

Use and Care Guide

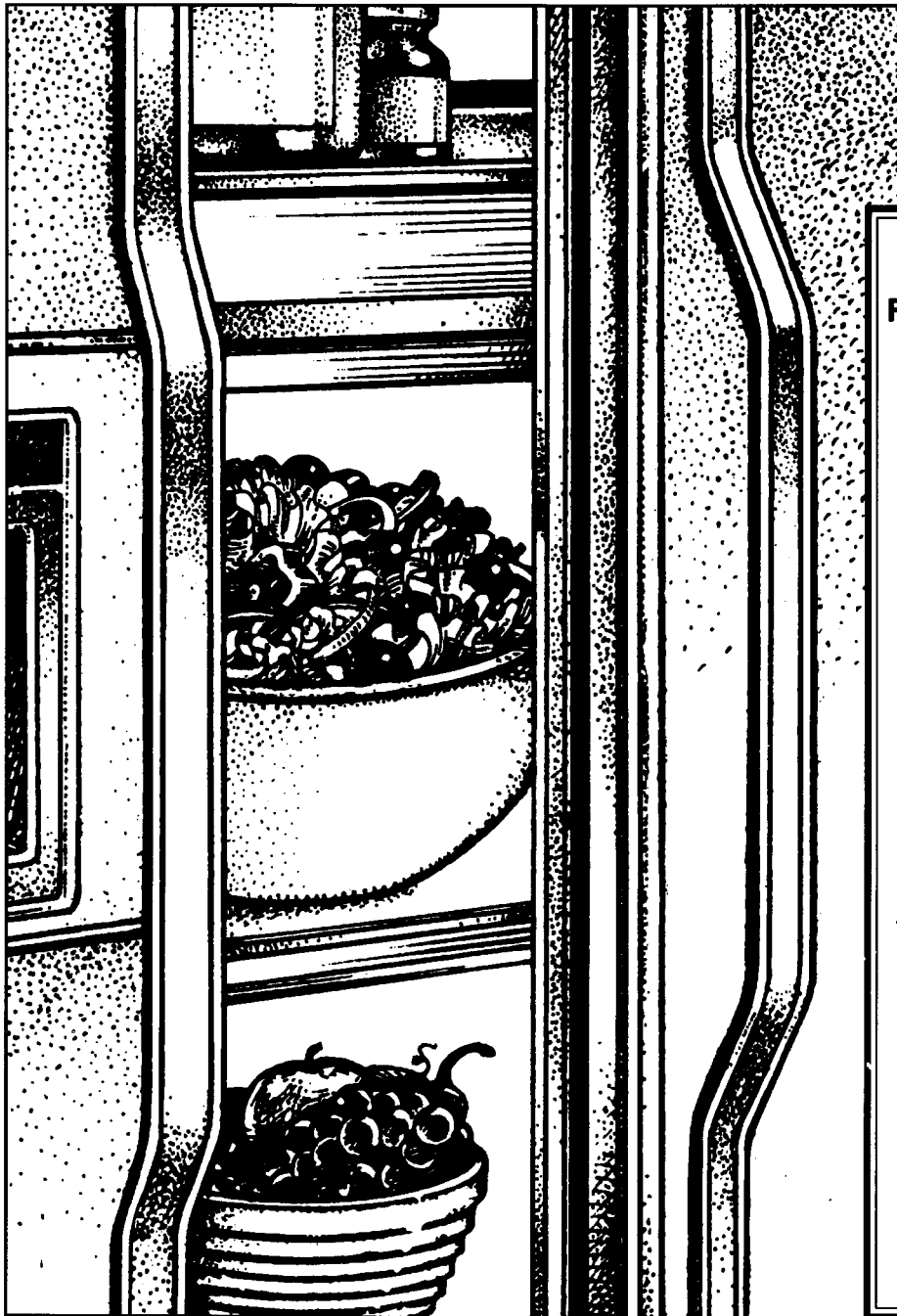

KitchenAid®
FOR THE WAY IT'S MADE.™

Table of Contents (complete)	2
A Note to You	2
Refrigerator Safety	3
Parts and Features	4
Before Using Your Refrigerator	5
Using Your Refrigerator	7
Caring for Your Refrigerator	24
Food Storage Guide	27
Troubleshooting	29
Requesting Assistance or Service	30
Warranty	32

1-800-422-1230

Call Us With Questions Or Comments

5-910

**KITCHENAID® No-frost Refrigerator
With CRYSTAL CLEAN™ Water Filter**

PART NO. 2194692

Table of Contents

	Page		Page
A Note to You	2	Adjusting the crisper humidity control	13
Refrigerator Safety	3	Removing the freezer shelf	13
Parts and Features	4	Removing the freezer baskets	14
Before Using Your Refrigerator	5	Using the automatic ice maker	14
Using Your Refrigerator	7	Removing the ice maker storage bin	15
Using the EXTENDFRESH™		Using the CRYSTALCLEAN™	
Temperature Management System	7	water and ice dispensers	16
Setting the controls	8	Attaching the ice maker to a water supply	18
Removing the door shelf fronts	8	Replacing the water filter cartridge	20
Adjusting the SLIDE 'N' LOCK™ door bins	9	Removing the base grille	21
Removing the drop-in door trim	9	Changing the light bulbs	22
Removing the SLIDE 'N' LOCK can racks	9	Understanding the sounds you may hear	23
Using the CLEARVUE™ Carousel	10	Saving energy	23
Adjusting the refrigerator shelves	10	Caring for Your Refrigerator	24
Removing the meat locker and cover	12	Food Storage Guide	27
Adjusting the FRESHCHILL™		Troubleshooting	29
Meat Locker Temperature Control	12	Requesting Assistance or Service	30
Removing the crisper and crisper cover	13	Warranty	32

A Note to You

Thank you for buying a KITCHENAID® appliance!

KITCHENAID appliances have everything you would expect of a superior appliance, plus the distinct style and thoughtful details which contribute to the overall look of your home and your enjoyment of it. To ensure that you enjoy many years of trouble-free operation, we developed this Use and Care Guide. It contains valuable information concerning how to operate and maintain your new appliance properly and safely. Please read it carefully.

Also, please complete and mail the enclosed Product Registration Card.

Please record your model's information.

Whenever you call to request service on your appliance, you need to know your complete model number and serial number. You can find this information on the model and serial number label (see diagram on page 4 for location of label).

Please also record the purchase date of your appliance and your dealer's name, address, and telephone number.

Keep this book and the sales slip together in a safe place for future reference.

Model Number _____
Serial Number _____
Purchase Date _____
Dealer Name _____
Dealer Phone _____

Our Consumer Assistance Center number, 1-800-422-1230, is toll-free 24 hours a day.

Refrigerator Safety

Your safety is important to us.

This guide contains statements under warning symbols. Please pay special attention to these symbols and follow any instructions given. Here is a brief explanation of the use of the warning symbol.



This symbol alerts you to hazards such as fire, electrical shock, or other injuries.

IMPORTANT SAFETY INSTRUCTIONS

WARNING

To reduce the risk of fire, electrical shock, or injury when using your refrigerator, follow these basic precautions:

- Read all instructions before using the refrigerator.
 - Child entrapment and suffocation are not problems of the past. Junked or abandoned refrigerators are still dangerous ... even if they will "just sit in the garage a few days."
If you are getting rid of your old refrigerator, do it safely. Please read the enclosed safety booklet from the Association of Home Appliance Manufacturers. Help prevent accidents.
 - Never allow children to operate, play with, or crawl inside the refrigerator.
 - Never clean refrigerator parts with flammable fluids. The fumes can create a fire hazard or explosion.
- FOR YOUR SAFETY •
- DO NOT STORE OR USE GASOLINE OR OTHER FLAMMABLE VAPORS AND LIQUIDS IN THE VICINITY OF THIS OR ANY OTHER APPLIANCE. THE FUMES CAN CREATE A FIRE HAZARD OR EXPLOSION.

– SAVE THESE INSTRUCTIONS –

Help us help you

Please:

- Install and level the refrigerator on a floor that will hold the weight and in an area suitable for its size and use.
- Do not install the refrigerator near an oven, radiator, or other heat source.
- Do not use the refrigerator in an area where the room temperature will fall below 55°F (13°C).
- Keep the refrigerator out of the weather.
- Connect the refrigerator only to the proper kind of outlet, with the correct electrical supply and grounding. (Refer to the Electrical Requirements and Grounding Instructions Sheet.)
- Do not load the refrigerator with food before it has time to get properly cold.
- Use the refrigerator only for the uses described in this manual.
- Properly maintain the refrigerator.
- Be sure the refrigerator is not used by anyone unable to operate it properly.
- Replace water filter cartridge at least once a year.
- Do not install filter cartridge on a water line with pressure above 120 psi.
- Activated carbon filters are not intended for use where water is microbiologically unsafe or with water of unknown quality.

IMPORTANT: The water filter is designed to improve water quality and reduce off-taste and odor. It does this by reducing sediments, algae, rust, and chlorine in the water.

Parts and Features

Below are illustrations of your appliance with the parts and features called out. To help you find information on specific parts or features faster, page references are included.

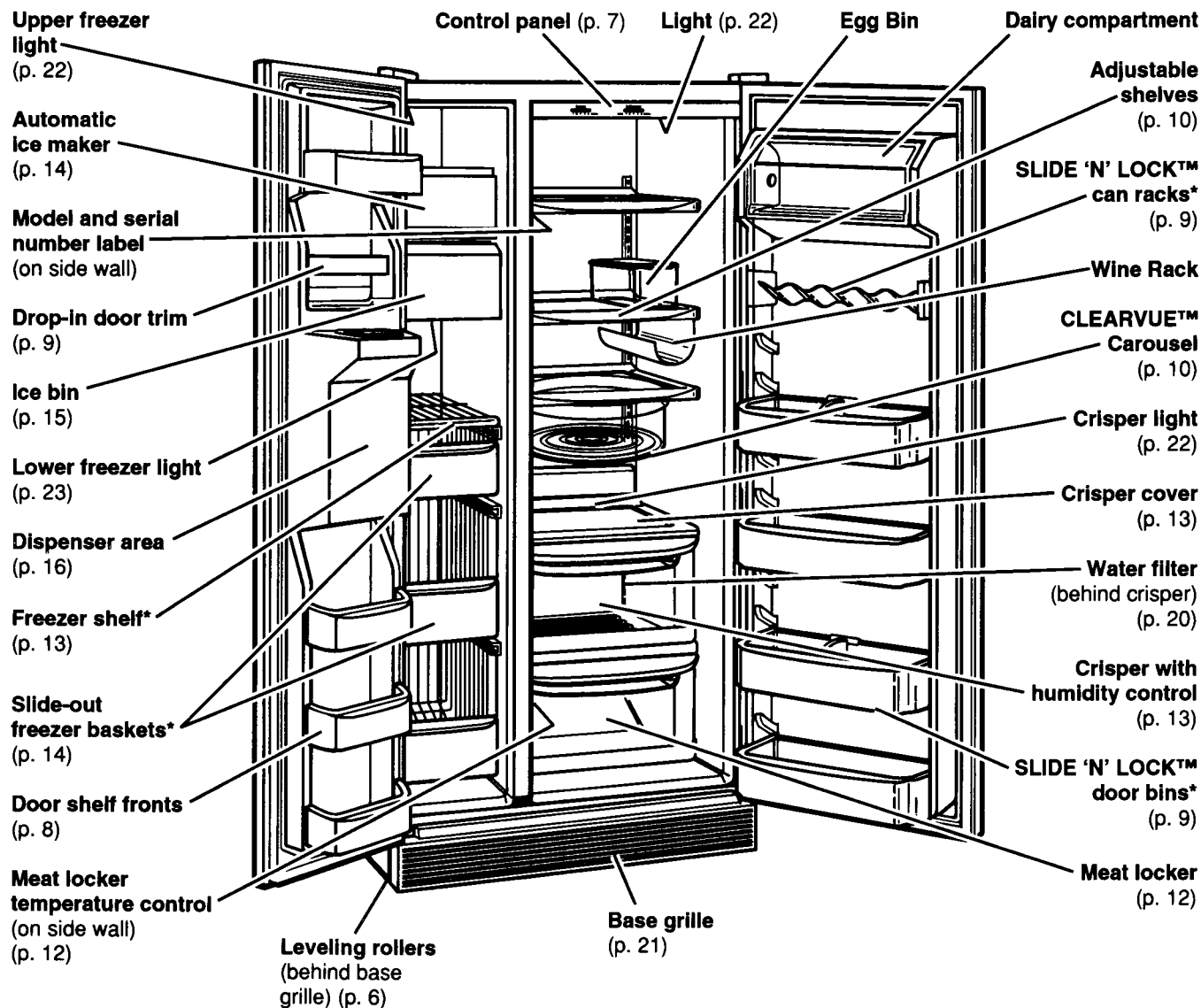

* Number varies with model

EXTENDFRESH™ Control Panel

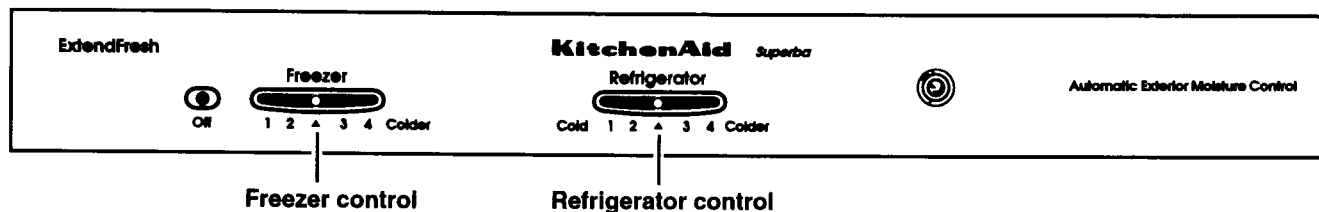

Before Using Your Refrigerator

It is important to prepare your refrigerator for use. This section tells you how to clean it, connect it to a power source, install it, and level it.

Cleaning your refrigerator

Removing packaging materials

Remove tape and any inside labels (except the model and serial number label) before using the refrigerator.

To remove any remaining tape or label glue:

- Rub briskly with thumb.
- OR
- Apply liquid hand-dishwashing detergent to area before removing glue as described above. Do not use sharp instruments, rubbing alcohol, flammable fluids, or abrasive cleaners. These can damage the material. See "Important Safety Instructions" on page 3.

NOTE: Do not remove any permanent instruction labels inside your refrigerator. Do not remove the Tech Sheet fastened under the refrigerator at the front.

Cleaning it before use

After removing all packaging materials, clean your refrigerator before using it, if necessary. See cleaning instructions on page 24.



Plugging it in

⚠ WARNING



Fire Hazard

Do not use an extension cord.
Doing so can result in death, fire, or electrical shock.

⚠ WARNING



Electrical Shock Hazard

Plug into a grounded 3 prong outlet.
Do not remove ground prong.
Do not use an adapter.
Failure to follow these instructions can result in death or electrical shock.

Recommended Grounding Method

A 115 Volt, 60 Hz., AC only 15 or 20 ampere fused and properly grounded electrical supply is required. It is recommended that a separate circuit serving only this appliance be provided. Use a receptacle which cannot be turned off with a switch or pull chain. Do not use an extension cord. See Electrical Requirements and Grounding Instructions Sheet in your Literature Package.

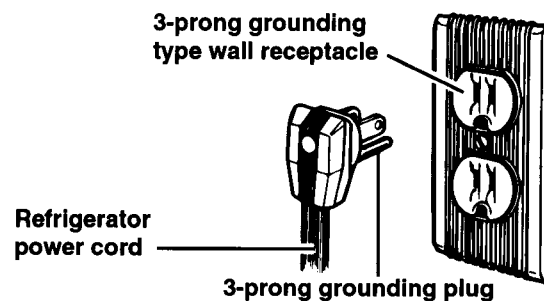

Installing it properly

1. Allow ½ inch (1.25 cm) space on each side and at the top of the refrigerator for ease of installation.
2. If the hinge side of the refrigerator is to be against a wall, you might want to leave extra space so the door can be opened wider.
3. The refrigerator can be flush against the back wall.

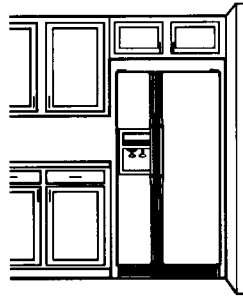

Leveling it

Your refrigerator has 2 front leveling screws – one on the right and one on the left. To adjust one or both of these, follow the directions below.

1. Remove base grille. (See page 21.)
2. To raise front, turn screw clockwise.
3. To lower front, turn screw counterclockwise.
4. Check with level.
5. Replace base grille. (See page 21.)

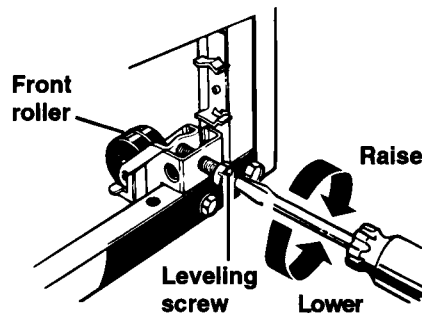

**Right to raise;
left to lower
Use a screw-
driver to adjust**

Using Your Refrigerator

To obtain the best possible results from your refrigerator, it is important that you operate it properly. This section tells you how to set the temperature controls, remove and adjust some of the features in your refrigerator, and how to save energy.

Using the EXTENDFRESH™ Temperature Management System

The EXTENDFRESH Temperature Management System controls the temperature in both the refrigerator compartment and the freezer compartment independently. The system helps extend the freshness of the food in your refrigerator by responding to temperature changes as small as 1.5°F. Unlike most refrigerators on the market today, the EXTENDFRESH System uses a “SmartFan” to transfer cold air immediately from the freezer to the refrigerator for faster response to temperature changes without the need for the compressor to turn on. Also, the system maintains consistent temperatures which are not affected by external temperature changes such as seasonal changes and programmable home thermostats or even the temperature of other compartments inside the refrigerator.

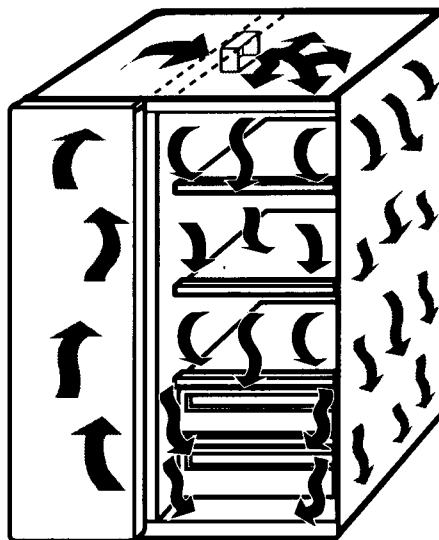

Example of SmartFan airflow pattern

Setting the controls for the EXTENDFRESH control panel

The Refrigerator and Freezer Controls come preset for you in the mid-setting.

If you need to change a control setting:

- Move the control one number to the left or right.
LEFT for WARMER temperature
RIGHT for COOLER temperature

IMPORTANT: Remember to wait 24 hours between adjustments. Doing so gives food items time to respond to the temperature change.

Turning the refrigerator off

- Slide the Freezer Control to the OFF setting.
Doing this stops all cooling in both the refrigerator and freezer compartments.

IMPORTANT: The Automatic Exterior Moisture Control continuously guards against moisture buildup on the outside of the refrigerator cabinet. This control does not have to be set or adjusted.

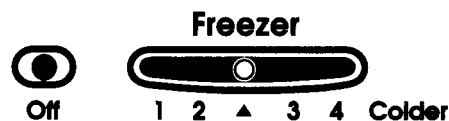

IMPORTANT: Setting control to OFF DOES NOT disconnect the refrigerator from its electrical power supply.

Setting the controls

If you need to adjust temperatures in the refrigerator or freezer, use the settings listed in the chart below as a guide. If you have any questions, call our Consumer Assistance Center number, **1-800-422-1230**, from anywhere in the U.S.A.

- Adjust the Refrigerator Control first.
- Wait at least 24 hours between adjustments.
- Then adjust the Freezer Control if needed.

CONDITION:	REASON:	RECOMMENDED SETTINGS:	
		Refrigerator	Freezer
Refrigerator section too warm	<ul style="list-style-type: none"> • Door opened often • Large amount of food added • Room temperature too warm 	4	2
Freezer section too warm	<ul style="list-style-type: none"> • Door opened often • Large amount of food added • Very cold room temperature (can't cycle often enough) 	3	4
Refrigerator section too cold	<ul style="list-style-type: none"> • Controls not set correctly for your conditions 	2	4
Ice not made fast enough	<ul style="list-style-type: none"> • Heavy ice usage • Very cold room temperature (can't cycle often enough) 	4	4
Both sections too warm	<ul style="list-style-type: none"> • Door opened often • Large amount of food added • Very warm or very cold room temperatures 	4	4

Removing the door shelf fronts

Remove the door shelf fronts for easier cleaning.

To remove shelf fronts:

1. Remove all items from the shelf.
2. Pull out on the inside tab at each end of the shelf fronts.
3. Pull shelf front straight out.

To replace shelf fronts:

1. Line up ends of the shelf front with the button on the door liner wall.
2. Push shelf front straight back until it snaps securely into place.
3. Replace items on the shelf.

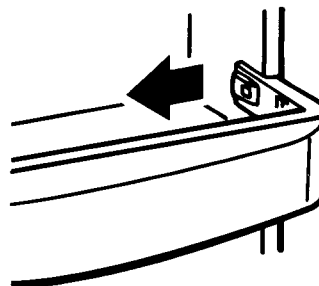

Adjusting the SLIDE 'N' LOCK™ door bins

Adjust the door bins to match the way you use your refrigerator.

To remove bins:

1. Lift bin up.
2. Pull bin straight out.

To replace bins:

1. Hold back of bin above desired bin guide.
2. Push bin back and down until it stops.

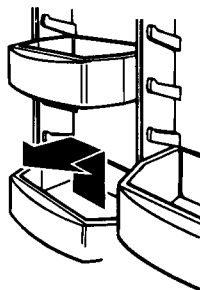

Removing the drop-in door trim (dispenser area)

Remove the trim above the dispenser area for easier cleaning.

To remove the trim piece:

1. Remove all items from the shelf.
2. Pull straight up at each end of the trim piece.



To replace the trim piece:

1. Line up each end of the trim piece above the trim pocket opening in the door liner wall.
2. Push the trim piece straight down until it stops.
3. Replace items on the shelf.



Removing the SLIDE 'N' LOCK™ can racks

Each rack holds 5 beverage cans in a convenient place, leaving more shelf space for larger items.

To remove rack:

1. Lift rack up.
2. Pull rack straight out.

To replace rack:

1. Hold back of rack above desired guide.
2. Push rack back and down until it stops.

IMPORTANT: When replacing the can rack, you must replace the bottom rack first.

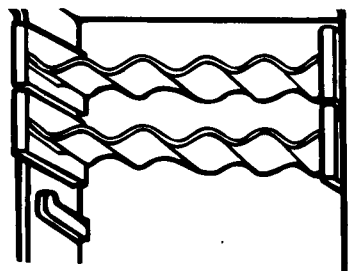

Using the CLEARVUE™ Carousel

The CLEARVUE Carousel is a rotating circular drawer mounted to the underside of a SPILLCLEAN™ shelf. The clear design allows you to see all the items in the drawer without opening it when you spin it 360°.

NOTE: The CLEARVUE Carousel drawer can be lifted out of the carriage frame and used as an attractive serving dish. The dishwasher safe drawer also makes for easy cleanup.

To roll carousel out:

- Carefully pull front of carousel toward you.

To roll carousel in:

- Push carousel in until it stops.

To remove carousel:

1. Roll carousel out to the stop.
2. Lift front of the carriage frame and pull the rest of the way out.
3. Lift carousel out of the carriage frame.

To replace carousel:

1. Place carousel into carriage frame.
2. Position rear carriage rollers into SPILLCLEAN shelf tracks.
3. Push carriage back, lift over forward stop, then push back to home position.

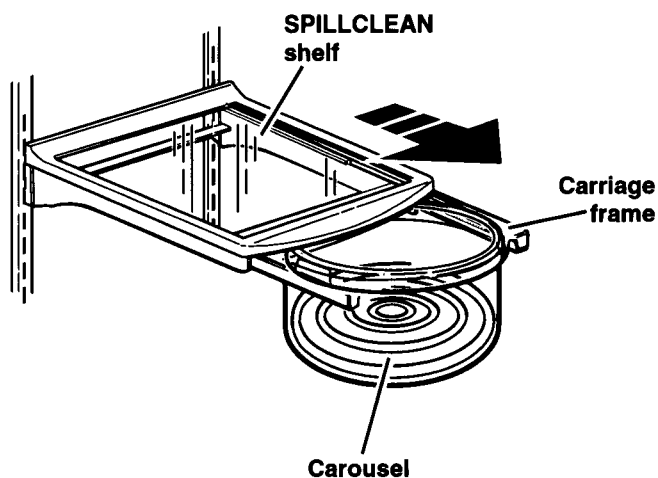

Adjusting the refrigerator shelves

Adjust the shelves to match the way you use your refrigerator.

SPILLCLEAN cantilever shelves

To remove shelves:

1. Tilt shelf up at front.
2. Lift shelf up at back.
3. Pull shelf straight out.

IMPORTANT: Glass shelves are heavy. Handle with care.

To replace shelves:

1. Guide the rear hooks of shelf into slots in the shelf supports.
2. Tilt shelf up at front until hooks drop into slots. Lower front of shelf to level position.
3. Check the stability of the shelf to be sure hooks have been inserted properly.

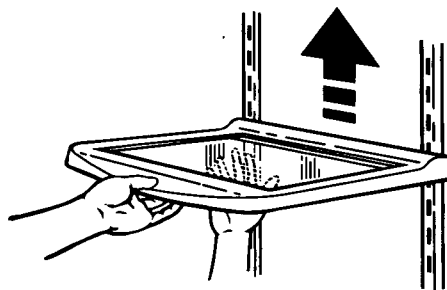

ROLLERTRAC™ SPILLCLEAN™ cantilever shelf

The ROLLERTRAC shelf has rollers which allow you to roll the shelf out for easier access to foods stored on the rear of the shelf.

To roll shelf out:

- Carefully pull front of shelf toward you.

To roll shelf in:

- Push shelf in until it stops.

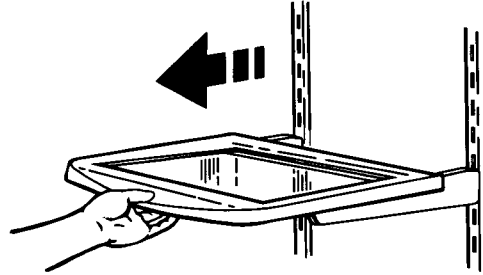

To remove shelf from metal frame:

1. Pull shelf out to the stop.
2. Lift the front and pull shelf out a little further.
3. Lift shelf up so that the roller moves through the slot in the frame.
4. Replace shelf in reverse order.

IMPORTANT: Glass shelves are heavy. Handle with care.

To remove shelf frame:

1. Tilt frame up at the front.
2. Lift frame up at the back and pull straight out.

To replace the shelf frame:

1. Guide the rear hooks of the frame into the shelf supports.
2. Tilt the frame up at the front until the hooks drop into the slots. Lower the front of the frame to a level position.
3. Check the stability of the frame to be sure that the hooks have been properly inserted.

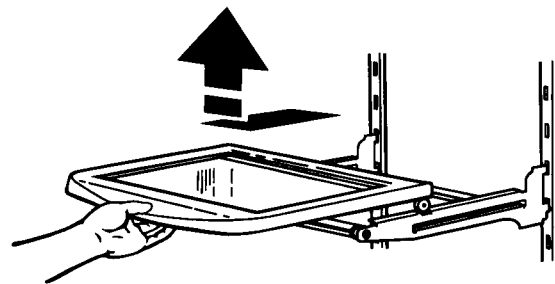

Removing the meat locker and cover

To remove the meat locker:

1. Slide out to the stop.
2. Lift front and slide out the rest of the way.
3. Replace in reverse order.

To remove the cover:

1. Tilt front of cover up.
2. Lift back of cover.
3. Pull cover straight out.

To replace the cover:

1. Guide the cover's rear hooks into the slots in the shelf supports on cabinet wall.
2. Tilt cover up at front until the hooks drop into slots.
3. Lower front of cover to a level position.

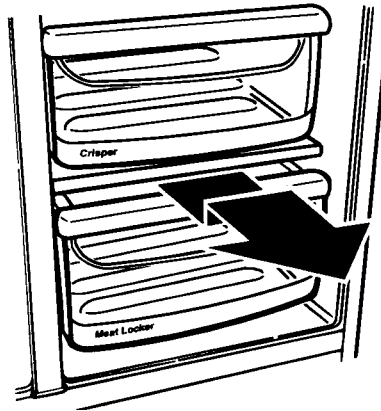

Pull out to the stop, lift the front, and pull again.

Adjusting the FRESHCHILL™ meat locker temperature control

The FRESHCHILL temperature control gently fills the meat locker with cool air, chilling the meats evenly. Unlike most chilled meat locker systems, the FRESHCHILL temperature control cools the air inside the pan instead of chilling only the pan itself (which doesn't cool the air inside the pan evenly). Chilling the air inside the pan provides more even cooling and reduces "spot" freezing. The FRESHCHILL temperature control can be set to keep meats between 28°F and 32°F (recommended storage temperatures from the National Livestock and Meat Board) which is just above their freezing temperature.

IMPORTANT: To extend freshness even more, remember to wrap meats in airtight, moisture-proof materials before storing as recommended by the National Livestock and Meat Board. See "Food Storage Guide" on page 27 for more information.

Adjusting the control

The FRESHCHILL control comes preset for you at the "1" setting. Move it to the mid-setting or "colder" for meat storage.

If you need to change a control setting:

- Move the control to a higher or lower number.

IMPORTANT: If meats start to freeze, move the control to a lower number. Remember to wait 24 hours between adjustments. Doing so gives the temperature of the food time to change.

NOTE: Fruit or fresh vegetables may be stored in the meat locker at the "1" setting.

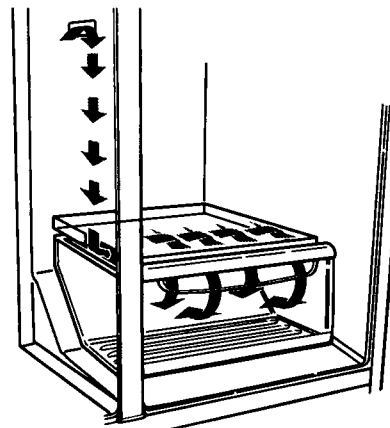

Airflow pattern

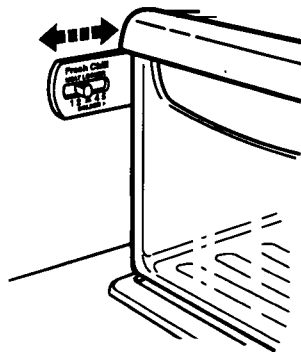

Removing the crisper and crisper cover

To remove the crisper:

1. Slide crisper straight out to the stop.
2. Lift the front and slide out the rest of the way.
3. Replace in reverse order.

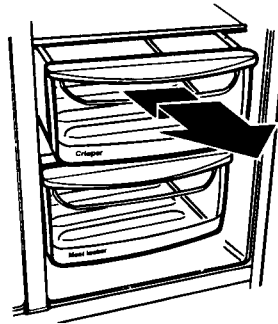

Pull out to the stop, lift the front, and pull again.

To remove the cover:

1. Push up the glass insert from the bottom, then slide out with both hands.
2. Lift front of cover frame.
3. Lift cover frame up and out.

To replace the cover:

1. Fit back of cover frame into notch supports on back wall of refrigerator, then lower the front into place.
2. Slide back of cover insert into place, then lower front.

Remove the glass insert. Lift the cover front, then the back.
NOTE: Handle glass insert with care. It is heavy.

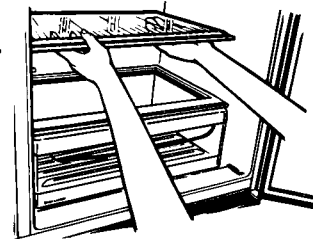

Adjusting the crisper humidity control

You can control the amount of humidity in the moisture-sealed crisper. Adjust the control to any setting between LOW and HIGH.

- LOW (open) lets moist air out of the crisper for best storage of fruits and vegetables with skins.
- HIGH (closed) keeps moist air in the crisper for best storage of fresh, leafy vegetables.

FreshSeal Humidity Control

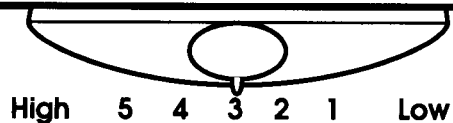

Removing the freezer shelf

To remove the shelf:

1. Lift right side of shelf off supports.
2. Slide shelf out of shelf support holes.
3. Replace in reverse order.

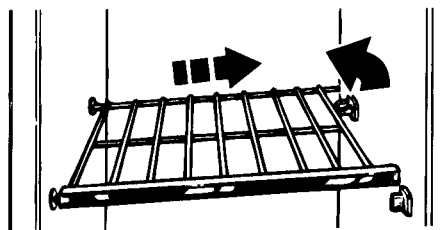

Removing the freezer baskets

To remove baskets:

1. Slide basket out to the stop.
2. Lift basket at front to clear the stop.
3. Slide basket out the rest of the way.

To replace baskets:

1. Place basket on the slides.
2. Lift basket at front to clear the stops.
3. Slide basket in until it stops.

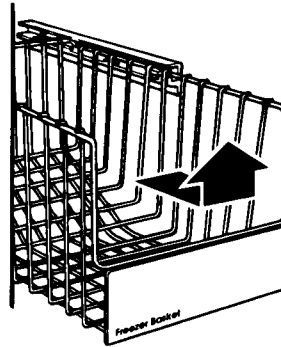

Using the automatic ice maker

Here are a few things you will want to know about your automatic ice maker:

- The ON/OFF lever is a wire signal arm. Move the arm:
DOWN to make ice automatically.
UP to shut off the ice maker.

NOTE: Do not turn ice maker on until it is connected to the water supply. **Instructions for ice maker water supply hookup are attached to the back of the refrigerator cabinet.**

- It is normal for ice crescents to be attached by a corner. They break apart easily.
- The ice maker will not operate until the freezer is cold enough to make ice. This can take overnight.
- If ice is not being made fast enough and more ice is needed, turn the Refrigerator Control toward a higher number. Wait a day and, if necessary, turn the Freezer Control toward a colder setting.
- Good water quality is important for good ice quality. Try to avoid connecting the ice maker to a softened water supply. Water softener chemicals (such as salt from a malfunctioning softener) can damage the ice maker mold and lead to poor ice quality. If a softened water supply cannot be avoided, make sure the water softener is operating properly and is well maintained.

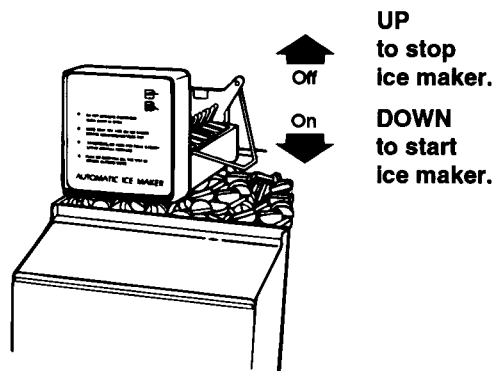

Solving common ice maker problems

PROBLEM	POSSIBLE CAUSE/SOLUTION
Ice crescents attached at corners	<ul style="list-style-type: none"> • This is normal. They break apart easily. Shake bin occasionally to keep cubes separated.
Ice maker will not operate or ice is not made fast enough	<ul style="list-style-type: none"> • ON/OFF lever is in the OFF (up) position. Lower lever to the ON (down) position. • Freezer is not cold enough. Adjust temperature controls and wait 24 hours. (See "Setting the controls" on page 8.)
Off-taste or odor in ice	<ul style="list-style-type: none"> • New plumbing connections can cause discolored or off-flavored ice. Discard the first few batches of ice. • Cubes are stored too long. Throw them away and make a new supply. • Food is not wrapped properly. See page 28. • Freezer and ice bin need to be cleaned. See page 24. • Filter cartridge needs replacing. Replace the cartridge. See page 20. • Water quality is poor. For best results, avoid connecting ice maker to a softened water supply. If softened water supply cannot be avoided, make sure the water softener is well maintained and operating properly.

Removing the ice maker storage bin

The ice maker storage bin holds up to 8.5 pounds (3.8 kg) of ice. Remove unused ice periodically to reduce the potential for off-taste or odor buildup in ice.

IMPORTANT: The first few batches of ice from the ice maker may have an off-taste. This is from new parts. Throw the first few batches of ice away and make a new supply.

To remove storage bin:

Remove the storage bin to obtain large quantities of ice or for cleaning.

1. Pull the covering panel out from the bottom and slide it to the rear.
2. Lift the ice maker signal arm until you feel it click into the OFF position. Ice can still be dispensed when the freezer door is closed, but no more can be made.
3. Lift the front of the storage bin and pull it out.
4. Empty the bin. Use hot or warm water to melt the ice if necessary. **Never use anything sharp** to break up the ice in the bin. This can damage the bin and dispenser mechanism.
5. Wash with mild detergent. Rinse and dry well. Do not use harsh or abrasive cleaners or solvents.

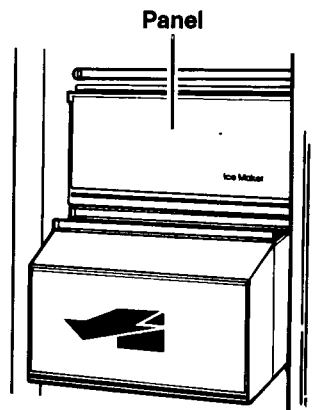

To replace storage bin:

1. Make sure bin is pushed in all the way.
2. Push the ice maker signal arm down to the ON position to restart ice production.
3. Lower covering panel.

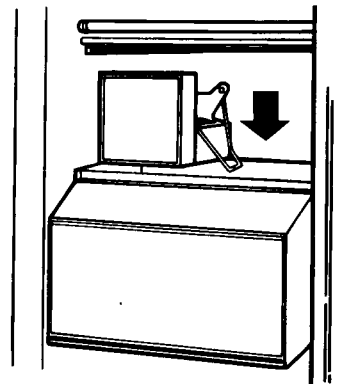

Using the CRYSTALCLEAN™ water and ice dispensers

The ice dispenser

Ice dispenses from the ice maker storage bin in the freezer. When you press the dispenser bar, a trapdoor opens in a chute between the dispenser and the ice bin. Ice moves from the bin and falls through the chute. When you release the dispenser bar, a buzzing sound may be heard for a few seconds as the trapdoor closes. The dispenser system will not operate when the freezer door is open.

For crushed ice, cubes are crushed before being dispensed. This may cause a slight delay when dispensing crushed ice. Noise from the ice crusher is normal, and pieces of ice may vary in size.

When changing from CRUSHED to CUBED, a few ounces of crushed ice will be dispensed along with the first cubes.

To dispense ice:

1. For cubed ice, move Ice Selector Switch to the CUBED position.

For crushed ice, move Ice Selector Switch to the CRUSHED position.

2. Press a **sturdy** glass against the ice dispenser bar. Hold the glass close to dispenser opening so ice does not fall outside of the glass.
3. Remove the glass to stop dispensing.

NOTE: The first few batches of ice may have an off-flavor from new plumbing and parts. Throw the ice away. Also, take large amounts of ice from the ice bin, not through the dispenser.

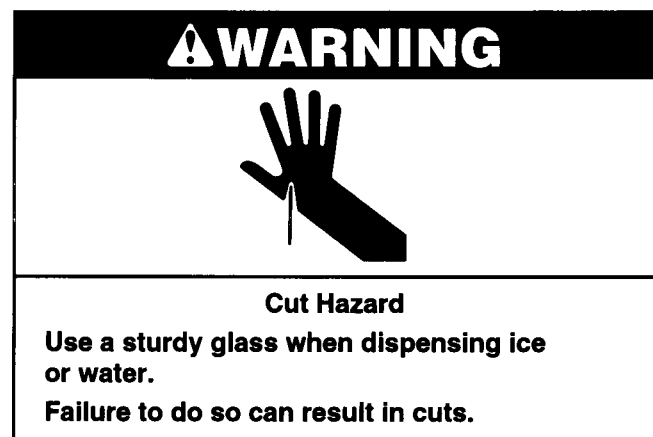

Cubed • Crushed



Cubed • Crushed

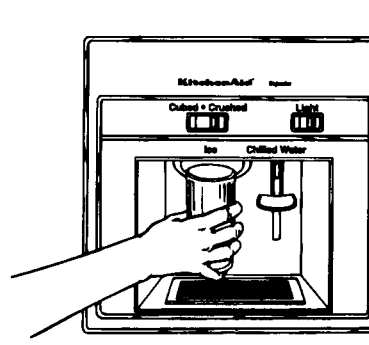

The water dispenser

Chilled water comes from a 50 oz. (1.5 L) tank behind the crisper and meat drawers. Allow about 24 hours to chill the first tankful of water.

When the refrigerator is first hooked up, press the water dispenser bar until you draw and discard 3 to 4 quarts (2.9 to 3.8 L) of water. This removes air from the system and rinses the water filter, tank, and pipes.

If dispenser is not used regularly, dispense enough water every week to freshen the supply. Allow 2 to 3 hours for a new supply of water to chill.

NOTE: The small tray beneath the dispenser is designed to evaporate **small** spills. There is no drain in this tray. **Do not** pour water into it.

To dispense water:

1. Press a **sturdy** glass against the water dispenser bar.
2. Remove the glass to stop dispensing.

The dispenser light

To turn on night light, slide dispenser LIGHT switch to the left. See page 23 for directions for changing the dispenser light bulb.

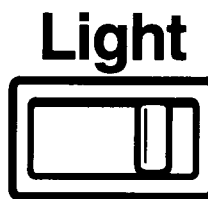
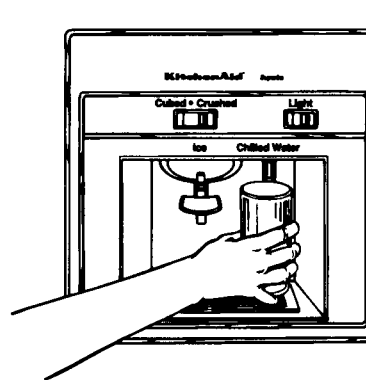

Solving common dispenser problems

PROBLEM	POSSIBLE CAUSE/SOLUTION
Ice dispenser will not work	<ul style="list-style-type: none"> • Freezer door is open. • Ice bin not properly installed. Make sure the bin is pushed in all the way. • Wrong ice in bin. Only use crescents from the ice maker. Shake the bin occasionally to separate cubes and increase storage room. • Dispenser not used for extended periods of time, causing ice cubes to melt together. Dump old ice and make a new supply.
Ice dispenser stops working	<ul style="list-style-type: none"> • Ice dispenser bar held in too long. Wait about 3 minutes for dispenser motor to reset. (Large amounts of ice should be taken from the bin, not through the dispenser.)
Water dispenser will not work	<ul style="list-style-type: none"> • Water filter valve turned off. Turn water filter valve ON by flipping the blue handle up until it stops. • Filter cartridge needs replacing. Replace the cartridge. See page 20.

Attaching the ice maker to a water supply

Read all directions carefully before you begin.

! WARNING

Electrical Shock Hazard Unplug the refrigerator before installing ice maker. Failure to do so can result in death or electrical shock.

IMPORTANT:

- It may take up to 24 hours for your ice maker to begin producing ice.
- If operating the refrigerator before installing the water connection, turn ice maker to the OFF position to prevent operation without water.
- All installations must be in accordance with local plumbing code requirements.

**INSTALLATION IS NOT WARRANTED
BY REFRIGERATOR OR ICE MAKER
MANUFACTURER.**

IMPORTANT:

- Use copper tubing only and check for leaks.
- Install ice maker tubing in areas where temperatures are above freezing.

Tools required:

- Standard screwdriver
- $\frac{7}{16}$ -inch and $\frac{1}{2}$ -inch open-end wrenches or 2 adjustable wrenches
- $\frac{1}{4}$ -inch nut driver
- $\frac{1}{4}$ -inch drill bit
- Hand drill or electric drill (properly grounded)

VALVE SELECTION

Your appliance dealer has a kit available with a $\frac{1}{4}$ -inch saddle type shut-off valve, a union, and copper tubing. Before purchasing, make sure the saddle type valve complies with your local plumbing codes. **Do not use a piercing type or $\frac{3}{16}$ -inch saddle valve which reduces water flow and clogs more easily.**

Cold water supply

Ice maker water valve contains a flow washer which is used as a water pressure regulator. The ice maker needs to be connected to a cold water line with water pressure limitations of 20-120 psi. If a problem occurs, call your utility company.

Connecting to water line

1. Find a 1/2-inch to 1 1/4-inch vertical COLD water pipe near the refrigerator.

NOTE: Horizontal pipe will work, but the following precaution must be taken: Drill on the top side of the pipe, not the bottom. This will help keep water away from the drill. This also keeps normal sediment from collecting in the valve.

2. Measure from connection on rear of refrigerator to water pipe. Add 7 feet (2.1 m) to allow for moving refrigerator for cleaning. This is the length of 1/4-inch O.D. copper tubing you will need for the job (length from connection to water pipe PLUS 7 feet [2.1 m]). Be sure both ends of copper tubing are cut square.
3. Turn OFF main water supply. Turn ON nearest faucet long enough to clear line of water.
4. Using a grounded drill, drill a 1/4-inch hole on the cold water pipe you have selected.
5. Fasten shut-off valve to cold water pipe with pipe clamp. Be sure outlet end is solidly in the 1/4-inch drilled hole in the water pipe and that washer is under the pipe clamp. Tighten packing nut. Tighten the pipe clamp screws carefully and evenly so washer makes a watertight seal. Do not overtighten or you may crush the copper tubing, especially if soft (coiled) copper tubing is used. Now you are ready to connect the copper tubing.
6. Slip compression sleeve and compression nut on copper tubing as shown in diagram. Insert end of tubing into outlet end squarely as far as it will go. Screw compression nut onto outlet end with adjustable wrench. Do not overtighten. Turn ON main water supply and flush out tubing until water is clear. Turn OFF shut-off valve on the water pipe. Coil copper tubing.

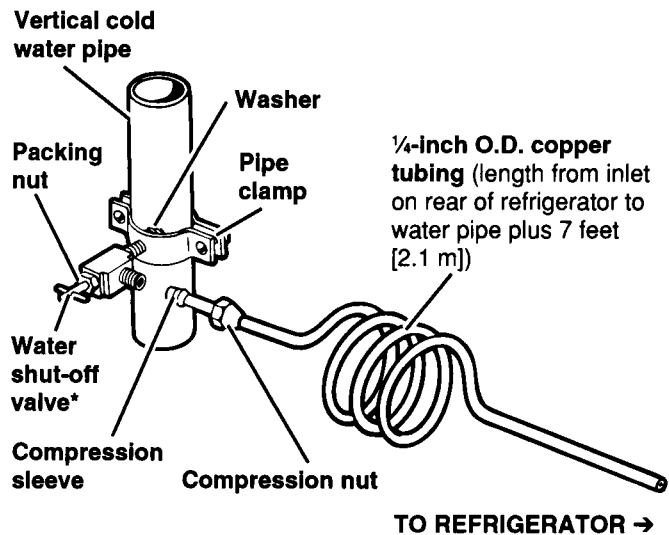

* Controls water supply

Connecting to refrigerator

1. (On kit models, assemble water valve to refrigerator per kit instructions.) Route the copper tubing through the tube clamp provided as shown at left. Connect the 1/4-inch copper tube from the shut-off valve to the water valve at the lower, left rear of cabinet. Remove tape label from valve inlet and insert tubing until it bottoms out (approximately 1/2 inch). Tighten nut by hand as much as possible; then turn the nut an additional 1/2 turn using a wrench. Do not overtighten.
2. **Turn shut-off valve ON. CHECK FOR LEAKS. TIGHTEN ANY CONNECTIONS (INCLUDING CONNECTIONS AT THE VALVE) OR NUTS THAT LEAK.**
3. The ice maker is equipped with a built-in water strainer. If local water conditions require periodic cleaning or a well is your source of water supply, a second water strainer should be installed in the 1/4-inch water line. Obtain a water strainer from your nearest appliance dealer. Install at either tube connection.
4. Reconnect electrical supply to refrigerator.

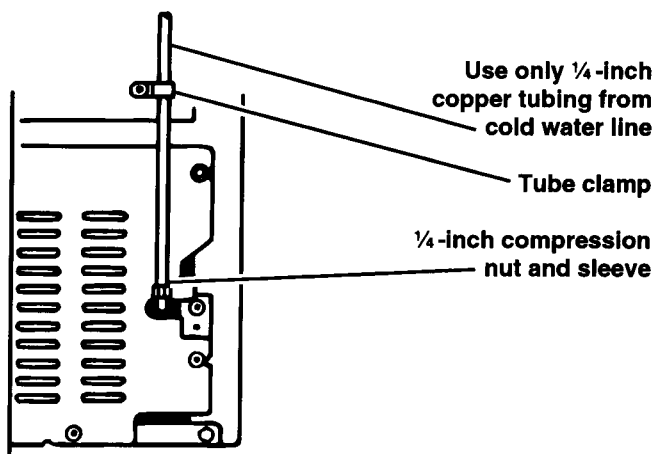

Replacing the water filter cartridge

To continue to enjoy great tasting water, this filtration system requires that you replace the cartridge every 6-12 months, depending upon usage.

Your replacement filter cartridge part number is 2168701 and may be purchased from your local KitchenAid dealer, or you may order the cartridge through the KitchenAid accessory department at:

KitchenAid
123 Koomler Drive
LaPorte, IN 46350-2545

Attn.: Accessory Accounting

The water filter is located behind the crisper cover (just above the meat locker drawer). The water filter reduces chlorine, off-taste and odor in the water. Household water is filtered before being sent to both the water dispenser and the ice maker.

You will need to replace the filter cartridge when off-taste and odor return to the water (between 6-12 months, depending on local water conditions).

To remove the filter cartridge:

1. Remove the crisper and the crisper cover. (See instructions on page 13.)
2. Locate the filter cartridge and water valve in the back of the refrigerator compartment, just below the light lens.

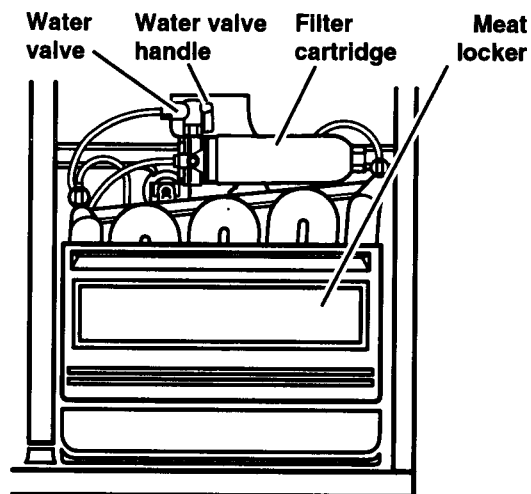

3. Shut off the water valve by flipping the blue handle up until it stops (about 1/4 turn).
4. Press a sturdy glass against the water dispenser to release any pressure that may be trapped. Doing this will prevent any water from splashing.

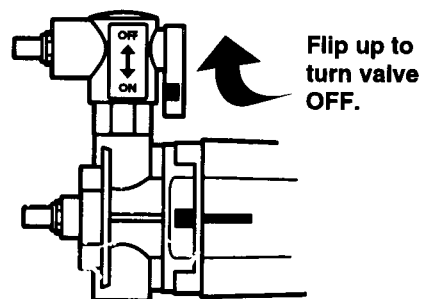

5. Grasp the cartridge and rotate it toward you (counterclockwise) until it stops. Pull the cartridge out to the right to release it from the mounting head.

NOTE: Keep the left end of the cartridge tilted up so any remaining water in the cartridge does not drain into the refrigerator.

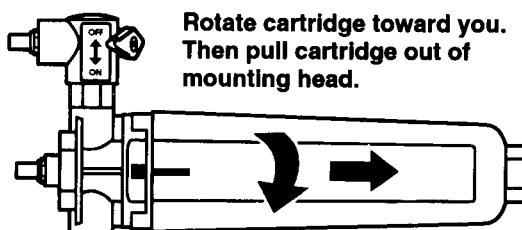

To replace the filter cartridge:

1. Align the cartridge ears with the open slots of the head assembly.
2. Push the cartridge into the head assembly and rotate it toward the back of the refrigerator cabinet (clockwise) until the red lines on the head assembly and the cartridge line up.

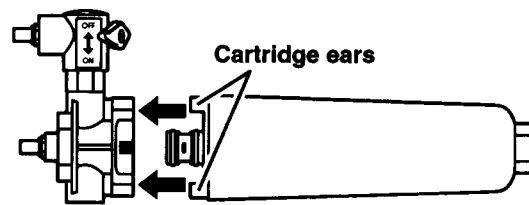

IMPORTANT: Make sure the red lines match up before proceeding. If the lines are not matched up, the cartridge could be pushed out of the assembly head, causing an internal water leak.

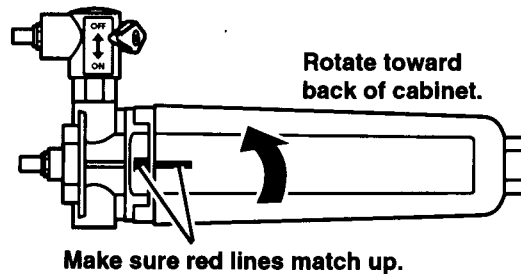

3. Turn on the filter's water valve by flipping the blue handle down until it stops.
4. Draw and discard 1 gallon (3.8 L) of water by pressing the water dispenser bar. This will remove the air in the water line and rinse the filter cartridge.

IMPORTANT: It is normal to see some carbon granules in the first fill of each cartridge. Water dispensed through the dispenser could look dark. This does not mean the cartridge is defective. The dark color should disappear after you draw and discard 1 gallon (3.8 L) of water.

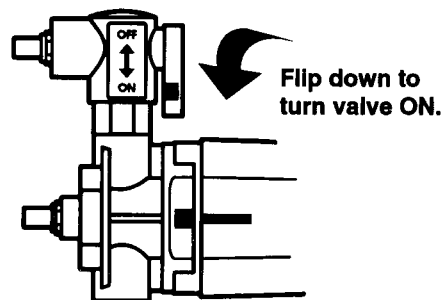

Removing the base grille

To remove base grille:

1. Open both doors.
2. Pull base grille forward to release the support tabs from the metal clips.

IMPORTANT: Do not remove Tech Sheet fastened behind the base grille.

To replace base grille:

1. Line up base grille support tabs with metal clips.
2. Push base grille firmly to snap into place.
3. Close the doors.

See cleaning instructions for defrost pan and condenser coils on page 25.

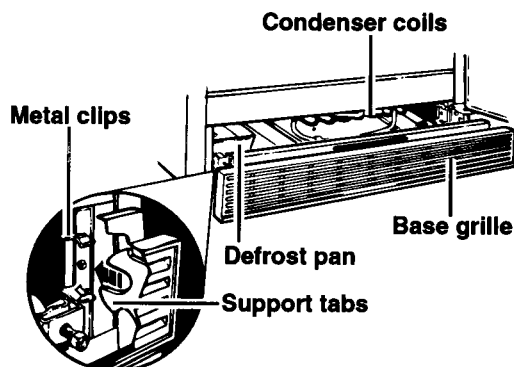

Changing the light bulbs

⚠ WARNING



Electrical Shock Hazard

Unplug the refrigerator before removing a light bulb.

Failure to do so can result in death or electrical shock.

To change refrigerator light:

1. Disconnect refrigerator from power supply.
2. Reach behind Control Console to remove bulb.
3. Remove bulb and replace with a 40-watt appliance bulb.
4. Reconnect refrigerator to power supply.

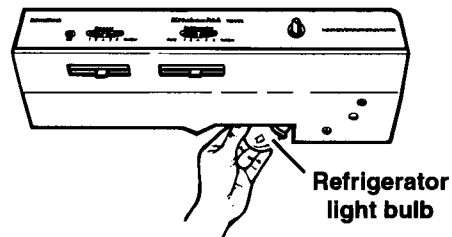

To change crisper light:

1. Disconnect refrigerator from power supply.
2. Remove crisper and cover. (See page 13.)
3. Remove bulb and replace with a 40-watt appliance bulb.
4. Reconnect refrigerator to power supply.

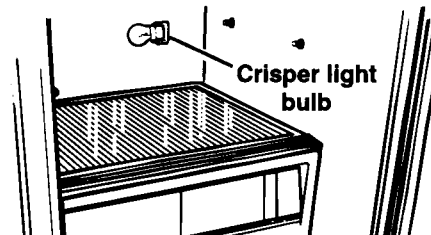

To change upper freezer light:

1. Disconnect refrigerator from power supply.
2. Remove light shield by grasping the top center of the shield.
3. Pull forward while turning the light shield slightly to one side.
4. Replace bulb with a 40-watt appliance bulb.
5. To replace light shield:
 - Grasp the top center of the shield.
 - Insert the tabs on one end of the shield into the slotted holes in the freezer liner.
 - Carefully bend the shield at the center to insert the tabs on the other end.
6. Reconnect refrigerator to power supply.

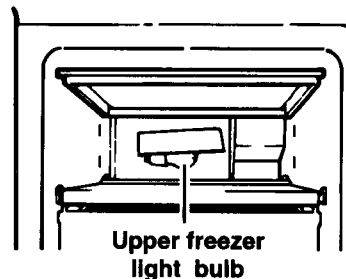

To change lower freezer light:

1. Disconnect refrigerator from power supply.
2. Push in sides of light shield until it snaps free.
3. Remove bulb and replace with a 40-watt appliance bulb.
4. Replace light shield.
5. Reconnect refrigerator to power supply.

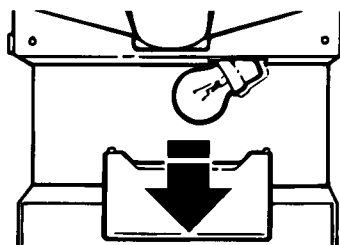

Lower freezer light bulb

To change dispenser light:

1. Disconnect refrigerator from power supply.
2. Reach through front of dispenser area to bulb.
3. Remove bulb and replace with a heavy-duty 10-watt bulb.
4. Reconnect refrigerator to power supply.

IMPORTANT: Not all appliance bulbs will fit your refrigerator. Be sure to replace a bulb with one of the same size and shape.

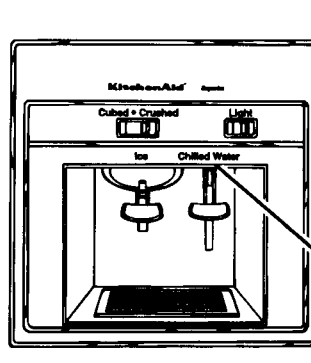

Dispenser area light

Understanding the sounds you may hear

Your new refrigerator may make sounds that your old one didn't. Because the sounds are new to you, you might be concerned about them. Don't be. Most of the new sounds are normal. Hard surfaces like the floor, walls, and cabinets can make the sounds seem louder. The following describes the kinds of sounds that might be new to you, and what may be making them.

Slight hum, soft hiss

You may hear the refrigerator's fan motor and moving air.

Clicking or snapping sounds

The thermostat makes a definite click when the refrigerator stops running. It also makes a sound when the refrigerator starts. The defrost timer will click when the defrost cycle starts.

Water sounds

When the refrigerator stops running, you may hear gurgling in the tubing for a few minutes after it stops. You may also hear defrost water running into the defrost water pan.

Ice maker sounds

- trickling water
- thud (clatter of ice)

You may hear buzzing (from the water valve), trickling water, and the clatter of ice dumped into the bin.

Running sounds

Your refrigerator has a high-efficiency compressor and motor. It will run longer than older designs. It may even seem to run most of the time.

Saving energy

You can help your refrigerator use less electricity.

- Check door gaskets for a tight seal. Level the cabinet to be sure of a good seal.
- Clean the condenser coils regularly.
- Open the door as few times as possible. Think about what you need before you open the door. Get everything out at one time. Keep food organized so you won't have to search for what you want. Close door as soon as food is removed.

- Go ahead and fill up the refrigerator, but don't overcrowd it so air movement is blocked.
- It is a waste of electricity to set the refrigerator and freezer to temperatures colder than they need to be. If ice cream is firm in the freezer and drinks are as cold as your family likes them, that's cold enough.
- Make sure your refrigerator is not next to a heat source such as a range, water heater, furnace, radiator, or in direct sunlight.

Caring for Your Refrigerator

Your refrigerator is built to give you many years of dependable service. However, there are a few things you can do to help extend its product life. This section tells you how to clean your refrigerator and what to do when going on vacation, moving, or during a power outage.

Cleaning your refrigerator

Both the refrigerator and freezer sections defrost automatically. However, clean both about once a month to help prevent odors from building up. Wipe up spills right away.



To clean your refrigerator, unplug it, take out all removable parts, and clean the refrigerator according to the following directions.

⚠ WARNING

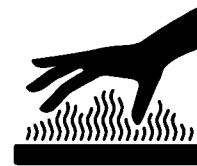

Burn Hazard

Do not touch refrigeration tubes near defrost pan.

Doing so can result in burns.

PART	WHAT TO USE	HOW TO CLEAN
Removable parts (shelves, crisper, etc.)	Sponge or cloth with mild detergent and warm water	<ul style="list-style-type: none"> • Hand wash, rinse, and dry thoroughly.
Outside	Sponge, cloth, or paper towel with mild detergent, warm water, and a good appliance wax (or good auto paste wax)	<ul style="list-style-type: none"> • Wash outside of cabinet. Do not use abrasive or harsh cleaners. • Wipe thoroughly. • Wax painted metal surfaces at least twice a year. Apply wax with a clean, soft cloth. Waxing painted metal surfaces provides rust protection. Do not wax plastic parts.
Inside walls (allow freezer to warm up so cloth won't stick)	Sponge, soft cloth, or paper towel with baking soda or mild detergent and warm water	<ul style="list-style-type: none"> • Wash with mixture of warm water and: <ul style="list-style-type: none"> – mild detergent, or – baking soda (2 tbs to 1 qt [26 g to .95 L] of water). • Wipe thoroughly.
Door liners and gaskets	Sponge, soft cloth, or paper towel with mild detergent and warm water	<ul style="list-style-type: none"> • Wash and wipe thoroughly. <p>DO NOT USE cleaning waxes, concentrated detergents, bleaches, or cleaners containing petroleum on plastic parts.</p>
Plastic parts (covers and panels)	Soft, clean sponge or soft, clean cloth with mild detergent and warm water	<ul style="list-style-type: none"> • Wash and wipe thoroughly. <p>DO NOT USE paper towels, window sprays, scouring cleansers, or flammable fluids. These can scratch or damage material. See "Important Safety Instructions" on page 3.</p>

PART	WHAT TO USE	HOW TO CLEAN
Defrost pan	Sponge or cloth with mild detergent and warm water	<ul style="list-style-type: none"> • Remove base grille. (See page 21.) • Lift defrost pan over wire brace. Remove tape, if any. • Wash, rinse, and dry thoroughly. • Replace defrost pan with notched corner to the rear. Push pan in all the way. Make sure that the defrost drain tube is directed into defrost pan. • Replace base grille.
Condenser coils	Vacuum cleaner with extended narrow attachment	<ul style="list-style-type: none"> • Remove base grille. • Vacuum coils when dusty or dirty. Coils may need to be cleaned as often as every other month. • Replace base grille.

Vacation and moving care

Short vacations

No need to shut off the refrigerator if you will be away for less than four weeks.

1. Use up any perishables.
2. Freeze other items.
3. Raise signal arm to OFF (up) position.
4. Shut off water supply to the ice maker.

Long vacations

If you will be gone a month or more:

1. Remove all food from the refrigerator.
2. Turn off the water supply to the ice maker at least one day ahead of time.
3. When the last load of ice drops, turn off the ice maker. Make sure all ice is dispensed out of the ice maker mechanism.
4. Unplug the refrigerator.
5. Clean it, wipe well, and dry.
6. Tape rubber or wood blocks to the tops of both doors to prop them open far enough for air to get in. This stops odor and mold from building up.

To restart refrigerator, see page 7.

Moving

When you are moving the refrigerator to a new home:

1. Turn off the water supply to the ice maker at least one day ahead of time.
2. Disconnect the water line.
3. After the last load of ice drops, lift the signal arm to the OFF (up) position.
4. Remove all food from the refrigerator.
5. Pack all frozen food in dry ice.
6. Unplug the refrigerator.
7. Clean it thoroughly. Wipe well and dry.
8. Take out all removable parts, wrap them well, and tape them together so they don't shift and rattle.
9. Screw in the leveling rollers.
10. Tape the doors shut and tape the power supply cord to the cabinet.

When you get to your new home, put everything back and refer to page 5. Also, if your refrigerator has an automatic ice maker, remember to reconnect the water supply line.

Power interruptions

If electricity goes off, call the power company. Ask how long power will be off.

1. If service will be interrupted 24 hours or less, **keep both doors closed**. This helps foods stay frozen.
2. If service will be interrupted longer than 24 hours:
 - (a) Remove all frozen food and store in a frozen food locker.
OR
 - (b) Place 2 lbs. (907g) of dry ice in freezer for every cubic foot (liter) of freezer space. This will keep food frozen for 2 to 4 days. Wear gloves to protect your hands from dry ice burns.
OR
 - (c) If neither a food locker or dry ice is available, use or can perishable food at once.
3. A full freezer stays cold longer than a partly filled one. A freezer full of meat stays cold longer than a freezer full of baked goods. If food contains ice crystals, it may be safely refrozen, although the quality and flavor may be affected. If the condition of the food is poor, or if you feel it is unsafe, dispose of it.

Questions?

Call our Consumer Assistance Center telephone number, **1-800-422-1230**, from anywhere in the U.S.A.

Food Storage Guide

There is a correct way to package and store refrigerated or frozen food. To keep food fresher, longer, take the time to study these recommended steps.

Storing fresh food

Wrap or store food in the refrigerator in airtight and moisture-proof material. This prevents food odor and taste transfer throughout the refrigerator. For dated products, check code date to ensure freshness.

Leafy vegetables

Remove store wrapping and trim or tear off bruised and discolored areas. Wash in cold water and drain. Place in plastic bag or plastic container and store in crisper.

Vegetables with skins

(carrots, peppers)

Store in crisper, plastic bags, or plastic container.

Fruit

Wash, let dry, and store in refrigerator in plastic bags or crisper. Do not wash or hull berries until they are ready to use. Sort and keep berries in original container in a crisper, or store in a loosely closed paper bag on a refrigerator shelf.

Eggs

Store without washing in original carton on interior shelf. On some models, an egg storage container is provided for your convenience.

Milk

Wipe milk cartons. For best storage, place milk on interior shelf.

Butter or margarine

Keep opened butter in covered dish or closed compartment. When storing an extra supply, wrap in freezer packaging and freeze.

Cheese

Store in the original wrapping until you are ready to use it. Once opened, rewrap tightly in plastic wrap or aluminum foil.

Leftovers

Cover leftovers with plastic wrap or aluminum foil. Plastic containers with tight lids can also be used.

Meat

Store most meat in original wrapping as long as it is airtight and moisture-proof. Rewrap if necessary. See the following for storage times. When storing meat longer than the times given, freeze the meat.

Chicken	1-2 days	Bacon	5-7 days
Ground beef	1-2 days	Cold cuts	3-5 days
Steaks/roasts	3-5 days	Variety meats	1-2 days
Cured meats ...	7-10 days		

NOTE: Use fresh fish and shellfish the same day as purchased.

Storing frozen food

The freezer section is designed for storage of commercially frozen food and for freezing food at home.

NOTE: For further information about preparing food for freezing or food storage times, check a freezer guide or reliable cookbook.

Packaging

The secret of successful freezing is in the packaging. The way you close and seal the package must not allow air or moisture in or out. Packaging done in any other way could cause food odor and taste transfer throughout the refrigerator and drying of frozen food.

Packaging recommended for use:

- Rigid plastic containers with tight-fitting lids
- Straight-sided canning/freezing jars
- Heavy-duty aluminum foil
- Plastic-coated paper
- Non-permeable plastic wraps (made from saran film)

Follow package or container instructions for proper freezing methods.

Do not use:

- Bread wrappers
- Non-polyethylene plastic containers
- Containers without tight lids
- Wax paper
- Wax-coated freezer wrap
- Thin, semi-permeable wrap

The use of these wrappings could cause food odor, taste transfer, and drying of frozen food.

Freezing

Do not expect your freezer to quick-freeze any large quantity of food. Put no more unfrozen food into the freezer than will freeze within 24 hours (no more than 2-3 lbs. of food per cubic foot [900-1,350 g per liter] of freezer space). Leave enough space for air to circulate around packages. Be careful to leave enough room at the front so the door can close tightly.

Storage times will vary according to the quality of the food, the type of packaging or wrap used (airtight and moisture-proof), and the storage temperature, which should be 0°F (-17.8°C).

Troubleshooting

Performance problems often result from little things you can fix without tools. Please read through "Before calling for assistance ..." below before calling for service on your appliance.

Before calling for assistance ...

Listed in this chart are the most common problems consumers run into with their appliances. Please read through this and see if it can solve your problem.

PROBLEM	CHECK THE FOLLOWING
Your refrigerator will not operate	Is the power supply cord firmly plugged into a live circuit with proper voltage? Has a household fuse or circuit breaker blown/tripped? Is the Freezer Control set to the OFF position?
The lights do not work	Is the power supply cord firmly plugged into a live circuit with proper voltage? Has a household fuse or circuit breaker blown/tripped? Is a bulb burned out?
Dispensers will not operate	See "Solving common dispenser problems" on page 17.
The ice maker does not work	See "Solving common ice maker problems" on page 15.
Unfamiliar sounds or a rattling/jingling noise	Is something on top of or behind the refrigerator? Some new sounds are normal. See "Understanding the sounds you may hear" on page 23.
There is water in the defrost pan	This is normal on hot, muggy days. Make sure the refrigerator is level so the pan does not overflow.
The motor seems to run too much	Are the condenser coils dirty? Has the door been opened often? Has a large amount of food been added at one time? The motor naturally runs longer if these things happen. Is the room hot? If the room is too warm, the motor runs longer to keep the unit cool.

Requesting Assistance or Service

Before calling for assistance or service, please check "Troubleshooting" on page 29. It may save you the cost of a service call. If you still need help, follow the instructions below.

1. If you need assistance:

Call the KitchenAid Consumer Assistance Center toll-free:



1-800-422-1230

and talk with one of our trained consultants. The consultant can instruct you in how to obtain satisfactory operation from your appliance or, if service is necessary, recommend a qualified service company in your area.

If you prefer, write to:

KitchenAid Brand Home Appliances
Consumer Assistance Center
c/o Correspondence Dept.
2000 North M-63
Benton Harbor, MI 49022-2692

Please include a daytime phone number in your correspondence.

2. If you need service:

Call your dealer or the repair service he recommends.



All service should be handled locally by the dealer from whom you purchased the unit or an authorized KitchenAid servicer. If you are unable to obtain the name of a local authorized KitchenAid servicer, call

our Consumer Assistance Center telephone number (see Step 1).

3. If you are not satisfied with the action taken:

- Contact the Major Appliance Consumer Action Program (MACAP). MACAP is a group of consumer experts that voices consumer views at the highest levels of the major appliance industry.
- Contact MACAP only when the dealer, authorized servicer, and KitchenAid have failed to resolve your problem.

Major Appliance Consumer Action Program
20 North Wacker Drive
Chicago, IL 60606

- MACAP will in turn inform us of your action.

When asking for help or service:

Please provide a detailed description of the problem, your appliance's complete model and serial numbers, and the purchase date. (See page 2.) This information will help us respond properly to your request.

KitchenAid®

Freestanding Refrigerator Warranty

LENGTH OF WARRANTY	KITCHENAID WILL PAY FOR	KITCHENAID WILL NOT PAY FOR
ONE YEAR FULL WARRANTY FROM DATE OF PURCHASE.	Replacement parts and repair labor costs to correct defects in materials or workmanship. Service must be provided by an authorized KitchenAid servicing outlet.	A. Service calls to: 1. Correct the installation of the refrigerator. 2. Instruct you how to use the refrigerator. 3. Replace house fuses or correct house wiring. 4. Replace house plumbing. B. Repairs when refrigerator is used in other than normal home use. C. Damage resulting from accident, alteration, misuse, abuse, improper installation or installation not in accordance with local electrical codes or plumbing codes. D. Any food loss due to product failure. E. Any labor costs during the limited warranty. F. Replace parts or repair labor costs for units operated outside the United States. G. Pickup and delivery. This product is designed to be repaired in the home. H. Repairs to parts or systems caused by unauthorized modifications made to the appliance.
SECOND THROUGH FIFTH YEAR FULL WARRANTY FROM DATE OF PURCHASE.	Replacement or repair of the refrigerator/freezer cavity liner, (including labor costs) if the part cracks due to defective material or workmanship. Service must be provided by an authorized KitchenAid servicing outlet. Replacement parts and repair labor costs to correct defects in materials or workmanship in the sealed refrigeration system. These parts are: 1. Compressor; 2. Evaporator; 3. Condenser; 4. Drier; 5. Connecting Tubing. Service must be provided by an authorized KitchenAid servicing outlet.	
SIXTH THROUGH TENTH YEAR LIMITED WARRANTY FROM DATE OF PURCHASE.	Replacement parts to correct defects in materials or workmanship in the sealed refrigeration system. These parts are: 1. Compressor; 2. Evaporator; 3. Condenser; 4. Drier; 5. Connecting Tubing.	
LIMITED LIFETIME WARRANTY SECOND YEAR THROUGH LIFE OF PRODUCT FROM DATE OF PURCHASE	Replacement of all SLIDE 'N' LOCK™ Door Bins and SLIDE 'N' LOCK Can Racks due to defective material or workmanship.	

3/96

KITCHENAID DOES NOT ASSUME ANY RESPONSIBILITY FOR INCIDENTAL OR CONSEQUENTIAL DAMAGES. Some states do not allow the exclusion or limitation of incidental or consequential damages, so this exclusion or limitation may not apply to you.

This warranty gives you specific legal rights and you may also have other rights which may vary from state to state.

Outside the United States, a different warranty may apply. For details, please contact your authorized KitchenAid dealer.

If you need service, first see the "Troubleshooting" section of this book. After checking "Troubleshooting," additional help can be found by checking the "Requesting Assistance or Service" section, or by calling our Consumer Assistance Center telephone number, **1-800-422-1230**, from anywhere in the U.S.A.

KitchenAid
St. Joseph, Michigan, 49085 U.S.A.

PART NO. 2194692
© 1996 KitchenAid, U.S.A.

© Registered Trademark/TM Trademark of KitchenAid, U.S.A.

4/96
Printed in U.S.A.

Free Manuals Download Website

<http://myh66.com>

<http://usermanuals.us>

<http://www.somanuals.com>

<http://www.4manuals.cc>

<http://www.manual-lib.com>

<http://www.404manual.com>

<http://www.luxmanual.com>

<http://aubethermostatmanual.com>

Golf course search by state

<http://golfingnear.com>

Email search by domain

<http://emailbydomain.com>

Auto manuals search

<http://auto.somanuals.com>

TV manuals search

<http://tv.somanuals.com>