

KitchenAid®

ELECTRIC RANGE

PRO LINE™ SERIES AND ARCHITECT® SERIES

Use & Care Guide

For questions about features, operation/performance, parts, accessories or service, call: **1-800-422-1230**
In Canada, call for assistance **1-800-461-5681**, for installation and service, call: **1-800-807-6777** or visit our website at...
www.kitchenaid.com or **www.KitchenAid.ca**

Table of Contents..... 2



Models KERA807 KESI901 KESA907 KESV908 YKESA907 YKERA807 YKESV908
9757451

TABLE OF CONTENTS

RANGE SAFETY	3	Meat Thermometer.....	17
The Anti-Tip Bracket	3	Temperature Probe	18
PARTS AND FEATURES	6	Oven Vent.....	18
COOKTOP USE	8	Positioning Racks and Bakeware	19
Ceramic Glass	8	Oven Half-Rack with Removable Insert.....	19
Cookware	9	Bake.....	20
Home Canning	9	Broil.....	20
Cooktop Controls for Electronic Touch Activated System	9	Convection Cooking.....	21
Cooktop Controls for Electronic Knob Control System	11	EASYCONNECT™ Conversion	21
Cooktop Controls for Standard Knob Control System	13	Convection Bake	21
ELECTRONIC OVEN CONTROL	15	Convection Roast.....	22
Electronic Control Pads	15	Convection Broil	23
Oven Displays	15	Convect Full Meal.....	23
Start	16	Sabbath Mode.....	24
Control Lock.....	16	Proofing Bread	24
Off.....	16	Timed Cooking	25
Clock/Timer Display	16	Warming Drawer.....	25
OPTIONS	16	RANGE CARE	26
Options Selection Pad	16	Self-Cleaning Cycle.....	26
Fahrenheit and Celsius.....	16	General Cleaning	27
Tones.....	16	Oven Light(s).....	28
Oven Temperature Control	16	Storage Drawer	29
Timer.....	17	Oven Door	29
OVEN USE	17	Warming Drawer.....	29
Aluminum Foil.....	17	TROUBLESHOOTING	30
Bakeware.....	17	ASSISTANCE OR SERVICE	31
		WARRANTY	32

RANGE SAFETY

Your safety and the safety of others are very important.

We have provided many important safety messages in this manual and on your appliance. Always read and obey all safety messages.



This is the safety alert symbol.

This symbol alerts you to potential hazards that can kill or hurt you and others.

All safety messages will follow the safety alert symbol and either the word "DANGER" or "WARNING." These words mean:

⚠ DANGER

You can be killed or seriously injured if you don't immediately follow instructions.

⚠ WARNING

You can be killed or seriously injured if you don't follow instructions.

All safety messages will tell you what the potential hazard is, tell you how to reduce the chance of injury, and tell you what can happen if the instructions are not followed.

The Anti-Tip Bracket

The range will not tip during normal use. However, the range can tip if you apply too much force or weight to the open door without the anti-tip bracket fastened down properly.

⚠ WARNING

Tip Over Hazard

A child or adult can tip the range and be killed.

Connect anti-tip bracket to rear range foot.

Reconnect the anti-tip bracket, if the range is moved.

See the installation instructions for details.

Failure to follow these instructions can result in death or serious burns to children and adults.



Anti-Tip Bracket

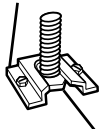

Range Foot

Making sure the anti-tip bracket is installed:

- Slide range forward.
- Look for the anti-tip bracket securely attached to floor.
- Slide range back so rear range foot is under anti-tip bracket.

IMPORTANT SAFETY INSTRUCTIONS

WARNING: To reduce the risk of fire, electrical shock, injury to persons, or damage when using the range, follow basic precautions, including the following:

- **WARNING:** TO REDUCE THE RISK OF TIPPING OF THE RANGE, THE RANGE MUST BE SECURED BY PROPERLY INSTALLED ANTI-TIP DEVICES. TO CHECK IF THE DEVICES ARE INSTALLED PROPERLY, SLIDE RANGE FORWARD, LOOK FOR ANTI-TIP BRACKET SECURELY ATTACHED TO FLOOR, AND SLIDE RANGE BACK SO REAR RANGE FOOT IS UNDER ANTI-TIP BRACKET.
- **CAUTION:** Do not store items of interest to children in cabinets above a range or on the backguard of a range – children climbing on the range to reach items could be seriously injured.
- Proper Installation – Be sure the range is properly installed and grounded by a qualified technician.
- Never Use the Range for Warming or Heating the Room.
- Do Not Leave Children Alone – Children should not be left alone or unattended in area where the range is in use. They should never be allowed to sit or stand on any part of the range.
- Wear Proper Apparel – Loose-fitting or hanging garments should never be worn while using the range.
- User Servicing – Do not repair or replace any part of the range unless specifically recommended in the manual. All other servicing should be referred to a qualified technician.
- Storage in or on the Range – Flammable materials should not be stored in an oven or near surface units.
- Do Not Use Water on Grease Fires – Smother fire or flame or use dry chemical or foam-type extinguisher.
- Use Only Dry Potholders – Moist or damp potholders on hot surfaces may result in burns from steam. Do not let potholder touch hot heating elements. Do not use a towel or other bulky cloth.
- DO NOT TOUCH SURFACE UNITS OR AREAS NEAR UNITS – Surface units may be hot even though they are dark in color. Areas near surface units may become hot enough to cause burns. During and after use, do not touch, or let clothing or other flammable materials contact surface units or areas near units until they have had sufficient time to cool. Among those areas are the cooktop and surfaces facing the cooktop.
- Use Proper Pan Size – The range is equipped with one or more surface units of different size. Select utensils having flat bottoms large enough to cover the surface unit heating element. The use of undersized utensils will expose a portion of the heating element to direct contact and may result in ignition of clothing. Proper relationship of utensil to burner will also improve efficiency.
- Never Leave Surface Units Unattended at High Heat Settings – Boilover causes smoking and greasy spillovers that may ignite.
- Make Sure Reflector Pans or Drip Bowls Are in Place – Absence of these pans or bowls during cooking may subject wiring or components underneath to damage.
- Protective Liners – Do not use aluminum foil to line surface unit drip bowls or oven bottoms, except as suggested in the manual. Improper installation of these liners may result in a risk of electric shock, or fire.
- Glazed Cooking Utensils – Only certain types of glass, glass/ceramic, ceramic, earthenware, or other glazed utensils are suitable for range-top service without breaking due to the sudden change in temperature.
- Utensil Handles Should Be Turned Inward and Not Extend Over Adjacent Surface Units – To reduce the risk of burns, ignition of flammable materials, and spillage due to unintentional contact with the utensil, the handle of a utensil should be positioned so that it is turned inward, and does not extend over adjacent surface units.
- Do Not Soak Removable Heating Elements – Heating elements should never be immersed in water.
- Do Not Cook on Broken Cooktop – If cooktop should break, cleaning solutions and spillovers may penetrate the broken cooktop and create a risk of electric shock. Contact a qualified technician immediately.
- Clean Cooktop With Caution – If a wet sponge or cloth is used to wipe spills on a hot cooking area, be careful to avoid steam burn. Some cleaners can produce noxious fumes if applied to a hot surface.
- Use Care When Opening Door – Let hot air or steam escape before removing or replacing food.
- Do Not Heat Unopened Food Containers – Build-up of pressure may cause container to burst and result in injury.

SAVE THESE INSTRUCTIONS

IMPORTANT SAFETY INSTRUCTIONS

- Keep Oven Vent Ducts Unobstructed.
- Placement of Oven Racks – Always place oven racks in desired location while oven is cool. If rack must be moved while oven is hot, do not let potholder contact hot heating element in oven.
- DO NOT TOUCH HEATING ELEMENTS OR INTERIOR SURFACES OF OVEN – Heating elements may be hot even though they are dark in color. Interior surfaces of an oven become hot enough to cause burns. During and after use, do not touch, or let clothing or other flammable materials contact heating elements or interior surfaces of oven until they have had sufficient time to cool. Other surfaces of the appliance may become hot enough to cause burns – among these surfaces are oven vent openings and surfaces near these openings, oven doors, and windows of oven doors.

For self-cleaning ranges –

- Do Not Clean Door Gasket – The door gasket is essential for a good seal. Care should be taken not to rub, damage, or move the gasket.
- Do Not Use Oven Cleaners – No commercial oven cleaner or oven liner protective coating of any kind should be used in or around any part of the oven.
- Clean Only Parts Listed in Manual.
- Before Self-Cleaning the Oven – Remove broiler pan and other utensils.

For units with ventilating hood –

- Clean Ventilating Hoods Frequently – Grease should not be allowed to accumulate on hood or filter.
- When flaming foods under the hood, turn the fan on.

SAVE THESE INSTRUCTIONS

The California Safe Drinking Water and Toxic Enforcement Act requires the Governor of California to publish a list of substances known to the State of California to cause cancer, birth defects, or other reproductive harm, and requires businesses to warn of potential exposure to such substances.

WARNING: This product contains a chemical known to the State of California to cause cancer, birth defects, or other reproductive harm.

This appliance can cause low-level exposure to some of the substances listed, including benzene, formaldehyde, carbon monoxide, and toluene.

PARTS AND FEATURES

This manual covers several different models. The range you have purchased may have some or all of the items listed. The locations and appearances of the features shown here may not match those of your model.

Control Panel for Electronic Touch Activated System (Models KESV908 and YKESV908 - Pro Line™ Series)

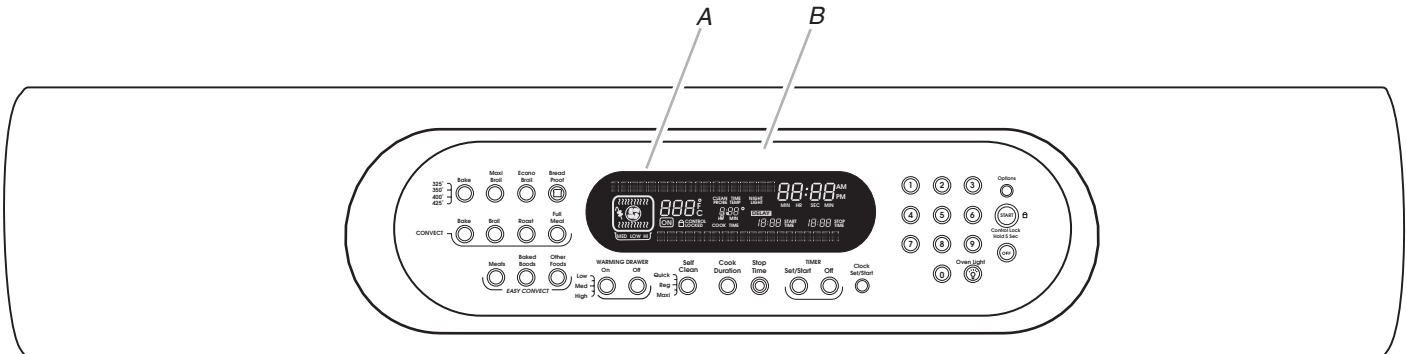

A. Oven Display
B. Oven Control Panel

Control Panel for Electronic Knob Control System (Models KERA807, YKERA807, KESA907 and YKESA907 - Architect® Series)

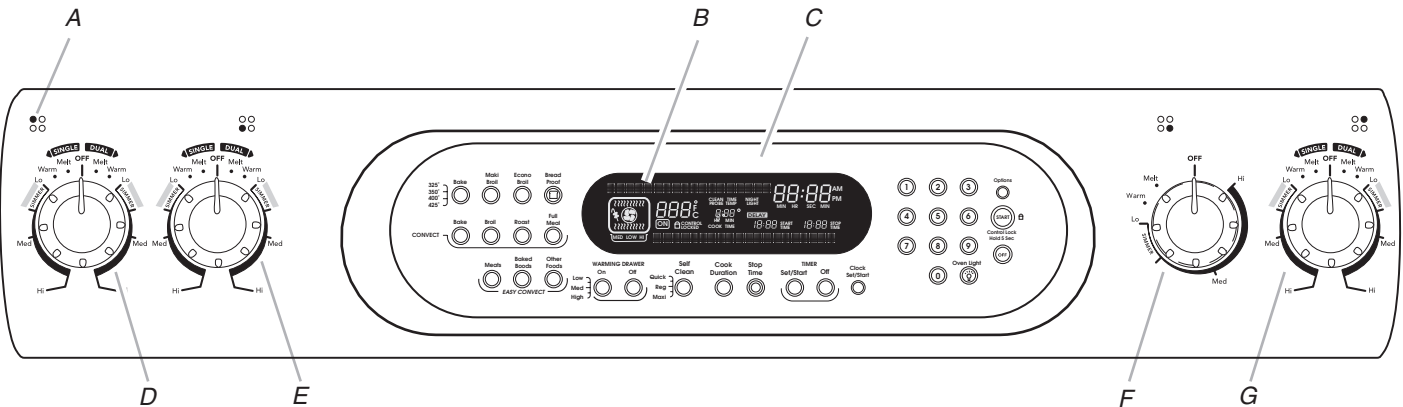

A. Surface Locator Indicator Light
B. Oven Display
C. Oven Control Panel

D. Left Rear Cooktop Element Control (Dual-Size Element)
E. Left Front Cooktop Element Control (Dual-Size Element)

F. Right Front Cooktop Element Control (Single Element)
G. Right Rear Cooktop Element Control (Dual-Size Element)

Control Panel For Standard Knob Controls (Model KES1901)

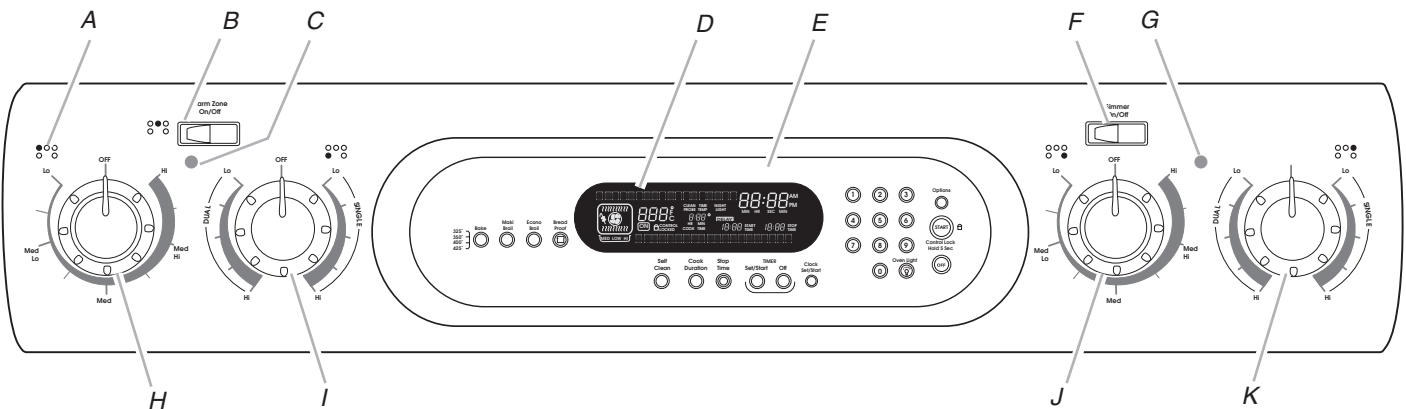

A. Surface Indicator
B. Warm Zone Element On/Off Switch

C. Cooktop Power On Indicator Light
D. Oven Display
E. Oven Control Panel
F. Right Front Simmer On/Off Switch

G. Cooktop Power On Indicator Light
H. Left Rear Cooktop Element Control
I. Left Front Cooktop Element Control (Dual-Size Element)

J. Right Front Cooktop Element Control
K. Right Rear Cooktop Element Control

Cooktop Element Controls for Electronic Touch Activated System

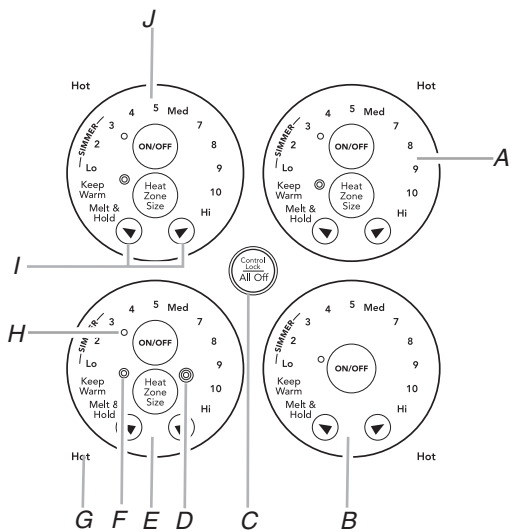

- A. Right Rear Touch Control (Dual-Size Element)
- B. Right Front Touch Control (Single Element)
- C. ALL OFF Control Lock
- D. Zone diameter indicator (Triple)
- E. Left Front Touch Control (Triple-Size Element)
- F. Zone diameter indicator (Dual)
- G. Hot Surface Indicator Lights
- H. Zone diameter indicator (Single)
- I. Increase/Decrease Temperature Touch Control
- J. Left Rear Touch Control (Dual-Size Element)

Range (Electronic Touch Activated System)

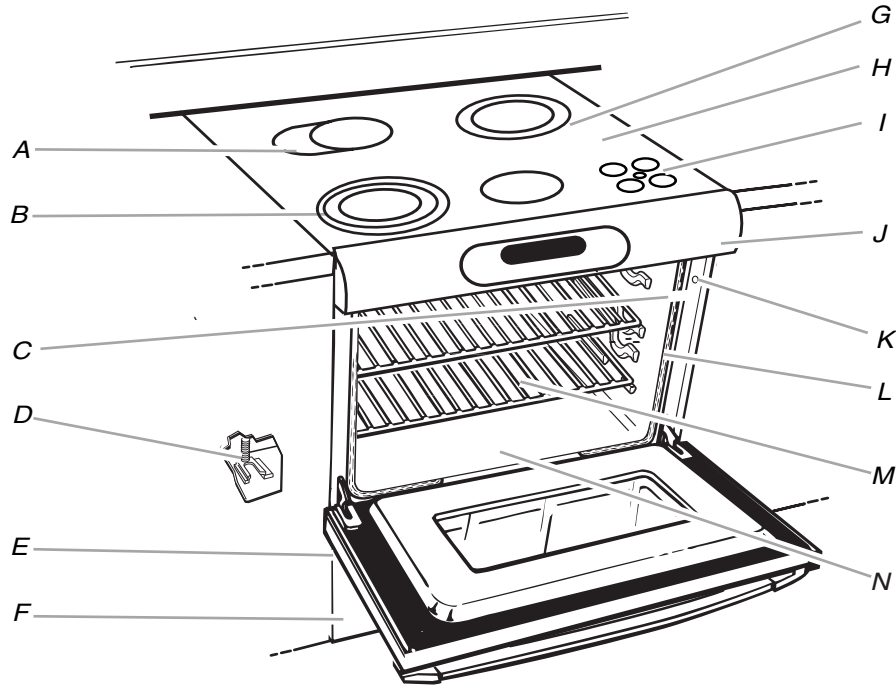

- A. Dual-Size Oval Element
- B. Triple-Size Element
- C. Temperature Probe Jack (not shown)
- D. Anti-Tip Bracket

- E. Model and Serial Number (behind left side of drawer)
- F. Warming Drawer
- G. Dual-Size Element
- H. Ceramic Surface Cooking Area
- I. Electronic Cooktop Touch Controls

- J. Oven Control Panel
- K. Automatic Oven Light
- L. Door Gasket
- M. Broil Element (not shown)
- N. CleanBake™ Element (not shown)

- Parts and Features not shown (on some models)**
- Ceramic Glass
 - Oven Door Window
 - Oven Light
 - Broiler Pan and Grid
 - Roasting Rack
 - Temperature Probe
 - T.H.E.™ Convection Fan & Element

Range (Standard and Electronic Knob Control System)

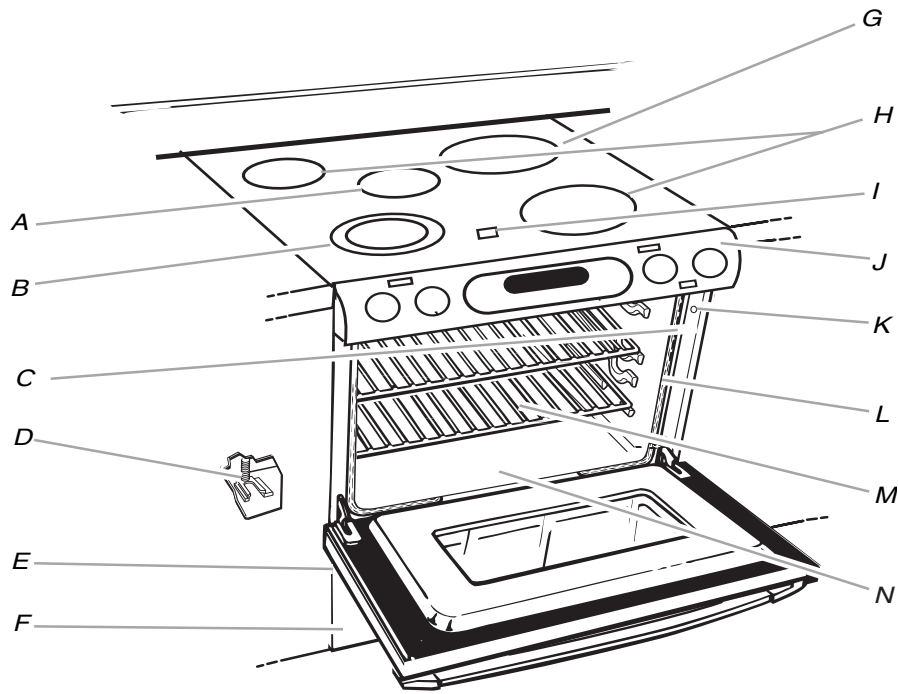

A. Warming Zone Element (on some models)
 B. Dual-Size Element
 C. Temperature Probe Jack (not shown)
 D. Anti-Tip Bracket

E. Model and Serial Number (behind left side of drawer)
 F. Warming Drawer (Storage Drawer on some models)
 G. Ceramic Glass Surface Cooking Area
 H. Selectable Simmer Feature (available on left rear on some models)

I. Hot Surface Indicator Lights
 J. Control Panel
 K. Automatic Oven Light
 L. Door Gasket
 M. Broil Element (not shown)
 N. CleanBake™ Element (not shown)

Parts and Features not shown (on some models)
 Ceramic Glass
 Oven Door Window
 Oven Light
 Broiler Pan and Grid
 Roasting Rack
 Temperature Probe
 T.H.E.™ Convection Fan & Element

COOKTOP USE

Ceramic Glass

The surface cooking area will glow red when an element is on. It will cycle on and off, at all settings, to maintain the selected heat level.

Wiping off the cooktop before and after each use will help keep it free from stains and provide the most even heating. On cooktops with white ceramic glass, soils and stains may be more visible, and may require more cleaning and care. For more information, see "General Cleaning" section.

- Do not store jars or cans above the cooktop. Dropping a heavy or hard object onto the cooktop could crack it.
- Do not leave a hot lid on the cooktop. As the cooktop cools, air can become trapped between the lid and the cooktop, and the ceramic glass could break when the lid is removed.
- For foods containing sugar in any form, clean up all spills and soils as soon as possible. Allow the cooktop to cool down slightly. Then, while wearing oven mitts, remove the spills while the surface is still warm. If sugary spills are allowed to cool down, they can adhere to the cooktop and can cause pitting and permanent marks.
- Do not slide cookware or bakeware across the cooktop. Aluminum or copper bottoms and rough finishes on cookware or bakeware could leave scratches or marks on the cooktop.
- Do not cook popcorn in prepackaged aluminum containers on the cooktop. It could leave aluminum marks that cannot be removed completely.

- Do not allow objects that could melt, such as plastic or aluminum foil, to touch any part of the entire cooktop.
- Do not use the cooktop as a cutting board.
- Use cookware about the same size as the surface cooking area. Cookware should not extend more than ½" (1.25 cm) outside the area.

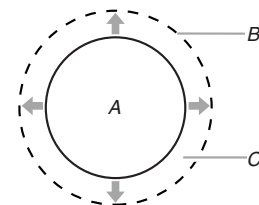

A. Surface Cooking Area
 B. Cookware/Canner
 C. ½" (1.25 cm) Maximum Overhang

- Use flat-bottomed cookware for best heat conduction and energy efficiency. Cookware with rounded, warped, ribbed or dented bottoms could cause uneven heating and poor cooking results.

- Determine flatness by placing the straight edge of a ruler across the bottom of the cookware. While you rotate the ruler, no space or light should be visible between it and the cookware.
- Cookware designed with slightly indented bottoms or small expansion channels can be used.
- Make sure the bottoms of pots and pans are clean and dry before using them. Residue and water can leave deposits when heated.
- Do not cook foods directly on the cooktop.

Cookware

IMPORTANT: Do not leave empty cookware on a hot surface cooking area, element or surface burner.

Ideal cookware should have a flat bottom, straight sides, a well-fitting lid and the material should be of medium-to-heavy thickness.

Rough finishes may scratch the cooktop. Aluminum and copper may be used as a core or base in cookware. However, when used as a base it can leave permanent marks on the cooktop or grates.

Cookware material is a factor in how quickly and evenly heat is transferred, which affects cooking results. A nonstick finish has the same characteristics as its base material. For example, aluminum cookware with a nonstick finish will take on the properties of aluminum.

Use the following chart as a guide for cookware material characteristics.

COOKWARE	CHARACTERISTICS
Aluminum	<ul style="list-style-type: none"> ■ Heats quickly and evenly. ■ Suitable for all types of cooking. ■ Medium or heavy thickness is best for most cooking tasks.
Cast iron	<ul style="list-style-type: none"> ■ Heats slowly and evenly. ■ Good for browning and frying. ■ Maintains heat for slow cooking.
Ceramic or Ceramic glass	<ul style="list-style-type: none"> ■ Follow manufacturer's instructions. ■ Heats slowly, but unevenly. ■ Ideal results on low to medium heat settings.
Copper	<ul style="list-style-type: none"> ■ Heats very quickly and evenly.
Earthenware	<ul style="list-style-type: none"> ■ Follow manufacturer's instructions. ■ Use on low heat settings.
Porcelain enamel-on-steel or cast iron	<ul style="list-style-type: none"> ■ See stainless steel or cast iron.
Stainless steel	<ul style="list-style-type: none"> ■ Heats quickly, but unevenly. ■ A core or base of aluminum or copper on stainless steel provides even heating.

Home Canning

When canning for long periods, alternate the use of surface cooking areas, elements or surface burners between batches. This allows time for the most recently used areas to cool.

- Center the canner on the grate or largest surface cooking area or element. Canners should not extend more than 1" (2.5 cm) outside the cooking area.
- Do not place canner on 2 surface cooking areas, elements or surface burners at the same time.
- On ceramic glass models, use only flat-bottomed canners.

For more information, contact your local U.S. Government Agricultural Department Extension Office. In Canada, contact Agriculture Canada. Companies that manufacture home canning products can also offer assistance.

Cooktop Controls for Electronic Touch Activated System (Pro Line™ Series)

⚠ WARNING



Fire Hazard

Turn off all controls when done cooking.
Failure to do so can result in death or fire.

The electronic touch controls offer a variety of heat settings for optimal cooking results. When melting foods such as chocolate or butter, or when proofing bread, the surface cooking area can be set to MELT & HOLD for minimal element operation.

To keep cooked foods warm or to heat serving dishes, the surface cooking area can be set to KEEP WARM.

For maximum element operation, all cooktop touch controls can be set to HI when bringing liquids to a fast and rapid boil. Touch the "down" arrow to immediately reach the HI setting.

NOTE: This cooktop automatically adjusts for 208V operation without affecting cooking performance.

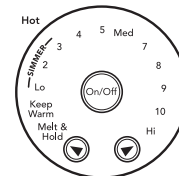

To Use:

1. Touch ON/OFF.
2. Touch the "up" or "down" arrow to increase or decrease power.
3. To choose a power level between HI and MELT & HOLD, touch and hold either arrow until the desired level has been reached.

When finished cooking, touch ON/OFF to turn surface cooking area(s) off individually, or touch ALL OFF to turn all elements off at the same time.

Use the following chart as a guide when setting heat levels.

SETTING	RECOMMENDED USE
DUAL and TRIPLE-SIZE ELEMENTS	<ul style="list-style-type: none"> ■ Large diameter cookware. ■ Large quantities of food. ■ Home canning.
HI	<ul style="list-style-type: none"> ■ Bring liquid to a boil.
MED- HI [8-10]	<ul style="list-style-type: none"> ■ Hold a rapid boil. ■ Quickly brown or sear food.
MED [6-7]	<ul style="list-style-type: none"> ■ Maintain a slow boil. ■ Fry or sauté foods. ■ Cook soups, sauces and gravies.
MED-LO [4-5]	<ul style="list-style-type: none"> ■ Stew or steam food.
LO-3 [SIMMER]	<ul style="list-style-type: none"> ■ Simmer (range of simmer temperatures)
KEEP WARM	<ul style="list-style-type: none"> ■ Keep cooked foods warm.
MELT & HOLD	<ul style="list-style-type: none"> ■ Melt chocolate or butter.

REMEMBER: When cooktop is in use, the entire cooktop area may become hot.

Single, Dual and Triple-Size Elements



A. Single size

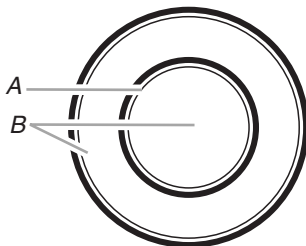

A. Single size
B. Dual size



A. Single size
B. Dual size

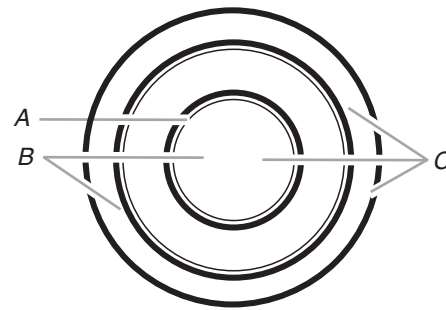

A. Single size
B. Dual size
C. Triple size

To use:

1. Touch ON/OFF.
2. Touch heat zone size to desired zone diameter (single, dual or triple). The corresponding zone diameter indicator light will glow to show which setting is activated.
3. To choose a power level between HI and MELT & HOLD, touch and hold either the “up” or “down” arrow until the desired level has been reached.

When finished cooking, touch ON/OFF to turn surface cooking area(s) off individually, or touch ALL OFF to turn all elements off at the same time.

Melt & Hold

The Melt & Hold function is available on all the surface cooking elements, and is ideal for melting chocolate or butter.

To Use:

1. Touch ON/OFF.
2. Touch the “up” arrow once for MELT & HOLD.

When finished cooking, touch ON/OFF to turn surface cooking area off.

Keep Warm

The Keep Warm function is available on all the surface cooking elements, and is ideal for keeping cooked foods warm. Do not use it to heat cold foods. One hour is the recommended maximum time to maintain food quality.

- Use only cookware and dishes recommended for oven and cooktop use.
- Cover all foods with a lid or aluminum foil. When warming baked goods, allow a small opening in the cover for moisture to escape.
- Do not use plastic wrap to cover food. Plastic wrap may melt.
- Use pot holders or oven mitts to remove food.

To Use:

1. Touch ON/OFF.
2. Touch the “up” arrow twice for KEEP WARM.

When finished cooking, touch ON/OFF to turn surface cooking area off.

Simmer

The Simmer function is available on all the surface cooking elements. It has an adjustable heat setting for more precise simmer control.

Three levels of simmer are available. The recommended setting will vary depending on the quantity and density of the food being cooked as well as the size and shape of the cookware being used.

To Use:

1. Touch ON/OFF.
2. Touch the "up" arrow to select the desired simmer setting.

When finished cooking, touch ON/OFF to turn surface cooking area off.

Use the following chart as a guide when setting heat levels.

SETTING	RECOMMENDED USE
LO	<ul style="list-style-type: none"> ■ Water-based foods such as chicken noodle soup. ■ Bringing water to boil. ■ Cooking with a lid. ■ Cooking with smaller cookware.
2	<ul style="list-style-type: none"> ■ Medium-density foods such as cream soups, sauces and gravy.
3	<ul style="list-style-type: none"> ■ Thicker foods such as tomato sauce, chili. ■ Cooking without a lid. ■ Cooking with larger cookware.

ALL OFF/Control Lock

The ALL OFF cooktop touch controls turn off all surface cooking areas that are in use at the same time.

The Control Lock cooktop touch control prevents unintended use of the surface cooking areas. When the cooktop is locked out, the surface cooking areas cannot be turned on by the cooktop touch controls.

To Lock Cooktop: Press and hold the Control Lock/ALL OFF keypad for 5 seconds. After 5 seconds, CONTROL LOCK will glow red, indicating that the cooktop touch controls are in the lockout position.

To Unlock Cooktop: Press and hold the Control Lock/ALL OFF keypad for 5 seconds.

Hot Surface Indicator Lights

The Hot Surface Indicator Lights are located next to each of the cooktop touch controls. The Hot Surface Indicator Lights will glow as long as any surface cooking area is too hot to touch, even after the surface cooking area(s) is turned off.

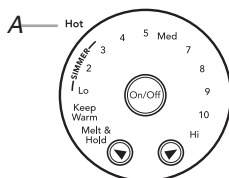

A. Hot Surface Indicator Light

Cooktop Controls for Electronic Knob Control System (Architect® Series)

WARNING



Fire Hazard

**Turn off all controls when done cooking.
Failure to do so can result in death or fire.**

The knob-activated electronic system controls offer a variety of heat settings for optimal cooking results. When melting foods such as chocolate or butter, the surface cooking area can be set to MELT for minimal element operation.

To keep cooked foods warm or to heat serving dishes, the surface cooking area can be set to WARM.

For maximum element operation, all knob-activated electronic system controls can be set to HI when bringing liquids to a fast and rapid boil.

NOTE: This cooktop automatically adjusts for 208V operation without affecting cooking performance.

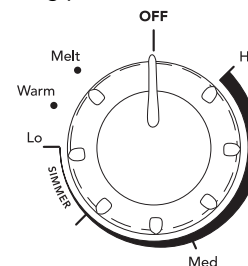

To Use:

1. The cooktop control can be set anywhere between HI and MELT.
2. Push in and turn to desired setting.

Use the following chart as a guide when setting heat levels.

SETTING	RECOMMENDED USE
DUAL-SIZE ELEMENT	<ul style="list-style-type: none"> ■ Large diameter cookware. ■ Large quantities of food. ■ Home canning.
HI	<ul style="list-style-type: none"> ■ Bring liquid to a boil.
MED- HI	<ul style="list-style-type: none"> ■ Hold a rapid boil. ■ Quickly brown or sear food.
MED	<ul style="list-style-type: none"> ■ Maintain a slow boil. ■ Fry or sauté foods. ■ Cook soups, sauces and gravies.
MED-LO	<ul style="list-style-type: none"> ■ Stew or steam food.
LO [SIMMER]	<ul style="list-style-type: none"> ■ Simmer (range of simmer temperatures).

SETTING	RECOMMENDED USE
WARM	■ Keep cooked foods warm.
MELT	■ Melt chocolate or butter.

REMEMBER: When range is in use or (on some models) during the Self-Cleaning cycle, the entire cooktop area may become hot.

Single and Dual-Size Elements



A. Single size

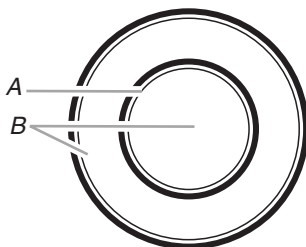

A. Single size
B. Dual size



A. Single size
B. Dual size

The Dual-Size Elements offer flexibility depending on the size of the cookware. Single size can be used in the same way as a regular element. The dual size combines both the single and outer element and is recommended for larger size cookware.

To Use SINGLE:

1. Push in and turn knob counterclockwise from the OFF position to the SINGLE zone anywhere between LO and HI.
2. Turn knob to OFF when finished.

To Use DUAL:

1. Push in and turn knob clockwise from the OFF position to the DUAL zone anywhere between LO and HI.
2. Turn knob to OFF when finished.

Melt

The Melt function is available on all the surface cooking elements, and is ideal for melting chocolate or butter.

To Use:

1. Push in and turn knob to MELT setting.
2. Turn knob to OFF when finished.

Warm

The Warm function is available on all the surface cooking elements, and is ideal for keeping cooked foods warm. Do not use it to heat cold foods. One hour is the recommended maximum time to maintain food quality.

- Use only cookware and dishes recommended for oven and cooktop use.
- Cover all foods with a lid or aluminum foil. When warming baked goods, allow a small opening in the cover for moisture to escape.
- Do not use plastic wrap to cover food. Plastic wrap may melt.
- Use pot holders or oven mitts to remove food.

To Use:

1. Push in and turn knob to WARM setting.
2. Turn knob to OFF when finished.

Simmer

The Simmer function is available on all cooking elements. It has an adjustable heat setting for more precise simmer control.

Three levels of simmer are available. The recommended setting will vary depending on the quantity and density of the food being cooked as well as the size and shape of the cookware used.

To Use:

1. Push in and turn knob to the desired SIMMER setting.
2. Turn knob to OFF when finished.

Use the following chart as a guide when setting heat levels.

SETTING	RECOMMENDED USE
LO	<ul style="list-style-type: none"> ■ Water-based foods such as chicken noodle soup. ■ Bringing water to boil. ■ Cooking with a lid. ■ Cooking with smaller cookware.
2	<ul style="list-style-type: none"> ■ Medium-density foods such as cream soups, sauces and gravy.
3	<ul style="list-style-type: none"> ■ Thicker foods such as tomato sauce, chili. ■ Cooking without a lid. ■ Cooking with larger cookware.

POWER ON Lights

Each control knob has a POWER ON light. The light will glow when its control knob is on.

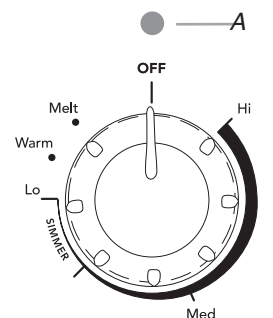

A. Power On Indicator Light

Hot Surface Indicator Light

The hot surface indicator light will glow as long as any surface cooking area is too hot to touch, even after the surface cooking area(s) is turned off.



SETTING	RECOMMENDED USE
SIMMER Switch (on some models)	■ Precise simmer control.
WARM ZONE Element Switch	■ Keep cooked foods warm.

REMEMBER: When range is in use or (on some models) during the Self-Cleaning cycle, the entire cooktop area may become hot.

Cooktop Controls for Standard Knob Control System

⚠ WARNING



Fire Hazard

Turn off all controls when done cooking.
Failure to do so can result in death or fire.

The cooktop controls can be set anywhere between HI and LO.

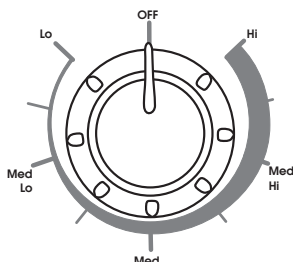

Push in and turn to the desired heat setting. Use the following chart as a guide when setting heat levels.

SETTING	RECOMMENDED USE
HI	■ Bring liquid to a boil.
MED- HI	■ Hold a rapid boil. ■ Quickly brown or sear food.
MED	■ Maintain a slow boil. ■ Fry poultry or meat. ■ Cook pudding, sauce, icing or gravy.
MED- LO	■ Stew or steam food. ■ Simmer.
LO	■ Keep food warm. ■ Melt chocolate or butter.

Single and Dual-Size Elements



A. Single size

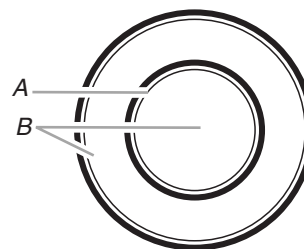

A. Single size
B. Dual size

The Dual-Size Elements offer flexibility depending on the size of the cookware. Single size can be used in the same way as a regular element. The dual size combines both the single and outer element and is recommended for larger size cookware, large quantities of food and home canning.

To Use SINGLE:

1. Push in and turn knob counterclockwise from the OFF position to the SINGLE zone anywhere between LO and HI.
2. Turn knob to OFF when finished.

To Use DUAL:

1. Push in and turn knob clockwise from the OFF position to the DUAL zone anywhere between LO and HI.
2. Turn knob to OFF when finished.

Simmer

The Simmer feature is an adjustable heat setting for more precise simmering. It is the right front (and left rear on some models) surface cooking areas or elements. When the Simmer feature is not on, the right front surface cooking areas or elements will function as usual.

When this feature is on, the wattage to the burner is significantly reduced. It provides a wide range of temperatures for simmering. Choose from the higher levels for stocks and water-based foods or the lower levels for sauces, puddings and gravies.

To Use:

1. Set SIMMER switch to ON (press left).
2. Select desired temperate setting from LO to HI.
3. Set SIMMER switch to OFF (press right) when finished.

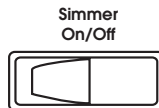

Warm Zone Element

⚠ WARNING

Food Poisoning Hazard

Do not let food sit for more than one hour before or after cooking.

Doing so can result in food poisoning or sickness.

Use the Warm Zone Element to keep cooked foods warm. One hour is the recommended maximum time to maintain food quality.

Do not use it to heat cold foods.

The Warm Zone Element can be used alone or when any of the other surface cooking areas are being used. The Warm Zone Element area will not glow red when cycling on. However, its indicator light will glow as long as the Warm Zone Element area is too hot to touch.

- Use only cookware and dishes recommended for oven and cooktop use.
- Cover all foods with a lid or aluminum foil. When warming baked goods, allow a small opening in the cover for moisture to escape.
- Do not use plastic wrap to cover food. Plastic wrap may melt.
- Use pot holders or oven mitts to remove food.

To Use:

1. Set switch to ON (press left). The switch lights up when the Warm Zone Element is on.
2. Set switch to OFF (press right) when finished.

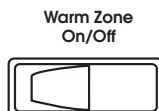

POWER ON Lights

Each control knob has a POWER ON light. The light will glow when its control knob is on.

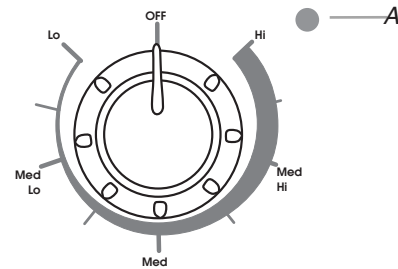

A. Power On Indicator Light

Hot Surface Indicator Light

The hot surface indicator light will glow as long as any surface cooking area is too hot to touch, even after the surface cooking area(s) is turned off.

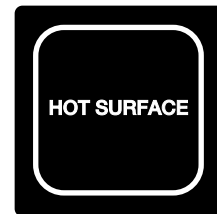

ELECTRONIC OVEN CONTROL

Style 1 (Electronic Touch Activated and Electronic Knob Control Systems)

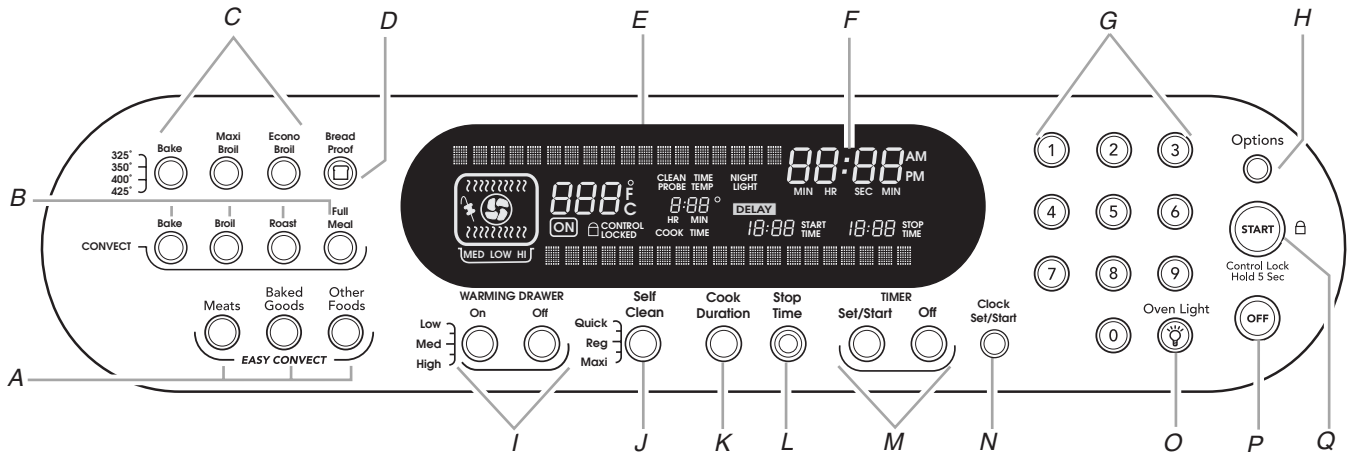

- A. EASYCONVECT™ Conversion
- B. Convection Oven Settings
- C. Oven Settings
- D. Proof Bread Setting
- E. Oven Display
- F. Clock/Time of Day Display

- G. Number Pads
- H. Options Selection Pad
- I. Warming Drawer
- J. Self-Clean
- K. Cook Time (length of cooking time)
- L. Stop Time

- M. Timer
- N. Clock Set/Start
- O. Oven Light ON/OFF
- P. Off
- Q. Start (Control Lock)

Style 2 (Standard Knob Controls System)

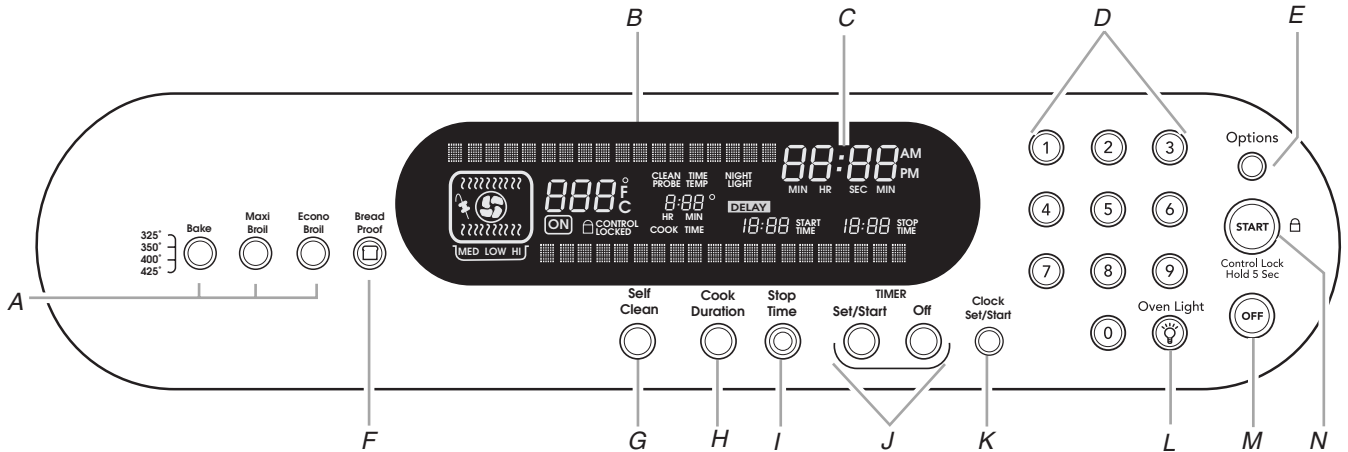

- A. Oven Settings
- B. Oven Display
- C. Clock/Time of Day Display
- D. Number Pads

- E. Options Selection Pad
- F. Proof Bread Setting
- G. Self-Clean
- H. Cook Time (length of cooking time)
- I. Stop Time

- J. Timer
- K. Clock Set/Start
- L. Oven Light ON/OFF
- M. Off
- N. Start (Control Lock)

Electronic Control Pads

When pressing any control pad function on the Electronic Oven Control, use the pad of your finger to press the desired function. Hold down the pad a few seconds, or until the desired function appears in the display.

When entering multiple functions within one setting, pause briefly between each control pad command. If a command pad is pressed several times repeatedly, the pad may briefly stop working. Wait a few seconds, and the pad should function again as normal.

Oven Displays

When the oven is in use, this display shows the oven temperature, heat source(s) and start time. During Timed Cooking, this display also shows a timed countdown and the stop time (if entered).

If "Err" appears on the display, an invalid pad was pressed. Press OFF and retry your entry. When the oven is not in use, this display is blank.

Start

The START pad begins any oven function except the Timer, Control Lock and Sabbath Mode. If not pressed within 5 seconds after pressing a pad, "START?" will appear on the oven display as a reminder. If not pressed within 5 minutes after pressing a pad, the oven display will return to inactive mode (blank) and the programmed function will be canceled.

Control Lock

The Control Lock shuts down the control panel pads to prevent unintended use of the oven. The Control Lock is preset unlocked, but can be locked.

When the control is locked, only the TIMER SET/START and TIMER OFF pads will function.

To Lock/Unlock Control: Before locking, make sure the oven, the Timer and Timed Cooking are off. Press and hold the START pad for 5 seconds until "CONTROL LOCK" appears on the display. Repeat to unlock and remove "CONTROL LOCK" from the display.

Off

The OFF pad stops any oven function except for the Warming Drawer, Clock, Timer and Control Lock.

Clock/Timer Display

This is a 12-hour clock.

1. Press CLOCK SET/START.
 2. Press number pads to set time of day.
 3. Press CLOCK SET/START
-

OPTIONS

Options Selection Pad

The OPTIONS selection pad allows you to access 10 hidden functions within the Electronic Oven Control. These hidden functions allow you to change the oven temperature between Fahrenheit and Celsius, turn the audible signals and prompts on and off and adjust the oven calibration. The Sabbath Mode is also set using the OPTIONS selection pad.

To Use: Press OPTIONS. The oven display will scroll through the various options, starting at 1 and ending in 0. You can also press the OPTIONS selection pad and number pad to quickly access the desired hidden function.

OPTIONS	HIDDEN FUNCTION
1	Fahrenheit and Celsius conversion
2	Sound On/Off
3	Sound High/Low
4	End Beep On/Off
6	Oven temperature calibration
7	Sabbath Mode

Fahrenheit and Celsius

Press options, then 1 on the keypad for Celsius. Repeat to convert back to Fahrenheit.

Tones

Tones are audible signals, indicating the following:

One beep

- Function has been entered

Three beeps

- Invalid pad press

Timer Completion Tones

Three chimes occur when the timer reaches zero. This can be when using the timer for functions other than cooking.

Cooking Time Completion Tones

Three beeps indicate the end of a cooking cycle. Press OPTIONS, and then 4 to turn ON. Press OPTIONS, and then 4 to turn OFF.

Preheat Completion Tone

One chime indicates a preheat cycle has been completed.

All Tones

All tones are preset ON, but can be turned OFF. To turn tones ON, press the options key, then press keypad 2. To turn tones OFF, press the options key again, and then press keypad 2.

Tone Volume

The volume is preset at high, but can be changed to low.

To Change: Press OPTIONS, and then 3 to lower the volume. Press options 3 to raise the volume of the tones.

Oven Temperature Control

IMPORTANT: Do not use a thermometer to measure oven temperature because opening the oven door during cycling may give incorrect readings.

The oven provides accurate temperatures; however, it may cook faster or slower than your previous oven, so the temperature calibration can be adjusted. It can be changed in Fahrenheit or Celsius.

A minus sign means the oven will be cooler by the displayed amount. The absence of a sign means the oven will be warmer by the displayed amount. Use the following chart as a guide.

ADJUSTMENT °F (AUTOMATIC °C CHANGE)	COOKS FOOD
10°F (5°C)	...a little more
20°F (10°C)	...moderately more
35°F (15°C)	...much more
-10°F (-5°C)	...a little less
-20°F (-10°C)	...moderately less
-35°F (-15°C)	...much less

To Adjust Oven Temperature Calibration:

1. Press OPTIONS, and then 6 to set the calibration.
2. Press 3 to increase the temperature, or press 6 to decrease the temperature.
3. Press START to end calibration.

Timer

The Timer can be set in minutes and seconds or hours and minutes and counts down the set time.

NOTE: The Timer does not start or stop the oven.

1. Press TIMER SET/START.
Press again to switch from MIN/SEC and HR/MIN.
If no action is taken after 4 minutes, the display will return to the time of day mode.
 2. Press the number pads to set length of time.
 3. Press TIMER SET/START to start the timer.
If not pressed within 4 minutes, the display will return to the time of day mode and the programmed function will be canceled.
When the set time ends, timer completion tones will sound, then reminder tones will sound every minute.
 4. Press TIMER OFF anytime to cancel the Timer and/or stop reminder tones.
Remember, if OFF is pressed, the oven will turn off.
 5. The time can be reset during the countdown by repeating the above steps.
-

OVEN USE

Odors and smoke are normal when the oven is used the first few times, or when it is heavily soiled.

IMPORTANT: The health of some birds is extremely sensitive to the fumes given off. Exposure to the fumes may result in death to certain birds. Always move birds to another closed and well ventilated room.

NOTE: This oven automatically adjusts for 208V operation without affecting cooking performance. Preheat times may be longer.

Aluminum Foil

IMPORTANT: Do not line the oven bottom with any type of foil, liners or cookware because permanent damage will occur to the oven bottom finish.

- Do not cover entire rack with foil because air must be able to move freely for best cooking results.
- To catch spills, place foil on rack below dish. Make sure foil is at least 1" (2.5 cm) larger than the dish and that it is turned up at the edges.

Bakeware

The bakeware material affects cooking results. Follow manufacturer's recommendations and use the bakeware size recommended in the recipe. Use the following chart as a guide.

BAKEWARE/ RESULTS	RECOMMENDATIONS
Light colored aluminum <ul style="list-style-type: none">■ Light golden crusts■ Even browning	<ul style="list-style-type: none">■ Use temperature and time recommended in recipe.
Dark aluminum and other bakeware with dark, dull and/or nonstick finish <ul style="list-style-type: none">■ Brown, crisp crusts	<ul style="list-style-type: none">■ May need to reduce baking temperatures 25°F (15°C).■ Use suggested baking time.■ For pies, breads and casseroles, use temperature recommended in recipe.■ Place rack in center of oven.
Insulated cookie sheets or baking pans <ul style="list-style-type: none">■ Little or no bottom browning	<ul style="list-style-type: none">■ Place in the bottom third of oven.■ May need to increase baking time.
Stainless steel <ul style="list-style-type: none">■ Light, golden crusts■ Uneven browning	<ul style="list-style-type: none">■ May need to increase baking time.
Stoneware <ul style="list-style-type: none">■ Crisp crusts	<ul style="list-style-type: none">■ Follow manufacturer's instructions.
Ovenproof glassware, ceramic glass or ceramic <ul style="list-style-type: none">■ Brown, crisp crusts	<ul style="list-style-type: none">■ May need to reduce baking temperatures 25°F (15°C).

Meat Thermometer

On models without a temperature probe, always rely on a meat thermometer to determine doneness of meat and poultry. The internal temperature, not appearance, is what counts. A meat thermometer is not supplied with this appliance.

- Insert the thermometer into the center of the thickest portion of the meat or inner thigh or breast of poultry. The tip of the thermometer should not touch fat, bone or gristle.
- After reading the thermometer once, push it into the meat ½" (1.25 cm) more and read again. If the temperature drops, cook the meat or poultry longer.
- Check all meat in 2 or 3 places.

Temperature Probe (on some models)

⚠ WARNING

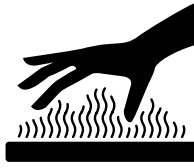

Burn Hazard

Use an oven mitt to remove temperature probe.

Do not touch broil element.

Failure to follow these instructions can result in burns.

The temperature probe accurately measures the internal temperature of meat, poultry and casseroles with liquid and should be used in determining the doneness of meat and poultry. It should not be used during maxi and econo broiling, convection broiling or proofing bread.

Always unplug and remove the temperature probe from the oven when removing food.

To Use:

Before using, insert the probe into the center of the thickest portion of meat or into the inner thigh or breast of poultry, away from fat or bone. Place food in oven and connect the temperature probe to the jack. Keep probe as far away from heat source as possible. Close oven door.

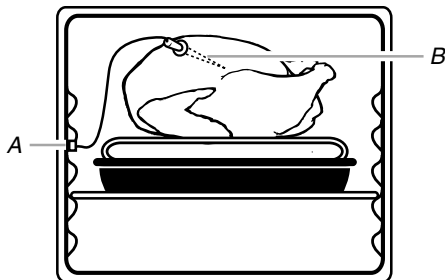

A. Temperature probe jack
B. Temperature probe

1. Press the number pads to enter a probe temperature other than 160°F (71°C). The probe temperature can be adjusted between 130°F and 190°F (54°C and 88°C).
2. Press BAKE, CONVECTION BAKE or CONVECTION ROAST. Press number pads to enter a temperature other than the one displayed.

3. Press START.

The set oven temperature will appear on the oven display throughout cooking.

“Lo°” will appear as the probe temperature until the internal temperature of the food reaches 130°F (54°C). Then the display will show the temperature increasing in 5°F increments.

When the set probe temperature is reached, the oven will shut off automatically and “End” will appear on the oven display.

If enabled, end-of-cycle tones will sound, then reminder tones will sound every minute.

4. Press OFF.

To Change Probe Temperature, Oven Setting:

Repeat previous steps.

If OFF is pressed anytime when changing the probe temperature, the set function will automatically be canceled and the use of the temperature probe function will need to be reset.

To reset after OFF has been pressed, unplug the probe from the probe jack and plug back in. Close the oven door and repeat previous steps.

After cooking, unplug the probe and remove food from oven. The probe symbol will remain lit until the probe is unplugged from the probe jack.

See “General Cleaning” section to clean probe.

Oven Vent

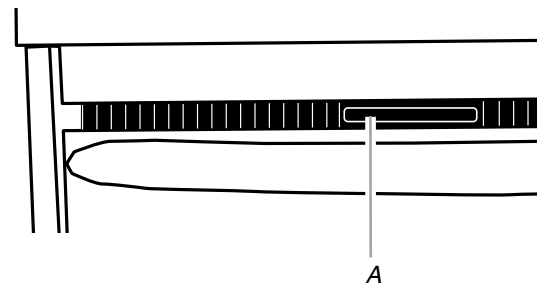

A. Oven vent

The oven vent should not be blocked or covered since it allows the release of hot air and moisture from the oven. Doing so will cause poor air circulation, affecting cooking and cleaning results. Do not set plastics, paper or other items that could melt or burn near the oven vent.

Positioning Racks and Bakeware

IMPORTANT: Do not place food or bakeware directly on the oven door or bottom. Permanent damage will occur to the porcelain finish.

RACKS

NOTES:

- Position racks before turning the oven on.
- Do not position racks with bakeware on them.
- Make sure racks are level.

To move a rack, pull it out to the stop position, raise the front edge, then lift out. Use the following illustration and charts as a guide.

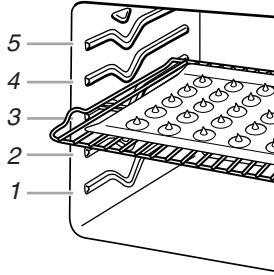

Traditional Cooking

FOOD	RACK POSITION
Frozen pies, large roasts, turkeys, angel food cakes	1 or 2
Bundt cakes, most quick breads, yeast breads, casseroles, meats	2
Cookies, biscuits, muffins, cakes, nonfrozen pies	2 or 3

*On models with the CleanBake™ feature, foods may be placed on a lower rack position.

Convection Cooking

OVEN SETTING	NUMBER OF RACKS USED	RACK POSITION(S)
Convection Bake	1	1, 2 or 3
Convection Bake	2	2 and 4
Convection Bake	3	1, 3 and 5
Convection Roast	1	1, 2 or 3
Convection Broil	1	3 or 4

BAKEWARE

To cook food evenly, hot air must be able to circulate. Allow 1" (2.5 cm) of space around bakeware and oven walls. Use the following chart as a guide.

NUMBER OF PAN(S)	POSITION ON RACK
1	Center of rack.
2	Side by side or slightly staggered.
3 or 4	Opposite corners on each rack. Make sure that no bakeware piece is directly over another.

Oven Half-Rack with Removable Insert (on some models)

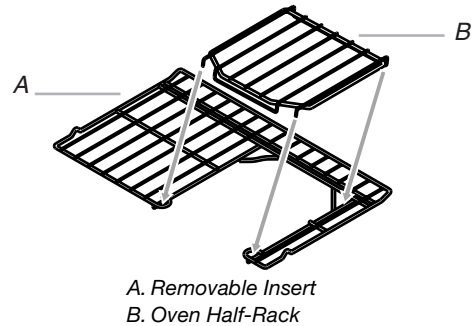

The Oven Half-Rack with Removable Insert maximizes space. When the 2 racks are attached, they make a full rack. The insert can also be removed to provide room for large items such as a turkey or casseroles.

The insert can also be used on the counter for a cooling rack. Do not place more than 25 lbs (11.3 kg) on the oven oven half-rack or on the removable insert piece.

Before Self-Cleaning, remove the Oven Half-Rack with Removable Insert to keep it shiny and easy to slide. See the "General Cleaning" section in the Use and Care Guide for more information.

To Use Oven Oven Half-Rack with Removable Insert:

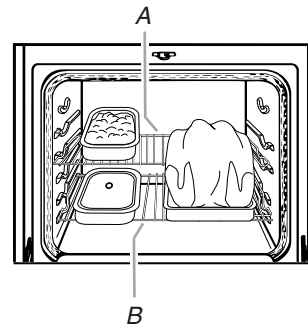

A. Oven Half-Rack (Removable Insert not shown)
B. Full Oven Rack

1. Place a full rack on position 1 or 2, and the half rack on position 3 or 4.
2. Place large items on the right-hand side of the full rack.
3. Place deeper, covered dishes on the left side of the full rack.
4. Place shallow dishes on the half rack.
5. When finished cooking, carefully remove items.

Bake

The BAKE function is ideal for baking, roasting or heating casseroles.

During baking or roasting, the bake and broil elements will cycle on and off in intervals to maintain oven temperature.

If the oven door is opened during baking or roasting, the broil element will turn off immediately and the bake element will turn off in 30 seconds to 2 minutes. They will come back on once the door is closed.

To Bake or Roast:

Before baking and roasting, position racks according to the "Positioning Racks and Bakeware" section. When roasting, it is not necessary to wait for the oven to preheat before putting food in, unless recommended in the recipe.

1. Press BAKE once for 325°F (163°C), or press the number pads to enter a temperature. Each subsequent press of BAKE will increase the temperature by 25 degrees.

2. Press START.

"Lo" will appear on the display if the actual oven temperature is under 170°F (77°C).

"Preheating" will show on the oven display after a temperature of 170°F (77°C) has been reached. The temperature will be shown on the display until reaching the set point.

When the set temperature is reached, if on, 1 tone will sound.

3. Press OFF when finished cooking.

Broil

(Maxi/Econo on some models)

- Use only the broiler pan and grid provided with the range. It is designed to drain juices and help prevent spatter and smoke.
- For proper draining, do not cover the grid with foil. The bottom of the pan may be lined with aluminum foil for easier cleaning.
- Trim excess fat to reduce spattering. Slit the remaining fat on the edges to prevent curling.
- Pull out oven rack to stop position before turning or removing food. Use tongs to turn food to avoid the loss of juices. Very thin cuts of fish, poultry or meat may not need to be turned.
- After broiling, remove the pan from the oven when removing the food. Drippings will bake on the pan if left in the heated oven, making cleaning more difficult.
- If the oven door is opened during broiling, the broil element will turn off immediately and come back on once the door is closed.

Broiling uses direct radiant heat to cook food. Use MAXI/ECONO (on some models) for broiling regular-sized and smaller cuts of meat, poultry and fish. Broil MAXI uses both top elements for maximum browning coverage of foods. Broil ECONO uses the inner element for browning coverage of a smaller area.

Before broiling, position rack according to Broiling Chart. It is not necessary to preheat the oven before putting food in unless recommended in the recipe. Position food on grid in the broiler pan, then place it in the center of the oven rack. Close the door to ensure proper broiling operation.

To Broil:

1. Press one of the two broil functions.

Choose Maxi Broil when broiling larger amounts of food with both broil elements. Choose Econo Broil when broiling smaller amounts of food with only the inner broil element.

2. Press START.

3. Press OFF when finished.

Variable Temperature Broiling

Changing the temperature when Variable Temperature Broiling allows more precise control when cooking. The lower the temperature, the slower the cooking. Thicker cuts and unevenly shaped pieces of meat, fish and poultry may cook better at lower broiling temperatures.

To Use:

1. Press one of the two broil functions.

2. Press the number pads to set a temperature between 300°F and 500°F (149°C to 260°C).

3. Press START.

The temperature can be changed after this step by entering a new temperature using the number pads and pressing START. If START is not pressed within 5 seconds "START?" will appear on the display. If START is not pressed within 10 seconds, the temperature will return to the previous temperature entered.

4. Press OFF when finished.

BROILING CHART

For best results, place food 3" (7 cm) or more from the broil element. Times are guidelines only and may need to be adjusted for individual tastes. Recommended rack positions are numbered from the bottom (1) to the top (5). For diagram, see the "Positioning Racks and Bakeware" section.

FOOD	RACK POSITION	SETTING	TOTAL TIME MIN. (APPROX.)
Steak 1" (2.5 cm) thick			
medium rare	4	500°F	14
medium	4	(260°C)	16
well-done	4		18
Steak 1½" (3.8 cm) thick			
rare	4	500°F	23
medium	4	(260°C)	28
Ground meat patties* 1" (2.5 cm) thick	4	500°F	16-18
well-done		(260°C)	
Pork chops 1" (2.5 cm) thick	4	450°F	25-28
		(232°C)	
Ham slice [precooked] ½" (1.25 cm) thick	4	500°F	10-12
1" (2.5 cm) thick	4	(260°C)	20-22
Frankfurters	4	500°F	8
		(260°C)	
Lamb chops 1" (2.5 cm) thick	4	400°F	18-20
		(204°C)	
Chicken bone-in pieces	3	500°F	32
		(260°C)	
Fish ½" (1.25 cm) thick	3	350°F	20
1" (2.5 cm) thick	3	(177°C)	20-22

*Place up to 12 patties, equally spaced, on broiler grid.

Convection Cooking (on some models)

In a convection oven, the fan-circulated hot air continually distributes heat more evenly than the natural movement of air in a standard thermal oven. This movement of hot air maintains a consistent temperature throughout the oven, cooking foods more evenly, crisping surfaces while sealing in moisture and yielding crustier breads.

Most foods can be cooked by lowering cooking temperatures 25°F to 50°F (14°C to 28°C) and cooking time can be shortened by as much as 30 percent, especially for large turkeys and roasts.

- It is important not to cover foods so that surface areas remain exposed to the circulating air, allowing browning and crisping.
- Keep heat loss to a minimum by only opening the oven door when necessary.
- Choose cookie sheets without sides and roasting pans with lower sides to allow air to move freely around the food.
- Test baked goods for doneness a few minutes before the minimum cooking time with an alternative method such as a toothpick.
- Use a meat thermometer or the temperature probe to determine the doneness of meats and poultry. Check the temperature of pork and poultry in 2 or 3 places.

EASYCONVECT™ Conversion (on some models)

Convection cooking temperatures and times differ from those of standard cooking. Depending upon the selected category, EASYCONVECT conversion automatically may reduce the standard recipe temperature and/or time you input for convection cooking.

Foods are grouped into 3 general categories. Choose the category most appropriate for the food to be cooked. To ensure optimal cooking results, the oven will prompt a food check at the end of a non-delayed cook time. Use the following chart as a guide.

SETTING	FOODS
BAKED GOODS	Biscuits, Breads: quick and yeast Cakes: layer and angel food Casseroles: including frozen entrées and soufflés, cookies, fish
MEATS	Baked potatoes, Chicken: whole and pieces Meat loaf, Roasts: pork, beef and ham (Turkey and large poultry are not included because their cook time varies.)
OTHER FOODS	Convenience foods: french fries, nuggets, fish sticks, pizza Pies: fruit and custard

To Use:

Before using convection temperature conversion for BAKED GOODS and OTHER FOODS, allow the oven to preheat before placing food in the oven.

1. Press BAKED GOODS, MEATS or OTHER FOODS.
2. Press number pads to enter standard cook temperature.
3. Press number pads to enter standard cook time.
4. Press START.
“CHECK FOOD AT” and the stop time will appear on the oven display.
When the stop time is reached, end-of-cycle tones will sound if enabled. Open the door and check food.
5. Press OFF to cancel the reminder tones.

Convection Bake (on some models)

Convection baking can be used for baking delicate cakes and pastries, as well as foods on multiple racks. It is helpful to stagger items on the racks to allow a more even flow of heat. If the oven is full, extra cooking time may be needed.

When cooking an oven meal with several different types of foods, be sure to select recipes that require similar temperatures. Cookware should sit in the oven with at least 1" (2.5 cm) of space between the cookware and the sides of the oven.

During convection baking preheat, the broil elements and the bake element all heat the oven cavity. After preheat, the convection element will cycle on and off in intervals to maintain oven temperature, while the fan constantly circulates the hot air.

If the oven door is opened during convection baking or preheating, the convection element and fan will turn off immediately. They will come back on once the door is closed.

- Reduce recipe temperature 25°F (14°C). The cook time may need to be reduced also.

To Convection Bake:

Before convection baking, position racks according to the “Positioning Racks and Bakeware” section.

1. Press CONVECT BAKE.
Press the number pads to enter a temperature other than 325°F (163°C). The convection bake range can be set between 170°F and 500°F (77°C and 260°C).
2. Press START.
“Lo°” will appear on the oven display if the actual oven temperature is under 170°F (77°C).
When the actual oven temperature reaches 170°F (77°C), the oven display will show the oven temperature increasing in 1-degree increments.
When the set temperature is reached, if on, one preheat completion tone will sound if tones are turned on.
3. Press OFF when finished cooking.

Convection Roast

(on some models)

Convection roasting can be used for roasting meats and poultry, or for baking yeast breads and loaf cakes using a single rack. During convection roasting, the bake and broil elements will cycle on and off in intervals to maintain oven temperature, while the fan constantly circulates the hot air.

If the oven door is opened during convection roasting, the broil element and convection fan will turn off immediately and the bake element will turn off within 2 minutes. They will come back on once the door is closed.

- Reduce recipe temperature 25°F (14°C). The cook time may need to be reduced also.

To Convection Roast:

Before convection roasting, position racks according to the "Positioning Racks and Bakeware" section. It is not necessary to wait for the oven to preheat before putting food in, unless recommended in the recipe.

Use the roasting rack on top of the broiler pan and grid. This holds the food above the grid and allows air to circulate completely around all surfaces.

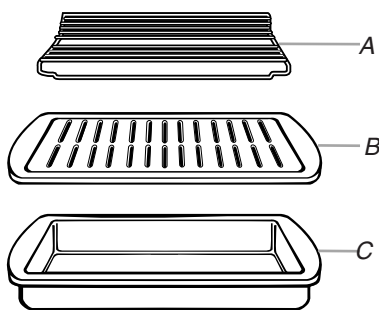

A. Roasting rack
B. Broiler grid
C. Broil pan

1. Press CONVECT ROAST.

Press the number pads to enter a temperature other than 300°F (149°C). The convection roast range can be set between 170°F and 500°F (77°C and 260°C).

2. Press START.

"Lo" will appear on the oven display if the actual oven temperature is under 170°F (77°C).

When the actual oven temperature reaches 170°F (77°C), the oven display will show the oven temperature increasing in 1-degree increments.

When the set temperature is reached, one preheat completion tone will sound if tones are turned on.

3. Press OFF when finished cooking.

CONVECTION ROASTING CHART

Food/Rack Position	Cook Time (min. per 1 lb [454 g])	Oven Temp.	Internal Food Temp.
Beef, Rack Position 2			
Rib Roast			
rare	20-25	300°F (149°C)	140°F (60°C)
medium	25-30		160°F (71°C)
well-done	30-35		170°F (77°C)
Rib Roast (boneless)			
rare	22-25	300°F (149°C)	140°F (60°C)
medium	27-30		160°F (71°C)
well-done	32-35		170°F (77°C)
Rump, Sirloin Tip Roast			
rare	20-25	300°F (149°C)	140°F (60°C)
medium	25-30		160°F (71°C)
well-done	30-35		170°F (77°C)
Meat Loaf	20-25	325°F (163°C)	165°F (74°C)
Veal, Rack Position 2			
Loin, Rib, Rump Roast			
medium	25-35	325°F (163°C)	160°F (71°C)
well-done	30-40		170°F (77°C)
Pork, Rack Position 2			
Loin Roast (boneless)			
	30-40	325°F (163°C)	160°F-170°F (71°C-77°C)
Shoulder Roast			
	35-40	325°F (163°C)	160°F-170°F (71°C-77°C)
Ham, Rack Position 2			
Fresh (uncooked)			
	25-35	300°F (149°C)	160°F (71°C)
Fully Cooked			
	15-20	300°F (149°C)	160°F (71°C)
Lamb, Rack Position 2			
Leg, Shoulder Roast			
medium	25-30	300°F (149°C)	160°F (71°C)
well-done	30-35		170°F (77°C)
Chicken*, Rack Position 2			
Whole			
3-5 lbs (1.5-2.2 kg)	20-25	325°F (163°C)	180°F (82°C)
5-7 lbs (2.2-3.1 kg)	15-20	325°F (163°C)	180°F (82°C)
Turkey*, Rack Positions 1 or 2			
13 lbs and under (5.85 kg)	10-15	300°F (149°C)	180°F (82°C)
Over 13 lbs (5.85 kg)	10-12	300°F (149°C)	180°F (82°C)
Cornish Game Hens*, Rack Position 2 or 3			
1-1.5 lbs (0.5-0.7 kg)	50-60	325°F (163°C)	180°F (82°C)

*Do not stuff poultry when convection roasting.

Convection Broil

(on some models)

During convection broiling, the broil elements will cycle on and off in intervals to maintain oven temperature, while the fan constantly circulates the hot air.

The temperature is preset at 500°F (260°C), but can be changed to a different temperature. Cooking times will vary depending on the rack position and temperature and may need to be adjusted.

If the oven door is opened during convection broiling, the broil elements and fan will turn off after 30 seconds. They will come back on once the door is closed.

To Convection Broil:

Before convection broiling, see "Broil" section for general broiling guidelines. Position rack.

Allow the oven to preheat for 5 minutes. Position food on the unheated grid on the broiler pan, then place it in the center of the oven rack with the longest side parallel to the door.

Close the door.

1. Press CONVECT BROIL.

Press the number pads to enter a temperature other than 500°F (260°C). The convection broil range can be set between 300°F and 500°F (149°C and 260°C).

2. Press START.

The set oven temperature will appear on the oven display until oven is turned off.

3. Press OFF when finished cooking.

Convect Full Meal

(on some models)

Convect Full Meal allows you to cook different foods for the same cook time if they require similar temperatures. Convect Full Meal lets you choose from 10 preset cooking cycles. A single pad includes an oven setting, an oven temperature, and a cook time or probe temperature. One pad is changeable to allow you to set your own cycle and save it for future use. Use the following chart as a guide.

- All food should be at refrigerator or room temperature before placing in the oven. These settings and times are not for frozen foods.
- Always check for doneness of meats and poultry with a meat thermometer. Test other foods for doneness by checking color and texture.

PAD/ OVEN SETTING	OVEN TEMP.	COOK TIME or PROBE TEMP.	FOOD or MEAL
1 Convection Bake	325°F (163°C)	1 hr.	Meat Loaf, Baked Potatoes, Pineapple Upside Down Cake
2 Convection Roast	325°F (163°C)	1 hr. 30 min.	Turkey Breast, Stuffing Casserole, Peach Crisp
3 Convection Roast	350°F (177°C)	40 min.	Stuffed Pork Chops, Baked Winter Squash, Bread Pudding
4 Convection Bake	375°F (191°C)	45 min.	Oven Fried Chicken Pieces, Scalloped Potatoes, Cherry Pie

PAD/ OVEN SETTING	OVEN TEMP.	COOK TIME or PROBE TEMP.	FOOD or MEAL
5 Convection Bake	425°F (218°C)	20 min.	Baked Salmon Steaks, Roasted Vegetable Wedges, Biscuits
6 Convection Roast	325°F (163°C)	140°F (60°C)	Beef, rare
7 Convection Roast	325°F (163°C)	155°F (68°C)	Beef, medium or Pork
8 Convection Roast	325°F (163°C)	165°F (74°C)	Beef, well-done
9 Convection Roast	300°F (149°C)	135°F (56°C)	Pot Roast (3 lbs [1.4 kg]) with vegetables
0 Convection Bake	325°F (163°C)	160°F (71°C)	Casseroles

To Use:

Before using Convect Full Meal, place food in oven. If temperature probe is required, insert probe into food and plug probe into jack. See "Temperature Probe" section for diagram.

1. Press CONVECT FULL MEAL.

2. Press number to select oven setting from chart.

For example, number pads 1 to 0 or scroll through CONVECT FULL MEAL.

3. Press START.

The start time, stop time and cooktime will appear on the oven display.

When the cycle ends, end-of-cycle tones will sound, then reminder tones will sound every minute if tones are turned on.

4. Press OFF or open the oven door when finished cooking to clear the display.

To Set Cycle:

Before setting a cycle, start with the meat or main dish temperature and cook time. Choose baked goods with an oven temperature similar to those of the meat or main dish. Temperatures ranging from plus or minus 25°F to 50°F (14°C to 28°C) and cook times ranging from plus or minus 10 to 15 minutes are acceptable. Choose vegetables and fruits last.

1. Press CONVECT FULL MEAL.

2. Press any oven setting pad, for example BAKE.

3. Press number pads to enter oven temperature.

4. Press COOK DURATION.

5. Press number pads to enter length of time to cook in hours and minutes

or

Press 0 to do untimed cooking.

6. Press CONVECT FULL MEAL to save

or

Press START to save and immediately begin cycle.

Sabbath Mode

The Sabbath Mode sets the oven to remain on in a bake setting until turned off. A timed Sabbath Mode can also be set to keep the oven on for only part of the Sabbath.

When the Sabbath Mode is set, only the number and start pads will function, no tones will sound, and the displays will not show messages or temperature changes. The heat sources icons will appear lit on the oven display throughout the Sabbath Mode.

When the oven door is opened or closed, the oven light will not turn on or off and the heating elements will not turn on or off immediately.

If a power failure occurs when the Sabbath Mode is set, the oven will remain Sabbath Mode compliant but will no longer be actively cooking. The "ON" indicator will no longer be illuminated. Press OFF to return to normal operating mode (non-Sabbath Mode compliant, not cooking).

To Activate:

IMPORTANT: Before the Sabbath Mode can be regularly set, the oven must first be enabled with a one time only setup.

1. Open the oven door.
2. Press OFF.
3. Press the number pads 7, 8, 9, 6, in this order.
4. Press START to activate.
"SABBATH ENABLED" will appear on the display.
5. Press OFF pad to clear the display.

To Deactivate:

The oven can be disabled of the ability to set the Sabbath Mode by repeating the previous steps. See "To Activate" section. When disabled the Sabbath Mode cannot be regularly set until re-enabled.

To Regularly Set, Untimed:

1. Press BAKE.
Press the number pads to enter a temperature other than 325°F (163°C). The bake range can be set between 170°F and 500°F (77°C and 260°C).
2. Press START. The oven will begin a bake cycle.
3. Press OPTIONS, and then press number pad 7.
4. "SABBATH MODE" will appear on the oven display.

To Regularly Set, Timed:

⚠ WARNING

Food Poisoning Hazard

Do not let food sit in oven more than one hour before or after cooking.

Doing so can result in food poisoning or sickness.

1. Press BAKE.
Press the number pads to enter a temperature other than 325°F (163°C). The bake range can be set between 170°F and 500°F (77°C and 260°C).
2. Press COOK DURATION.
3. Press the number pads to enter the length of Sabbath Mode time, up to 9 hours 59 minutes.
4. Press START. The oven will begin a timed bake cycle.
The start time and stop time will appear on the display.

5. Press OPTIONS, and then press number pad 7. "SABBATH MODE" will appear on the display.
6. When the stop time is reached, the oven will automatically turn off. The oven control will remain Sabbath Mode compliant until the OFF button is pressed.

Temperature Change

The oven temperature can be changed when the oven(s) are in the Sabbath Mode. No tones will sound, and the display will not change. The heating elements will not turn on or off for a random time, anywhere from 16 to 24 seconds. It may take up to ½ hour for the oven to change temperature.

Number pads 1 through 0 represent temperatures. Use the following chart as a guide.

NUMBER PAD	OVEN TEMPERATURE
1	170°F (77°C)
2	200°F (95°C)
3	225°F (107°C)
4	250°F (120°C)
5	300°F (149°C)
6	325°F (163°C)
7	350°F (177°C)
8	375°F (191°C)
9	400°F (204°C)
0	450°F (232°C)

To Change Temperature:

1. Press the number pad from the chart.
2. Press START.

Warming Drawer Operation During Sabbath Mode

The warming drawer may be set for use during Sabbath Mode. This is accomplished by pressing the WARMING DRAWER ON key (continue pressing until desired temperature level is displayed) before the oven is placed into its Sabbath Mode compliant state. See "To Regularly Set, Untimed" section for instructions on placing the oven into its Sabbath Mode compliant state. Once the oven is in its Sabbath Mode compliant state, the warming drawer cannot be turned on or off and its temperature cannot be changed until the oven is returned to its normal operating state (non-Sabbath Mode compliant state, not cooking) by pressing the OFF key.

Proofing Bread (on some models)

Proofing bread prepares the dough for baking by activating the yeast. Follow the recipe directions as a guide.

To Proof:

- Before first proofing, place the dough in a lightly greased bowl and cover loosely with wax paper, coated with shortening. Place on rack guide 2, then place broiler pan on guide 1. See "Positioning Racks and Bakeware" for diagram. Put 2 cups (500 mL) of boiling water in the broiler pan. Close the door.
1. Press BREAD PROOF.
The display will show 100°F (38°C).

2. Press START.

Let the dough rise until nearly doubled in size, checking after 20-25 minutes. Proofing time may vary depending on dough type and quantity.

3. Press OFF when finished proofing.

Before second proofing, shape the dough, place it in baking pan(s) and cover loosely with plastic wrap, coated with cooking spray. Follow the same placement, broiler pan and water and control steps above. Before baking, remove the plastic wrap.

Timed Cooking

⚠ WARNING

Food Poisoning Hazard

Do not let food sit in oven more than one hour before or after cooking.

Doing so can result in food poisoning or sickness.

Timed Cooking allows the oven to be set to turn on at a certain time of day, cook for a set length of time, and/or shut off automatically. Delay start should not be used for food such as breads and cakes because they may not bake properly.

To Set a Cook Time:

1. Press BAKE, CONVECT BAKE or CONVECT ROAST.
Press the number pads to enter a temperature other than the one displayed.
2. Press COOK DURATION.
3. Press number pads to enter the length of time to cook.
4. Press START.

On some models, the start time, stop time and cook time countdown will appear on the oven display.

When the stop time is reached, the oven will shut off automatically, and end-of-cycle tones will sound, then reminder tones will sound every minute.

5. Press OFF to stop reminder tones or open the oven door.

To Set a Cook Time and Stop Time (Delay Start):

Before setting, make sure the clock is set to the correct time of day. See "Clock" section.

1. Press BAKE, CONVECT BAKE or CONVECT ROAST.
Press the number pads to enter a temperature other than the one displayed.
2. Press COOK DURATION.
3. Press number pads to enter the length of time to cook.
4. Press STOP TIME.
5. Press the number pads to enter time of day to stop.
6. Press START.

The start time is automatically calculated and displayed.

"DELAY" and the stop time will also appear on the oven display.

When the start time is reached, the oven will automatically turn on. The cook time countdown will appear on the oven display.

On some models, the set temperature and minute time countdown will appear on the oven display.

When the stop time is reached, the oven will shut off automatically, and end-of-cycle tones will sound, then reminder tones will sound every minute.

7. Press OFF to stop reminder tones or open the oven door.

Warming Drawer (on some models)

⚠ WARNING

Food Poisoning Hazard

Do not let food sit for more than one hour before or after cooking.

Doing so can result in food poisoning or sickness.

The Warming Drawer is ideal for keeping hot cooked foods at serving temperature. It may also be used for warming breads and pastries.

Different types of food may be placed in the warming drawer at the same time. For best results, do not hold foods longer than one hour. For smaller quantities or heat-sensitive foods, such as eggs, do not hold longer than 30 minutes.

Food must be at serving temperature before being placed in the warming drawer. Breads, pastries, and fruit pies may be heated from room temperature on the HI setting.

Remove food from plastic bags and place in oven-safe container. Cover foods with a lid or aluminum foil.

Do not cover with plastic wrap.

Empty serving dishes and ovenproof dishes can be heated while the warming drawer is preheating.

Do not place food to be warmed directly on warming drawer surface.

To Use:

1. Place cooked food(s) in warming drawer.
2. Press WARMING DRAWER.
"WARM-LOW" and "START?" will appear on the display.
Each subsequent press of WARMING DRAWER will increase the temperature setting.
3. Press START.
"DRAWER ON" will appear on the display for 5 seconds.
4. Press WARM DRAWER OFF when finished.

Warming Drawer Settings:

The warming drawer is preset for a "Lo" temperature, but can be changed by pressing WARMING DRAWER additional times. Use the following chart as a guide when selecting a different temperature other than "Low."

SETTINGS	TEMPERATURES
LOW	100°F (38°C)
MED LOW (Medium Low)	140°F (60°C)
MED (Medium)	160°F (71°C)
MED HI (Medium High)	180°F (88°C)
HI (High)	195°F (91°C)

Warming Drawer Temperature Chart

Different foods require different settings in order to maintain the ideal serving temperature. Use the following chart as a guide.

FOOD	SETTING
Appetizers	HI
Biscuits	LOW
Chicken Boneless, Breaded Nuggets	HI HI
Coffee Cake	LOW
Dinner Plate (1) Salisbury Steak, Mashed Potatoes, Corn	HI
Fish Pieces Breaded Battered	HI HI
French Fries	HI
Gravy	MED HI
Ham, Boneless	MED
Hard Rolls	LOW
Lasagna	MED HI
Pastries Prepackaged, baked Prepackaged, frozen	MED HI LOW
Pie Single Crust Double Crust	LOW LOW
Pizza	MED HI
Potatoes, Baked	MED HI
Quiche	MED
Roast, Boneless	MED HI
Roasted Chicken	MED HI
Soft Rolls	LOW

RANGE CARE

Self-Cleaning Cycle (on some models)

WARNING

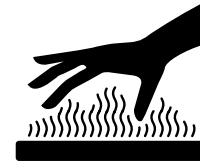

Burn Hazard

Do not touch the oven during the Self-Cleaning cycle.

Keep children away from oven during Self-Cleaning cycle.

Failure to follow these instructions can result in burns.

IMPORTANT: The health of some birds is extremely sensitive to the fumes given off during the Self-Cleaning cycle. Exposure to the fumes may result in death to certain birds. Always move birds to another closed and well ventilated room.

Self-clean the oven before it becomes heavily soiled. Heavy soil results in longer cleaning and more smoke.

Keep the kitchen well-ventilated during the Self-Cleaning cycle to help get rid of heat, odors, and smoke.

Do not block the oven vent(s) during the Self-Cleaning cycle. Air must be able to move freely. Depending on your model, see "Oven Vent" or "Oven Vents" section.

Do not clean, rub, damage or move the oven door gasket. The door gasket is essential for a good seal.

Prepare Oven:

- Remove the broiler pan, grid, cookware and bakeware from the oven.
- Remove any foil from the oven because it may burn or melt, damaging the oven.
- Remove oven racks to keep them shiny and easy to slide. See "General Cleaning" section for more information.
- Hand clean inside door edge and the 1½" (3.8 cm) area around the inside oven cavity frame, being careful not to move or bend the gasket. This area does not get hot enough during self-cleaning to remove soil. Do not let water, cleaner, etc. enter slots on door frame. Use a damp cloth to clean this area.
- Wipe out any loose soil to reduce smoke and avoid damage. At high temperatures, foods react with porcelain. Staining, etching, pitting or faint white spots can result. This will not affect cooking performance.

Prepare Cooktop and Storage Drawer:

- Remove plastic items from the cooktop because they may melt.
- Remove all items from the storage drawer.

How the Cycle Works

IMPORTANT: The heating and cooling of porcelain on steel in the oven may result in discoloring, loss of gloss, hairline cracks and popping sounds.

The Self-Cleaning cycle uses very high temperatures, burning soil to a powdery ash.

The oven is preset for a 2 hour 30 minute clean cycle, however the time can be changed. There are five levels of clean. Suggested clean times are 2 hours 30 minutes for light soil and between 3 hours 30 minutes to 4 hours 30 minutes for average to heavy soil. Use the following chart as a guide to determine the desired cleaning level.

CLEANING LEVEL	TOTAL CLEANING TIME (includes a 30 minute cool down time)
1 (Quick)	2 hours 30 minutes
2	3 hours
3 (Regular)	3 hours 30 minutes
4	4 hours
5 (Maxi)	4 hours 30 minutes

Once the oven has completely cooled, remove ash with a damp cloth. Do not wipe down any of the inside surfaces until the oven has completely cooled down. Applying a cool damp cloth to the inner door glass before it has cooled completely could result in the glass breaking.

The oven light will not work during the Self-Cleaning cycle.

On some Canadian models, the surface elements will not work during the Self-Cleaning cycle.

To Self-Clean:

Before self-cleaning, make sure the door is closed completely or it will not lock and the cycle will not begin.

1. Press SELF CLEAN to set a clean time other than 2 hours 30 minutes. The clean time can be set between 2 hours 30 minutes and 4 hours 30 minutes.
2. Press START.

The oven door will automatically lock and "DOOR LOCKED" or "LOCKED," the start time and stop time will appear on the oven display. On some models, the clean time will appear on the oven display.

The door will not unlock until the oven cools.

When the cycle is complete and the oven cools, "End" will appear on the oven display and "DOOR LOCKED" or "LOCKED" will disappear from the display.

3. Press any pad or open the oven door to clear the oven display.

To Delay Start Self-Clean:

Before delay starting Self-Clean, make sure the clock is set to the correct time of day. See "Clock" section. Also, make sure the door is closed completely or it will not lock and the cycle will not begin.

1. Press SELF CLEAN to set a clean time other than 2 hours 30 minutes. The clean time can be set between 2 hours 30 minutes and 4 hours 30 minutes.
2. Press STOP TIME.
3. Press the number pads to enter the time of day to stop.
4. Press START.

The start time is automatically calculated and displayed. The door will automatically lock, and "DOOR LOCKED" or "LOCKED" and "DELAY" and the stop time will also appear on the display (on some models). The door will not unlock until the oven cools.

When the start time is reached, the oven will automatically turn on.

When the cycle is complete and the oven cools, "End" will appear on the oven display and "DOOR LOCKED" or "LOCKED" will disappear from the display.

5. Press OFF to clear the oven display.

To Stop Self-Clean any time:

Press OFF. If the oven temperature is too high, the door will remain locked. It will not unlock until the oven cools.

If the oven temperature is too high after self-cleaning, then "LOCKED" will appear on the display until the oven completely cools.

General Cleaning

IMPORTANT: Before cleaning, make sure all controls are off and the oven and cooktop are cool. Always follow label instructions on cleaning products. Soap, water and a soft cloth or sponge are suggested first unless otherwise noted.

EXTERIOR PORCELAIN ENAMEL SURFACES (on some models)

Food spills containing acids, such as vinegar and tomato, should be cleaned as soon as the entire appliance is cool. These spills may affect the finish.

- Glass cleaner, mild liquid cleaner or nonabrasive scrubbing pad: Gently clean around the model and serial number plate because scrubbing may remove numbers.

STAINLESS STEEL (on some models)

NOTE: Do not use soap-filled scouring pads, abrasive cleaners, Cooktop Polishing Creme, steel-wool pads, gritty washcloths or some paper towels. Damage may occur, even with one-time or limited use.

Rub in direction of grain to avoid damaging.

- Stainless Steel Cleaner & Polish (sample included): See "Assistance or Service" section to order.
- Liquid detergent or all-purpose cleaner: Rinse with clean water and dry with soft, lint-free cloth.
- Vinegar for hard water spots

CERAMIC GLASS (on some models)

Do not use steel wool, abrasive powder cleansers, chlorine bleach, rust remover or ammonia because damage may occur.

Always wipe with a clean, wet cloth or sponge and dry thoroughly to prevent streaking and staining.

Cooktop Polishing Creme (sample included) is recommended for regular use to help prevent scratches, pitting and abrasions, and to condition the cooktop. It may be ordered as an accessory. See "Assistance or Service" to order.

A Cooktop Scraper is also recommended for stubborn soils, and can be ordered as an accessory. See "Assistance or Service" to order. The Cooktop Scraper uses razor blades. **Store razor blades out of the reach of children.**

Light to moderate soil

- Paper towels or clean damp sponge: Clean while the cooktop is still warm. You may want to wear oven mitts while doing so.

Sugary spills (jellies, candy, syrup)

- Cooktop Scraper: Clean while the cooktop is still warm. You may want to wear oven mitts while doing so.
- Cooktop Polishing Creme and clean damp paper towel: Clean as soon as cooktop has cooled down. Rub creme into surface with a damp paper towel or soft cloth. Continue rubbing until white film disappears.

Heavy soil, dark streaks, specks and discoloration

- Cooktop Polishing Creme or nonabrasive cleanser: Rub product into soil with a damp paper towel or soft cloth. Continue rubbing until white film disappears.

Burned-on soil

- Cooktop Polishing Creme and Cooktop Scraper: Rub creme into soil with damp paper towel. Hold scraper as flat as possible on surface and scrape. Repeat for stubborn spots. Polish entire cooktop with creme and paper towel.

Metal marks from aluminum and copper

- Cooktop Polishing Creme: Clean as soon as cooktop has cooled down. Rub creme into surface with a damp paper towel or soft cloth. Continue rubbing until white film disappears. The marks will not totally disappear but after many cleanings become less noticeable.

Tiny scratches and abrasions

- Cooktop Polishing Creme: Rub creme into surface with a damp paper towel or soft cloth. Continue rubbing until white film disappears. Scratches and abrasions do not affect cooking performance and after many cleanings become less noticeable.

COOKTOP CONTROLS

Do not use steel wool, abrasive cleansers or oven cleaner.

Do not soak knobs.

When replacing knobs, make sure knobs are in the Off position.

On some models, do not remove seals under knobs.

- Soap and water or dishwasher: Pull knobs straight away from control panel to remove.

OVEN DOOR EXTERIOR

- Glass cleaner and paper towels or nonabrasive plastic scrubbing pad: Apply glass cleaner to soft cloth or sponge, not directly on panel.

CONTROL PANEL

Do not use abrasive cleaners, steel-wool pads, gritty washcloths or some paper towels. Damage may occur.

- Glass cleaner and soft cloth or sponge: Apply glass cleaner to soft cloth or sponge, not directly on panel.

OVEN CAVITY

Do not use oven cleaners.

Food spills should be cleaned when oven cools. At high temperatures, foods react with porcelain and staining, etching, pitting or faint white spots can result.

- Self-Cleaning cycle: See "Self-Cleaning Cycle" first.

OVEN RACKS AND ROASTING RACKS

- Self-Cleaning cycle: See "Self-Cleaning Cycle" first. Remove racks or they will discolor and become harder to slide. If this happens, a light coating of vegetable oil applied to the rack guides will help them slide.
- Steel-wool pad

BROILER PAN AND GRID

Do not clean in the Self-Cleaning cycle (on some models).

- Mildly abrasive cleanser: Scrub with wet scouring pad.
- Solution of ½ cup (125 mL) ammonia to 1 gal. (3.75 L) water: Soak for 20 minutes, then scrub with scouring or steel-wool pad.
- Oven cleaner: Follow product label instructions.

Porcelain enamel only, not chrome

- Dishwasher

Oven Light(s)

The oven light(s) is a 15-watt appliance bulb. The light(s) will come on when the oven door is opened. The light(s) will not work during the Self-Cleaning cycle. When the oven door is closed, press OVEN LIGHT to turn the light(s) on or off.

To Replace:

Before replacing, make sure the oven is off and cool.

1. Unplug range or disconnect power.
2. Turn the glass bulb cover in the back of the oven counterclockwise to remove.
3. Turn bulb counterclockwise to remove from socket.
4. Replace bulb and bulb cover by turning clockwise.
5. Plug in range or reconnect power.

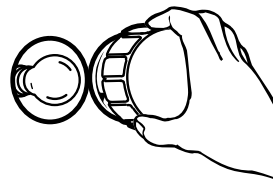

Storage Drawer

The storage drawer can be removed. Before removing, make sure drawer is cool and empty.

To Remove:

1. Pull drawer straight out to the first stop.
2. Lift up the back of the drawer and pull out.

To Replace:

1. Fit the ends of the drawer rails into the guides in the cavity.
 2. Slide the drawer closed.
-

Oven Door

For normal range use, it is not suggested to remove the oven door. However, if removal is necessary, make sure the oven is off and cool. Then, follow these instructions. The oven door is heavy.

To Remove:

1. Open oven door all the way.
2. Flip up the hinge latch on each side.

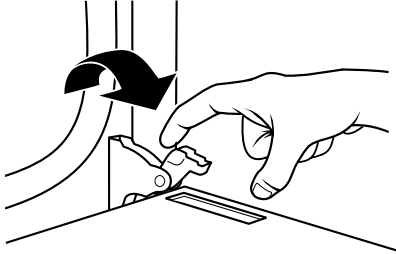

3. Close the oven door as far as it will shut.
4. Lift the oven door while holding both sides.

Continue to push the oven door closed and pull it away from the oven door frame.

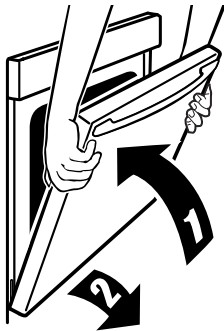

To Replace:

1. Insert both hanger arms into the door.

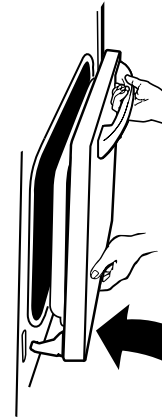

2. Open the oven door.
You should hear a “click” as the door is set into place.
 3. Move the hinge levers back to the locked position. Ensure that the door is free to open and close. If it is not, repeat the removal and installation procedures
-

Warming Drawer

(on some models)

Remove all items from inside the warming drawer, and allow the unit to cool completely before attempting to remove the drawer.

To Remove:

1. Open drawer to its full open position.
2. Locate the black loops on both sides of the drawer.

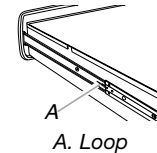

3. Pull both loops forward at the same time, then pull drawer out another inch.

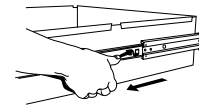

4. Holding the drawer by its sides, not its front, carefully pull it all the way out.

To Replace:

1. Align the drawer glides with the receiving guides.

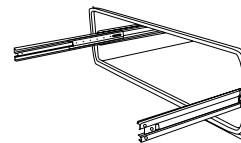

2. Push drawer in all the way.
3. Gently open and close the drawer to ensure it is seated properly on the slides.

TROUBLESHOOTING

Try the solutions suggested here first in order to avoid the cost of an unnecessary service call.

Nothing will operate

- **Is the power supply cord unplugged?** Plug into a grounded outlet.
- **Has a household fuse blown, or has a circuit breaker tripped?** Replace the fuse or reset the circuit.

Cooktop will not operate

- **Is the control knob set correctly?** Push in knob before turning to a setting.
- **On some ceramic glass models, is the Cooktop Control Lock set?** See “ALL OFF/Control Lock” in “Cooktop Controls for Electronic Touch Activated System” section.

Excessive heat around cookware on cooktop

- **Is the cookware the proper size?** Use cookware about the same size as the surface cooking area, element or surface burner. Cookware should not extend more than ½" (1.25 cm) outside the cooking area.

Hot surface indicator light stays on

- **Does the hot surface indicator light stay on after controls have been turned off?** See “Hot Surface Indicator Lights” in “Cooktop Controls for Electronic Touch Activated System,” “Cooktop Controls for Electronic Knob Control System” or “Cooktop Controls for Standard Knob Control System” section, depending on your model.

Cooktop cooking results not what expected

- **Is the proper cookware being used?** See “Cookware” section.
- **Is the control knob or element controls set to the proper heat level?** See “Cooktop Controls for Electronic Touch Activated System,” “Cooktop Controls for Electronic Knob Control System” or “Cooktop Controls for Standard Knob Control System” section, depending on your model.
- **Is the appliance level?** Level the appliance. See the Installation Instructions.

Oven will not operate

- **Is the electronic oven control set correctly?** See “Electronic Oven Control” section.
- **Has a delay start been set?** See “Timed Cooking” section.
- **On some models, is the Control Lock set?** See “Control Lock” section.
- **On some models, is the Sabbath Mode set?** See “Sabbath Mode” section.

Oven temperature too high or too low

- **Does the oven temperature calibration need adjustment?** See “Oven Temperature Control” section.

- **On some models, does the cooling fan run during BAKE, BROIL or CLEAN?** It is normal for the fan to automatically run when the oven is in use. This helps cool the electronic control.

Display shows messages

- **Is the display showing “SET CLOCK”?** There has been a power failure. Clear the display. See “Oven Displays” section. On some models, reset the clock, if needed. See “Clock/Timer Display” section.
- **Is the display showing a letter followed by a number?** Press OFF to clear the display. See “Oven Displays” section. If it reappears, call for service. See “Assistance or Service” section.

Self-Cleaning cycle will not operate

- **Is the oven door open?** Close the oven door all the way.
- **Has the function been entered?** See “Self-Cleaning Cycle” section.
- **On some models, has a delay start Self-Clean cycle been set?** See “Self-Cleaning Cycle” section.
- **Has a delay start been set?** See “Timed Cooking” section.

Oven cooking results not what expected

- **Is the appliance level?** Level the appliance. See the Installation Instructions.
- **Is the proper temperature set?** Double-check the recipe in a reliable cookbook.
- **Is the proper oven temperature calibration set?** See “Oven Temperature Control” section.
- **Was the oven preheated?** See “Bake,” “Convection Bake,” “Convection Roast” or “Convection Broil” section.
- **Is the proper bakeware being used?** See “Bakeware” section.
- **Are the racks positioned properly?** See “Positioning Racks and Bakeware” section.
- **Is there proper air circulation around bakeware?** See “Positioning Racks and Bakeware” section.
- **Is the batter evenly distributed in the pan?** Check to make sure batter is level in the pan.
- **Is the proper length of time being used?** Adjust cooking time.
- **Has the oven door been opened while cooking?** Oven peeking releases oven heat and can result in longer cooking times.
- **Are baked items too brown on the bottom?** Move rack to higher position in the oven.
- **Are pie crust edges browning early?** Use aluminum foil to cover the edge of the crust and/or reduce baking temperature.

ASSISTANCE OR SERVICE

Before calling for assistance or service, please check "Troubleshooting." It may save you the cost of a service call. If you still need help, follow the instructions below.

When calling, please know the purchase date and the complete model and serial number of your appliance. This information will help us to better respond to your request.

If you need replacement parts

If you need to order replacement parts, we recommend that you use only factory specified parts. These factory specified parts will fit right and work right because they are made with the same precision used to build every new KITCHENAID® appliance.

To locate factory specified parts in your area, call our Customer Interaction Center telephone number or your nearest KitchenAid designated service center.

In the U.S.A.

Call the KitchenAid Customer Interaction Center toll free:
1-800-422-1230.

Our consultants provide assistance with:

- Features and specifications on our full line of appliances.
- Installation information.
- Accessory and repair parts sales.
- Specialized customer assistance (Spanish speaking, hearing impaired, limited vision, etc.).
- Referrals to local dealers, repair parts distributors, and service companies. KitchenAid designated service technicians are trained to fulfill the product warranty and provide after-warranty service, anywhere in the United States.

To locate the KitchenAid designated service company in your area, you can also look in your telephone directory Yellow Pages.

For further assistance

If you need further assistance, you can write to KitchenAid with any questions or concerns at:

KitchenAid Brand Home Appliances
Customer Interaction Center
553 Benson Road
Benton Harbor, MI 49022-2692

Please include a daytime phone number in your correspondence.

Accessories U.S.A.

To order accessories, call the KitchenAid Customer Interaction Center toll free at **1-800-442-9991** and follow the menu prompts. Or visit our website at www.kitchenaid.com and click on "Shop-Online," then "Accessories." Portable appliances, bakeware, cookware, gadgets and textiles are also available.

Canning Unit Kit

(coil element models)
Order Part #242905

Cooktop Polishing Creme

(ceramic glass models)
Order Part #4392916

Cooktop Scraper

(ceramic glass models)
Order Part #3183488

Stainless Steel Cleaner & Polish

(stainless steel models)
Order Part #4396095

Gourmet Griddle

Order Part #4396096

Warming Drawer Pan (1/2 Size)

(ceramic glass models)
Order Part #8171421

Warming Drawer Pan (1/3 Size)

(ceramic glass models)
Order Part #8171422

In Canada

For product related questions, please call the KitchenAid Canada Customer Interaction Center toll free: **1-800-461-5681**
Monday to Friday 8:00 a.m. - 6:00 p.m. (EST).
Saturday 8:30 a.m. - 4:30 p.m. (EST).

Our consultants provide assistance with:

- Features and specifications on our full line of appliances.
- Referrals to local dealers.

For parts, accessories and service in Canada

Call **1-800-807-6777**. KitchenAid designated service technicians are trained to fulfill the product warranty and provide after-warranty service, anywhere in Canada.

For further assistance

If you need further assistance, you can write to KitchenAid Canada with any questions or concerns at:

Customer Interaction Center
KitchenAid Canada
1901 Minnesota Court
Mississauga, Ontario L5N 3A7

Please include a daytime phone number in your correspondence.

KITCHENAID® COOKTOP, BUILT-IN OVEN AND RANGE WARRANTY

ONE-YEAR FULL WARRANTY

For one year from the date of purchase, when this appliance is operated and maintained according to instructions attached to or furnished with the product, KitchenAid will pay for factory specified parts and repair labor costs to correct defects in materials or workmanship. Service must be provided by a KitchenAid designated service company.

SECOND THROUGH FIFTH YEAR LIMITED WARRANTY ON ELECTRIC ELEMENTS, CERAMIC GLASS COOKTOP, GAS BURNERS, SOLID STATE TOUCH CONTROL SYSTEM, AND MAGNETRON TUBE

On electric ranges and electric cooktops, in the second through fifth years from the date of purchase, when this appliance is operated and maintained according to instructions attached to or furnished with the product, KitchenAid will pay for factory specified parts for any electric element to correct defects in materials or workmanship.

On ceramic glass ranges and ceramic glass cooktops, in the second through fifth years from the date of purchase, when this appliance is operated and maintained according to instructions attached to or furnished with the product, KitchenAid will pay for factory specified parts for the ceramic glass cooktop. KitchenAid warrants that the ceramic glass cooktop will not discolor, the cooktop pattern will not wear off, the rubber seal between the ceramic glass cooktop and porcelain edge will not crack, the ceramic glass cooktop will not crack due to thermal shock and the surface unit elements will not burn out.

On gas ranges and gas cooktops, in the second through fifth years from the date of purchase, when this appliance is operated and maintained according to instructions attached to or furnished with the product, KitchenAid will pay for factory specified parts for any gas burner to correct defects in materials or workmanship.

On ranges and built-in ovens, in the second through fifth years from the date of purchase, when this appliance is operated and maintained according to instructions attached to or furnished with the product, KitchenAid will pay for factory specified parts for solid state touch control system and Magnetron tube in combination ovens to correct defects in materials or workmanship.

SECOND THROUGH TENTH YEAR LIMITED WARRANTY ON RANGES AND BUILT-IN OVENS PORCELAIN OVEN CAVITY/INNER DOOR

On ranges and built-in ovens only, in the second through tenth years from date of purchase, when this appliance is operated and maintained according to instructions attached to or furnished with the product, KitchenAid will pay for factory specified parts for the porcelain oven cavity/inner door if the part rusts through due to defects in materials or workmanship.

KitchenAid will not pay for:

1. Service calls to correct the installation of your appliance, to instruct you how to use your appliance, to replace house fuses or correct house wiring, or to replace owner-accessible light bulbs.
2. Repairs when your appliance is used in other than normal, single-family household use.
3. Pickup and delivery. Your appliance is designed to be repaired in the home.
4. Damage resulting from accident, alteration, misuse, abuse, fire, flood, improper installation, acts of God or use of products not approved by KitchenAid or KitchenAid Canada.
5. Repairs to parts or systems resulting from unauthorized modifications made to the appliance.
6. Replacement parts or repair labor costs for units operated outside the United States or Canada.
7. In Canada, travel or transportation expenses for customers who reside in remote areas.
8. Any labor costs during the limited warranty periods.

KITCHENAID AND KITCHENAID CANADA SHALL NOT BE LIABLE FOR INCIDENTAL OR CONSEQUENTIAL DAMAGES.

Some states or provinces do not allow the exclusion or limitation of incidental or consequential damages, so this exclusion or limitation may not apply to you. This warranty gives you specific legal rights, and you may also have other rights which vary from state to state or province to province.

Outside the 50 United States and Canada, this warranty does not apply. Contact your authorized KitchenAid dealer to determine if another warranty applies.

If you need service, first see the "Troubleshooting" section of this book. After checking "Troubleshooting," additional help can be found by checking the "Assistance or Service" section or by calling the KitchenAid Customer Interaction Center, **1-800-422-1230** (toll-free), from anywhere in the U.S.A. In Canada, contact your KitchenAid designated service company or call **1-800-807-6777**. 4/04

Keep this book and your sales slip together for future reference. You must provide proof of purchase or installation date for in-warranty service.

Write down the following information about your appliance to better help you obtain assistance or service if you ever need it. You will need to know your complete model number and serial number. You can find this information on the model and serial number label/plate, located on your appliance as shown in the "Parts and Features" section.

Dealer name _____

Address _____

Phone number _____

Model number _____

Serial number _____

Purchase date _____

Free Manuals Download Website

<http://myh66.com>

<http://usermanuals.us>

<http://www.somanuals.com>

<http://www.4manuals.cc>

<http://www.manual-lib.com>

<http://www.404manual.com>

<http://www.luxmanual.com>

<http://aubethermostatmanual.com>

Golf course search by state

<http://golfingnear.com>

Email search by domain

<http://emailbydomain.com>

Auto manuals search

<http://auto.somanuals.com>

TV manuals search

<http://tv.somanuals.com>