

---

# MICROWAVE OVEN WITH CONVECTION

## Use & Care Guide

For questions about features, operation/performance, parts, accessories or service, call: **1-800-422-1230**,  
or visit our website at... [www.kitchenaid.com](http://www.kitchenaid.com)

---

Table of Contents ..... 2



**Model KCMC1575**  
**W10434302A**

---

# TABLE OF CONTENTS

<b>MICROWAVE OVEN SAFETY</b> .....	<b>3</b>	<b>MICROWAVE OVEN USE</b> .....	<b>8</b>
<b>INSTALLATION INSTRUCTIONS</b> .....	<b>5</b>	Food Characteristics .....	8
Unpacking .....	5	Cooking Guidelines .....	9
Location Requirements .....	5	Cookware and Dinnerware.....	9
Electrical Requirements .....	5	Aluminum Foil and Metal.....	9
<b>PARTS AND FEATURES</b> .....	<b>6</b>	Microwave Cooking Power .....	10
Turntable .....	6	Manual Cooking .....	10
Grill Element .....	6	Cooking in Stages .....	10
Convection Element and Fan.....	6	Sensor Cooking.....	10
Grill and Convection Racks .....	6	Menu (sensor and non-sensor) .....	11
<b>MICROWAVE OVEN CONTROL</b> .....	<b>7</b>	Grill.....	12
Display .....	7	Convection .....	12
Start .....	7	Convection Temperature Indicator .....	12
Add 30 Seconds.....	7	Convection Roast.....	12
Stop Cancel.....	7	Convection Bake .....	13
Tones.....	7	Defrost .....	14
Clock .....	8	<b>MICROWAVE OVEN CARE</b> .....	<b>15</b>
Timer.....	8	General Cleaning .....	15
Language.....	8	<b>TROUBLESHOOTING</b> .....	<b>16</b>
Weight Entry Mode .....	8	<b>ASSISTANCE OR SERVICE</b> .....	<b>17</b>
Control Lock.....	8	Replacement Parts.....	17
		Built-In Kits .....	17
		<b>WARRANTY</b> .....	<b>18</b>

# MICROWAVE OVEN SAFETY

## Your safety and the safety of others are very important.

We have provided many important safety messages in this manual and on your appliance. Always read and obey all safety messages.



This is the safety alert symbol.

This symbol alerts you to potential hazards that can kill or hurt you and others.

All safety messages will follow the safety alert symbol and either the word "DANGER" or "WARNING."

These words mean:

**⚠ DANGER**

**You can be killed or seriously injured if you don't immediately follow instructions.**

**⚠ WARNING**

**You can be killed or seriously injured if you don't follow instructions.**

All safety messages will tell you what the potential hazard is, tell you how to reduce the chance of injury, and tell you what can happen if the instructions are not followed.

## IMPORTANT SAFETY INSTRUCTIONS

When using electrical appliances basic safety precautions should be followed, including the following:

**WARNING:** To reduce the risk of burns, electric shock, fire, injury to persons, or exposure to excessive microwave energy:

- Read all instructions before using the microwave oven.
- Read and follow the specific "PRECAUTIONS TO AVOID POSSIBLE EXPOSURE TO EXCESSIVE MICROWAVE ENERGY" found in this section.
- The microwave oven must be grounded. Connect only to properly grounded outlet. See "GROUNDING INSTRUCTIONS" found in the "INSTALLATION INSTRUCTIONS" section.
- Install or locate the microwave oven only in accordance with the provided Installation Instructions.
- Some products such as whole eggs in the shell and sealed containers - for example, closed glass jars - are able to explode and should not be heated in the microwave oven.
- Use the microwave oven only for its intended use as described in the manual. Do not use corrosive chemicals or vapors in the microwave oven. This type of oven is specifically designed to heat, cook, or dry food. It is not designed for industrial or laboratory use.
- As with any appliance, close supervision is necessary when used by children.
- Do not operate the microwave oven if it has a damaged cord or plug, if it is not working properly, or if it has been damaged or dropped.
- The microwave oven should be serviced only by qualified service personnel. Call an authorized service company for examination, repair, or adjustment.
- Do not cover or block any openings on the microwave oven.
- Do not store this microwave oven outdoors. Do not use the microwave oven near water - for example, near a kitchen sink, in a wet basement, near a swimming pool, or similar locations.
- Do not immerse cord or plug in water.
- Keep cord away from heated surfaces.
- Do not let cord hang over edge of table or counter.
- See door surface cleaning instructions in the "Microwave Oven Care" section.
- To reduce the risk of fire in the oven cavity:
  - Do not overcook food. Carefully attend the microwave oven when paper, plastic, or other combustible materials are placed inside the oven to facilitate cooking.
  - Remove wire twist-ties from paper or plastic bags before placing bags in oven.
  - If materials inside the oven ignite, keep oven door closed, turn oven off, and disconnect the power cord, or shut off power at the fuse or circuit breaker panel.
  - Do not use the cavity for storage purposes. Do not leave paper products, cooking utensils, or food in the cavity when not in use.

## SAVE THESE INSTRUCTIONS

## IMPORTANT SAFETY INSTRUCTIONS

- Liquids, such as water, coffee, or tea are able to be overheated beyond the boiling point without appearing to be boiling. Visible bubbling or boiling when the container is removed from the microwave oven is not always present. **THIS COULD RESULT IN VERY HOT LIQUIDS SUDDENLY BOILING OVER WHEN THE CONTAINER IS DISTURBED OR A SPOON OR OTHER UTENSIL IS INSERTED INTO THE LIQUID.**

To reduce the risk of injury to persons:

- Do not overheat the liquid.
- Stir the liquid both before and halfway through heating it.
- Do not use straight-sided containers with narrow necks.
- After heating, allow the container to stand in the microwave oven for a short time before removing the container.
- Use extreme care when inserting a spoon or other utensil into the container.

- Do not mount over a sink.
- Do not store anything directly on top of the microwave oven when the microwave oven is in operation.
- Oversized foods or oversized metal utensils should not be inserted in the microwave oven as they may create a fire or risk of electric shock.
- Do not clean with metal scouring pads. Pieces can burn off the pad and touch electrical parts involving a risk of electric shock.
- Do not use paper products when appliance is operated in convection, combination, grill or "PAN BROWN" mode.
- Do not store any materials, other than manufacturer's recommended accessories, in this microwave oven when not in use.
- Do not cover racks or any other part of the microwave oven with metal foil. This will cause overheating of the microwave oven.

## SAVE THESE INSTRUCTIONS

## PRECAUTIONS TO AVOID POSSIBLE EXPOSURE TO EXCESSIVE MICROWAVE ENERGY

- (a) Do not attempt to operate this oven with the door open since open-door operation can result in harmful exposure to microwave energy. It is important not to defeat or tamper with the safety interlocks.
- (b) Do not place any object between the oven front face and the door or allow soil or cleaner residue to accumulate on sealing surfaces.
- (c) Do not operate the oven if it is damaged. It is particularly important that the oven door close properly and that there is no damage to the:
  - (1) Door (bent),
  - (2) Hinges and latches (broken or loosened),
  - (3) Door seals and sealing surfaces.
- (d) The oven should not be adjusted or repaired by anyone except properly qualified service personnel.

This device complies with Part 18 of the FCC Rules.

State of California Proposition 65 Warnings:

WARNING: This product contains one or more chemicals known to the State of California to cause cancer.

WARNING: This product contains one or more chemicals known to the State of California to cause birth defects or other reproductive harm.

# INSTALLATION INSTRUCTIONS

## Unpacking

1. Empty the microwave oven of any packing materials.
2. Clean the inside with a soft, damp cloth.
3. Check for damage, such as:
  - a door that is not lined up correctly
  - damage around the door, or
  - dents on the interior or exterior of the microwave oven.

If there is any damage, do not operate the microwave oven until a designated service technician has checked it and made any needed repairs.

**NOTE:** To avoid damage to the microwave oven, do not remove microwave inlet cover. See "Parts and Features."

## Location Requirements

### **⚠ WARNING**

#### **Excessive Weight Hazard**

**Use two or more people to move and install microwave oven.**

**Failure to do so can result in back or other injury.**

**IMPORTANT:** The control side of the microwave oven is the heavy side. Handle the microwave oven gently. The weight of the microwave oven is over 35 lbs (15.9 kg).

- Place the microwave oven on a cart, counter, table or shelf that is strong enough to hold the microwave oven and the food and utensils you place inside it.
- The microwave oven should be at a temperature above 50°F (10°C) for proper operation.

**NOTE:** Some models can be built into a wall or cabinet by using one of the trim kits listed in the "Assistance or Service" section.

- Do not block the exhaust vents or air intake openings. Allow a few inches of space at the back and side of the microwave oven where the exhaust vents are located. Blocking the exhaust vents could cause damage to the microwave oven, as well as poor cooking results.
- Make sure the microwave oven legs are in place to ensure proper airflow. If vents are blocked, a sensitive thermal device may automatically turn the microwave oven off. The microwave oven should work properly once it has cooled.

## Electrical Requirements

### **⚠ WARNING**



#### **Electrical Shock Hazard**

**Plug into a grounded 3 prong outlet.**

**Do not remove ground prong.**

**Do not use an adapter.**

**Do not use an extension cord.**

**Failure to follow these instructions can result in death, fire, or electrical shock.**

Observe all governing codes and ordinances.

#### **Required:**

- A 120 volt, 60 Hz, AC only, 15- or 20-amp electrical supply with a fuse or circuit breaker.

#### **Recommended:**

- A time-delay fuse or time-delay circuit breaker.
- A separate circuit serving only this microwave oven.

## **GROUNDING INSTRUCTIONS**

#### **■ For all cord connected appliances:**

The microwave oven must be grounded. In the event of an electrical short circuit, grounding reduces the risk of electric shock by providing an escape wire for the electric current. The microwave oven is equipped with a cord having a grounding wire with a grounding plug. The plug must be plugged into an outlet that is properly installed and grounded.

**WARNING:** Improper use of the grounding plug can result in a risk of electric shock. Consult a qualified electrician or serviceman if the grounding instructions are not completely understood, or if doubt exists as to whether the microwave oven is properly grounded.

Do not use an extension cord. If the power supply cord is too short, have a qualified electrician or serviceman install an outlet near the microwave oven. A short power supply cord is provided to reduce the risks resulting from becoming entangled in or tripping over a longer cord.

## **SAVE THESE INSTRUCTIONS**

# PARTS AND FEATURES

This manual may cover several different models. The model you have purchased may have some or all of the features shown here. The appearance of your particular model may differ slightly from the illustrations in this manual.

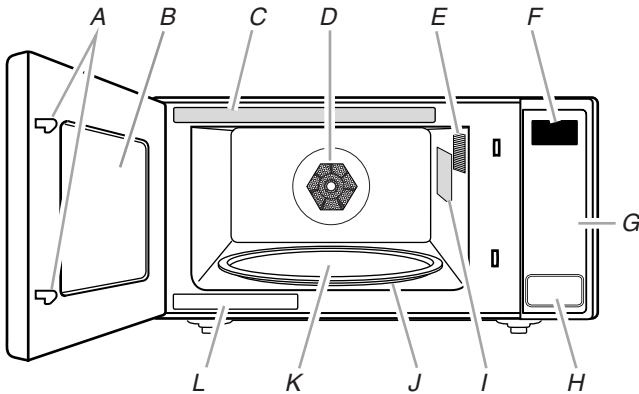

- A. Door lock system
  - B. Window
  - C. Cooking guide label
  - D. Convection element and fan
  - E. Microwave oven light
  - F. Display
  - G. Control panel
  - H. Door open push button
  - I. Microwave inlet cover
  - J. Removable turntable support
  - K. Glass turntable
  - L. Model and serial number plate
- Parts and Features Not Shown:**  
Grill element (on cavity ceiling)

## Grill Element

The microwave oven uses a calrod thermal element for grilling. The microwave oven cavity and door will become hot. The use of oven mitts is recommended.

## Convection Element and Fan

The microwave oven's convection system is composed of a convection element, which heats in conjunction with the convection fan for true convection cooking. The convection system is embedded in the wall of the microwave oven cavity, behind the screen. See "Parts and Features." The microwave oven cavity and door will become hot. The use of oven mitts is recommended.

## Grill and Convection Racks

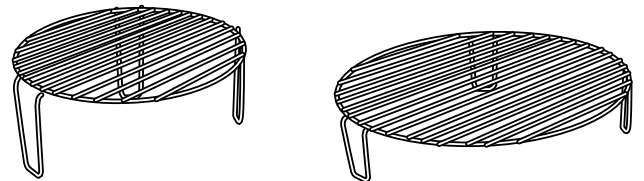

The tall grill rack is designed for grilling in the microwave oven. See "Grill" section. Place the grill rack securely on a pan, the pan on the turntable, and position food on grill rack. See "Assistance or Service" to order replacement parts. See "General Cleaning" for cleaning instructions.

The short convection rack is designed to be used with the convection element and fan for true convection cooking. See "Convection Bake" and "Convection Roast" sections. Place the convection rack on the turntable, and position dish with food on the rack. If food is placed directly on the rack, a pan may be placed under the rack to catch drippings. See "Assistance or Service" to order replacement parts. See "General Cleaning" for cleaning instructions.

## Turntable

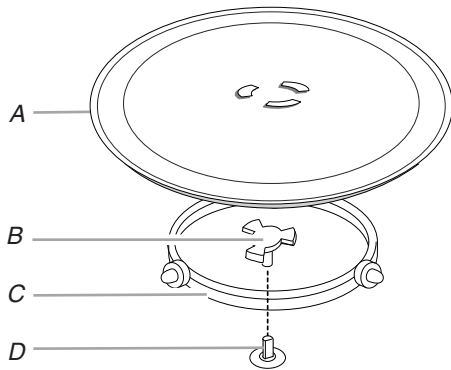

- A. Turntable
- B. Hub
- C. Support
- D. Shaft

The turntable can rotate in either direction to help cook food more evenly. For best cooking results, do not operate the microwave oven without having the turntable in place. See "Assistance or Service" to reorder any of the parts.

### To Install:

- Place the support on the microwave oven cavity bottom.
- Place the turntable on the support.

Fit the raised, curved wedges in the center of the turntable bottom between the three spokes of the hub. The rollers on the support should fit inside the turntable bottom ridge.

## Accessory Configurations

### Grilling

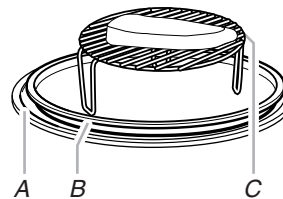

### Roasting

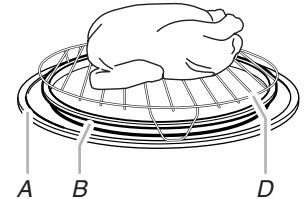

### Baking

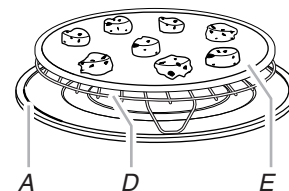

- A. Turntable
- B. Pan (not provided)
- C. Grill rack

- D. Convection rack
- E. Cookie sheet (not provided)

# MICROWAVE OVEN CONTROL

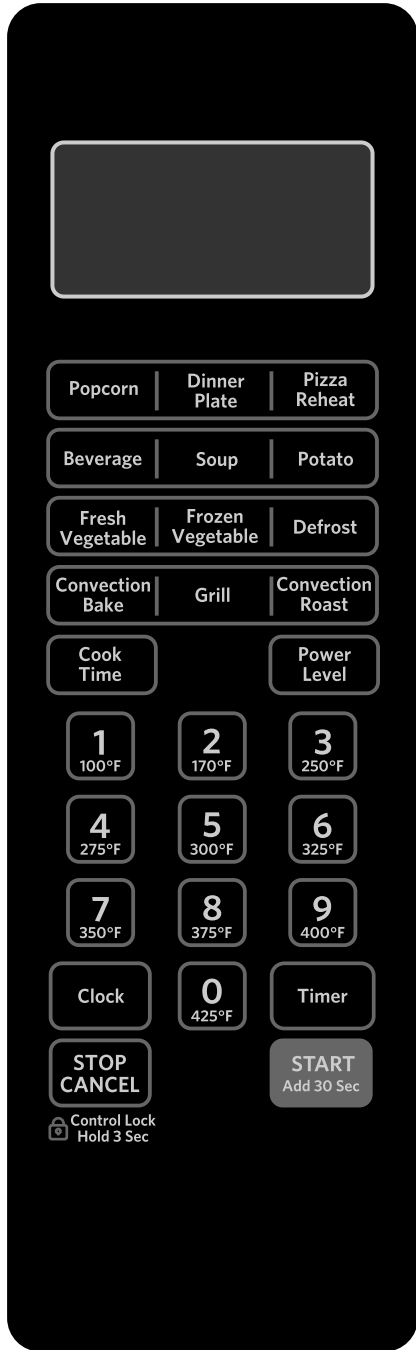

## Display

When power is first supplied to the microwave oven, "0:00" will appear in the display. If the "0:00" appears in the display at any other time, a power failure has occurred. Reset the clock if needed. See "Clock."

When the microwave oven is in use, the display will show cook time remaining. When the microwave oven is not in use, the display will show the time of day (if the clock is set) or Timer countdown (if the Timer is set).

## Start

The START control begins any function. If non-sensor cooking is interrupted by opening the door, touching START will resume the cycle.

**NOTE:** To avoid unintentional operation of the microwave oven, a cooking function cannot be started if the microwave oven door has been closed for about 5 minutes. The word "door" will appear in the display until the door is opened and closed.

## Add 30 Seconds

The (START) ADD 30 SEC control automatically starts the microwave oven at 100% power for 30 seconds, and adds 30 seconds of cook time with each additional touch of the control.

Time may be added to any manual cooking cycle in 30-second increments, at the current power level, by touching (START) ADD 30 SEC during cooking.

**NOTE:** To avoid unintentional operation of the microwave oven, a cooking function cannot be started if the microwave oven door has been closed for about 5 minutes. The word "door" will appear in the display until the door is opened and closed.

## Stop Cancel

The STOP CANCEL control clears any incorrect command, and cancels any program during cooking. It will not erase the time of day.

The microwave oven will also turn off when the door is opened. Close the door and touch START to resume the cycle.

The STOP CANCEL control is also used to lock and unlock the control panel. See "Control Lock."

## Tones

Tones are audible signals that may be turned off.

**To Turn Off/On End-of-Cycle, End-of-Timer and Reminder Tones:** With the microwave oven door open, touch and hold number pad 3 for about 3 seconds, until a tone sounds.

**To Turn Off/On All Tones:** With the microwave oven door open, touch and hold number pad 2 for about 3 seconds.

These tones indicate the following:

### One tone

- Valid entry
- Control lock activated or deactivated
- End of stage in multistage cooking

### Two tones

- End of convection bake preheat

### Three tones

- End of Timer countdown

### Five tones

- End of cooking cycle
- Reminder, repeat each minute after the end-of-cycle and end-of-Timer tones

---

## Clock

This is a standard 12-hour clock (1:00-12:59). The Clock cannot be erased. If the Clock is not set, "0:00" will remain in the display when the microwave oven is not in use.

### To Set:

The microwave oven and Timer must be off.

1. Touch CLOCK.
  2. Touch number pads to enter correct time of day.
  3. Touch CLOCK.
- 

## Timer

The Timer can be set in minutes and seconds, up to 99 minutes 99 seconds, and counts down the set time.

**NOTE:** The Timer does not start or stop the microwave oven.

Cook functions may be used while the Timer is counting down. When the cook function is active in the display, touch TIMER to see the Timer count down for about 5 seconds.

### To Set:

1. Touch TIMER.
  2. Touch number pads to enter desired time.
  3. Touch START.  
When the set time ends, "End" will appear in the display and the end-of-Timer tones will sound.
  4. Touch STOP CANCEL while the Timer is active in the display to cancel the Timer.
- 

---

## Language

The default display language is English, but may be set to French. Two display messages are affected: "End" (English) or "Fin" (French), and "door" (English) or "PrtE" ("porte" - French).

**To Set Language to French:** With the microwave oven door open, touch and hold number pad 1 for about 3 seconds, until a tone sounds. Repeat to change back to English. The language remains set after a power failure.

---

## Weight Entry Mode

The default weight entry mode for Defrost is imperial (pounds), but may be set to metric (grams). This setting does not affect any other program besides Defrost. See "Defrost" section.

**To Set Weight Entry to Metric:** With the microwave oven door open, touch and hold number pad 0 for about 3 seconds, until a tone sounds. Repeat to change back to imperial. The mode remains set after a power failure.

---

## Control Lock

The Control Lock disables the control panel pads to avoid unintended use of the microwave oven.

**To Lock/Unlock Control:** The microwave oven must be off. Touch and hold STOP CANCEL for about 3 seconds, until the tone sounds and the control lock icon appears in the display. Repeat to unlock.

If any control pad is touched while the control is locked, there will be no response from the control.

---

---

# MICROWAVE OVEN USE

A magnetron in the microwave oven produces microwaves which reflect off the metal floor, walls and ceiling and pass through the turntable and appropriate cookware to the food. Microwaves are attracted to and absorbed by fat, sugar and water molecules in the food, causing them to move, producing friction and heat which cooks the food.

- To avoid damage to the microwave oven, do not lean on or allow children to swing on the microwave oven door.
- To avoid damage to the microwave oven, do not operate microwave oven when it is empty.
- Baby bottles and baby food jars should not be heated in microwave oven.
- Clothes, flowers, fruit, herbs, wood, gourds, paper, including brown paper bags and newspaper, should not be dried in microwave oven.
- Paraffin wax will not melt in the microwave oven because it does not absorb microwaves.
- Use oven mitts or pot holders when removing containers from microwave oven.
- Do not overcook potatoes. At the end of the recommended cook time, potatoes should be slightly firm. Let potatoes stand for 5 minutes. They will finish cooking while standing.
- Do not cook or reheat whole eggs inside the shell. Steam buildup in whole eggs may cause them to burst, requiring significant cleanup of microwave oven cavity. Cover poached eggs and allow a standing time.

---

## Food Characteristics

When microwave cooking, the amount, size and shape, starting temperature, composition and density of the food affect cooking results.

### Amount of Food

The more food heated at once, the longer the cook time needed. Check for doneness and add small increments of time if necessary.

### Size and Shape

Smaller pieces of food will cook more quickly than larger pieces, and uniformly shaped foods cook more evenly than irregularly shaped food.

### Starting Temperature

Room temperature foods will heat faster than refrigerated foods, and refrigerated foods will heat faster than frozen foods.

### Composition and Density

Foods high in fat and sugar will reach a higher temperature, and will heat faster than other foods. Heavy, dense foods, such as meat and potatoes, require a longer cook time than the same size of a light, porous food, such as cake.



## Cooking Guidelines

### Covering

Covering food helps retain moisture, shorten cook time and reduce spattering. Use the lid supplied with cookware. If a lid is not available, wax paper, paper towels or plastic wrap approved for microwave ovens may be used. Plastic wrap should be turned back at one corner to provide an opening to vent steam. Condensation on the door and cavity surfaces is normal during heavy cooking.

### Stirring and Turning

Stirring and turning redistribute heat evenly to avoid overcooking the outer edges of food. Stir from outside to center. If possible, turn food over from bottom to top.

### Arranging

If heating irregularly shaped or different sized foods, arrange the thinner parts and smaller sized items toward the center. If cooking several items of the same size and shape, place them in a ring pattern, leaving the center of the ring empty.

### Piercing

Before heating, use a fork or small knife to pierce or prick foods that have a skin or membrane, such as potatoes, egg yolks, chicken livers, hot dogs, and sausage. Prick in several places to allow steam to vent.

### Shielding

Use small, flat pieces of aluminum foil to shield the thin pieces of irregularly shaped foods, bones and foods such as chicken wings, leg tips and fish tail. See "Aluminum Foil and Metal" first.

### Standing Time

Food will continue to cook by the natural conduction of heat even after the microwave cooking cycle ends. The length of standing time depends on the volume and density of the food.

## Cookware and Dinnerware

Cookware and dinnerware must fit on the turntable. Always use oven mitts or pot holders when handling because any dish may become hot from heat transferred from the food. Do not use cookware and dinnerware with gold or silver trim. Use the following chart as a guide, then test before using.

MATERIAL	RECOMMENDATIONS
Aluminum Foil, Metal	See "Aluminum Foil and Metal" section.
Browning Dish	Bottom must be at least 3/16" (5 mm) above the turntable. Follow manufacturer's recommendations.
Ceramic Glass, Glass	Acceptable for use.
China, Earthenware	Follow manufacturer's recommendations.
Melamine	Follow manufacturer's recommendations.
Paper: Towels, Dinnerware, Napkins	Use nonrecycled and those approved by the manufacturer for microwave oven use.

MATERIAL	RECOMMENDATIONS
Plastic: Wraps, Bags, Covers, Dinnerware, Containers	Use those approved by the manufacturer for microwave oven use.
Pottery and Clay	Follow manufacturer's recommendations.
Silicone Bakeware	Follow manufacturer's recommendations.
Straw, Wicker, Wooden Containers	Do not use in microwave oven.
Wax Paper	Acceptable for use.

### To Test Cookware or Dinnerware for Microwave Use:

- Place cookware or dinnerware in microwave oven with 1 cup (250 mL) of water beside it.
- Cook at 100% cooking power for 1 minute.

Do not use cookware or dinnerware if it becomes hot and the water stays cool.

## Aluminum Foil and Metal

Always use oven mitts or pot holders when removing dishes from the microwave oven.

Aluminum foil and some metal can be used in the microwave oven. If not used properly, arcing (a blue flash of light) can occur and cause damage to the microwave oven.

### OK for Use

Racks and bakeware supplied with the microwave oven (on some models), aluminum foil for shielding, and approved meat thermometers may be used with the following guidelines:

- To avoid damage to the microwave oven, do not allow aluminum foil or metal to touch the inside cavity walls, ceiling or floor.
- Always use the turntable.
- To avoid damage to the microwave oven, do not allow contact with another metal object during microwave cooking.

### Do Not Use

Metal cookware and bakeware, gold, silver, pewter, non-approved meat thermometers, skewers, twist ties, foil liners such as sandwich wrappers, staples and objects with gold or silver trim or a metallic glaze should not be used in the microwave oven.

### For Use with Grill Element

Use the provided tall grill rack with an ovenproof pan to catch the drippings.

### For Use with Convection System

Use the provided short convection rack and an ovenproof baking dish for convection baking.

Use the provided short convection rack and a microwave-safe, ovenproof baking dish for convection roasting.

---

## Microwave Cooking Power

Many recipes for microwave cooking specify which cooking power to use by percent or name. For example, PL7=70%=Medium-High.

To see the exact power level during a cooking cycle, touch **POWER LEVEL**. The display will briefly show the current power level, then will return to the cooking countdown.

Use the following chart as a general guide for the suggested cooking power of specific foods.

PERCENT/NAME	USE
100%, High, PL10 (default setting)	Quick heating convenience foods and foods with high water content, such as soups, beverages and most vegetables.
90%, PL9	Cooking small, tender pieces of meat, ground meat, poultry pieces and fish fillets. Heating cream soups.
80%, PL8	Heating rice, pasta or stirrable casseroles. Cooking and heating foods that need a cook power lower than high. For example, whole fish and meat loaf.
70%, Medium-High, PL7	Reheating a single serving of food.
60%, PL6	Cooking sensitive foods such as cheese and egg dishes, pudding and custards. Cooking non-stirrable casseroles, such as lasagna.
50%, Medium, PL5	Cooking ham, whole poultry and pot roasts. Simmering stews.
40%, PL4	Melting chocolate. Heating bread, rolls and pastries.
30%, Medium-Low, Defrost, PL3	Defrosting bread, fish, meats, poultry and precooked foods.
20%, PL2	Softening butter, cheese, and ice cream.
10%, Low, PL1	Taking chill out of fruit.

## Manual Cooking

**NOTE:** To cook at 100% power, begin by touching number pads to enter cook time, then touch **START**.

### To Use:

1. Place food on the turntable and close the door.
2. Touch **COOK TIME**.  
“00:00” will appear in the display. Enter the length of time to cook.  
If cooking with 100% power, skip Step 3.
3. Touch **POWER LEVEL**.  
The default power level PL10 will appear in the display. Enter the desired power level. See “Microwave Cooking Power.”
4. Touch **START**.  
When the cycle ends, “End” will appear in the display, and the end-of-cycle tones will sound.
5. Touch **STOP CANCEL** or open the door to clear the display.

---

## Cooking in Stages

The microwave oven can be set to cook at different cooking powers for various lengths of time, up to 2 stages, which may include a defrosting stage. See “Defrost” to set defrosting stage.

**NOTE:** If a defrosting stage is programmed, it will cycle first.

### To Cook in Stages:

1. Place food on the turntable, and close the door.
2. Touch **COOK TIME**.  
“00:00” will appear in the display. Enter the length of time to cook during the first stage.
3. Touch **POWER LEVEL**, then enter the desired cooking power for the first stage. See “Microwave Cooking Power.”
4. Repeat steps 2 and 3 for the second stage.
5. Touch **START**.  
One tone will sound between stages.  
When the cycle ends, “End” will appear in the display, and the end-of-cycle tones will sound.
6. Touch **STOP CANCEL** or open the door to clear the display.  
Cook time may be added in 30-second increments during the cycling stage by touching (**START**) **ADD 30 SEC** control.

---

## Sensor Cooking

A sensor in the microwave oven detects humidity released from the food as it heats, and adjusts the cook time accordingly.

Many sensor cycles require the covering of foods. Microwave-safe containers or steamers with loose-fitting lids are recommended. The loose-fitting lid allows enough steam to escape to be detected by the sensor. When covering foods with plastic wrap, be sure to leave a large enough vent opening to allow the steam to escape.

“SC” (sensor cook) will appear in the display during sensor cooking.

### NOTES:

- The microwave oven should be plugged in for at least 3 minutes.
- The microwave oven cavity and the exterior of the cooking container should be dry.
- The room temperature should not exceed 95°F (35°C).
- If the door is opened while the sensor is detecting moisture (while “SC” appears in the display), sensing will stop and the program will be canceled.

## Menu (sensor and non-sensor)

The following menu items are preprogrammed for quick and easy cooking/reheating.

For added convenience, the available/recommended amounts shown in the following chart are included on the Cooking Guide label (see "Parts and Features" for its location).

MENU ITEM	SERVING SIZE	INSTRUCTIONS
POPCORN (non-sensor)	3.3 oz (94 g) 3.0 oz (85 g) 1.75 oz (50 g)	<ul style="list-style-type: none"> <li>■ To avoid damage to the microwave oven, do not use regular paper bags or glassware.</li> <li>■ Pop only one package of popcorn at a time.</li> <li>■ Follow manufacturer's instructions when using a microwave popcorn popper.</li> <li>■ For best cooking results, do not try to pop unpopped kernels.</li> <li>■ Use fresh bags of popcorn for optimal results.</li> <li>■ Cooking results may vary by brand and fat content. For bag sizes not listed in this section, follow directions on the package.</li> </ul> <p><b>NOTE:</b> During Popcorn function, as with all microwave cooking functions, the microwave oven should be attended at all times. Listen for popping to slow to 1 pop every 1 or 2 seconds, then stop the cycle.</p>
PIZZA REHEAT (non-sensor)	1 to 3 slices, 3 oz (85 g) each, refrigerated	Place pizza slices on a paper towel-lined microwave-safe plate in the center of the turntable.
BEVERAGE (non-sensor, reheat)	1 or 2 cups, 8 oz (250 mL) each	Do not cover. The diameter of the cup's opening will affect how the liquid heats. Beverages in cups with smaller openings may heat faster.
SOUP (non-sensor)	1 to 4 cups (250 mL to 1 L)	Place in microwave-safe container. Cover with plastic wrap, and vent. Stir and let stand 2-3 minutes after heating.
POTATO (non-sensor)	1 to 4 potatoes, 10 oz (283 g) each	Pierce each one several times with a fork. Place on paper towel, around turntable edges, at least 1" (2.5 cm) apart. Place a single potato to the side of the turntable. Let stand 5 minutes after cooking.
DINNER PLATE (sensor, reheat)	10-16 oz (283-454 g), refrigerated	Place food on microwave-safe plate. Cover with plastic wrap, and vent*. Let stand 2-3 minutes after heating.
FRESH VEGETABLE (sensor)	1 to 4 cups (250 mL to 1 L)	Place in microwave-safe container, and add 2-4 tbs (30-60 mL) water. Cover with plastic wrap, and vent*. Stir and let stand 2-3 minutes after cooking.
FROZEN VEGETABLE (sensor)	1 to 4 cups (250 mL to 1 L)	Place in microwave-safe container, and add 2-4 tbs (30-60 mL) water. Cover with plastic wrap, and vent*. Stir and let stand 2-3 minutes after cooking.

\*When covering foods, make sure the vent opening is large enough for the moisture to escape. This will allow the sensor to accurately determine cooking time.

### To Use Non-sensor Menu (Popcorn, Pizza Reheat, Beverage, Soup, Potato):

1. Place food on the turntable, and close the door.
2. Touch desired menu control.  
The first programmed amount will appear in the display. Touch control pad repeatedly or touch number pads to change quantity. See chart.
3. Touch START.  
When the cycle ends, "End" will appear in the display, and the end-of-cycle tones will sound.
4. Touch STOP CANCEL or open the door to clear the display.

### To Use Sensor Menu (Dinner Plate, Fresh Vegetable, Frozen Vegetable):

1. Place food on the turntable, and close the door.
2. Touch the desired menu control.  
"SC" (sensor cook) will appear in the display.
3. Touch START.  
The microwave oven will start, and sensor cooking will begin. "SC" will remain in the display until the sensor has determined the remaining cook time.  
When the cycle ends, "End" will appear in the display, and the end-of-cycle tones will sound.
4. Touch STOP CANCEL or open the door to clear the display.

---

## Grill

The Grill function uses a calrod thermal element that heats quickly to grill a variety of foods.

- Use the grill rack to place food closer to the grill element for faster grilling.
- Oven cavity and door will become very hot during grill element use. The use of oven mitts is recommended.
- Use an ovenproof pan to catch drippings.
- The grill rack and pan will become very hot. Use oven mitts to grasp pan for removal. To avoid damage, do not place hot pan directly on heat-sensitive surfaces.
- The turntable must be in place when using the grill rack.
- For best results, apply light amount of cooking oil to grill rack.

---

### Examples of Grill Times

Toast	5-5½ min
Sirloin steak, 1 lb (454 g), 3/4" (1.9 cm) thick, medium doneness	Side 1: 15 min Side 2: 10 min

---

### To Use:

1. Place grill rack securely on pan, and place both on the turntable. Then position food on rack, and close the door.
2. Touch GRILL.  
"00:00" will appear in the display. Enter the length of time to grill in minutes and seconds.
3. Touch START.  
Grill time will count down in the display.  
About halfway through the cycle, a tone will sound. This is a reminder to turn the food, if desired.  
When the cycle ends, "End" will appear in the display, and the end-of-cycle tones will sound.
4. Touch STOP CANCEL or open the door to clear the display.

---

## Convection

The convection system circulates hot air through the microwave oven cavity with a fan. The constantly moving air surrounds the food to heat the outer portion quickly.

Convection Bake uses the convection system only.

Convection Roast uses the convection system in conjunction with microwaves to cook more quickly.

- The microwave oven cavity and door will become hot during the convection cycle. The use of oven mitts is recommended.
- Use the provided convection (short) rack.
- Do not cover turntable or convection rack with aluminum foil, as it interferes with the circulation of hot air.

- Do not use light plastic containers, plastic wrap or paper products. All ovenproof cookware or metal utensils can be used with the Convection Bake function. (Round pizza pans are excellent cooking utensils for many convection-only items.) Metal utensils cannot be used with the Convection Roast function.
- No special techniques are needed to adapt standard oven recipes to convection cooking, although some temperatures might need to be reduced, and some cooking times might need to be shortened.

---

## Convection Temperature Indicator

The ten bars in the bottom of the display represent the microwave oven's current and approaching temperature. Each bar corresponds to the temperature represented on each of the number pads, 1 through 0 (10).

The bar corresponding to the desired set temperature will flash. As the microwave oven heats, each bar will light as its corresponding temperature is reached. When the desired temperature is reached, the flashing bar will become solid. If the temperature of the microwave oven drops below the set temperature, the bar will flash until the microwave oven heats to the set temperature again.

For example, if the desired temperature is set at 375° (number pad 8), the eighth bar will flash. When the microwave oven reaches 100°, the first bar will light. When the microwave oven reaches 170°, the second bar will light, and so on, until the desired temperature is reached, and the eighth bar stops flashing and becomes solid.

---

## Convection Roast

The Convection Roast function shortens the cooking time for foods that normally require long periods of time to cook. It alternates between convection heat and microwave energy. Combination cooking also leaves meats juicy on the inside, and crispy on the outside.

- The microwave oven cavity and door will become hot during the Convection Roast cycle. The use of oven mitts is recommended.
- To avoid damage to the microwave oven, do not use metal cookware or utensils during the Convection Roast cycle. Use only ovenproof, microwave-safe cookware.
- Meats may be roasted directly on the convection rack. Use an ovenproof, microwave-safe pan to catch the drippings.
- Less tender cuts of beef can be roasted and tenderized using oven cooking bags.
- Check for doneness after cooking time has ended. If not completely done, let stand in microwave oven for a few minutes to complete cooking.

---

### Examples of Convection Roast Times

Pork roast, 2 lbs (907 g)	350°F for 50 min (about 22-23 min/lb)
Whole chicken, 4 lbs (1.8 kg) (giblet removed)	350°F for 1 hr, 10 min (about 18-20 min/lb)
Bone-in chicken pieces, 2 lbs (907 g)	325°F for 40 min

---

## To Use:

**NOTE:** The default temperature is 325°F (163°C), and the default roast time is one hour.

1. Arrange food on convection rack, place rack with food in a pan, then place the pan with the rack and food on the turntable and close the door.  
or  
Place food in a pan, place the pan on the convection rack, then place the rack with the pan and food on the turntable and close the door.
2. Touch CONVECTION ROAST.  
"325" will blink in the display. Touch the number pad that corresponds to the desired temperature, if other than 325° (163°C). Available temperatures are 170°F (77°C) through 375°F (191°C).  
If roasting for the default length of time of 1 hour, skip Step 3.
3. Touch COOK TIME.  
"H0:00" will appear in the display. Enter length of time to roast in hours and minutes.
4. Touch START.  
Convection Roast time will count down in the display.  
When the cycle ends, "End" will appear in the display, and the end-of-cycle tones will sound.
5. Touch STOP CANCEL or open the door to clear the display.

## Convection Bake

The Convection Bake function is ideal for baking items such as soufflés, breads, cookies, angel food cakes, pizza and casseroles.

- The microwave oven cavity and door will become hot during the Convection Bake cycle. The use of oven mitts is recommended.
- Use ovenproof bakeware. Metal bakeware may be used during the Convection Bake cycle.
- This microwave oven may be preheated in the same way that a standard oven is preheated. (Most recipes for baked goods call for preheating.)
- The default temperature is 350°F (177°C), and the default bake time is one hour.

### Examples of Convection Bake Times

Cookies	350°F for 10-13 min
Bread	350°F for 25-30 min
Frozen pizza, thin crust	400°F for 18-20 min
Frozen pizza, thick crust	400°F for 25 min

## To Use Without Preheat:

**NOTE:** The end-of-preheat tones will sound when the microwave oven has reached the desired temperature, but no action is required.

1. Place pan of food on the convection rack, then place the rack with the pan on the turntable and close the door.
2. Touch CONVECTION BAKE.  
"350" will blink in the display. Touch the number pad that corresponds to the desired temperature, if other than 350° (177°C).  
If baking for the default length of time of 1 hour, skip Step 3.
3. Touch COOK TIME.  
"H0:00" will appear in the display. Enter length of time to bake in hours and minutes.
4. Touch START.  
Convection Bake time will count down in the display.  
The end-of-preheat tones will sound during the countdown  
When the cycle ends, "End" will appear in the display, and the end-of-cycle tones will sound.
5. Touch STOP CANCEL or open the door to clear the display.

## To Use With Preheat:

1. Place the convection rack on the turntable and close the door.
2. Touch CONVECTION BAKE.  
"350" will blink in the display. Touch the number pad that corresponds to the desired temperature, if other than 350° (177°C).
3. Touch START.  
"H1:00" will appear in the display, and start counting down.  
When preheat temperature is reached, 2 tones will sound.
4. Place the pan of food on the convection rack, and close the door.  
If Convection Bake time remaining in the display is correct, skip Step 5.
5. Touch COOK TIME.  
"H0:00" will appear in the display. Enter length of time to bake in hours and minutes.
6. Touch START.  
Convection Bake time will count down in the display.  
When the cycle ends, "End" will appear in the display, and the end-of-cycle tones will sound.
7. Touch STOP CANCEL or open the door to clear the display.

## Defrost

- Unwrap foods and remove lids (for example, from fruit juice containers) before defrosting.
- Shallow packages will defrost more quickly than deep blocks.
- Separate food pieces as soon as possible during or at the end of the cycle for more even defrosting.
- Use small pieces of aluminum foil to shield parts of food such as chicken wings, leg tips and fish tails. See “Aluminum Foil and Metal” first.

The Defrost feature has preset times and cook powers for defrosting meat, poultry and fish by weight. It should not be used for food that has been left outside the freezer for more than 20 minutes, or for frozen ready-made food. Use the following chart as a guide.

FOODS	INSTRUCTIONS
Meat <i>Beef (ground, steaks, roast, stew)</i> <i>Lamb (stew and chops)</i> <i>Pork (chops, ribs, roasts, sausage)</i>	The narrow or fatty areas of irregular shaped cuts should be shielded with foil before defrosting. Do not defrost less than 1/4 lb (113 g) or two 4 oz (113 g) patties. Place all meats in microwave-safe baking dish. Do not cover.
Poultry <i>Chicken (whole and cut up)</i> <i>Cornish hens</i> <i>Turkey breast</i>	Place in microwave-safe baking dish, chicken breast side up. Do not cover.
Fish <i>Filletts</i> <i>Steaks</i> <i>Whole shellfish</i>	Place in microwave-safe baking dish. Do not cover.

### To Use Defrost:

1. Place food, uncovered, on the turntable and close the door.
  2. Touch DEFROST.  
Enter the weight in pounds.  
Weight can be set from 0.3 lb to 6.3 lbs (136 g to 2.86 kg).  
**NOTE:** Enter weight in grams if weight entry mode is set to metric. See “Weight Entry Mode” section.
  3. Touch START.  
The display will count down the defrost time.  
The cycle may be interrupted briefly to turn food, if necessary, by opening the door. Close the door and touch START to resume the cycle.  
When the cycle ends, “End” will appear in the display, and the end-of-cycle tones will sound.
  4. Touch STOP CANCEL or open the door to clear the display.
- To Defrost Manually:** Follow direction in “Manual Cooking” section, and use 30% cooking power. See “Microwave Cooking Power” chart.

---

# MICROWAVE OVEN CARE

---

## General Cleaning

**IMPORTANT:** Before cleaning, make sure all controls are off and the microwave oven is cool. Always follow label instructions on cleaning products.

Soap, water and a soft cloth or sponge are suggested unless otherwise noted.

---

### MICROWAVE OVEN CAVITY

---

To avoid damage to the microwave oven cavity, do not use soap-filled scouring pads, abrasive cleaners, steel-wool pads, gritty washcloths or some recycled paper towels.

To avoid damage to stainless steel models, rub in direction of grain.

The area where the microwave oven door and frame touch when closed should be kept clean.

#### Average soil

- Mild, nonabrasive soaps and detergents:  
Rinse with clean water and dry with soft, lint-free cloth.

#### Heavy soil

- Mild, nonabrasive soaps and detergents:  
Heat 1 cup (250 mL) of water for 2 to 5 minutes in microwave oven. Steam will soften soil. Rinse with clean water and dry with soft, lint-free cloth.

#### Odors

- Lemon juice or vinegar:  
Heat 1 cup (250 mL) of water with 1 tbs (15 mL) of either lemon juice or vinegar for 2 to 5 minutes in microwave oven.

#### Microwave Inlet Cover

To avoid arcing and microwave oven damage, the microwave inlet cover (see "Parts and Features") should be kept clean.

- Wipe with wet cloth.

---

### MICROWAVE OVEN DOOR AND EXTERIOR

---

The area where the microwave oven door and frame touch when closed should be kept clean.

- Mild, nonabrasive soaps and detergents:  
Rinse with clean water and dry with soft, lint-free cloth.
- Glass cleaner and paper towels or nonabrasive plastic scrubbing pad:  
Apply glass cleaner to towel, not directly to surface.

#### Stainless Steel (on some models)

To avoid damage to microwave oven door and exterior, do not use soap-filled scouring pads, abrasive cleaners, steel-wool pads, gritty washcloths or some paper towels. Rub in direction of grain.

- Stainless steel cleaner (not included):  
See "Assistance or Service" section to order.
- Liquid detergent or all-purpose cleaner:  
Rinse with clean water and dry with soft, lint-free cloth.
- Vinegar for hard water spots

---

### CONTROL PANEL

---

- Sponge or soft cloth and water:  
Dampen sponge with water and wipe panel. Dry with soft cloth.
- To avoid damage to the control panel, do not use chemical or abrasive cleansers.

---

### TURNTABLE

---

Replace turntable immediately after cleaning. Do not operate the microwave oven without the turntable in place.

- Mild cleanser and scouring pad
- Dishwasher

---

### CONVECTION and GRILL RACKS

---

Dishwasher cleaning is not recommended. To avoid damage to the convection and grill racks, do not use abrasive cleansers or scrubbers.

- Mild soap, water and washcloth

---

# TROUBLESHOOTING

Try the solutions suggested here first in order to avoid the cost of an unnecessary service call.

---

## Nothing will operate

---

- **Has a household fuse blown, or has a circuit breaker tripped?**  
Replace the fuse or reset the circuit breaker. If the problem continues, call an electrician.
- **Is the microwave oven wired properly?**  
See Installation Instructions provided with your microwave oven.

---

## Microwave oven will not operate

---

- **Is the magnetron working properly?**  
Try to heat 1 cup (250 mL) of cold water for 2 minutes at 100% cooking power. If water does not heat, try the steps in the bullets below. If microwave oven still does not operate, call for service. See "Assistance or Service" section.
- **Is the door completely closed?**  
Firmly close door.
- **Is a packaging spacer (on some models) attached to the inside of the door?**  
Remove packaging spacer, then firmly close door.
- **Is the electronic microwave oven control set correctly?**  
See "Microwave Oven Control" section.
- **Is the Control Lock set?**  
See "Control Lock" section.
- **Does "door" appear in the display?**  
Open and close the microwave oven door, and then touch START. See "Start" section.

---

## Microwave oven makes humming noise

---

- This is normal and occurs when the power supply in the magnetron cycles on.

---

## Microwave oven door looks wavy

---

- This is normal and will not affect performance.

---

## Turntable will not operate

---

- **Is the turntable properly in place?**  
Make sure turntable is correct side up and is sitting securely on the turntable support. See "Turntable" section.
- **Is the turntable support operating properly?**  
Remove turntable. Remove and clean turntable hub, support and rollers. Replace hub, support and turntable. Place 1 cup (250 mL) of water on the turntable, then restart microwave oven. If it still is not working, call for service. See "Assistance or Service" section. Do not operate the microwave oven without turntable and turntable support working properly.

---

## Turntable alternates rotation directions

---

- This is normal and depends on motor rotation at beginning of cycle.

---

## Display shows messages

---

- **Is the display showing "0:00"?**  
There has been a power failure or the Clock time has been turned off. See "Display" section to clear display. See "Clock" section to reset or turn on Clock.

---

## Display shows time countdown, but the microwave oven is not operating

---

- **Is the Timer in use?**  
See "Timer" section.

---

## Tones are not sounding

---

- **Are tones turned off?**  
See "Tones" section.

---

## Cooking times seem too long

---

- **Is the cooking power set properly?**  
See "Microwave Cooking Power" section.
- **Are large amounts of food being heated?**  
Larger amounts of food need longer cooking times.
- **Is the incoming voltage less than that specified in "Electrical Requirements?"**  
Have a qualified electrician check the electrical system in the home.

---

## Odor coming from microwave oven during convection and/or grill cooking

---

- This is normal for the first few convection and/or grill cycles. The odor will dissipate with repeated use.

---

## Interference with radio, TV, cordless phone, etc.

---

- **Is the microwave oven plugged into the same outlet?**  
Try a different outlet for the electronic device.
- **Is the radio or TV receiver near the microwave oven?**  
Move the receiver away from the microwave oven, or adjust the radio or TV antenna.
- **Are the microwave oven door and sealing surfaces clean?**  
Make sure these areas are clean.
- **Is the cordless phone frequency 2.4 GHz?**  
Some 2.4 GHz-based cordless phones and home wireless networks may experience static or noise while the microwave oven is on. Use a corded phone or a different frequency cordless phone, or avoid using these items during microwave oven operation.



# ASSISTANCE OR SERVICE

Before calling for assistance or service, please check "Troubleshooting." It may save you the cost of a service call. If you still need help, follow the instructions below.

When calling, please know the purchase date and the complete model and serial number of your appliance. This information will help us to better respond to your request.

## If you need replacement parts

If you need to order replacement parts, we recommend that you use only factory specified parts. These factory specified parts will fit right and work right because they are made with the same precision used to build every new KITCHENAID® appliance.

To locate factory specified parts in your area, call us or your nearest KitchenAid designated service center.

## In the U.S.A.

Call the KitchenAid Customer eXperience Center toll free: **1-800-422-1230** or visit our website at [www.kitchenaid.com](http://www.kitchenaid.com).

### Our consultants provide assistance with:

- Features and specifications on our full line of appliances.
- Installation information.
- Use and maintenance procedures.
- Accessory and repair parts sales.
- Specialized customer assistance (Spanish speaking, hearing impaired, limited vision, etc.).
- Referrals to local dealers, repair parts distributors and service companies. KitchenAid designated service technicians are trained to fulfill the product warranty and provide after-warranty service, anywhere in the United States.

To locate the KitchenAid designated service company in your area, you can also look in your telephone directory Yellow Pages.

### For further assistance

If you need further assistance, you can write to KitchenAid with any questions or concerns at:

KitchenAid Brand Home Appliances  
Customer eXperience Center  
553 Benson Road  
Benton Harbor, MI 49022-2692

Please include a daytime phone number in your correspondence.

## Replacement Parts

Glass Turntable  
Part Number W10451786

Turntable Support and Rollers  
Part Number W10605643

Turntable Hub  
Part Number W10605644

Convection Rack (short)  
Part Number W10605651

Grill Rack (tall)  
Part Number W10605652

## Cleaning Supplies

affresh® Kitchen Appliance  
Cleaner

Part Number W10355010

affresh® Stainless Steel  
Cleaner

Part Number W10355016

affresh® Stainless Steel Wipes  
Part Number W10355049

Heavy Duty Degreaser  
Part Number 31552A

## Built-In Kits

This countertop microwave oven can be built in by using one of the following trim kits\*. These kits are available from the dealer or can be ordered by kit model number. See "Assistance or Service" section for the toll-free number.

KIT SIZE	KIT MODEL NUMBERS/COLORS
27" (68.6 cm)	MKC2157AW / White MKC2157AB / Black MKC2157AS / Stainless
30" (76.2 cm)	MKC2150AW / White MKC2150AB / Black MKC2150AS / Stainless

\*The built-in trim kits can be installed over any (electric or gas) built-in wall oven, up to 30" (76.2 cm).

---

# KITCHENAID® COUNTERTOP MICROWAVE LIMITED WARRANTY

---

## ONE YEAR LIMITED WARRANTY

For one year from the original date of purchase, when this microwave is installed, operated and maintained according to instructions attached to or furnished with the product, KitchenAid brand of Whirlpool Corporation or Whirlpool Canada LP (hereafter "KitchenAid") will, at its sole option, either pay for factory specified parts and repair labor to correct defects in materials or workmanship or replace the product. If replaced, the unit will be covered by the remaining one-year limited warranty of the original unit. See service instructions below.

YOUR SOLE AND EXCLUSIVE REMEDY UNDER THE LIMITED WARRANTY SHALL BE PRODUCT REPAIR OR REPLACEMENT AT OUR DISCRETION AS PROVIDED HEREIN. Service must be provided by a KitchenAid designated service company. This limited warranty is valid in the United States or Canada and applies only when the microwave is used in the country in which it was purchased. This limited warranty is effective from the date of the original consumer purchase. Proof of original purchase date is required to obtain service or replacement under this limited warranty.

---

## ITEMS EXCLUDED FROM WARRANTY

1. Service calls to correct the installation of your microwave, to instruct you how to use your product, to replace or repair house fuses, reset circuit breakers or to correct house wiring or plumbing.
2. Service calls to repair or replace light bulbs. Consumable parts are excluded from warranty coverage.
3. In-home service. Your microwave must be shipped to a KitchenAid designated service company.
4. Repairs or replacement when your microwave is used for other than normal, single-family household use or when it is used in a manner contrary to published user or operator instructions and/or installation instructions.
5. Damage resulting from accident, alteration, misuse, abuse, fire, flood, acts of God, improper installation, installation not in accordance with electrical or plumbing codes, or use of consumables or cleaning products not approved by KitchenAid.
6. Cosmetic damage, including scratches, dents, chips or other damage to the finish of your microwave, unless such damage results from defects in materials or workmanship and is reported to KitchenAid within 30 days from the date of purchase.
7. Any food loss due to microwave product failure.
8. Repairs to parts or systems resulting from unauthorized modifications made to the appliance.
9. Microwaves with original model/serial numbers that have been removed, altered or cannot be easily determined. This warranty is void if the factory applied serial number has been altered or removed from your appliance.

**The cost of repair or replacement under these excluded circumstances shall be borne by the customer.**

---

**If you reside in the United States and your KitchenAid® Countertop Microwave should cease to operate within the first year of ownership:**

1. Call our Customer eXperience Center at **1-800-253-1301** (toll-free).
  2. Give the consultant your model, serial number and shipping address.
  3. The consultant will advise whether the microwave qualifies for repair or replacement.
  4. In the event of repair, you may be directed to forward the product to a KitchenAid designated service center. You are responsible for insurance and freight to the designated service center. Please include your name and address on a piece of paper, along with a copy of the proof of purchase (register receipt, charge slip, etc.). The microwave should be properly packaged to avoid damage in transit as we will not be responsible for any such damage.
  5. KitchenAid will return the repaired unit or, at our option, an identical or comparable microwave to your door free of charge.
- 

## DISCLAIMER OF IMPLIED WARRANTIES

IMPLIED WARRANTIES, INCLUDING ANY IMPLIED WARRANTY OF MERCHANTABILITY OR IMPLIED WARRANTY OF FITNESS FOR A PARTICULAR PURPOSE, ARE LIMITED TO ONE YEAR OR THE SHORTEST PERIOD ALLOWED BY LAW. Some states and provinces do not allow limitations on the duration of implied warranties of merchantability or fitness, so this limitation may not apply to you. This warranty gives you specific legal rights, and you also may have other rights that vary from state to state or province to province.

---

## LIMITATION OF REMEDIES; EXCLUSION OF INCIDENTAL AND CONSEQUENTIAL DAMAGES

YOUR SOLE AND EXCLUSIVE REMEDY UNDER THE LIMITED WARRANTY SHALL BE PRODUCT REPAIR OR REPLACEMENT AT OUR DISCRETION AS PROVIDED HEREIN. KITCHENAID SHALL NOT BE LIABLE FOR INCIDENTAL OR CONSEQUENTIAL DAMAGES. Some states and provinces do not allow the exclusion or limitation of incidental or consequential damages, so these limitations may not apply to you. This warranty gives you specific legal rights, and you also may have other rights that vary from state to state or province to province.

---

Outside the 50 United States and Canada, this warranty does not apply. Contact your authorized KitchenAid dealer to determine if another warranty applies.

If you need service, first see the "Troubleshooting" section of the Use & Care Guide. Additional help can be found by checking the "Assistance or Service" section or by calling KitchenAid. In the U.S.A. call **1-800-422-1230**. In Canada call **1-800-807-6777**. 9/12

---

**Keep this book and your sales slip together for future reference. You must provide proof of purchase or installation date for in-warranty service.**

Write down the following information about your major appliance to better help you obtain assistance or service if you ever need it. You will need to know your complete model number and serial number. You can find this information on the model and serial number label located on the product.

Dealer name \_\_\_\_\_

Address \_\_\_\_\_

Phone number \_\_\_\_\_

Model number \_\_\_\_\_

Serial number \_\_\_\_\_

Purchase date \_\_\_\_\_



## Free Manuals Download Website

<http://myh66.com>

<http://usermanuals.us>

<http://www.somanuals.com>

<http://www.4manuals.cc>

<http://www.manual-lib.com>

<http://www.404manual.com>

<http://www.luxmanual.com>

<http://aubethermostatmanual.com>

Golf course search by state

<http://golfingnear.com>

Email search by domain

<http://emailbydomain.com>

Auto manuals search

<http://auto.somanuals.com>

TV manuals search

<http://tv.somanuals.com>