

KitchenAid™

**LAUNDRY CENTER
WASHER • DRYER**

**ELECTRIC MODEL
KELC500T**

**GAS MODEL
KGLC500T**

USE & CARE GUIDE

CONTENTS

	Page		Page
Before Using Your Laundry Center	2	Other Dryer Instructions	14
Important Safety Instructions	3	Cycle Selection Chart	15
Parts and Features	4	Features	16
Ownership Registration	5	Drying Tips	17
Laundry Preparation	5	Lint Screen/Lint Removal	18
Starting Your Washer	6	Laundry Center Care and Cleaning	19
What Happens in Each Cycle	8	If You Need Service or Assistance	21
Other Washer Instructions	12	Warranty	Back Cover
Starting Your Dryer	13		

BEFORE USING YOUR LAUNDRY CENTER

YOU ARE RESPONSIBLE FOR MAKING SURE THAT YOUR LAUNDRY CENTER:

- Is installed by a qualified installer.
- Is properly maintained.
- Is properly installed and leveled in a well-ventilated room on a floor that can support the weight.*
- Is located in an area where the temperature is above 45°F (7°C).
- Is properly connected to fuel, water supply, drain, and exhaust systems.*
- Is used only for its intended function.
- Is not run where there may be explosive fumes.
- Is not used by children or anyone unable to operate it properly.

ALWAYS unplug the power supply cord or turn off electrical power before attempting to service the appliance. **Shut off the GAS VALVE** if yours is a gas dryer.

DO NOT machine wash glass fiber materials. Small particles can stick to fabrics washed in subsequent loads and cause skin irritation.

ALWAYS read and follow instructions on packages of detergent and laundry aids – especially warning and precautions.

ALWAYS shut off the gas valve before leaving on vacation.

NEVER store or use flammable fluids such as dry-cleaning solvents, gasoline, kerosene, etc. in or near your laundry center or any other appliance.

NEVER operate the dryer if...

- it is not working properly (i.e., too noisy, too hot).
- it is damaged.
- parts are missing (i.e., door, latch).
- lint screen is not in place.

***See the INSTALLATION INSTRUCTIONS for complete information.**

FOR YOUR SAFETY

IF YOU SMELL GAS:

1. OPEN THE WINDOWS.
2. DON'T TOUCH ELECTRICAL SWITCHES.
3. EXTINGUISH ANY OPEN FLAMES.
4. IMMEDIATELY CALL YOUR GAS SUPPLIERS.

FOR YOUR SAFETY

DO NOT STORE OR USE GAS-OILINE OR OTHER FLAMMABLE VAPORS OR FLUIDS, SUCH AS DRY-CLEANING SOLVENTS OR KEROSENE, IN OR NEAR YOUR DRYER OR ANY OTHER APPLIANCE.

IMPORTANT SAFETY INSTRUCTIONS

WARNING: To reduce the risk of fire, electric shock, or injury to persons when using your laundry center, follow basic precautions, including the following:

1. Read all instructions carefully for important information before using your appliance.
2. Your laundry center should be installed in an area protected from weather.
3. Your laundry center should be connected to the right kind of outlet, electrical supply and grounding. See the **INSTALLATION INSTRUCTIONS** for complete information.
4. **NEVER** wash articles in the laundry center that have been spotted, cleaned, washed or soaked in gasoline, wax, paint, or other flammable fluids. The fumes can create a **FIRE HAZARD** or **EXPLOSION**. **NEVER** add these materials to your washer or dryer, and **NEVER** use them near your laundry center. **ALWAYS** hand launder and air dry fabrics containing any of the above materials.
5. **NEVER** use heat to dry articles containing foam rubber or similarly textured rubber-like materials.
6. **NEVER** allow children to play on or in the laundry center. Close supervision is necessary when this or any appliance is used near children.
7. Before the appliance is removed for service or discarded, **ALWAYS** remove the doors to prevent accidental entrapment.
8. **WARNING: If hot water system has not been used for period of 2 weeks or more, hydrogen gas may build up in water heater and hot water pipes. HYDROGEN GAS IS EXPLOSIVE. If the hot water system has not been used for such a time period, turn on all hot water faucets and let the water flow from each for several minutes before using the washer. This will allow gases to escape. DO NOT smoke or use an open flame during this procedure.**
9. **DO NOT** tamper with controls.
10. **DO NOT** reach into the appliance if the tub, agitator or drum is moving or the basket is spinning. If the lid to the washer is opened while the basket is spinning, the basket will automatically stop in a few seconds.
11. **FIRE HAZARD** and **DAMAGE** to some materials can result from:
 - operating the dryer with the lint screen loose, damaged or missing.
 - allowing lint to build up inside the dryer and exhaust system. **The exhaust duct and interior of your dryer should be cleaned by a qualified technician at least once every two years.** See page 18 for lint removal instructions.
12. **DO NOT** let dust, lint, paper, rags, chemicals, etc. pile up around or under the dryer. **DO NOT** install against drapes or curtains. Keep area around the exhaust opening free of accumulation of lint, dust and dirt.
13. **DO NOT** install or perform any servicing unless you are qualified. Improper installation, repair, or servicing may result in personal **INJURY** or **FIRE HAZARD**.
14. In your dryer, **DO NOT** use fabric softeners or products to eliminate static unless recommended by the manufacturer of the fabric softener or product.
15. Clean the lint screen in your dryer before each load.

SAVE THESE INSTRUCTIONS

PARTS AND FEATURES

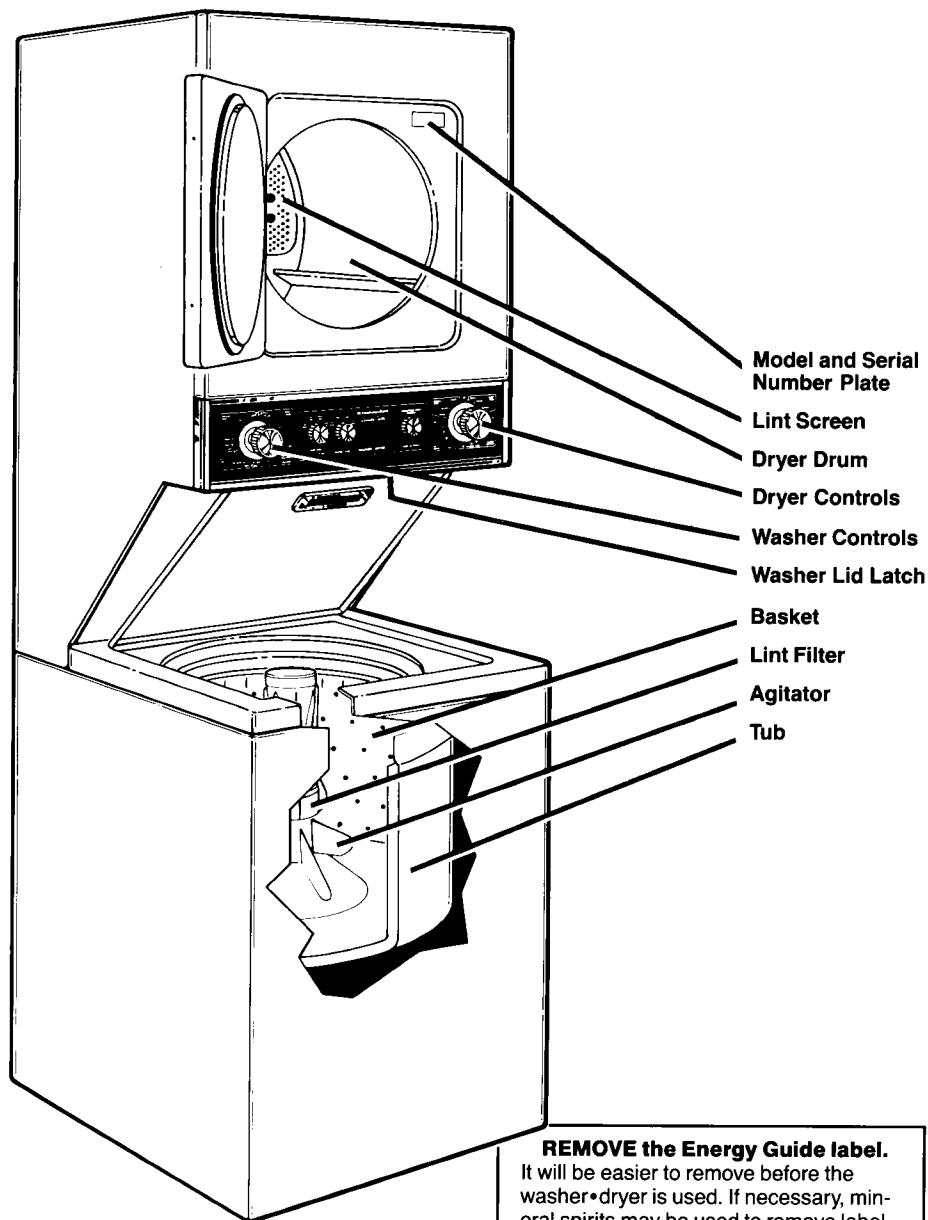

REMOVE the Energy Guide label.

It will be easier to remove before the washer-dryer is used. If necessary, mineral spirits may be used to remove label adhesive. Do not scrape adhesive from your washer-dryer or finish may be damaged.

You should wipe out the basket with a damp cloth before using to remove dust from storing or shipping.

OWNERSHIP REGISTRATION

Before using your laundry center, please fill out and mail your ownership registration card packed with the Use & Care Guide. This card will enable us to contact you in the unlikely event of a product safety notification and assist us in complying with the provisions of the Consumer Product Safety Act. THIS CARD DOES NOT VERIFY YOUR WARRANTY.

Keep a copy of the sale receipt showing the date of purchase. PROOF OF PURCHASE WILL ASSURE YOU OF IN-WARRANTY SERVICE.

Write down the following information. You will need it if your laundry center ever requires service.

Model Number* _____ Serial Number* _____

Date Purchased _____ Date Installed _____

Dealer's Name _____

Address _____

Phone _____

*Model and serial numbers are located on a label inside dryer door, near upper right edge of dryer opening.

LAUNDERING PREPARATION

For best washing and drying results, you must take some very important steps before, during and after each load:

1. Prepare and sort each load for washing. (See LAUNDRY CENTER GUIDE, pages 4-5.)
2. Measure and add detergent or soap to washer. (See LAUNDRY CENTER GUIDE, pages 9-10.)
3. Load the washer properly. (See LAUNDRY CENTER GUIDE, pages 6-7.)
4. Select the water temperature, load size and cycle recommended for the fabrics before starting the washer. (See pages 6-7 of this book.)
5. Add other laundry aids to the washer according to instructions. (See LAUNDRY CENTER GUIDE, pages 11-13.)
6. Properly sort the load for drying. (See LAUNDRY CENTER GUIDE, pages 18-19.)
7. Select the right drying cycle and time for the fabrics. (See pages 14-15 of this book.)
8. Remove and hang or fold items **immediately** after drying.

Service or performance problems caused by the use of any product not manufactured by KitchenAid, Inc. are the responsibility of the manufacturer of that product.

WARNING: To reduce the risk of fire, electric shock or injury to persons, read the **IMPORTANT SAFETY INSTRUCTIONS**, pages 2 to 3, before operating this appliance.

STARTING YOUR WASHER

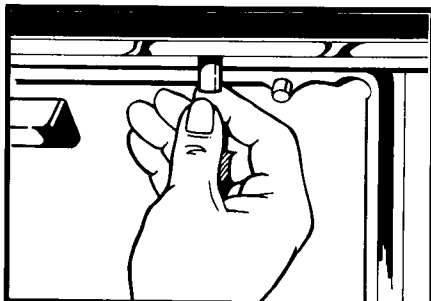

To hold the washer lid up, lift the lid until it snaps past the latch.

To release the lid, push the lid latch up.

1. Select a WATER LEVEL

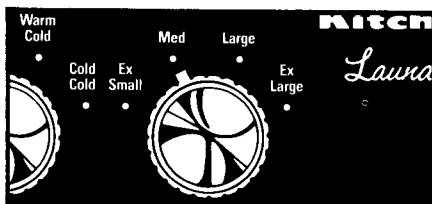

- Turn the knob to point to a setting that describes the size of load you want to wash.
- The water level can be set for EX SMALL, MEDIUM, LARGE or EX LARGE loads. Select the water level that matches the load size.

See your LAUNDRY CENTER GUIDE for details on load sizes.

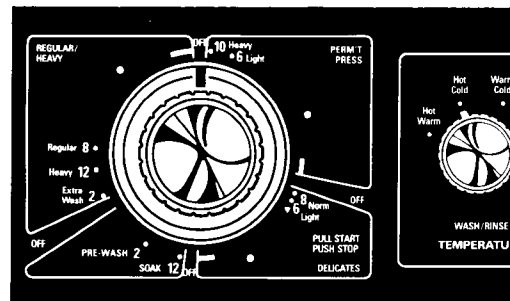

LOAD SIZES AND WATER LEVELS

CAUTION:
DO NOT OVERLOAD WASHER.

For best cleaning results, the load must be able to move freely in the water. Too big a load or too little water can cause wear or tearing of load items.

EX LARGE

(11.3 gal./42.7 L)*

LARGE

(9.4 gal./35.6 L)*

MEDIUM

(7.5 gal./28.4 L)*

EX SMALL

(5.6 gal./21.2 L)*

*Approximate fill with load.

2. Select WATER TEMPERATURES

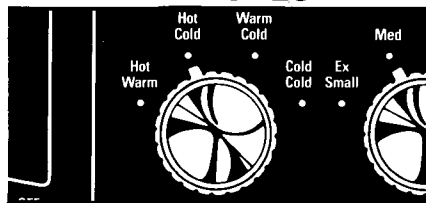

- Match the wash water temperature to the type of fabrics and soils being washed.
- This drawing shows a hot wash (top temperature) and a cold rinse (bottom temperature).

Recommended wash temperatures can be found in your LAUNDRY CENTER GUIDE.

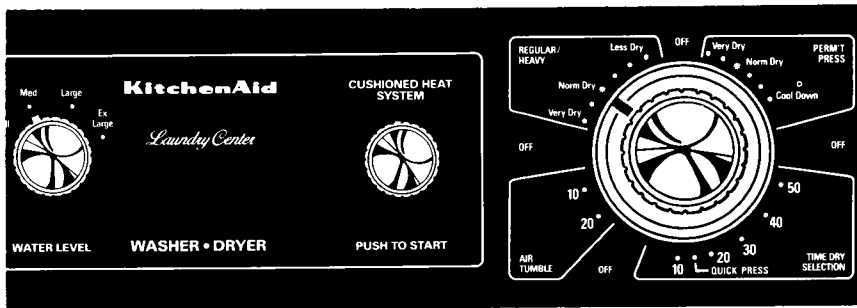

3. Select CYCLE and WASH TIME: Start the Washer

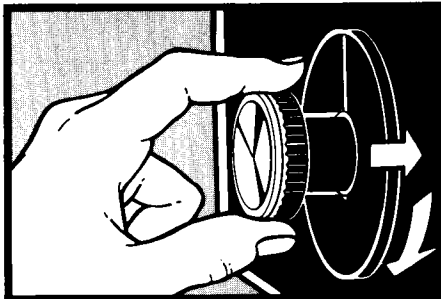

A. Push in the Control Knob and turn it to the right. It must be pushed in and turned only clockwise.

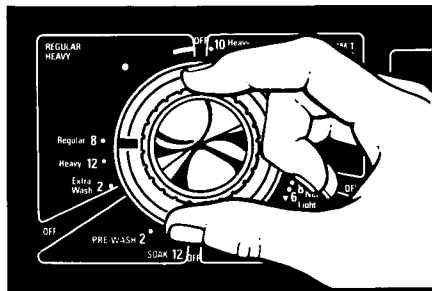

B. Stop on a number in the cycle you want. The numbers are minutes of wash time. The drawing shows 8 minutes of agitation in the REGULAR/HEAVY Cycle.

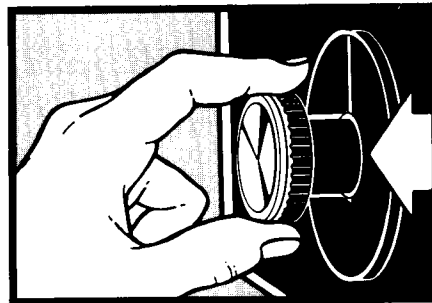

C. Start the washer by pulling out the Control Knob. The washer will fill to the level you set with wash water of the selected temperature. After filling, the washer will agitate for the selected number of minutes.

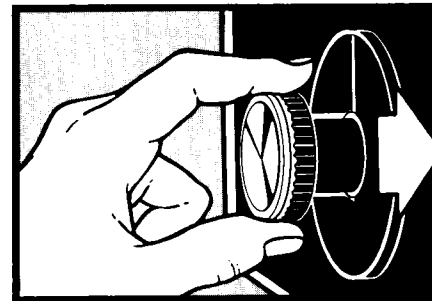

D. To stop the washer at any time, push in the Control Knob. To restart the washer, pull out the Control Knob.

WHAT HAPPENS IN EACH CYCLE

Each cycle has different agitation and spin speeds designed for different kinds of fabrics. Numbers on the dial in each cycle are the minutes of WASH agitation time.

When a Cycle Control Knob is set to a number and pulled out, the washer fills before agitation and timing starts. After agitation starts, the knob turns clockwise until it points to OFF and the cycle ends.

NOTE: You may hear the sound of water spraying during the spin part of some cycles. In some cycles, cold water is sprayed on the spinning load to help with the rinsing.

IMPORTANT: THE WASHER WILL PAUSE BRIEFLY THROUGHOUT EACH CYCLE. These pauses are normal. They allow for the reversing of the motor, normal washer operations, and the cool down portion of the PERMANENT PRESS Cycle.

EXTRA WASH Cycle



Use for washing heavily soiled loads that require maximum soil removal. **Double the recommended amount of detergent.**

FILL to Selected Level

WASH 2 Minutes, High Speed

PARTIAL DRAIN

After the PARTIAL DRAIN the washer automatically refills and goes into the REGULAR/HEAVY Cycle. **Be sure to use enough detergent for the double wash.**

REGULAR/HEAVY Cycle

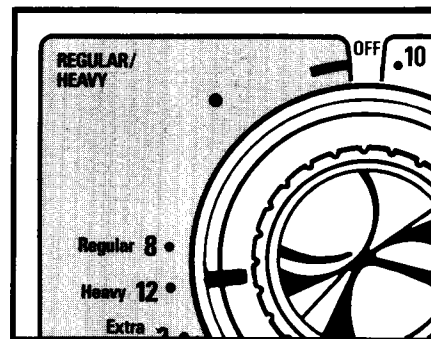

A cycle for sturdily constructed fabrics that are heavily to moderately soiled.

FILL to Selected Level

WASH 2 Minutes, High Speed

WASH 10 Minutes, Low Speed

DRAIN No Agitation

SPIN High Speed, 3 Spray Rinses

FILL for Deep Rinse

RINSE High Speed

RINSE Low Speed

DRAIN No Agitation

SPIN High Speed, 3 Spray Rinses

REGULAR Cycle

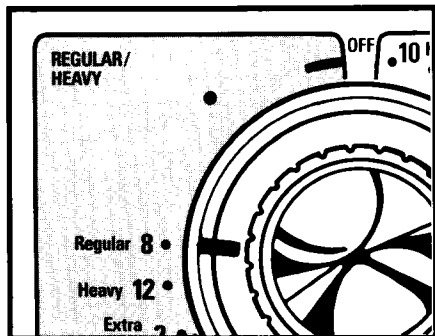

A cycle for regular loads of fabrics that are moderately to lightly soiled.

FILL to Selected Level

WASH 8 Minutes, Low Speed

DRAIN No Agitation

SPIN High Speed, 3 Spray Rinses

FILL for Deep Rinse

RINSE High Speed

RINSE Low Speed

DRAIN No Agitation

SPIN High Speed, 3 Spray Rinses

PERM'T PRESS HEAVY Cycle

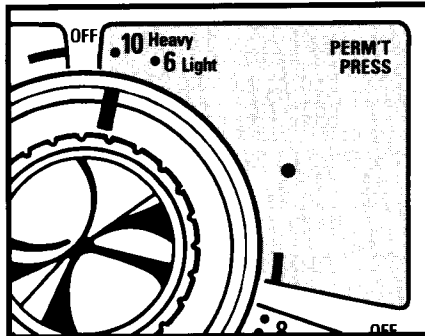

A cycle designed for permanent press and some synthetic fabrics that are moderately soiled. The **cool down** rinse helps keep wrinkles from setting into these fabrics.

FILL to Selected Level

WASH 2 Minutes, High Speed

WASH 8 Minutes, Low Speed

PARTIAL DRAIN (Pause)

REFILL – COOL DOWN

WASH Low Speed

DRAIN No Agitation

SPIN Low Speed, 3 Spray Rinses

FILL for Deep Rinse

RINSE Low Speed

DRAIN No Agitation

SPIN Low Speed

PERM'T PRESS LIGHT Cycle

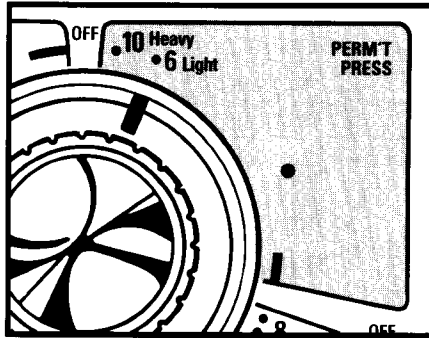

A cycle designed for lightly soiled permanent press and synthetic items. The **cool down** rinse helps keep wrinkles from setting into these fabrics.

FILL to Selected Level

WASH 6 Minutes, Low Speed

PARTIAL DRAIN (Pause)

REFILL – COOL DOWN

WASH Low Speed

DRAIN No Agitation

SPIN Low Speed, 3 Spray Rinses

FILL for Deep Rinse

RINSE Low Speed

DRAIN No Agitation

SPIN Low Speed

DELICATES NORMAL Cycle

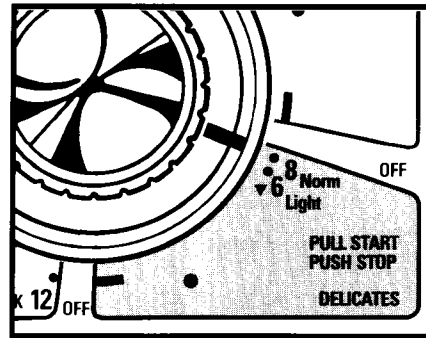

A cycle that gently washes and spins moderately soiled delicate items.

FILL to Selected Level

WASH 4 Minutes, Low Speed

▼ **SOAK** 2 Minutes (Pause)

WASH 2 Minutes, Low Speed

DRAIN No Agitation

SPIN Low Speed, 3 Spray Rinses

FILL for Deep Rinse

RINSE Low Speed

DRAIN No Agitation

SPIN Low Speed

▼ **Indicates the machine is pausing for a brief soak period.**

DELICATES LIGHT Cycle

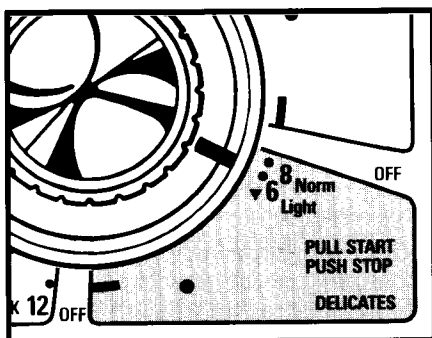

A cycle that gently washes and spins lightly soiled delicate items.

FILL to Selected Level

WASH 2 Minutes, Low Speed

▼ **SOAK** 2 Minutes (Pause)

WASH 2 Minutes, Low Speed

DRAIN No Agitation

SPIN Low Speed, 3 Spray Rinses

FILL for Deep Rinse

RINSE Low Speed

DRAIN No Agitation

SPIN Low Speed

▼ Indicates the machine is pausing for a brief soak period.

SOAK and PRE-WASH Cycles

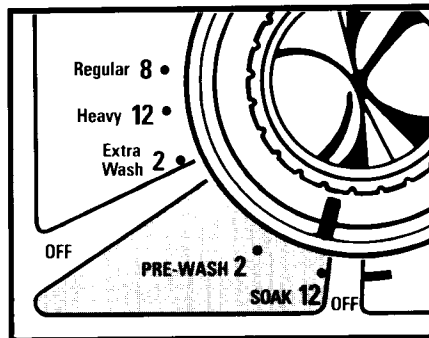

Brief periods of agitation and soak time help remove heavy soils and certain stains that need extra pretreatment. Use recommended amount of detergent or pre-soak additive. **The Soak cycle should always be followed by Wash cycle.**

FILL to Selected Level

WASH 2 Minutes, High Speed

SOAK 8 Minutes, No Agitation

Pre-Wash setting begins here, (see page 12).

WASH 2 Minutes, High Speed

DRAIN No Agitation

SPIN High Speed

Special care is needed when soaking or pre-washing laundry. **See your LAUNDRY GUIDE for proper use of this cycle.**

OTHER WASHER INSTRUCTIONS

Rinse and Spin

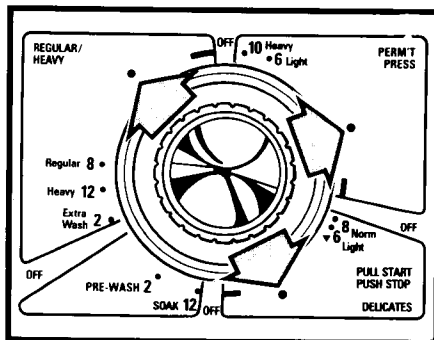

You may need extra rinse and spin for heavily soiled loads which need more detergent. (Extra detergent can require an extra rinse.)

1. Push Control Knob in.
2. Turn clockwise to any ● on the dial. **See above drawing.**
3. Pull Control Knob out.
4. The washer will fill to selected level; agitate 2 minutes; drain and spin.

Drain and Spin

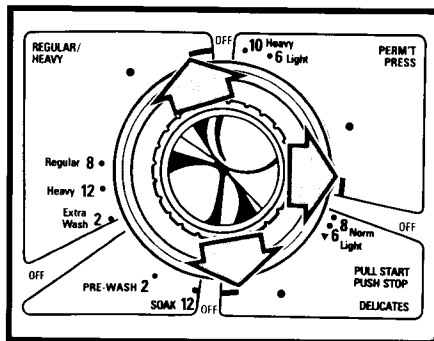

Your washer can be set to drain and spin out water.

1. Push Control Knob in.
2. Turn clockwise to the bar just before OFF. **See above drawing.**
3. Pull Control Knob out.
4. The washer will drain and spin.

For agitation and spin speeds in each cycle, see pages 8-11.

12

Soak or Pre-Wash

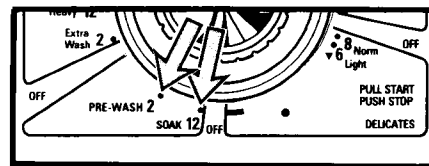

For best results, use **warm** water for soaking or pre-washing stained laundry. **Hot water can set stains.**

1. Use recommended amount of detergent or presoak product.
2. Push Control Knob in.
3. Turn clockwise to point to a **number** in the SOAK or PRE-WASH cycle.
4. Pull Control Knob out to start washer.
5. When the cycle is over, add detergent for the next selected wash cycle. **The SOAK Cycle should always be followed by a Wash Cycle.**

Important: See additional care information on page 7 of your LAUNDRY GUIDE.

Cleaning the Lint Filter

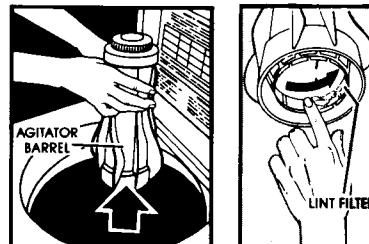

Clean filter after every load for best filtering results. **NOTE:** The load type will vary the amount of lint build-up.

To clean:

1. Lift off the agitator barrel.
2. Wash or wipe the filter clean in the bottom of the agitator barrel. **The filter is not removable.**
3. Replace the agitator barrel and snap into place.

STARTING YOUR DRYER

Before starting your dryer, be sure laundry is sorted and loaded properly. (See your LAUNDRY CENTER GUIDE.) **Be sure the door is tightly closed.**

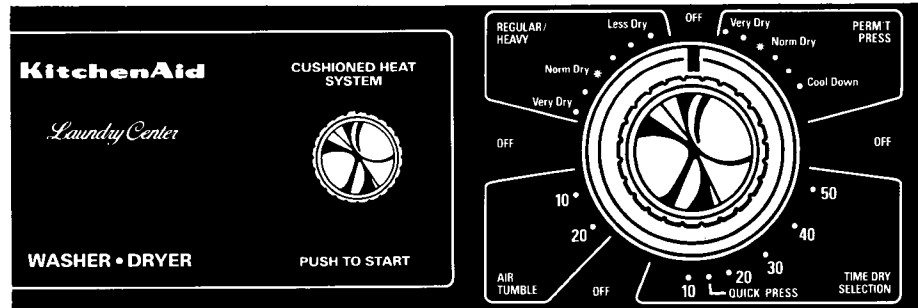

1. Select a CYCLE or TIME

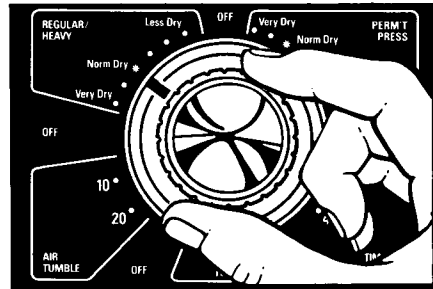

Turn the Control Knob either way to point to the amount of drying you want in a desired cycle.

In **REGULAR/HEAVY** and **PERM'T PRESS** cycles, choose the setting that best describes the level of dryness you desire for the load.

In **AIR TUMBLE** and **TIME DRY**, choose the length of time you wish to dry the load. See **CYCLE SELECTION CHART**, page 15.

2. Push the START Button

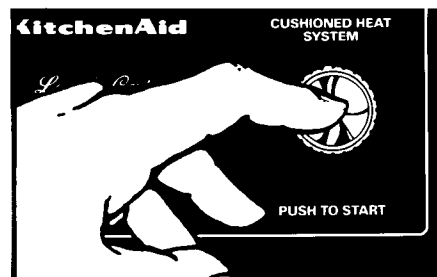

The dryer will start tumbling when you push the **START** Button.

3. To Stop and Restart the Dryer

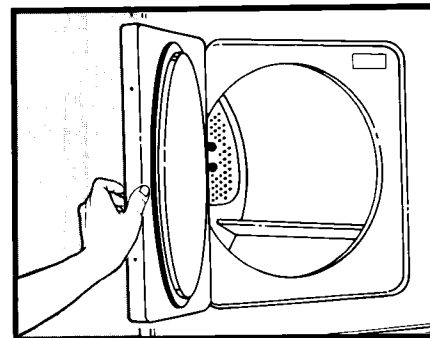

To stop, open the door (or turn the Control Knob to **OFF**).

To restart, close the door and push the **START** Button.

4. Changing a Setting

The setting can be changed at any time by turning the Control Knob to a new setting.

The Cycle Control Knob should point to OFF when the dryer is not in use.

OTHER DRYER INSTRUCTIONS

The Automatic Cycles

The automatic cycles allow you to select the degree of dryness you prefer for the clothes being dried.

The Control Knob will not move until the clothes load is almost dry or the COOL-DOWN portion of the cycle has been reached. After COOL-DOWN, knob automatically moves to an OFF area and tumbling stops.

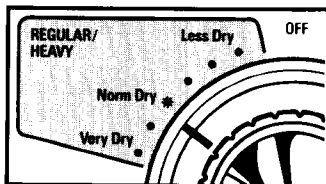

Use AUTOMATIC REGULAR/HEAVY to dry heavy and medium-weight cotton items. **The load tumbles without heat during the last 5 minutes.** This helps make the load easier to handle.

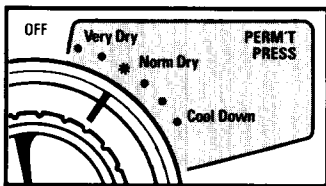

Use AUTOMATIC PERM'T PRESS to dry permanent press, knits and other synthetic fabrics. **The load tumbles without heat during the last 10 minutes.** This helps keep wrinkles from setting in and makes the load easier to handle.

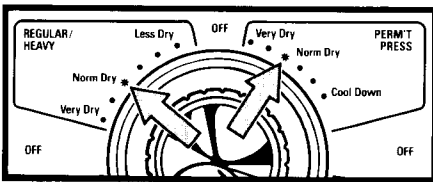

For the first few loads, set the Control Knob to point to the * in either automatic cycle. When the dryer stops, feel the dried items.

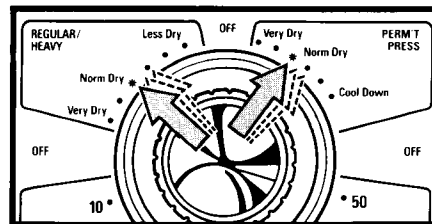

- If items are drier than you like, use a setting to the right of the * the next time you dry a similar load.

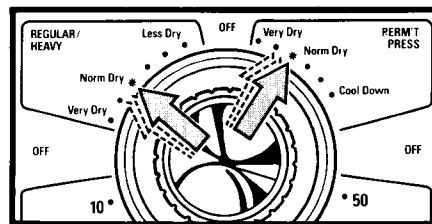

- If items are not as dry as you like, use a setting to the left of the * the next time you dry a similar load.

OVERDRYING CAN CAUSE SHRINKAGE, STATIC CLING AND DAMAGE TO SOME FABRICS.

TIME DRY

Use the TIME DRY Cycle for any load you want to dry by time. For example: small loads, large bulky items, items to be fluffed or dusted.

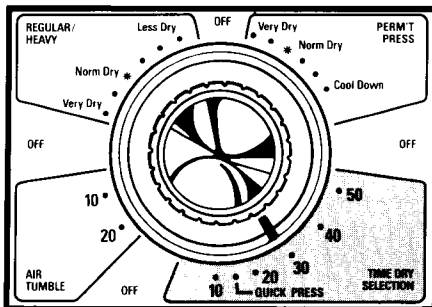

1. Turn the Control Knob to the number of minutes you want – from 10 to 50.
2. The last 5 minutes of this cycle are without heat – a cool down time. This helps make the load easier to handle.

CYCLE SELECTION CHART

This chart suggests fabric loads and cycle selections.

TYPE OF LOAD	SUGGESTED CYCLE
Cottons and Linens	
EXTRA HEAVY – Bedspreads, mattress pads, quilts	AUTOMATIC REGULAR/ HEAVY
HEAVYWEIGHT FABRICS – Towels, jeans, corduroys, work clothes	
MEDIUMWEIGHT COTTONS – Sheets, pillowcases, cotton underwear, diapers	
LIGHTWEIGHT COTTONS – Batistes, organdies, lingerie	
Permanent Press, Synthetics and Blends	
HEAVYWEIGHT FABRICS – Work clothes, jackets, raincoats	AUTOMATIC PERM'T PRESS
MEDIUMWEIGHT FABRICS – Shirts, play clothes, sheets, slacks	
LIGHTWEIGHT FABRICS – Lingerie, blouses, dresses . . .	
Knits	
HEAVYWEIGHT – Cottons, rayons, blends, T-shirts, slacks, shirts	AUTOMATIC PERM'T PRESS
LIGHTWEIGHT – Synthetics (polyester, acrylic, etc.) and blends, lingerie, blouses, dresses	
Lightweight and Delicate Fabrics	
Sheer curtains (2 or 3 panels)	AUTOMATIC PERM'T PRESS
Gauze, lace, etc.	
Rubber, Plastic, Heat Sensitive Fabrics	
FOAM RUBBER – Pillows, bras, stuffed toys	AIR TUMBLE 20 Min
PLASTIC – Shower curtains, tablecloths	20 Min
OLEFIN, POLYPROPYLENE, SHEER NYLON	15-20 Min
<i>WARNING: Drying heat sensitive materials with heat can damage them or be a FIRE HAZARD.</i>	

FEATURES

AIR TUMBLE Setting

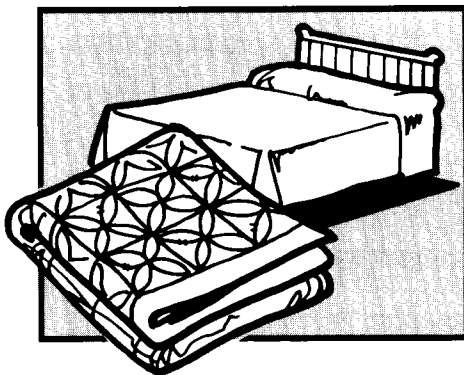

The dryer does not heat when the Control Knob is set on AIR TUMBLE. This setting can be used to fluff bedding, plastic tablecloths, foam rubber pillows, stuffed toys and sneakers.

QUICK PRESS Setting

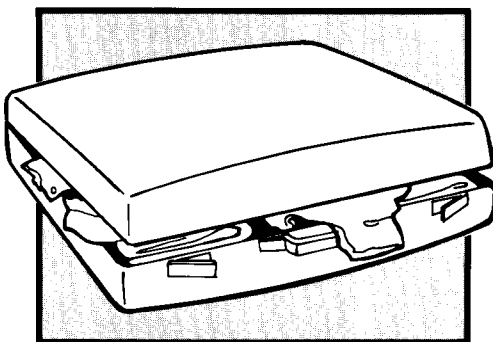

The QUICK PRESS setting removes wrinkles from dry clothing such as items that may have been packed in a suitcase, closet, or items not removed from the dryer.

The load will tumble in heated air 10 minutes. The heat shuts off and the dryer continues to tumble the load for 5 more minutes.

For best results, QUICK PRESS only a few items at a time. Put them on hangers or fold as soon as the dryer stops.

CYCLE SENTRY Signal

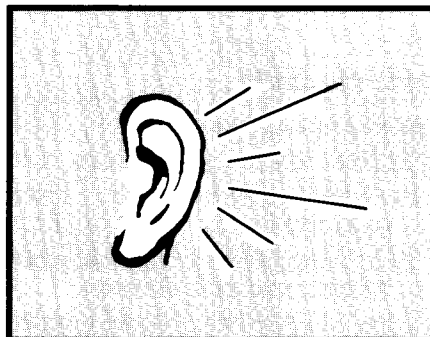

The dryer sounds a signal to let you know when the cycle is finished. The signal is automatic with a non-adjustable volume.

The signal is helpful when you are drying permanent press, synthetics and other items that should be taken out as soon as the dryer stops.

Cushioned Heat

The dryer automatically reduces the heat settings in the REGULAR/HEAVY and PERM'T PRESS cycles. During the last few minutes of each cycle with reduced heat, the dryer temperature gradually reduces to a lower setting. **COOL-DOWN takes over automatically after Cushioned Heat is finished.** This helps prevent overdrying.

Cool Down

In all cycles except for AIR TUMBLE, the heat shuts off 10 minutes before the dryer stops tumbling. This cool down time helps to:

- Keep wrinkles from setting in.
- Make handling of hot load items easier.

DRYING TIPS

Mixed Loads

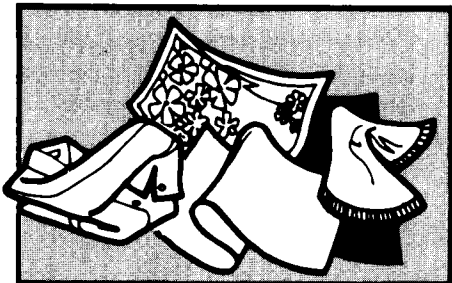

When drying a load with different kinds and weights of fabrics, use the cycle suggested for lightest fabrics.

NOTE: Overdrying can cause shrinkage, static cling and damage to some fabrics.

To help reduce wrinkling, take the load from the dryer as soon as tumbling stops. This is very important for permanent press, knits and synthetic fabrics.

Drying Times

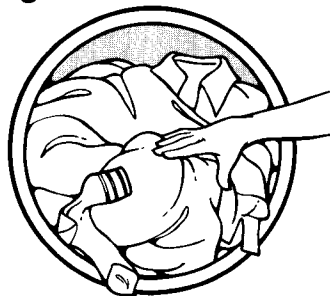

Drying times will vary depending on one or more of the following:

- Amount of moisture in the clothes.
- Type and weight of the fabric.
- Size of the load.
- Room temperature around the dryer.
- Temperature of the wash/rinse water.
- Amount of lint in the lint screen.
- Dryer temperature selection.

See your LAUNDRY GUIDE for more information.

LINT SCREEN

Clean the lint screen before each load. A screen blocked by lint can increase drying time and may be a FIRE HAZARD.

The lint screen is inside the dryer drum, on the back wall.

WARNING: DO NOT run the dryer with the lint screen loose, damaged, blocked or missing. Doing so can cause overheating, can damage fabrics and can be a FIRE HAZARD.

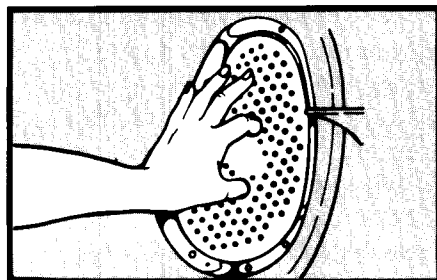

1. Grasp the lint screen by the finger holes and pull straight out.

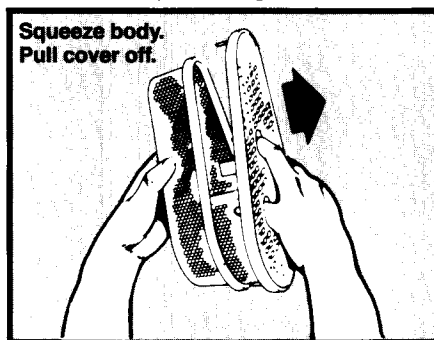

2. Lightly squeeze the body, as shown, while pulling the cover off.
3. **ROLL** lint off the screen with your fingers. **Do not rinse or wash the screen. Wet lint is hard to remove.**

LINT REMOVAL

Lint can gather inside the dryer and create a fire hazard. **This lint should be removed at least every 2 years, or more often, depending on dryer usage.**

WARNING:

- **Avoid electrical shock hazard. Unplug the power supply cord or turn off the electrical power at the circuit breaker or fuse box.**
- **Avoid injury or damage. Do not put hands inside the cabinet.**
- **Avoid burn injury. Make sure the dryer is cool.**

ELECTRIC DRYER

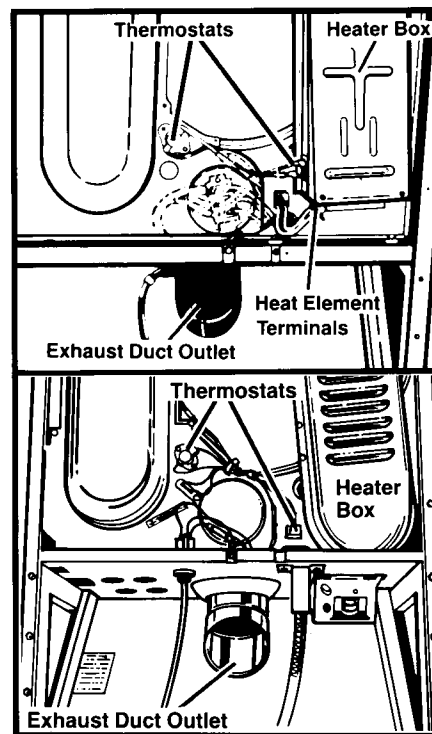

GAS DRYER

Cleaning should be done by a qualified person.

1. Remove back panel from dryer.
2. Avoid damaging wires, terminals, thermostats and heater box.
3. Remove lint from shaded area with a soft brush or vacuum cleaner.
4. Replace panel, reconnect the exhaust duct and level the washer/dryer.

LAUNDRY CENTER CARE AND CLEANING

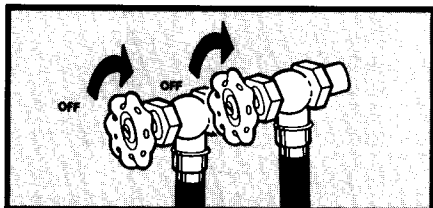

WHEN NOT WASHING, keep both water faucets turned off. This takes the pressure off the water inlet valve and hoses.

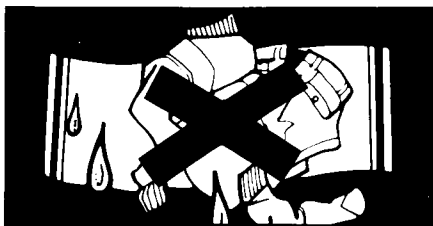

NEVER USE THE WASHER TO:

- Store wet or dry laundry.
- Soak more than 2 hours.
- Soak with chlorine bleach.
- Soak with vinegar or other acids.
- Soak or store urine soaked clothes.

Any of the above uses may result in damage to clothing and the porcelain wash tub.

NEVER leave wet or damp laundry in your dryer. Clothes may become damaged.

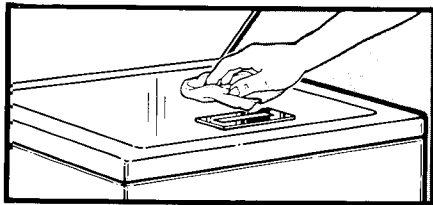

AFTER WASHING, use a soft dry cloth to wipe the outside and inside dry. Leave washer lid up until the basket is dry. **Wipe up all spills.** Spills allowed to remain may dull or damage the finish.

REMOVE LOOSE, SHARP AND HEAVY OBJECTS such as pins, buckles, bolts, nuts, etc. from clothing before washing or drying. Close metal zippers. **NEVER** put these items in or on the washer or dryer.

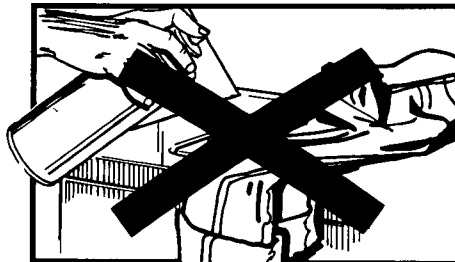

SOME PRETREATMENT PRODUCTS can damage the washer/dryer dials, consoles and finish. Do not use these products on or near your washer or dryer.

Cleaning the Dryer Interior

WARNING: Before cleaning interior, unplug power supply cord or turn off electrical power at the circuit breaker or fuse box to avoid electrical hazard.

Garments which contain unstable dyes, such as denim blue jeans or brightly colored cotton items, may discolor the dryer interior. If the interior is discolored, clean with one of the following methods to avoid staining later load items.

Powdered laundry detergent and very warm water

Make a paste with detergent and very warm water. Apply paste to a soft cloth and scrub area until all excess dye is removed. Wipe thoroughly with a damp cloth. Tumble a load of rags. – **OR** –

Liquid spray household cleaner

Spray on stained area. Rub with a cloth until all excess dye is removed. Tumble a load of rags.

Vacation Care

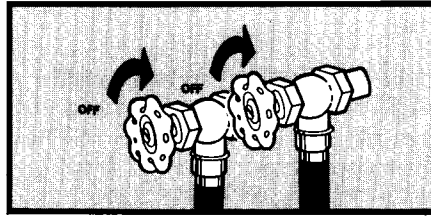

1. Turn off both water faucets to take pressure off inlet valves and hoses.
2. Unplug power supply cord or turn off electrical power.
3. Clean the washer lint filter and the dryer lint screen.

Winterizing

Because some water stays in the washer, freezing can cause a lot of damage. If the washer/dryer is **stored or moved** during the cold weather:

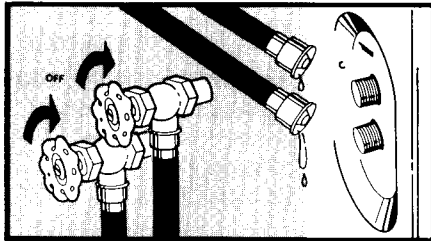

1. Shut off both water faucets. Disconnect and drain water inlet hoses.

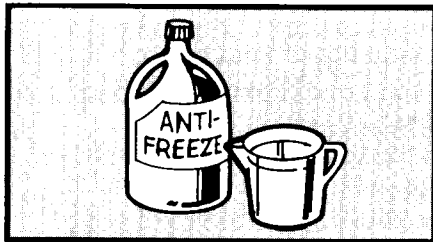

2. Put a quart of R.V. or automobile-type antifreeze in the basket.

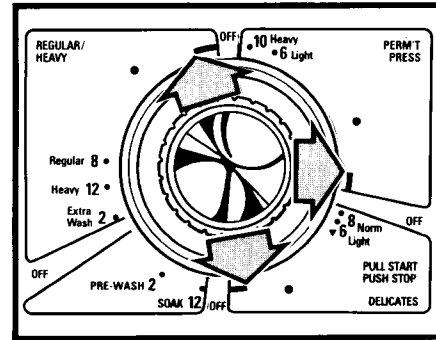

3. Run washer on a DRAIN and SPIN setting, (see page 12). Let it run about 30 seconds to mix the antifreeze and water, then shut it off.

To Use the Washer Again:

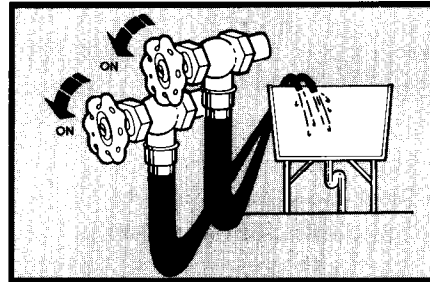

1. Flush the water pipes and hoses.
2. Connect water inlet hoses.
3. Turn on both water faucets.

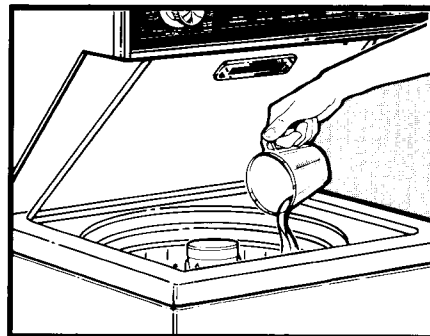

4. Run the washer through a complete cycle with one cup of detergent to clean out the antifreeze.

IF YOU NEED SERVICE OR ASSISTANCE



Follow These Steps

1. If your laundry center should fail to operate, review the following list before calling your dealer. You could save the cost of a service call.

If your washer does not fill:

- Is the power supply cord plugged into a live circuit with the proper voltage?
- Are both water faucets open?

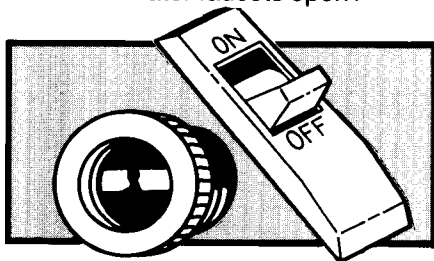

- Have you checked your home's main fuses or circuit breaker box?
- Are the water supply hoses kinked?
- Is the Cycle Control Knob set and pulled out?

If your washer does not spin:

- Is the lid closed?
- Is the power supply cord plugged into a live circuit with the proper voltage?
- Have you checked your home's main fuses or circuit breaker box?

If your washer drains at the wrong time:

- The drain hose should be at least 28 inches above the floor and secured.
- The drain hose should not fit tightly in the drain pipe.

- Make sure that the Cycle Control Knob is pointing to a number in the cycle.

Make sure the drain hose is higher than the water level in the washer.

If it isn't:

- The washer may seem to be draining during wash and rinse cycles.
- Water can siphon out. (See INSTALLATION INSTRUCTIONS.)

If your washer stops during the permanent press cycle:

- Remember, the washer will stop for about 2 minutes after the partial drain during the cool-down period in this cycle.

If your dryer does not run or heat:

- Is the power supply cord plugged into a live circuit with the proper voltage?
- Is the door closed tightly?
- Did you push the START Button?
- Have you checked your home's main fuse or circuit breaker box?
- The AIR TUMBLE setting is without heat.
- The last minutes of heat settings are without heat. See page 14.

If drying times seem too long:

- Is the lint screen clean?
- Is the load too large?
- Is the room temperature cold?
- See page 16 of this book and page 19 of your LAUNDRY CENTER GUIDE.

2. If the problem is not due to one of the above items, first call your dealer or repair service he recommends.

- All service should be handled locally by the dealer from whom you purchased the unit or an authorized KitchenAid servicer.

3. In the event you are unable to obtain the name of a local authorized KitchenAid servicer, call KitchenAid Customer Relations TOLL-FREE: 800-422-1230.

- A Customer Relations representative can recommend a qualified service company in your area.

If you must call or write, please provide: Model Number, Serial Number, Date of Purchase and complete description of the problem.

Write to:

Customer Relations Department
KitchenAid, Inc.
P.O. Box 558
St. Joseph, MI 49085-0558

4. If you are not satisfied with the action taken, contact the Major Appliance Consumer Action Panel (MACAP). MACAP is a group of independent consumer experts that voices consumer views at the highest levels of the major appliance industry. Contact them only when the dealer, authorized servicer or KitchenAid, Inc., have failed to resolve your problem.

Major Appliance Consumer
Action Panel
20 North Wacker Drive
Chicago, Illinois 60606

MACAP will in turn inform us of your action.

KitchenAidTM

LAUNDRY CENTER WARRANTY

LENGTH OF WARRANTY:	KITCHENAID WILL PAY FOR:	KITCHENAID WILL NOT PAY FOR:
ONE YEAR FULL WARRANTY FROM DATE OF PURCHASE.	Replacement parts and repair labor to correct defects in materials or workmanship. Service must be provided by an authorized KitchenAid servicing outlet.	<p>A. Service calls to:</p> <ol style="list-style-type: none"> 1. Correct the installation of the washer/dryer. 2. Instruct you how to use the washer/dryer. 3. Replace house fuses or correct house wiring. 4. Correct house plumbing.
FIVE YEAR LIMITED WARRANTY ONE YEAR FULL PLUS SECOND THROUGH FIFTH YEAR LIMITED FROM DATE OF PURCHASE.	Replacement parts for any dryer electric element on electric models or burner on gas models if defective in materials or workmanship. Rust-through protection on cabinet assembly.	<p>B. Repairs when washer/dryer is used in other than normal home use.</p> <p>C. Damage resulting from accident, alteration, misuse, abuse, improper installation or installation not in accordance with local electrical or plumbing codes.</p>
TEN YEAR LIMITED WARRANTY ONE YEAR FULL PLUS SECOND THROUGH TENTH YEAR LIMITED FROM DATE OF PURCHASE.	<p>Replacement parts for any part of the washer gearcase assembly if defective in materials or workmanship.</p> <p>Replacement of the washer outer tub should it fail to contain water due to defective materials or workmanship.</p> <p>Replacement of the dryer drum if it rusts through due to defective materials or workmanship.</p>	<p>D. Any labor costs during the limited warranties.</p> <p>E. Replacement parts or repair labor costs for units operated outside the United States.</p> <p>F. Pickup and delivery. This product is designed to be repaired in the home.</p>

KITCHENAID, INC. DOES NOT ASSUME ANY RESPONSIBILITY FOR INCIDENTAL OR CONSEQUENTIAL DAMAGES. Some states do not allow the exclusion or limitation of incidental or consequential damages, so this exclusion or limitation may not apply to you.

This warranty gives you specific legal rights and you may also have other rights which vary from state to state.

KitchenAid, Inc.

Part No. 3387331

St. Joseph, Michigan, USA 49085

(W1287)

Free Manuals Download Website

<http://myh66.com>

<http://usermanuals.us>

<http://www.somanuals.com>

<http://www.4manuals.cc>

<http://www.manual-lib.com>

<http://www.404manual.com>

<http://www.luxmanual.com>

<http://aubethermostatmanual.com>

Golf course search by state

<http://golfingnear.com>

Email search by domain

<http://emailbydomain.com>

Auto manuals search

<http://auto.somanuals.com>

TV manuals search

<http://tv.somanuals.com>