

DN530

Creative Quad Gate

Operator Manual

Klark Teknik,
Klark Industrial Park,
Walter Nash Road,
Kidderminster.
Worcestershire.
DY11 7HJ.
England.

Tel: +44 1562 741515
Fax: +44 1562 745371

Email: info@midasklarktechnik.com
Website: www.klarktechnik.com

DN530 Creative Quad Gate — Operator Manual
DOC02-DN530 Issue B — February 2010
© Red Chip Company Ltd.

In line with the company's policy of continual improvement, specifications and function may be subject to change without notice. This Operator Manual was correct at the time of writing. E&OE.



IMPORTANT SAFETY INSTRUCTIONS



The lightning flash with arrowhead symbol within an equilateral triangle is intended to alert the user to the presence of uninsulated "dangerous voltage" within the product's enclosure that may be of sufficient magnitude to constitute a risk of electric shock to persons.



The exclamation point within an equilateral triangle is intended to alert the user to the presence of important operating and maintenance (servicing) instructions in the literature accompanying the product.

- 1** Read these instructions.
- 2** Keep these instructions.
- 3** Heed all warnings.
- 4** Follow all instructions.
- 5** Do not use this apparatus near water.
- 6** Clean only with a dry cloth.
- 7** Do not block any of the ventilation openings. Install in accordance with the manufacturer's instructions.
- 8** Do not install near any heat sources such as radiators, heat registers, stoves, or other apparatus (including amplifiers) that produce heat.
- 9** Do not defeat the safety purpose of the polarized or grounding-type plug. A polarized plug has two blades with one wider than the other. A grounding type plug has two blades and a third grounding prong. The wide blade or the third prong are provided for your safety. If the provided plug does not fit into your outlet, consult an electrician for replacement of the obsolete outlet.
- 10** Protect the power cord from being walked on or pinched particularly at plugs, convenience receptacles and the point where they exit from the apparatus.
- 11** Only use attachments/accessories specified by the manufacturer.
- 12** Unplug this apparatus during lightning storms or when unused for long periods of time.
- 13** Refer all servicing to qualified personnel. Servicing is required when the apparatus has been damaged in any way, such as power-supply cord or plug is damaged, liquid has been spilled or objects have fallen into the apparatus, the apparatus has been exposed to rain or moisture, does not operate normally, or has been dropped.
- 14** Use the mains plug to disconnect the apparatus from the mains.
- 15** **Warning: To reduce the risk of fire or electric shock, do not expose this apparatus to rain or moisture.**
- 16** **Warning: Do not expose this equipment to dripping or splashing and ensure that no objects filled with liquids, such as vases, are placed on the equipment.**
- 17** **Warning: The mains plug of the power supply cord shall remain readily operable.**

INSTRUCTIONS DE SÉCURITÉ IMPORTANTES



Le symbole représentant un éclair fléché dans un triangle équilatéral a pour but d'alerter l'utilisateur de la présence d'une "tension dangereuse" non isolée à l'intérieur du boîtier, pouvant être d'une force suffisante pour constituer un risque d'électrocution.



Le point d'exclamation dans un triangle équilatéral a pour but d'alerter l'utilisateur de la présence d'instructions importantes concernant le fonctionnement et la maintenance, dans la documentation qui accompagne l'appareil.

- 1 Veuillez lire ces instructions.
- 2 Conservez ces instructions.
- 3 Respectez toutes les consignes de sécurité.
- 4 Suivez scrupuleusement toutes les instructions.
- 5 N'utilisez pas cet appareil près d'un point d'eau.
- 6 Utilisez uniquement un chiffon sec pour le nettoyer.
- 7 N'obstruez aucune des ouïes de ventilation. Installez-le en respectant les instructions du fabricant.
- 8 Ne l'installez pas près de sources de chaleur tels que radiateurs, panneaux chauffants, étuves, ou autres appareils produisant de la chaleur (dont les amplificateurs).
- 9 Ne pas utiliser d'adaptateur pour supprimer la prise de terre des prises à trois fiches. Si la prise fournie ne peut pas être branchée dans la prise électrique, adressez-vous à un électricien qui remplacera la prise obsolète.
- 10 Protégez le cordon secteur afin que l'on ne marche pas dessus et qu'il ne soit pas pincé, surtout au niveau des prises, ou à l'endroit où il sort de l'appareil.
- 11 Utilisez exclusivement des fixations et des accessoires recommandés par le fabricant.
- 12 Débranchez l'appareil en période d'orage ou s'il doit rester inutilisé pendant longtemps.
- 13 Confiez toutes les réparations et interventions à un personnel qualifié. Une intervention est nécessaire si l'appareil a été endommagé d'une façon ou d'une autre, si son cordon ou sa prise secteur ont été endommagés, si du liquide a été renversé ou si des objets sont tombés à l'intérieur, ou encore si l'appareil a été exposé à la pluie ou à l'humidité, s'il ne fonctionne pas normalement, ou s'il est tombé.
- 14 Débrancher l'appareil du réseau électrique par la prise de secteur.
- 15 **Avertissement : afin de réduire le risque d'incendie ou de choc électrique, ne pas exposer cet appareil à la pluie ou à de l'humidité.**
- 16 **Avertissement : n'exposez pas cet équipement aux éclaboussures et veillez à ce qu'aucun récipient rempli de liquide, verre ou vase, ne soit posé dessus.**
- 17 **Avertissement : la prise secteur doit toujours rester directement accessible.**



EC-Declaration of Conformity

The undersigned, representing the following manufacturer

Manufacturer:

Address:

Midas Klark Teknik Ltd.

Klark Industrial Park, Walter Nash Road,
Kidderminster. Worcestershire. DY11 7HJ.

hereby declares that the following product

Product Type Number	Product Description	Nominal Voltage(s)	Current	Freq.
DN530	Creative Quad Gate	115V AC 230V AC	200mA 100mA	50/60Hz

is in conformity with the regulations of the following marked EC-directives and bears the CE-mark accordingly

reference number	title
2004/108/EC	EMC Directive (EMC)
2006/95/EC	Low-Voltage Directive (LVD)

The conformity of the product with EC directives for use in environments E1, E2, E3 and E4 is provided by the compliance with the following standards:

Standards/date:

reference number	title
EN 60065:2002	Audio, video and similar electronic apparatus. Safety requirements.

Applied EMC emission test standards:

Applied EMC immunity test standards:

ref. no.	title
EN 55103-1:1996 Class B	EN 55103-1 Annex A: Radiated magnetic disturbance, 50Hz-50kHz
	CISPR 22: Radiated disturbance, 30-1000MHz
	EN 55103-1 Annex E: Conducted disturbance, ac & signal ports
	EN 61000-3-2:2006 Mains harmonics
	EN 61000-3-3:1995 Mains voltage flicker

ref. no.	title
EN 55103:1996 Class B	EN 61000-4-2:1995 Electrostatic discharge
	EN 61000-4-3:1996: Radiated RF disturbance, 80-1000MHz
	EN 55103-2 Annex A: Magnetic LF disturbance, 50Hz-10kHz
	EN 61000-4-4:1995: Fast transient bursts, ac & signal ports
	EN 61000-4-5:1995: Surge, ac port
	EN 61000-4-6:1996: Conducted RF field, ac & signal ports
	EN 61000-4-11:1994: Mains voltage dips and interruptions

Place, date: Kidderminster, UK
9th February 2011



SVP, Midas Klark Teknik
Printed name: John Oakley



AVP, Product Development
Printed name: Alex Cooper



Precautions

Before installing, setting up or operating this equipment please ensure that you have read and fully understand all of this section and the "IMPORTANT SAFETY INSTRUCTIONS" at the front of this manual.

This equipment is supplied by a mains voltage that can cause electric shock injury!

The following special limitations must be observed in order to maintain safety and electromagnetic compatibility performance.

Safety warnings

This equipment is fitted with a mains power socket. For safety reasons the earth leads must not be disconnected.

Signal 0V is connected internally to the chassis.

To completely disconnect this equipment from the AC mains, while observing full safety precautions (see "Power" on page vii), switch off the mains at the mains outlet. It is now safe to isolate the unit by unplugging the mains lead from its rear panel.

To avoid electrical shock do not remove covers. Refer servicing to qualified personnel only.

The power supplies — even the DC ones — have a high current!

General precautions

The following information gives basic safety precautions that should be observed to reduce the risk of fire, electric shock and personal injury:

- Never operate damaged equipment and never operate equipment with damaged cables.
- Do not remove, obscure or deface any warnings or cautions.

Power

Please note that the system power supplies contain LETHAL VOLTAGES greatly in excess of the mains voltage and that its rails can produce extremely large currents that could burn out equipment and wiring if shorted. All

testing and servicing must ONLY be carried out by approved service engineers.

This apparatus should only be operated with the power supply connected to ground via the ground in the mains connector.

The internal power supplies are of the switch mode type that automatically sense the incoming mains voltage and will work where the nominal voltage is in the range 100VAC to 240VAC.

When removing the equipment's electric plugs from the outlets, always hold the plug itself and not the cable. Pulling out the plug by the cable can damage it.

Never insert or remove an electric plug with wet hands.

Handling the equipment

Completely isolate the equipment electrically and disconnect all cables from the equipment before moving it.

When lifting or moving the equipment, always take its size and weight into consideration.

Do not insert your fingers or hand in any gaps or openings on the equipment, for example, vents.

Avoid inserting or dropping foreign objects, such as paper, plastic, metal etc., into any gaps or openings on the equipment, for example, vents. If this happens, immediately disconnect the equipment from the mains (see "Safety warnings" on page vii). Then, have the equipment inspected by the manufacturer's qualified service personnel.



Installation

Before installing the equipment:

- Power plugs must be inserted in socket outlets provided with protective earth contacts. The electrical supply at the socket outlets must provide appropriate over-current protection.
- Both the mains supply and the quality of earthing must be adequate for the equipment.
- Before connecting up the equipment, check that the mains power supply voltage rating corresponds with the local mains power supply. The rating of the mains power supply voltage is printed on the equipment.

Location

- Ideally a cool area is preferred, away from power distribution equipment or other potential sources of interference.
- Do not install the equipment in places of poor ventilation.
- Do not install this equipment in a location subjected to excessive heat, dust or mechanical vibration. Allow for adequate ventilation around the equipment, making sure that its vents are not obstructed. To prevent excessive heating of the equipment, avoid mounting it directly above power amplifiers or other devices that radiate significant amounts of heat, such as radiators and heaters. Keep the equipment out of direct sunlight.
- Make sure that the mains voltage and fuse rating information of the equipment will be visible after installation.

Audio connections

To ensure the correct and reliable operation of the equipment, only high quality balanced, screened, twisted pair audio cable should be used.

XLR connector shells should be of metal construction so that they provide a screen when connected to the console and, where appropriate, they should have Pin 1 connected to the cable screen.

In the event of ground loop problems, disconnect the signal screen at one end of the connecting cables. Note that this can only be done when the equipment is used within a balanced system.

Radio frequency interference

Class B device

This equipment has been tested and found to comply with the limits for a Class B digital device, pursuant to part 15 of the FCC Rules. These limits are designed to provide reasonable protection against harmful interference in a residential installation. This equipment generates, uses, and can radiate radio frequency energy and, if not installed and used in accordance with the instructions, may cause harmful interference to radio communications. However, there is no guarantee that interference will not occur in a particular installation. If this equipment does cause harmful interference to radio or television reception, which can be determined by turning the equipment off and on, the user is encouraged to try to correct the interference by one or more of the following measures:

- Reorient or relocate the receiving antenna.
- Increase the separation between the equipment and receiver.
- Connect the equipment into an outlet on a circuit different from that to which the receiver is connected.
- Consult the dealer or an experienced radio TV technician for help.

Electric fields

Caution:

In accordance with Part 15 of the FCC Rules & Regulations, "... changes or modifications not expressly approved by the party responsible for compliance could void the user's authority to operate the equipment."

Should this product be used in an electromagnetic field that is amplitude modulated by an audio frequency signal (20Hz to 20kHz), the signal to noise ratio may be degraded. Degradation of up to 60dB at a frequency corresponding to the modulation signal may be experienced under extreme conditions (3V/m, 90% modulation).

Operation

To avoid electrical shock, never operate the equipment with the covers removed.



Safety equipment

Never remove, for example, covers, housings or any other safety guards. Do not operate the equipment or any of its parts if safety guards are ineffective or their effectiveness has been reduced.

Optional equipment

Unless advised otherwise, optional equipment must only be installed by service personnel and in accordance with the appropriate assembly and usage regulations.

Special accessories

To comply with part 15 of the FCC Rules, any special accessories (that is, items that cannot be readily obtained from multiple retail outlets) supplied with this equipment must be used with this equipment; do not use any alternatives, as they may not fulfil the RF requirement.





Contents

Chapter 1	Introduction	1
	Overview of the DN530	1
	Applications	2
	Features	3
	About this manual	3
Chapter 2	What Is A Gate?	5
	Principles of gate operation	5
	Typical creative uses	6
	Other uses of gating	7
	Unwanted side effects	7
Chapter 3	Getting Started.	9
	Unpacking	9
	Checking the mains fuse	9
	Installation	9
	Connecting the power cable	10
	Connecting the audio cables	10
	Channel I/O pin-outs	10
	Sidechain inputs	11
	Connecting to unbalanced equipment	12
	Powering the unit	12
Chapter 4	Front Panel.	13
	Description	13
	Gate section	14
	Metering	15
	Sidechain section	16
Chapter 5	Rear Panel	17
	Mains input	17
	Channels	17
	Solo bus	18
Chapter 6	Gate Control Functions.	19
	Attack	19
	Hold	19
	Release	19
	Range	19
	Threshold	19
	Accent	19
	Intelligent threshold shift (i-TS)	20
Chapter 7	Using The Gate.	21
	Basic gate operation	21



	Sidechain21
	Soloing23
	Interfacing with the console24
	Using gates with compressors25
	Instrument synchronisation26
Appendix A	Application Notes	27
	Removal of background noise from electronic sources27
	Drums and percussive instruments27
	Transient accentuation27
	Music PA28
	Conference PA28
	Envelope shaping29
	Gating vocals29
	Chatter30
	Clicking30
	False triggering30
	Noise enhancement31
	Ducking31
	De-essing31
Appendix B	Technical Specification	33
Appendix C	Functional Block Diagram	35
Appendix D	Balanced/Unbalanced Audio	37
Appendix E	Crib Sheet	39
Appendix F	Service Information	41
	Routine maintenance41
	Cleaning41
	Replacing the mains fuse41
	Equipment disposal42



Chapter 1: Introduction

Thank you for purchasing a Klark Teknik DN530 Creative Quad Gate. The DN530 is a user-friendly, high-performance, four-channel (quad) analogue gate designed for live sound reinforcement with applications in both front-of-house and monitoring situations. Other possible areas for use include broadcasting, the recording studio and installation.

The DN530 provides a variety of easy-to-use controls for the precise manipulation of gate parameters. These enable you to use gating for creative and corrective applications, for example, by using a channel insert on drums.

Your DN530 was conceived by Klark Teknik to offer audio professionals high-performance audio equipment, designed to provide no-compromise sonic quality with a feature set that offers all essential facilities and functions. It represents the very best of British design and engineering combined with contemporary, efficient manufacturing methods, and will give you many years of reliable service.

All this is backed up, of course, by the standard Klark Teknik three year warranty.

Please take the time to complete and return the registration card or fill in the Warranty Registration Form online by visiting our website at www.klarktechnik.com and, to obtain the best results with a minimum of effort, also read this operator manual.

Finally, enjoy your Klark Teknik DN530!

Overview of the DN530

The DN530 consists of four channels of gate mounted in a 1U rack. Full control of all essential audio-gating parameters is available, including all envelope characteristics. Additionally, there are external sidechain access points with internal frequency selective filters.



Front panel



Rear panel

The main gate controls consist of bypass and duck switches, continuously adjustable threshold and range controls, and four envelope controls (attack, accent, hold and release).

External sidechain input and filter solo facilities are provided, which feed a solo bus output (with input for linking). The sidechain filters consist of a single band pass section with a frequency control that can sweep the majority of the audio spectrum. The filter switch activates the filter within the sidechain signal path.



Applications

The DN530 provides a quality, cost effective and compact gating unit presented in a traditional 1U quad channel format. This makes it suited to applications where space is limited and is ideal for small touring public address (PA) rigs where the four channels are enough to cover a small drum kit. The accent feature will largely eliminate the need for excessive EQ or compression on these channels, which is ideal if the accompanying console has limited processing facilities.

Other applications include ducking channels to make room for other instruments, ducking with the sidechain filter active to reduce sibilance, noise gating effects processors or other noisy sources like guitar amps.

The accent feature is primarily intended for use with gated percussion, but it can also be used on its own with the gate range set to minimum in order to add punch, as an effect, to varied sources.

The DN530 has been primarily designed for the following main application areas:

- **Touring live sound** In applications where analogue consoles are still required due to their ease of use. Here the DN530 gate would primarily be used for channel inserts on drums. The quality of sound produced by the accent feature may also make the unit useful as an insert on digital desks too.
- **Theatre live sound** Theatres could make use of the gate in the same way as touring and, for example, may also use it as a noise gate on vocals.
- **Corporate live event** Used similarly to the touring and theatre live sound applications.
- **Conference and other fixed install** Particularly for noise gating, with the small rack size being an important factor.



Features

The DN530 has the following features:

- The gate action has rock solid triggering.
- Advanced band pass sidechain filter, which is easy to set up.
- Separate (daisy-chainable) solo bus that allows tuning of the sidechain filter, even during the performance.
- Attack is exponential, so that it can be set extremely fast to reduce signal loss at the start of sounds while remaining sonically transparent, that is, with no unwanted clicks.
- Release is reverse exponential, so that it can be set relatively fast to blend in seamlessly with the natural decay of the material.
- Ducking.
- Extremely low noise and distortion levels.
- Rotary controls for all envelope characteristics and range.
- Progressively controllable accent level that emphasises the start of signals to increase the dynamic power within percussive signals.
- Comprehensive metering makes set up simple and intuitive.
- Status of bypass, solo and other major switches are boldly presented to avoid mistakes.
- External sidechain inputs.

About this manual

This is the operator manual for the DN530. It is intended to help get your DN530 installed and in operation as quickly as possible by giving you unpacking, installation, connection and setting up instructions. To help familiarise you with the DN530 there is a description of the front and rear panels, along with easy-to-follow user instructions.





Chapter 2: What Is A Gate?

The natural sounds of everyday life, which can be caused by anything from, say, the falling of a leaf to the roar of a jet engine, vary extremely widely in sound level. This variance is known as the 'dynamic range' and is the difference — expressed in decibels (dB) — between the loudest and quietest sounds in a piece of audio, such as music or speech, or that can be reproduced by a piece of audio equipment without distortion.

All of the sounds that we want to listen to, whether natural or electronically processed, are accompanied by a certain amount of unwanted background noise, such as the rustle of musicians turning the pages of the score in the studio. Even if, in the final programme, the noise level is below the ambient noise of the listening area, it may still be heard and is therefore undesirable.

The gate is a valuable tool for controlling the dynamic range. The gate of the DN530 not only allows you to minimise or eliminate unwanted low level noises, but also gives you creative possibilities by providing the tools to artistically restructure the dynamics of a signal.

Principles of gate operation

The gate closes when the input signal falls below threshold (position 1 in Figure 1 below). This cuts off the output signal altogether until the gate opens again (position 2 Figure 1 below) when the input signal goes over threshold.

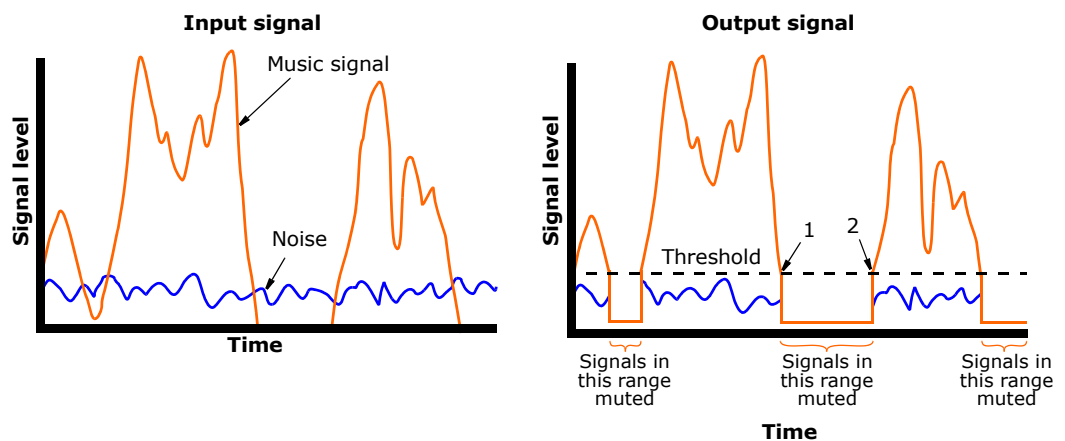

Figure 1: Gate function

You would normally set the gate threshold below the lowest level of the performance so as not to lose any of the performance, but eliminating any of the unwanted hum, low level noise etc.



Typical creative uses

The human ear is connected to an extremely sophisticated organ for processing incoming audio information — the brain. Even in situations where there are many sound sources, we seem to be able to tune in to the sounds we want to hear and reject others. This is sometimes known as the *cocktail party* effect, where it is possible to pick out one person's voice — even at a distance — from many conflicting conversations.

The microphone (mic) is less selective in its pick up, being sensitive to all sounds within its range and coverage angle. For example, a mic set to pick up the snare drum of a drum kit will pick up every other drum and cymbal to some extent, and probably the bass guitarist as well. When several mics are positioned on the kit, each one giving a good sound on its own particular drum, but they will all pick up unwanted instruments as well, making the sound less clear.

One solution is to use a noise gate on each mic (see diagram below). The gate will reduce the output from the mic to almost zero when the drum is silent, yet will open practically instantaneously when the drum is played. As the sound from the drum decays, the gate will close again and reject noise from the rest of the kit.

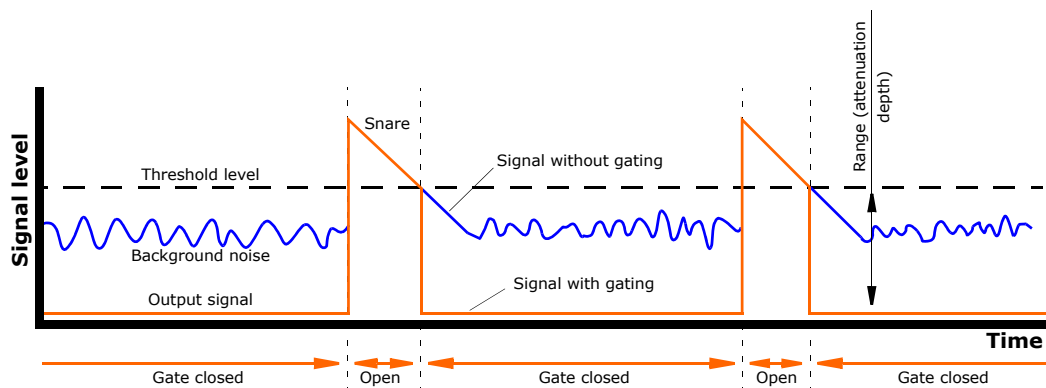

The threshold level represents the sound level at which the gate will open. Any sound exceeding the threshold triggers the gate. Sounds at lower levels leave the gate closed and the mic will be almost completely silent.



Other uses of gating

Gates were originally devised to reduce noise in the silent passages of a music programme, especially during the process of multi-track recording on analogue tape. Although they are still used for reducing noise, many other uses and creative applications have been found for them over the years, including:

- Noise reduction.
- Removing compressor breathing noise.
- Reducing spill from adjacent sound sources.
- Gating ambience reverb for effects.
- Gating one instrument to synchronise it with another.
- Ducking one source to make room for another in a mix.
- Reduction of ringing on drums.
- Increasing the definition and punch of drums.

Unwanted side effects

Very often the process of gating produces unwanted side effects, especially if the gate is not set up well or does not operate sympathetically with a particular type of source material. These can include the following:

- **Chatter** The gate is indecisive and keeps opening and closing on sustained notes.
- **Clicking** The attack is set too fast or its envelope shape is unsuitable and generates high order harmonics each time it opens.
- **False triggering** The gate opens on mic spill as well as its intended source.
- **Noise enhancement** Noise is removed totally, so that the transition from when the gate shuts to when it opens and back, modulates the background noise so much that it draws the listener's attention to the noise when it is present.

For details of how to overcome the unwanted side effects, see Appendix A "Application Notes" on page 27.

Providing controls for threshold, attack, release, hold and ratio, plus good metering, helps operators set up the gate for differing signal sources and minimise most of the negative effects above. However, this may involve a degree of compromise between the desired gating effects and the unwanted side effects. The DN530 will fare better than most because design choices made during its development were based on listening tests carefully tailored to match real world applications.





Chapter 3: Getting Started

Observing the IMPORTANT SAFETY INSTRUCTIONS at the front of the manual and the guidelines in "Precautions" on page vii, carry out the following to get your DN530 unit fully operational.

Unpacking

Carefully unpack your DN530 equipment package.

Then, inspect the DN530 unit carefully for any signs of damage that may have occurred during transit and notify the courier immediately if you discover any.

Check the contents of your DN530 equipment package. If there are any parts missing, incorrect or faulty, please contact your local distributor or Klark Teknik at the address at the front of this manual. The following is a list of the main items contained in the DN530 package.

Quantity	Description	Part number
1	DN530 unit	Not applicable
1	DN530 Operator Manual (this document)	DOC02-DN530
1	Warranty card	DOC04-WARRANTY
1	Mains lead	PWR21-MAINSLEAD

Please retain the original packing in case you should need to return the equipment to the manufacturer or supplier, or transport or ship the unit later.

Checking the mains fuse

Before installing the equipment, make sure that the mains fuse fitted is of the correct type and rating for your unit. For details, see "Replacing the mains fuse" on page 41.

Installation

This unit is designed for mounting in any 19" EIA standard rack. Four rack-mount holes in the front panel are provided for rack mounting and are designed to fully support the weight of the unit in the rack.

Note: Avoid over-tightening the rack-mount screws, as this could damage the front panel.

The position of the unit will depend upon how it is to be used. However, when positioning the unit, avoid placing it where the control knobs may be damaged by being accidentally knocked or snapped off. Also, try to avoid placing the unit directly near or on any power distribution units or power amplifiers.



Connecting the power cable

Making sure that the mains power at the power outlet is off, connect the mains cable supplied with your DN530 to the mains power outlet and then to the mains socket at the rear of your unit.

Connecting the audio cables

Making sure that all equipment is switched off, connect the DN530 to the rest of your audio equipment as shown in the following subsections. For information on balancing, see "Balanced/unbalanced audio" on page 37.

Channel I/O pin-outs

The following shows the channel I/O pin-outs for the male and female XLR connectors, on both balanced and unbalanced circuits.

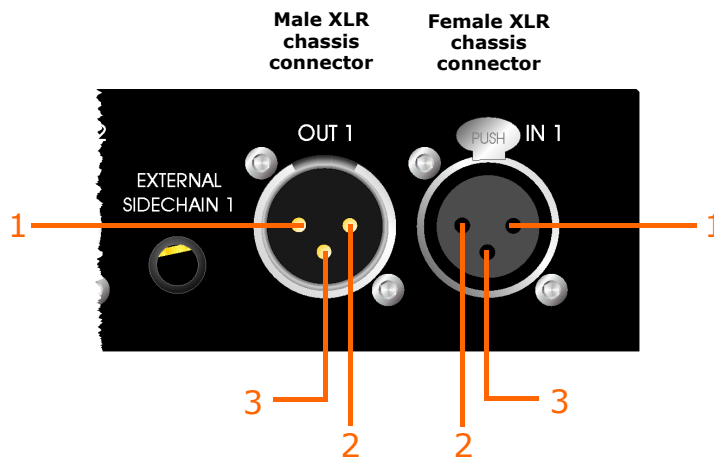

Pin-out	Balanced I/O	Unbalanced I/O
1	Screen/ground	Screen/ground (not connected at unbalanced end)
2	Hot signal	Hot signal
3	Cold signal	Ground at unbalanced end



Sidechain inputs

The electronically balanced sidechain inputs are on stereo 1/4" TRS connectors. Inserting a mono jack plug will automatically unbalance the input. The following diagram shows the sidechain input connection details.

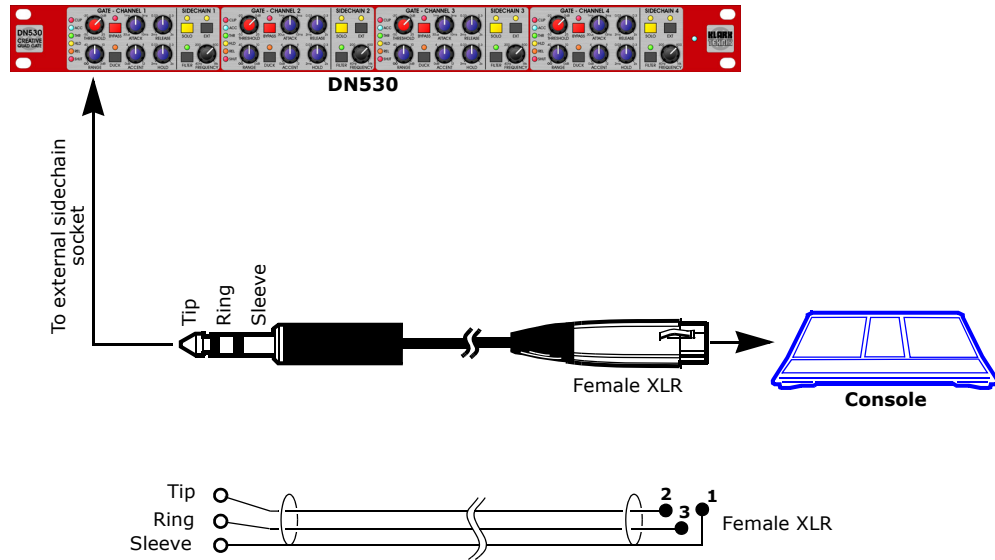

The 1/4" TRS connector wiring details are as follows:

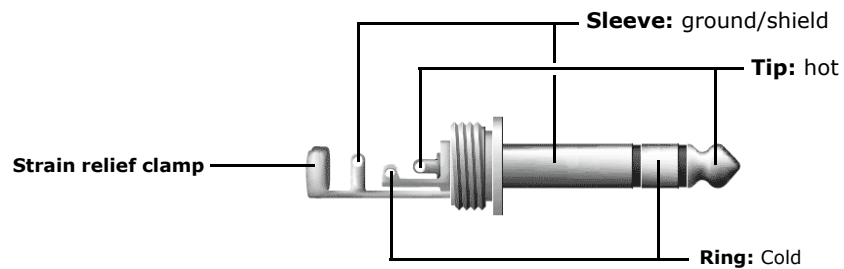



Connecting to unbalanced equipment

Ideally, you will be making the best use of the DN530's low-noise high-headroom balanced inputs by connecting to similarly balanced equipment. However, if you do have to connect to unbalanced devices, the following wiring is recommended for best results (see Figure 3):

- Connect the +ve (pin 2) of the balanced connection to the +ve terminal on the unbalanced connector.
- Connect the -ve (pin 3) of the balanced connection to the common (ground) terminal on the unbalanced connector.
- Connect the ground (pin 1) of the balanced connection to the common (ground) terminal on the unbalanced connector.

The following diagram shows the wiring details for the insert send/return 1/4" TRS connector/XLRs.

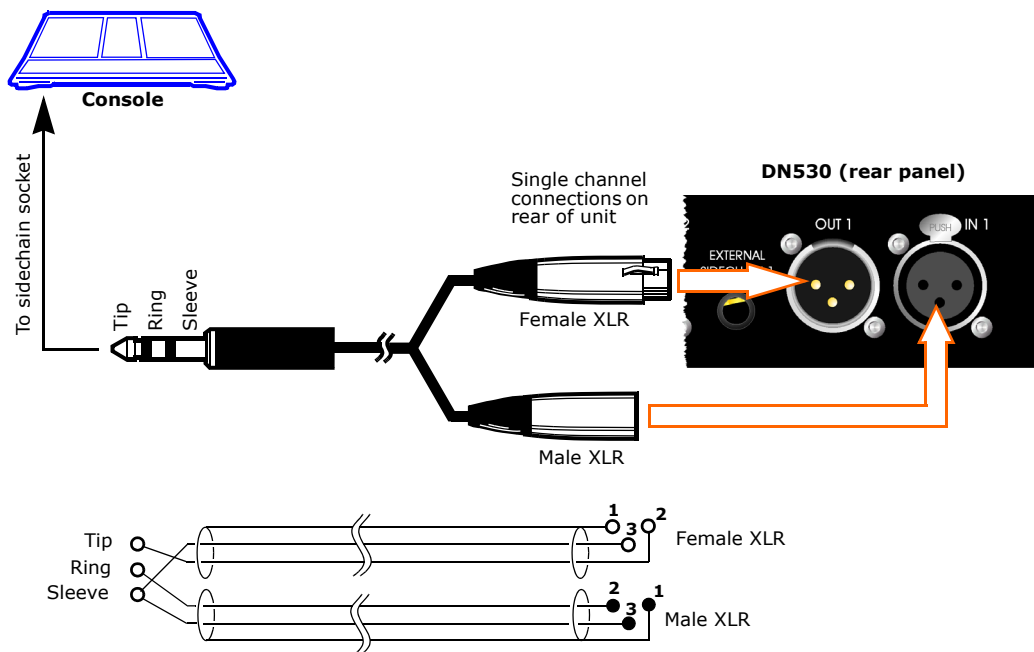

Powering the unit

To power up the unit, switch on the power at the mains power outlet. The blue power LED on the front of the unit (far right) will illuminate to show that power is on.

Your unit is now ready to operate.

To switch off the DN530, switch off the mains at the mains power outlet. Then, to electrically isolate the unit, remove the mains cable from the mains IEC socket on the rear panel.



Chapter 4: Front Panel

The front panel of the DN530 has four main channel sections, each containing a number of control knobs, pushbuttons and LEDs. Each main channel section is divided into a gate section and a sidechain section.

All of the switches on the front panel are of the latching pushbutton type and have two positions, in and out. Each of these switches have an associated LED above that illuminates to show when the switch is on.

Description

The front panel comprises four channel sections and a power on/off indicator LED.

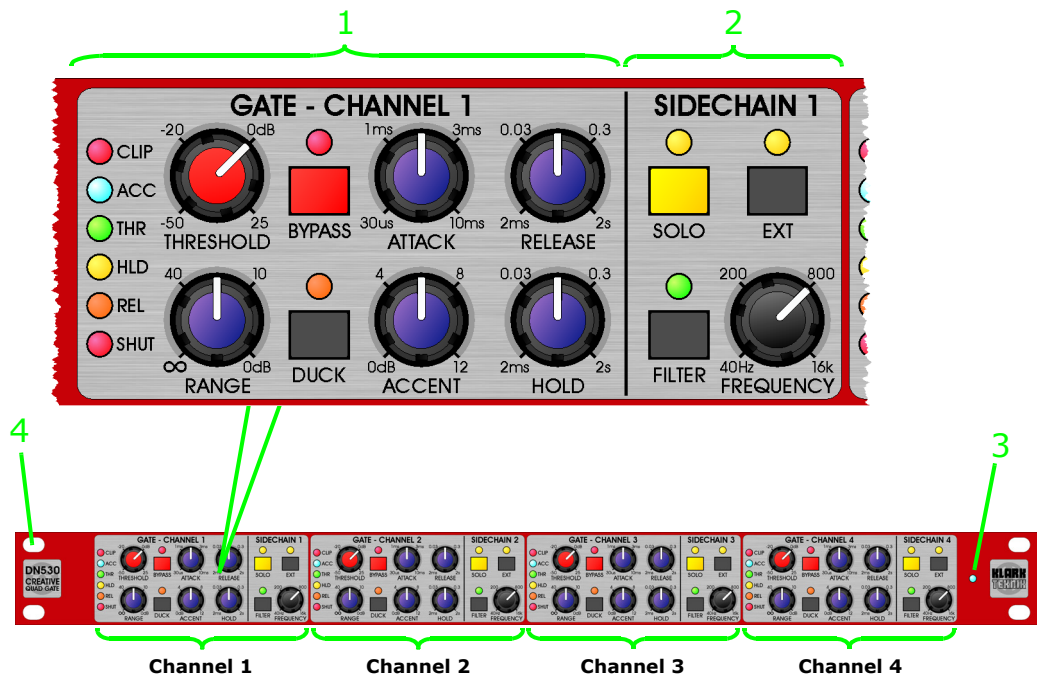

Item	Description
1	Gate section (see "Gate section" on page 14).
2	Sidechain section (see "Sidechain section" on page 16).
3	Power on/off indicator LED. Illuminates blue when the power is on.
4	Four rack mounting holes for securing the unit in a rack. Do not overtighten.



Gate section

The gate section houses six gate parameter control knobs, bypass and duck switches, and a set of six metering LEDs. For more information on the gate controls and their uses, see Chapter 6 "Gate Control Functions" on page 19.

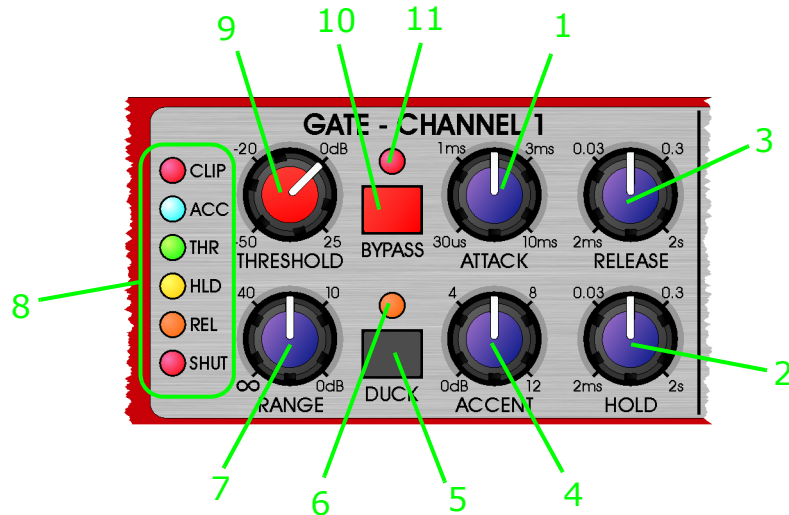

Item	Type	Label	Function
1	Control knob	ATTACK	Adjusts the time taken for the gate to open after an over-threshold signal.
2	Control knob	HOLD	Defines a waiting period before the gate starts to close once the signal has been detected as having fallen below threshold.
3	Control knob	RELEASE	Adjusts the time it takes for the gate to close after the program material falls back below threshold and the hold time has elapsed.
4	Control knob	ACCENT	Adds an overshoot characteristic when the gate is opening, which accentuates the transient.
5	Pushbutton	DUCK	Reverses the operation of the gate so that it closes when signals go over threshold and opens when they go below threshold. When the DUCK switch is on, the ACCENT control and the ACC LED are disabled.
6	LED (orange)	Not applicable	On/off status indicator for the DUCK pushbutton.
7	Control knob	RANGE	Adjusts the amount of gain reduction that is applied to signals that are below threshold.
8	LED	Various	For details, see "Metering" on page 15.
9	Control knob	THRESHOLD	Adjusts the operating point (threshold) of the gate.
10	Pushbutton	BYPASS	Disconnects the gate from the main signal path.
11	LED (red)	Not applicable	On/off status indicator for the BYPASS pushbutton.



Metering

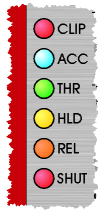

The key to successful DN530 operation is to know when signals are above or below threshold. This is especially true if the accent feature is used with low range settings or with no gating action at all. This style of metering provides an intuitive moving LED indication that ramps up and down as the signal level moves around the threshold point.

The metering comprises the following LEDs:

Label	Colour	Function
CLIP	Red	Clip LED for showing when the signal is being clipped. Clip LED threshold is +21dBu.
ACC	Blue	Accent LED for showing when the ACCENT control is applying positive signal gain.
THR	Green	Over threshold LED for showing when the signal has gone over threshold.
HLD	Yellow	Hold LED for showing when the HOLD control is delaying gate closure.
REL	Orange	Release LED for showing when the RELEASE control is delaying gate closure.
SHUT	Red	Shut LED for showing when the gate is closed to the level set by the RANGE control.



Sidechain section

The signals that feed the gate's sidechain are called the "sidechain". A band pass filter is provided that acts on the sidechain signals.

The sidechain section for each channel can be broadly divided into two areas: filter and solo. The filter section comprises the **FREQUENCY** control knob and the **FILTER** and **EXT** pushbuttons, and the solo section consists of the **SOLO** pushbutton.

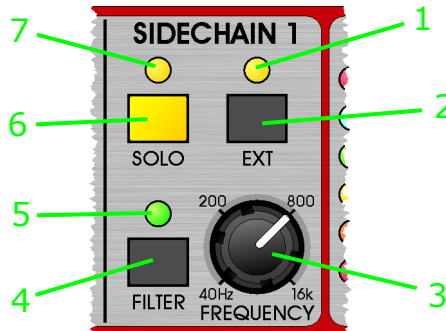

Item	Type	Label	Function
1	LED (yellow)	Not applicable	On/off status indicator for the EXT pushbutton.
2	Pushbutton	EXT	Switches the source of the signals that feed the sidechain from incoming gate signal to external input connection, and vice versa.
3	Control knob	FREQUENCY	Adjusts filter frequency in the range 40Hz to 16kHz.
4	Pushbutton	FILTER	Switches the band pass filter in/out.
5	LED (green)	Not applicable	On/off status indicator for the FILTER pushbutton.
6	Pushbutton	SOLO	Switches the solo function on/off.
7	LED (yellow)	Not applicable	On/off status indicator for the SOLO pushbutton.



Chapter 5: Rear Panel

The rear panel of the DN530 (shown below) has three main connector sections: mains input, solo bus and the four channels.

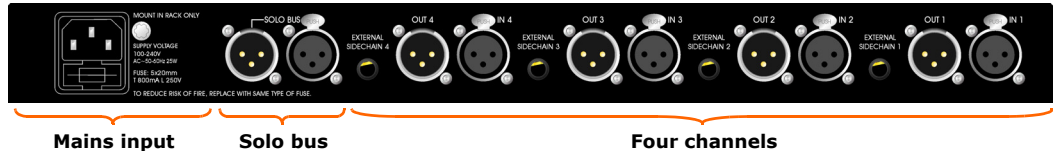

Mains input

The mains input section has a mains IEC socket, below which is a fuse drawer. Printed to the right are mains supply voltage and fuse details.

The mains input is an auto-voltage sensing switch mode power supply that operates where normal mains voltage is in the range 100V AC to 240V AC.

The fuse drawer houses the mains fuse at the rear of a two-compartment drawer. The front compartment provides room for a spare. Always replace the mains fuse with one of the same type and rating, as printed to the right of the fuse drawer.

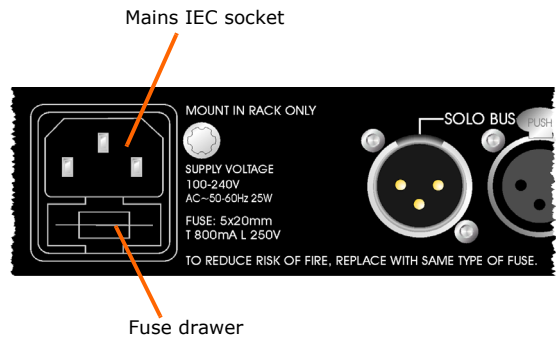

Channels

There are four similar channel sections on the rear of the DN530. Each section comprises an input and an output XLR chassis connector, and a 1/4" TRS connector. These are used for connecting to external line level signals, such as a mixing console's insert connections.

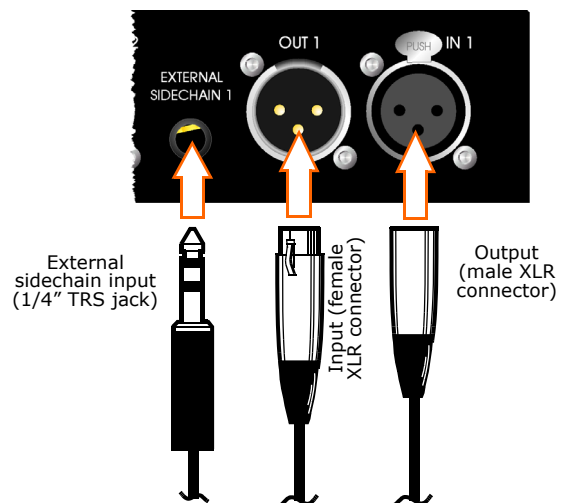



Solo bus

The solo bus section comprises an input and an output XLR chassis connector.

These are connected to an external monitor input, such as a mixing console, or they can be daisy-chained to other units being monitored (see Figure 3, "Daisy-chaining the DN530s (solo bus)," on page 23).

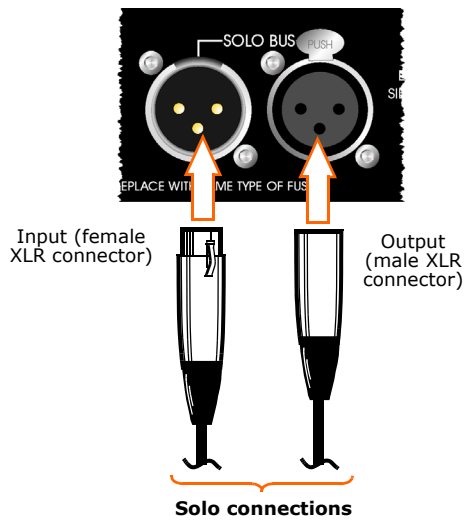



Chapter 6: Gate Control Functions

This chapter gives details of the control functions of the DN530 gate.

Attack

Attack is the time taken for the gate to open after an over threshold signal. The shape of the attack is fixed and has been carefully tailored to produce a transparent gating action.

Hold

Minimises chattering in conjunction with the internal hysteresis. Once the signal has been detected as having fallen below threshold, this control defines a waiting period before the gate starts to close. This is particularly useful for low frequency material and instruments with oscillating or unpredictable decay envelopes.

Release

Release is the time taken for the gate to close after the programme material falls back below threshold. As with attack, the shape is crucial to the sound and has been tailored to produce the most transparent gating action possible.

Range

Controls the amount of gain reduction that is applied to signals below threshold. The gain reduction can be infinite, but things often sound more natural when it is backed off to only 10dB or 15dB. With this type of setting, the background noise and spill remain at a reduced level, but become less noticeable because they do not noticeably switch in and out with the gating action. The maximum range is given when the control is fully anti-clockwise, that is, set to infinity (∞).

Threshold

This is the gate operating point. Signals that go over threshold will open the gate, while signals that go below threshold will close the gate. In both cases, gate opening/closing occurs over a period of time, which is dependent on the envelope (attack and release) control settings.

Accent

Normally, during an opening transition the gain changes from -n dB (n is set up by the range control) to 0dB. When the accent control is turned up the transition goes from -n dB to a positive +n dB gain (the amount of positive gain is set by the accent control up to a maximum of +12dB). This accented level only lasts for a short period of time (50ms), after which the gain returns to 0dB. The effect this produces is similar to the thickening action compressors impart on drums when their attack time is set very slow.



The advantage of generating the effect in this way is that it is much more straightforward to set up and has the added benefit that the attack control operates to change the sonic character of the accent as well as the gate. This allows a more precise tailoring of the sound produced — changing from tight and snappy to more of a low-end thud as you increase the attack time.

Another important feature of the transient accent is that it is independent of the range control, so that it is possible to accent things without gating them at all. This means that there is no need to lose any of the original sound, while gaining extra definition and punch.

Intelligent threshold shift (i-TS)

Intelligent threshold shift (i-TS) — or hysteresis — operates in conjunction with the **HOLD** control knob to reduce chattering within the gate. Chattering is the undesirable condition that occurs when signals — especially low frequency ones — are very close to the gate threshold. In this situation the gate can become indecisive and repeatedly open and shut on the programme. i-TS ensures that the gate remains open by automatically adjusting the threshold downwards as the signal goes over threshold. When the signal actually falls below threshold (that is, the temporarily adjusted threshold) the i-TS resets, ready for the next gate opening. This improved decision-making ensures that gating is rock solid and attacks start instantly and consistently, even on signals that go slightly over threshold.

i-TS is particularly useful for low frequency material and instruments with oscillating or unpredictable decay envelopes.



Chapter 7: Using The Gate

The DN530 is a gate processor that utilises premium quality, high precision components to achieve a high degree of accuracy and control. The DN530 has been designed primarily for creative use as front of house (FOH) or monitor. However, it is just as effective when used in the studio while broadcasting or recording. The DN530 processors offer, in a compact unit, control over the dynamic range for creative and corrective purposes.

Basic gate operation

The attack characteristic of the gate is exponential, which ensures that even at extremely fast attack settings the attack envelope seamlessly blends into the audio waveform. This prevents the creation of any undesirable audio artefacts (clicks).

>> To use the DN530

- 1** Set the threshold, attack, hold and release times to suit the programme.
- 2** Set the attenuation depth using the **RANGE** control knob.
- 3** Use the sidechain filter to tune the gate to open at a selected frequency.

Sidechain

For most applications the DN530 is triggered by the level of the incoming signal. Sometimes it can be useful to use a different signal to trigger the gate; this signal is known as an "external sidechain". Additionally, there is a solo function that routes the filtered sidechain signal to the solo bus to help the operator find the most sensitive frequency to trigger the gate.

Particularly in the case of drums, a very reliable trigger can be obtained by taping a contact mic to the shell of the drum, using the clean signal it produces to trigger the gate. An example of this set up — which can also be used for ducking (see "Ducking" on page 31) — is shown in Figure 2 "Typical set up for external sidechain operation" on page 22.

The frequency controls can be used to make the gate triggering frequency selective. The filter frequency control, which is adjustable from 40Hz to 16kHz, provides a good degree of triggering selectivity and facilitates easy set-up. The power of this feature combined with the solo bus cannot be overstated. It can also produce excellent results as a de-esser (see "De-essing" on page 31).

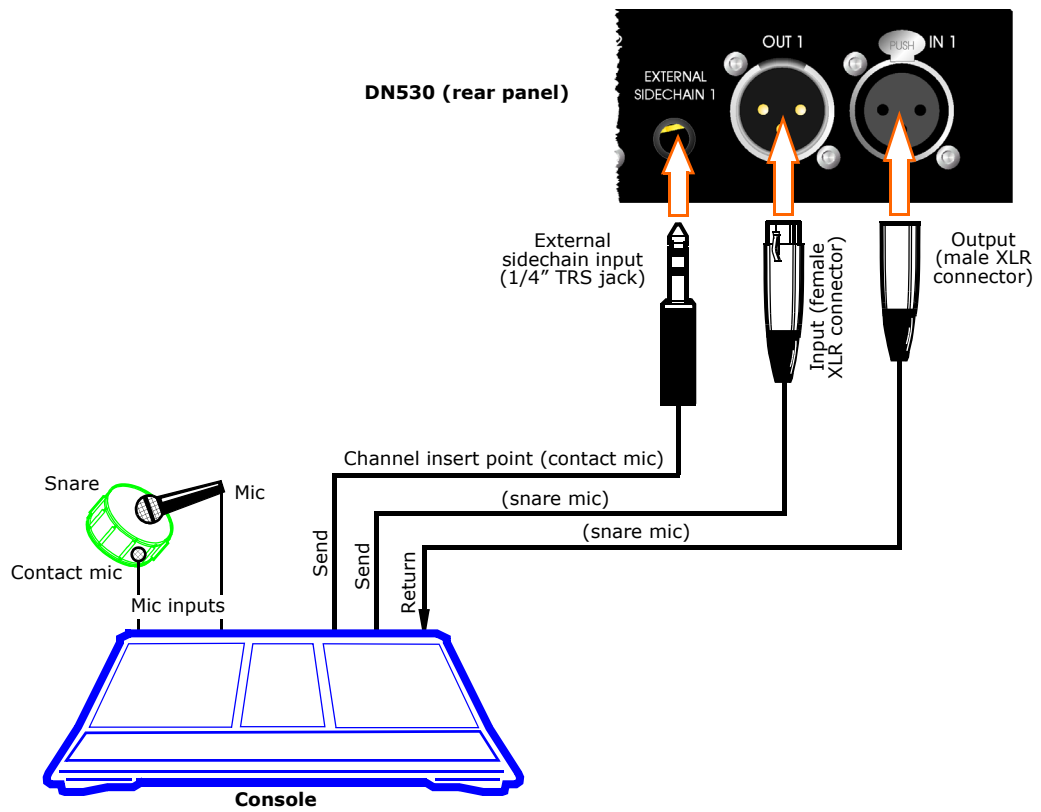

Figure 2: Typical set up for external sidechain operation



Soloing

You can monitor the sidechain during the performance using the dedicated solo output. To do this, connect the solo output to a spare input channel, line return, effects return etc., on your mixing console. Enabling any solo pushbutton will route that processor's sidechain monitor to the solo output, allowing monitoring of the sidechain filter without interrupting the audio output of the processor.

The rear panel of the DN530 includes a solo bus with input and output XLRs. This allows multiple units to be linked in series, so that a group of units can all apply a solo signal to a common solo bus. The final solo bus output will be taken from the last unit in the chain.

In the following example, four units are daisy-chained, although you can have any number you want.

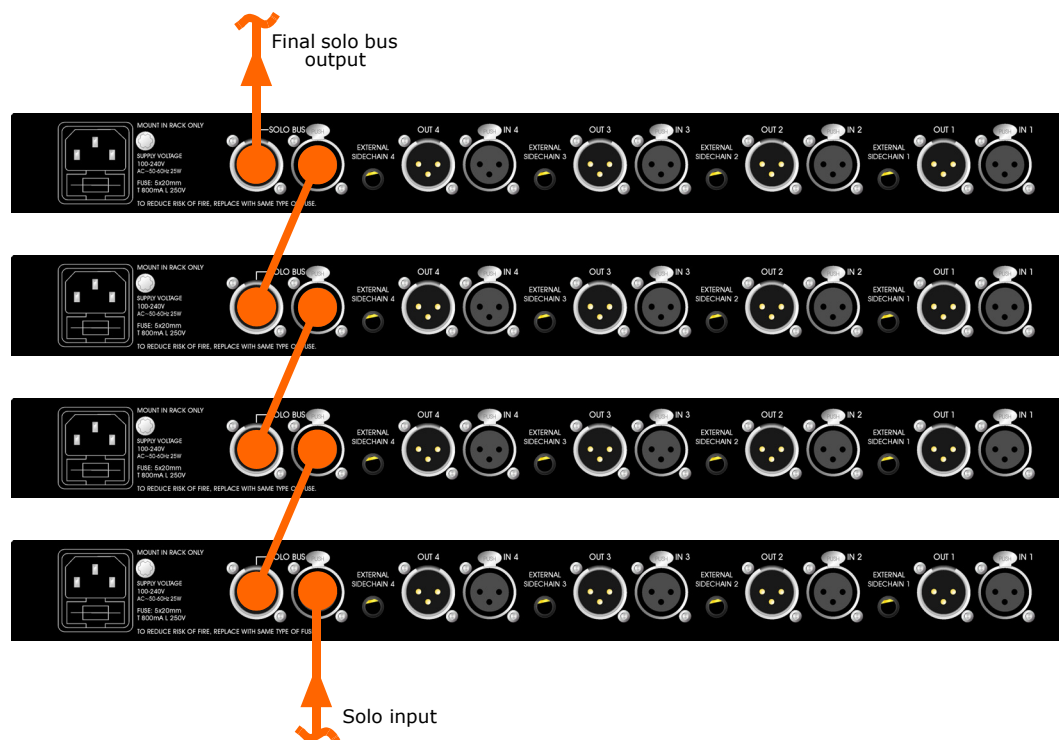
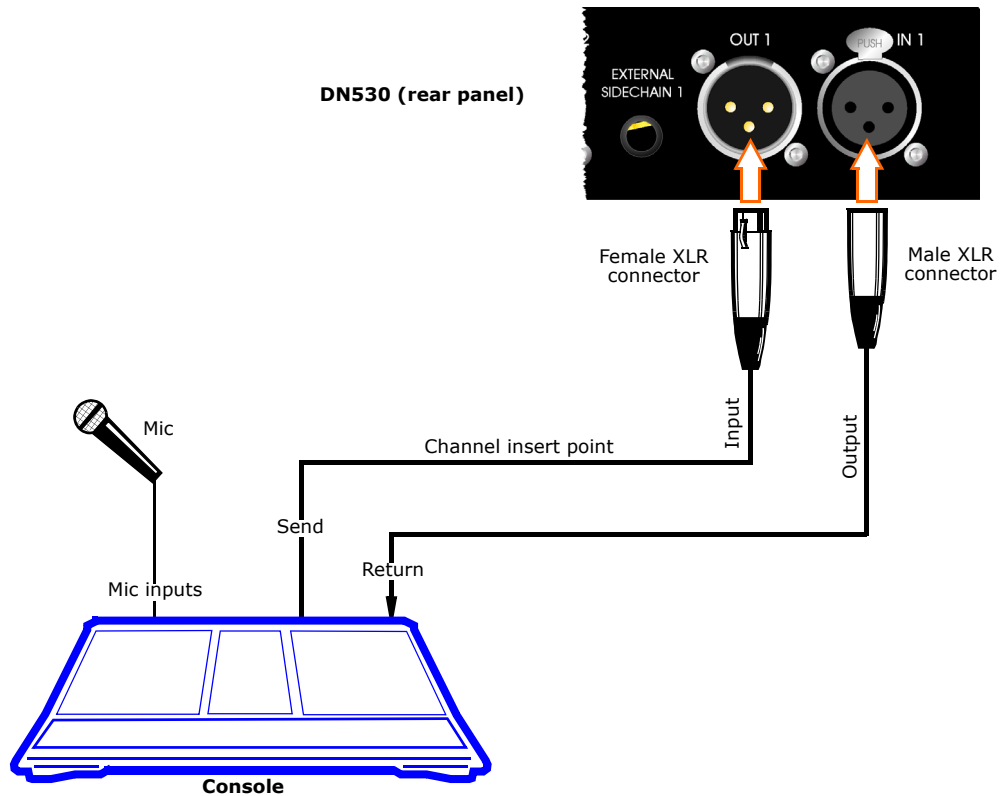

Figure 3: Daisy-chaining the DN530s (solo bus)



Interfacing with the console

The DN530 is optimised for use at line level, therefore to gate a mic, the input to the DN530 has to be taken from the console, preferably from the channel insert point send. The output from the DN530 comes back to the channel insert return. By connecting the DN530 at this position in the signal chain, its operation is unaffected by the use of any of the console controls, except input gain.



An alternative is to connect to the group insert point of the console. This is useful when many inputs are mixed down to a smaller number of outputs. A given number of gates can achieve a greater coverage.



Using gates with compressors

One of the most important applications of a noise gate is the reduction of noise emphasised by the action of compressors. When any signal is compressed, the highest levels are reduced, but the lowest noise levels remain the same. This effectively decreases the signal to noise ratio. By gating the signal before it enters the compressor (as shown in the following diagram), the noise can be eliminated before it has chance to be exaggerated by the compressor action.

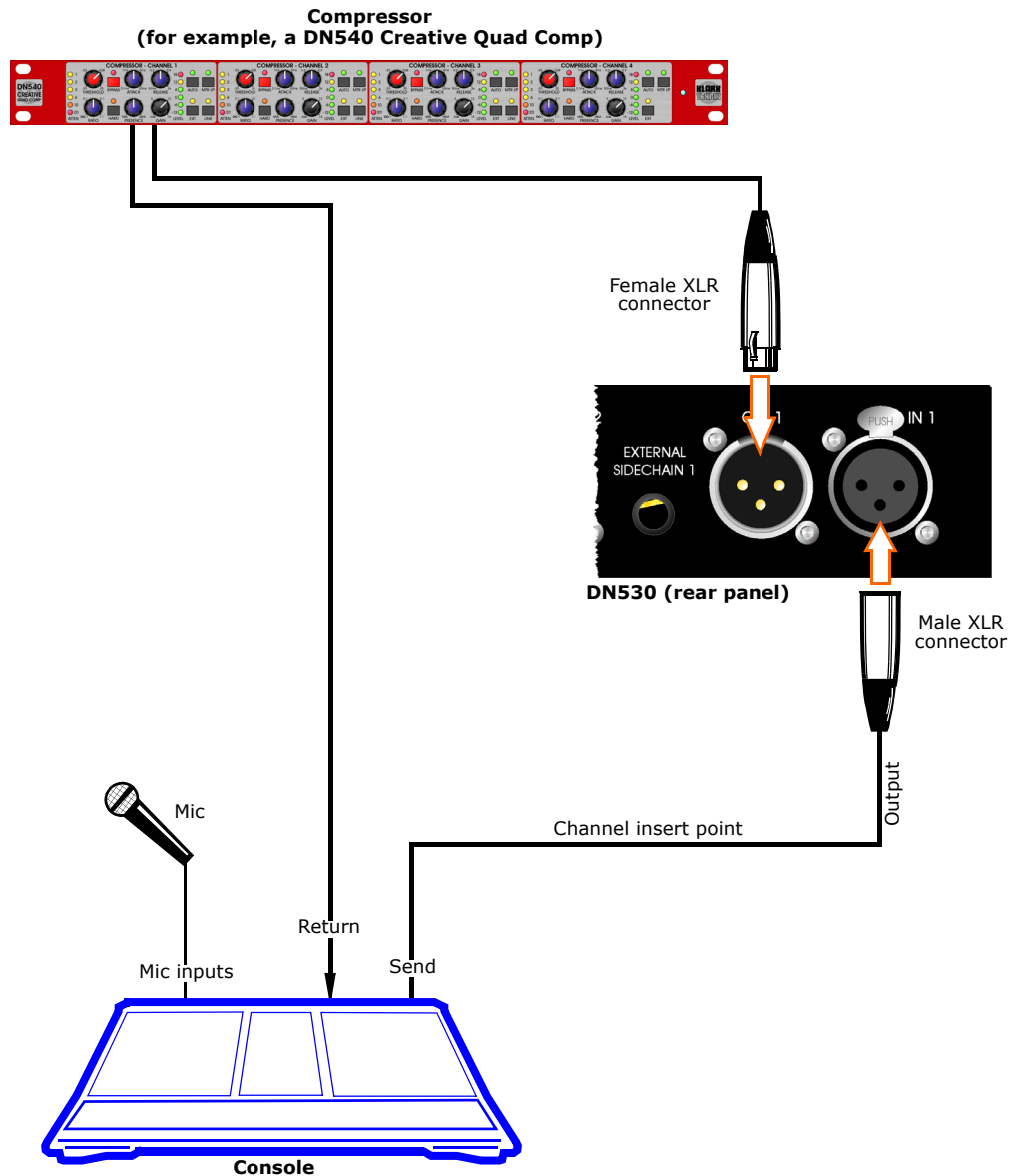

Some engineers prefer to connect the gate after the compressor. This reduces any slight noise produced by the compressor itself, but since the dynamic range of the signal is less when it leaves the compressor, setting the correct threshold level may take a little longer. Alternatively, the uncompressed signal may be paralleled to the external sidechain input; this external sidechain can then be used to trigger the gate.



Instrument synchronisation

Sometimes it is necessary to synchronise the attack of two instruments. Often a bass guitar must be made to synchronise precisely to the regular beat of the bass drum. This can be done by passing the bass guitar through the gate and using the bass drum as the external sidechain.

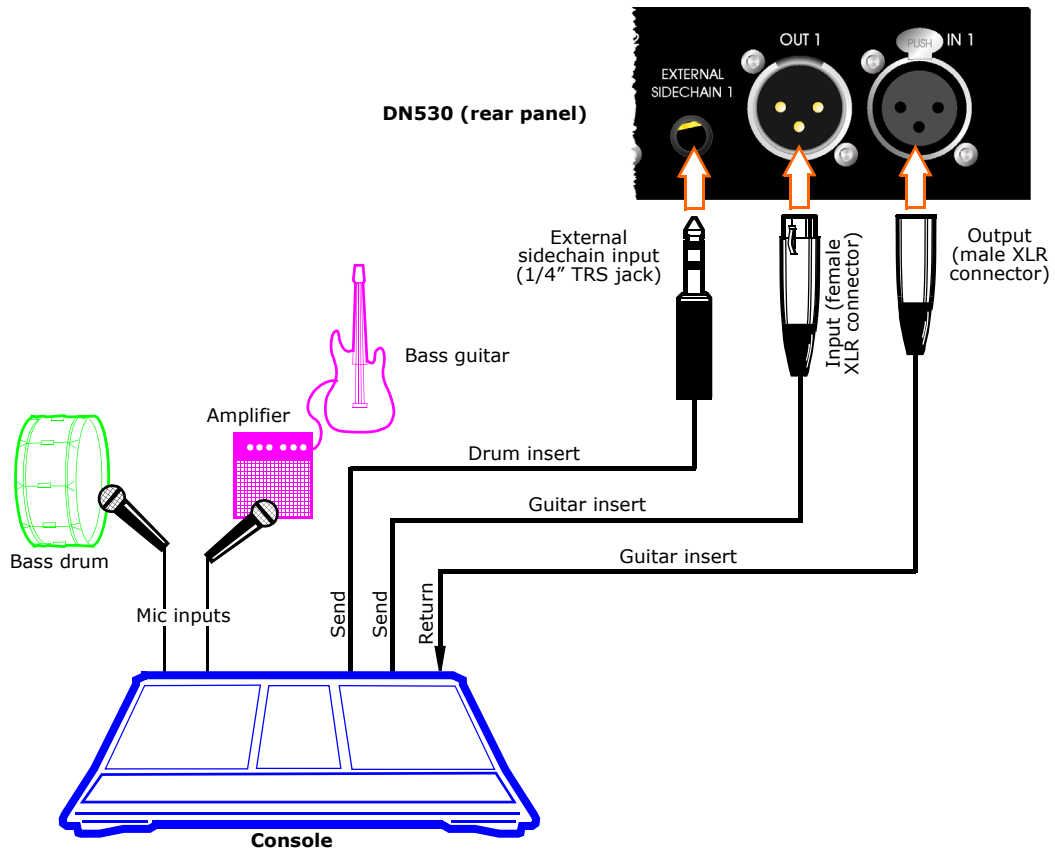



Appendix A: Application Notes

As most dynamics processing is a matter of personal taste and preference, these application notes are provided as a guide only. Experimenting in unconventional areas can often yield interesting and useful results. Always remember, be creative with your DN530 — and have fun!

When using noise gates, try experimenting with the attenuation depth for more subtle gating. Bear in mind that 20dB of attenuation is equivalent to switching the pad in on your console's mic amp!

Removal of background noise from electronic sources

Gating can be used, typically, when an electric guitar with noisy effects pedals is set at high gain. On the appropriate channel, insert your DN530's processor and, with just the unwanted noise present, turn the threshold up until the gate closes. Set long hold and release times so that the gate does not close on decaying notes, but gates the noise rather than closing abruptly.

Note: *Don't be tempted to set extremely fast attack times. This is an electronic instrument, so we want to avoid ultra-fast transients, that is, the high-energy peak at the beginning of waveforms.*

Try setting the sidechain filter so that the gate is more sensitive to the frequency spectrum of the instrument. Most noise problems will have a predominantly high frequency content.

Drums and percussive instruments

Ideally, to obtain the best results you would set the threshold as low as possible to utilise the gate's fastest possible attack. However, in practice the threshold setting is dictated by the noise floor level, that is, adjacent drums, cymbals etc.

A solution is to use the sidechain filter so that the gate is more sensitive to the bandwidth you want to hear. Do this by adjusting the filter setting to tune the gate to a specific frequency. Then, use the sidechain solo facility to help set the filter; you can do this without interrupting the audio by monitoring from the solo bus output via a spare input on your mixing console.

Transient accentuation

Many instruments have a percussive start to notes that are played. These transients can be enhanced or reduced by careful adjustment of the attack time as described above. Additionally, the DN530 has the ability to accentuate this transition even more through application of its transient accentuation capabilities.

Every time the gate opens, an accent is applied. This is a controlled boost in the signal level that lasts approximately 50ms. The amount of boost applied is determined (in dB) by the accent control, and the speed at which it is applied is determined (in ms) by the attack control. The boost is gradually removed during the 50ms accent period, returning the signal level to normal.



If the gate is being used creatively, the effect of the gate opening transition can be accentuated. This is particularly useful on drums, improving definition and punch.

The accent effect is totally independent of the range control, so it is possible to reduce the range very low or even off (0dB) and still achieve a noticeable enhancement of transients.

Some benefits of transient accentuation are:

- **Increased tonal shaping effectiveness** Gates can be used to modify the leading edge of percussive sounds to add definition and punch. This effect can be massively increased by accenting if required.
- **Reduction of gated breathing** The noise enhancement issues associated with gating background noise can be reduced or totally eliminated, while retaining the tonal shaping and punch that a gate can add to percussive sounds.
- **Reduction of delay** When gates are used to reshape the transient start of a sound they remove a small amount of sound at the start. This effectively causes a slight delay. Digital gates can capture this sound by using look-ahead techniques, but they are not time machines; the way they work is to delay the signal until the gate has opened. This eliminates any losses from the transient, but delays the signal even further. Using transient accentuation with the gate range at minimum (0dB) ensures that absolutely no sound is lost and no delay is introduced. However, controlled accentuation of the transient is still possible.
- **Reduction of resonant howl-round** With high amplification levels it is possible for a drum to resonate in sympathy with the amplified version of itself similar to microphonic howl-round. It is possible for this sound to be so loud that once open a gate will not shut again. If the sound levels are reduced and the drum transients are accentuated the possibility of howl-round is substantially reduced. The transient accentuation only lasts for 50ms, so any risk of resonant build up is restricted to this time period only.

The transient accentuation feature of the DN530 adds another tool for the sound engineer that can be used to enhance and compliment the application of gating to many types of sound source.

Music PA

The more mics there are in a public address (PA) system, the more background noise and stage clutter will be picked up and amplified unless noise gating is used. The most significant improvement in clarity will be obtained by gating those mics that are used least often. For example, the mic used only occasionally by a backing vocalist.

Mics used at a fairly high gain setting, such as on a string section, will pick up a lot of background noise. To improve PA clarity these should also be gated.

Noise gates on the drum mics will also improve the sound of the kit.

Conference PA

In a conference or business presentation PA system there may be several mics in use simultaneously. Since each mic is placed at some distance from the speaker's mouth, the gain setting on the console will be quite high. Background noise, such as outside traffic or air conditioning, will be picked up and amplified, causing a considerable reduction in the signal to noise ratio of the system. The solution is to gate each mic individually using the DN530.



Envelope shaping

A rhythmic pulse of 8th or 16th notes going all the way through a song is a common musical device. This could be a sequenced synthesiser, but a more interesting method is possible using the DN530.

The synthesiser is set up to provide continuous sustained notes (changing according to the harmony of the song), perhaps being processed by a chorus unit before passing through the gate. A drum machine or sequencer is programmed to produce a regular chain of 8th or 16th notes. This is used as the key input to the DN530 (an alternative source of 8th or 16th note pulses is a live bass drum with added echo, timed to give the appropriate repeats).

By adjusting the release time, the synthesiser will appear to play a perfectly timed sequence of notes, which will add interest and rhythm to the arrangement.

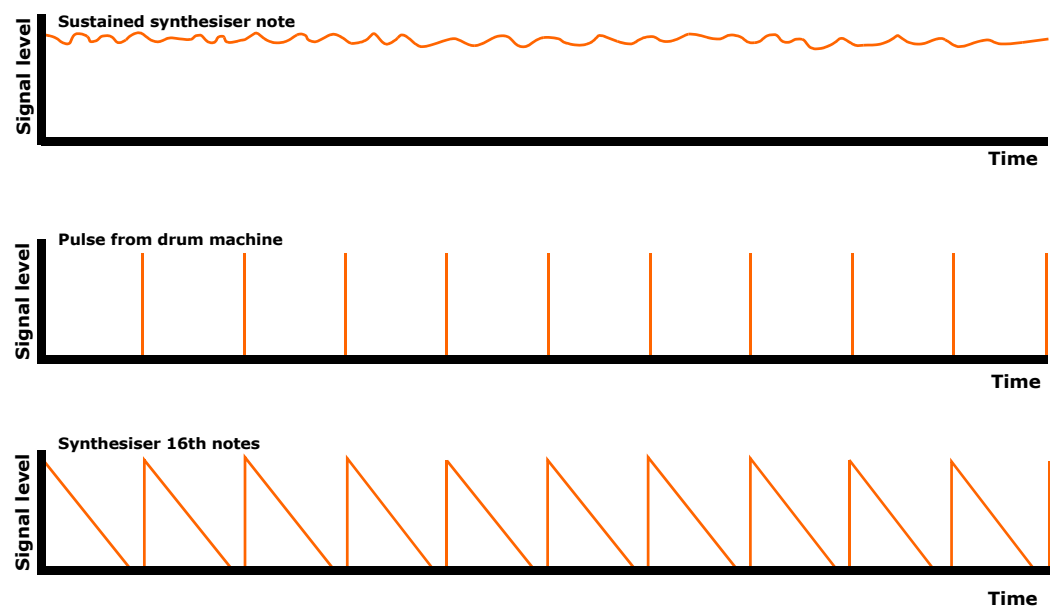

Figure 4: Envelope shaping

In a similar way, a bass drum may be *beefed up* by using it to key a low frequency tone produced by a synthesiser (or even the console oscillator) and mixing this gated tone with the original drum sound. A snare drum may be given added *bite* by keying high frequency noise.

Gating vocals

In a recording studio, vocals usually need to be gated to remove studio ambience, headphone noise, breaths etc. This is best done after the vocal has been committed to the recording medium, otherwise it may be possible to accidentally gate out something that should have been recorded.

If gating is carried out as the vocal is being recorded, it is important not to gate the signal before it is fed to the vocalist's headphones. Many vocalists find a gated headphone feed distracting and it makes it more difficult to find the right note to come in on.



Chatter

Chatter can normally be eliminated by increasing the hold time, but this may allow the gate to stay open longer than is desirable. Adding hysteresis to the threshold control helps enormously and allows hold times to be reduced without signal chatter. The DN530 has 4dB of i-TS hysteresis built in, which is enough to eliminate chatter on all normal instrument types.

Clicking

The key to silent gating is the shape of the gain transition curve that is used to fade up the signal level when the gate opens (attack) and fade it back down when the gate closes (release). Many gates use linear transitions that, when applied to low frequency signals, generate high order harmonics that sound like extra clicks (in time with the music source). The ideal shape is logarithmic (like an audio fader) so that the initial transition from shut to mostly open is fast and the final adjustment to fully open is progressively slower and slower. The exact reverse applies to the gate closing, which needs to start slowly and then speed up to close the gate fully. With these shapes no harmonics are produced during an attack, only a fundamental frequency (quarter cycle) that can be controlled by the attack time.

The tonality of the gate opening transition can be adjusted using the attack control to be slightly higher in pitch than the LF content of the sound it is processing to accentuate the start of each note. Or it can be set to be the same, in which case the transition will not be heard at all. If the attack is made slower still, the start of each note will be softened, which may be useful as an effect. Release times are, typically, much slower so audio frequency clicks are rarely heard, but the logarithmic shape is still the best because it makes the fade out much less noticeable. The attack and release characteristics in the DN530 are logarithmic and fully adjustable to ensure effective gating that can be tonally transparent or used to add (or reduce) punch and definition.

False triggering

Often, mics pick up as much spill from other instruments as the sound they pick up from the intended source. This causes the gate to open at times when it should be shut. Traditionally, hi pass and low pass filters have been employed on gate sidechains in an attempt to limit the frequency spectrum that will trigger the gate to open. This type of filter seldom works well in this application because they are not easily manufactured with steep enough transitions from pass band to stop band. Also, set up is difficult because you typically need to adjust them together to form a band pass filter.

A much better solution is to use a band pass filter in the first place, which is set up with a high enough Q to make it very selective. Most instruments (especially drums) have a resonant frequency, and false gate triggering can be massively improved by tuning a single band pass filter, as described, to find this resonance. False triggering is eliminated because the frequency spectrum and resonance from the spill does not produce enough energy at the tuned frequency to open the gate; only the intended source will.

The DN530 sidechain filters are high Q band pass types as described above. Set up is made by a simple single control (per channel) and this is made even easier because you can listen to the filter output (without interrupting the source material) on a separate solo bus.



Noise enhancement

We all have the ability to block out constant background noises and often using a gate to eliminate background noises altogether defeats this mechanism. This tends to draw our attention to the noise when the gate opens. Typically, adjusting the gate range down to 10dB or 15dB produces results that sound much more natural.

Ducking

Ducking is used to automatically reduce the signal levels when the level of a source signal (from the external sidechain) goes over threshold. This is typically used in situations requiring a voice-over. For example, when an announcer or DJ wants to speak, the background music is automatically made to *duck* (is attenuated) so that their voice can be heard clearly and at a normal level.

De-essing

Compressors have traditionally been used for de-essing, but the degree of de-essing achieved is very level dependent, that is, the loud passages will have sibilance ("s" sounds) attenuated more than the quiet ones.

De-essing using the duck mode of the DN530 is an alternative way of removing sibilance, rather than using compression. Use the solo to tune the sidechain filter into the sibilance (around 10kHz). Set the attack relatively fast (1ms), and similarly with the release (30ms), plus a little hold and then trim the threshold so that the gate meter respond to all the sibilant sounds but not to normal speech. Attenuation ranges that are between 6dB to 10dB will produce the best results, consistently reducing sibilance to the same degree.





Appendix B: Technical Specification

This appendix contains the technical specifications specific to the DN530.

Inputs	Four	
	Type	Analogue, electronically balanced female XLRs (Pin 2 hot)
	Impedance	10k ohms
	Maximum input level	+22dBu
	Common mode rejection	Typically, -80dB at 1kHz
Outputs	Four	
	Type	Analogue, electronically balanced male XLRs (Pin 2 hot)
	Output impedance	<60 ohms
	Maximum output level	+22dBu
	Signal drive capability	<600 ohms
External sidechain inputs	Four	
	Type	Analogue, electronically balanced Jack sockets
	Impedance	20k ohms
	Maximum input level	+22dBu
	Common mode rejection	Typically -60dB at 1kHz
Solo bus input	One	
	Type	Analogue, electronically balanced female XLR (pin 2 hot)
	Input impedance	20k ohms
	Maximum input level	+22dBu
	Common mode rejection	Typically -60dB at 1kHz
Solo bus output	One	
	Type	Analogue, electronically balanced male XLR (pin 2 hot)
	Output impedance	<60 ohms
	Maximum output level	+22dBu
	Signal drive capability	<600 ohms
Performance	Maximum gate gain reduction	Greater than -90dB
	Maximum accent gain	+12dB
	Maximum signal level any input or output	+22dBu
	Noise at main output with unity gain	-94dBu
	Distortion at 1KHz 0dBu with steady unity gain condition	<0.05%
	Signal delay	0 seconds
	Frequency response	±0.5dBu (input to output), 20Hz to 20kHz
	Dynamic range	>116dB (22Hz to 22kHz unweighted)



Gate	Threshold	Scale = -50dB to +25dB
	Range	Scale = $-\infty$ (minus infinity) to 0dB
	Attack	Scale = 30 μ s to 10ms
	Release	Scale = 2ms to 2s
	Hold	Scale = 2ms to 2s
	Accent	Scale = 0dB to +12dB
Filter	Sidechain filter	Scale = 40Hz to 16kHz
Terminations	Audio	3-pin XLRs (male and female) and 1/4" TRS balanced jack sockets
	Power	3-pin IEC
Power requirements	Voltage	100VAC to 240VAC \pm 10%
	Frequency	50Hz to 60Hz
	Consumption	<25W
Dimensions	Height	44.5 mm (1.75"), 1U high
	Width	483 mm (19")
	Depth	305 mm (12")
Weight	Net	4.6 kg
	Shipping	5.6 kg
Operation	Temperature	+5°C to +45°C
Storage	Temperature	-20°C to +60°C

Due to a policy of continual improvement, Klark Teknik reserves the right to alter the function or specification at any time without notice.



Appendix C: Functional Block Diagram

The following page contains the signal flow diagram for the DN530.

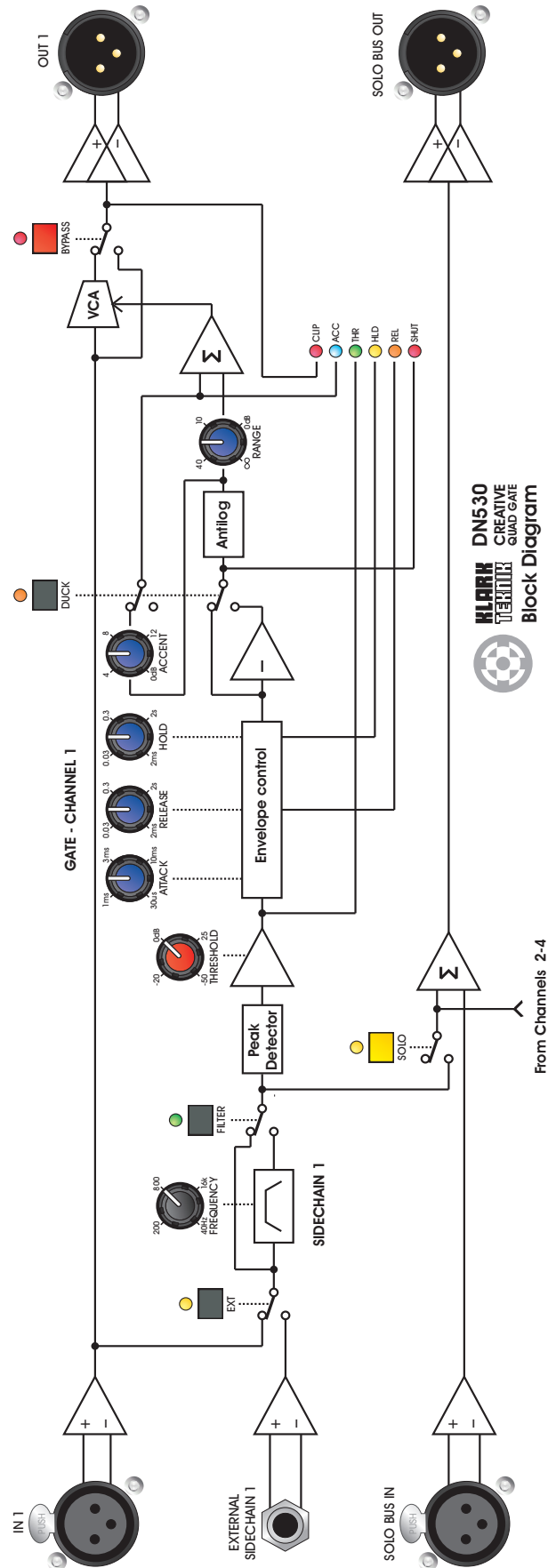

KLARK
TEKNIK
DN530
CREATIVE
QUAD GATE
Block Diagram



Appendix D: *Balanced/Unbalanced Audio*

Balancing refers to the type of input or output signal connections in an audio system. These connections are specifically designed to reject external noise, such as from mains wiring and internal interference from adjacent signal cables. Unlike unbalanced lines, which are more susceptible to noise, balancing is especially useful when long cable runs are used between pieces of equipment and can also provide other benefits, including an increase in line signal level and a decreased possibility of ground loops. Balanced connections are typically employed on long cable runs, such as to amplifiers, or for cables carrying sensitive or low level signals, for example, mics. A balanced line typically employs connectors of the XLR and 1/4" TRS jack plug types.

The basic principle of balanced interconnection is the cancelling out of any electrical noise by means of a three-cable connection to achieve the required signal. Two of the cables, called "hot" and "cold", are used to carry signals, and the third is a grounded shield that surrounds the hot and cold cables. (An unbalanced connection only has two cables, one of which, the grounded shield, is also used for signal return.) As the hot and cold cables are of equal voltage (and the same source impedance), but of opposite polarity, when they are subtracted any noise voltages — caused by interference and noise pick-up — appearing identically on both cables is cancelled out; the difference between them being the resultant signal.

However, in practice the electrical noise on both cables will never be identical, and the degree to which it is reduced is measured by the common mode rejection ratio (CMRR). The electronically balanced input and output connections of the DN530 have the benefit of high common mode rejection (CMR), which eliminates externally induced interference such as mains hum etc. CMR is the ability of a balanced input to reject the part of the incoming signal that has the same amplitude and opposite phase on both input terminals, referenced to ground. As a specification, CMR is usually stated as a dB ratio, called CMRR, at a given frequency.

Note: *On balanced circuits, the 'hot' signal is also known as "+ve" and "in phase", while the 'cold' signal is also known as "-ve" and "out of phase".*





Appendix E: Crib Sheet

The following page contains a crib sheet. You can photocopy (or print) this page if you want more copies.



GATE - CHANNEL 1 <input type="radio"/> CLIP <input type="radio"/> ACC <input type="radio"/> THR <input type="radio"/> HD <input type="radio"/> REL <input type="radio"/> SHUT	GATE - CHANNEL 2 <input type="radio"/> CLIP <input type="radio"/> ACC <input type="radio"/> THR <input type="radio"/> HD <input type="radio"/> REL <input type="radio"/> SHUT	GATE - CHANNEL 3 <input type="radio"/> CLIP <input type="radio"/> ACC <input type="radio"/> THR <input type="radio"/> HD <input type="radio"/> REL <input type="radio"/> SHUT	GATE - CHANNEL 4 <input type="radio"/> CLIP <input type="radio"/> ACC <input type="radio"/> THR <input type="radio"/> HD <input type="radio"/> REL <input type="radio"/> SHUT	SIDECHAIN 1 <input type="radio"/> SOLO <input type="radio"/> EXT <input type="radio"/> FILTER <input type="radio"/> FREQUENCY	SIDECHAIN 2 <input type="radio"/> SOLO <input type="radio"/> EXT <input type="radio"/> FILTER <input type="radio"/> FREQUENCY	SIDECHAIN 3 <input type="radio"/> SOLO <input type="radio"/> EXT <input type="radio"/> FILTER <input type="radio"/> FREQUENCY	SIDECHAIN 4 <input type="radio"/> SOLO <input type="radio"/> EXT <input type="radio"/> FILTER <input type="radio"/> FREQUENCY
---	---	---	---	---	---	---	---

Location: _____ **Date:** _____

Application: _____

GATE - CHANNEL 1 <input type="radio"/> CLIP <input type="radio"/> ACC <input type="radio"/> THR <input type="radio"/> HD <input type="radio"/> REL <input type="radio"/> SHUT	GATE - CHANNEL 2 <input type="radio"/> CLIP <input type="radio"/> ACC <input type="radio"/> THR <input type="radio"/> HD <input type="radio"/> REL <input type="radio"/> SHUT	GATE - CHANNEL 3 <input type="radio"/> CLIP <input type="radio"/> ACC <input type="radio"/> THR <input type="radio"/> HD <input type="radio"/> REL <input type="radio"/> SHUT	GATE - CHANNEL 4 <input type="radio"/> CLIP <input type="radio"/> ACC <input type="radio"/> THR <input type="radio"/> HD <input type="radio"/> REL <input type="radio"/> SHUT	SIDECHAIN 1 <input type="radio"/> SOLO <input type="radio"/> EXT <input type="radio"/> FILTER <input type="radio"/> FREQUENCY	SIDECHAIN 2 <input type="radio"/> SOLO <input type="radio"/> EXT <input type="radio"/> FILTER <input type="radio"/> FREQUENCY	SIDECHAIN 3 <input type="radio"/> SOLO <input type="radio"/> EXT <input type="radio"/> FILTER <input type="radio"/> FREQUENCY	SIDECHAIN 4 <input type="radio"/> SOLO <input type="radio"/> EXT <input type="radio"/> FILTER <input type="radio"/> FREQUENCY
---	---	---	---	---	---	---	---

Location: _____ **Date:** _____

Application: _____

GATE - CHANNEL 1 <input type="radio"/> CLIP <input type="radio"/> ACC <input type="radio"/> THR <input type="radio"/> HD <input type="radio"/> REL <input type="radio"/> SHUT	GATE - CHANNEL 2 <input type="radio"/> CLIP <input type="radio"/> ACC <input type="radio"/> THR <input type="radio"/> HD <input type="radio"/> REL <input type="radio"/> SHUT	GATE - CHANNEL 3 <input type="radio"/> CLIP <input type="radio"/> ACC <input type="radio"/> THR <input type="radio"/> HD <input type="radio"/> REL <input type="radio"/> SHUT	GATE - CHANNEL 4 <input type="radio"/> CLIP <input type="radio"/> ACC <input type="radio"/> THR <input type="radio"/> HD <input type="radio"/> REL <input type="radio"/> SHUT	SIDECHAIN 1 <input type="radio"/> SOLO <input type="radio"/> EXT <input type="radio"/> FILTER <input type="radio"/> FREQUENCY	SIDECHAIN 2 <input type="radio"/> SOLO <input type="radio"/> EXT <input type="radio"/> FILTER <input type="radio"/> FREQUENCY	SIDECHAIN 3 <input type="radio"/> SOLO <input type="radio"/> EXT <input type="radio"/> FILTER <input type="radio"/> FREQUENCY	SIDECHAIN 4 <input type="radio"/> SOLO <input type="radio"/> EXT <input type="radio"/> FILTER <input type="radio"/> FREQUENCY
---	---	---	---	---	---	---	---

Location: _____ **Date:** _____

Application: _____



Appendix F: Service Information

This appendix contains routine service and maintenance instructions.

Routine maintenance

To help keep your DN530 unit in good working order and to make sure it gives you optimum performance, we recommend that you carry out the following at monthly intervals:

- Clean the unit (see "Cleaning" below).
- Check the controls for freedom of operation.
- Check the functionality of all controls, that is, control knobs, pushbuttons and LEDs. You can carry out a visual check of all illuminated items (LEDs etc.) by switching the unit off and then on again, as they should all illuminate during power up.
- Check the functionality of the equipment.

Cleaning

Switch off the unit and electrically isolate it from the mains *before* cleaning.

Clean the DN530 using a dry, lint-free cloth. Do not use harsh abrasives or solvents. When cleaning the unit, take great care not to damage control knobs, pushbuttons etc.

Replacing the mains fuse

The equipment must be independently isolated from the mains voltage supply before any attempt is made to change the protective fuse. The fuse and its cover must always be replaced before the equipment is reconnected to the mains voltage supply.

Only use the correct replacement type when changing the fuse. Fuse specification is printed on the rear cover.

To remove the fuse, pull out the fuse drawer (see "Mains input" on page 17). Then, prise out the fuse from the furthest compartment (the nearest compartment is for a spare fuse); a small, flat-bladed screwdriver may be useful for this.

Insert a new fuse in the rear fuse compartment, and close the drawer.

After replacing a fuse, check that the unit is working properly.

Always ensure that there is a spare fuse available.



Equipment disposal

When this equipment has come to the end of its useful life, its disposal may come under the DIRECTIVE 2002/96/EC OF THE EUROPEAN PARLIAMENT AND OF THE COUNCIL of 27 January 2003 on waste electrical and electronic equipment (WEEE).

Hazardous substances in WEEE contaminate water, soil and air and ultimately put at risk our environment and health. The directive aims to minimize the impacts of WEEE on the environment during their life times and when they become waste.

The WEEE directive addresses the disposal of products when they have reached the end of their life and contributes to the reduction of wasteful consumption of natural resources. This will help to reduce pollution, and protect the environment and ourselves.



If this equipment carries a 'crossed-out wheelie bin' (shown left), please do not dispose of WEEE as unsorted municipal waste but collect and dispose of in accordance with local WEEE legislation. The horizontal bar underneath indicates that the product was placed on the EU market after 13th August 2005.



For WEEE disposal, see our website at www.klarktechnik.com for information.

Thank you for reading through this Operator Manual.
We hope you found it useful.

Please feel free to send us your comments.
Our contact details and website address can be found
at the front of this manual.



KLARK TEKNIK
SIGNAL PROCESSING BY DEFINITION

Klark Teknik
Klark Industrial Park, Walter Nash Road,
Kidderminster. Worcestershire. DY11 7HJ. England.
Tel: +44 1562 741515, Fax: +44 1562 745371
Email: info@midasklarktechnik.com
Website: www.klarktechnik.com

Free Manuals Download Website

<http://myh66.com>

<http://usermanuals.us>

<http://www.somanuals.com>

<http://www.4manuals.cc>

<http://www.manual-lib.com>

<http://www.404manual.com>

<http://www.luxmanual.com>

<http://aubethermostatmanual.com>

Golf course search by state

<http://golfingnear.com>

Email search by domain

<http://emailbydomain.com>

Auto manuals search

<http://auto.somanuals.com>

TV manuals search

<http://tv.somanuals.com>