

Tone	Tone Type	Tone Description / Application	Dip Switch (S1/S2)	3rd Stage Tone	Peak Sound Level (dBA@1m)	Sounder Current (mA Avg)
1.		970Hz (BS5839-1:2002)	0-0-0-0-0-0	18	105	31
2.		800Hz/970Hz @ 2Hz (BS5839-1:2002)	0-0-0-0-0-1	1	105	28
3.		800Hz - 970Hz @ 1Hz (BS5839-1:2002)	0-0-0-0-1-0	1	104	25
4.		970Hz 1s OFF/1s ON (Apollo Fire Systems Alert Tone, BS5839-1:2002)	0-0-0-0-1-1	1	105	17
5.		970Hz, 0.5s/ 630Hz, 0.5s (Apollo Fire Systems Evacuate Tone, BS5839-1:2002)	0-0-0-1-0-0	1	105	27
6.		554Hz, 0.1s/ 440Hz, 0.4s (France - AFNOR NF S 32 001)	0-0-0-1-0-1	1	103	20
7.		500 - 1200Hz, 3.5s/ 0.5s OFF (Netherlands - NEN 2575:2000)	0-0-0-1-1-0	1	108	19
8.		420Hz 0.625s ON/0.625s OFF (Australia AS1670 Alert tone)	0-0-0-1-1-1	1	102	10
9.		500 - 1200Hz, 0.5s/ 0.5s OFF x 3/ 1.5s OFF (Australia AS1670 Evacuation tone)	0-0-1-0-0-0	1	106	13
10.		550Hz/440Hz @ 0.5Hz	0-0-1-0-0-1	19	104	21
11.		970Hz, 0.5s ON/0.5s OFF x 3/ 1.5s OFF (ISO 8201 Low tone)	0-0-1-0-1-0	1	105	13
12.		2850Hz, 0.5s ON/0.5s OFF x 3/ 1.5s OFF (ISO 8201 High tone)	0-0-1-0-1-1	1	107	16
13.		1200Hz - 500Hz @ 1Hz (DIN 33 404)	0-0-1-1-0-0	1	109	22
14.		400Hz	0-0-1-1-0-1	18	101	16
15.		550Hz, 0.7s/1000Hz, 0.33s	0-0-1-1-1-0	1	105	25
16.		1500Hz - 2700Hz @ 3Hz (Vandal Alarm)	0-0-1-1-1-1	1	113	32
17.		Simulated Bell	0-1-0-0-0-0	1	107	18
18.		840Hz	0-1-0-0-0-1	1	110	26
19.		660Hz	0-1-0-0-1-0	10	102	25
20.		660Hz 1.8s ON/1.8s OFF	0-1-0-0-1-1	19	102	14
21.		660Hz 0.15s ON/0.15s OFF	0-1-0-1-0-0	19	102	14
22.		510Hz, 0.25s/ 610Hz, 0.25s	0-1-0-1-0-1	1	103	24
23.		800/1000Hz 0.5s each (1Hz)	0-1-0-1-1-0	1	106	25
24.		250Hz - 1200Hz @ 12Hz	0-1-0-1-1-1	1	101	23
25.		500Hz - 1200Hz @ 0.33Hz.	0-1-1-0-0-0	1	108	21
26.		2400Hz - 2900Hz @ 9Hz	0-1-1-0-0-1	1	113	39
27.		2400Hz - 2900Hz @ 3Hz	0-1-1-0-1-0	1	111	39
28.		800Hz - 970Hz @ 100Hz	0-1-1-0-1-1	1	104	23
29.		800Hz - 970Hz @ 9Hz	0-1-1-1-0-0	1	104	27
30.		800Hz - 970Hz @ 3Hz	0-1-1-1-0-1	1	105	28
31.		800Hz, 0.25s ON/1s OFF	0-1-1-1-1-0	1	103	8
32.		500Hz - 1200Hz, 3.75s/0.25s OFF (AS2220)	0-1-1-1-1-1	1	108	20
33.		340Hz	1-0-0-0-0-0	1	101	17
34.		1000Hz	1-0-0-0-0-1	18	106	25
35.		1400Hz - 1600Hz, 1s/1600Hz - 1400Hz, 0.5s (NF 48-265)	1-0-0-0-1-0	1	104	34
36.		660Hz 6.5s ON/13s OFF	1-0-0-0-1-1	19	102	9
37.		1000Hz/2000Hz, 1s each	1-0-0-1-0-0	1	108	25
38.		720Hz, 0.7s ON/0.3s OFF	1-0-0-1-0-1	1	104	16
39.		970Hz, 0.25s ON/OFF	1-0-0-1-1-0	1	105	17
40.		2800Hz, 1s ON/OFF	1-0-0-1-1-1	1	106	20
41.		2800Hz 0.25s ON/OFF	1-0-1-0-0-0	1	106	19
42.		2400/2900 @ 2Hz	1-0-1-0-0-1	1	113	38
43.		Chime, 554Hz/440Hz Single shot 'ding dong'	1-0-1-0-1-0	1	100	15
44.		Chime, 554Hz/440Hz Repeating 'ding dong'	1-0-1-0-1-1	1	102	15
45.		Chime, 970Hz/800Hz Single shot 'ding dong'	1-0-1-1-0-0	1	101	36
46.		Chime, 970Hz/800Hz Repeating 'ding dong'	1-0-1-1-0-1	1	100	36
47.		Hooter, Repeating	1-0-1-1-1-0	1	102	13
48.		Gentle alarm - Tone 2, rises slowly to full volume over 30s	1-0-1-1-1-1	1	105	28
49.		Time-Out Alarm - As Tone 2, cuts off after 10 mins	1-1-0-0-0-0	1	105	28
50.		Time-Out Alarm - As Tone 2, cuts off after 2 mins	1-1-0-0-0-1	1	105	28
51.		750Hz 0.33s ON/0.51s OFF	1-1-0-0-1-0	1	103	8
52.		750Hz 0.51s ON/0.33s OFF	1-1-0-0-1-1	1	103	15
53.		550Hz, 0.33s/1000Hz, 0.7s	1-1-0-1-0-0	1	106	25
54.		600Hz - 900Hz/ 0.9s	1-1-0-1-0-1	1	104	31
55.		660Hz - 680Hz/ 0.9s	1-1-0-1-1-0	1	101	28
56.		670Hz - 725Hz/ 0.9s	1-1-0-1-1-1	1	104	25
57.		920Hz - 750Hz/ 0.9s	1-1-1-0-0-0	1	104	30
58.		700Hz - 900Hz, 0.3s/0.6s OFF	1-1-1-0-0-1	1	104	11
59.		900Hz - 760Hz, 0.6s/0.3s OFF	1-1-1-0-1-0	1	105	19
60.		750Hz	1-1-1-0-1-1	18	103	22
61.		Power Only - Use with Stage 3 control for manual/intermittent chime triggering	1-1-1-1-0-0	43		
62.		Power Only - Use with Stage 3 control for manual/intermittent chime triggering	1-1-1-1-0-1	43		
63.		Power Only - Use with Stage 3 control for manual/intermittent horn triggering	1-1-1-1-1-0	47		
64.		Reserved for future use	1-1-1-1-1-1			

EN54-3

Fire Alarm Device - Sounder

Type B: For indoor or outdoor use

18-980542/543/544/653/655/588/620/621/658/659/657

Technical Data: Document 18-186528



0832-CPD-0615 (Sounder-LED Beacon)
0832-CPD-0616 (Sounder-Xenon Beacon)
0832-CPD-0617 (Sounder)



Installation Instructions

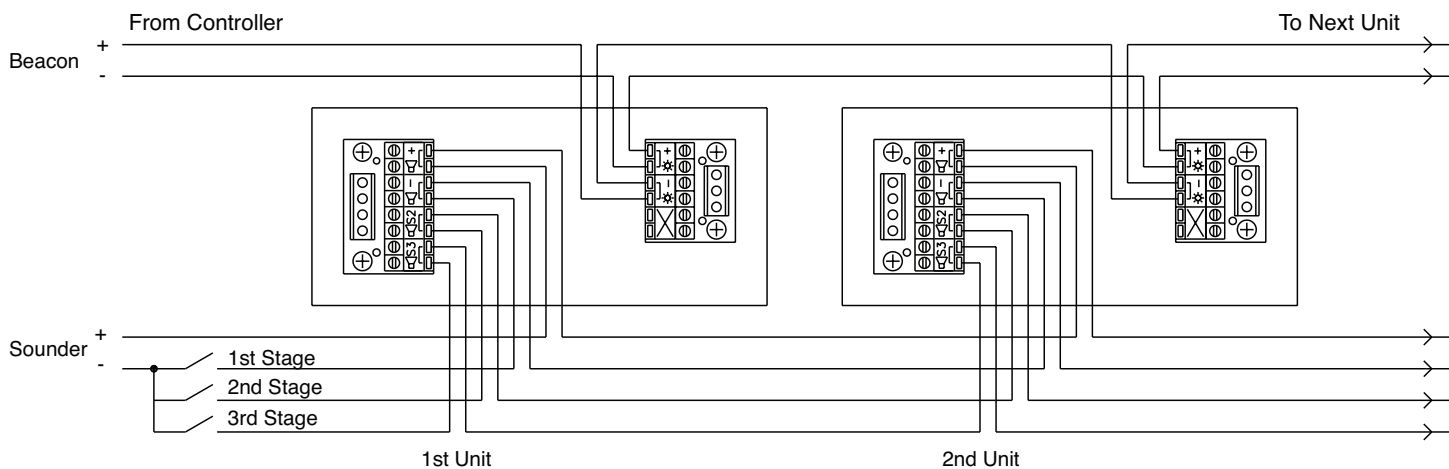

EN

Installation Manual

Installation

- The sounder is installed by first mounting the base unit and making the external wiring connections to the base. The head unit then automatically connects when it is attached to the base.
- The sounder head is separated from the base by unlocking the four ¼-turn fasteners in the corners of the sounder. (Recommended screwdriver: Philips No. 2, min 100mm long).
- Note that the head only fits onto the base one way around. If a beacon is fitted, care should be taken when mounting the base to ensure that the beacon will be positioned in the desired orientation after the sounder is attached

Wiring

The sounder and beacon have separate wiring terminals. Each terminal is duplicated to enable simple 'daisy-chain' connection of multiple units.

Line	Terminal Marking
Sounder Positive Supply (10 to 60V DC)	+
Sounder Negative Supply (0V)	-
2nd Stage Alarm Control (Connect to 0V to activate)	S2
3rd Stage Alarm Control (Connect to 0V to activate)	S3
Beacon Positive Supply (10 to 60V DC)	+
Beacon Negative Supply (0V)	-

Controls

- Tone Selection**
The first and second stage alarm tones are independently set using 6-way dipswitches S1 and S2 respectively. The required settings are shown in the table overleaf. The third stage alarm tone is pre-set to complement the selected first stage tone as shown in the table.
- Volume Control**
The sound output of the unit can be reduced by up to 20dBA by adjusting the potentiometer.
- Beacon Flash Controls (If fitted)**
The flash mode of the beacon can be altered using the 2-way dipswitch marked

Switch	XENON BEACON		LED BEACON	
	Off	On	Off	On
1	60 flashes per min	30 flashes per min	Single Flash	Double Flash
2	Single Flash	Double Flash	Flashing	Static

Technical Specification:

Supply Voltage Range.....	10-60V DC
Current – Sounder.....	8-40mA* (Typ. 30mA @ 24V, Tone 1)
Current –Beacon.....	Xenon - 250mA Average, 700mA Peak*, (Where fitted) LED - 18mA (Flashing) or 65mA (Static)*
Peak Sound Level	100-113 dBA at 1m* (Typ. 105dBA @ 24V, Tone 1)
Number of Tones.....	64
Volume Control	20dBA typical
Remote Tone Switching.....	Provision for 3 alarm stages (Negative voltage activation)
Operating Temperature	-25°C to +70°C
Casing.....	High Impact Polycarbonate/ABS
IP Rating.....	IP66
Synchronisation	Automatic with Klaxon Nexus and Sonos Sounders

*depends on selected tone and input voltage. See tone table for details.
EN54-3 certified on tones 1,2,3,6,7 & 13 & > 17V DC only.



The European directive "Waste Electrical and Electronic Equipment" (WEEE) aims to minimise the impact of electrical and electronic equipment waste on the environment and human health. To conform with this directive, electrical equipment marked with this symbol must not be disposed of in European public disposal systems. European users of electrical equipment must now return end-of-life equipment for disposal. Further information can be found on the following website: <http://www.recyclethis.info/>.







DE Installationsanweisung

Einbau

- Zum Installieren des Alarmgebers zunächst die Basis montieren und externe Kabel an die Basis anschließen. Sobald der Kopf auf der Basis befestigt ist, wird die Verbindung automatisch hergestellt.
- Um den Kopf von der Basis abzunehmen, die vier Befestigungen in den Ecken des Alarmgebers durch ¼ Drehung entriegeln. (Empfohlener Schraubendreher: Philips Nr. 2, mind. 100mm lang).
- Hinweis: Der Kopf lässt sich nur in einer Richtung auf die Basis setzen. Bei gleichzeitiger Verwendung einer Signalleuchte sollte beim Montieren der Basis darauf geachtet werden, dass die Signalleuchte nach Aufsetzen des Signalgebers korrekt ausgerichtet ist.

Kabelanschlüsse

Alarmgeber und Signalleuchte haben gesonderte Anschlussklemmen. Jede Klemme wird dupliziert, sodass mehrere Geräte problemlos hintereinander angeschlossen werden können.

Leitung	Klemmen-Kennzeichnung
Positive Versorgungsspannung Alarmgeber (10 bis 60V Gleichstrom)	 +
Negative Versorgungsspannung Alarmgeber (0V)	 -
Alarmregelung 2. Stufe (zum Aktivieren an 0V anschließen)	 S2
Alarmregelung 3. Stufe (zum Aktivieren an 0V anschließen)	 S3
Positive Versorgungsspannung Signalleuchte (10 bis 60V Gleichstrom)	 +
Negative Versorgungsspannung Signalleuchte (0V)	 -

Bedienung

- Tonwahl**
Die Alarmtöne der ersten und zweiten Stufe werden mithilfe der 6-Wege-DIP-Schalter S1 bzw. S2 unabhängig eingestellt. Die erforderlichen Einstellungen sind in der Tabelle auf der nächsten Seite angegeben. Der Alarmton der dritten Stufe ist zur Ergänzung des Tons der ersten Stufe voreingestellt (siehe Tabelle).
- Lautstärkeregelung**
Durch Regulierung des Potentiometers kann die Lautstärke des Geräts um bis zu 20dBa reduziert werden.
- Regulierung des Blinkens der Signalleuchte (sofern vorhanden)**
Der Blinkmodus der Signalleuchte kann mithilfe des mit  gekennzeichneten 2-Wege-DIP-Schalters reguliert werden.

Schalter	XENON-LEUCHTE		LED-LEUCHTE	
	Aus	Ein	Aus	Ein
1	60 Blinken/Min.	30 Blinken/Min.	Ein Aufblinken	Doppeltes Aufblinken
2	Ein Aufblinken	Doppeltes Aufblinken	Blinken	Konstant

Technische Spezifikation:

Versorgungsspannung	10-60V Gleichstrom
Stromstärke - Alarmgeber	8-40mA* (Typ. 45mA bei 24V, Ton 1)
Stromstärke - Signalleuchte (sofern vorhanden)	Xenon - 250mA Durchschnitt, 700mA Spitzen*, LED - 18mA (Blinkend) oder 65mA (Konstant)*
Tonspitzen	100-113 dBA in 1m* (Typ. 105dBA bei 24V, Ton 1)
Anzahl Töne	64
Lautstärkeregelung	20dBa typisch
Ferngesteuerte Tonumschaltung	3 Alarmstufen (Aktivierung durch Negativspannung)
Betriebstemperatur	-25°C bis +70°C
Gehäuse	Stoßfestes Polycarbonat/ABS
IP-Klasse	IP66
Synchronisierung	Automatisch mit Klaxon Nexus- und Sonos-Alarmgebern

*je nach gewähltem Ton und Eingangsspannung. Ausführliche Informationen siehe Tontabelle. EN54-3 zertifiziert nur für Töne 1,2,3,6,7 und 13 und > 17V Gleichstrom.

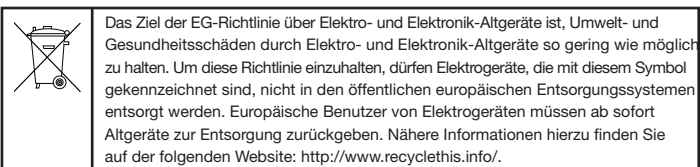







FR Installation Manual

Spécifications techniques

- Le socle de la sirène doit être fixé au préalable.
- Les raccordements s'effectuent directement sur le socle de la sirène.
- La sirène est ensuite vissée sur le socle via 4 vis ¼ de tour (utiliser uniquement un tournevis de type Philips 2 x 100).

Câblage

La sirène et le flash possèdent des connecteurs séparés. Chaque bornier est doublé facilitant ainsi le raccordement d'autres sirènes.

Alimentation	Bornier
+ Alimentation (signal sonore)	 +
- Alimentation (signal sonore)	 -
2ème son (si besoin)	 S2
3ème son (si besoin)	 S3
+ Alimentation (signal lumineux)	 +
- Alimentation (signal lumineux)	 -

Les deuxième et troisième sons (contrôle à distance) sont activés par les connecteurs  S2 et  S3.

Note : Il n'est pas autorisé d'utiliser les deuxième et troisième sons quand le système demande le son AFNOR NFS32001

Contrôle des signaux visuel et sonore

- Contrôle des sons :**
La sirène est programmée sur le son AFNOR NFS32001. D'autres sons peuvent être sélectionnés en utilisant les 5 microcontacts S1/S2 de la sirène. Voir le tableau de choix des sons pour plus de détails sur les sons disponibles et la position des microcontacts correspondante.
- Contrôle du volume :**
Fonction non disponible lorsque la sirène est utilisée en son AFNOR NF-S 32.001 (554Hz, 0.1s/440Hz, 0.4s).
- Contrôle du signal lumineux :**
Le mode de fonctionnement du flash peut être modifié en utilisant les 2 microcontacts identifiés par le symbole .

Position	Flash (LED)	
	Off	On
1	Simple Flash	Double Flash
2	Clignotant	Fixe

Spécifications techniques:

Tension admissible	10 à 60 Vcc
Consommation signal sonore	8-40 mA (sous 24Vcc) / 30mA (sous 24Vcc)
Consommation signal sonore et lumineux	250mA (sous 24Vcc) / 700mA (sous 48Vcc)
Puissance sonore maximum	100-113 dBA @ 1m
Sons	64 dont le son AFNOR NF-S 32.001 (554Hz, 0.1s/440Hz, 0.4s)
Signal lumineux	3 modes configurables par cavalier (simple flash, double flash, et fixe)
Gamme de fréquence	De 400 à 2850 Hz*
Température de fonctionnement	De -25°C à +70°C
Matière	Polycarbonate résistant au choc
Degré d'étanchéité	IP66
Synchronisation	Automatique avec d'autres sirènes Klaxon (SONOS & NEXUS)

* Variable selon les sons et les tensions. Voir tableau des sons pour plus d'informations. Certifié selon la EN54-3 pour les tons 1, 2, 3, 6, 7, 13 et >17V DC.



La directive européenne * Déchets d'Equipements Electriques et Electroniques (DEEE) a pour but de minimiser l'impact des déchets électriques et électroniques sur l'environnement et la santé humaine. Conformément à cette directive, tout équipement électrique disposant de ce symbole ne doit pas être jeté dans les systèmes d'évacuation des déchets publics européens. Les utilisateurs européens d'équipement électrique doivent désormais renvoyer tout équipement électrique en fin de vie pour évacuation. Vous trouverez de plus amples informations sur le site Web suivant : <http://www.recyclethis.info/>.

Installatie

- De sounder wordt geïnstalleerd door eerst de basiseenheid te monteren en dan de externe bedradingaansluitingen aan de basis te maken. De hoofdeenheid sluit dan automatisch aan wanneer het aan de basis wordt bevestigd.
- De sounderkop wordt van de basis gescheiden door de vier draaibevestigingen die zich in de hoeken van de sounder bevinden te openen. (Aanbevolen schroevendraaier: Philips Nr. 2, min 100mm lang).
- Merk op dat de kop enkel via een manier op de basis kan bevestigd worden. Als er een bakenzender is geïnstalleerd, moet men voorzichtig zijn bij het monteren van de basis om ervoor te zorgen dat de bakenzender in de gewenste positie wordt geplaatst nadat de sounder aangehecht werd.

Bedrading

Merk op dat de sounder en de bakenzender afzonderlijke voedingsaansluiting hebben, die als volgt worden aangeduid. Toonshakelaar op afstand (indien vereist): Verbind extern de bedringsaansluitingen zoals hieronder weergegeven.

Lijn	Contact markerin
Sounder positieve stroom (10 tot 60V gelijkstroom)	 +
Sounder negatieve stroom (0V)	 -
2de fase alarmregeling (Sluit aan op 0V om te activeren)	 S2
3rd fase alarmregeling (Sluit aan op 0V om te activeren)	 S3
Sounder positieve stroom (10 tot 60V gelijkstroom)	 +
Bakenzender negatieve stroom (0V)	 -

Regeling

- Toonselectie**
De eerste en tweede fase alarmtonen worden onafhankelijk ingesteld door gebruik van 6-weg dimschakelaars S1 en S2. De vereiste instellingen worden in de tabel op de ommezijde weergegeven. De derde fase alarmtoon is preset als aanvulling de geselecteerde eerste fase toon, zoals weergegeven op de tabel.
- Volumeregeling**
De geluidsuitvoer van het apparaat kan tot 20dBA verminderd worden door de potentiometer (volumeknop) af te stellen.
- Bakenzender knipperregeling (indien gemonteerd)**
De knippermodus van de bakenzender kan gewijzigd worden door gebruik van de 2-weg dimschakelaars gemarkeerde 

Xenon		LED		
Schakelaar	Van	Op	Van	Op
1	60 Flitsen per min	30 Flitsen per min	Kies flits uit	De dubbele flits
2	Kies flits uit	De dubbele flits	Het flits	De luchtstoring

Technische specificaties:

Spanningsbereik	10-60V
Stroomsterkte alarm	8-40mA* (typ. 30mA @ 24z, toon 1)
Stroomsterkte bakenzender.....	Xenon - 250mA gemiddelde, 700mA max LED - 18mA (flikkerde) of 65mA (luchtstoring)*
Geluidsniveaupiek	100 - 113 dBA aan 1m* (typ. 105dBA @ 24V toon 1)
Aantal tonen	64
Volume-instelling	20dBA typische
Verre toon schakelen	Bevoorrad voor 3 alarmstadiums (negatieve spanningsactivering)
Gebruikstemperatuur	- 25°C bis +70°C
Behuizing	Slagvast polycarbonaat
IP waarde	IP66
Synchronisatie.....	Automatisch

* Variable selon les sons et les tensions. Voir tableau des sons pour plus d'informations. Certifié selon la EN54-3 pour les tons 1, 2, 3, 6, 7 et 13 et > 17V DC enkel









Instalación

- El receptor acústico se instala después de montar la unidad de base y realizar las conexiones de cableado externo a la misma. A continuación, la unidad de cabeza se conecta automáticamente cuando se acopla a la base.
- La cabeza del receptor acústico se separa de la base al desbloquear los cuatro cierres giratorios situados en las esquinas del receptor acústico. (Destornillador recomendado: Philips Nº 2, mín. 100 mm de largo).
- Tenga en cuenta que la cabeza sólo se ajusta a la base de una forma. Si se ajusta una luz, deberá tener cuidado al montar la base para asegurarse de que la luz se coloque en la orientación deseada tras acoplar el receptor acústico.

Cableado

Tenga en cuenta que el receptor acústico y la luz tienen terminales de potencia independientes, que están marcados como sigue. Conmutación de tono remoto (si es necesario): Vincule externamente los terminales de control como se indica a continuación.

Línea	Terminal
Alimentación positiva del receptor acústico (10-60 V CC)	 +
Alimentación negativa del receptor acústico (0 V)	 -
Control de alarma de nivel 2 (conectar a 0 V para activación)	 S2
Control de alarma de nivel 3 (conectar a 0 V para activación)	 S3
Alimentación positiva de la luz (10-60 V CC)	 +
Alimentación negativa de la luz (0 V)	 -

Controles

- Selección de tono**
Los tonos de alarma de nivel 1 y 2 se ajustan de forma independiente mediante conmutadores S1 y S2 de 6 formas, respectivamente. Los ajustes necesarios aparecen en el dorso de la tabla. El tono de alarma de nivel 3 se preajusta para complementar el nivel de tono 1 seleccionado tal como muestra la tabla.
- Control de volumen**
La emisión de sonido de la unidad puede reducirse hasta 20 dBA gracias al potenciómetro.
- Controles de parpadeo de la luz (si está ajustada)**
El modo de parpadeo de la luz puede alterarse mediante los conmutadores de 2 formas. 

Xenon		LED		
Interruptor	Off	En	Off	En
1	60 parpadea por min	30 parpadea por min	solo parpadeo	doble parpadeo
2	solo parpadeo	doble parpadeo	parpadeante	constante

Especificaciones Técnicas:

Voltaje de Alimentación	10-60V
Corriente Receptor acústico	8-40mA * Typ. 30mA @ tono 24V 1
Corriente Luz	Xenon - 250mA avg. 700mA* max LED - 18mA (parpadeante) o 65mA (Constante)*
Nivel máximo de sonido	100-113 dBA à 1m* (typ. 105 dBA @ 24V, tono 1)
Número de tonos	64
Ajuste del volumen	20 dBA (típico)
Tono remoto que cambia	La provisión para 3 etapas de la alarma (la activación negativa del voltaje)
Temperatura de trabajo	- 25 °C à +70 °C
Caja.....	Polycarbonato de gran resistencia al impacto
Régimen IP.....	IP66
Sincronización	Automática

* depende del tono seleccionado y la tensión de alimentación. Ver la tabla de tonos para los detalles. EN54-3 acreditado solamente tonos 1,2,3,6,7 & 13 & > 17V DC sólo

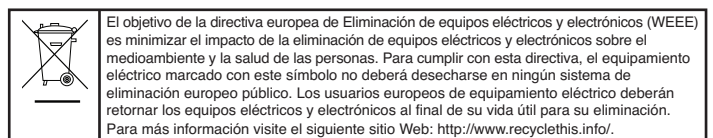

Free Manuals Download Website

<http://myh66.com>

<http://usermanuals.us>

<http://www.somanuals.com>

<http://www.4manuals.cc>

<http://www.manual-lib.com>

<http://www.404manual.com>

<http://www.luxmanual.com>

<http://aubethermostatmanual.com>

Golf course search by state

<http://golfingnear.com>

Email search by domain

<http://emailbydomain.com>

Auto manuals search

<http://auto.somanuals.com>

TV manuals search

<http://tv.somanuals.com>