



24 Fast Ethernet + 2 Gigabit L2 Managed Switch User's Manual

KS-2262



Release 2.28

Electronic Emission Notices

Federal Communications Commission (FCC) Statement

This equipment has been tested and found to comply with the limits for a class A computing device pursuant to Subpart J of part 15 of FCC Rules, which are designed to provide reasonable protection against such interference when operated in a commercial environment.

European Community (CE) Electromagnetic Compatibility Directive

This equipment has been tested and found to comply with the protection requirements of European Emission Standard EN55022/EN60555-2 and the Generic European Immunity Standard EN50082-1.

EMC:	EN55022(1988)/CISPR-22(1985)	class A
	EN60555-2(1995)	class A
	EN60555-3	
	IEC1000-4-2(1995)	4K V CD, 8KV, AD
	IEC1000-4-3(1995)	3V/m
	IEC1000-4-4(1995)	1KV – (power line), 0.5KV – (signal line)

Table of Contents

CAUTION	4
ELECTRIC EMISSION NOTICES	II
1. INTRODUCTION	6
1-1. OVERVIEW OF 24 FAST ETHERNET + 2 GIGABIT L2 MANAGED SWITCH	6
1-2. CHECKLIST	8
1-3. FEATURES	8
1-4. VIEW OF 24 FAST ETHERNET + 2 GIGABIT L2 MANAGED SWITCH	10
1-4-1. USER INTERFACES ON THE FRONT PANEL (BUTTON, LEDS AND PLUGS)	10
1-4-2. USER INTERFACES ON THE REAR PANEL	12
1-5. VIEW OF THE OPTIONAL MODULES	13
2. INSTALLATION	15
2-1. STARTING 24 FAST ETHERNET + 2 GIGABIT L2 MANAGED SWITCH UP	15
2-1-1. HARDWARE AND CABLE INSTALLATION	15
2-1-2. INSTALLING CHASSIS TO A 19-INCH WIRING CLOSET RAIL	17
2-1-3. CABLING REQUIREMENTS	17
2-1-3-1. CABLING REQUIREMENTS FOR TP PORTS	18
2-1-3-2. CABLING REQUIREMENTS FOR 1000SX/LX SFP MODULE	18
2-1-3-3. SWITCH CASCADING IN TOPOLOGY	19
2-1-4. CONFIGURING THE MANAGEMENT AGENT OF 24 FAST ETHERNET + 2 GIGABIT L2 MANAGED SWITCH	22
2-1-4-1. CONFIGURING THE MANAGEMENT AGENT THROUGH THE SERIAL RS-232 PORT	23
2-1-4-2. CONFIGURING THE MANAGEMENT AGENT THROUGH THE ETHERNET PORT	25
2-1-5. IP ADDRESS ASSIGNMENT	26
2-2. TYPICAL APPLICATIONS	31
3. OPERATION OF WEB-BASED MANAGEMENT	33
3-1. WEB MANAGEMENT HOME OVERVIEW	35
3-1-1. SYSTEM INFORMATION	38
3-1-2. IP CONFIGURATION	40
3-1-3. TIME CONFIGURATION	43
3-1-4. ACCOUNT CONFIGURATION	46
3-1-5. MANAGEMENT SECURITY	47
3-1-6. VIRTUAL STACK	50
3-2. PORT CONFIGURATION	52
3-2-1. PORT STATUS	52
3-2-2. PORT CONFIGURATION	57
3-2-3. PORT DESCRIPTION	59
3-2-5. SIMPLE COUNTER	60
3-2-4. DETAIL COUNTER	62
3-3. SNMP CONFIGURATION	65
3-4. LOOP DETECTION	67
3-5. DHCP BOOT	69
3-6. IGMP SNOOPING	70
3-7. VLAN	74
3-7-1. VLAN MODE	74
3-7-2. TAG-BASED GROUP	77
3-7-3. PVID	79
3-7-4. PORT-BASED GROUP	81
3-7-5. MANAGEMENT VLAN	83
3-8. MAC TABLE	84
3-9. GVRP CONFIGURATION	91
3-10. STP CONFIGURATION	97
3-10-1. STP STATUS	97
3-10-2. STP CONFIGURATION	99
3-10-3. STP PORT CONFIGURATION	101
3-11. TRUNKING CONFIGURATION	104
3-12. 802.1X CONFIGURATION	111
3-13. ALARM CONFIGURATION	122
3-14. CONFIGURATION	125
3-14-1. SAVE/RESTORE	126
3-14-2. CONFIG FILE	127

3-15. SECURITY-----	128
3-16. BANDWIDTH MANAGEMENT-----	131
3-17. QOS(QUALITY OF SERVICE) CONFIGURATION-----	135
3-18. DIAGNOSTICS-----	145
3-19. TFTP SERVER-----	148
3-20. LOG-----	149
3-21. FIRMWARE UPGRADE-----	151
3-22. REBOOT-----	152
3-23. LOGOUT-----	153
4. OPERATION OF CLI MANAGEMENT-----	154
4-1. CLI MANAGEMENT-----	154
4-1-1. LOGIN-----	154
4-2. COMMANDS OF CLI-----	156
4-2-1. GLOBAL COMMANDS OF CLI-----	157
4-2-2. LOCAL COMMANDS OF CLI-----	163
5. MAINTENANCE-----	249
5-1. RESOLVING NO LINK CONDITION-----	249
5-2. Q&A-----	249
APPENDIX A TECHNICAL SPECIFICATIONS-----	250
APPENDIX B NULL MODEM CABLE SPECIFICATIONS-----	254

Caution

Circuit devices are sensitive to static electricity, which can damage their delicate electronics. Dry weather conditions or walking across a carpeted floor may cause you to acquire a static electrical charge.

To protect your device, always:

- Touch the metal chassis of your computer to ground the static electrical charge before you pick up the circuit device.
- Pick up the device by holding it on the left and right edges only.

About this user's manual

In this user's manual, it will not only tell you how to install and connect your network system but configure and monitor the 24 FAST ETHERNET + 2 GIGABIT L2 MANAGED SWITCH through the built-in CLI and web by RS-232 serial interface and Ethernet ports step-by-step. Many explanations in detail of hardware and software functions are shown as well as the examples of the operation for web-based interface and command-line interface (CLI).

Overview of this user's manual

- Chapter 1 "Introduction" describes the features of 24 FAST ETHERNET + 2 GIGABIT L2 MANAGED SWITCH
- Chapter 2 "Installation"
- Chapter 3 "Operation of Web-based Management"
- Chapter 4 "Operation of CLI Management"
- Chapter 5 "Maintenance"

1. Introduction

1-1. Overview of 24 FAST ETHERNET + 2 GIGABIT L2 MANAGED SWITCH

24 FAST ETHERNET + 2 GIGABIT L2 MANAGED SWITCH, 24 Fast Ethernet + 2 Gigabit L2 Managed Switch, implemented 24 10/100Mbps TP + 2 Gigabit dual media ports with TP/SFP, is a standard switch that meets all IEEE 802.3/u/x/z Gigabit, Fast Ethernet and Ethernet specifications. The switch can be managed through RS-232 serial port via directly connection, or through Ethernet port using Telnet or Web-based management unit, associated with SNMP agent. With the SNMP agent, the network administrator can logon the switch to monitor, configure and control each port's activity in a friendly way. The overall network management is enhanced and the network efficiency is also improved to accommodate high bandwidth applications. In addition, the switch features comprehensive and useful function such as QoS (Quality of Service), Spanning Tree, VLAN, Port Trunking, Bandwidth Control, Port Security, SNMP/RMON and IGMP Snooping capability via the intelligent software. It is suitable for both metro-LAN and office application.

10/100/1000Mbps TP is a standard Ethernet port that meets all IEEE 802.3/u/x/z Gigabit, Fast Ethernet specifications. 1000Mbps SFP Fiber transceiver is a Gigabit Ethernet port that fully complies with all IEEE 802.3z and 1000Base-SX/LX standards.

For upgrading firmware, please refer to the Section 3-20 or Section 4-2-2 for more details. The switch will not stop operating while upgrading firmware and after that, the configuration keeps unchanged.

• Key Features in the Device

QoS:

Support Quality of Service by the IEEE 802.1P standard. There are two priority queue and packet transmission schedule using Weighted Round Robin (WRR). User-defined weight classification of packet priority can be based on either VLAN tag on packets or user-defined port priority.

Spanning Tree:

Support IEEE 802.1D, IEEE 802.1w (RSTP: Rapid Spanning Tree Protocol) standards.

VLAN:

Support Port-based VLAN and IEEE802.1Q Tag VLAN. Support 256 active VLANs and VLAN ID 1~4094.

Port Trunking:

Support static port trunking and port trunking with IEEE 802.3ad LACP.

Bandwidth Control:

Support ingress and egress per port bandwidth control.

Port Security:

Support allowed, denied forwarding and port security with MAC address.

SNMP/RMON:

SNMP agent and RMON MIB. In the device, SNMP agent is a client software which is operating over SNMP protocol used to receive the command from SNMP manager (server site) and echo the corresponded data, i.e. MIB object. Besides, SNMP agent will actively issue TRAP information when happened.

RMON is the abbreviation of Remote Network Monitoring and is a branch of the SNMP MIB.

The device supports MIB-2 (RFC 1213), Bridge MIB (RFC 1493), RMON MIB (RFC 1757)-statistics Group 1,2,3,9, Ethernet-like MIB (RFC 1643) and so on.

IGMP Snooping:

Support IGMP version 2 (RFC 2236): The function IGMP snooping is used to establish the multicast groups to forward the multicast packet to the member ports, and, in nature, avoid wasting the bandwidth while IP multicast packets are running over the network.

1-2. Checklist

Before you start installing the switch, verify that the package contains the following:

- 24 FAST ETHERNET + 2 GIGABIT L2 MANAGED SWITCH 24 Fast Ethernet + 2 Gigabit L2 Managed Switch
- Fiber Modules (optional)
- Mounting Accessory (for 19" Rack Shelf)
- This User's Manual in CD-ROM
- AC Power Cord
- RS-232 Cable

Please notify your sales representative immediately if any of the aforementioned items is missing or damaged.

1-3. Features

The 24 FAST ETHERNET + 2 GIGABIT L2 MANAGED SWITCH, a standalone off-the-shelf switch, provides the comprehensive features listed below for users to perform system network administration and efficiently and securely serve your network.

• Hardware

- Supports 24-port 10/100M TP ports with Nway and auto MDIX function
- Supports 2 Gigabit dual media ports(TP/SFP) and 2 slots for removable SFP module supporting 1000M SFP fiber module
- Supports hot-plug fiber transceiver modules
- Supports 256KB packet buffer and 128KB control memory
- Maximal packet length can be up to 1536 bytes
- Full-duplex flow control (IEEE802.3x) and half-duplex backpressure
- Extensive front-panel diagnostic LEDs; System: Power, CPURUN, ACT / FDX / SPD(LEDSET), 10/100Mbps TP Port1-24:LINK/ACT, FDX, SPD, 10/100/1000Mbps/Fiber port 25, 26: LINK/ACT, FDX, SPD

• Management

- Supports concisely the status of port and easily port configuration
- Supports per port traffic monitoring counters
- Supports a snapshot of the system Information when you login
- Supports port mirror function
- Supports the static trunk function

- Supports 802.1Q VLAN with 256 entries.
- Supports user management and limits three users to login
- Supports DHCP Broadcasting Suppression to avoid network suspended or crashed
- Supports to send the trap event while monitored events happened
- Supports default configuration which can be restored to overwrite the current configuration which is working on via web browser and CLI
- Supports on-line plug/unplug SFP modules
- Supports 5 kinds of QoS, are as follows, MAC Priority, 802.1p Priority, IP TOS Priority, and DiffServ DSCP Priority.
- Built-in web-based management and CLI management, providing a more convenient UI for the user
- Supports port mirror function with ingress/egress traffic
- Supports rapid spanning tree (802.1w RSTP)
- Supports 802.1x port security on a VLAN
- Supports user management and only first login administrator can configure the device. The rest of users can only view the switch
- SNMP access can be disabled and prevent from illegal SNMP access
- Supports Ingress, Non-unicast and Egress Bandwidth rating management
- The trap event and alarm message can be transferred via e-mail and mobile phone short message
- Supports diagnostics to let administrator knowing the hardware status
- Supports external loopback test to check if the link is ok
- TFTP for firmware upgrade, system log upload and config file import/export
- Supports remote boot the device through user interface and SNMP
- Supports network time synchronization and daylight saving
- Supports 120 event log records in the main memory and display on the local console

1-4. View of 24 FAST ETHERNET + 2 GIGABIT L2 MANAGED SWITCH

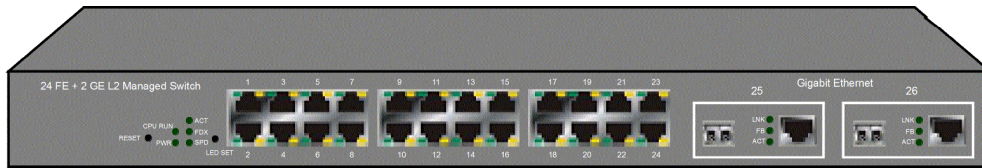

Fig. 1-1 Full View of 24 FAST ETHERNET + 2 GIGABIT L2 MANAGED SWITCH with SFP Module

1-4-1. User Interfaces on the Front Panel (Button, LEDs and Plugs)

There are 24 TP Fast Ethernet ports and 2 slots for optional removable modules on the front panel of the switch. LED display area, locating on the front panel, contains a CPURUN, Power LED and 26 ports working status of the switch.

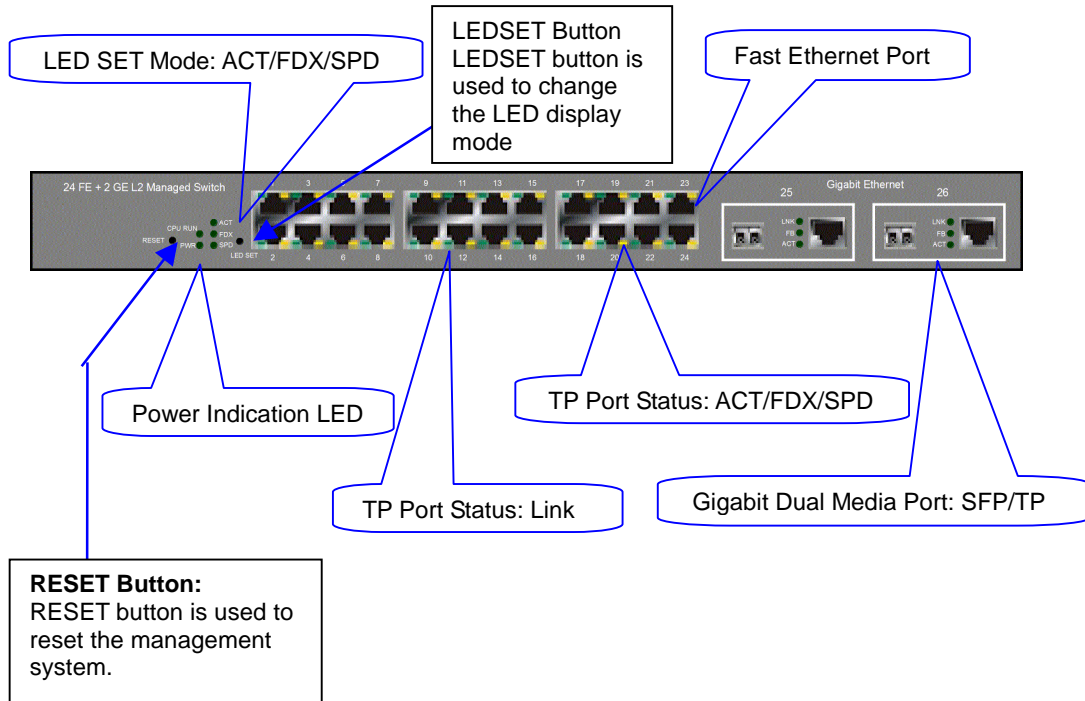

Fig. 1-2 Front View of the Unit with SFP Module

• LED Indicators

LED	Color	Function
System LED		
CPURUN	Green	Lit when CPU is on and good
POWER	Green	Lit when AC power is on and good
ACT	Green	Lit when LEDSET set on active mode
FDX	Green	Lit when LEDSET set on full-duplex mode
SPD	Green	Lit when LEDSET set on speed mode
10/100Mbps Ethernet TP Port 1 to 24 LED		
LNK	Green	Lit when connection with remote device is good Off when cable connection is not good
ACT/FDX/ SPD	Amber (TP Port 1 to 24 LED)	a. LEDSET set on ACT (active) mode: Blinks when any traffic is present b. LEDSET set on FDX (full-duplex) mode: Lit when full-duplex mode is active Blinks when any collision is present c. LEDSET set on SPD (speed) mode: Lit when 100Mbps speed is active Off when 10Mbps speed is active
10/100/1000Mbps Gigabit TP/Fiber Port 25, 26 LED		
LNK	Green	Lit when connection with remote device is good Off when cable connection is not good
FB	Green	Lit when Fiber port is active Off when TP port is active
ACT/FDX/ SPD	Green (Port 25, 26 LED)	a. LEDSET set on ACT (active) mode: Blinks when any traffic is present b. LEDSET set on FDX (full-duplex) mode: Lit when full-duplex mode is active Blinks when any collision is present c. LEDSET set on SPD (speed) mode: Lit when 1000Mbps speed is active Off when 10/100Mbps speed is active

Table1-1

1-4-2. User Interfaces on the Rear Panel

One RS-232 DB-9 interface is offered for configuration or management. And there is one AC power input socket for having the switch powered on or off.

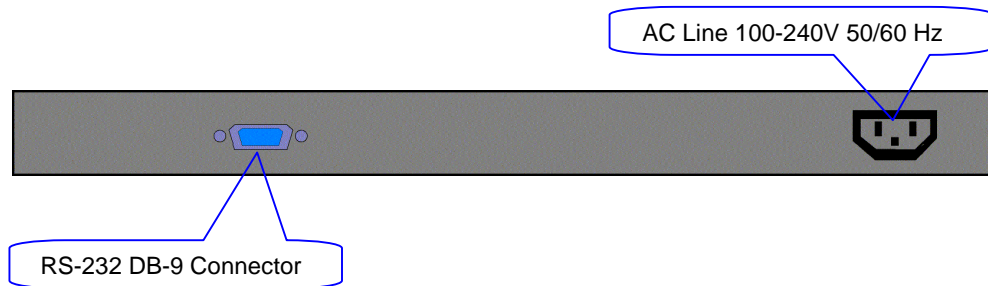

Fig. 1-3 Rear View of 24 FAST ETHERNET + 2 GIGABIT L2 MANAGED SWITCH

1-5. View of the Optional Modules

In the switch, Port 25, 26 includes two types of media --- TP and SFP Fiber (LC, BiDi LC...); this port supports 10/100/1000Mbps TP or 1000Mbps SFP Fiber with auto-detected function. 1000Mbps SFP Fiber transceiver is used for high-speed connection expansion. Refer to "KS-2601 Model List" file for detailed specification. In the list, the SFP fiber transceivers include 1000BASE-SX standard LC for MMF, 1000BASE-LX LC for different SMF, and Bi-Di LC for single SMF.

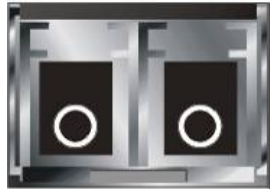

Fig. 1-4 Front View of 1000Base-SX/LX LC, SFP Fiber Transceiver



Fig. 1-5 Front View of 1000Base-LX BiDi LC, SFP Fiber Transceiver

2. Installation

2-1. Starting 24 FAST ETHERNET + 2 GIGABIT L2 MANAGED SWITCH Up

This section will give users a quick start for:

- Hardware and Cable Installation
- Management Station Installation
- Software booting and configuration

2-1-1. Hardware and Cable Installation

At the beginning, please do first:

⇒ Wear a grounding device to avoid the damage from electrostatic discharge

- **Installing Optional SFP Fiber Transceivers to the L2 Managed Switch**

Note: If you have no modules, please skip this section.

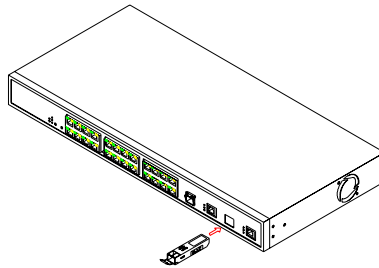

Fig. 2-1 Installation of Optional SFP Fiber Transceiver

- **Connecting the SFP Module to the Chassis:**

The optional SFP modules are hot swappable, so you can plug or unplug it before or after powering on.

1. Verify that the SFP module is the right model and conforms to the chassis
2. Slide the module along the slot. Also be sure that the module is properly seated against the slot socket/connector
3. Install the media cable for network connection
4. Repeat the above steps, as needed, for each module to be installed into slot(s)
5. Have the power ON after the above procedures are done

- **TP Port and Cable Installation**

- ⇒ In the switch, TP port supports MDI/MDI-X auto-crossover, so both types of cable, straight-through (Cable pin-outs for RJ-45 jack 1, 2, 3, 6 to 1, 2, 3, 6 in 10/100M TP; 1, 2, 3, 4, 5, 6, 7, 8 to 1, 2, 3, 4, 5, 6, 7, 8 in Gigabit TP) and crossed-over (Cable pin-outs for RJ-45 jack 1, 2, 3, 6 to 3, 6, 1, 2) can be used. It means you do not have to tell from them, just plug it.
- ⇒ Use Cat. 5 grade RJ-45 TP cable to connect to a TP port of the switch and the other end is connected to a network-aware device such as a workstation or a server.
- ⇒ Repeat the above steps, as needed, for each RJ-45 port to be connected to a Gigabit 10/100/1000 TP device.

Now, you can start having the switch in operation.

- **Power On**

The switch supports 100-240 VAC, 50-60 Hz power supply. The power supply will automatically convert the local AC power source to DC power. It does not matter whether any connection plugged into the switch or not when power on, even modules as well. After the power is on, all LED indicators will light up immediately and then all off except the power LED still keeps on. This represents a reset of the system.

- **Firmware Loading**

After resetting, the bootstrap loader will load the firmware into the memory. It will take about 30 seconds, after that, the switch will flash all the LED once and automatically performs self-test and is in ready state.

2-1-2. Installing Chassis to a 19-Inch Wiring Closet Rail

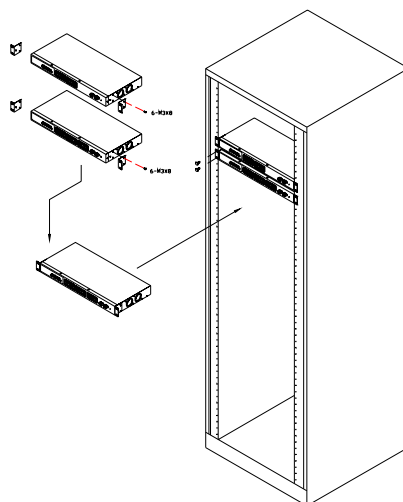

Fig. 2-2

Caution: Allow a proper spacing and proper air ventilation for the cooling fan at both sides of the chassis.

- ⇒ Wear a grounding device for electrostatic discharge.
- ⇒ Screw the mounting accessory to the front side of the switch (See Fig. 2-2).
- ⇒ Place the Chassis into the 19-inch wiring closet rail and locate it at the proper position. Then, fix the Chassis by screwing it.

2-1-3. Cabling Requirements

To help ensure a successful installation and keep the network performance good, please take a care on the cabling requirement. Cables with worse specification will render the LAN to work poorly.

2-1-3-1. Cabling Requirements for TP Ports

- ⇒ For Fast Ethernet TP network connection
 - The grade of the cable must be Cat. 5 or Cat. 5e with a maximum length of 100 meters.
- ⇒ Gigabit Ethernet TP network connection
 - The grade of the cable must be Cat. 5 or Cat. 5e with a maximum length of 100 meters. Cat. 5e is recommended.

2-1-3-2. Cabling Requirements for 1000SX/LX SFP Module

It is more complex and comprehensive contrast to TP cabling in the fiber media. Basically, there are two categories of fiber, multi mode (MM) and single mode (SM). The later is categorized into several classes by the distance it supports. They are SX, LX, LHX, XD, and ZX. From the viewpoint of connector type, there mainly are LC and BiDi LC.

- Gigabit Fiber with multi-mode LC SFP module
- Gigabit Fiber with single-mode LC SFP module
- Gigabit Fiber with BiDi LC 1310nm SFP module
- Gigabit Fiber with BiDi LC 1550nm SFP module

The following table lists the types of fiber that we support and those else not listed here are available upon request.

		Multi-mode Fiber Cable and Modal Bandwidth			
		Multi-mode 62.5/125μm		Multi-mode 50/125μm	
IEEE 802.3z Gigabit Ethernet 1000SX 850nm		Modal Bandwidth	Distance	Modal Bandwidth	Distance
		160MHz-Km	220m	400MHz-Km	500m
		200MHz-Km	275m	500MHz-Km	550m
1000Base- LX/LHX/XD/ZX		Single-mode Fiber 9/125μm			
		Single-mode transceiver 1310nm 10Km			
		Single-mode transceiver 1550nm 30, 50, 70, 110Km			
1000Base-LX Single Fiber WDM Module		Single-Mode *20Km	TX(Transmit)	1310nm	
			RX(Receive)	1550nm	
		Single-Mode *20Km	TX(Transmit)	1550nm	
			RX(Receive)	1310nm	

Table2-1

2-1-3-3. Switch Cascading in Topology

- **Takes the Delay Time into Account**

Theoretically, the switch partitions the collision domain for each port in switch cascading that you may up-link the switches unlimitedly. In practice, the network extension (cascading levels & overall diameter) must follow the constraint of the IEEE 802.3/802.3u/802.3z and other 802.1 series protocol specifications, in which the limitations are the timing requirement from physical signals defined by 802.3 series specification of Media Access Control (MAC) and PHY, and timer from some OSI layer 2 protocols such as 802.1d, 802.1q, LACP and so on.

The fiber, TP cables and devices' bit-time delay (round trip) are as follows:

1000Base-X TP, Fiber		100Base-T (TP		100Base-F (Fiber	
Round trip Delay: 4096		Round trip Delay: 512			
Cat. 5 TP Wire:	11.12/m	Cat. 5 TP Wire:	1.12/m	Fiber Cable:	1.0/m
Fiber Cable :	10.10/m	TP to fiber Converter: 56			
Bit Time unit : 1ns (1sec./1000 Mega bit)		Bit Time unit: 0.01μs (1sec./100 Mega bit)			

Table 2-2

Sum up all elements' bit-time delay and the overall bit-time delay of wires/devices must be within Round Trip Delay (bit times) in a half-duplex network segment (collision domain). For full-duplex operation, this will not be applied. You may use the TP-Fiber module to extend the TP node distance over fiber optic and provide the long haul connection.

- **Typical Network Topology in Deployment**

A hierarchical network with minimum levels of switch may reduce the timing delay between server and client station. Basically, with this approach, it will minimize the number of switches in any one path; will lower the possibility of network loop and will improve network efficiency. If more than two switches are connected in the same network, select one switch as Level 1 switch and connect all other switches to it at Level 2. Server/Host is recommended to connect to the Level 1 switch. This is general if no VLAN or other special requirements are applied.

Case1: All switch ports are in the same local area network. Every port can access each other (See Fig. 2-3).

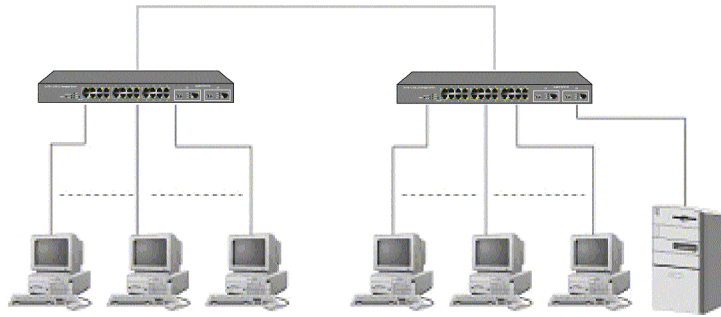

Fig. 2-3 No VLAN Configuration Diagram

If VLAN is enabled and configured, each node in the network that can communicate each other directly is bounded in the same VLAN area.

Here VLAN area is defined by what VLAN you are using. The switch supports both port-based VLAN and tag-based VLAN. They are different in practical deployment, especially in physical location. The following diagram shows how it works and what the difference they are.

Case2a: Port-based VLAN (See Fig.2-4).

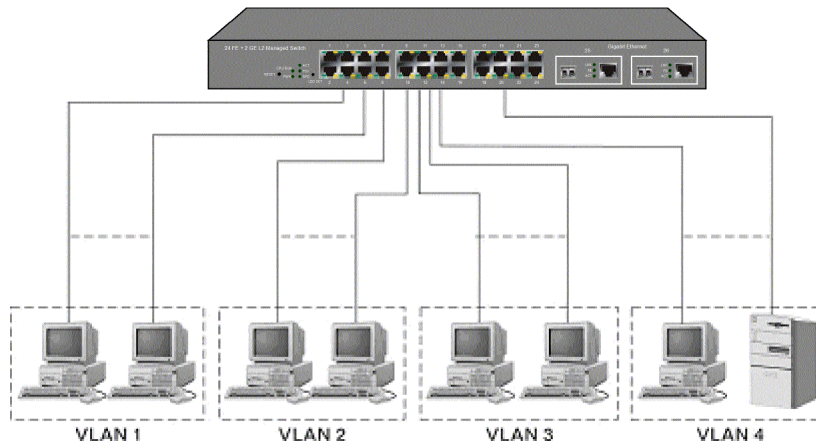

Fig. 2-4 Port-based VLAN Diagram

1. The same VLAN members could not be in different switches.
2. Every VLAN members could not access VLAN members each other.
3. The switch manager has to assign different names for each VLAN groups at one switch.

Case 2b: Port-based VLAN (See Fig.2-5).

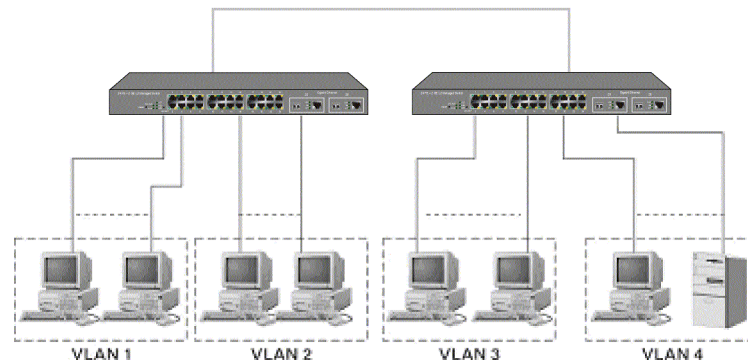

Fig. 2-5 Port-based VLAN Diagram

1. VLAN1 members could not access VLAN2, VLAN3 and VLAN4 members.
2. VLAN2 members could not access VLAN1 and VLAN3 members, but they could access VLAN4 members.
3. VLAN3 members could not access VLAN1, VLAN2 and VLAN4.
4. VLAN4 members could not access VLAN1 and VLAN3 members, but they could access VLAN2 members.

Case3a: The same VLAN members can be at different switches with the same VID (See Fig. 2-6).

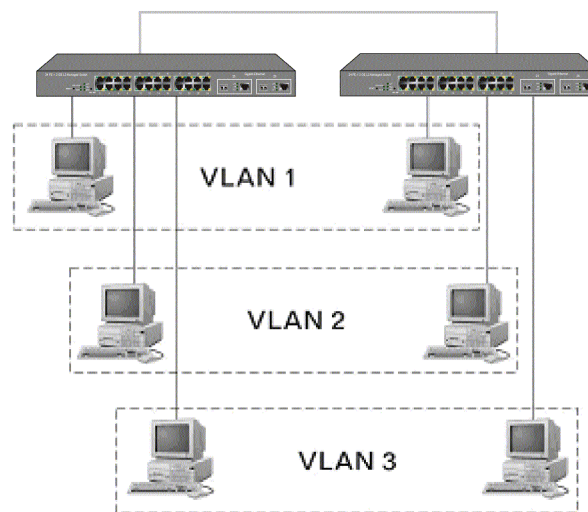

Fig. 2-6 Attribute-based VLAN Diagram

2-1-4. Configuring the Management Agent of 24 FAST ETHERNET + 2 GIGABIT L2 MANAGED SWITCH

We offer you three ways to startup the switch management function. They are RS-232 console, CLI, and Web. Users can use any one of them to monitor and configure the switch. You can touch them through the following procedures.

Section 2-1-4-1: Configuring the Management Agent of 24 FAST ETHERNET + 2 GIGABIT L2 MANAGED SWITCH through the Serial RS-232 Port

Section 2-1-4-2: Configuring the Management Agent of 24 FAST ETHERNET + 2 GIGABIT L2 MANAGED SWITCH through the Ethernet Port

Note: Please first modify the IP address, Subnet mask, Default gateway and DNS through RS-232 console, and then do the next.

2-1-4-1. Configuring the Management Agent through the Serial RS-232 Port

To perform the configuration through RS-232 console port, the switch's serial port must be directly connected to a DCE device, for example, a PC, through RS-232 cable with DB-9 connector. Next, run a terminal emulator with the default setting of the switch's serial port. With this, you can communicate with the switch.

In the switch, RS-232 interface only supports baud rate 57.6k bps with 8 data bits, 1 stop bit, no parity check and no flow control.

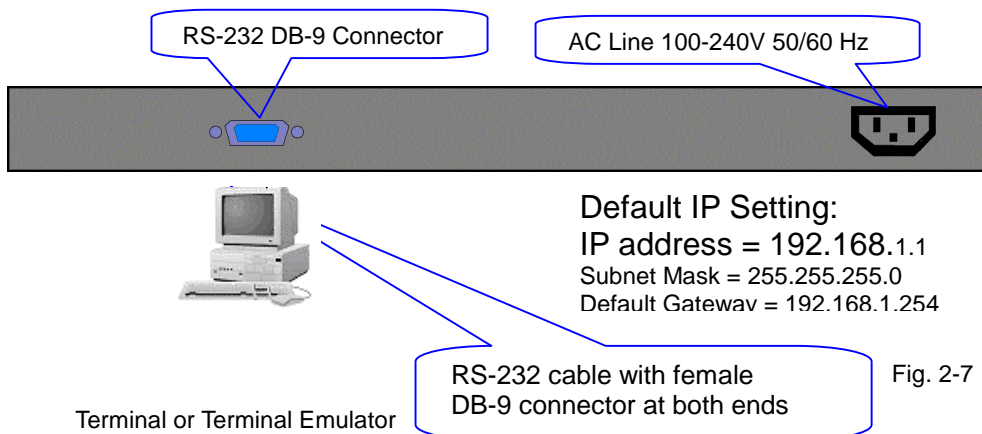

To configure the switch, please follow the procedures below:

1. Find the RS-232 DB-9 cable with female DB-9 connector bundled. Normally, it just uses pins 2, 3 and 7. See also Appendix B for more details on Null Modem Cable Specifications.
2. Attaches the DB-9 female cable connector to the male serial RS-232 DB-9 connector on the switch.
3. Attaches the other end of the serial RS-232 DB-9 cable to PC's serial port, running a terminal emulator supporting VT100/ANSI terminal with The switch's serial port default settings. For example, Windows98/2000/XP HyperTerminal utility.

Note: The switch's serial port default settings are listed as follows:

Baud rate	57600
Stop bits	1
Data bits	8
Parity	N
Flow control	none

4. When you complete the connection, then press **<Enter>** key. The login prompt will be shown on the screen. The default username and password are shown as below:

Username = admin

Password = admin

- **Set IP Address, Subnet Mask and Default Gateway IP Address**

Please refer to Fig. 2-7 CLI Management for details about factory setting. They are default setting of IP address. You can first either configure your PC IP address or change IP address of the switch, next to change the IP address of default gateway and subnet mask.

For example, your network address is 10.1.1.0, and subnet mask is 255.255.255.0. You can change the switch's default IP address 192.168.1.1 to 10.1.1.1 and set the subnet mask to be 255.255.255.0. Then, choose your default gateway, may be it is 10.1.1.254.

Default Value	24 F. ST	Your Network Setting
IP Address	192.168.1.1	10.1.1.1
Subnet	255.255.255.0	255.255.255.0
Default Gateway	192.168.1.254	10.1.1.254

Table 2-3

After completing these settings in the switch, it will reboot to have the configuration taken effect. After this step, you can operate the management through the network, no matter it is from a web browser or Network Management System (NMS).

Managed Switch - 2262 FE Switch

Login: admin

Password:

2262 FE Switch

Fig. 2-8 the Login Screen for CLI

2-1-4-2. Configuring the Management Agent through the Ethernet Port

There are three ways to configure and monitor the switch through the switch's Ethernet port. They are CLI, Web browser and SNMP manager. The user interface for the last one is NMS dependent and does not cover here. We just introduce the first two types of management interface.

Default IP Setting:
IP = 192.168.1.1
Subnet Mask = 255.255.255.0
Default Gateway = 192.168.1.254

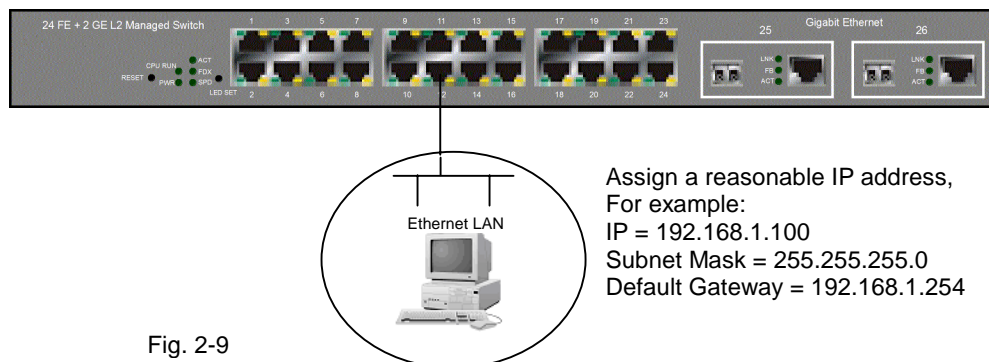

Fig. 2-9

• Managing L2 MANAGED SWITCH through Ethernet Port

Before you communicate with the switch, you have to finish first the configuration of the IP address or to know the IP address of the switch. Then, follow the procedures listed below.

1. Set up a physical path between the configured the switch and a PC by a qualified UTP Cat. 5 cable with RJ-45 connector.

Note: If PC directly connects to the switch, you have to setup the same subnet mask between them. But, subnet mask may be different for the PC in the remote site. Please refer to Fig. 2-9 about the switch's default IP address information.

2. Run CLI or web browser and follow the menu. Please refer to Chapter 3 and Chapter 4.

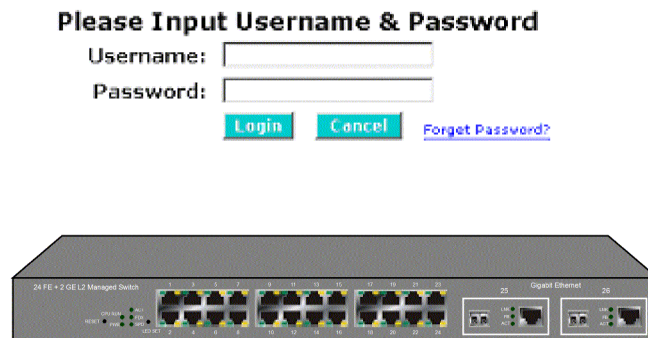

Fig. 2-10 the Login Screen for Web

2-1-5. IP Address Assignment

For IP address configuration, there are three parameters needed to be filled in. They are IP address, Subnet Mask, Default Gateway and DNS.

IP address:

The address of the network device in the network is used for internetworking communication. Its address structure looks is shown in the Fig. 2-11. It is “classful” because it is split into predefined address classes or categories.

Each class has its own network range between the network identifier and host identifier in the 32 bits address. Each IP address comprises two parts: network identifier (address) and host identifier (address). The former indicates the network where the addressed host resides, and the latter indicates the individual host in the network which the address of host refers to. And the host identifier must be unique in the same LAN. Here the term of IP address we used is version 4, known as IPv4.

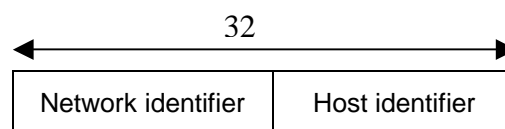
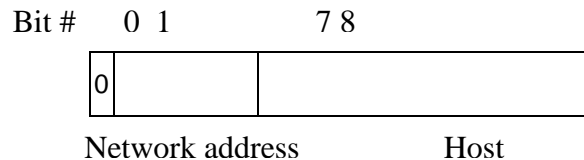

Fig. 2-11 IP address structure

With the class addressing, it divides IP address into three classes, class A, class B and class C. The rest of IP addresses are for multicast and broadcast. The bit length of the network prefix is the same as that of the subnet mask and is denoted as IP address/X, for example, 192.168.1.0/24. Each class has its address range described below.

Class A:

Address is less than 126.255.255.255. There are a total of 126 networks can be defined because the address 0.0.0.0 is reserved for default route and 127.0.0.0/8 is reserved for loopback function.



Class B:

IP address range between 128.0.0.0 and 191.255.255.255. Each class B network has a 16-bit network prefix followed 16-bit host address. There are 16,384 (2^{14})/16 networks able to be defined with a maximum of 65534 ($2^{16} - 2$) hosts per network.

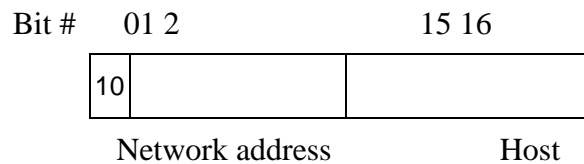

Class C:

IP address range between 192.0.0.0 and 223.255.255.255. Each class C network has a 24-bit network prefix followed 8-bit host address. There are 2,097,152 (2^{21})/24 networks able to be defined with a maximum of 254 ($2^8 - 2$) hosts per network.

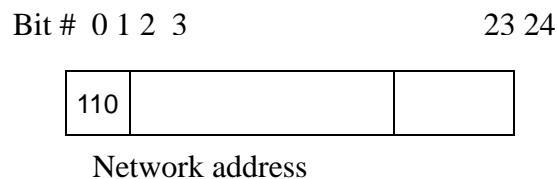

Class D and E:

Class D is a class with first 4 MSB (Most significance bit) set to 1-1-1-0 and is used for IP Multicast. See also RFC 1112. Class E is a class with first 4 MSB set to 1-1-1-1 and is used for IP broadcast.

According to IANA (Internet Assigned Numbers Authority), there are three specific IP address blocks reserved and able to be used for extending internal network. We call it Private IP address and list below:

Class A	10.0.0.0 --- 10.255.255.255
Class B	172.16.0.0 --- 172.31.255.255
Class C	192.168.0.0 --- 192.168.255.255

Please refer to RFC 1597 and RFC 1466 for more information.

Subnet mask:

It means the sub-division of a class-based network or a CIDR block. The subnet is used to determine how to split an IP address to the network prefix and the host address in bitwise basis. It is designed to utilize IP address more efficiently and ease to manage IP network.

For a class B network, 128.1.2.3, it may have a subnet mask 255.255.0.0 in default, in which the first two bytes is with all 1s. This means more than 60 thousands of nodes in flat IP address will be at the same network. It's too large to manage practically. Now if we divide it into smaller network by extending network prefix from 16 bits to, say 24 bits, that's using its third byte to subnet this class B network. Now it has a subnet mask 255.255.255.0, in which each bit of the first three bytes is 1. It's now clear that the first two bytes is used to identify the class B network, the third byte is used to identify the subnet within this class B network and, of course, the last byte is the host number.

Not all IP address is available in the sub-netted network. Two special addresses are reserved. They are the addresses with all zero's and all one's host number. For example, an IP address 128.1.2.128, what IP address reserved will be looked like? All 0s mean the network itself, and all 1s mean IP broadcast.

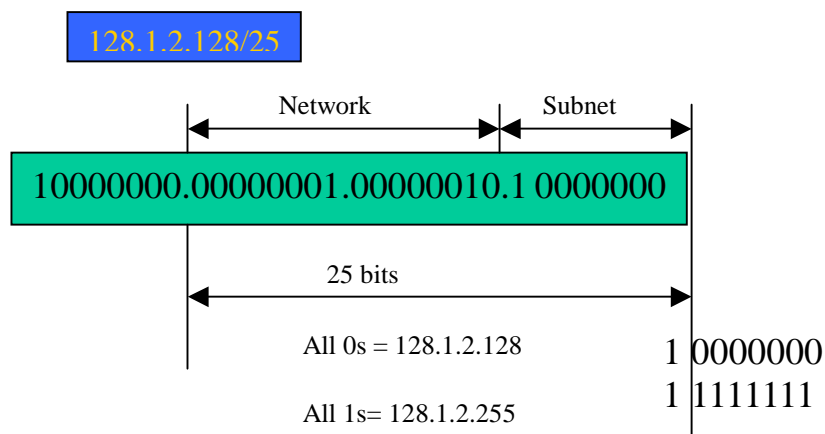

In this diagram, you can see the subnet mask with 25-bit long, 255.255.255.128, contains 126 members in the sub-netted network. Another is that the length of network prefix equals the number of the bit with 1s in that subnet mask. With this, you can easily count the number of IP addresses matched. The following table shows the result.

Prefix Length	No. of IP matched	No. of Addressable IP
/32	1	-
/31	2	-
/30	4	2
/29	8	6
/28	16	14
/27	32	30
/26	64	62
/25	128	126
/24	256	254
/23	512	510
/22	1024	1022
/21	2048	2046
/20	4096	4094
/19	8192	8190
/18	16384	16382
/17	32768	32766
/16	65536	65534

Table 2-4

According to the scheme above, a subnet mask 255.255.255.0 will partition a network with the class C. It means there will have a maximum of 254 effective nodes existed in this sub-netted network and is considered a physical network in an autonomous network. So it owns a network IP address which may looks like 168.1.2.0.

With the subnet mask, a bigger network can be cut into small pieces of network. If we want to have more than two independent networks in a network, a partition to the network must be performed. In this case, subnet mask must be applied.

For different network applications, the subnet mask may look like 255.255.255.240. This means it is a small network accommodating a maximum of 15 nodes in the network.

Default gateway:

For the routed packet, if the destination is not in the routing table, all the traffic is put into the device with the designated IP address, known as default router. Basically, it is a routing policy. The gateway setting is used for Trap Events Host only in the switch.

For assigning an IP address to the switch, you just have to check what the IP address of the network will be connected with the switch. Use the same network address and append your host address to it.

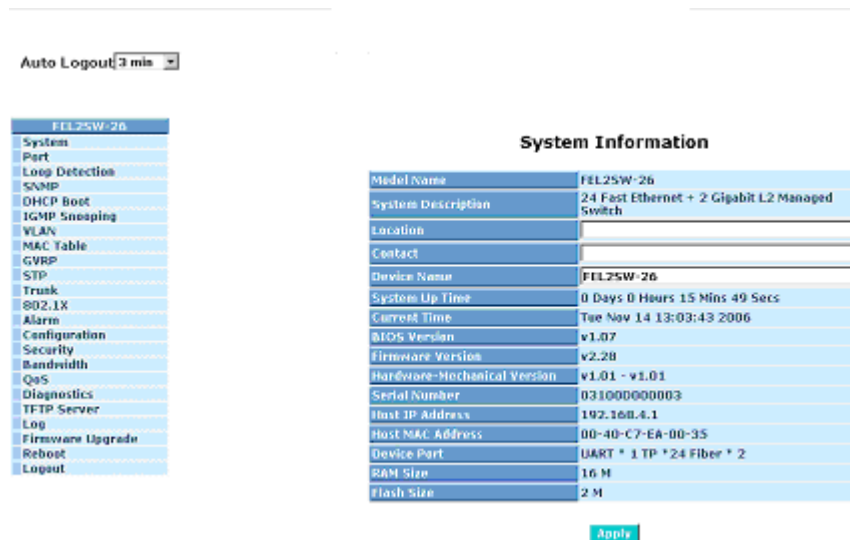

Fig. 2-12

First, IP Address: as shown in the Fig. 2-12, enter "192.168.1.1", for instance. For sure, an IP address such as 192.168.1.x must be set on your PC.

Second, Subnet Mask: as shown in the Fig. 2-12, enter "255.255.255.0". Any subnet mask such as 255.255.255.x is allowable in this case.

DNS:

The Domain Name Server translates human readable machine name to IP address. Every machine on the Internet has a unique IP address. A server generally has a static IP address. To connect to a server, the client needs to know the IP of the server. However, user generally uses the name to connect to the server. Thus, the switch DNS client program (such as a browser) will ask the DNS to resolve the IP address of the named server.

2-2. Typical Applications

The 24 FAST ETHERNET + 2 GIGABIT L2 MANAGED SWITCH implements 24 Fast Ethernet TP ports with auto MDIX and 2 Gigabit dual media ports with SFP for removable module supported comprehensive fiber types of connection, including LC, BiDi LC for SFP. For more details on the specification of the switch, please refer to Appendix A.

The switch is suitable for the following applications.

- Central Site/Remote site application is used in carrier or ISP (See Fig. 2-13)
- Peer-to-peer application is used in two remote offices (See Fig. 2-14)
- Office network(See Fig. 2-15)

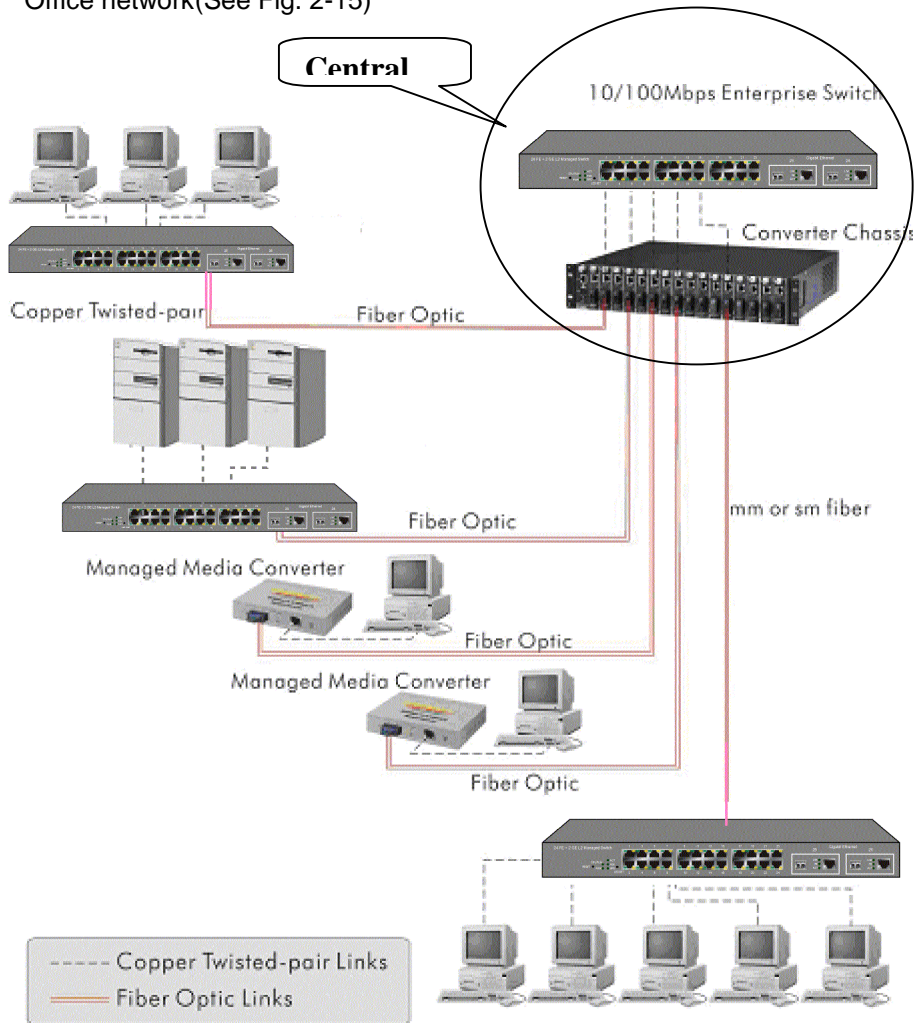

Fig. 2-13 Network Connection between Remote Site and Central Site

Fig. 2-13 is a system wide basic reference connection diagram. This diagram demonstrates how the switch connects with other network devices and hosts.

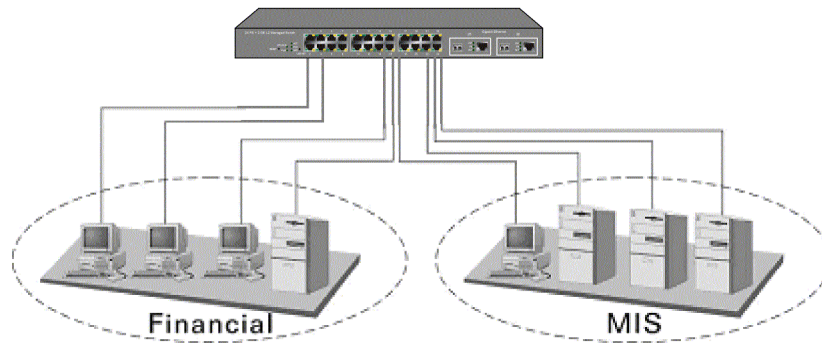

Fig. 2-14 Peer-to-peer Network Connection

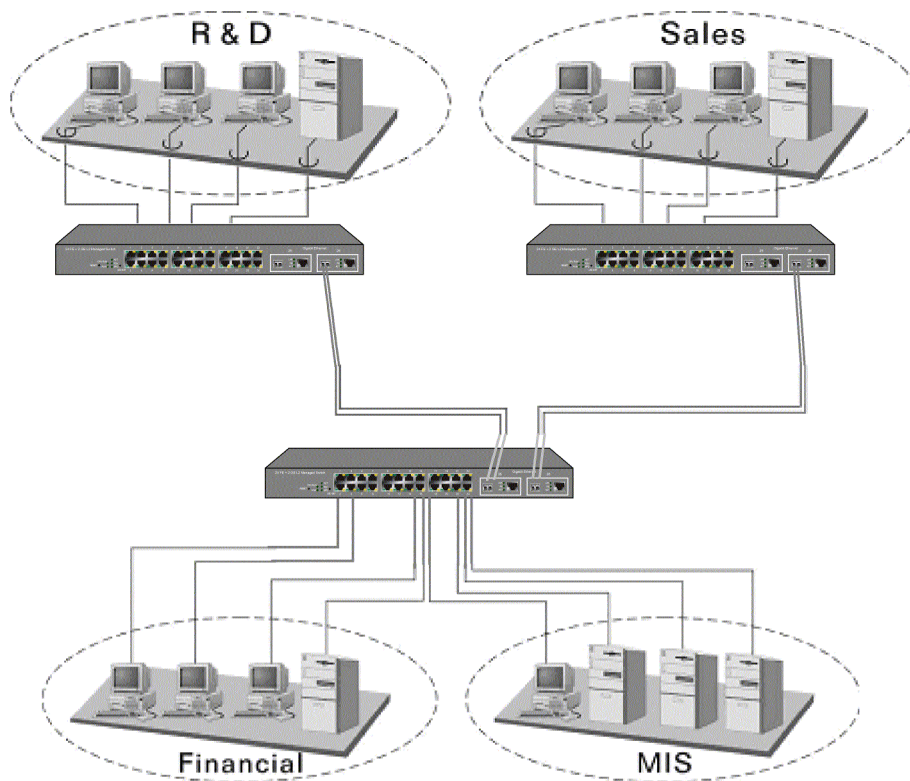

Fig. 2-15 Office Network Connection

3. Operation of Web-based Management

This chapter instructs you how to configure and manage the 24 FAST ETHERNET + 2 GIGABIT L2 MANAGED SWITCH through the web user interface it supports, to access and manage the 24 10/100Mbps TP + 2 Gigabit dual media ports with TP/SFP Fiber management Ethernet switch. With this facility, you can easily access and monitor through any one port of the switch all the status of the switch, including MIBs status, each port activity, Spanning tree status, port aggregation status, multicast traffic, VLAN and priority status, even illegal access record and so on.

The default values of the managed switch are listed in the table below:

IP Address	192.168.1.1
Subnet Mask	255.255.255.0
Default Gateway	192.168.1.254
Username	admin
Password	admin

Table 3-1

After the managed switch has been finished configuration in the CLI via the switch's serial interface, you can browse it. For instance, type <http://192.168.1.1> in the address row in a browser, it will show the following screen (see Fig.3-1) and ask you inputting username and password in order to login and access authentication. The default username and password are both "admin". For the first time to use, please enter the default username and password, and then click the **<Login>** button. The login process now is completed.

Just click the link of "Forget Password" in WebUI (See Fig. 3-1) or input "Ctrl+Z" in CLI's login screen (See Fig. 4-1~4-2) in case the user forgets the manager's password. Then, the system will display a serial No. for the user. Write down this serial No. and contact your vendor, the vendor will give you a temporary password. Use this new password as ID and Password, and it will allow the user to login the system with manager authority temporarily. Due to the limit of this new password, the user only can login the system one time, therefore, please modify your password immediately after you login in the system successfully.

In this login menu, you have to input the complete username and password respectively, the switch will not give you a shortcut to username automatically. This looks inconvenient, but safer.

In the switch, it supports a simple user management function allowing only one administrator to configure the system at the same time. If there are two or more users using administrator's identity, the switch will allow the only one who logs in first to configure the system. The rest of users, even with administrator's identity, can only monitor the system. For those who have no administrator's identity, can only monitor the system. There are only a maximum of three users able to login simultaneously in the switch.

To optimize the display effect, we recommend you use Microsoft IE 6.0 above, Netscape V7.1 above or FireFox V1.0.0 above and have the resolution 1024x768. The switch supported neutral web browser interface.

In Fig. 3-2, for example, left section is the whole function tree with web user interface and we will travel it through this chapter.

Please Input Username & Password

Username:

Password:

[Forget Password?](#)

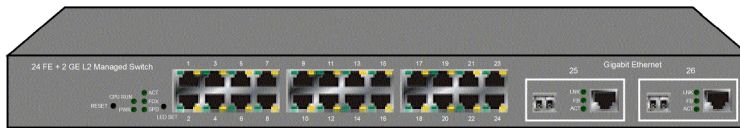

Fig. 3-1

3-1. Web Management Home Overview

After you login, the switch shows you the system information as Fig. 3-2. This page is default and tells you the basic information of the system, including “Model Name”, “System Description”, “Location”, “Contact”, “Device Name”, “System Up Time”, “Current Time”, “BIOS Version”, “Firmware Version”, “Hardware-Mechanical Version”, “Serial Number”, “Host IP Address”, “Host MAC Address”, “Device Port”, “RAM Size” and “Flash Size”. With this information, you will know the software version used, MAC address, serial number, how many ports good and so on. This is helpful while malfunctioning.

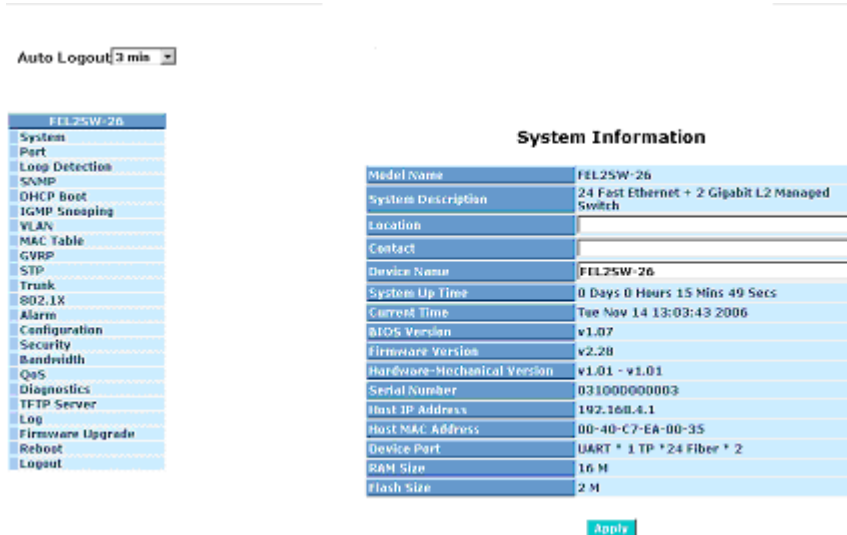

Fig. 3-2

- **The Information of Page Layout**

- On the top side, it shows the front panel of the switch. In the front panel, the linked ports will display green; as to the ports, which are link off, they will be dark. For the optional modules, the slot will show only a cover plate if no module exists and will show a module if a module is present. The image of module depends on the one you inserted. The same, if disconnected, the port will show just dark, if linked, green.

In this device, there are clicking functions on the panel provided for the information of the ports. These are very convenient functions for browsing the information of a single port. When clicking the port on the front panel, an information window for the port will be pop out. (See Fig. 3-3)

Port 1 Detail Information

Link	Up
State	Enabled
Auto Negotiation	Enabled
Speed/Duplex	100M/Half
Rx Pause	ON
Tx Pause	OFF
Tx Byte	276217
Rx Byte	246861
Tx Packet	651
Rx Packet	2297
Tx Collision	0
Rx Error Packet	0
Description	

Close

Fig. 3-3 port detail information

In Fig. 3-3, it shows the basic information of the clicked port. With this, you'll see the information about the port status, traffic status and bandwidth rating for egress and ingress respectively.

- On the left-top corner, there is a pull-down list for Auto Logout. For the sake of security, we provide auto-logout function to protect you from illegal user as you are leaving. If you do not choose any selection in Auto Logout list, it means you turn on the Auto Logout function and the system will be logged out automatically when no action on the device 3 minutes later. If OFF is chosen, the screen will keep as it is. Default is ON.
- On the left side, the main menu tree for web is listed in the page. They are hierarchical menu. Open the function folder, a sub-menu will be shown. The functions of each folder are described in its corresponded section respectively. When clicking it, the function is performed. The following list is the full function tree for web user interface.

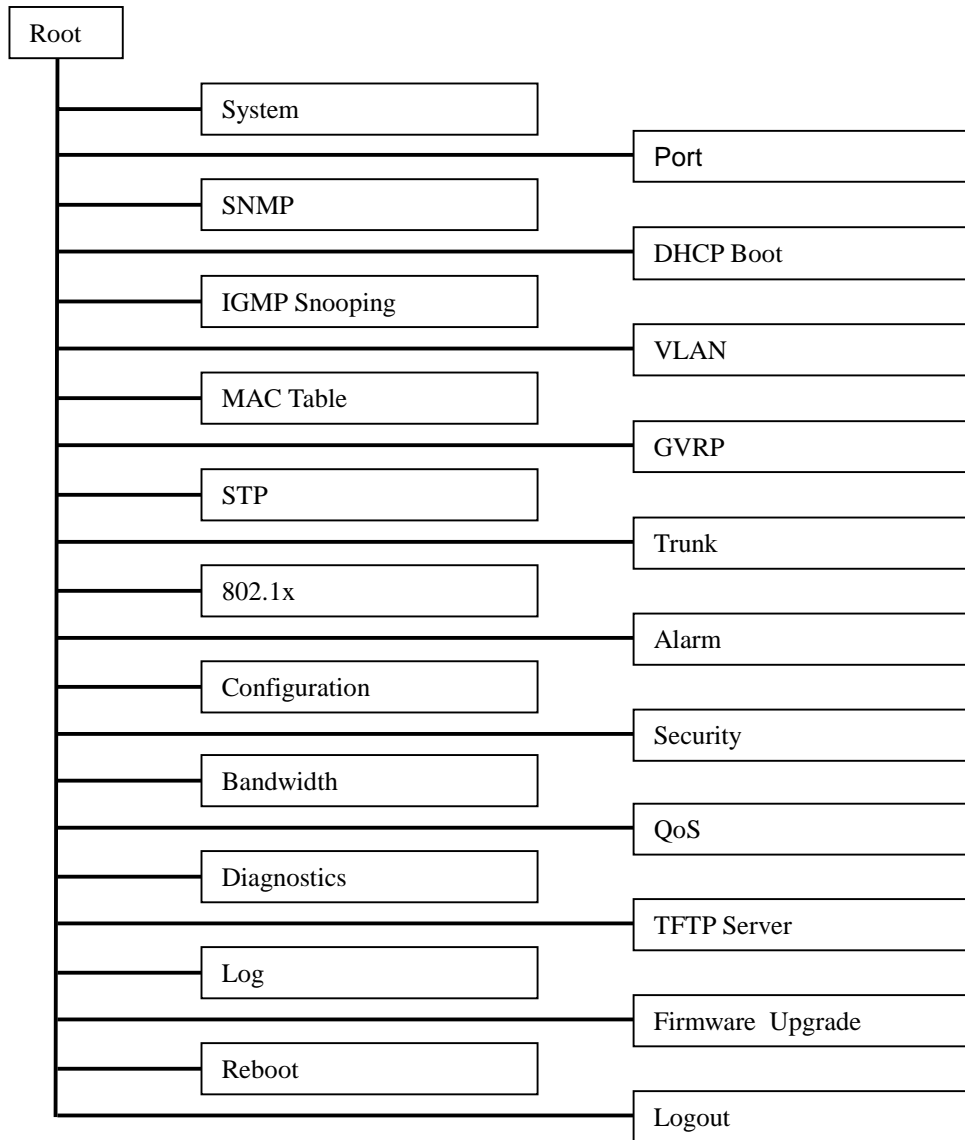

3-1-1. System Information

Function name:

System Information

Function description:

Show the basic system information.

Parameter description:

Model name:

The model name of this device.

System description:

As it is, this tells what this device is. Here, it is "24 Fast Ethernet + 2 Gigabit L2 Managed Switch".

Location:

Basically, it is the location where this switch is put. User-defined.

Contact:

For easily managing and maintaining device, you may write down the contact person and phone here for getting help soon. You can configure this parameter through the device's user interface or SNMP.

Device name:

The name of the switch. User-defined.

System up time:

The time accumulated since this switch is powered up. Its format is day, hour, minute, second.

Current time:

Show the system time of the switch. Its format: day of week, month, day, hours: minutes: seconds, year. For instance, Tue Apr 20 23:25:58 2004

BIOS version:

The version of the BIOS in this switch.

Firmware version:

The firmware version in this switch.

Hardware-Mechanical version:

The version of Hardware and Mechanical. The figure before the hyphen is the version of electronic hardware; the one after the hyphen is the version of mechanical.

Serial number:

The serial number is assigned by the manufacturer.

Host IP address:

The IP address of the switch.

Host MAC address:

It is the Ethernet MAC address of the management agent in this switch.

Device Port:

Show all types and numbers of the port in the switch.

RAM size:

The size of the DRAM in this switch.

Flash size:

The size of the flash memory in this switch.

3-1-2. IP Configuration

IP configuration is one of the most important configurations in the switch. Without the proper setting, network manager will not be able to manage or view the device. The switch supports both manual IP address setting and automatic IP address setting via DHCP server. When IP address is changed, you must reboot the switch to have the setting taken effect and use the new IP to browse for web management and CLI management.

IP Configuration

DHCP Setting	Disable ▾
IP Address	192.168.4.1
Subnet Mask	255.255.255.0 ▾
Default Gateway	192.168.4.254
DNS Server	Manual ▾ 0.0.0.0

Apply

Fig. 3-4 IP Address Configuration

Function name:

IP Configuration

Function description:

Set IP address, subnet mask, default gateway and DNS for the switch.

Parameter description:

DHCP Setting:

DHCP is the abbreviation of Dynamic Host Configuration Protocol. Here DHCP means a switch to turn ON or OFF the function.

The switch supports DHCP client used to get an IP address automatically if you set this function "Enable". When enabled, the switch will issue the request to the DHCP server resided in the network to get an IP address. If DHCP server is down or does not exist, the switch will issue the request and show IP address is under requesting, until the DHCP server is up. Before getting an IP address from DHCP server, the device will not continue booting procedures. If set this field "Disable", you'll have to input IP address manually. For more details about IP address and DHCP, please see the Section 2-1-5 "IP Address Assignment" in this manual.

Default: Disable

IP address:

Users can configure the IP settings and fill in new values if users set the DHCP function "Disable". Then, click **<Apply>** button to update.

When DHCP is disabled, Default: 192.168.1.1

If DHCP is enabled, this field is filled by DHCP server and will not allow user manually set it any more.

Subnet mask:

Subnet mask is made for the purpose to get more network address because any IP device in a network must own its IP address, composed of Network address and Host address, otherwise can't communicate with other devices each other. But unfortunately, the network classes A, B, and C are all too large to fit for almost all networks, hence, subnet mask is introduced to solve this problem. Subnet mask uses some bits from host address and makes an IP address looked Network address, Subnet mask number and host address. It is shown in the following figure. This reduces the total IP number of a network able to support, by the amount of 2 power of the bit number of subnet number ($2^{\text{(bit number of subnet number)}}$).

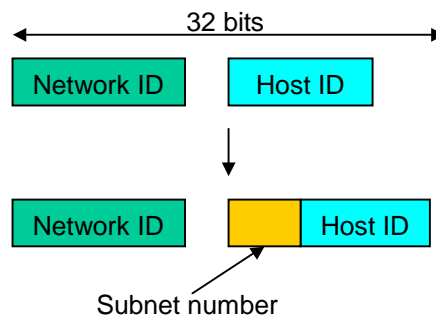

Subnet mask is used to set the subnet mask value, which should be the same value as that of the other devices resided in the same network it attaches.

For more information, please also see the Section 2-1-5 "IP Address Assignment" in this manual.

Default: 255.255.255.0

Default gateway:

Set an IP address for a gateway to handle those packets that do not meet the routing rules predefined in the device. If a packet does not meet the criteria for other pre-defined path, it must be forwarded to a default router on a default path. This means any packet with undefined IP address in the routing table will be sent to this device unconditionally.

Default: 192.168.1.254

DNS:

It is Domain Name Server used to serve the translation between IP address and name address.

The switch supports DNS client function to re-route the mnemonic name address to DNS server to get its associated IP address for accessing Internet. User can specify a DNS IP address for the switch. With this, the switch can translate a mnemonic name address into an IP address.

There are two ways to specify the IP address of DNS. One is fixed mode, which manually specifies its IP address, the other is dynamic mode, which is assigned by DHCP server while DHCP is enabled. DNS can help you easily remember the mnemonic address name with the meaningful words in it. Default is no assignment of DNS address.

Default: 0.0.0.0

3-1-3. Time Configuration

The switch provides manual and automatic ways to set the system time via NTP. Manual setting is simple and you just input "Year", "Month", "Day", "Hour", "Minute" and "Second" within the valid value range indicated in each item. If you input an invalid value, for example, 61 in minute, the switch will clamp the figure to 59.

NTP is a well-known protocol used to synchronize the clock of the switch system time over a network. NTP, an internet draft standard formalized in RFC 1305, has been adopted on the system is version 3 protocol. The switch provides four built-in NTP server IP addresses resided in the Internet and a user-defined NTP server IP address. The time zone is Greenwich-centered which uses the expression form of GMT+/- xx hours.

Function name:

Time

Function description:

Set the system time by manual input or set it by syncing from Time servers. The function also supports daylight saving for different area's time adjustment.

Parameter description:

Current Time:

Show the current time of the system.

Manual:

This is the function to adjust the time manually. Filling the valid figures in the fields of Year, Month, Day, Hour, Minute and Second respectively and press **<Apply>** button, time is adjusted. The valid figures for the parameter Year, Month, Day, Hour, Minute and Second are ≥ 2000 , 1-12, 1-31, 0-23, 0-59 and 0-59 respectively. Input the wrong figure and press **<Apply>** button, the device will reject the time adjustment request. There is no time zone setting in Manual mode.

Default: Year = 2000, Month = 1, Day = 1
 Hour = 0, Minute = 0, Second = 0

NTP:

NTP is Network Time Protocol and is used to sync the network time based Greenwich Mean Time (GMT). If use the NTP mode and select a built-in NTP time server or manually specify an user-defined NTP server as well as Time Zone, the switch will sync the time in a short after pressing **<Apply>** button. Though it synchronizes the time automatically, NTP does not update the time periodically without user's processing.

Time Zone is an offset time off GMT. You have to select the time zone first and then perform time sync via NTP because the switch will combine this time zone offset and updated NTP time to come out the local time, otherwise, you will not able to get the correct time. The switch supports configurable time zone from -12 to +13 step 1 hour.

Default Time zone: +8 Hrs.

Daylight Saving:

Daylight saving is adopted in some countries. If set, it will adjust the time lag or in advance in unit of hours, according to the starting date and the ending date. For example, if you set the day light saving to be 1 hour. When the time passes over the starting time, the system time will be increased one hour after one minute at the time since it passed over. And when the time passes over the ending time, the system time will be decreased one hour after one minute at the time since it passed over.

The switch supports valid configurable day light saving time is -5 ~ +5 step one hour. The zero for this parameter means it need not have to adjust current time, equivalent to in-act daylight saving. You don't have to set the starting/ending date as well. If you set daylight saving to be non-zero, you have to set the starting/ending date as well; otherwise, the daylight saving function will not be activated.

Default for Daylight Saving: 0.

The following parameters are configurable for the function Daylight Saving and described in detail.

Day Light Saving Start :

This is used to set when to start performing the day light saving time.

Mth:

Range is 1 ~ 12.

Default: 1

Day:

Range is 1 ~ 31.

Default: 1

Hour:

Range is 0 ~ 23.

Default: 0

Day Light Saving End:

This is used to set when to stop performing the daylight saving time.

Mth:

Range is 1 ~ 12.

Default: 1

Day:

Range is 1 ~ 31.

Default: 1

Hour:

Range is 0 ~ 23.

Default: 0

System Time Setting

Current Time		Tue Nov 14 13:12:53 2006					
<input checked="" type="radio"/> Manual	Year	<input type="text" value="2006"/> (2000~2036)	Month	<input type="text" value="11"/> (1~12)			
	Day	<input type="text" value="14"/> (1~31)	Hour	<input type="text" value="13"/> (0~23)			
	Minute	<input type="text" value="12"/> (0~59)	Second	<input type="text" value="53"/> (0~59)			
<input type="radio"/> NTP	<input checked="" type="radio"/> 209.81.9.7(USA)			Time Zone <input type="text" value="GMT+8:00"/>			
	<input type="radio"/> 137.189.8.174(HK)						
	<input type="radio"/> 133.100.9.2(JP)						
	<input type="radio"/> 131.188.3.222(Germany)						
	<input type="text"/>						
Daylight Saving		<input type="text" value="0"/>					
Daylight Saving Start		Mth	<input type="text" value="1"/>	Day	<input type="text" value="1"/>	Hour	<input type="text" value="0"/>
Daylight Saving End		Mth	<input type="text" value="1"/>	Day	<input type="text" value="1"/>	Hour	<input type="text" value="0"/>
<input type="button" value="Apply"/>							

Fig. 3-5

3-1-4. Account Configuration

In this function, only administrator can create, modify or delete the username and password. Administrator can modify other guest identities' password without confirming the password but it is necessary to modify the administrator-equivalent identity. Guest-equivalent identity can modify his password only. Please note that you must confirm administrator/guest identity in the field of Authorization in advance before configuring the username and password. Only one administrator is allowed to exist and unable to be deleted. In addition, up to 4 guest accounts can be created.

The default setting for user account is:

Username : admin

Password : admin

The default setting for guest user account is:

Username : guest

Password : guest

Account Configuration

Account Name	Authorization
admin	Administrator
guest	Guest

Create New

Edit

Delete

Fig. 3-6

3-1-5. Management Security

Through the management security configuration, the manager can do the strict setup to control the switch and limit the user to access this switch.

The following rules are offered for the manager to manage the switch:

Rule 1) : When no list exists, then it will accept all connections.

Accept

Rule 2) : When only “accept lists” exist, then it will deny all connections, excluding the connection inside of the accepting range.

Accept Deny **Accept** Deny **Accept**

Rule 3) : When only “deny lists” exist, then it will accept all connections, excluding the connection inside of the denying range.

Deny Accept **Deny** Accept **Deny**

Rule 4) : When both “accept and deny” lists exist, then it will deny all connections, excluding the connection inside of the accepting range.

Accept Deny **Deny** Deny **Accept**

Rule 5) : When both “accept and deny” lists exist, then it will deny all connections, excluding the connection inside of the accepting range and NOT inside of the denying range at the same time.

Accept	Deny
--------	------

Accept

Deny | Acc | Deny | Acc | Deny

Function name:

Management Security Configuration

Function description:

The switch offers Management Security Configuration function. With this function, the manager can easily control the mode that the user connects to the switch. According to the mode, users can be classified into two types: Those who are able to connect to the switch (Accept) and those who are unable to connect to the switch (Deny). Some restrictions also can be placed on the mode that the user connect to the switch, for example, we can decide that which VLAN VID is able to be accepted or denied by the switch, the IP range of the user could be accepted or denied by the switch, the port that the user is allowed or not allowed to connect with the switch, or the way of controlling and connecting to the switch via Http, Telnet or SNMP.

Management Security Configuration

Name	VID	IP Range
<input type="text"/>	<input checked="" type="radio"/> Any <input type="radio"/> Custom <input type="text"/>	<input checked="" type="radio"/> Any <input type="radio"/> Custom <input type="text"/> -- <input type="text"/>

Incoming Port	Access Type	Action
<input checked="" type="radio"/> Any <input type="radio"/> Custom 1. <input type="checkbox"/> 2. <input type="checkbox"/> 3. <input type="checkbox"/> 4. <input type="checkbox"/> 5. <input type="checkbox"/> 6. <input type="checkbox"/> 7. <input type="checkbox"/> 8. <input type="checkbox"/> 9. <input type="checkbox"/> 10. <input type="checkbox"/> 11. <input type="checkbox"/> 12. <input type="checkbox"/> 13. <input type="checkbox"/> 14. <input type="checkbox"/> 15. <input type="checkbox"/> 16. <input type="checkbox"/> 17. <input type="checkbox"/> 18. <input type="checkbox"/> 19. <input type="checkbox"/> 20. <input type="checkbox"/> 21. <input type="checkbox"/> 22. <input type="checkbox"/> 23. <input type="checkbox"/> 24. <input type="checkbox"/> 25. <input type="checkbox"/> 26. <input type="checkbox"/>	<input checked="" type="radio"/> Any <input type="radio"/> Custom <input type="checkbox"/> Http <input type="checkbox"/> Telnet <input type="checkbox"/> SNMP	<input type="radio"/> Deny <input checked="" type="radio"/> Accept

Name	VID	IP Range	Incoming Port	Access Type	Action
------	-----	----------	---------------	-------------	--------

Fig. 3-7

Parameter description:

Name:

A name is composed of any letter (A-Z, a-z) and digit (0-9) with maximal 8 characters.

VID:

The switch supports two kinds of options for managed valid VLAN VID, including "Any" and "Custom". Default is "Any". When you choose "Custom", you can fill in VID number. The valid VID range is 1~4094.

IP Range:

The switch supports two kinds of options for managed valid IP Range, including "Any" and "Custom". Default is "Any". In case that "Custom" had been chosen, you can assign effective IP range. The valid range is 0.0.0.0~255.255.255.255.

Incoming Port:

The switch supports two kinds of options for managed valid Port Range, including "Any" and "Custom". Default is "Any". You can select the ports that you would like them to be worked and restricted in the management security configuration if "Custom" had been chosen.

Access Type:

The switch supports two kinds of options for managed valid Access Type, including "Any" and "Custom". Default is "Any". "Http", "Telnet" and "SNMP" are three ways for the access and managing the switch in case that "Custom" had been chosen.

Action:

The switch supports two kinds of options for managed valid Action Type, including "Deny" and "Accept". Default is "Deny". When you choose "Deny" action, you will be restricted and refused to manage the switch due to the "Access Type" you choose. However, while you select "Accept" action, you will have the authority to manage the switch.

Edit/Create:

A new entry of Management Security Configuration can be created after the parameters as mentioned above had been setup and then press **<Edit/Create>** button. Of course, the existed entry also can be modified by pressing this button.

Delete:

Remove the existed entry of Management Security Configuration from the management security table.

3-1-6. Virtual Stack

Function name:

Virtual Stack

Function description:

Virtual Stack Management(VSM) is the group management function. Through the proper configuration of this function, switches in the same LAN will be grouped automatically. And among these switch, one switch will be a master machine, and the others in this group will become the slave devices.

VSM offers a simple centralized management function. It is not necessary to remember the address of all devices; manager is capable of managing the network with knowing the address of the Master machine. Instead of SNMP or Telnet UI, VSM is only available in Web UI. While one switch becomes the Master, two rows of buttons for group device will appear on the top of its Web UI. By pressing these buttons, user will be allowed to connect the Web UI of the devices of the group in the same window without the login of these devices.

The most top-left button is only for Master Device. The background color of the button you press will be changed to represent that the device is under your management.

Note: It will remove the grouping temporarily in case that you login the switch via the console.

The device of the group will be shown as station address (the last number of IP Address) + device name on the button, otherwise it will show " ---- " if no corresponding device exists.

Once the devices join the group successfully, then they are merely able to be managed via Master device, and user will fail to manage them via telnet/console/web individually.

Up to 16 devices can be grouped for VSM; however, only one Master is allowed to exist in each group. For Master redundancy, user may configure more than two devices as Master device; however, the Master device with the smaller MAC value will be the Master one. All of these 16 devices can become Master device and back up with each other.

Virtual Stack Configuration

State	Disable ▾
Role	Slave ▾
Group ID	default

Apply

Note: You should be logout every time when you change the state of Virtual Stack.

Fig. 3-8

Parameter description:

State:

It is used for the activation or de-activation of VSM. Default is Enable.

Role:

The role that the switch would like to play in virtual stack. Two types of roles, including master and slave are offered for option. Default is Master.

Group ID:

It is the group identifier (GID) which signs for VSM. Valid letters are A-Z, a-z, 0-9, “ - “ and “_” characters. The maximal length is 15 characters.

3-2. Port Configuration

Four functions, including Port Status, Port Configuration, Simple Counter and Detail Counter are contained in this function folder for port monitor and management. Each of them will be described in detail orderly in the following sections.

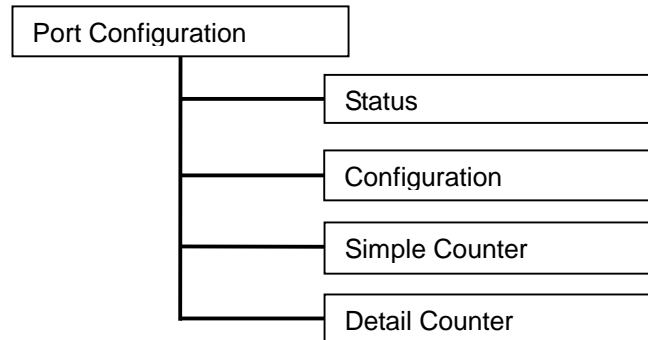

3-2-1.Port Status

The function Port Status gathers the information of all ports' current status and reports it by the order of port number, media, link status, port state, Auto-Negotiation status, speed/duplex, Rx Pause and Tx Pause. An extra media type information for the module ports 25 and 26 is also offered.

Port Current Status

Port No	Media	Link	State	Auto Nego.	Speed/Duplex	Rx Pause	Tx Pause	Port Description
1	TP	Up	Enabled	Enabled	100M/Half	On	Off	
2	TP	Down	Enabled	Enabled	---/----	-----	-----	
3	TP	Down	Enabled	Enabled	---/----	-----	-----	
4	TP	Down	Enabled	Enabled	---/----	-----	-----	
5	TP	Down	Enabled	Enabled	---/----	-----	-----	
6	TP	Down	Enabled	Enabled	---/----	-----	-----	
7	TP	Down	Enabled	Enabled	---/----	-----	-----	
8	TP	Down	Enabled	Enabled	---/----	-----	-----	
9	TP	Down	Enabled	Enabled	---/----	-----	-----	
10	TP	Down	Enabled	Enabled	---/----	-----	-----	
11	TP	Down	Enabled	Enabled	---/----	-----	-----	
12	TP	Down	Enabled	Enabled	---/----	-----	-----	
13	TP	Down	Enabled	Enabled	---/----	-----	-----	
14	TP	Down	Enabled	Enabled	---/----	-----	-----	
15	TP	Down	Enabled	Enabled	---/----	-----	-----	
16	TP	Down	Enabled	Enabled	---/----	-----	-----	
17	TP	Down	Enabled	Enabled	---/----	-----	-----	
18	TP	Down	Enabled	Enabled	---/----	-----	-----	
19	TP	Down	Enabled	Enabled	---/----	-----	-----	
20	TP	Down	Enabled	Enabled	---/----	-----	-----	
21	TP	Down	Enabled	Enabled	---/----	-----	-----	
22	TP	Down	Enabled	Enabled	---/----	-----	-----	
23	TP	Down	Enabled	Enabled	---/----	-----	-----	
24	TP	Down	Enabled	Enabled	---/----	-----	-----	
25	Fiber	Down	Enabled	Enabled	---/----	-----	-----	
26	TP	Down	Enabled	Enabled	---/----	-----	-----	

Fig. 3-9

Function name:

Port Status

Function Description:

Report the latest updated status of all ports in this switch. When any one of the ports in the switch changes its parameter displayed in the page, it will be automatically refreshed the port current status about every 5 seconds.

Parameter Description:

Port No:

Display the port number. The number is 1 – 26. Both port 25 and 26 are optional modules.

Media:

Show the media type adopted in all ports. The Port 25 and Port 26 are optional modules, which support either fiber or UTP media with either Gigabit Ethernet (1000Mbps) or 10/100Mbps Fast Ethernet port. They may have different media types and speed. Especially, fiber port has comprehensive types of connector, distance, fiber mode and so on. The switch describes the module ports with the following page.

Link:

Show that if the link on the port is active or not. If the link is connected to a working-well device, the Link will show the link “Up”; otherwise, it will show “Down”. This is determined by the hardware on both devices of the connection.

No default value.

State:

Show that the communication function of the port is “Enabled” or “Disabled”. When it is enabled, traffic can be transmitted and received via this port. When it is disabled, no traffic can be transferred through this port. Port State is configured by user.

Default: Enabled.

Auto Nego.:

Show the exchange mode of Ethernet MAC. There are two modes supported in the switch. They are auto-negotiation mode “Enabled” and forced mode “Disabled”. When in “Enabled” mode, this function will automatically negotiate by hardware itself and exchange each other the capability of speed and duplex mode with other site which is linked, and comes out the best communication way. When in “Disabled” mode, both parties must have the same setting of speed and duplex, otherwise, both of them will not be linked. In this case, the link result is “Down”.

Default: Enabled

Speed / Duplex :

Display the speed and duplex of all port. There are three speeds 10Mbps, 100Mbps and 1000Mbps supported for TP media, and the duplex supported is half duplex and full duplex. If the media is 1Gbps fiber, it is 1000Mbps supported only. The status of speed/duplex mode is determined by 1) the negotiation of both local port and link partner in "Auto Speed" mode or 2) user setting in "Force" mode. The local port has to be preset its capability.

In port 1 – 24, they are supported Fast Ethernet with TP media only, so the result will show 100M/Full or 100M/Half, 10M/Full and 10M/Half duplex.

In port 25 and port 26, if the media is 1000Mbps with TP media, it will show the combinations of 10/100M and Full/Half duplex, 1000Mbps and Full duplex only. If the media is 1000Mbps with fiber media, it will show only 1000M/Full duplex.

Default: None, depends on the result of the negotiation.

Rx Pause:

The way that the port adopts to process the PAUSE frame. If it shows "on", the port will care the PAUSE frame; otherwise, the port will ignore the PAUSE frame.

Default: None

Tx Pause:

It decides that whether the port transmits the PAUSE frame or not. If it shows "on", the port will send PAUSE frame; otherwise, the port will not send the PAUSE frame.

Default: None

Port 25 Detail Information

Connector Type	SFP - LC
Fiber Type	Multi-mode (MM)
Tx Central Wavelength	850
Baud Rate	1G
Vendor OUI	00:40:c7
Vendor Name	APAC Opto
Vendor PN	KM28-C3S-TC-N
Vendor Rev	0000
Vendor SN	5425010710
Date Code	050530
Temperature	none
Vcc	none
Mon1 (Bias) mA	none
Mon2 (TX PWR)	none
Mon3 (RX PWR)	none

Close

Fig. 3-10

Parameter description of Port 25 and Port 26:

Connector Type:

Display the connector type, for instance, UTP, SC, ST, LC and so on.

Fiber Type:

Display the fiber mode, for instance, Multi-Mode, Single-Mode.

Tx Central Wavelength:

Display the fiber optical transmitting central wavelength, for instance, 850nm, 1310nm, 1550nm and so on.

Baud Rate:

Display the maximum baud rate of the fiber module supported, for instance, 10M, 100M, 1G and so on.

Vendor OUI:

Display the Manufacturer's OUI code which is assigned by IEEE.

Vendor Name:

Display the company name of the module manufacturer.

Vendor P/N:

Display the product name of the naming by module manufacturer.

Vendor Rev (Revision):

Display the module revision.

Vendor SN (Serial Number):

Show the serial number assigned by the manufacturer.

Date Code:

Show the date this module was made.

Temperature:

Show the current temperature of module.

Vcc:

Show the working DC voltage of module.

Mon1(Bias) mA:

Show the Bias current of module.

Mon2(TX PWR):

Show the transmit power of module.

Mon3(RX PWR):

Show the receiver power of module.

3-2-2. Port Configuration

Port Configuration is applied to change the setting of each port. In this configuration function, you can set/reset the following functions. All of them are described in detail below.

Port No	State	Speed/Duplex	Flow Control
1	Enable	Auto	Symmetric
2	Enable	Auto	Symmetric
3	Enable	Auto	Symmetric
4	Enable	Auto	Symmetric
5	Enable	Auto	Symmetric
6	Enable	Auto	Symmetric
7	Enable	Auto	Symmetric
8	Enable	Auto	Symmetric
9	Enable	Auto	Symmetric
10	Enable	Auto	Symmetric
11	Enable	Auto	Symmetric
12	Enable	Auto	Symmetric
13	Enable	Auto	Symmetric
14	Enable	Auto	Symmetric
15	Enable	Auto	Symmetric
16	Enable	Auto	Symmetric
17	Enable	Auto	Symmetric
18	Enable	Auto	Symmetric
19	Enable	Auto	Symmetric
20	Enable	Auto	Symmetric
21	Enable	Auto	Symmetric

Fig. 3-11

Function name:

Port Configuration

Function description:

It is used to set each port's operation mode. The switch supports 3 parameters for each port. They are State, Speed/Duplex and Flow Control.

Parameter description:

State:

Set the communication capability of the port is Enabled or Disabled. When enabled, traffic can be transmitted and received via this port. When disabled, the port is blocked and no traffic can be transferred through this port. Port State is configurable by the user. There are only two states "Enable" and "Disable" able to choose. If you set a port's state "Disable", then that port is prohibited to pass any traffic, even it looks Link up.

Default: Enable.

Speed/Duplex:

Set the speed and duplex of the port. In speed, 10/100Mbps baud rate is available for Fast Ethernet, Gigabit module in port 25, 26. If the media is 1Gbps fiber, it is always 1000Mbps and the duplex is full only. If the media is TP, the Speed/Duplex is comprised of the combination of speed mode, 10/100/1000Mbps, and duplex mode, full duplex and half duplex. The following table summarized the function the media supports.

Media type	NWay	Speed	Duplex
100M TP	ON/OFF	10/100M	Full/Half
1000M TP	ON/OFF	10/100/1000M	Full for all, Half for 10/100
1000M Fiber	ON/OFF	1000M	Full

In Auto-negotiation mode, no default value. In Forced mode, default value depends on your setting.

Flow Control:

There are two modes to choose in flow control, including Symmetric and Asymmetric. If flow control is set Symmetric, both parties can send PAUSE frame to the transmitting device(s) if the receiving port is too busy to handle. When it is set Asymmetric, this will let the receiving port care the PAUSE frame from transmitting device(s), but it doesn't send PAUSE frame. This is one-way flow control.

Default: Symmetric.

3-2-3. Port Description

Port Description is applied to change the setting of each port. In this configuration function, you can give a name to each port. All of them are described in detail below.

Port	Description
1	Samuel PC
2	Wendy NB
3	Wade Server
4	Akira WorkStation
5	Lorence PC
6	Eric Router
7	Benson PC
8	Harry NB

Fig. 3-12

Function name:

Port Description

Function description:

It is used to set each port's description. This human readable description can make the port management easier.

Parameter description:

Description:

This field can enter up to 47 characters for the port description purpose.
Default: <Empty>.

3-2-5. Simple Counter

The function of Simple Counter collects any information and provides the counting about the traffic of the port, no matter the packet is good or bad.

In the Fig. 3-13, the window can show all ports' counter information at the same time. Each data field has 20-digit long. If the counting is overflow, the counter will be reset and restart counting. The data is updated every time interval defined by the user. The valid range is 3 to 10 seconds. The Refresh Interval is used to set the update frequency. Default update time is 3 seconds.

Simple Counter

Refresh Interval Reset

Time elapsed since last reset: 0 Days 0 Hours 8 Mins 25 Secs

Port No	Tx Byte	Rx Byte	Tx Packet	Rx Packet	Tx Collision	Rx Error Packet
1	505260	204060	1062	1636	0	0
2	0	0	0	0	0	0
3	0	0	0	0	0	0
4	0	0	0	0	0	0
5	0	0	0	0	0	0
6	0	0	0	0	0	0
7	0	0	0	0	0	0
8	0	0	0	0	0	0
9	0	0	0	0	0	0
10	0	0	0	0	0	0
11	0	0	0	0	0	0
12	0	0	0	0	0	0
13	0	0	0	0	0	0
14	0	0	0	0	0	0
15	0	0	0	0	0	0
16	0	0	0	0	0	0
17	0	0	0	0	0	0
18	0	0	0	0	0	0
19	0	0	0	0	0	0
20	0	0	0	0	0	0
21	0	0	0	0	0	0
22	0	0	0	0	0	0
23	0	0	0	0	0	0
24	0	0	0	0	0	0

Fig. 3-13

Function name:

Simple Counter

Function description:

Display the summary counting of each port's traffic, including Tx Byte, Rx Byte, Tx Packet, Rx Packet, Tx Collision and Rx Error Packet.

Parameters description:

Tx Byte:

Total transmitted bytes.

Rx Byte:

Total received bytes.

Tx Packet:

The counting number of the packet transmitted.

Rx Packet:

The counting number of the packet received.

Tx Collision:

Number of collisions transmitting frames experienced.

Rx Error Packet:

Number of bad packets received.

3-2-4. Detail Counter

The function of Detail Counter collects any information and provides the counting about the traffic of the port, no matter the packet is good or bad.

In the Fig. 3-14, the window can show only one port counter information at the same time. To see another port's counter, you have to pull down the list of Select, then you will see the figures displayed about the port you had chosen.

Each data field has 20-digit long. If the counting is overflow, the counter will be reset and restart counting. The data is updated every time interval defined by the user. The valid range is 3 to 10 seconds. The Refresh Interval is used to set the update frequency. Default update time is 3 seconds.

Detail Counter			
Select	Port 1	Refresh Interval	3 sec
Time elapsed since last reset: 0 Days 0 Hours 9 Mins 23 Secs			
Receive Total		Transmit Error Counters	
Rx Packets	1817	Tx Collisions	0
Rx Octets	226198	Tx Single Collision	0
Rx Errors	0	Tx Multiple Collision	0
Rx Unicast Packets	1070	Tx Drop Packets	0
Rx Broadcast Packets	747	Tx Deferred Transmit	0
Rx Multicast Packets	0	Tx Late Collision	0
Rx Pause Packets	0	Tx Excessive Collision	0
Receive Size Counters		Transmit Total	
Packets 64 Octets	693	Tx Packets	1151
Packets 65 to 127 Octets	934	Tx Octets	548975
Packets 128 to 255 Octets	1	Tx Unicast Packets	1151
Packets 256 to 511 Octets	49	Tx Broadcast Packets	0
Packets 512 to 1023 Octets	140	Tx Multicast Packets	0
Packets 1024 to 1522 Octets	0	Tx Pause Packets	0
Receive Error Counters			
Rx FCS Errors	0		
Rx Alignment Errors	0		
Rx Fragments	0		
Rx Jabbers	0		

Fig. 3-14

Function name:

Detail Counter

Function description:

Display the detailed counting number of each port's traffic. In the Fig. 3-14, the window can show all counter information of each port at one time.

Parameter description:

Rx Packets:

The counting number of the packet received.

Rx Octets:

Total received bytes.

Rx Errors:

Number of bad packets received.

Rx Unicast Packets:

Show the counting number of the received unicast packet.

Rx Broadcast Packets:

Show the counting number of the received broadcast packet.

Rx Multicast Packets:

Show the counting number of the received multicast packet.

Rx Pause Packets:

Show the counting number of the received pause packet.

Tx Collisions:

Number of collisions transmitting frames experienced.

Tx Single Collision:

Number of frames transmitted that experienced exactly one collision.

Tx Multiple Collision:

Number of frames transmitted that experienced more than one collision.

Tx Drop Packets:

Number of frames dropped due to excessive collision, late collision, or frame aging.

Tx Deferred Transmit:

Number of frames delayed to transmission due to the medium is busy.

Tx Late Collision:

Number of times that a collision is detected later than 512 bit-times into the transmission of a frame.

Tx Excessive Collision:

Number of frames that are not transmitted because the frame experienced 16 transmission attempts.

Packets 64 Octets:

Number of 64-byte frames in good and bad packets received.

Packets 65-127 Octets:

Number of 65 ~ 127-byte frames in good and bad packets received.

Packets 128-255 Octets:

Number of 128 ~ 255-byte frames in good and bad packets received.

Packets 256-511 Octets:

Number of 256 ~ 511-byte frames in good and bad packets received.

Packets 512-1023 Octets:

Number of 512 ~ 1023-byte frames in good and bad packets received.

Packets 1024- 1522 Octets:

Number of 1024-1522-byte frames in good and bad packets received.

Tx Packets:

The counting number of the packet transmitted.

TX Octets:

Total transmitted bytes.

Tx Unicast Packets:

Show the counting number of the transmitted unicast packet.

Tx Broadcast Packets:

Show the counting number of the transmitted broadcast packet.

Tx Multicast Packets:

Show the counting number of the transmitted multicast packet.

Tx Pause Packets:

Show the counting number of the transmitted pause packet.

Rx FCS Errors:

Number of bad FSC packets received.

Rx Alignment Errors:

Number of Alignment errors packets received.

Rx Fragments:

Number of short frames (< 64 bytes) with invalid CRC.

Rx Jabbers:

Number of long frames (according to max_length register) with invalid CRC.

Rx Drop Packets:

Frames dropped due to the lack of receiving buffer.

Rx Undersize Packets:

Number of short frames (<64 Bytes) with valid CRC.

Rx Oversize Packets:

Number of long frames (according to max_length register) with valid CRC.

3-3. SNMP Configuration

Any Network Management System (NMS) running the Simple Network Management Protocol (SNMP) can manage the Managed devices equipped with SNMP agent, provided that the Management Information Base (MIB) is installed correctly on the managed devices. The SNMP is a protocol that is used to govern the transfer of information between SNMP manager and agent and traverses the Object Identity (OID) of the management Information Base (MIB), described in the form of SMI syntax. SNMP agent is running on the switch to response the request issued by SNMP manager.

Basically, it is passive except issuing the trap information. The switch supports a switch to turn on or off the SNMP agent. If you set the field SNMP "Enable", SNMP agent will be started up. All supported MIB OIDs, including RMON MIB, can be accessed via SNMP manager. If the field SNMP is set "Disable", SNMP agent will be de-activated, the related Community Name, Trap Host IP Address, Trap and all MIB counters will be ignored.

Function name:

SNMP Configuration

Function description:

This function is used to configure SNMP settings, community name, trap host and public traps as well as the throttle of SNMP. A SNMP manager must pass the authentication by identifying both community names, and then it can access the MIB information of the target device. So, both parties must have the same community name. Once completing the setting, click **<Apply>** button, the setting takes effect.

Parameters description:

SNMP:

The term SNMP here is used for the activation or de-activation of SNMP. Default is Enable.

Get/Set/Trap Community:

Community name is used as password for authenticating if the requesting network management unit belongs to the same community group. If they both don't have the same community name, they don't belong to the same group. Hence, the requesting network management unit can not access the device with different community name via SNMP protocol; If they both have the same community name, they can talk each other.

Community name is user-definable with a maximum length of 15 characters and is case sensitive. There is not allowed to put any blank in the community name string. Any printable character is allowable.

The community name for each function works independently. Each function has its own community name. Say, the community name for GET only works for GET function and can't be applied to other function such as SET and Trap.

Default SNMP function: Enable
 Default community name for GET: public
 Default community name for SET: private
 Default community name for Trap: public
 Default Set function: Enable
 Default trap host IP address: 0.0.0.0
 Default port number: 162

Trap:

In the switch, there are 6 trap hosts supported. Each of them has its own community name and IP address; is user-definable. To set up a trap host means to create a trap manager by assigning an IP address to host the trap message. In other words, the trap host is a network management unit with SNMP manager receiving the trap message from the managed switch with SNMP agent issuing the trap message. 6 trap hosts can prevent the important trap message from losing.

For each public trap, the switch supports the trap event Cold Start, Warm Start, Link Down, Link Up and Authentication Failure Trap. They can be enabled or disabled individually. When enabled, the corresponded trap will actively send a trap message to the trap host when a trap happens. If all public traps are disabled, no public trap message will be sent. As to the Enterprise (no. 6) trap is classified as private trap, which are listed in the Trap Alarm Configuration function folder.

Default for all public traps: Enable.

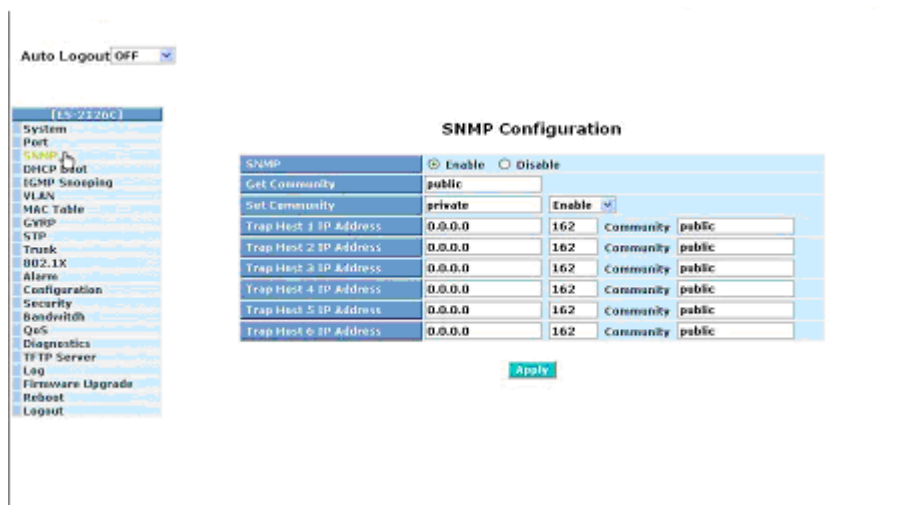

Fig. 3-15 Community and trap host setting

3-4. Loop Detection

Looping will always occur when the switches are connected as a cycle and a switch transmits the packets that will go back to the transmitted switch. Loop Detection will prevent the looping from happening. Moreover, it could remove the looping phenomenon per port. In general, you can unplug the cable connection to stop the looping when a port causes the looping. The switch has powerful Looping Detection capability, which could cease the looping immediately.

7	Disable	Unlocked	<input type="checkbox"/> Unlock
8	Disable	Unlocked	<input type="checkbox"/> Unlock
9	Disable	Unlocked	<input type="checkbox"/> Unlock
10	Disable	Unlocked	<input type="checkbox"/> Unlock
11	Disable	Unlocked	<input type="checkbox"/> Unlock
12	Disable	Unlocked	<input type="checkbox"/> Unlock
13	Disable	Unlocked	<input type="checkbox"/> Unlock
14	Disable	Unlocked	<input type="checkbox"/> Unlock
15	Disable	Unlocked	<input type="checkbox"/> Unlock
16	Disable	Unlocked	<input type="checkbox"/> Unlock
17	Disable	Unlocked	<input type="checkbox"/> Unlock
18	Disable	Unlocked	<input type="checkbox"/> Unlock
19	Disable	Unlocked	<input type="checkbox"/> Unlock
20	Disable	Unlocked	<input type="checkbox"/> Unlock
21	Disable	Unlocked	<input type="checkbox"/> Unlock
22	Disable	Unlocked	<input type="checkbox"/> Unlock
23	Disable	Unlocked	<input type="checkbox"/> Unlock
24	Disable	Unlocked	<input type="checkbox"/> Unlock
25	Disable	Unlocked	<input type="checkbox"/> Unlock
26	Disable	Unlocked	<input type="checkbox"/> Unlock
Action <input type="checkbox"/> Enable			

Fig. 3-16 Loop Detection

Function name:

Loop Detection

Function description:

This function will start when you enable looping action by ticking the check box () of the Action. That will create some special packet for

looping detection. After enabling looping action, you should decide which port you would like to open loop detection capability. For example, you open the loop detection of port 1 as enable state. When the looping situation happens from port 1, Loop Detection will lock the port1's ability. And then you will see that the "Current Status" of port 1 shows Locked. In port status function, you can see that the State of Port Configuration of port 1 is "Disabled". So the port 1 will lose the essential ability the port could have. However, "Resume Action" in Loop Detection will remove the looping status. It is very convenient for looping happening in real networking environment. After any setting you done, please click the **<Apply>** button to have the setting taken effect. When looping has already happened, we suggest that the users could choose the looping port as "Enable" in advance. And then tick the check box () of the Action. That will get the better result for Looping removing.

Parameters description:

State:

Open the Loop Detection capability per port. The list has "Enable" and "Disable". Default is "Disable".

Current Status:

Show the looping status per port. It could be "Unlocked or Locked". Default is "Unlocked". When some port happens looping, it will show "Locked"

Resume Action:

Remove the looping status per port. Just tick the check box () of the Unlock to open resume action per port.

Refresh:

"Refresh" button could appear the instant Current Status of Loop Detection.

3-5. DHCP Boot

The DHCP Boot function is used to spread the request broadcast packet into a bigger time frame to prevent the traffic congestion due to broadcast packets from many network devices which may seek its NMS, boot server, DHCP server and many connections predefined when the whole building or block lose the power and then reboot and recover. At this moment, a bunch of switch or other network device on the LAN will try its best to find the server to get the services or try to set up the predefined links, they will issue many broadcast packets in the network.

The switch supports a random delay time for DHCP and boot delay for each device. This suppresses the broadcast storm while all devices are at booting stage in the same time. The maximum user-defined delay time is 30 sec. If DHCP Broadcasting Suppression function is enabled, the delay time is set randomly, ranging from 0 to 30 seconds, because the exactly delay time is computed by the switch itself. The default is "Disable".

DHCP Boot

DHCP Broadcast Suppression	<input type="text" value="Disable"/>	Delay Time	<input type="text" value="30"/>	(1-30 seconds)
<input type="button" value="Apply"/>				

Fig. 3-17

3-6. IGMP Snooping

The function, IGMP Snooping, is used to establish the multicast groups to forward the multicast packet to the member ports, and, in nature, avoids wasting the bandwidth while IP multicast packets are running over the network. This is because a switch that does not support IGMP or IGMP Snooping can not tell the multicast packet from the broadcast packet, so it can only treat them all as the broadcast packet. Without IGMP Snooping, the multicast packet forwarding function is plain and nothing is different from broadcast packet.

A switch supported IGMP Snooping with the functions of query, report and leave, a type of packet exchanged between IP Multicast Router/Switch and IP Multicast Host, can update the information of the Multicast table when a member (port) joins or leaves an IP Multicast Destination Address. With this function, once a switch receives an IP multicast packet, it will forward the packet to the members who joined in a specified IP multicast group before.

The packets will be discarded by the IGMP Snooping if the user transmits multicast packets to the multicast group that had not been built up in advance.

IGMP Snooping

Snooping Mode Disable Active Passive

IP Multicast Table

IP Address	VLAN ID	Member Port
------------	---------	-------------

Apply Refresh

Fig. 3-18

Function name:

IGMP Snooping Status

Function description:

IGMP is used to snoop the status of IP multicast groups and display its associated information in both tagged VLAN and non-tagged VLAN networks. Enabling IGMP with either passive or active mode, you can monitor the IGMP snooping information, which contains the multicast member list with the multicast groups, VID and member port.

Parameter description:

IGMP snooping mode selection:

The switch supports three kinds of IGMP Snooping status, including "Passive", "Active" and "Disable".

Disable:

Set "Disable" mode to disable IGMP Snooping function.

Default: Disable

Active:

In Active mode, IGMP snooping switch will periodically issue the Membership Query message to all hosts attached to it and gather the Membership report message to update the database of the Multicast table. By the way, this also reduces the unnecessary multicast traffic.

Passive:

In Passive Snooping mode, the IGMP snooping will not periodically poll the hosts in the groups. The switch will send a Membership Query message to all hosts only when it has received a Membership Query message from a router.

IP Address:

Show all multicast groups IP addresses that are registered on this device.

VLAN ID:

Show VLAN ID for each multicast group.

Member Port:

Show member ports that join each multicast group. Member port may be only or more than one.

Function name:

Allowed Group

Function description:

The Allowed Group function allows the IGMP Snooping to set up the IP multicast table based on user's specific conditions. IGMP report packets that meet the items you set up will be joined or formed the multicast group.

Allowed Group

IP Range		VID
<input checked="" type="radio"/> Any <input type="radio"/> Custom <input style="width: 100px;" type="text"/> -- <input style="width: 100px;" type="text"/>		<input checked="" type="radio"/> Any <input type="radio"/> Custom <input style="width: 100px;" type="text"/>

Port							
<input checked="" type="radio"/> Any <input type="radio"/> Custom							
1. <input type="checkbox"/>	2. <input type="checkbox"/>	3. <input type="checkbox"/>	4. <input type="checkbox"/>	5. <input type="checkbox"/>	6. <input type="checkbox"/>	7. <input type="checkbox"/>	8. <input type="checkbox"/>
9. <input type="checkbox"/>	10. <input type="checkbox"/>	11. <input type="checkbox"/>	12. <input type="checkbox"/>	13. <input type="checkbox"/>	14. <input type="checkbox"/>	15. <input type="checkbox"/>	16. <input type="checkbox"/>
17. <input type="checkbox"/>	18. <input type="checkbox"/>	19. <input type="checkbox"/>	20. <input type="checkbox"/>	21. <input type="checkbox"/>	22. <input type="checkbox"/>	23. <input type="checkbox"/>	24. <input type="checkbox"/>
25. <input type="checkbox"/>	26. <input type="checkbox"/>						

No	IP Range	VID	Applied Port
1	Any	Any	1, 2, 3, 4, 5, 6, 7, 8, 9, 10, 11, 12, 13, 14, 15, 16, 17, 18, 19, 20, 21, 22, 23, 24, 25, 26,

Fig. 3-19

Parameter description:

IP Range:

The switch supports two kinds of options for managed valid IP range, including "Any" and "Custom". Default is "Any". In case that "Custom" is chosen, you can assign effective IP range. The valid range is 224.0.0.0~239.255.255.255.

VID:

The switch supports two kinds of options for managed valid VLAN VID, including "Any" and "Custom". Default is "Any". When you choose "Custom", you can fill in VID number. The valid VID range is 1~4094.

Port:

The switch supports two kinds of options for managed valid port range, including "Any" and "Custom". Default is "Any". You can select the ports that you would like them to work and be restricted in the allowed group configuration if "Custom" is chosen.

Add:

A new entry of allowed group configuration can be created after the parameters as mentioned above had been setup and then press **<Add>** button.

Edit:

The existed entry also can be modified after pressing **<Edit>** button.

Delete:

Remove the existed entry of allowed group configuration from the allowed group.

3-7. VLAN

The switch supports Tag-based VLAN (802.1q) and Port-based VLAN. It supports 256 active VLANs and VLAN ID 1~4094. VLAN configuration is used to partition your LAN into small ones as your demand. Properly configuring it, you can gain not only improving security and increasing performance but greatly reducing VLAN management.

3-7-1. VLAN Mode

Function name:

VLAN Mode Setting

Function description:

The VLAN Mode Selection function includes two modes: Port-based and Tag-based, you can choose one of them by pulling down list and pressing the **<Downward>** arrow key. Then, click **<Apply>** button, the settings will take effect immediately.

Parameter description:

VLAN Mode:

Tag-based:

This is the default setting.

Tag-based VLAN identifies its member by VID. This is quite different from port-based VLAN. If there are any more rules in ingress filtering list or egress filtering list, the packet will be screened with more filtering criteria to determine if it can be forwarded. The switch supports supplement of 802.1q.

Each tag-based VLAN you built up must be assigned VLAN name and VLAN ID. Valid VLAN ID is 1-4094. User can create total up to 256 Tag VLAN groups.

Port-based:

Port-based VLAN is defined by port. Any packet coming in or outgoing from any one port of a port-based VLAN will be accepted. No filtering criterion applies in port-based VLAN. The only criterion is the physical port you connect to. For example, for a port-based VLAN named PVLAN-1 contains port members Port 1&2&3&4. If you are on the port 1, you can communicate with port 2&3&4. If you are on the port 5, then you cannot talk to them. Each port-based VLAN you built up must be assigned a group name. This switch can support up to maximal 26 port-based VLAN groups.

Metro Mode:

The Metro Mode is a quick configuration VLAN environment method on Port-based VLAN. It will create 22 or 23 Port-based VLAN groups.

Symmetric Vlan:

This is an Ingress Rule (Rule 1, The Ingress Filtering Rule 1 is “forward only packets with VID matching this port’s configured VID”). For example, if port 1 receives a tagged packet with VID=100 (VLAN name=VLAN100), and if Symmetric-Vlan function is enabled, the switch will check if port 1 is a member of VLAN100. If yes, the received packet is forwarded; otherwise, the received packet is dropped.

Note: If Symmetric is enabled and port 1, for example, receives an untagged packet, the switch will apply the PVID of port 1 to tag this packet, the packet then will be forwarded. But if the PVID of port 1 is not 100, the packet will be dropped.

SVL:

While SVL is enable, all VLANs use the same filtering database storing the membership information of the VLAN to learn or look up the membership information of the VLAN. While SVL is disable, it means learning mode is IVL. In this mode, different VLAN uses different filtering database storing the membership information of the VLAN to learn or look up the information of a VLAN member.

Double Tag:

Double-tag mode belongs to the tag-based mode, however, it would treat all frames as the untagged ones, which means that tag with PVID will be added into all packets. Then, these packets will be forwarded as Tag-based VLAN. So, the incoming packets with tag will become the double-tag ones. To notice that the up-link Port won’t add an extra VLAN tag.

Up-link Port:

This function is enabled only when metro mode or double-tag is chosen in VLAN mode.

25:

Except Port 25, each port of the switch cannot transmit packets with each other. Each port groups a VLAN with Port 25, thus, total 23 groups consisting of 2 members are formed.

26:

Except Port 26, each port of the switch cannot transmit packets with each other. Each port groups a VLAN with Port 26, thus, total 23 groups consisting of 2 members are formed.

25&26:

Except Port 25 and Port 26, each port of the switch cannot transmit packets with each other. Each port groups a VLAN with Port 25 and Port 26, thus, total 22 groups consisting of 3 members are formed.

VLAN Mode

VLAN Mode	Tag-based
Symmetric Vlan	Disable
SVL	Disable
Double Tag	Disable
Up-Link Port	26 Port

Apply

Fig. 3-20

3-7-2. Tag-based Group

Function name:

Tag-based Group Configuration

Function description:

It shows the information of existed Tag-based VLAN Groups. You can also easily create, edit and delete a Tag-based VLAN group by pressing **<Add>**, **<Edit>** and **<Delete>** function buttons. User can add a new VLAN group by inputting a new VLAN name and VLAN ID after pressing **<Add>** button.

Parameter description:

VLAN Name:

The name defined by administrator is associated with a VLAN group. Valid letters are A-Z, a-z, 0-9, “ - “ and “ _ ” characters. The maximal length is 15 characters.

VID:

VLAN identifier. Each tag-based VLAN group has a unique VID. It appears only in tag-based and Double-tag mode.

Member:

This is used to enable or disable if a port is a member of the new added VLAN, “Enable” means it is a member of the VLAN. Just tick the check box beside the port x to enable it.

Tag-based Group

No	VLAN NAME	VID
1	default	1

Fig. 3-21

Add Group:

Input the VLAN name, VID and then choose the member by ticking the check box beside the port No. to create a new Tag-based VLAN. As to the parameter of Untag, it stands for an egress rule of the port. If you tick the check box beside the port No., packets with this VID outgoing from this port will be untagged. Finally, press the **<Apply>** button to have the setting taken effect.

Tag-based VLAN

VLAN name	<input type="text"/>							
VID	<input type="text"/>							
Member	1. <input type="checkbox"/>	2. <input type="checkbox"/>	3. <input type="checkbox"/>	4. <input type="checkbox"/>	5. <input type="checkbox"/>	6. <input type="checkbox"/>	7. <input type="checkbox"/>	8. <input type="checkbox"/>
	9. <input type="checkbox"/>	10. <input type="checkbox"/>	11. <input type="checkbox"/>	12. <input type="checkbox"/>	13. <input type="checkbox"/>	14. <input type="checkbox"/>	15. <input type="checkbox"/>	16. <input type="checkbox"/>
	17. <input type="checkbox"/>	18. <input type="checkbox"/>	19. <input type="checkbox"/>	20. <input type="checkbox"/>	21. <input type="checkbox"/>	22. <input type="checkbox"/>	23. <input type="checkbox"/>	24. <input type="checkbox"/>
	25. <input type="checkbox"/>	26. <input type="checkbox"/>						
Untag	1. <input type="checkbox"/>	2. <input type="checkbox"/>	3. <input type="checkbox"/>	4. <input type="checkbox"/>	5. <input type="checkbox"/>	6. <input type="checkbox"/>	7. <input type="checkbox"/>	8. <input type="checkbox"/>
	9. <input type="checkbox"/>	10. <input type="checkbox"/>	11. <input type="checkbox"/>	12. <input type="checkbox"/>	13. <input type="checkbox"/>	14. <input type="checkbox"/>	15. <input type="checkbox"/>	16. <input type="checkbox"/>
	17. <input type="checkbox"/>	18. <input type="checkbox"/>	19. <input type="checkbox"/>	20. <input type="checkbox"/>	21. <input type="checkbox"/>	22. <input type="checkbox"/>	23. <input type="checkbox"/>	24. <input type="checkbox"/>
	25. <input type="checkbox"/>	26. <input type="checkbox"/>						

Fig. 3-22

Delete Group:

Just press the **<Delete>** button to remove the selected group entry from the Tag-based group table.

Edit a group:

Just select a group entry and press the **<Edit>** button, then you can modify a group's description, member and untag settings.

3-7-3. PVID

Function name:

PVID

Function description:

In PVID Setting, user can input VID number to each port. The range of VID number is from 1 to 4094. User also can choose ingress filtering rule (Rule 2) to each port. The Ingress Filtering Rule 2 is "drop untagged frame". While Rule 2 is enabled, the port will discard all Untagged-frames.

PVID

Port No	PVID	Default Priority	Drop Untag
1	1	0	Disable
2	1	0	Disable
3	1	0	Disable
4	1	0	Disable
5	1	0	Disable
6	1	0	Disable
7	1	0	Disable
8	1	0	Disable
9	1	0	Disable
10	1	0	Disable
11	1	0	Disable
12	1	0	Disable
13	1	0	Disable
14	1	0	Disable

Fig. 3-23

Parameter description:

Port 1-26:

Port number.

PVID:

This PVID range will be 1-4094. Before you set a number x as PVID, you have to create a Tag-based VLAN with VID x. For example, if port x receives an untagged packet, the switch will apply the PVID (assume as VID y) of port x to tag this packet, the packet then will be forwarded as the tagged packet with VID y.

Default Priority:

It bases on 802.1p QoS and affects untagged packets. When the packets enter the switch, it would get the priority precedence according to your Default Priority setting and map to 802.1p priority setting in QoS function. For example, while you set Default Priority of port 2 with 2 and transmit untagged packets to port 2, these packets will own priority 2 precedence due to your default 802.1p Priority Mapping setting in QoS function and be put into Queue 1.

Drop Untag:

Drop untagged frame. You can configure a given port to accept all frames (Tagged and Untagged) or just receive tagged frame. If the former is the case, then the packets with tagged or untagged will be processed. If the later is the case, only the packets carrying VLAN tag will be processed, the rest packets will be discarded.

3-7-4. Port-based Group

Function name:

Port-based Group Configuration

Function description:

It shows the information of the existed Port-based VLAN Groups. You can easily create, edit and delete a Port-based VLAN group by pressing **<Add>**, **<Edit>** and **<Delete>** function buttons. User can add a new VLAN group by inputting a new VLAN name.

Parameter description:

VLAN Name:

The name defined by administrator is associated with a VLAN group. Valid letters are A-Z, a-z, 0-9, “ - “ and “ _ ” characters. The maximal length is 15 characters.

Member:

This is used to enable or disable if a port is a member of the new added VLAN, “Enable” means it is a member of the VLAN. Just tick the check box beside the port x to enable it.

Port-based Group

No	VLAN NAME
1	default

Fig. 3-24

Add Group:

Create a new Port-based VLAN. Input the VLAN name and choose the member by ticking the check box beside the port No., then, press the **<Apply>** button to have the setting taken effect.

Port-based VLAN

VLAN name	<input type="text"/>							
Member	1. <input type="checkbox"/>	2. <input type="checkbox"/>	3. <input type="checkbox"/>	4. <input type="checkbox"/>	5. <input type="checkbox"/>	6. <input type="checkbox"/>	7. <input type="checkbox"/>	8. <input type="checkbox"/>
	9. <input type="checkbox"/>	10. <input type="checkbox"/>	11. <input type="checkbox"/>	12. <input type="checkbox"/>	13. <input type="checkbox"/>	14. <input type="checkbox"/>	15. <input type="checkbox"/>	16. <input type="checkbox"/>
	17. <input type="checkbox"/>	18. <input type="checkbox"/>	19. <input type="checkbox"/>	20. <input type="checkbox"/>	21. <input type="checkbox"/>	22. <input type="checkbox"/>	23. <input type="checkbox"/>	24. <input type="checkbox"/>
	25. <input type="checkbox"/>	26. <input type="checkbox"/>						

Apply

Fig. 3-25

Delete Group:

Just press the **<Delete>** button to remove the selected group entry from the Port-based group table.

Edit a group:

Just select a group entry and press the **<Edit>** button, then you can modify a group's description and member set.

3-7-5. Management VLAN

Function name:

Management VLAN

Function Description:

Management VLAN

State	Disable ▾
VID	1

Apply

Parameter description:

State:

It works when the tag-based mode is chosen. When this function is enabled, only the tagged packets with this VID can manage the switch.

VID:

Valid range 1~4094.

3-8. MAC Table

MAC Table Configuration gathers many functions, including MAC Table Information, MAC Table Maintenance, Static and MAC Alias, which cannot be categorized to some function type. They are described below.

Function name:

MAC Table Information

Function Description:

Display the static or dynamic learning MAC entry and the state for the selected port.

Parameter description:

Port:

Select the port you would like to inquire.

Search:

Set up the MAC entry you would like to inquire.

The default is ??-??-??-??-??-??

MAC:

Display the MAC address of one entry you selected from the searched MAC entries table.

Alias:

Set up the Alias for the selected MAC entry.

Set Alias:

Save the Alias of MAC entry you set up.

Search:

Find the entry that meets your setup.

Previous Page:

Move to the previous page.

Next Page:

Move to the next page.

Alias:

The Alias of the searched entry.

MAC Address:

The MAC address of the searched entry.

Port:

The port that exists in the searched MAC Entry.

VID:

VLAN Group that MAC Entry exists.

State:

Display the method that this MAC Entry is built. It may show "Dynamic MAC" or "Static MAC".

MAC Table Information

Port	<input checked="" type="checkbox"/> 01 <input checked="" type="checkbox"/> 02 <input checked="" type="checkbox"/> 03 <input checked="" type="checkbox"/> 04 <input checked="" type="checkbox"/> 05 <input checked="" type="checkbox"/> 06 <input checked="" type="checkbox"/> 07 <input checked="" type="checkbox"/> 08 <input checked="" type="checkbox"/> 09 <input checked="" type="checkbox"/> 10 <input checked="" type="checkbox"/> 11 <input checked="" type="checkbox"/> 12 <input checked="" type="checkbox"/> 13 <input checked="" type="checkbox"/> 14 <input checked="" type="checkbox"/> 15 <input checked="" type="checkbox"/> 16 <input checked="" type="checkbox"/> 17 <input checked="" type="checkbox"/> 18 <input checked="" type="checkbox"/> 19 <input checked="" type="checkbox"/> 20 <input checked="" type="checkbox"/> 21 <input checked="" type="checkbox"/> 22 <input checked="" type="checkbox"/> 23 <input checked="" type="checkbox"/> 24 <input checked="" type="checkbox"/> 25 <input checked="" type="checkbox"/> 26 <input checked="" type="checkbox"/> Select/Unselect All
Search	MAC: <input type="text"/> ?? - <input type="text"/> ?? - <input type="text"/> ?? - <input type="text"/> ?? - <input type="text"/> ?? - <input type="text"/> ?? VID: <input type="text"/> ?
MAC	<input type="text"/>
Alias	<input type="text"/> <input type="button" value="Set Alias"/>

Alias	MAC Address	Port	VID	State
	00-50-fc-8e-d2-01	Port 1	1	Dynamic

Fig. 3-26

Function Name:

MAC Table Maintenance

Function Description:

This function can allow the user to set up the processing mechanism of MAC Table. An idle MAC address exceeding MAC Address Age-out Time will be removed from the MAC Table. The range of Age-out Time is 10-1000000 seconds, and the setup of this time will have no effect on static MAC addresses.

In addition, the learning limit of MAC maintenance is able to limit the amount of MAC that each port can learn.

Parameter description:

Aging Time:

Delete a MAC address idling for a period of time from the MAC Table, which will not affect static MAC address. Range of MAC Address Aging Time is 10-1000000 seconds. The default Aging Time is 300 seconds.

Learning Limit:

To set up the maximum amount of MAC that each port can learn. Valid value of learning limit for port 1~24 ranges from 0-8191. As to port 25~port 26, only the fixed value "8192" is assigned to these two ports and user cannot configure this value.

MAC Maintenance

Aging time			
Enable	300	Secs (10~1000000)	Apply

Learning Limit (0~8191)			
Port No	Limit	Port No	Limit
1	8191	2	8191
3	8191	4	8191
5	8191	6	8191
7	8191	8	8191
9	8191	10	8191
11	8191	12	8191
13	8191	14	8191
15	8191	16	8191
17	8191	18	8191
19	8191	20	8191
21	8191	22	8191
23	8191	24	8191
25	8192	26	8192

Apply

Fig. 3-27

Function Name:

Static Setting

Function Description:

The function of Static is used to configure MAC's real manners inside of the switch. Three kinds of manners including static, static with destination drop and static with source drop are contained in this function .

As "static" is chosen, assign a MAC address to a specific port, all of the switch's traffics sent to this MAC address will be forwarded to this port.

As "static with destination drop" is chosen, the packet will be dropped if its DA is equal to the value you set up. Due to this setting belongs to the global one, so, it may affect all ports' transmission of the packets.

As "static with source drop" is chosen, the packet will be dropped if its SA is equal to the value you set up. Due to this setting belongs to the global one, so, it may affect all ports' transmission of the packets.

Static MAC

MAC						VID	Queue	Forwarding Rule	Port
<input type="text"/>	<input type="text"/>	<input type="text"/>	<input type="text"/>	<input type="text"/>	<input type="text"/>	<input type="text"/>	0	Static	<input type="text"/>

No	MAC	VID	Queue	Forwarding Rule	Port
----	-----	-----	-------	-----------------	------

Fig. 3-28

Parameter description:

MAC:

It is a six-byte long Ethernet hardware address and usually expressed by hex and separated by hyphens. For example,

00 - 40 - C7 - D6 - 00 - 01

VID:

VLAN identifier. This will be filled only when tagged VLAN is applied. Valid range is 1 ~ 4094.

Queue (Priority):

Set up the priority (0~3) for the MAC.

Forwarding Rule (Drop Policy):

Static:

A MAC address is assigned to a specific port, all of the switch's traffics sent to this MAC address will be forwarded to this port.

Static with Destination Drop:

While the DA of the incoming packets meets the value you set up, these packets will be dropped.

Static with Source Drop:

While the SA of the incoming packets meets the value you set up, these packets will be dropped.

Port :

Select the port No. you would like to do setup in the switch. It is 1 ~26.

Function name:

MAC Alias

Function description:

MAC Alias function is used to let you assign MAC address a plain English name. This will help you tell which MAC address belongs to which user in the illegal access report. At the initial time, it shows all pairs of the existed alias name and MAC address.

There are three MAC alias functions in this function folder, including MAC Alias Add, MAC Alias Edit and MAC Alias Delete. You can click **<Create/Edit>** button to add/modify a new or an existed alias name for a specified MAC address, or mark an existed entry to delete it. Alias name must be composed of A-Z, a-z and 0-9 only and has a maximal length of 15 characters.

Function name:

MAC Alias Create/Edit or Delete

Function description:

In the MAC Alias function, MAC Alias Add/Edit function is used to let you add or modify an association between MAC address and a plain English name. User can click **<Create/Edit>** button to add a new record with name.

As to MAC Alias Delete function is used to let you remove an alias name to a MAC address. You can select an existed MAC address or alias name to remove.

MAC Alias

MAC Address						Alias	
<input type="text"/>	-	<input type="text"/>	-	<input type="text"/>	-	<input type="text"/>	<input type="text"/>

No	MAC Address	Alias
----	-------------	-------

Fig. 3-29

Parameter description:

MAC Address:

It is a six-byte long Ethernet hardware address and usually expressed by hex and separated by hyphens. For example,

00 – 40 - C7 - D6 – 00 - 02

Alias:

MAC alias name you assign.

Note: If there are too many MAC addresses learned in the table, we recommend you inputting the MAC address and alias name directly.

3-9. GVRP Configuration

GVRP is an application based on Generic Attribute Registration Protocol (GARP), mainly used to automatically and dynamically maintain the group membership information of the VLANs. The GVRP offers the function providing the VLAN registration service through a GARP application. It makes use of GARP Information Declaration (GID) to maintain the ports associated with their attribute database and GARP Information Propagation (GIP) to communicate among switches and end stations. With GID information and GIP, GVRP state machine maintain the contents of Dynamic VLAN Registration Entries for each VLAN and propagate these information to other GVRP-aware devices to setup and update their knowledge database, the set of VLANs associated with currently active members, and through which ports these members can be reached.

In GVRP Configuration function folder, there are three functions supported, including GVRP Config, GVRP Counter and GVRP Group explained below.

GVRP Configuration

GVRP State Disabled Apply

Port	Join Time	Leave Time	LeaveAll Time	Default Applicant Mode	Default Registrar Mode	Restricted Mode
1	20	60	1000	Normal	Normal	Disabled
2	20	60	1000	Normal	Normal	Disabled
3	20	60	1000	Normal	Normal	Disabled
4	20	60	1000	Normal	Normal	Disabled
5	20	60	1000	Normal	Normal	Disabled
6	20	60	1000	Normal	Normal	Disabled
7	20	60	1000	Normal	Normal	Disabled
8	20	60	1000	Normal	Normal	Disabled
9	20	60	1000	Normal	Normal	Disabled
10	20	60	1000	Normal	Normal	Disabled
11	20	60	1000	Normal	Normal	Disabled
12	20	60	1000	Normal	Normal	Disabled
13	20	60	1000	Normal	Normal	Disabled
14	20	60	1000	Normal	Normal	Disabled
15	20	60	1000	Normal	Normal	Disabled
16	20	60	1000	Normal	Normal	Disabled
17	20	60	1000	Normal	Normal	Disabled
18	20	60	1000	Normal	Normal	Disabled

Fig. 3-30

Function name:

GVRP Config

Function description:

In the function of GVRP Config, it is used to configure each port's GVRP operation mode, in which there are seven parameters needed to be configured described below.

Parameter description:

GVRP State Setting:

This function is simply to let you enable or disable GVRP function. You can pull down the list and click the **<Downward>** arrow key to choose "Enable" or "Disable". Then, click the **<Apply>** button, the system will take effect immediately.

Join Time:

Used to declare the Join Time in unit of centisecond. Valid time range: 20 –100 centiseconds, Default: 20 centisecond.

Leave Time:

Used to declare the Leave Time in unit of centisecond. Valid time range: 60 –300 centisecond, Default: 60 centisecond.

Leave All Time:

A time period for announcement that all registered device is going to be de-registered. If someone still issues a new join, then a registration will be kept in the switch. Valid range: 1000-5000 unit time, Default: 1000 unit time.

Default Applicant Mode:

The mode here means the type of participant. There are two modes, normal participant and non-participant, provided for the user's choice.

Normal:

It is Normal Participant. In this mode, the switch participates normally in GARP protocol exchanges. The default setting is Normal.

Non-Participant:

It is Non-Participant. In this mode, the switch does not send or reply any GARP messages. It just listens messages and reacts for the received GVRP BPDU.

Default Registrar Mode:

The mode here means the type of Registrar. There are three types of parameters for registrar administrative control value, normal registrar, fixed registrar and forbidden registrar, provided for the user's choice.

Normal:

It is Normal Registration. The Registrar responds normally to incoming GARP messages. The default setting is Normal.

Fixed:

It is Registration Fixed. The Registrar ignores all GARP messages, and all members remain in the registered (IN) state.

Forbidden:

It is Registration Forbidden. The Registrar ignores all GARP messages, and all members remain in the unregistered (EMPTY) state.

Restricted Mode:

This function is used to restrict dynamic VLAN be created when this port received GVRP PDU. There are two modes, disable and enable, provided for the user's choice.

Disabled:

In this mode, the switch dynamic VLAN will be created when this port received GVRP PDU. The default setting is Normal.

Enabled:

In this mode, the switch does not create dynamic VLAN when this port received GVRP PDU. Except received dynamic VLAN message of the GVRP PDU is an existed static VLAN in the switch, this port will be added into the static VLAN members dynamically.

Function name:

GVRP Counter

Function description:

All GVRP counters are mainly divided into Received and Transmitted two categories to let you monitor the GVRP actions. Actually, they are GARP packets.

GVRP Counter Port 1 ▾

Counter Name	Received	Transmitted
Total GVRP Packets	0	0
Invalid GVRP Packets	0	----
LeaveAll message	0	0
JoinEmpty message	0	0
JoinIn message	0	0
LeaveEmpty message	0	0
Empty message	0	0

Refresh

Fig. 3-31

Parameter description:

Received:

Total GVRP Packets:

Total GVRP BPDU is received by the GVRP application.

Invalid GVRP Packets:

Number of invalid GARP BPDU is received by the GARP application.

LeaveAll Message Packets:

Number of GARP BPDU with Leave All message is received by the GARP application.

JoinEmpty Message Packets:

Number of GARP BPDU with Join Empty message is received by the GARP application.

JoinIn Message Packets:

Number of GARP BPDU with Join In message is received by the GARP application.

LeaveEmpty Message Packets:

Number of GARP BPDU with Leave Empty message is received by the GARP application.

Empty Message Packets:

Number of GARP BPDU with Empty message is received by the GARP application.

Transmitted:

Total GVRP Packets:

Total GARP BPDU is transmitted by the GVRP application.

Invalid GVRP Packets:

Number of invalid GARP BPDU is transmitted by the GVRP application.

LeaveAll Message Packets:

Number of GARP BPDU with Leave All message is transmitted by the GARP application.

JoinEmpty Message Packets:

Number of GARP BPDU with Join Empty message is transmitted by the GARP application.

JoinIn Message Packets:

Number of GARP BPDU with Join In message is transmitted by the GARP application.

LeaveEmpty Message Packets:

Number of GARP BPDU with Leave Empty message is transmitted by the GARP application.

Empty Message Packets:

Number of GARP BPDU with Empty message is transmitted by the GARP application.

Function name:

GVRP Group Information

Function description:

To show the dynamic group member and their information.

Parameter description:

Current Dynamic Group Number:

The number of GVRP group that are created currently.

VID:

VLAN identifier. When GVRP group creates, each dynamic VLAN group owns its VID. Valid range is 1 ~ 4094.

Member Port:

Those are the members belonging to the same dynamic VLAN group.

Edit Administrative Control:

When you create GVRP group, you can use Administrative Control function to change Applicant Mode and Registrar Mode of GVRP group member.

Refresh:

Refresh function can help you to see current GVRP group status.

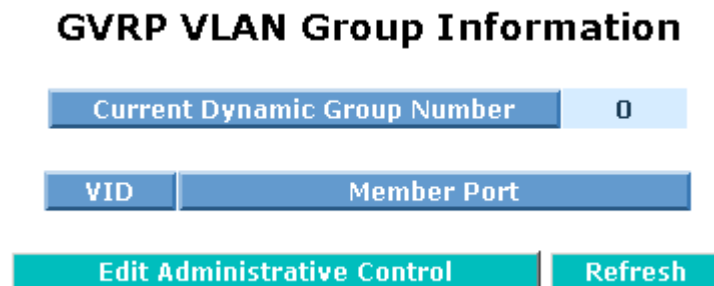

Fig. 3-32

3-10. STP Configuration

The Spanning Tree Protocol (STP) is a standardized method (IEEE 802.1D) for avoiding loops in switched networks. When STP is enabled, ensure that only one path is active between any two nodes on the network at a time. User can enable Spanning Tree Protocol on switch's web management and then set up other advanced items. We recommend that you enable STP on all switches to ensure a single active path on the network.

3-10-1. STP Status

Function name:

STP Status

Function description:

In the Spanning Tree Status, user can read 12 parameters to know STP current status. The 12 parameters' description is listed in the following table.

Parameter description:

STP State:

Show the current STP Enabled / Disabled status. Default is "Disabled".

Bridge ID:

Show switch's bridge ID which stands for the MAC address of this switch.

Bridge Priority:

Show this switch's current bridge priority setting. Default is 32768.

Designated Root:

Show root bridge ID of this network segment. If this switch is a root bridge, the "Designated Root" will show this switch's bridge ID.

Designated Priority:

Show the current root bridge priority.

Root Port:

Show port number connected to root bridge with the lowest path cost.

Root Path Cost:

Show the path cost between the root port and the designated port of the root bridge.

Current Max. Age:

Show the current root bridge maximum age time. Maximum age time is used to monitor if STP topology needs to change. When a bridge does not receive a hello message from root bridge until the maximum age time is counted down to 0, the bridge will treat the root bridge malfunctioned and issue a Topology Change Notification (TCN) BPDU to all other bridges.

All bridges in the LAN will re-learn and determine which the root bridge is. Maximum Age time is assigned by Root Bridge in unit of seconds. Default is 20 seconds.

Current Forward Delay:

Show the current root bridge forward delay time. The value of Forward Delay time is set by root. The Forward Delay time is defined as the time spent from Listening state moved to Learning state or from Learning state moved to Forwarding state of a port in bridge.

Hello Time:

Show the current hello time of the root bridge. Hello time is a time interval specified by Root Bridge, used to request all other bridges periodically sending hello message every "hello time" seconds to the bridge attached to its designated port.

STP Topology Change Count:

STP Topology Change Count expresses the time spent in unit of seconds since the beginning of the Spanning Tree Topology Change to the end of the STP convergence. Once the STP change is converged, the Topology Change count will be reset to 0. The figures showing in the screen may not be the exact time it spent but very close to, because the time is eclipsing.

Time Since Last Topology Change:

Time Since Last Topology Change is the accumulated time in unit of seconds the STP has been since the last STP Topology Change was made. When Topology Change is initiated again, this counter will be reset to 0. And it will also count again once STP topology Change is completed.

STP Status

STP State	Disabled
Bridge ID	00:40:C7:EA:00:35
Bridge Priority	32768
Designated Root	00:40:C7:EA:00:35
Designated Priority	32768
Root Port	0
Root Path Cost	0
Current Max. Age(sec)	20
Current Forward Delay(sec)	15
Hello Time(sec)	2
STP Topology Change Count	0
Time Since Last Topology Change(sec)	0

Fig. 3-33

3-10-2. STP Configuration

The STP, Spanning Tree Protocol, actually includes RSTP. In the Spanning Tree Configuration, there are six parameters open for the user to configure as user's idea. Each parameter description is listed below.

Function name:

STP Configuration

Function description:

User can set the following Spanning Tree parameters to control STP function enable/disable, select mode RSTP/STP and affect STP state machine behavior to send BPDU in this switch. The default setting of Spanning Tree Protocol is "Disable".

Parameter description:

Spanning Tree Protocol:

Set 802.1W Rapid STP function Enable / Disable. Default is "Disable"

Bridge Priority:

The lower the bridge priority is the higher priority it has. Usually, the bridge with the highest bridge priority is the root. If you want to have the 24 FAST ETHERNET + 2 GIGABIT L2 MANAGED SWITCH as root bridge, you can set this value lower than that of bridge in the LAN. The valid value is 0 ~ 61440. The default is 32768.

Hello Time:

Hello Time is used to determine the periodic time to send normal BPDU from designated ports among bridges. It decides how long a bridge should send this message to other bridge to tell I am alive. When the 24 FAST ETHERNET + 2 GIGABIT L2 MANAGED SWITCH is the root bridge of the LAN, for example, all other bridges will use the hello time assigned by this switch to communicate with each other. The valid value is 1 ~ 10 in unit of second.

Default is 2 seconds.

Max. Age:

When the 24 FAST ETHERNET + 2 GIGABIT L2 MANAGED SWITCH is the root bridge, the whole LAN will apply this figure set by this switch as their maximum age time. When a bridge received a BPDU originated from the root bridge and if the message age conveyed in the BPDU exceeds the Max. Age of the root bridge, the bridge will treat the root bridge malfunctioned and issue a Topology Change Notification (TCN) BPDU to all other bridges. All bridges in the LAN will re-calculate and determine who the root bridge is. The valid value of Max. Age is 6 ~ 40 seconds. Default is 20 seconds.

Forward Delay:

You can set the root bridge forward delay time. This figure is set by Root Bridge only. The forward delay time is defined as the time spent from Listening state moved to Learning state and also from Learning state moved to Forwarding state of a port in bridge. The forward delay time contains two states, Listening state to Learning state and Learning state to Forwarding state. It assumes that forward delay time is 15 seconds, and then total forward delay time will be 30 seconds. This has much to do with the STP convergent time which will be more than 30 seconds because some other factors.

The valid value is 4 ~ 30 seconds, default is 15 seconds.

Force Version:

Two options are offered for the user's choosing STP algorithm. One is RSTP and the other is STP. If STP is chosen, RSTP will run as a legacy STP. The switch supports RSTP (802.1w) which is backward compatible with STP (802.1d).

STP Configuration

Spanning Tree Protocol	Disable ▾
Bridge Priority (0-61440)	32768 ▾
Hello Time (1-10 sec)	2
Max. Age (6-40 sec)	20
Forward Delay (4-30 sec)	15
Force Version	RSTP ▾

**Note: $2 * (\text{Forward Delay} - 1) \geq \text{Max Age}$
 $\text{Max Age} \geq 2 * (\text{Hello Time} + 1)$**

Apply

Fig. 3-34

3-10-3. STP Port Configuration

Function name:

STP Port Setting

Function description:

In the STP Port Setting, one item selection and five parameters settings are offered for user's setup. User can disable and enable each port by selecting each Port Status item. User also can set "Path Cost" and "Priority" of each port by filling in the desired value and set "Admin Edge Port" and "Admin Point To Point" by selecting the desired item.

Parameter description:

Port Status:

It displays the current state of a port. We cannot manually set it because it displays the status only. There are three possible states. (According to 802.1w specification)

- DISCARDING state indicates that this port can neither forward packets nor contribute learning knowledge.

Notice: Three other states (Disable state, BLOCKING state and LISTENING state) defined in the 802.1d specification are now all represented as DISCARDING state.

- LEARNING state indicates this port can now contribute its learning knowledge but cannot forward packets still.
- FORWARDING state indicates this port can both contribute its learning knowledge and forward packets normally.

Path Cost Status:

It is the contribution value of the path through this port to Root Bridge. STP algorithm determines a best path to Root Bridge by calculating the sum of path cost contributed by all ports on this path. A port with a smaller path cost value would become the Root Port more possibly.

Configured Path Cost:

The range is 0 – 200,000,000. In the switch, if path cost is set to be zero, the STP will get the recommended value resulted from auto-negotiation of the link accordingly and display this value in the field of Path Cost Status. Otherwise, it may show the value that the administrator set up in Configured Path Cost and Path Cost Status.

802.1w RSTP recommended value: (Valid range: 1 – 200,000,000)

10 Mbps : 2,000,000

100 Mbps : 200,000

1 Gbps : 20,000

Default: 0

Priority:

Priority here means Port Priority. Port Priority and Port Number are mixed to form the Port ID. Port IDs are often compared in order to determine which port of a bridge would become the Root Port. The range is 0 – 240.

Default is 128.

Admin Edge Port:

If user selects “Yes”, this port will be an edge port. An Edge Port is a port connected to a device that knows nothing about STP or RSTP. Usually, the connected device is an end station. Edge Ports will immediately transit to forwarding state and skip the listening and learning state because the edge ports cannot create bridging loops in the network. This will expedite the convergence. When the link on the edge port toggles, the STP topology keeps unchanged. Unlike the designate port or root port though, an edge port will transit to a normal spanning-tree port immediately if it receives a BPDU.

Default: No

Admin Point To Point:

We say a port is a point-to-point link, from RSTP's view, if it is in full-duplex mode but is shared link if it is in half-duplex mode. RSTP fast convergence can only happen on point-to-point links and on edge ports. This can expedite the convergence because this will have the port fast transition to forwarding state.

There are three parameters, Auto, True and False, used to configure the type of the point-to-point link. If configure this parameter to be Auto, it means RSTP will use the duplex mode resulted from the auto-negotiation. In today's switched networks, most links are running in full-duplex mode. For sure, the result may be half-duplex, in this case, the port will not fast transition to Forwarding state. If it is set as True, the port is treated as point-to-point link by RSTP and unconditionally transitioned to Forwarding state. If it is set as False, fast transition to Forwarding state will not happen on this port.

Default: Auto

M Check:

Migration Check. It forces the port sending out an RSTP BPDU instead of a legacy STP BPDU at the next transmission. The only benefit of this operation is to make the port quickly get back to act as an RSTP port. Click **<M Check>** button to send a RSTP BPDU from the port you specified.

STP Port Configuration

Port No	Port Status	Path Cost Status	Configured Path Cost	Priority	Admin Edge Port	Admin Point To Point
1	FORWARDING	200000	0	128	No	Auto
2	DISCARDING	200000	0	128	No	Auto
3	DISCARDING	200000	0	128	No	Auto
4	DISCARDING	200000	0	128	No	Auto
5	DISCARDING	200000	0	128	No	Auto
6	DISCARDING	200000	0	128	No	Auto
7	DISCARDING	200000	0	128	No	Auto
8	DISCARDING	200000	0	128	No	Auto
9	DISCARDING	200000	0	128	No	Auto
10	DISCARDING	200000	0	128	No	Auto
11	DISCARDING	200000	0	128	No	Auto
12	DISCARDING	200000	0	128	No	Auto
13	DISCARDING	200000	0	128	No	Auto
14	DISCARDING	200000	0	128	No	Auto
15	DISCARDING	200000	0	128	No	Auto
16	DISCARDING	200000	0	128	No	Auto
17	DISCARDING	200000	0	128	No	Auto
18	DISCARDING	200000	0	128	No	Auto
19	DISCARDING	200000	0	128	No	Auto
20	DISCARDING	200000	0	128	No	Auto
21	DISCARDING	200000	0	128	No	Auto
22	DISCARDING	200000	0	128	No	Auto
23	DISCARDING	200000	0	128	No	Auto
24	DISCARDING	200000	0	128	No	Auto
25	DISCARDING	20000	0	128	No	Auto
26	DISCARDING	20000	0	128	No	Auto

Edit

MCheck

Fig. 3-35

3-11. Trunking Configuration

The Port Trunking Configuration is used to configure the settings of Link Aggregation. You can bundle more than one port with the same speed, full duplex and the same MAC to be a single logical port, thus the logical port aggregates the bandwidth of these ports. This means you can apply your current Ethernet equipments to build the bandwidth aggregation. For example, if there are three Fast Ethernet ports aggregated in a logical port, then this logical port has bandwidth three times as high as a single Fast Ethernet port has.

The switch supports two kinds of port trunking methods:

LACP:

Ports using Link Aggregation Control Protocol (according to IEEE 802.3ad specification) as their trunking method can choose their unique LACP GroupID (1~3) to form a logic "trunked port". The benefit of using LACP is that a port makes an agreement with its peer port before it becomes a ready member of a "trunk group" (also called aggregator). LACP is safer than the other trunking method - static trunk.

The switch LACP does not support the followings:

- Link Aggregation across switches
- Aggregation with non-IEEE 802.3 MAC link
- Operating in half-duplex mode
- Aggregate the ports with different data rates

Static Trunk:

Ports using Static Trunk as their trunk method can choose their unique Static GroupID (also 1~3, this Static groupID can be the same with another LACP groupID) to form a logic "trunked port". The benefit of using Static Trunk method is that a port can immediately become a member of a trunk group without any handshaking with its peer port. This is also a disadvantage because the peer ports of your static trunk group may not know that they should be aggregate together to form a "logic trunked port". Using Static Trunk on both end of a link is strongly recommended. Please also note that low speed links will stay in "not ready" state when using static trunk to aggregate with high speed links.

As to system restrictions about the port aggregation function on the switch, In the management point of view, the switch supports maximum 3 trunk groups for LACP and additional 3 trunk groups for Static Trunk. But in the system capability view, only 3 "real trunked" groups are supported. An LACP trunk group with more than one ready member-port is a "real trunked" group. An LACP trunk group with only one or less than one ready member-port is not a "real trunked" group. Any Static trunk group is a "real trunked" group.

Per Trunking Group supports a maximum of 4 ready member-ports. Please note that some decisions will automatically be made by the system while you are configuring your trunking ports. Trunk Setting Rules are listed below:

Rule1: Maximum 3 groups are allowed

Rule 2: The members of each group cannot exceed more than 4 ports

Rule 3: Group 1 and 2 cannot exist member 25 and 26 port

Rule 4: Group 3 cannot exist member from 1 to 24 port

Function name:

Port Setting/Status

Function description:

Port setting/status is used to configure the trunk property of each and every port in the switch system.

Parameter description:

Method:

This determines the method a port uses to aggregate with other ports.

None:

A port does not want to aggregate with any other port should choose this default setting.

LACP:

A port use LACP as its trunk method to get aggregated with other ports also using LACP.

Static:

A port use Static Trunk as its trunk method to get aggregated with other ports also using Static Trunk.

Group:

Ports choosing the same trunking method other than "None" must be assigned a unique Group number (i.e. Group ID, valid value is from 1 to 8) in order to declare that they wish to aggregate with each other.

Active LACP:

This field is only referenced when a port's trunking method is LACP.

Active:

An Active LACP port begins to send LACPDU to its link partner right after the LACP protocol entity started to take control of this port.

Passive:

A Passive LACP port will not actively send LACPDU out before it receives an LACPDU from its link partner.

Aggtr:

Aggtr is an abbreviation of “aggregator”. Every port is also an aggregator, and its own aggregator ID is the same as its own Port No. We can regard an aggregator as a representative of a trunking group. Ports with same Group ID and using same trunking method will have the opportunity to aggregate to a particular aggregator port. This aggregator port is usually the port with the smallest Port No. within the trunking group.

Status:

This field represents the trunking status of a port which uses a trunking method other than “None”. It also represents the management link status of a port which uses the “None” trunking method. “---“ means “not ready”

Trunk Port Setting/Status [Setting Rule](#)

Port	Trunk Port Setting			Trunk Port Status	
	Method	Group	Active LACP	Aggtr	Status
1	None	0	Active	1	Ready
2	None	0	Active	2	---
3	None	0	Active	3	---
4	None	0	Active	4	---
5	None	0	Active	5	---
6	None	0	Active	6	---
7	None	0	Active	7	---
8	None	0	Active	8	---
9	None	0	Active	9	---
10	None	0	Active	10	---

Fig.3-36

Function name:

Aggregator View

Function description:

To display the current port trunking information from the aggregator point of view.

Parameter description:

Aggregator:

It shows the aggregator ID (from 1 to 26) of every port. In fact, every port is also an aggregator, and its own aggregator ID is the same as its own Port No..

Method:

Show the method a port uses to aggregate with other ports.

Member Ports:

Show all member ports of an aggregator (port).

Ready Ports:

Show only the ready member ports within an aggregator (port).

Aggregator View

Aggregator	Method	Member Ports	Ready Ports
1	None	1	1
2	None	2	
3	None	3	
4	None	4	
5	None	5	
6	None	6	
7	None	7	
8	None	8	
9	None	9	
10	None	10	
11	None	11	
12	None	12	
13	None	13	

Fig.3-37

Function name:

LACP Detail (LACP Aggregator Detailed Information)

Function description:

Show the detailed information of the LACP trunking group.

Parameter description:

Actor:

The switch you are watching on.

Partner:

The peer system from this aggregator's view.

System Priority:

Show the System Priority part of a system ID.

MAC Address:

Show the MAC Address part of a system ID.

Port:

Show the port number part of an LACP port ID.

Key:

Show the key value of the aggregator. The key value is determined by the LACP protocol entity and can't be set through management.

Trunk Status:

Show the trunk status of a single member port."---" means "not ready"

Aggregator 2 Information

Actor			Partner	
System Priority	MAC Address		System Priority	MAC Address
32768	00-40-c7-ea-00-35		32768	00-00-00-00-00-00
Port	Key	Trunk Status	Port	Key
2	258	---	2	0

Fig. 3-38

Function name:

LACP System Configuration

Function description:

It is used to set the priority part of the LACP system ID. LACP will only aggregate together the ports whose peer link partners are all on a single system. Each system supports LACP will be assigned a globally unique System Identifier for this purpose. A system ID is a 64-bit field comprising a 48-bit MAC Address and 16-bit priority value.

Parameter description:

System Priority:

The System Priority can be set by the user. Its range is from 1 to 65535.
Default: 32768.

LACP Hash Method:

DA+SA, DA and SA are three Hash methods offered for the Link Aggregation of the switch. Packets will decide the path to transmit according to the mode of Hash you choose.

Default: DA and SA

LACP System Configuration

System Priority	<input type="text" value="32768"/> (1~65535)
Hash Method	<input type="text" value="DA and SA"/> ▼
Note: This hash method applies to both LACP and static trunk.	
<input type="button" value="Apply"/>	

Fig.3-39

3-12. 802.1x Configuration

802.1x port-based network access control provides a method to restrict users to access network resources via authenticating user's information. This restricts users from gaining access to the network resources through a 802.1x-enabled port without authentication. If a user wishes to touch the network through a port under 802.1x control, he (she) must firstly input his (her) account name for authentication and waits for gaining authorization before sending or receiving any packets from a 802.1x-enabled port.

Before the devices or end stations can access the network resources through the ports under 802.1x control, the devices or end stations connected to a controlled port send the authentication request to the authenticator, the authenticator pass the request to the authentication server to authenticate and verify, and the server tell the authenticator if the request get the grant of authorization for the ports.

According to IEEE802.1x, there are three components implemented. They are Authenticator, Supplicant and Authentication server.

Supplicant:

It is an entity being authenticated by an authenticator. It is used to communicate with the Authenticator PAE (Port Access Entity) by exchanging the authentication message when the Authenticator PAE request to it.

Authenticator:

An entity facilitates the authentication of the supplicant entity. It controls the state of the port, authorized or unauthorized, according to the result of authentication message exchanged between it and a supplicant PAE. The authenticator may request the supplicant to re-authenticate itself at a configured time period. Once start re-authenticating the supplicant, the controlled port keeps in the authorized state until re-authentication fails.

A port acting as an authenticator is thought to be two logical ports, a controlled port and an uncontrolled port. A controlled port can only pass the packets when the authenticator PAE is authorized, and otherwise, an uncontrolled port will unconditionally pass the packets with PAE group MAC address, which has the value of 01-80-c2-00-00-03 and will not be forwarded by MAC bridge, at any time.

Authentication server:

A device provides authentication service, through EAP, to an authenticator by using authentication credentials supplied by the supplicant to determine if the supplicant is authorized to access the network resource.

The overview of operation flow is quite simple. When Supplicant PAE issues a request to Authenticator PAE, Authenticator and Supplicant exchanges authentication message. Then, Authenticator passes the request to RADIUS server to verify. Finally, RADIUS server replies if the request is granted or denied.

While in the authentication process, the message packets, encapsulated by Extensible Authentication Protocol over LAN (EAPOL), are exchanged between an authenticator PAE and a supplicant PAE. The Authenticator exchanges the message to authentication server using EAP encapsulation. Before successfully authenticating, the supplicant can only touch the authenticator to perform authentication message exchange or access the network from the uncontrolled port.

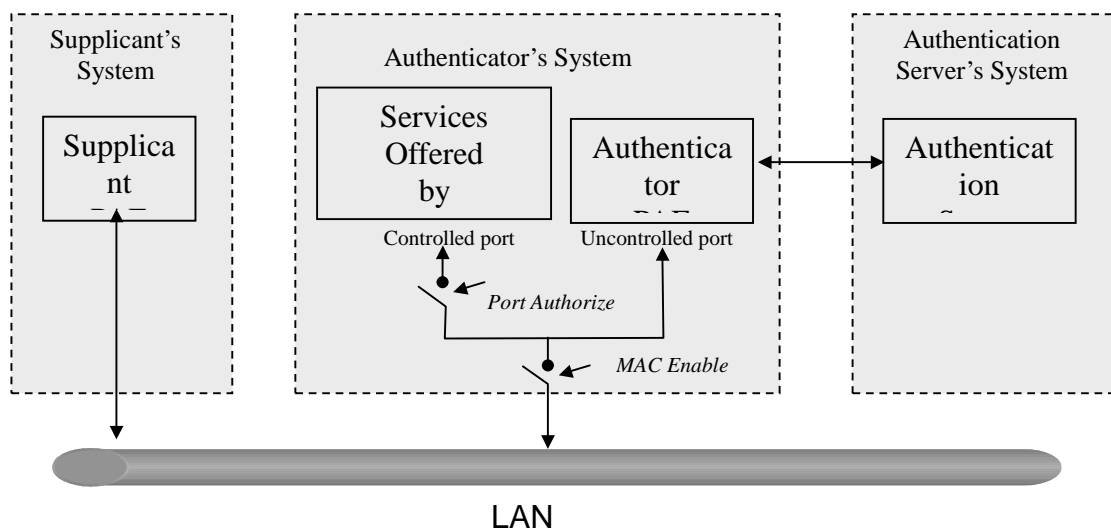
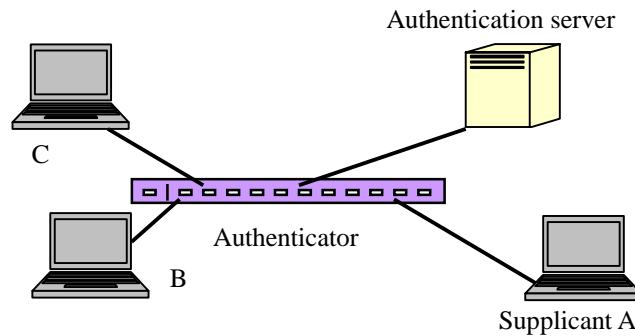

Fig. 3-40

This is the typical configuration, a single supplicant, an authenticator and an authentication server. B and C is in the internal network, D is Authentication server running RADIUS, switch at the central location acts Authenticator connecting to PC A and A is a PC outside the controlled port, running Supplicant PAE. In this case, PC A wants to access the services on device B and C, first, it must exchange the authentication message with the authenticator on the port it connected via EAPOL packet. The authenticator transfers the supplicant's credentials to Authentication server for verification. If success, the authentication server will notice the authenticator the grant. PC A, then, is allowed to access B and C via the switch. If there are two switches directly connected together instead of single one, for the link connecting two switches, it may have to act two port roles at the end of the link: authenticator and supplicant, because the traffic is bi-directional.

Fig. 3-41



The Figure shows the procedure of 802.1x authentication. There are steps for the login based on 802.1x port access control management. The protocol used in the right side is EAPOL and the left side is EAP.

1. At the initial stage, the supplicant A is unauthenticated and a port on switch acting as an authenticator is in unauthorized state. So the access is blocked in this stage.
2. Initiating a session. Either authenticator or supplicant can initiate the message exchange. If supplicant initiates the process, it sends EAPOL-start packet to the authenticator PAE and authenticator will immediately respond EAP-Request/Identity packet.
3. The authenticator always periodically sends EAP-Request/Identity to the supplicant for requesting the identity it wants to be authenticated.
4. If the authenticator doesn't send EAP-Request/Identity, the supplicant will initiate EAPOL-Start the process by sending to the authenticator.
5. And next, the Supplicant replies an EAP-Response/Identity to the authenticator. The authenticator will embed the user ID into Radius-Access-Request command and send it to the authentication server for confirming its identity.
6. After receiving the Radius-Access-Request, the authentication server sends Radius-Access-Challenge to the supplicant for asking for inputting user password via the authenticator PAE.
7. The supplicant will convert user password into the credential information, perhaps, in MD5 format and replies an EAP-Response with this credential information as well as the specified authentication algorithm (MD5 or OTP) to Authentication server via the authenticator PAE. As per the value of the type field in message PDU, the authentication server knows which algorithm should be applied to authenticate the credential information, EAP-MD5 (Message Digest 5) or EAP-OTP (One Time Password) or other else algorithm.

8. If user ID and password is correct, the authentication server will send a Radius-Access-Accept to the authenticator. If not correct, the authentication server will send a Radius-Access-Reject.
9. When the authenticator PAE receives a Radius-Access-Accept, it will send an EAP-Success to the supplicant. At this time, the supplicant is authorized and the port connected to the supplicant and under 802.1x control is in the authorized state. The supplicant and other devices connected to this port can access the network. If the authenticator receives a Radius-Access-Reject, it will send an EAP-Failure to the supplicant. This means the supplicant is failed to authenticate. The port it connected is in the unauthorized state, the supplicant and the devices connected to this port won't be allowed to access the network.
10. When the supplicant issue an EAP-Logoff message to Authentication server, the port you are using is set to be unauthorized.

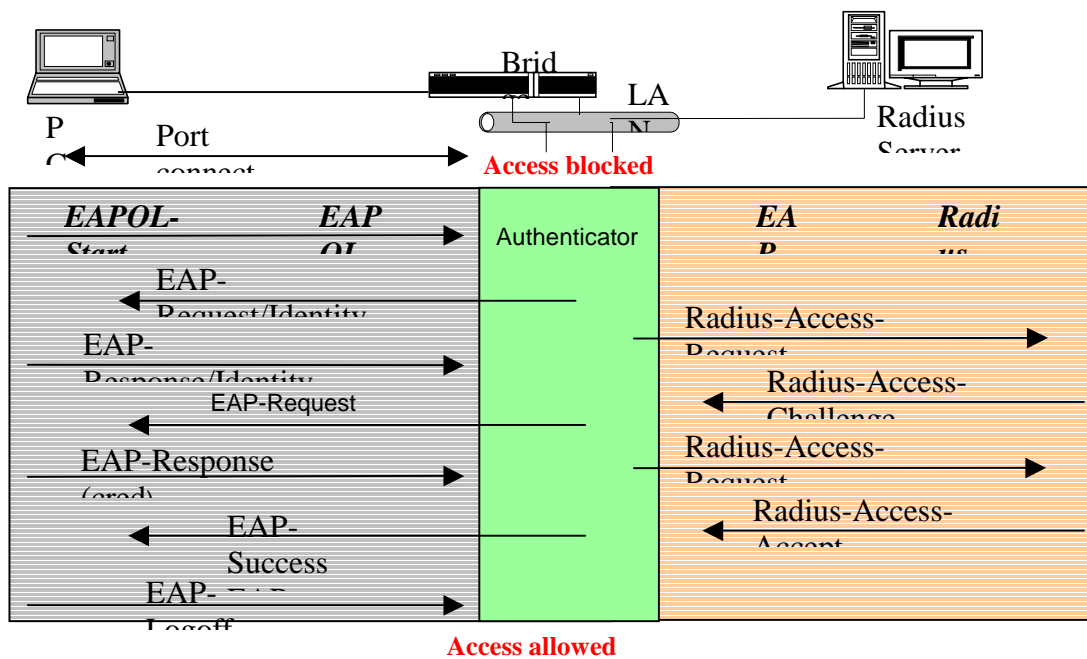

Fig. 3-42

Only MultiHost 802.1X is the type of authentication supported in the switch. In this mode, for the devices connected to this port, once a supplicant is authorized, the devices connected to this port can access the network resource through this port.

802.1x Port-based Network Access Control function supported by the switch is little bit complex, for it just support basic Multihost mode, which can distinguish the device's MAC address and it's VID. The following table is the summary of the combination of the authentication status and the port status versus the status of port mode, set in 802.1x Port mode, port control state, set in 802.1x port setting. Here Entry Authorized means MAC entry is authorized.

Port Mode	Port Control	Authentication	Port Status
Disable	Don't Care	Don't Care	Port Uncontrolled
Multihost	Auto	Successful	Port Authorized
Multihost	Auto	Failure	Port Unauthorized
Multihost	ForceUnauthorized	Don't Care	Port Unauthorized
Multihost	ForceAuthorized	Don't Care	Port Authorized

Table 3-3

802.1X State Setting

Radius Server	192.168.1.1
Port Number(1~65535)	1812
Secret Key	Radius
Accounting Service	Disable ▾
Accounting Server	192.168.1.1
Accounting Port(1~65535)	1813

Apply

Fig. 3-43

Function name:

802.1x State Setting

Function description:

This function is used to configure the global parameters for RADIUS authentication in 802.1x port security application.

Parameter description:

Radius Server:

RADIUS server IP address for authentication.

Default: 192.168.1.1

Port Number:

The port number to communicate with RADIUS server for the authentication service. The valid value ranges 1-65535.

Default port number is 1812.

Secret Key:

The secret key between authentication server and authenticator. It is a string with the length 1 – 31 characters. The character string may contain upper case, lower case and 0-9. It is character sense. It is not allowed for putting a blank between any two characters.

Default: Radius

Accounting Service:

To enabled/disable the accounting service.

Accounting Server:

Accounting server IP address for accounting service.

Default: 192.168.1.1

Accounting Port :

The port number to communicate with Accounting server for the accounting service. The valid value ranges 1-65535.

Default port number is 1813.

Function name:

802.1x Mode Setting

Function description:

Set the operation mode of 802.1X for each port. In this device, it supports only Multi-host operation mode.

Parameter description:

Port Number:

Indicate which port is selected to configure the 802.1x operation mode.

802.1x Mode:

802.1x operation mode. There are two options, including Disable and Multi-host mode. Default is Disable.

- ▪ Disable

It will have the chosen port acting as a plain port that is no 802.1 x port access control works on the port.

- ▪ 802.1x with Multi-host

In Multi-host mode, for the devices connected to this port, once a supplicant is authorized, the devices connected to this port can access the network resource through this port.

802.1X Mode Setting

Port	802.1X Mode
1	Disable
2	Disable
3	Disable
4	Disable
5	Normal Advanced 802.1X
6	Disable

Fig. 3-44

Function name:

Port Security Management

Function description:

Shows each port status. In Multihost mode, it shows the port number and its status, authorized or unauthorized.

Parameter description:

Disable Mode:

When selecting Disable mode for a port in the function 802.1X Port Mode Configuration, the port is in the uncontrolled port state and does not apply 802.1X authenticator on it. Any node attached on this port can access the network without the admittance of 802.1X authenticator. The Port Status will show the following screen.

Port Number:

The port number to be chosen to show its 802.1X Port Status. The valid number is Port 1 – 26.

Port Status:

The current 802.1X status of the port. In Disable mode, this field is Disabled.

802.1x with Multihost mode:

When selecting 802.1x with Multihost mode for a port in the function 802.1X Port Mode Configuration, Devices can access the network through this port once the authenticator is authorized. The Port Status will show the following screen. If the port is granted to access the network, the port status is authorized, otherwise, unauthorized.

Port Security Management

Port	Mode	Status
1	disable	
2	disable	
3	disable	
4	disable	
5	disable	
6	disable	
7	disable	
8	disable	
9	disable	
10	disable	
11	disable	
12	disable	
13	disable	
14	disable	
15	disable	
16	disable	
17	disable	

Fig. 3-45

Function name:

Param. Setting

Function description:

This function is used to configure the parameters for each port in 802.1x port security application. Refer to the following parameters description for details.

Parameter description:

Port:

It is the port number to be selected for configuring its associated 802.1x parameters which are Port control, reAuthMax, txPeriod, Quiet Period, reAuthEnabled, reAuthPeriod, max. Request, suppTimeout, serverTimeout and Controlled direction.

Port Control:

This is used to set the operation mode of authorization. There are three type of operation mode supported, ForceUnauthorized, ForceAuthorized, Auto.

- ForceUnauthorized:

The controlled port is forced to hold in the unauthorized state.

- ForceAuthorized:

The controlled port is forced to hold in the authorized state.

- Auto:

The controlled port is set to be in authorized state or unauthorized state depends on the result of the authentication exchange between the authentication server and the supplicant.

Default: Auto

reAuthMax (1-10):

The number of authentication attempt that is permitted before the port becomes unauthorized.

Default: 2

txPeriod(1-65535 s):

A time period to transmitted EAPOL PDU between the authenticator and the supplicant.

Default: 30

Quiet Period (0-65535 s):

A period of time during which we will not attempt to access the supplicant.

Default: 60 seconds

reAuthEnabled:

Choose whether regular authentication will take place in this port.

Default: ON

reAuthPeriod(1-65535 s):

A non-zero number seconds between the periodic re-authentication of the supplicant.

Default: 3600

max. Request(1-10):

The maximum of number times that the authenticator will retransmit an EAP Request to the supplicant before it times out the authentication session. The valid range: 1 – 10.

Default: 2 times

suppTimeout(1-65535 s):

A timeout condition in the exchange between the authenticator and the supplicant. The valid range: 1 –65535.

Default: 30 seconds.

serverTimeout(1-65535 s):

A timeout condition in the exchange between the authenticator and the authentication server. The valid range: 1 –65535.

Default: 30 seconds

Port Parameter Setting

Port	1
Port Control	Auto
reAuthMax(1-10)	2
txPeriod(1-65535 s)	30
Quiet Period(0-65535 s)	60
reAuthEnabled	ON
reAuthPeriod(1-65535 s)	3600
max. Request(1-10)	2
suppTimeout(1-65535 s)	30
serverTimeout(1-65535 s)	30

Apply

Fig. 3-46

3-13. Alarm Configuration

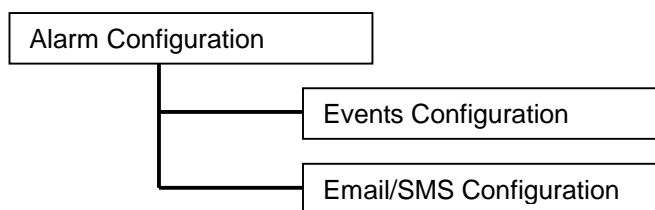

Function name:

Events Configuration

Function description:

The Trap Events Configuration function is used to enable the switch to send out the trap information while pre-defined trap events occurred. The switch offers 21 different trap events to users for switch management. The trap information can be sent out in three ways, including email, mobile phone SMS (short message system) and trap. The message will be sent while users tick (☑) the trap event individually on the web page shown as below.

Parameter description:

Trap: Cold Start, Warm Start, Link Down, Link Up, Authentication Failure, User login, User logout

STP: STP Topology Changed, STP Disabled, STP Enabled

LACP: LACP Disabled, LACP Enabled, LACP Member Added, LACP Port Failure

GVRP: GVRP Disabled, GVRP Enabled

VLAN: Port-based VLAN Enabled, Tag-based VLAN Enabled

Module Swap: Module Inserted, Module Removed, Dual Media Swapped

Trap Events Configuration

Email Select/Unselect All

SMS Select/Unselect All

Trap Select/Unselect All

Event	Email	SMS	Trap
Cold Start	<input type="checkbox"/>	<input type="checkbox"/>	<input checked="" type="checkbox"/>
Warm Start	<input type="checkbox"/>	<input type="checkbox"/>	<input checked="" type="checkbox"/>
Link Down	<input type="checkbox"/>	<input type="checkbox"/>	<input checked="" type="checkbox"/>
Link Up	<input type="checkbox"/>	<input type="checkbox"/>	<input checked="" type="checkbox"/>
Authentication Failure	<input type="checkbox"/>	<input type="checkbox"/>	<input checked="" type="checkbox"/>
User Login	<input type="checkbox"/>	<input type="checkbox"/>	<input type="checkbox"/>
User Logout	<input type="checkbox"/>	<input type="checkbox"/>	<input type="checkbox"/>
STP Topology Changed	<input type="checkbox"/>	<input type="checkbox"/>	<input type="checkbox"/>
STP Disabled	<input type="checkbox"/>	<input type="checkbox"/>	<input type="checkbox"/>
STP Enabled	<input type="checkbox"/>	<input type="checkbox"/>	<input type="checkbox"/>
LACP Disabled	<input type="checkbox"/>	<input type="checkbox"/>	<input type="checkbox"/>

Apply

Fig. 3-47

Function name:

Email/SMS Configuration

Function description:

Alarm configuration is used to configure the persons who should receive the alarm message via either email or SMS, or both. It depends on your settings. An email address or a mobile phone number has to be set in the web page of alarm configuration. Then, user can read the trap information from the email or the mobile phone. This function provides 6 email addresses and 6 mobile phone numbers at most. The 21 different trap events will be sent out to SNMP Manager when trap event occurs. After ticking trap events, you can fill in your desired email addresses and mobile phone numbers. Then, please click **<Apply>** button to complete the alarm configuration. It will take effect in a few seconds.

Note: SMS may not work in your mobile phone system. It is customized for different systems.

Parameter description:

Email:

Mail Server: the IP address of the server transferring your email.

Username: your username on the mail server.

Password: your password on the mail server.

Email Address 1 – 6: email address that would like to receive the alarm message.

SMS:

SMS Server: the IP address of the server transferring your SMS.

Username: your username in ISP.

Password: your username in ISP.

Mobile Phone 1-6: the mobile phone number that would like to receive the alarm message.

Alarm Configuration

Mail Server	<input type="text"/>
Username	<input type="text"/>
Password	<input type="text"/>
Email Address 1	<input type="text"/>
Email Address 2	<input type="text"/>
Email Address 3	<input type="text"/>
Email Address 4	<input type="text"/>
Email Address 5	<input type="text"/>
Email Address 6	<input type="text"/>
SMS Server	<input type="text"/>
Username	<input type="text"/>
Password	<input type="text"/>
Mobile Phone 1	<input type="text"/>
Mobile Phone 2	<input type="text"/>
Mobile Phone 3	<input type="text"/>
Mobile Phone 4	<input type="text"/>
Mobile Phone 5	<input type="text"/>
Mobile Phone 6	<input type="text"/>

Apply

Fig. 3-48

3-14. Configuration

The switch supports three copies of configuration, including the default configuration, working configuration and user configuration for your configuration management. All of them are listed and described below respectively.

▪ **Default Configuration:**

This is factory setting and cannot be altered. In Web UI, two restore default functions are offered for the user to restore to the default setting of the switch. One is the function of “Restore Default Configuration including default IP address”, the IP address will restore to default “192.168.1.1” as you use it. The other is the function of “Restore Default Configuration without changing current IP address”; the IP address will keep the same one that you had saved before by performing this function.

▪ **Working Configuration:**

It is the configuration you are using currently and can be changed any time. The configurations you are using are saved into this configuration file. This is updated each time as you press **<Apply>** button.

▪ **User Configuration:**

It is the configuration file for the specified or backup purposes and can be updated while having confirmed the configuration. You can retrieve it by performing Restore User Configuration.

Configuration

Save Start	Save as Start Configuration
Save User	Save as User Configuration
Restore Default	Restore Default Configuration including default ip address
Restore Default	Restore Default Configuration without changing current ip address
Restore User	Restore User Configuration

Fig. 3-49

3-14-1. Save/Restore

Function name:

Save As Start Configuration

Function description:

Save the current configuration as a start configuration file in flash memory.

Function name:

Save As User Configuration

Function description:

Save the current configuration as a user configuration file in flash memory.

Function name:

Restore Default Configuration (includes default IP address)

Function description:

Restore Default Configuration function can retrieve factory setting to replace the start configuration. And the IP address of the switch will also be restored to 192.168.1.1.

Function name:

Restore Default Configuration (excludes current IP address)

Function description:

Restore Default Configuration function can retrieve factory setting to replace the start configuration. However, the switch's current IP address that the user set up will not be changed and will NOT be restored to 192.168.1.1 as well.

Function name:

Restore User Configuration

Function description:

Restore User Configuration function can retrieve the previous confirmed working configuration stored in the flash memory to update start configuration. When completing to restore the configuration, the system's start configuration is updated and will be changed its system settings after rebooting the system.

3-14-2. Config File

Function name:

Config File

Function description:

With this function, user can back up or reload the config files of Save As Start or Save As User via TFTP. To notice that after import config file, the original IP related setting won't be changed by config file. This feature is designed for preventing remote device lose control after import.

Parameter description:

Export File Path:

Export Start:

Export Save As Start's config file stored in the flash.

Export User-Conf:

Export Save As User's config file stored in the flash.

Import File Path:

Import Start:

Import Save As Start's config file stored in the flash.

Import User-Conf:

Import Save As User's config file stored in the flash.

Configure Export/Import File Path

The screenshot displays a configuration interface with the following elements:

- TFTP Server IP:** A light blue field containing the text "0.0.0.0".
- Export File Path:** A white input field with a blue border. Below it are two teal buttons: "Export Start" and "Export User-Conf".
- Import File Path:** A white input field with a blue border. Below it are two teal buttons: "Import Start" and "Import User-Conf".

Fig. 3-50

3-15. Security

Function name:

Mirror Configuration

Function description:

Mirror Configuration is to monitor the traffic of the network. For example, we assume that Port A and Port B are Monitoring Port and Monitored Port respectively, thus, the traffic received by Port B will be copied to Port A for monitoring.

Parameter description:

Mode:

Used for the activation or de-activation of Port Mirror function. Default is disable.

Monitoring Port:

Set up the port for monitoring. Valid port is Port 1~26 and default is Port 1.

Monitored Ingress Port:

Set up the port for being monitored. It only monitor the packets received by the port you set up. Just tick the check box () beside the port x and valid port is Port 1~26.

Monitored Egress Port:

Set up the port for being monitored. It only monitors the packets transmitted by the port you set up. Just tick the check box () beside the port x and valid port is Port 1~26.

Mirror

Mode	Disable ▾							
Monitoring Port	Port 1 ▾							
Monitored Ingress Port	1. <input type="checkbox"/>	2. <input type="checkbox"/>	3. <input type="checkbox"/>	4. <input type="checkbox"/>	5. <input type="checkbox"/>	6. <input type="checkbox"/>	7. <input type="checkbox"/>	8. <input type="checkbox"/>
	9. <input type="checkbox"/>	10. <input type="checkbox"/>	11. <input type="checkbox"/>	12. <input type="checkbox"/>	13. <input type="checkbox"/>	14. <input type="checkbox"/>	15. <input type="checkbox"/>	16. <input type="checkbox"/>
	17. <input type="checkbox"/>	18. <input type="checkbox"/>	19. <input type="checkbox"/>	20. <input type="checkbox"/>	21. <input type="checkbox"/>	22. <input type="checkbox"/>	23. <input type="checkbox"/>	24. <input type="checkbox"/>
	25. <input type="checkbox"/>	26. <input type="checkbox"/>						
Monitored Egress Port	1. <input type="checkbox"/>	2. <input type="checkbox"/>	3. <input type="checkbox"/>	4. <input type="checkbox"/>	5. <input type="checkbox"/>	6. <input type="checkbox"/>	7. <input type="checkbox"/>	8. <input type="checkbox"/>
	9. <input type="checkbox"/>	10. <input type="checkbox"/>	11. <input type="checkbox"/>	12. <input type="checkbox"/>	13. <input type="checkbox"/>	14. <input type="checkbox"/>	15. <input type="checkbox"/>	16. <input type="checkbox"/>
	17. <input type="checkbox"/>	18. <input type="checkbox"/>	19. <input type="checkbox"/>	20. <input type="checkbox"/>	21. <input type="checkbox"/>	22. <input type="checkbox"/>	23. <input type="checkbox"/>	24. <input type="checkbox"/>
	25. <input type="checkbox"/>	26. <input type="checkbox"/>						

Apply

Fig. 3-51

Function name:

Isolated Group

Function description:

Isolated Group function can let the port be independent of other ports in the Isolated group, and the communication is also forbidden between these ports. But, the ports of the Isolated group are still able to communicate with the ports of the non-Isolated group. With this design, it will be helpful to the administrator to immediately find and solve the port that results in the occurrence of looping problems in the network.

Parameter description:

Mode:

Used for the activation or de-activation of Isolated Group function.
Default is disable

Isolated Group:

User can choose any port to be the member of this group. Just tick the check box () beside the port x and valid port is Port 1~26. In this group, all of these member ports cannot forward packets with each other. Thus, the switch will not be capable of forwarding any packets in case its all ports become the members of the Isolated group.

Isolated Group

Mode	Disable ▾							
Isolated Group	1. <input type="checkbox"/>	2. <input type="checkbox"/>	3. <input type="checkbox"/>	4. <input type="checkbox"/>	5. <input type="checkbox"/>	6. <input type="checkbox"/>	7. <input type="checkbox"/>	8. <input type="checkbox"/>
	9. <input type="checkbox"/>	10. <input type="checkbox"/>	11. <input type="checkbox"/>	12. <input type="checkbox"/>	13. <input type="checkbox"/>	14. <input type="checkbox"/>	15. <input type="checkbox"/>	16. <input type="checkbox"/>
	17. <input type="checkbox"/>	18. <input type="checkbox"/>	19. <input type="checkbox"/>	20. <input type="checkbox"/>	21. <input type="checkbox"/>	22. <input type="checkbox"/>	23. <input type="checkbox"/>	24. <input type="checkbox"/>
	25. <input type="checkbox"/>	26. <input type="checkbox"/>						

Apply

Fig. 3-52

Function name:

Restricted Group

Function description:

The function of the Restricted Group can decide the direction of transmitting packets for the specific port. The packets received by the port with the "Ingress" mode of Restricted Group will be sent to the ports with the "Egress" mode of Restricted Group.

Parameter description:

Mode:

Used for the activation or de-activation of Restricted Group function.
Default is disable.

Ingress:

Select the ports that you would like their Restricted Group to set into "Ingress" mode. Just tick the check box beside the port x and valid port is Port 1~26.

Egress:

Select the ports that you would like their Restricted Group to set into "Egress" mode. Just tick the check box beside the port x and valid port is Port 1~26.

Restricted Group

Mode	Disable ▾							
Ingress	1. <input type="checkbox"/>	2. <input type="checkbox"/>	3. <input type="checkbox"/>	4. <input type="checkbox"/>	5. <input type="checkbox"/>	6. <input type="checkbox"/>	7. <input type="checkbox"/>	8. <input type="checkbox"/>
	9. <input type="checkbox"/>	10. <input type="checkbox"/>	11. <input type="checkbox"/>	12. <input type="checkbox"/>	13. <input type="checkbox"/>	14. <input type="checkbox"/>	15. <input type="checkbox"/>	16. <input type="checkbox"/>
	17. <input type="checkbox"/>	18. <input type="checkbox"/>	19. <input type="checkbox"/>	20. <input type="checkbox"/>	21. <input type="checkbox"/>	22. <input type="checkbox"/>	23. <input type="checkbox"/>	24. <input type="checkbox"/>
	25. <input type="checkbox"/>	26. <input type="checkbox"/>						
Egress	1. <input type="checkbox"/>	2. <input type="checkbox"/>	3. <input type="checkbox"/>	4. <input type="checkbox"/>	5. <input type="checkbox"/>	6. <input type="checkbox"/>	7. <input type="checkbox"/>	8. <input type="checkbox"/>
	9. <input type="checkbox"/>	10. <input type="checkbox"/>	11. <input type="checkbox"/>	12. <input type="checkbox"/>	13. <input type="checkbox"/>	14. <input type="checkbox"/>	15. <input type="checkbox"/>	16. <input type="checkbox"/>
	17. <input type="checkbox"/>	18. <input type="checkbox"/>	19. <input type="checkbox"/>	20. <input type="checkbox"/>	21. <input type="checkbox"/>	22. <input type="checkbox"/>	23. <input type="checkbox"/>	24. <input type="checkbox"/>
	25. <input type="checkbox"/>	26. <input type="checkbox"/>						

Apply

Fig. 3-53

3-16. Bandwidth Management

Function name:

Ingress Bandwidth Setting

Function description:

Ingress Bandwidth Setting function is used to set up the limit of Ingress bandwidth for each port.

Ingress Bandwidth Control

Port 1-24:66-102400(Kb)
Port 25, 26: 66-1024000(Kb)

Port No	Rate(Kb)	Port No	Rate(Kb)
1	102400	2	102400
3	102400	4	102400
5	102400	6	102400
7	102400	8	102400
9	102400	10	102400
11	102400	12	102400
13	102400	14	102400
15	102400	16	102400
17	102400	18	102400
19	102400	20	102400
21	102400	22	102400
23	102400	24	102400
25	1024000	26	1024000

Apply

Fig. 3-54

Parameter description:

Port No.:

Choose the port that you would like this function to work on it. Valid range of the port is 1~26.

Rate:

Set up the limit of Ingress bandwidth for the port you choose. Incoming traffic will be discarded if the rate exceeds the value you set up in Data Rate field. Pause frames are also generated if flow control is enabled. The format of the packet limits to unicast, broadcast and multicast. Valid value of Port 1~24 ranges from 66~102400, and Port 25~26 ranges from 66~1024000 with the minimum unit of 1. Default value of Port 1~24 is 102400 and Port 25~26 is 1024000.

Function name:

Egress Bandwidth Setting

Function description:

Egress Bandwidth Setting function is used to set up the limit of Egress bandwidth for each port.

Parameter description:

Port No.:

Choose the port that you would like this function to work on it. Valid range of the port is 1~26.

Rate:

Set up the limit of Egress bandwidth for the port you choose. Packet transmission will be delayed if the rate exceeds the value you set up in Data Rate field. Traffic may be lost if egress buffers run full. The format of the packet limits to unicast, broadcast and multicast. Valid value of Port 1~24 ranges from 66~102400, and Port 25~26 ranges from 66~1024000 with the minimum unit of 1. Default value of Port 1~24 is 102400 and Port 25~26 is 1024000.

Function name:

Storm Setting

Function description:

Bandwidth Management function is used to set up the limit of Ingress and Egress bandwidth for each port.

Bandwidth Storm Control

The screenshot displays the configuration interface for Bandwidth Storm Control. It consists of two main sections: 'Storm Type' and 'Storm Rate'. The 'Storm Type' section has a dropdown menu currently set to 'Disable'. The 'Storm Rate' section has a text input field containing the value '100' and a range indicator '(1~100)%'. Below these sections is a green 'Apply' button.

Apply

Fig. 3-55

Parameter description:

Storm Type:

Disable:

Disable the function of the bandwidth storm control.

Broadcast Storm Control:

Enable the function of bandwidth storm control for broadcast packets.

Multicast Storm Control:

Enable the function of bandwidth storm control for multicast packets.

Unknown Unicast Storm Control:

Enable the function of bandwidth storm control for unknown unicast packets. These packets are the MAC address that had not completed the learning process yet.

Broadcast, Multicast, Unknown Unicast Storm Control:

Enable the function of bandwidth storm control for all packets in transmission.

Storm Rate:

Set up the limit of bandwidth for storm type you choose. Valid value of the storm rate ranges from 1-100 with the minimum unit of 1. And only integer is acceptable. Default is 100.

3-17. QoS(Quality of Service) Configuration

The switch supports 5 kinds of QoS, are as follows, MAC Priority, 802.1p Priority, IP TOS Priority, and DiffServ DSCP Priority. Port Based Priority has a special name called VIP Port in the switch. Any packets enter VIP Port will have highest transmitting priority. MAC Priority act on the destination address of MAC in packets. VLAN tagged Priority field is affected by 802.1p Priority setting. IP TOS Priority affects TOS fields of IP header, and you can find it has 8-bit SERVICE TYPE field that specifies how the datagram should be handled. The field could be divided into six subfields as follows, PRECEDENCE (3 bits), D-Type (Delay Priority, 1 bit), T-Type (Throughput Priority, 1bit), R-Type (Reliability Priority, 1bit), M-Type (Monetary Cost Priority, 1bit), and UNUSED (1bit).

User can randomly control these fields to achieve some special QoS goals. When bits D, T, R, or M set, the D bit requests low delay, the T bit requests high throughput, the R bit requests high reliability, and the M bit requests low cost.

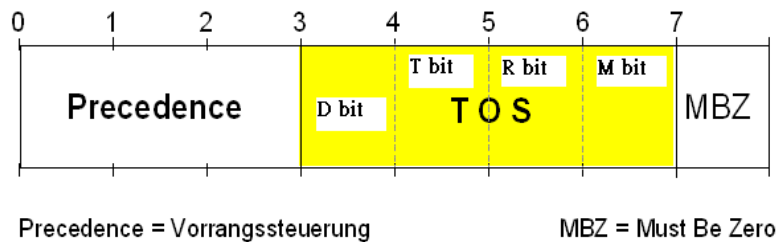

DiffServ DSCP Priority act on DSCP field of IP Header. In the late 1990s, the IETF redefined the meaning of the 8-bit SERVICE TYPE field to accommodate a set of differentiated services (DS). Under the differentiated services interpretation, the first six bits comprise a codepoint, which is sometimes abbreviated DSCP, and the last two bits are left unused.

High Priority Packet streams will experience less delay into the switch. For handing different priority packets, each egress port has designed up to 4 queues. Each QoS is influenced by two scheduling, WRR (Weighted Round Robin) and Strict Priority as well. When you finish setting the priority mapping to the queue, WRR scheduling will distribute the bandwidth according to the weight you set for 4 queues (queue 0 to queue 3). Another scheduling is Strict Priority dedicated for the function named VIP Port of QoS. While we select some ports as the VIP Port, these ports will own the highest transmitting priority in egress queue of the switch.

The QoS functions as we mentioned above are able to enable at the same time. But, the following precedence will decide whether these functions work or not.

1. enable both VIP and TOS
Choose priorities of VIP and TOS.
2. enable both VIP and DSCP
Choose priorities of VIP and DSCP.
3. enable both TOS and DSCP
Choose "DSCP".
4. enable both VIP and DSCP
Choose priorities of VIP and DSCP.
5. enable both 802.1p and TOS
Choose "TOS".
6. enable both 802.1p and DSCP
Choose "DSCP".
7. enable both 802.1p and DSCP and TOS
Choose "DSCP".
8. enable both 802.1p and DSCP and TOS and VIP
Choose priorities of VIP and DSCP.
** VIP/DSCP > TOS > 802.1p (Final result)

Function name:

QoS Global Setting

Function description:

When you want to use QoS function, please enable QoS Mode in advance. Then you can use MAC Priority, 802.1p Priority, IP TOS Priority, DiffServ DSCP Priority, or VIP Port functions and take effect. In this function, you can Enable QoS Mode. Choose any of Priority Control, such as 802.1p, TOS, DSCP. Moreover, you can select Scheduling Method of WRR (Weighted Round Robin) or Strict Priority. Next, you can arrange Weight values for queue 0 to queue 3.

Parameter description:

QoS Mode:

You can Enable QoS Mode and let QoS function become effective. Default is Disable.

Priority Control:

Just tick the check box () of 802.1P, TOS, or DSCP QoS and click Apply button to be in operation.

Scheduling Method:

There are two Scheduling Method, WRR and Strict Priority. Default is WRR. After you choose any of Scheduling Method, please click Apply button to be in operation.

Weight (1~55):

Over here, you can make an arrangement to Weight values of Queue 0 to Queue 3. The range of Weight you can set is 1~55. In default, the weight of Queue 0 is 1, the weight of Queue 1 is 2, the weight of Queue 2 is 4, and the weight of Queue 3 is 8.

QoS Global Config

QoS Mode		Enable	
Priority Control			
802.1P	TOS	DSCP	
<input type="checkbox"/>	<input type="checkbox"/>	<input type="checkbox"/>	
Scheduling Method		WRR	
Weight (1-55)			
Queue 0	Queue 1	Queue 2	Queue 3
1	2	4	8
<input type="button" value="Apply"/>			

Fig. 3-56

Function name:

VIP Port Setting

Function description:

When the port is set as VIP Port, the packets enter this port and will have highest transmitting priority. For example, as you choose port 2 is VIP Port, simultaneously transmit packets from port 2 and port 3 to port 1 at speed of 100MB and let congestion happen. The packets for port 3 will be dropped because the packets from port 2 own highest precedence. For the sake of this function taking effect, you must choose Scheduling Method of Strict Priority ahead.

Parameter description:

VIP Port:

Just tick the check box () to select any port (port 1~26) as the VIP Port. Then, click the **<Apply>** button to have the setting taken effect.

VIP Port

VIP Group	1. <input type="checkbox"/>	2. <input type="checkbox"/>	3. <input type="checkbox"/>	4. <input type="checkbox"/>	5. <input type="checkbox"/>	6. <input type="checkbox"/>	7. <input type="checkbox"/>	8. <input type="checkbox"/>
	9. <input type="checkbox"/>	10. <input type="checkbox"/>	11. <input type="checkbox"/>	12. <input type="checkbox"/>	13. <input type="checkbox"/>	14. <input type="checkbox"/>	15. <input type="checkbox"/>	16. <input type="checkbox"/>
	17. <input type="checkbox"/>	18. <input type="checkbox"/>	19. <input type="checkbox"/>	20. <input type="checkbox"/>	21. <input type="checkbox"/>	22. <input type="checkbox"/>	23. <input type="checkbox"/>	24. <input type="checkbox"/>
	25. <input type="checkbox"/>	26. <input type="checkbox"/>						

Fig. 3-57

Function name:

802.1p Setting

Function description:

This function will affect the priority of VLAN tag. Based on priority of VLAN tag, it can arrange 0~8 priorities, priorities can map to 4 queues of the switch (queue 0~3) and possess different bandwidth distribution according to your weight setting.

Parameter description:

802.1p Priority Mapping:

Each Priority can select any of Queue 0 ~ Queue 3. In Default, Priority 0 is mapping to Queue 0, Priority 1 is mapping to Queue 0, Priority 2 is mapping to Queue 1, Priority 3 is mapping to Queue 1, Priority 4 is mapping to Queue 2, Priority 5 is mapping to Queue 2, Priority 6 is mapping to Queue 3, and Priority 7 is mapping to Queue 3.

802.1p Priority Mapping

Priority	Queue
0	0
1	0
2	1
3	1
4	2
5	2
6	3
7	3

Apply

Fig. 3-58

Function name:

D-Type TOS

Function description:

IP TOS Priority affect TOS fields of IP header, you can find it has 8-bit SERVICE TYPE field that specifies how the datagram should be handled. The field could be divided into six subfields as follows, PRECEDENCE (3 bits), D-Type (Delay Priority, 1 bit), T-Type (Throughput Priority, 1bit), R-Type (Reliability Priority, 1bit), M-Type (Monetary Cost Priority, 1bit), and UNUSED. PRECEDENCE 3-bits can arrange 8 kinds of priorities corresponding to the 0~7 priority in the following priority diagram. TOS Delay Priority Mapping works while D-TYPE in TOS field of IP header of the packets received by the switch is configured.

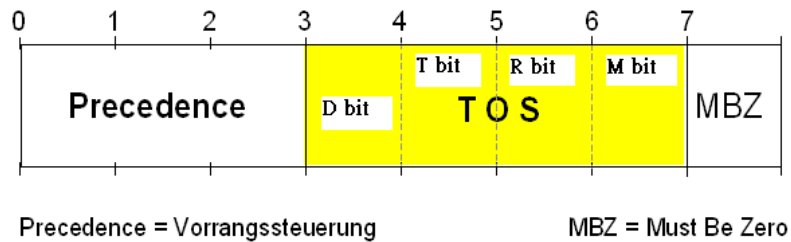

Parameter description:

TOS Delay Priority Mapping:

Each Priority can select any of Queue 0 ~ Queue 3. In Default, Priority 0 is mapping to Queue 0, Priority 1 is mapping to Queue 0, Priority 2 is mapping to Queue 1, Priority 3 is mapping to Queue 1, Priority 4 is mapping to Queue 2, Priority 5 is mapping to Queue 2, Priority 6 is mapping to Queue 3, and Priority 7 is mapping to Queue 3.

TOS Delay Priority Mapping

Priority	Queue
0	0
1	0
2	1
3	1
4	2
5	2
6	3
7	3

Apply

Fig. 3-59

Function name:

T-Type TOS

Function description:

IP TOS Priority affect TOS fields of IP header, you can find it has 8-bit SERVICE TYPE field that specifies how the datagram should be handled. The field could be divided into six subfields as follows, PRECEDENCE (3 bits), D-Type (Delay Priority, 1 bit), T-Type (Throughput Priority, 1bit), R-Type (Reliability Priority, 1bit), M-Type (Monetary Cost Priority, 1bit), and UNUSED. PRECEDENCE 3-bits can arrange 8 kinds of priorities corresponding to the 0~7 priority in the following priority diagram. TOS Throughput Priority Mapping works while T-TYPE in TOS field of IP header of the packets received by the switch is configured.

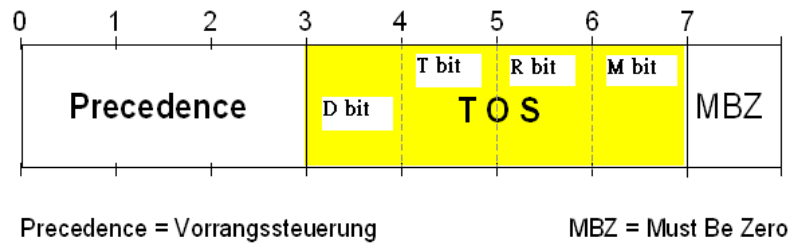

Parameter description:

TOS Throughput Priority Mapping:

Each Priority can select any of Queue 0 ~ Queue 3. In Default, Priority 0 is mapping to Queue 0, Priority 1 is mapping to Queue 0, Priority 2 is mapping to Queue 1, Priority 3 is mapping to Queue 1, Priority 4 is mapping to Queue 2, Priority 5 is mapping to Queue 2, Priority 6 is mapping to Queue 3, and Priority 7 is mapping to Queue 3.

TOS Throughput Priority Mapping

Priority	Queue
0	0
1	0
2	1
3	1
4	2
5	2
6	3
7	3

Apply

Fig. 3-60

Function name:

R-Type TOS

Function description:

IP TOS Priority affect TOS fields of IP header, you can find it has 8-bit SERVICE TYPE field that specifies how the datagram should be handled. The field could be divided into six subfields as follows, PRECEDENCE (3 bits), D-Type (Delay Priority, 1 bit), T-Type (Throughput Priority, 1bit), R-Type (Reliability Priority, 1bit), M-Type (Monetary Cost Priority, 1bit), and UNUSED. PRECEDENCE 3-bits can arrange 8 kinds of priorities corresponding to the 0~7 priority in the following priority diagram. TOS Reliability Priority Mapping works while R-TYPE in TOS field of IP header of the packets received by the switch is configured.

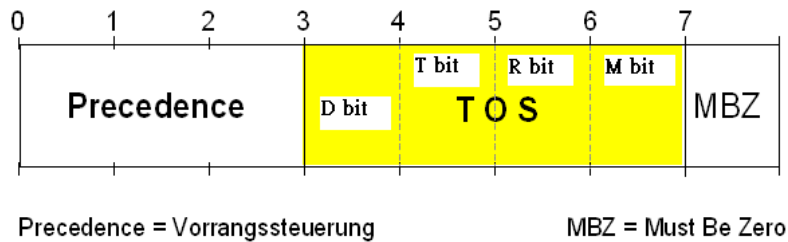

Parameter description:

TOS Reliability Priority Mapping:

Each Priority can select any of Queue 0 ~ Queue 3. In Default, Priority 0 is mapping to Queue 0, Priority 1 is mapping to Queue 0, Priority 2 is mapping to Queue 1, Priority 3 is mapping to Queue 1, Priority 4 is mapping to Queue 2, Priority 5 is mapping to Queue 2, Priority 6 is mapping to Queue 3, and Priority 7 is mapping to Queue 3.

TOS Reliability Priority Mapping

Priority	Queue
0	0
1	0
2	1
3	1
4	2
5	2
6	3
7	3

Apply

Fig. 3-61

Function name:

M-Type TOS

Function description:

IP TOS Priority affect TOS fields of IP header, you can find it has 8-bit SERVICE TYPE field that specifies how the datagram should be handled. The field could be divided into six subfields as follows, PRECEDENCE (3 bits), D-Type (Delay Priority, 1 bit), T-Type (Throughput Priority, 1bit), R-Type (Reliability Priority, 1bit), M-Type (Monetary Cost Priority, 1bit), and UNUSED. PRECEDENCE 3-bits can arrange 8 kinds of priorities corresponding to the 0~7 priority in the following priority diagram. TOS Monetary Cost Priority Mapping works while M-TYPE in TOS field of IP header of the packets received by the switch is configured.

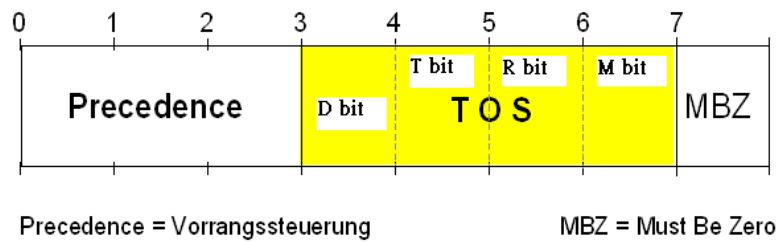

Parameter description:

TOS Monetary Cost Priority Mapping:

Each Priority can select any of Queue 0 ~ Queue 3. In Default, Priority 0 is mapping to Queue 0, Priority 1 is mapping to Queue 0, Priority 2 is mapping to Queue 1, Priority 3 is mapping to Queue 1, Priority 4 is mapping to Queue 2, Priority 5 is mapping to Queue 2, Priority 6 is mapping to Queue 3, and Priority 7 is mapping to Queue 3.

TOS Monetary Cost Priority Mapping

Priority	Queue
0	0
1	0
2	1
3	1
4	2
5	2
6	3
7	3

Apply

Fig. 3-62

Function name:

DSCP Setting

Function description:

In the late 1990s, the IETF redefined the meaning of the 8-bit SERVICE TYPE field to accommodate a set of differentiated services (DS). Under the differentiated services interpretation, the first six bits comprise a codepoint, which is sometimes abbreviated DSCP, and the last two bits are left unused.

DSCP can form total 64 (0~63) kinds of Traffic Class based on the arrangement of 6-bit field in DSCP of the IP packet. In the switch, user is allowed to set up these 64 kinds of Class that belong to any of queue 0~3.

Parameter description:

DSCP Priority Mapping:

64 kinds of priority traffic as mentioned above, user can set up any of Queue 0~3. In default, Priority 0~15 are mapping to Queue 0, Priority 16~31 are mapping to Queue 1, Priority 32~47 are mapping to Queue 0, Priority 48~63 are mapping to Queue 0.

DSCP Priority Mapping

Priority	Queue	Priority	Queue	Priority	Queue	Priority	Queue
0	0	1	0	2	0	3	0
4	0	5	0	6	0	7	0
8	0	9	0	10	0	11	0
12	0	13	0	14	0	15	0
16	1	17	1	18	1	19	1
20	1	21	1	22	1	23	1
24	1	25	1	26	1	27	1
28	1	29	1	30	1	31	1
32	2	33	2	34	2	35	2
36	2	37	2	38	2	39	2
40	2	41	2	42	2	43	2
44	2	45	2	46	2	47	2
48	3	49	3	50	3	51	3
52	3	53	3	54	3	55	3
56	3	57	3	58	3	59	3
60	3	61	3	62	3	63	3

Apply

Fig. 3-63

3-18. Diagnostics

Three functions, including Diagnostics, Loopback Test and Ping Test are contained in this function folder for device self-diagnostics. Each of them will be described in detail orderly in the following sections.

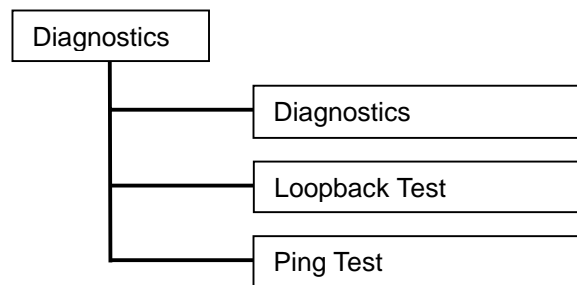

Function name:

Diagnostics

Function description:

Diagnostics function provides a set of basic system diagnosis. It let users know that whether the system is health or needs to be fixed. The basic system check includes EEPROM test, UART test, DRAM test and Flash test.

Diagnostics

EEPROM Test	wait.....
UART Test	wait.....
DRAM Test	wait.....
Flash Test	wait.....

Run

Fig. 3-64

Function name:

Loopback Test

Function description:

In the Loopback Test function, there are two different loopback tests. One is Internal Loopback Test and the other is External Loopback Test. The former test function will not send the test signal outside the switch box. The test signal only wraps around in the switch box. As to the latter test function, it will send the test signal to its link partner. If you do not have them connected to active network devices, i.e. the ports are link down, the switch will report the port numbers failed. If they all are ok, it just shows OK.

Note: Whatever you choose Internal Loopback Test or External Loopback Test, these two functions will interfere with the normal system working, and all packets in sending and receiving also will stop temporarily.

Loopback Test

Port No	Internal Loopback	External Loopback
1	OK	OK
2	OK	Fail
3	OK	Fail
4	OK	Fail
5	OK	Fail
6	OK	Fail
7	OK	Fail
8	OK	Fail
9	OK	Fail
10	OK	Fail
11	OK	Fail
12	OK	Fail

Fig. 3-65

Function name:

Ping Test

Function description:

Ping Test function is a tool for detecting if the target device is alive or not through ICMP protocol which abounds with report messages. The switch provides Ping Test function to let you know that if the target device is available or not. You can simply fill in a known IP address and then click **<Ping>** button. After a few seconds later, the switch will report you the pinged device is alive or dead in the field of Ping Result.

Parameter description:

IP Address:

An IP address with the version of v4, e.g. 192.168.1.1.

Default Gateway:

IP address of the default gateway.

For more details, please see the section of IP address in Chapter 2.

Ping Test

IP Address	<input type="text"/>
Default Gateway	192.168.4.254
Ping Result	

Ping

Input an address to ping, ex. 192.168.1.1

Fig. 3-66

3-19. TFTP Server

Function name:

TFTP Server

Function description:

Set up IP address of TFTP server.

Parameter description:

Specify the IP address where the TFTP server locates. Fill in the IP address of your TFTP server, then press **<Apply>** button to have the setting taken effect.

TFTP Server

Server	0.0.0.0
--------	---------

Apply

Fig. 3-67

3-20. Log

This function shows the log data. The switch provides system log data for users. There are 16 private trap logs, 5 public trap logs. The switch supports total 120 log entries. For more details on log items, please refer to the section of Trap/Alarm Configuration and SNMP Configuration.

Function name:

Log Data

Function description:

The Trap Log Data is displaying the log items including all SNMP Private Trap events, SNMP Public traps and user logs occurred in the system. In the report table, No., Time and Events are three fields contained in each trap record.

Log Data		
TFTP Server	0.0.0.0	
Auto Upload	Disabled	
No	Time	Events
1	Tue Nov 14 18:46:27 2006	Login [admin]
2	Tue Nov 14 18:25:59 2006	Cold Start

Fig. 3-68

Parameter description:

No.:

Display the order number that the trap happened.

Time:

Display the time that the trap happened.

Events:

Display the trap event name.

Auto Upload Enable:

Switch the enabled or disabled status of the auto upload function.

Upload Log:

Upload log data through tftp.

Clear Log:

Clear log data.

3-21. Firmware Upgrade

Software upgrade tool is used to help upgrade the software function in order to fix or improve the function. The switch provides a TFTP client for software upgrade. This can be done through Ethernet.

Function name:

Firmware Upgrade

Function description:

The switch supports TFTP upgrade tool for upgrading software. If you assure to upgrade software to a newer version one, you must follow two procedures:

- 1.) Specifying the IP address where TFTP server locates. In this field, the IP address of your TFTP server should be filled in.
- 2.) Specifying what the filename and where the file is. You must specify full path and filename.

Then, press **<Upgrade>** button if your download is not successful, the switch will also be back to “Software Upgrade”, and it will not upgrade the software as well.

When download is completed, the switch starts upgrading software. A reboot message will be prompted after completing upgrading software. At this time, you must reboot the switch to have new software worked.

Note: Software upgrade is hazardous if power is off. You must do it carefully.

Parameter description:

TFTP Server: A TFTP server stored the image file you want to upgrade.

Path and Filename: File path and filename stored the image file you want to upgrade.

Firmware Upgrade

TFTP Server	0.0.0.0
Path and Filename	<input type="text"/>

Upgrade

Fig. 3-69

3-22. Reboot

We offer you many ways to reboot the switch, including power up, hardware reset and software reset. You can press the RESET button in the front panel to reset the switch. After upgrading software, changing IP configuration or changing VLAN mode configuration, then you must reboot to have the new configuration taken effect. Here we are discussing is software reset for the “reboot” in the main menu.

Function name:

Reboot

Function description:

Reboot the switch. Reboot takes the same effect as the RESET button on the front panel of the switch. It will take around thirty (30) seconds to complete the system boot.

Parameter description:

Save and Reboot:

Save the current settings as start configuration before rebooting the switch.

Reboot:

Reboot the system directly.

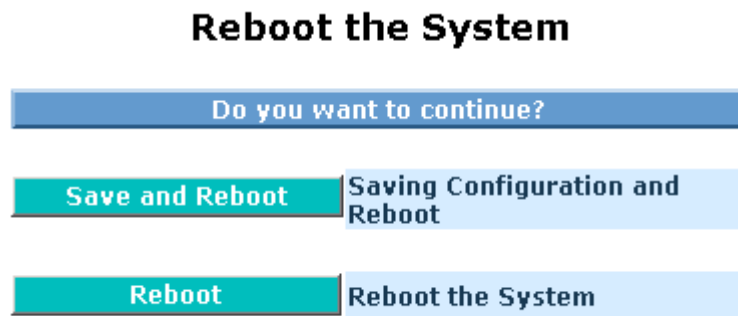

Fig. 3-70

3-23. Logout

You can manually logout by performing Logout function. In the switch, it provides another way to logout. You can configure it to logout automatically.

Function name:

Logout

Function description:

The switch allows you to logout the system to prevent other users from the system without the permission. If you do not logout and exit the browser, the switch will automatically have you logout. Besides this manually logout and implicit logout, you can pull down the **<Auto Logout>** list at the left-top corner to explicitly ON/OFF this logout function.

Parameter description:

Auto Logout:

Default is ON. If it is "ON", and no action and no key is stroke as well in any function screen more than 3 minutes, the switch will have you logout automatically.

Logout

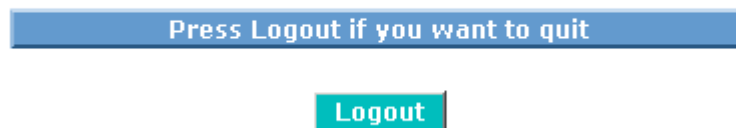

Fig. 3-71

4. Operation of CLI Management

4-1. CLI Management

Refer to Chapter 2 for basic installation. The following description is the brief of the network connection.

- Locate the correct DB-9 null modem cable with female DB-9 connector. Null modem cable comes with the management switch. Refer to the Appendix B for null modem cable configuration.
- Attach the DB-9 female connector to the male DB-9 serial port connector on the Management board.
- Attach the other end of the DB-9 cable to an ASCII terminal emulator or PC Com-1, 2 port. For example, PC runs Microsoft Windows HyperTerminal utility.
- At "Com Port Properties" Menu, configure the parameters as below: (see the next section)

Baud rate	57600
Stop bits	1
Data bits	8
Parity	N
Flow control	none

4-1-1. Login

The command-line interface (CLI) is a text-based interface. User can access the CLI through either a direct serial connection to the device or a Telnet session. The default values of the managed switch are listed below:

```
Username: admin
Password: admin
```

After you login successfully, the prompt will be shown as "#" if you are the first login person and your authorization is administrator; otherwise it may show "\$". See the following two figures. The former means you behave as an administrator and have the access right of the system. As to the latter, it means you behave as a guest and are only allowed to view the system without the permission to do any setting for this switch.

```
-----  
Managed Switch - 2262 FE Switch  
  
Login: admin  
Password:  
  
2262#  
-----
```

Fig. 4-1

```
-----  
Managed Switch - 2262 FE Switch  
  
Login: admin  
Password:  
  
2262$  
-----
```

Fig. 4-2

4-2. Commands of CLI

To see the commands of the mode, please input “?” after the prompt, then all commands will be listed in the screen. All commands can be divided into two categories, including global commands and local commands. Global commands can be used wherever the mode you are. They are “exit”, “end”, “help”, “history”, “logout”, “save start”, “save user”, “restore default” and “restore user”. For more details, please refer to Section 4-2-1.

Command instructions reside in the corresponding modes are local commands. The same command with the same command name may occur but perform totally different function in different modes. For example, “show” in IP mode performs displaying the IP information; however, it performs displaying the system information in system mode. For more details, please refer to Section 4-2-2.

```
Commands available:
-----<< Local commands >>-----
802.1X          Enter into 802.1X mode
account         Enter into account mode
alarm           Enter into alarm mode
autologout      Change autologout time
bandwidth       Enter into bandwidth mode
config-file     Enter into config file mode
dhcp-boot       Enter into dhcp-boot mode
diag            Enter into diag mode
firmware        Enter into firmware mode
gurp            Enter into gurp mode
hostname        Change hostname
igmp-snooping  Enter into igmp mode
ip              Enter into ip mode
log             Enter into log mode
loop-detection  Enter into Loop-Detection(LD) mode
mac-table       Enter into mac table mode
management      Enter into management mode
port            Enter into port mode
qos             Enter into qos mode
reboot          Reboot the system
security        Enter into security mode
snmp            Enter into snmp mode
stp             Enter into stp mode
system          Enter into system mode
tftp            Enter into tftp mode
time            Enter into time mode
trunk           Enter into trunk mode
vlan            Enter into vlan mode
vs              Enter into virtual stack mode
-----<< Global commands >>-----
end             Back to the top mode
exit            Back to the previous mode
help            Show available commands
history         Show a list of previously run commands
logout          Logout the system
restore default Restore default config
restore user    Restore user config
save start      Save as start config
save user       Save as user config
```

Fig. 4-3

4-2-1. Global Commands of CLI

end

Syntax:

end

Description:

Back to the top mode.

When you enter this command, your current position would move to the top mode. If you use this command in the top mode, you are still in the position of the top mode.

Argument:

None.

Possible value:

None.

Example:

FE2262 # alarm

FE2262 (alarm)# events

FE2262 (alarm-events)# end

FE2262 #

exit

Syntax:

exit

Description:

Back to the previous mode.

When you enter this command, your current position would move back to the previous mode. If you use this command in the top mode, you are still in the position of the top mode.

Argument:

None.

Possible value:

None.

Example:

FE2262 # trunk

FE2262 (trunk)# exit

FE2262 #

help

Syntax:

help

Description:

To show available commands.

Some commands are the combination of more than two words. When you enter this command, the CLI would show the complete commands. Besides, the command would help you classify the commands between the local commands and the global ones.

Argument:

None.

Possible value:

None.

Example:

FE2262 # ip

FE2262(ip)# help

```
-----<< Local commands >>-----  
  disable dhcp      Disable DHCP  
  enable dhcp       Enable DHCP, and set dns auto or manual  
  set dns           Set dns  
  set ip            Set ip and gateway  
  show              Show IP Configuration  
-----<< Global commands >>-----  
  end               Back to the top mode  
  exit              Back to the previous mode  
  help              Show available commands  
  history           Show a list of previously run commands  
  logout            Logout the system  
  restore default   Restore default config  
  restore user      Restore user config  
  save start        Save as start config  
  save user         Save as user config
```

FE2262(ip)#

history

Syntax:

history [#]

Description:

To show a list of previous commands that you had ever run.

When you enter this command, the CLI would show a list of commands which you had typed before. The CLI supports up to 256 records. If no argument is typed, the CLI would list total records up to 256. If optional argument is given, the CLI would only show the last numbers of records, given by the argument.

Argument:

[#]: show last number of history records. (optional)

Possible value:

[#]: 1, 2, 3,, 256

Example:

FE2262 (ip)# history

Command history:

0. ?
1. trunk
2. exit
3. FEL2SW-26 # trunk
4. FEL2SW-26 (trunk)# exit
5. FEL2SW-26 #
6. trunk
7. exit
8. alarm
9. events
10. end
11. ip
12. help
13. history

FE2262 (ip)# history 3

Command history:

12. help
13. history
14. history 3

FE2262 (ip)#

logout

Syntax:

logout

Description:

When you enter this command via Telnet connection, you would logout the system and disconnect. If you connect the system through direct serial port with RS-232 cable, you would logout the system and be back to the initial login prompt when you run this command.

Argument:

None.

Possible value:

None.

Example:

FE2262 # logout

restore default

Syntax:

restore default

Description:

When you use this function in CLI, the system will show you the information "Do you want to restore the default IP address?(y/n)". If you choose Y or y, the IP address will restore to default "192.168.1.1". If you choose N or n, the IP address will keep the same one that you had saved before.

If restoring default successfully, the CLI would prompt if reboot immediately or not. If you press Y or y, the system would reboot immediately; otherwise, it would be back to the CLI system. After restoring default configuration, all the changes in the startup configuration would be lost. After rebooting, the entire startup configuration would reset to factory default.

Argument:

None.

Possible value:

None.

Example:

FE2262# restore default

Do you want to restore the default ip address?(y/n)

Restoring ...

Restore default configuration successfully.

Do you want to reboot the system?(y/n)

restore user

Syntax:

restore user

Description:

To restore the startup configuration as user defined configuration. If restoring default successfully, the CLI would prompt if reboot immediately or not. If you press Y or y, the system would reboot immediately; others would back to the CLI system. After restoring user-defined configuration, all the changes in the startup configuration would be lost. After rebooting, the entire startup configuration would replace as user defined one.

Argument:

None.

Possible value:

None.

Example:

```
FE2262# restore user
Restoring ...
Restore user configuration successfully.
Do you want to reboot the system?(y/n)
```

save start

Syntax:

save start

Description:

To save the current configuration as the start one. When you enter this command, the CLI would save your current configuration into the non-volatile FLASH. If you want the configuration still works after rebooting, save the configuration using the command 'save stat'.

Argument:

None.

Possible value:

None.

Example:

```
FE2262 # save start
Saving start...
Save Successfully
```

```
FE2262 #
```

save user

Syntax:

save user

Description:

To save the current configuration as the user-defined configuration. When you enter this command, the CLI would save your current configuration into the non-volatile FLASH as user-defined configuration.

Argument:

None.

Possible value:

None.

Example:

FE2262 # *save user*

Saving user...

Save Successfully

FE2262 #

4-2-2. Local Commands of CLI

■ 802.1x

set max-request

Syntax:

set max-request <port-range> <times>

Description:

The maximum number of times that the state machine will retransmit an EAP Request packet to the Supplicant before it times out the authentication session.

Argument:

<port range>: syntax 1,5-7, available from 1 to 26

<times>: max-times, range 1-10

Possible value:

<port range> : 1 to 26

<times> : 1-10, default is 2

Example:

FE2262(802.1x)# set max-request 2 2

set mode

Syntax:

set mode <port-range> <mode>

Description:

To set up the 802.1X authentication mode of each port.

Argument:

<port range> : syntax 1,5-7, available from 1 to 26

<mode> : set up 802.1x mode

0:disable the 802.1x function

1:set 802.1x to Multi-host mode

Possible value:

<port range> : 1 to 26

<mode>: 0 or 1

Example:

FE2262(802.1x)# set mode 2 1

set port-control

Syntax:

set port-control <port-range> <authorized>

Description:

To set up 802.1X status of each port.

Argument:

<port range> : syntax 1,5-7, available from 1 to 26

<authorized> : set up the status of each port

0:ForceUnauthorized

1:ForceAuthorized

2:Auto

Possible value:

<port range> : 1 to 26

<authorized> : 0,1 or 2

Example:

FE2262(802.1x)# set port-control 2 2

set quiet-period

Syntax:

set quiet-period <port-range> <sec>

Description:

A timer used by the Authenticator state machine to define periods of time during when it will not attempt to acquire a Supplicant.

Argument:

<port range> : syntax 1,5-7, available from 1 to 26

<sec> : timer, range 0-65535

Possible value:

<port range> : 1 to 26

<sec> : 0-65535, default is 60

Example:

FE2262 (802.1x)# set quiet-period 2 30

set reAuthEnabled

Syntax:

set reAuthEnabled <port-range> <ebl>

Description:

A constant that define whether regular reauthentication will take place on this port.

Argument:

<port range> : syntax 1,5-7, available from 1 to 26

<ebl> :

0:"OFF" to disable reauthentication

1:"ON" to enable reauthentication

Possible value:

<port range> : 1 to 26

<ebl> : 0 or 1, default is 1

Example:

FE2262 (802.1x)# set reAuthEnabled 2 1

set reAuthMax

Syntax:

set reAuthMax <port-range> <max>

Description:

The number of reauthentication attempts that are permitted before the port becomes Unauthorized.

Argument:

<port range> : syntax 1,5-7, available from 1 to 26

<max> : max. value , range 1-10

Possible value:

<port range> : 1 to 26

<max> : 1-10, default is 2

Example:

FE2262 (802.1x)# set reAuthMax 2 2

set reAuthPeriod

Syntax:

set reAuthPeriod <port-range> <sec>

Description:

A constant that defines a nonzero number of seconds between periodic reauthentication of the supplicant.

Argument:

<port range> : syntax 1,5-7, available from 1 to 26

<sec> : timer, range 1-65535

Possible value:

<port range> : 1 to 26

<sec> : 1-65535, default is 3600

Example:

FE2262 (802.1x)# set reAuthPeriod 2 3600

set serverTimeout

Syntax:

set serverTimeout <port-range> <sec>

Description:

A timer used by the Backend Authentication state machine in order to determine timeout conditions in the exchanges between the Authenticator and the Supplicant or Authentication Server. The initial value of this timer is either suppTimeout or serverTimeout, as determined by the operation of the Backend Authentication state machine.

Argument:

<port range> : syntax 1,5-7, available from 1 to 26

<sec> : timer, range 1-65535

Possible value:

<port range> : 1 to 26

<sec> : 1-65535, default is 30

Example:

FE2262 (802.1x)# set serverTimeout 2 30

165

set state

Syntax:

set state <ip> <port-number> <secret-key> <Accounting Service> <Accounting Server> <Accounting Port>

Description:

To configure the settings related with 802.1X Radius Server and Accounting service.

Argument:

ip: xxx.xxx.xxx.xxx

port-number: 1~65535

secret-key: The length of secret-key is from 1 to 31

Accounting Service: 0 for disable, 1 for enable

Accounting Server: xxx.xxx.xxx.xxx

Accounting Port: 1~65535

Possible value:

<port-number> : 1~65535, default 1812

<Accounting-port> : 1~65535, default 1813

Example:

FE2262(802.1X)# set state 192.168.1.1 1812 password 1 192.168.1.1 1813

set suppTimeout

Syntax:

set suppTimeout <port-range> <sec>

Description:

A timer used by the Backend Authentication state machine in order to determine timeout conditions in the exchanges between the Authenticator and the Supplicant or Authentication Server. The initial value of this timer is either suppTimeout or serverTimeout, as determined by the operation of the Backend Authentication state machine.

Argument:

<port range> : syntax 1,5-7, available from 1 to 26

<sec> : timer, range 1-65535

Possible value:

<port range> : 1 to 26

<sec> : 1-65535, default is 30

Example:

FE2262 (802.1x)# set suppTimeout 2 30

set txPeriod

Syntax:

set txPeriod <port-range> <sec>

Description:

A timer used by the Authenticator PAE state machine to determine when an EAPOL PDU is to be transmitted.

Argument:

<port range> : syntax 1,5-7, available from 1 to 26

<sec> : timer, range 1-65535

Possible value:

<port range> : 1 to 26

<sec> : 1-65535, default is 30

Example:

166

FE2262 (802.1x)# set txPeriod 2 30

show mode

Syntax:

show mode

Description:

To display the mode of each port.

Argument:

None.

Possible value:

None.

Example:

FE2262(802.1x)# show mode

```
Port      Mode
=====  =====
 1       Di sable
 2       Mul ti -host
 3       Di sable
 4       Di sable
 5       Di sable
 6       Di sable
          :
          :
          :
```

show parameter

Syntax:

show parameter

Description:

To display the parameter settings of each port.

Argument:

None.

Possible value:

None.

Example:

FE2262(802.1x)# show parameter

```
port 1) port control : Auto
      reAuthMax      : 2
      txPeriod       : 30
      Quiet Period   : 60
      reAuthEnabled  : ON
      reAuthPeriod   : 3600
      max. Request   : 2
      suppTimeout    : 30
      serverTimeout  : 30
          :
          :
          :
```

show security

Syntax:

show security

Description:

To display the authentication status of each port.

Argument:

None.

Possible value:

None.

Example:

FE2262 (802.1x)# show security

Port	Mode	Status
1	Di sable	
2	Mul ti -host	Unauthori zed
3	Di sable	
4	Di sable	
5	Di sable	
6	Di sable	
	:	
	:	
	:	

show state

Syntax:

show state

Description:

To display the Radius server configuration.

Argument:

None.

Possible value:

None.

Example:

FE2262 (802.1x)# show state

Radius Server: 192.168.1.115

Port Number : 1812

Secret Key : Wi nRadi us

■ account

add

Syntax:

add <name>

Description:

To create a new guest user. When you create a new guest user, you must type in password and confirm password.

Argument:

<name> : new account name

Possible value:

<name> : A string must be at least 5 character.

Example:

FEL2SW-26(account)# add aaaaa

Password:

Confirm Password:

FEL2SW-26(account)#

del

Syntax:

del <name>

Description:

To delete an existing account.

Argument:

<name> : existing user account

Possible value:

None.

Example:

FEL2SW-26(account)# del aaaaa

Account aaaaa deleted

modify

Syntax:

modify <name>

Description:

To change the username and password of an existing account.

Argument:

<name> : existing user account

Possible value:

None.

Example:

```
FEL2SW-26(account)# modify aaaaa
username/password: the length is from 5 to 15.
Current username (aaaaa):bbbb
New password:
Confirm password:
Username changed successfully.
Password changed successfully.
```

show

Syntax:

show

Description:

To show system account, including account name and identity.

Argument:

None.

Possible value:

None.

Example:

```
FEL2SW-26(account)# show
```

Account Name	Identity
admin	Administrator
guest	guest
bbbb	guest

■ alarm

<<email>>

del mail-address

Syntax:

del mail-address <#>

Description:

To remove the e-mail address.

Argument:

<#>: email address number, range: 1 to 6

Possible value:

<#>: 1 to 6

Example:

FEL2SW-26(alarm-email)# del mail-address 2

del server-user

Syntax:

del server-user

Description:

To remove the server, user account and password.

Argument:

None.

Possible value:

None.

Example:

FEL2SW-26(alarm-email)# del server-user

set mail-address

Syntax:

set mail-address <#> <mail address>

Description:

To set up the email address.

Argument:

<#> : email address number, range: 1 to 6

<mail address> : email address

Possible value:

<#>: 1 to 6

Example:

FEL2SW-26(alarm-email)# set mail-address 1 abc@mail.abc.com

set server

Syntax:

set server <ip>

Description:

To set up the IP address of the email server.

Argument:

<ip>:email server ip address or domain name

Possible value:

None.

Example:

FEL2SW-26(alarm-email)# set server 192.168.1.6

set user

Syntax:

set user <username>

Description:

To set up the account of the email server.

Argument:

<username>: email server account

Possible value:

None.

Example:

FEL2SW-26(alarm-email)# set user event@gmail.com

show

Syntax:

show

Description:

To display the configuration of e-mail trap event.

Argument:

None.

Possible value:

None.

Example:

FEL2SW-26(alarm-email)# show
Mail Server : 192.168.1.6
Username : admin
Password : *****
Email Address 1: abc@mail.abc.com
Email Address 2:
Email Address 3:
Email Address 4:
Email Address 5:
Email Address 6:

<<events>>

del all

Syntax:

del all <range>

Description:

To disable email, sms and trap of events.

Argument:

<range>:del the range of email, sms and trap of events, syntax 1,5-7

Possible value:

<range>: 1~21

Example:

FEL2SW-26(alarm-events)# del all 1-3

del email

Syntax:

del email <range>

Description:

To disable the email of the events.

Argument:

<range>:del the range of email, syntax 1,5-7

Possible value:

<range>: 1~21

Example:

FEL2SW-26(alarm-events)# del email 1-3

del sms

Syntax:

del sms <range>

Description:

To disable the sms of the events.

Argument:

<range>:del the range of sms, syntax 1,5-7

Possible value:

<range>: 1~21

Example:

FEL2SW-26(alarm-events)# del sms 1-3

del trap

Syntax:

del trap <range>

Description:

To disable the trap of the events.

Argument:

<range>:del the range of trap, syntax 1,5-7

Possible value:

<range>: 1~21

Example:

FEL2SW-26(alarm-events)# del trap 1-3

set all

Syntax:

set all <range>

Description:

To enable email, sms and trap of events.

Argument:

<range>:set the range of email, sms and trap of events, syntax 1,5-7

Possible value:

<range>: 1~21

Example:

FEL2SW-26(alarm-events)# set all 1-3

set email

Syntax:

set email <range>

Description:

To enable the email of the events.

Argument:

<range>:set the range of email, syntax 1,5-7

Possible value:

<range>: 1~21

Example:

FEL2SW-26(alarm-events)# set email 1-3

set sms

Syntax:

set sms <range>

Description:

To enable the sms of the events.

Argument:

<range>:set the range of sms, syntax 1,5-7

Possible value:

<range>: 1~21

Example:

FEL2SW-26(alarm-events)# set sms 1-3

set trap

Syntax:

set trap <range>

Description:

To enable the trap of the events.

Argument:

<range>:set the range of trap, syntax 1,5-7

Possible value:

<range>: 1~21

Example:

FEL2SW-26(alarm-events)# set trap 1-3

show

Syntax:

show

Description:

The Show here is used to display the configuration of alarm event.

Argument:

None.

Possible value:

None.

Example:

```
FEL2SW-26(alarm-events)# show
  Events                               Email SMS Trap
-----
 1 Cold Start                          v
 2 Warm Start                          v
 3 Link Down                            v
 4 Link Up                              v
 5 Authentication Failure              v
 6 User Login
 7 User Logout
 8 STP Topology Changed
 9 STP Disabled
10 STP Enabled
11 LACP Disabled
12 LACP Enabled
13 LACP Member Added
14 LACP Port Failure
15 GVRP Disabled
16 GVRP Enabled
17 Port-based Vlan Enabled
18 Tag-based Vlan Enabled
19 Module Inserted
20 Module Removed
21 Module Media Swapped
```

show (alarm)

Syntax:

show

Description:

The Show for alarm here is used to display the configuration of Trap, SMS or E-mail.

Argument:

None.

Possible value:

None.

Example:

FEL2SW-26 (alarm)# show email
FEL2SW-26 (alarm)# show events
FEL2SW-26 (alarm)# show sms

<<sms>>

del phone-number

Syntax:

del phone-number <#>

Description:

To delete sms phone number.

Argument:

<#>: mobile phone number, range: 1 to 6

Possible value:

<#>: 1 to 6

Example:

FEL2SW-26(alarm-sms)# del phone-number 3

del server-user

Syntax:

del server-user

Description:

To delete sms server, user account and password.

Argument:

None.

Possible value:

None.

Example:

FEL2SW-26(alarm-sms)# del server-user

set phone-number

Syntax:

set phone-number <#> <phone-number>

Description:

To add sms phone number.

Argument:

<#>: mobile phone number, range: 1 to 6

<phone-number>: phone number

Possible value:

<#>: 1 to 6

Example:

FEL2SW-26(al arm-sms)# set phone-number 1 0968777777

set server

Syntax:

set server <ip>

Description:

To set up the IP address of sms server.

Argument:

<ip>: SMS server ip address or domain name

Possible value:

None.

Example:

FEL2SW-26(al arm-sms)# set server 192.168.1.7

set user

Syntax:

set user <username>

Description:

To set up user account and password of sms server.

Argument:

<username>: SMS server account

Possible value:

None.

Example:

FEL2SW-26(al arm-sms)# set user ABC

show

Syntax:

show

Description:

To display the configuration of SMS trap event.

Argument:

None.

Possible value:

None.

Example:

```
FEL2SW-26(al arm-sms)# show
SMS Server      : 192.168.1.7
Username        : ABC
Password        : *****
Mobile Phone 1: 096877777
Mobile Phone 2:
Mobile Phone 3:
Mobile Phone 4:
Mobile Phone 5:
Mobile Phone 6:
```

■ autologout

autologout

Syntax:

autologout <time>

Description:

To set up the timer of autologout.

Argument:

<time>: range 1 to 3600 seconds, 0 for autologout off, current setting is 180 seconds.

Possible value:

< time >: 0,1-3600

Example:

FEL2SW-26 # autologout 3600
Set autologout time to 3600 seconds

■ bandwidth

set egress-rate

Syntax:

set egress-rate <range> <data_rate>

Description:

To set up the egress-rate of the ports.

Argument:

<range>:syntax 1,5-7, available from 1 to 26

<data_rate>: 66-1024000(Kb).

port 1-24: 66-102400(Kb); port 25-26: 66-1024000(Kb)

Possible value:

<range>: 1 to 26

<data_rate>: 66-102400(Kb) for port 1-24; 66-1024000(Kb) for port 25-26

Example:

FEL2SW-26 (bandwidth)# set egress-rate 1-16 299

set ingress-rate

Syntax:

set ingress-rate <range> <data_rate>

Description:

To set up the ingress-rate of the ports.

Argument:

<range>:syntax 1,5-7, available from 1 to 26

<data_rate>: 66-1024000(Kb).

port 1-24: 66-102400(Kb); port 25-26: 66-1024000(Kb)

Possible value:

<range>: 1 to 26

<data_rate>: 66-102400(Kb) for port 1-24; 66-1024000(Kb) for port 25-26

Example:

FEL2SW-26 (bandwidth)# set ingress-rate 1-16 100

180

set storm-rate

Syntax:

set storm-rate <range> <data_rate>

Description:

To set up the storm-rate of the ports.

Argument:

<range>:syntax: 1,3-5, available from 1 to 5

1: Disable 2: Broadcast Storm Control

3: Multicast Storm Control

4: Unknown Unicast Storm Control

5: Broadcast, Multicast, Unknown Unicast Storm Control

<data_rate>: 1-100. The value must be the integer.

The value 100 disables broadcast storm control.

Possible value:

<range>: 1 to 5

<data_rate>: 1-100.

Example:

FEL2SW-26(bandwidth)# set storm-rate 2 99

show

Syntax:

show

Description:

To display all current settings of the bandwidth.

Argument:

None

Possible value:

None

Example:

FEL2SW-26(bandwidth)# show

Port	Ingress Rate(Kb)	Egress Rate(Kb)
1	102400	102400
2	102400	102400
3	102400	102400
	:	
	:	
23	102400	102400
24	102400	102400
25	1024000	1024000
26	1024000	1024000

Broadcast Storm Control

Type: Disable

Rate: 100 %

■ config-file

export start

Syntax:

export start

Description:

To run the export start function.

Argument:

None.

Possible value:

None.

Example:

FEL2SW-26 (config-file)# export start
Export successful.

export user-conf

Syntax:

export user-conf

Description:

To run the export user-conf function.

Argument:

None.

Possible value:

None.

Example:

FEL2SW-26 (config-file)# export user-conf
Export successful.

import start

Syntax:

import start

Description:

To run the import start function.

Argument:

None.

Possible value:

None.

Example:

FEL2SW-26 (config-file)# import start
Import successful.

import user-conf

Syntax:

import user-conf

Description:

To run the import user-conf function.

Argument:

None.

Possible value:

None.

Example:

FEL2SW-26 (config-file)# import user-conf
Import successful.

set export-path

Syntax:

set export-path <filepath>

Description:

To set up the file path and filename that user would like to export.

Argument:

<filepath>:filepath and filename

Possible value:

<filepath>:filepath and filename

Example:

FEL2SW-26 (config-file)# set export-path log/21511.txt

set import-path

Syntax:

set import-path <filepath>

Description:

To set up the filepath and filename that user would like to import.

Argument:

<filepath>:filepath and filename

Possible value:

<filepath>:filepath and filename

Example:

FEL2SW-26 (config-file)# set import-path log/21511.txt

show

Syntax:

show

Description:

To display the information of the config file.

Argument:

None.

Possible value:

None.

Example:

```
FEL2SW-26(config-file)# show
TFTP Server IP Address: 192.168.3.111
Export Path and Filename: log/21511.txt
Import Path and Filename: log/21511.txt
```

■ **dhcp-boot**

set dhcp-boot

Syntax:

set <sec>

Description:

To set up the delay time for DHCP Boot.

Argument:

<sec>:range syntax: 0, 1-30. The value "0" is to disable dhcp-boot delay

Possible value:

<sec>:0-30

Example:

```
FEL2SW-26 (dhcp-boot)# set 30
```

show

Syntax:

show

Description:

To display the status of DHCP Boot.

Argument:

None.

Possible value:

None.

Example:

```
FEL2SW-26(dhcp-boot)# show
DHCP Boot : Enable
Second    : 30
FEL2SW-26(dhcp-boot)#
```

■ diag

diag

Syntax:

diag

Description:

Diag is used to test whether EEPROM, UART, DRAM and Flash is normal or not.

Argument:

None.

Possible value:

None.

Example:

```
FEL2SW-26 (di ag)# di ag
EEPROM Test : OK
UART Test   : OK
DRAM Test   : OK
Flash Test  : OK
```

Loopback

Syntax:

loopback

Description:

For Internal/External Loopback Test.

Argument:

None.

Possible value:

None.

Example:

```
FEL2SW-26(di ag)# l oopback
Internal Loopback Test : OK
```

```
External Loopback Test : Port 1 2 3 4 5 6 7 8 9 10 11 12 13 14 15 16 17 18
19 20 21 22 23 24 25 26 Fai l
```

ping

Syntax:

ping <ip>

Description:

To confirm that whether the remote end-station or switch itself is alive or not.

Argument:

<ip> : IP address or domain name

Possible value:

IP address, e.g. 192.168.2.65 or domain name, e.g. tw.yahoo.com

Example:

```
FEL2SW-26(di ag)# pi ng 192. 168. 1. 115
Gateway      : 192.168.1.253
```

185

192.168.1.115 is alive.

■ firmware

set upgrade-path

Syntax:

set upgrade-path <filepath>

Description:

To set up the image file that will be upgraded.

Argument:

<filepath>: upgrade file path and name

Possible value:

<filepath>: upgrade file path and name

Example:

FEL2SW-26 (firmware)# set upgrade-path FEL2SW26_v2.05.img

show

Syntax:

show

Description:

To display the information of tftp server and upgrade-path and file name.

Argument:

None.

Possible value:

None.

Example:

FEL2SW-26(firmware)# show
TFTP Server IP Address: 192.168.3.111
Path and Filename : FEL2SW26_v2.05.img

upgrade

Syntax:

upgrade

Description:

To run the software upgrade function.

Argument:

None.

Possible value:

None.

Example:

FEL2SW-26(firmware)# upgrade
Upgrading firmware ...

■ gvrp

disable

Syntax:

disable

Description:

To disable the gvrp function

Argument:

None.

Possible value:

None.

Example:

FEL2SW-26 (gvrp)# disable

enable

Syntax:

enable

Description:

To enable the gvrp function.

Argument:

None.

Possible value:

None.

Example:

FEL2SW-26 (gvrp)# enable

group

Syntax:

group <group number>

Description:

To enter any of gvrp group for changing gvrp group setting. You can change the applicant or registrar mode of existing gvrp group per port.

Argument:

<group number>: enter which gvrp group you had created, using value is vid.

Available range: 1 to 4094

Possible value:

<group number>: 1~4094

Example:

FEL2SW-26 (gvrp)# show group

GVRP group information

Current Dynamic Group Number: 1

VID Member Port

2 5

```
FEL2SW-26 (gvrp)# group 2
FEL2SW-26 (gvrp-group-2)# set applicant 1-6 non-participant
```

```
FEL2SW-26 (gvrp-group-2)# show
GVRP group VID: 2
```

```
Port Applicant Registrar
-----
1 Non-Participant Normal
2 Non-Participant Normal
3 Non-Participant Normal
4 Non-Participant Normal
5 Non-Participant Normal
6 Non-Participant Normal
7 Normal Normal
8 Normal Normal
12 Normal Normal
13 Normal Normal
:
:
23 Normal Normal
24 Normal Normal
25 Normal Normal
26 Normal Normal
```

```
FEL2SW-26 (gvrp-group-2)# set registrar 1-10 fixed
```

```
FEL2SW-26 (gvrp-group-2)# show
GVRP group VID: 2
```

```
Port Applicant Registrar
-----
1 Non-Participant Fixed
2 Non-Participant Fixed
3 Non-Participant Fixed
4 Non-Participant Fixed
5 Non-Participant Fixed
6 Non-Participant Fixed
7 Normal Fixed
8 Normal Fixed
9 Normal Fixed
10 Normal Fixed
17 Normal Normal
:
:
23 Normal Normal
24 Normal Normal
25 Normal Normal
26 Normal Normal
```

set applicant

Syntax:

set applicant <range> <normal|non-participant>

Description:

To set default applicant mode for each port.

Argument:

<range>: port range, syntax 1,5-7, available from 1 to 26

<normal>: set applicant as normal mode

<non-participant>: set applicant as non-participant mode

Possible value:

<range>: 1 to 26

<normal|non-participant>: normal or non-participant

Example:

FEL2SW-26 (gvrp)# set applicant 1-10 non-participant

set registrar

Syntax:

set registrar <range> <normal|fixed|forbidden>

Description:

To set default registrar mode for each port.

Argument:

<range>: port range, syntax 1,5-7, available from 1 to 26

<normal>: set registrar as normal mode

<fixed>: set registrar as fixed mode

<forbidden>: set registrar as forbidden mode

Possible value:

<range>: 1 to 26

<normal|fixed|forbidden>: normal or fixed or forbidden

Example:

FEL2SW-26 (gvrp)# set registrar 1-5 fixed

set restricted

Syntax:

set restricted <range> <enable|disable>

Description:

To set the restricted mode for each port.

Argument:

<range>: port range, syntax 1,5-7, available from 1 to 26

<enable>: set restricted as enabled

<disable>: set restricted as disabled

Possible value:

<range>: 1 to 26

<enable|disable>: enable or disable

Example:

```
FEL2SW-26 (gvrp)# set restricted 1-10 enable
```

```
FEL2SW-26 (gvrp)# show config
```

```
GVRP state: Enable
```

Port	Join Time	Leave Time	LeaveAll Time	Applicant	Registrar	Restricted
1	20	60	1000	Normal	Normal	Enable
2	20	60	1000	Normal	Normal	Enable
3	20	60	1000	Normal	Normal	Enable
4	20	60	1000	Normal	Normal	Enable
5	20	60	1000	Normal	Normal	Enable
6	20	60	1000	Normal	Normal	Enable
7	20	60	1000	Normal	Normal	Enable
8	20	60	1000	Normal	Normal	Enable
9	20	60	1000	Normal	Normal	Enable
10	20	60	1000	Normal	Normal	Enable
				:		
				:		
				:		
22	20	60	1000	Normal	Normal	Disable
23	20	60	1000	Normal	Normal	Disable
24	20	60	1000	Normal	Normal	Disable
25	20	60	1000	Normal	Normal	Disable
26	20	60	1000	Normal	Normal	Disable

set timer

Syntax:

set timer <range> <join> <leave> <leaveall>

Description:

To set gvrp join time, leave time, and leaveall time for each port.

Argument:

<range> : port range, syntax 1,5-7, available from 1 to 26

<join>: join timer, available from 20 to 100

<leave>: leave timer, available from 60 to 300

<leaveall>: leaveall timer, available from 1000 to 5000

Leave Time must equal double Join Time at least.

Possible value:

<range> : 1 to 26

<join>: 20 to 100

<leave>: 60 to 300

<leaveall>: 1000 to 5000

Example:

FEL2SW-26 (gvrp)# set timer 2-8 25 80 2000

show config

Syntax:

show config

Description:

To display the gvrp configuration.

Argument:

None.

Possible value:

None.

Example:

FEL2SW-26(gvrp)# show config

GVRP state: Disable

Port	Join Time	Leave Time	LeaveAll Time	Applicant	Registrar	Restricted
1	20	60	1000	Normal	Normal	Disable
2	20	60	1000	Normal	Normal	Disable
3	20	60	1000	Normal	Normal	Disable
4	20	60	1000	Normal	Normal	Disable
			:			
			:			
			:			
23	20	60	1000	Normal	Normal	Disable
24	20	60	1000	Normal	Normal	Disable
25	20	60	1000	Normal	Normal	Disable
26	20	60	1000	Normal	Normal	Disable

show counter

Syntax:

show counter <port>

Description:

To show counter of the port.

Argument:

<port>: port number, available from 1 to 26

Possible value:

<port>: 1 to 26

Example:

FEL2SW-26(gvrp)# show counter 2

GVRP Counter port: 2

Counter Name	Received	Transmitted
Total GVRP Packets	0	0
Invalid GVRP Packets	0	----
LeaveAll message	0	0
JoinEmpty message	0	0
JoinIn message	0	0
LeaveEmpty message	0	0
Empty message	0	0

show group

Syntax:

show group

Description:

To show the gvrp group.

Argument:

None.

Possible value:

None.

Example:

FEL2SW-26(gvrp)# show group

GVRP group information

Current Dynamic Group Number: 0

VID Member Port

■ hostname

hostname

Syntax:

hostname <name>

Description:

To set up the hostname of the switch.

Argument:

<name>: hostname, max. 40 characters.

Possible value:

<name>: hostname, max. 40 characters.

Example:

```
FEL2SW-26 # hostname Company
Company#
```

■ igmp-snooping

add allowed-group

Syntax:

add allowed-group <ip-multicast> <vid> <port-range>

Description:

To add the entry of allowed IP multicast group.

Argument:

<ip-multicast>: the range of IP multicast.

<vid>: vlan ID. 1-4094 or any.

<port-range>: syntax 1,5-7, available from 1 to 26

Possible value:

<ip-multicast>: ex: 224.1.1.1-225.2.3.3 or any

<vid>: 1-4094 or any

<port-range>: 1 to 26

Example:

```
FEL2SW-26(igmp-snooping)# add allowed-group 224.1.1.1-225.2.3.3 100 1-10
```

del allowed-group

Syntax:

del allowed-group <index>

Description:

To remove the entry of allowed IP multicast group

Argument:

<index>: the index of the allowed-group.

Possible value:

<index>: the index of the allowed-group.

Example:

```
FEL2SW-26(igmp-snooping)# del allowed-group 1
```

set mode

Syntax:

set mode <status>

Description:

To set up the mode of IGMP Snooping.

Argument:

<status>: 0:disable, 1:active, 2:passive

Possible value:

<status>: 0,1 or 2

Example:

FEL2SW-26(igmp-snooping)# set mode 2

show igmp-snooping

Syntax:

show igmp-snooping

Description:

To display IGMP snooping mode and allowed IP multicast entry.

Argument:

None.

Possible value:

None.

Example:

FEL2SW-26(igmp-snooping)# show igmp-snooping

Snoop Mode: Active

IP Multicast:

- 1) IP Address : 224.1.1.1
- VLAN ID : 0
- Member Port : 22

show multicast

Syntax:

show multicast

Description:

To display IP multicast table.

Argument:

None.

Possible value:

None.

Example:

FEL2SW-26(igmp-snooping)# show multicast

IP Multicast: None

■ IP

disable dhcp

Syntax:

disable dhcp

Description:

To disable the DHCP function of the system.

Argument:

None.

Possible value:

None.

Example:

FEL2SW-26(ip)# disable dhcp
DHCP is already stopped.

enable dhcp

Syntax:

enable dhcp <manual|auto>

Description:

To enable the system DHCP function and set DNS server via manual or auto mode.

Argument:

<manual|auto> : set DNS by using manual or auto mode.

Possible value:

<manual|auto> : manual or auto

Example:

FEL2SW-26(ip)# enable dhcp manual

set dns

Syntax:

set dns <ip>

Description:

To set the IP address of DNS server.

Argument:

<ip> : dns ip address

Possible value:

<ip> : 168.95.1.1

Example:

FEL2SW-26 (ip)# set dns 168.95.1.1

set ip

Syntax:

set ip <ip> <mask> <gateway>

Description:

To set the system IP address, subnet mask and gateway.

Argument:

<ip> : ip address

<mask> : subnet mask

<gateway> : default gateway

Possible value:

<ip> : 192.168.1.1 or others

<mask> : 255.255.255.0 or others

<gateway> : 192.168.1.253 or others

Example:

FEL2SW-26 (ip)# set ip 192.168.1.2 255.255.255.0 192.168.1.253

show

Syntax:

show

Description:

To display the system's DHCP function state, IP address, subnet mask, default gateway, DNS mode, DNS server IP address and current IP address.

Argument:

None.

Possible value:

None.

Example:

FEL2SW-26 (ip)# show

```
DHCP           : Di sable
IP Address     : 192.168.1.1
Current IP Address : 192.168.1.1
Subnet mask    : 255.255.255.0
Gateway       : 192.168.1.253
DNS Setting    : Manual
DNS Server     : 192.95.1.1
```

■ log

clear

Syntax:

clear

Description:

To clear the log data.

Argument:

None.

Possible value:

None.

Example:

FEL2SW-26 (log)# clear

disable auto-upload

Syntax:

disable auto-upload

Description:

To disable the auto-upload function.

Argument:

None.

Possible value:

None.

Example:

FEL2SW-26 (log)# disable auto-upload

enable auto-upload

Syntax:

enable auto-upload

Description:

To enable the auto-upload function.

Argument:

None.

Possible value:

None.

Example:

FEL2SW-26 (log)# enable auto-upload

■loop-detection (LD)

disable action

Syntax:

disable action

Description:

Disable LD and corresponding action. Disable the locked-port action when loop occurs.

Argument:

None.

Possible value:

None.

Example:

FEL2SW-26(loop-detection)# disable action

disable port

Syntax:

disable port <port range>

Description:

Disable LD and corresponding action. Disable LD per port.

Argument:

<port range>: The range of your setting disabled loop detection with ports.

Possible value:

<port range>: syntax: 1,5-7, available from 1 to 26

Example:

FEL2SW-26(loop-detection)# disable port 1,5,6

enable action

Syntax:

enable action

Description:

Enable LD and corresponding action. Enable the locked-port action when loop occurs.

Argument:

None.

Possible value:

None.

Example:

FEL2SW-26(loop-detection)# enable action

enable port

Syntax:

enable port <port range>

Description:

Enable LD and corresponding action. Enable LD per port.

Argument:

<port range>: The range of your setting enabled loop detection with ports.

Possible value:

<port range>: syntax: 1,5-7, available from 1 to 26

Example:

FEL2SW-26(loop-detection)# enable port 7-9

show

Syntax:

show

Description:

Show Loop Detection status

Argument:

None

Possible value:

None

Example:

FEL2SW-26(loop-detection)# show

Locked port action: Enable

Port Loop-detection Current-status

1 Disable Unlocked
2 Disable Unlocked
3 Disable Unlocked
4 Disable Unlocked
5 Disable Unlocked
6 Disable Unlocked
7 Enable Unlocked
8 Enable Unlocked
9 Enable Unlocked
10 Disable Unlocked
11 Disable Unlocked
12 Disable Unlocked
13 Disable Unlocked
14 Disable Unlocked
15 Disable Unlocked
16 Disable Unlocked
17 Disable Unlocked
18 Disable Unlocked
19 Disable Unlocked
20 Disable Unlocked
21 Disable Unlocked

...

200

show

Syntax:

show

Description:

To show a list of trap log events. When any of log events happens, it will be recorded and using show command in log function to query. Up to 120 log records are supported.

Argument:

None.

Possible value:

None.

Example:

FEL2SW-26 (log)# show

Tftp Server : 0.0.0.0

Auto Upload : Disable

- 1) Wed Apr 13 12:13:27 2005 Link Up [Port 1]
- 2) Wed Apr 13 12:13:26 2005 Link Down [Port 1]
- 3) Wed Apr 13 11:58:31 2005 Login [admin]
- 4) Wed Apr 13 11:19:45 2005 Login [admin]
- 5) Wed Apr 13 11:19:37 2005 Logout [admin]

upload

Syntax:

Upload

Description:

To upload log data through tftp.

Argument:

None.

Possible value:

None.

Example:

FEL2SW-26 (log)# upload

■ mac-table

<<alias>>

del

Syntax:

del <mac>

Description:

To delete the mac alias entry.

Argument:

<mac> : mac address, format: 00-02-03-04-05-06

Possible value:

<mac> : mac address

Example:

FEL2SW-26 (mac-table-alias)# del 00-44-33-44-55-44

set

Syntax:

set <mac> <alias>

Description:

To set up the mac alias entry.

Argument:

<mac> : mac address, format: 00-02-03-04-05-06

<alias> : mac alias name, max. 15 characters

Possible value:

<mac> : mac address

<alias> : max. 15 characters

Example:

FEL2SW-26 (mac-table-alias)# set 00-44-33-44-55-44 www

show

Syntax:

show

Description:

To display the mac alias entry.

Argument:

None.

Possible value:

None.

Example:

FEL2SW-26 (mac-table-alias)# show

MAC Alias List

	MAC Address	Alias
--	-------------	-------

1) 00-02-03-04-05-06 aaa

2) 00-33-03-04-05-06 ccc

<<information>>

search

Syntax:

search <port> <mac> <vid>

Description:

To look for the relative mac information in mac table.

Argument:

<port> : set up the range of the ports to search for,
syntax 1,5-7, available from 1 to 26

<mac> : mac address, format: 01-02-03-04-05-06, '?' can be used

<vid> : vlan id, from 1 to 4094; '?' as don't care, 0 as untagged

Possible value:

<port> : 1 to 26

<vid> : 0, 1 ~4094

Example:

FEL2SW-26(mac-table-information)# search 1-26 ??-??-??-??-??-?? ?

MAC Table List

Alias	MAC Address	Port	VID	State
-------	-------------	------	-----	-------

	00-40-c7-88-00-06	1	0	Dynamic
--	-------------------	---	---	---------

FEL2SW-26 (mac-table-information)#

show

Syntax:

show

Description:

To display all mac table information.

Argument:

None.

Possible value:

None.

Example:

FEL2SW-26 (mac-table-information)# show

MAC Table List

Alias	MAC Address	Port	VID	State
-------	-------------	------	-----	-------

ABC	00-40-c7-d6-00-01	1	2	Static Forwarding
-----	-------------------	---	---	-------------------

ABC123	00-40-c7-d6-00-02	1	3	Static Filtering
--------	-------------------	---	---	------------------

<<maintain>>

set aging

Syntax:

set aging <time>

Description:

To set up the age out time of dynamic learning mac.

Argument:

<time> : Mac table age out time between 10 and 1000000 seconds. The value "0" means to disable age out time

Possible value:

<time> : 10-1000000 seconds or 0

Example:

FEL2SW-26(mac-table-maintain)# set aging 300

set learning

Syntax:

set learning <port> <num>

Description:

To set up the maximum amount of MAC that each port can learn.

Argument:

<port> : port range, syntax 1,5-7, available from 1 to 24

<num>: MAC address numbers which can be dynamically learned
num range: between 0 to 8191; 0 for learning disabled

Possible value:

<port> : 1 to 24

<num>: 0 to 8191

Example:

FEL2SW-26 (mac-table-maintain)# set learning 5 100

show

Syntax:

show

Description:

To display the settings of MAC table age out time and the learning limit of each port.

Argument:

None.

Possible value:

None.

Example:

```
FEL2SW-26(mac-table-maintain)# show
Mac table age out time: 300 seconds
Port   Dynamically Learn Limit
```

```
-----
 1    8191
 2    8191
 3    8191
 4    8191
 5    8191
      :
      :
      :
21    8191
22    8191
23    8191
24    8191
25    8192
26    8192
```

<<static-mac>>

```
-----
add
```

Syntax:

```
add <mac> <vid> <queue> <rule> <port>
```

Description:

To add the static mac entry.

Argument:

<mac>: mac address, format: 01-02-03-04-05-06

<vid>: vlan id, from 1 to 4094

<queue>: which queue you want to set, from 0 to 3

<rule> : forwarding rule, from 0 to 2

0:static

1:drop destination address matches

2:drop source address matches

<port> : forwarded destination port, from 1 to 26

Possible value:

<vid>: 1 to 4094

<queue>: 0 to 3

<rule>: 0 to 2

<port>: 1 to 26

Example:

```
FEL2SW-26 (mac-table-static-mac)# add 00-22-44-55-66-77 1 0 0 6
```

del

Syntax:

del <mac>

Description:

To remove the static mac entry.

Argument:

<mac> : mac address, format: 00-02-03-04-05-06

Possible value:

<mac> : mac address

Example:

FEL2SW-26(mac-table-static-mac)# *del* 00-02-03-04-05-06

show

Syntax:

show

Description:

To display static mac entry.

Argument:

None.

Possible value:

None.

Example:

FEL2SW-26(mac-table-static-mac)# *show*

	MAC	VID	Queue	Forwarding Rule	Port
1)	00-40-C7-D6-00-01	200	2	Static with Destination Drop	2

■ management

add

Syntax:

Usage: set [<name> <value>] [<vid> <value>] [<ip> <value>] [<port> <value>]
[<type> <value>] <action> <value>

Synopsis: set name Mary vid 20 ip 192.168.1.1-192.168.1.90 port 2-5,8
type h,s action a

Synopsis: set name Mary vid 20 ip 192.168.1.1-192.168.1.90

Description:

To save the adding management policy records.

When you don't know how to set the management policy records, you can use this command as follows:

FEL2SW-26(management-add)# set

This command will show exhaustive operating explanation for setting the management policy records.

Argument:

[<name> <value>] ACL entry name.
[<vid> <value>] VLAN ID.
[<ip> <value>] IP range.
[<port> <value>] Incoming port.
[<type> <value>] Access type.
<action> <value> a(ccept) or d(eny).

Possible value:

[<name> <value>] No default and it must be set.
[<vid> <value>] The range is 1-4095 and can be set to any.
[<ip> <value>] For example, 192.168.1.90-192.168.1.90 or any.
[<port> <value>] For example, 1 or 1-8 or 1,3-5 or any
[<type> <value>] For example, h(ttp),s(nmp),t(elnet) or any.
<action> <value> No default and it must be set.

Example:

FEL2SW-26(management-add)# set name Mary vid 20 ip 192.168.1.1-
192.168.1.90 port 2-5,8 type h,s action a

FEL2SW-26(management-add)# show

```
#: 1
Name : Mary           VlanID : 20           IP : 192.168.1.1-192.168.1.90
Type : Http, SNMP    Action : Accept       Port : 2,3,4,5,8
```

delete

Syntax:

delete #

Description:

To delete a specific record or range.

Argument:

[#]: a specific or range management security entry(s)

Possible value:

None.

Example:

FEL2SW-26 (management)# show

```
#: 1
Name : Tom                VlanID : 2                IP : 192.168.1.30-192.168.1.80
Type : SNMP              Action : Deny            Port : 1,2
```

FEL2SW-26 (management)# delete 1

FEL2SW-26 (management)# show

Security rule list is empty now

edit [#]: the specific management policy entry. Available range: 1 to 65536.

Syntax:

Usage: set [<name> <value>] [<vid> <value>] [<ip> <value>] [<port> <value>]
[<type> <value>] [<action> <value>]

Synopsis: set name Mary vid 20 ip 192.168.1.1-192.168.1.90 port 2-5,8
type h,s action a

Synopsis: set name Mary vid 20 ip 192.168.1.1-192.168.1.90

Description:

To edit management policy record.

Argument:

[<name> <value>]	ACL entry name.
[<vid> <value>]	VLAN ID.
[<ip> <value>]	IP Range.
[<port> <value>]	Incoming port.
[<type> <value>]	Access type.
<action> <value>	a(ccept) or d(eny).

Possible value:

[<name> <value>]	No default and it must be set.
[<vid> <value>]	The range is 1-4095 and can be set to any.
[<ip> <value>]	For example, 192.168.1.90-192.168.1.90 or any
[<port> <value>]	For example, 1 or 1-8 or 1,3-5 or any
[<type> <value>]	For example, h(ttp),s(nmp),t(elnet) or any
<action> <value>	No default and it must be set.

Example:

```
FEL2SW-26 (management)# edit 1
```

```
FEL2SW-26 (management-edit-1)# set name Tom vid 2 ip 192.168.1.30-  
192.168.1.80 port 1-2 type s action d
```

```
FEL2SW-26 (management-edit-1)# show
```

```
#: 1  
Name : Tom           VlanID : 2           IP : 192.168.1.30-192.168.1.80  
Type : SNMP         Action : Deny        Port : 1,2
```

show

Syntax:

show

Description:

To show the specific management policy record.

Argument:

None.

Possible value:

None.

Example:

```
FEL2SW-26 (management)# show
```

```
#: 1  
Name : Tom           VlanID : 2           IP : 192.168.1.30-192.168.1.80  
Type : SNMP         Action : Deny        Port : 1,2
```

■ port

clear counter

Syntax:

clear counter

Description:

To clear all ports' counter (include simple and detail port counter) information.

Argument:

None.

Possible value:

None.

Example:

FEL2SW-26 (port)# clear counter

disable state

Syntax:

disable state <range>

Description:

To disable the communication capability of the port.

Argument:

<range>: port range, syntax 1,5-7, available from 1 to 26

Possible value:

<range>: 1 ~ 26

Example:

FEL2SW-26 (port)# disable state 12

enable state

Syntax:

enable state <range>

Description:

To enable the communication capability of the port.

Argument:

<range>: port range, syntax 1,5-7, available from 1 to 26

Possible value:

<range>: 1 ~ 26

Example:

FEL2SW-26 (port)# enable state 3-10

210

set description

Syntax:

set description <range> <description>

Description:

To set up the human readable description of all ports.

Argument:

range syntax: 1,5-7, available from 1 to 26

description: set its port description, max 47 characters

Possible value:

<range>: 1 to 26

Example:

FEL2SW-26(port)# set description 1-26 testport

set flow-control

Syntax:

set flow-control <range> <symmetric|asymmetric>

Description:

To set up the flow control function of all ports.

Argument:

<range>:port range, syntax 1,5-7, available from 1 to 26

<symmetric>: set its flow control as symmetric

<asymmetric>: set its flow control as asymmetric

Possible value:

<range>: 1 to 26

<symmetric|asymmetric>:symmetric or asymmetric

Example:

FEL2SW-26 (port)# set flow-control 3-6 symmetric

set speed-duplex

Syntax:

set speed-duplex <range> <auto>[<10|100|1000> <half|full>]

Description:

To set up the speed and duplex of all ports.

Argument:

<range>:port range, syntax 1,5-7, available from 1 to 26

<port-speed>:

auto : set auto-negotiation mode

10 : set speed to 10M

100 : set speed to 100M

1000 : set speed to 1000M

<port-duplex> :

half : set to half duplex

full : set to full duplex

Possible value:

<range>: 1 to 26

<port-speed> : auto, 10, 100, 1000

<port-duplex> : full, half

Example:

FEL2SW-26 (port)# set speed-duplex 8 100 full

show conf

Syntax:

show conf

Description:

To display the each port's configuration about state, speed-duplex and flow control.

Argument:

None.

Possible value:

None.

Example:

FEL2SW-26 (port)# show conf

show description

Syntax:

show description

Description:

To display the each port's description.

Argument:

None.

Possible value:

None.

Example:

FEL2SW-26 (port)# show description

show detail-counter

Syntax:

show detail-counter <#>

Description:

To display the detailed counting number of each port's traffic.

Argument:

<#> : port, available from 1 to 26

Possible value:

<#>:1 ~ 26

Example:

FEL2SW-26 (port)# show detail-counter 6

show media

Syntax:

show media <port>

Description:

To display the module 25 or 26 information.

Argument:

<port>: available 25, 26

Possible value:

<port>: 25, 26

Example:

FEL2SW-26 (port)# show media 25

212

Port 25 Fiber Media Information

```
-----  
Connector Type       : SFP - LC  
Fiber Type           : Multi-mode (MM)  
Tx Central Wavelength : 850  
Baud Rate            : 1G  
Vendor OUI          : 00:40:c7  
Vendor Name         : APAC Opto  
Vendor PN           : KM28-C3S-TC-N  
Vendor Rev          : 0000  
Vendor SN           : 5425011140  
Date Code           : 050530  
Temperature         : none  
Vcc                 : none  
Mon1 (Bias) mA     : none  
Mon2 (TX PWR)      : none  
Mon3 (RX PWR)      : none
```

```
-----  
show simple-counter
```

Syntax:

```
show simple-counter
```

Description:

To display the summary counting of each port's traffic.

Argument:

None.

Possible value:

None.

Example:

```
FEL2SW-26 (port)# show simple-counter
```

```
-----  
show status
```

Syntax:

```
show status
```

Description:

To display the port's current status.

Argument:

None.

Possible value:

None.

Example:

```
FEL2SW-26(port)# show status
```

```
Port Media Link State Auto Nego. Speed/Duplex Rx Pause Tx Pause  
-----  
 1 TP Down Enable Enable ----/---- ----  
 2 TP Down Enable Enable ----/---- ----  
 3 TP Down Enable Enable ----/---- ----  
 4 TP Down Enable Enable ----/---- ----
```

213

5	TP	Up	Enable	Enable	100M/Full	ON	ON
6	TP	Down	Enable	Enable	----/----	----	----
7	TP	Down	Enable	Enable	----/----	----	----
				:			
				:			
				:			
24	TP	Down	Enable	Enable	----/----	----	----
25	TP	Down	Enable	Enable	----/----	----	----
26	TP	Down	Enable	Enable	----/----	----	----

■ qos

disable 1p

Syntax:

disable 1p

Description:

To disable 802.1p qos.

Argument:

None.

Possible value:

None.

Example:

FEL2SW-26 (qos)# disable 1p

disable dscp

Syntax:

disable dscp

Description:

To disable IP DSCP qos.

Argument:

None.

Possible value:

None.

Example:

FEL2SW-26 (qos)# disable dscp

disable qos

Syntax:

disable qos

Description:

To disable qos function.

Argument:

None.

Possible value:

None.

Example:

FEL2SW-26 (qos)# disable qos

disable tos

Syntax:

disable tos

Description:

To disable IP TOS qos.

Argument:

None.

Possible value:

None.

Example:

FEL2SW-26 (qos)# disable tos

enable 1p

Syntax:

enable 1p

Description:

To enable 802.1p qos.

Argument:

None.

Possible value:

None.

Example:

FEL2SW-26 (qos)# enable 1p

enable dscp

Syntax:

enable dscp

Description:

To enable IP DSCP qos.

Argument:

None.

Possible value:

None.

Example:

FEL2SW-26 (qos)# enable dscp

enable qos

Syntax:

enable qos

Description:

To enable qos function.

Argument:

None.

Possible value:

None.

Example:

FEL2SW-26 (qos)# *enable qos*

enable tos

Syntax:

enable tos

Description:

To enable IP TOS qos.

Argument:

None.

Possible value:

None.

Example:

FEL2SW-26 (qos)# *enable tos*

set dscp

Syntax:

set dscp [<q0><priority>] [<q1><priority>] [<q2><priority>] [<q3><priority>]

Description:

To set IP DSCP qos weighting for 4 queues.

Argument:

<q>: queue level, q0: queue 0; q1: queue 1; q2: queue 2; q3: queue 3.

<priority>: priority level. One queue has been assigned 2 different priorities.

You don't need to use all of queue, but must assign queue in order.

Syntax: 1,2 or 2,5-7, available from 0 to 63.

Possible value:

<priority>: 0 to 63

Example:

FEL2SW-26 (qos)# *set dscp* q0 2 q1 2 q2 2 q3 3

set pri-tag

Syntax:

set pri-tag [<q0><priority>] [<q1><priority>] [<q2><priority>] [<q3><priority>]

Description:

To set 802.1p qos weighting for 4 queues.

Argument:

<q>: queue level, q0: queue 0; q1: queue 1; q2: queue 2; q3: queue 3.
<priority>: priority level. One queue has been assigned 2 different priorities.
You don't need to use all of queues, but must assign queues in order.
Syntax: 1,2 or 2,5-7, available from 0 to 7.

Possible value:

<priority>: 0 to 7.

Example:

FEL2SW-26 (qos)# set pri-tag q0 0 q1 2 q3 4

set sche

Syntax:

set sche <wrr|strict> <wrr_0> <wrr_1> <wrr_2> <wrr_3>

Description:

To set qos schedule and weight for 4 queues.

Argument:

<wrr> : scheduling weighted round robin method
<strict> : scheduling strict method.
<wrr_0 to 3>: weighted for every queue. Weighted range : 1-55.

Possible value:

<wrr|strict>: wrr or strict
<wrr_0 to 3>: 1-55.

Example:

FEL2SW-26 (qos)# set sche wrr 1 2 8 16

set tos

Syntax:

set tos <type_value> [<q0><priority>] [<q1><priority>] [<q2><priority>]
[<q3><priority>]

Description:

To set IP tos qos weighting for 4 queues.

Argument:

<type_value>: Delay Priority: 0;
Throughput Priority: 1;
Reliability Priority: 2;
Monetary Cost Priority: 3.
<q>: queue level, q0: queue 0; q1: queue 1; q2: queue 2; q3: queue 3.
<priority>: priority level. One queue has been assigned 2 different priorities.
You don't need to use all of queues, but must assign queues in order
(from low queue to high queue).
Syntax: 1,2 or 2,5-7, available from 0 to 7.

Possible value:

<type_value>: 0~3

<priority>: 0 to 7.

Example:

FEL2SW-26 (qos)# set tos 0 q0 1 q1 2 q2 4 q3 6

set vip

Syntax:

set vip <port_range> <mode>

Description:

To set vip port for strict priority.

Argument:

<port_range>: syntax 1,5-7, available from 1 to 26

<mode>: enable/disable vip port for each port. 1: enable. 0: disable.

Possible value:

<port_range>: 1 to 26

<mode>: 1 or 0

Example:

FEL2SW-26 (qos)# set vip 1-6 1

show dscp

Syntax:

show dscp

Description:

To show IP DSCP Qos configuration.

Argument:

None.

Possible value:

None.

Example:

FEL2SW-26 (qos)# show dscp

ip dffserv classification

=====

```
Global QoS mode: Enable QoS
                  Disable 802.1p Priority
                  Disable ip tos classification
                  Enable ip dffserv classification
Scheduling:      weighted round robin method.
weight:          wrr 0 = 1; wrr 1 = 1; wrr 2 = 8; wrr 3 = 16.
                  weighted range: 1-55.
P0-63:          Priority 0-63.
Default mode:   Queue0: P0-15; Queue1: P16-31; Queue2: P32-47; Queue3:
P48-63.
```

Di ffServ	Queue	Di ffServ	Queue	Di ffServ	Queue	Di ffServ	Queue
0	0	1	0	2	0	3	0
4	0	5	0	6	0	7	0
8	0	9	0	10	0	11	0
12	0	13	0	14	0	15	0
16	1	17	1	18	1	19	1
20	1	21	1	22	1	23	1
24	1	25	1	26	1	27	1
28	1	29	1	30	1	31	1
32	2	33	2	34	2	35	2
36	2	37	2	38	2	39	2
40	2	41	2	42	2	43	2
44	2	45	2	46	2	47	2
48	3	49	3	50	3	51	3
52	3	53	3	54	3	55	3
56	3	57	3	58	3	59	3
60	3	61	3	62	3	63	3

show port

Syntax:

show port

Description:

To show VIP port configuration.

Argument:

none

Possible value:

none

Example:

FEL2SW-26 (qos)# show port

Port Based Priority

```

=====
Global QoS mode: Enable QoS
                  Enable 802.1p Priority
                  Disable ip tos classification
                  Disable ip diffserv classification
  
```

Port No	Mode	Port No	Mode
1	Enable	2	Enable
3	Enable	4	Enable
5	Enable	6	Enable
:			
:			
23	Disable	24	Disable
25	Disable	26	Disable

show priority-tag

Syntax:

show priority-tag

Description:

To show 802.1p Qos configuration.

Argument:

None.

Possible value:

None.

Example:

FEL2SW-26 (qos)# show priority-tag

802.1p priority

=====

```
Global QoS mode: Enable QoS
                  Enable 802.1p Priority
                  Disable ip tos classification
                  Disable ip diffserv classification
Scheduling:      weighted round robin method.
weight:          wrp 0 = 1; wrp 1 = 1; wrp 2 = 8; wrp 3 = 16.
                  weighted range: 1-55.
P0-7:           Priority 0-7.
Default mode:   Queue0: P0,P1; Queue1: P2,P3; Queue2: P4,P5; Queue3:
P6,P7.
```

	P0	P1	P2	P3	P4	P5	P6	P7
Queue	0	0	1	1	2	2	3	3

show tos

Syntax:

show tos

Description:

To show IP tos Qos configuration.

Argument:

none

Possible value:

none

Example:

FEL2SW-26 (qos)# show tos
ip tos classification

=====

Global QoS mode: Enable QoS
 Disable 802.1p Priority
 Enable ip tos classification
 Disable ip diffserv classification
Scheduling: weighted round robin method.
weight: wrr 0 = 1; wrr 1 = 1; wrr 2 = 8; wrr 3 = 16.
 weighted range: 1-55.
P0-7: Priority 0-7.
Default mode: Queue0: P0,P1; Queue1: P2,P3; Queue2: P4,P5; Queue3:
P6,P7.

	P0	P1	P2	P3	P4	P5	P6	P7
Queue	0	0	1	1	2	2	3	3

TOS type: Delay Priority

	P0	P1	P2	P3	P4	P5	P6	P7
Queue	0	0	1	1	2	2	3	3

TOS type: Throughput Priority

	P0	P1	P2	P3	P4	P5	P6	P7
Queue	0	0	1	1	2	2	3	3

TOS type: Reliability Priority

	P0	P1	P2	P3	P4	P5	P6	P7
Queue	0	0	1	1	2	2	3	3

TOS type: Monetary Cost Priority

■ **reboot**

reboot

Syntax:

reboot

Description:

To reboot the system.

Argument:

None.

Possible value:

None.

Example:

FEL2SW-26 # reboot

■ **security**

<<isolated-group>>

set

Syntax:

set <port>

Description:

To set up the function of the isolated group.

Argument:

<port> : isolated port; range syntax: 1,5-7, available from 0 to 26
set 0 as disabled

Possible value:

<port>:0 to 26

Example:

FEL2SW-26 (security-isolated-group)# set 2,3,4

show

Syntax:

show

Description:

To display the current setting status of isolated group.

Argument:

None.

Possible value:

None.

Example:

FEL2SW-26 (security-isolated-group)# show
Isolated group:
2 3 4

<<mirror>>

disable

Syntax:

disable

Description:

To disable the function of mirror.

Argument:

None.

Possible value:

None.

Example:

FEL2SW-26 (security-mirror)# disable

enable

Syntax:

enable

Description:

To enable the function of mirror.

Argument:

None.

Possible value:

None.

Example:

FEL2SW-26 (security-mirror)# enable

set

Syntax:

set <spy> <ingress> <egress>

Description:

To set up the monitoring port and monitored ports of the mirror function. User can monitor the ports that receive or transmit the packets.

Argument:

<spy>: monitoring port

<ingress>: monitored ingress port; range syntax: 1,5-7, available from 0 to 26

<egress>: monitored egress port; range syntax: 1,5-7, available from 0 to 26

set ingress/egress to 0 as ingress/egress disabled

Possible value:

<ingress>: 0 to 26

<egress>: 0 to 26

Example:

FEL2SW-26 (security-mirror)# set 1 4 2-3

show

Syntax:

show

Description:

To display the current setting status of mirror.

Argument:

None.

Possible value:

None.

Example:

FEL2SW-26 (security-mirror)# *show*

Mirror:

Monitoring Port :1

Monitored Ingress :4

Monitored Egress :2 3

<<restricted-group>>

set

Syntax:

set <ingress> <egress>

Description:

To set up the function of restricted group.

Argument:

<ingress>: ingress group port; range syntax: 1,5-7, available from 0 to 26

<egress>: egress group port; range syntax: 1,5-7, available from 0 to 26

set ingress or egress to 0 as disabled

Possible value:

<ingress>: 0 to 26

<egress>: 0 to 26

Example:

FEL2SW-26 (security-restricted-group)# *set* 5 8-10

show

Syntax:

show

Description:

To display the current setting status of restricted group.

Argument:

None.

Possible value:

None

Example:

FEL2SW-26 (security-restricted-group)# *show*

Restricted group:

Ingress:5

Egress :8 9 10

224

■ snmp

disable

Syntax:

disable set-community
disable snmp

Description:

The Disable here is used for the de-activation of snmp or set-community.

Argument:

None.

Possible value:

None.

Example:

FEL2SW-26(snmp)# disable set-community
FEL2SW-26(snmp)# disable snmp

enable

Syntax:

enable set-community
enable snmp

Description:

The Enable here is used for the activation snmp or set-community.

Argument:

None.

Possible value:

None.

Example:

FEL2SW-26(snmp)# enable set-community
FEL2SW-26(snmp)# enable snmp

set

Syntax:

```
set get-community <community>  
set set-community <community>  
set trap <#> <ip> [port] [community]
```

Description:

The Set here is used for the setup of get-community, set-community, trap host ip, host port and trap- community.

Argument:

<#>: trap number, range: 1 to 6
<ip>: ip address or domain name
<port>: trap port
<community>: community name

Possible value:

<trap number> : 1 to 6
<port> :1~65535

Example:

```
FEL2SW-26 (snmp)# set get-community public  
FEL2SW-26 (snmp)# set set-community private  
FEL2SW-26 (snmp)# set trap 1 192.168.1.1 162 public
```

show

Syntax:

```
show
```

Description:

The Show here is to display the configuration of SNMP.

Argument:

None.

Possible value:

None.

Example:

```
FEL2SW-26 (snmp)# show  
SNMP          : Enable  
Get Community: public  
Set Community: private [Enable]  
Trap Host 1 IP Address: 192.168.1.1 Port: 162 Community: public  
Trap Host 2 IP Address: 0.0.0.0 Port: 162 Community: public  
Trap Host 3 IP Address: 0.0.0.0 Port: 162 Community: public  
Trap Host 4 IP Address: 0.0.0.0 Port: 162 Community: public  
Trap Host 5 IP Address: 0.0.0.0 Port: 162 Community: public  
Trap Host 6 IP Address: 0.0.0.0 Port: 162 Community: public
```

■ stp

MCheck

Syntax:

MCheck <range>

Description:

To force the port to transmit RST BPDUs.

Argument:

<range>: syntax 1,5-7, available from 1 to 26

Possible value:

<range>: 1 to 26

Example:

FEL2SW-26 (stp)# Mcheck 1-8

disable

Syntax:

disable

Description:

To disable the function of STP.

Argument:

None.

Possible value:

None.

Example:

FEL2SW-26 (stp)# disable

enable

Syntax:

enable

Description:

To enable the function of STP.

Argument:

None.

Possible value:

None.

Example:

FEL2SW-26 (stp)# enable

set config

Syntax:

set config <Bridge Priority> <Hello Time> <Max. Age> <Forward Delay>

Description:

To set up the parameters of STP.

Argument:

<Bridge Priority>: priority must be a multiple of 4096, available from 0 to 61440.

<Hello Time>: available from 1 to 10.

<Max. Age>: available from 6 to 40.

<Forward Delay>: available from 4 to 30.

Note: $2 * (\text{Forward Delay} - 1) \geq \text{Max Age}$

$\text{Max Age} \geq 2 * (\text{Hello Time} + 1)$

Possible value:

<Bridge Priority>: 0 to 61440.

<Hello Time>: 1 to 10.

<Max. Age>: 6 to 40.

<Forward Delay>: 4 to 30.

Example:

FEL2SW-26 (stp)# set config 61440 2 20 15

set port

Syntax:

set port <range> <path cost> <priority> <edge_port> <admin p2p>

Description:

To set up the port information of STP.

Argument:

<range>: syntax 1,5-7, available from 1 to 26

<path cost>: 0, 1-200000000. The value zero means auto status

<priority>: priority must be a multiple of 16, available from 0 to 240

<edge_port>: Admin Edge Port, <yes|no>

<admin p2p>: Admin point to point, <auto|true|false>

Possible value:

<range> : 1 to 26

<path cost>: 0, 1-200000000.

<priority> : 0 to 240

<edge_port> : yes / no

<admin p2p>: auto / true / false

Example:

FEL2SW-26 (stp)# set port 1-16 0 128 yes auto

set version

Syntax:

set version <stp|rstp>

Description:

To set up the version of STP.

Argument:

<stp|rstp>: stp / rstp

Possible value:

<stp|rstp>: stp / rstp

Example:

228

FEL2SW-26 (stp)# set version rstp

show config

Syntax:

show config

Description:

To display the STP configuration data.

Argument:

None.

Possible value:

None.

Example:

```
FEL2SW-26 (stp)# show config
STP State Configuration :
Spanning Tree Protocol   : Enabled
Bridge Priority (0-61440) : 61440
Hello Time (1-10 sec)   : 2
Max. Age (6-40 sec)     : 20
Forward Delay (4-30 sec) : 15
Force Version           : RSTP
```

show port

Syntax:

show port

Description:

To display the port information of STP.

Argument:

None.

Possible value:

None.

Example:

```
FEL2SW-26 (stp)# show port
Port Port Status Path Cost Priority Admin Edge Port Admin Point To Point
=====
  1 DISCARDING 2000000 128 Yes Auto
  2 DISCARDING 2000000 128 Yes Auto
  3 DISCARDING 2000000 128 Yes Auto
  4 DISCARDING 2000000 128 Yes Auto
  5 DISCARDING 2000000 128 Yes Auto
      :
      :
      :
 23 DISCARDING 200000 128 No Auto
 24 DISCARDING 200000 128 No Auto
 25 DISCARDING 20000 128 No Auto
 26 DISCARDING 20000 128 No Auto
```

show status

Syntax:

show status

Description:

To display of the status of STP.

Argument:

None.

Possible value:

None.

Example:

FEL2SW-26 (stp)# show status

STP Status :

STP State	: Enabled
Bridge ID	: 00: 40: C7: D8: 09: 1D
Bridge Priority	: 61440
Designated Root	: 00: 40: C7: D8: 09: 1D
Designated Priority	: 61440
Root Port	: 0
Root Path Cost	: 0
Current Max. Age(sec)	: 20
Current Forward Delay(sec)	: 15
Hello Time(sec)	: 2
STP Topology Change Count	: 0
Time Since Last Topology Change(sec)	: 848

■ system

set contact

Syntax:

set contact <contact>

Description:

To set the contact description of the switch.

Argument:

<contact>: string length up to 40 characters.

Possible value:

<contact>: A, b, c, d, ... ,z and 1, 2, 3, etc.

Example:

FEL2SW-26 (system)# set contact Taipei

set device-name

Syntax:

set device-name <device-name>

Description:

To set the device name description of the switch.

Argument:

<device-name>: string length up to 40 characters.

Possible value:

<device-name>: A, b, c, d, ... ,z and 1, 2, 3, etc.

Example:

FEL2SW-26 (system)# set device-name CR-2600

set location

Syntax:

set location <location>

Description:

To set the location description of the switch.

Argument:

<location>: string length up to 40 characters

Possible value:

<location>: A, b, c, d, ... ,z and 1, 2, 3, etc.

Example:

FEL2SW-26 (system)# set location Taipei

show

Syntax:

show

Description:

To display the basic information of the switch.

Argument:

None.

Possible value:

None.

Example:

FEL2SW-26(system)# *show*

```
Model Name          : FEL2SW-26
System Description   : 24 Fast Ethernet + 2 Gigabit L2 Managed
                    : Switch
Location            :
Contact             :
Device Name         : FEL2SW-26
System Up Time      : 0 Days 22 Hours 29 Mins 31 Secs
Current Time        : Wed Aug 31 14:03:33 2005
BIOS Version        : v1.03
Firmware Version    : v2.04
Hardware-Mechanical Version : v65535.65535-v0.04
Serial Number       : 123
Host IP Address     : 192.168.1.1
Host MAC Address    : 00-40-c7-08-00-00
Device Port         : UART * 1 TP *24 Fiber * 2
RAM Size            : 16 M
Flash Size          : 2 M
```

■ tftp

set server

Syntax:

set server <ip>

Description:

To set up the IP address of tftp server.

Argument:

<ip>: the IP address of tftp server

Possible value:

<ip>: tftp server IP

Example:

FEL2SW-26 (tftp)# set server 192.168.3.111

show

Syntax:

show

Description:

To display the information of tftp server.

Argument:

None

Possible value:

None

Example:

FEL2SW-26 (tftp)# show

Tftp Server : 192.168.3.111

■ time

set daylightsaving

Syntax:

set daylightsaving <hr> <MM/DD/HH> <mm/dd/hh>

Description:

To set up the daylight saving.

Argument:

<hr> : daylight saving hour, range: -5 to +5

<MM> : daylight saving start Month (01-12)

<DD> : daylight saving start Day (01-31)

<HH> : daylight saving start Hour (00-23)

<mm> : daylight saving end Month (01-12)

<dd> : daylight saving end Day (01-31)

<hh> : daylight saving end Hour (00-23)

Possible value:

<hr> : -5 to +5

<MM> : (01-12)

<DD> : (01-31)

<HH> : (00-23)

<mm> : (01-12)

<dd> : (01-31)

<hh> : (00-23)

Example:

FEL2SW-26 (time)# set daylightsaving 3 10/12/01 11/12/01

set manual

Syntax:

set manual <YYYY/MM/DD> <hh:mm:ss>

Description:

To set up the current time manually.

Argument:

<YYYY> : Year (2000-2036) <MM> : Month (01-12)

<DD> : Day (01-31) <hh> : Hour (00-23)

<mm> : Minute (00-59) <ss> : Second (00-59)

Possible value:

<YYYY> : (2000-2036) <MM> : (01-12)

<DD> : (01-31) <hh> : (00-23)

<mm> : (00-59) <ss> : (00-59)

Example:

FEL2SW-26 (time)# set manual 2005/04/21 16:18:50

set ntp

Syntax:

set ntp <ip> <timezone>

Description:

To set up the current time via NTP server.

Argument:

<ip>: ntp server ip address or domain name

<timezone>: time zone (GMT), range: -12 to +13

Possible value:

<timezone>: -12,-11...,0,1...,13

Example:

FEML2-SW26E(time)# set ntp clock.via.net 8

Synchronizing...(1)

Synchronization success

show

Syntax:

show

Description:

To show the time configuration, including "Current Time", "NTP Server", "Timezone", "Daylight Saving", "Daylight Saving Start" and "Daylight Saving End"

Argument:

None.

Possible value:

None.

Example:

FEL2SW-26(time)# show

Current Time : Wed Apr 21 06:16:22 2005

NTP Server : 209.81.9.7

Timezone : 8

Day light Saving : 4 Hours

Day light Saving Start: Mth: 2 Day: 20 Hour: 10

Day light Saving End : Mth: 3 Day: 20 Hour: 10

FEL2SW-26 (time)#

■ trunk

del trunk

Syntax:

del trunk <port-range>

Description:

To remove the trunk port.

Argument:

<port-range> : syntax 1,5-7, available from 1 to 26

Possible value:

<port-range> : 1 to 26

Example:

FEL2SW-26 (trunk)# del trunk 1

set hash

Syntax:

set hash <method>

Description:

To set up trunk hash method.

Argument:

<method>: lacp hash method

0: DA and SA

1: SA

2: DA

Note : This hash method applies to both LACP and static trunk.

Possible value:

<method>: 0~2

Example:

FEL2SW-26 (trunk)# set hash 2

set priority

Syntax:

set priority <range>

Description:

To set up the LACP system priority.

Argument:

<range>:available from 1 to 65535.

Possible value:

<range>:1 to 65535.

Example:

FEL2SW-26 (trunk)# set priority 33333

set trunk

Syntax:

set trunk <port-range> <method> <group> <active LACP>

Description:

To set up the status of trunk, including the group number and mode of the trunk as well as LACP mode.

Argument:

<port-range> : syntax 1,5-7, available from 1 to 26

<method>: <static|lacp>

static : adopt the static link aggregation

lacp : adopt the dynamic link aggregation- link aggregation control protocol

<group>: 1-3.

<active LACP>: <passive|active>

active : set the LACP to active mode

passive : set the LACP to passive mode

Possible value:

<port-range> : 1 to 26

<method>: static or lacp

<group>: 1-3.

<active LACP>: active or passive

Example:

FEL2SW-26 (trunk)# set trunk 2-5 lacp 1 active

show aggtr-view

Syntax:

show aggtr-view

Description:

To display the aggregator list.

Argument:

None.

Possible value:

None.

Example:

FEL2SW-26 (trunk)# show aggtr-view

```
Aggregator 1) Method: None
              Member Ports: 1
              Ready Ports: 1
```

```
Aggregator 2) Method: LACP
              Member Ports: 2
              Ready Ports:
                  :
                  :
                  :
```

show lacp-config

Syntax:

show lacp-config

Description:

To display the value of LACP Priority.

Argument:

None.

Possible value:

None.

Example:

FEL2SW-26 (trunk)# show lacp-config
LACP System Priority : 33333
Hash Method : DA

show lacp-detail

Syntax:

show lacp-detail <aggr>

Description:

To display the detailed information of the LACP trunk group.

Argument:

<aggr> : aggregator, available from 1 to 26

Possible value:

<aggr> : 1 to 26

Example:

FEL2SW-26 (trunk)# show lacp-detail 2

Aggregator 2 Information:

Actor			Partner	
System Priority	MAC Address		System Priority	MAC Address
32768	00-40-c7-e8-00-02		32768	00-00-00-00-00-00
Port	Key	Trunk Status	Port	Key
2	257	---	2	0

show status

Syntax:

show status

Description:

To display the aggregator status and the settings of each port.

Argument:

None.

Possible value:

None.

Example:

FEL2SW-26 (trunk)# show status

Trunk Port Setting				Trunk Port Status	
port	Method	Group	Active LACP	Aggtregator	Status
1	None	0	Active	1	Ready
2	LACP	1	Active	2	---
3	LACP	1	Active	3	---
4	LACP	1	Active	4	---
5	LACP	1	Active	5	---
6	None	0	Active	6	---
7	None	0	Active	7	---
8	None	0	Active	8	---
9	None	0	Active	9	---
10	None	0	Active	10	---
11	None	0	Active	11	---
12	None	0	Active	12	---
13	None	0	Active	13	---
14	None	0	Active	14	---
15	None	0	Active	15	---
16	None	0	Active	16	---
17	None	0	Active	17	---
18	None	0	Active	18	---
19	None	0	Active	19	---
20	None	0	Active	20	---
21	None	0	Active	21	---
22	None	0	Active	22	---
23	None	0	Active	23	---
24	None	0	Active	24	---
25	None	0	Active	25	---
26	None	0	Active	26	---

■ vlan

del port-group

Syntax:

del port-group <name>

Description:

To delete the port-based vlan group.

Argument:

<name>: port-vlan name

Possible value:

<name>: port-vlan name

Example:

FEL2SW-26 (vlan)# del port-group vlan-2

del tag-group

Syntax:

del tag-group <vid>

Description:

To delete the tag-based vlan group.

Argument:

<vid>: vlan ID, available from 1 to 4094

Possible value:

<vid>: 1 to 4094

Example:

FEL2SW-26 (vlan)# del tag-group 2

disable double-tag

Syntax:

disable double-tag

Description:

To disable double-tag.

Argument:

None.

Possible value:

None.

Example:

FEL2SW-26 (vlan)# disable double-tag

disable drop-untag

Syntax:

disable drop-untag <port_range>

Description:

To disable drop-untag.

Argument:

<port_range>: which port(s) you want not to drop untagged frames. Syntax: 1,5-7, available from 1 to 26

Possible value:

<port_range>: 1 to 26

Example:

FEL2SW-26 (vlan)# disable drop-untag 2,4,5-7

disable svl

Syntax:

disable svl

Description:

To enable Independent VLAN Learning.

Argument:

None.

Possible value:

None.

Example:

FEL2SW-26 (vlan)# disable svl

disable symmetric

Syntax:

disable symmetric

Description:

To Not drop frames from the non-member port.

Argument:

None.

Possible value:

None.

Example:

FEL2SW-26 (vlan)# disable symmetric

enable double-tag

Syntax:

enable double-tag

Description:

To enable double-tag.

Argument:

None.

Possible value:

None.

Example:

FEL2SW-26 (vlan)# enable double-tag

enable drop-untag

Syntax:

enable drop-untag <port_range>

Description:

To enable drop-untag.

Argument:

<port_range>: which port(s) you want to drop untagged frames. Syntax: 1,5-7, available from 1 to 26

Possible value:

<port_range>: 1 to 26

Example:

FEL2SW-26 (vlan)# enable drop-untag 2,4,5-7

enable svl

Syntax:

enable svl

Description:

To enable Shared VLAN Learning.

Argument:

None.

Possible value:

None.

Example:

FEL2SW-26 (vlan)# enable svl

enable symmetric

Syntax:

enable symmetric

Description:

To drop frames from the non-member port.

Argument:

None.

Possible value:

None.

Example:

FEL2SW-26 (vlan)# enable symmetric

set mgt-vlan

Syntax:

set mgt-vlan <state> [vid]

Description:

To assign a management vlan to prevent DoS attack.

Argument:

state: enable or disable this feature

vid : management vlan id

Possible value:

state: 0 for disable; 1 for enable

vid : 1 to 4094

Example:

FEL2SW-26(vlan)# set mgt-vlan 1 1

set mode

Syntax:

set mode <port|tag>

Description:

To switch vlan mode between port-based and tag-based modes.

Argument:

<port|tag>: port or tag

tag: set tag-based vlan

port: set port-based vlan

Possible value:

<port|tag>: port or tag

Example:

FEL2SW-26 (vlan)# set mode tag

set port-group

Syntax:

set port-group <name> <range>

Description:

To add or edit a port-based vlan group.

Argument:

243

<name>: port-vlan name
<range>: vlan group members, syntax: 1,5-7, available from 1 to 26

Possible value:

<range>: 1 to 26

Example:

FEL2SW-26 (vlan)# set port-group vlan-1 2-5,6-10

set pvid

Syntax:

set pvid <port_range> <pvid> <default_priority>

Description:

To set vlan PVID and port priority.

Argument:

<port_range>: which port(s) you want to set PVID(s). Syntax 1,5-7, available from 1 to 26

<pvid>: which PVID you want to set, available from 1 to 4094

<default_priority>: which priority you want to set, available from 0 to 7

Possible value:

<port_range>: 1 to 26

<pvid>: 1 to 4094

<default_priority>: 0 to 7

Example:

FEL2SW-26 (vlan)# set pvid 3,5,6-8 5 6

set tag-group

Syntax:

set tag-group <vid> <name> <member_range> <untag_range>

Description:

To add or edit the tag-based vlan group.

Argument:

<vid>: vlan id, from 1 to 4094

<name>: tag-vlan group name

<member_range>: member port; syntax: 1,5-7, available from 1 to 26

<untag_range>: untagged out port; syntax: 1,5-7, available from 0 to 26

set untag_range to 0 as none of the ports are force untagged

Possible value:

<vid>: 1 to 4094

<member_range>: 1 to 26

<untag_range>: 0 to 26

Example:

FEL2SW-26 (vlan)# set tag-group 2 vlan-2 2-5,6,15-13 0

show config

Syntax:

show config

Description:

To display the current vlan mode, Symmetric vlan, SVL and Double tag states.

Argument:

None.

Possible value:

None.

Example:

FEL2SW-26 (vlan)# show config

Current vlan mode: Tag-based vlan

Global setting:

Symmetric vlan : Disable (Asymmetric)

SVL : Disable (IVL)

Double tag : Disable

show group

Syntax:

show group

Description:

To display vlan mode and vlan group.

Argument:

None

Possible value:

None

Example:

FEL2SW-26 (vlan)# show group

Vlan mode is tag-based.

- 1) Name : default
VID : 1
Member: 1 2 3 4 5 6 7 8 9 10 11 12 13 14 15 16 17 18 19 20 21 22 23 24
25 26
Untag : 1 2 3 4 5 6 7 8 9 10 11 12 13 14 15 16 17 18 19 20 21 22 23 24
25 26
- 2) Name : VLAN-2
VID : 2
Member: 2 3 4 5 6 13 14 15
Untag :

show mgt-vlan

Syntax:

show mgt-vlan

245

Description:

To display management setting.

Argument:

None

Possible value:

None

Example:

```
FEL2SW-26(vlan)# show mgt-vlan
```

```
Management Vlan:
```

```
State : Disable
```

```
VID   : 1
```

```
-----  
show pvid
```

Syntax:

```
show pvid
```

Description:

To display pvid, priority and drop untag result.

Argument:

None

Possible value:

None

Example:

```
FEL2SW-26 (vlan)# show pvid
```

```
Port   PVID   Priority Drop Untag
```

```
-----  
1      1      0      Disable  
2      1      0      Disable  
3      5      6      Disable  
4      1      0      Disable  
5      5      6      Disable  
6      5      6      Disable  
7      5      6      Disable  
8      5      6      Disable  
9      1      0      Disable  
10     1      0      Disable  
11     1      0      Disable  
12     1      0      Disable  
13     1      0      Disable  
14     1      0      Disable  
15     1      0      Disable  
16     1      0      Disable  
17     1      0      Disable  
18     1      0      Disable  
19     1      0      Disable  
20     1      0      Disable  
21     1      0      Disable
```

■ VS

disable

Syntax:

disable

Description:

To disable the virtual stack.

Argument:

None.

Possible value:

None.

Example:

FEL2SW-26(vs)# di sabl e

enable

Syntax:

enable

Description:

To enable the virtual stack.

Argument:

None.

Possible value:

None.

Example:

FEL2SW-26 (vs)# enabl e

set gid

Syntax:

set gid <gid>

Description:

To set the group id.

Argument:

<gid>: group ID

Possible value:

<gid>: a-z,A-Z,0-9

Example:

FEL2SW-26 (vs)# set gid group1

set role

Syntax:

set role <master|slave>

Description:

To set role.

Argument:

<master|slave>: master: act as master, slave : act as slave

Possible value:

<master|slave>: master or slave

Example:

FEL2SW-26 (vs)# set role master

show

Syntax:

show

Description:

To display the configuration of the virtual stack.

Argument:

None.

Possible value:

None.

Example:

FEL2SW-26 (vs)# show

Virtual Stack Config:

State : Enable

Role : Master

Group ID : group1

5. Maintenance

5-1. Resolving No Link Condition

The possible causes for a no link LED status are as follows:

- The attached device is not powered on
- The cable may not be the correct type or is faulty
- The installed building premise cable is faulty
- The port may be faulty

5-2. Q&A

1. Computer A can connect to Computer B, but cannot connect to Computer C through the Managed Switch.
 - ✓ The network device of Computer C may fail to work. Please check the link/act status of Computer C on the LED indicator. Try another network device on this connection.
 - ✓ The network configuration of Computer C may be something wrong. Please verify the network configuration on Computer C.
2. The uplink connection function fails to work.
 - ✓ The connection ports on another must be connection ports. Please check if connection ports are used on that Managed Switch.
 - ✓ Please check the uplink setup of the Managed Switch to verify the uplink function is enabled.
3. The console interface cannot appear on the console port connection.
 - ✓ The COM port default parameters are [Baud Rate: 57600, Data Bits: 8, Parity Bits: None, Stop Bit: A, Flow Control: None]. Please check the COM port property in the terminal program. And if the parameters are changed, please set the COM configuration to the new setting.
 - ✓ Check the RS-232 cable is connected well on the console port of the Managed Switch and COM port of PC.
 - ✓ Check if the COM of the PC is enabled.
4. How to configure the Managed Switch?
 - ✓ The "Hyperterm" is the terminal program in Win95/98/NT. Users can also use any other terminal programs in Linux/Unix to configure the Managed Switch. Please refer to the user guide of that terminal program. But the COM port parameters (baud rate/ data bits/ parity bits/ flow control) must be the same as the setting of the console port of the Managed Switch.

Appendix A

Technical Specifications

Features

- The switch included 24-Port 10/100Mbps TP and 2-Port Gigabit Dual Media TP/SFP.
- Supports 24-port 10/100M TP ports with Nway and auto MDIX function.
- Supports on-line plug/unplug SFP transceiver modules.
- Non-blocking, store-and-forward and shared-memory L2 managed switch.
- Supports auto-negotiation for configuring speed, duplex mode.
- Supports 802.3x flow control for full-duplex ports.
- Supports collision-based and carrier-based backpressure for half-duplex ports.
- 256-entry Multicast Address table.
- Any ports can be in disable mode, force mode or auto-polling mode.
- Per-port ingress/egress rate control with 64K/128K/256K (up to 100Mbps) resolution.
- Supports Head of Line (HOL) blocking prevention.
- Supports broadcast storm filtering.
- 8K MAC addresses with automatic learning and aging.
- Auto-aging with programmable inter-age time.
- Supports 802.1p Class of Service with 4-level priority queuing.
- Supports port sniffer function with 3 modes:
(TX Monitor Mode, RX Monitor Mode and TX-RX pair Monitor Mode).
- Supports port-based VLAN, 802.1Q tag-based VLAN with 256 entries.
- Efficient self-learning and address recognition mechanism enables forwarding rate at wire speed.
- Web-based management provides the ability to completely manage the switch from any web browser.
- SNMP/Telnet interface delivers complete in-band management.
- Supports IEEE 802.1d Spanning Tree Protocol.
- Supports IEEE 802.1w Rapid Spanning Trees.
- Supports IEEE 802.1x port-based network access control.
- Supports IP Multicasting to implement IGMP Snooping function.
- Supports 802.3ad port trunking with flexible load distribution and failover function.
- Supports ingress port security mode for VLAN Tagged and Untagged frame process.
- Supports SNMP MIB2 and RMON sampling with sampled packet error indication.

Hardware Specifications

- **Standard Compliance:** IEEE802.3ab / 802.3z / 802.3u / 802.3x
802.3z and 802.3ab compliant Gigabit Ethernet ports
- **Transmission Mode:** 10/100Mbps support full or half duplex
1000Mbps support full duplex only
- **Transmission Speed:** 10/100/1000Mbps for TP
1000Mbps for Fiber
- **Full Forwarding/Filtering Packet Rate:** PPS (packets per second)

Forwarding Rate	Speed
1,488,000PPS	1000Mbps
148,800PPS	100Mbps
14,880PPS	10Mbps

- **MAC Address and Self-learning:** 8K address table entries,
256 VLAN table entries,
256 IP multicast table entries,
- **Buffer Memory:** Embedded 256KB packet buffers and 128KB control memory.
- **Flow Control:** IEEE802.3x compliant for full duplex
Backpressure flow control for half duplex
- **Cable and Maximum Length:**

TP	Cat. 5 UTP cable, up to 100m
1000Base-SX MMF	Multimode fiber, up to 550m
1000Base-LX SMF	Single Mode Fiber, up to 10/30/50Km
1000Base-X BiDi SMF	Single SMF, BiDi 20Km

▪ **Diagnostic LED:**

System LED :

Power
CPURUN
ACT (LEDSET)
FDX (LEDSET)
SPD (LEDSET)

Per Port LED:

10/100M TP Port 1 to 24

: LINK/ACT, FDX, SPD

1000M Fiber/TP Port 25,26

: LINK/ACT, FDX, SPD

▪ **Power Requirement** : AC Line

Voltage : 100~240 V

Frequency : 50~60 Hz

Consumption : 15W

▪ **Ambient Temperature** : 0° to 40°C

▪ **Humidity** : 5% to 90%

▪ **Dimensions** : 44(H) × 442(W) × 209(D) mm

▪ **Compliance** : FCC Part 15 Class A & CE Mark Approval

Management Software Specifications

System Configuration	Auto-negotiation support on 10/100Base-TX ports, Web browser or console interface can set transmission speed (10/100Mbps) and operation mode (Full/Half duplex) on each port, enable/disable any port, set VLAN group, set Trunk Connection.
Management Agent	SNMP support; MIB II, Bridge MIB, RMON MIB
Spanning Tree Algorithm	IEEE 802.1D
VLAN Function	Port-Base / 802.1Q-Tagged, allowed up to 256 active VLANs in one switch.
Trunk Function	Ports trunk connections allowed
IGMP	IP Multicast Filtering by passively snooping on the IGMP Query.
Bandwidth Control	Supports by-port Egress/Ingress rate control
Quality of Service (CoS)	Referred as Class of Service (CoS) by the IEEE 802.1P standard Four queues per port Packet transmission schedule using Weighted Round Robin (WRR) User-defined weight Classification of packet priority can be based on either a VLAN tag on packet or a user-defined port priority.
Port Security	Limit number of MAC addresses learned per port static MAC addresses stay in the filtering table.
Networking Protocol	Bridging : 802.1D Spanning Tree IP Multicast : IGMP Snooping IP Multicast Packet Filtering Maximum of 256 active VLANs and IP multicast sessions
Network Management	One RS-232 port as local control console Telnet remote control console SNMP agent : MIB-2 (RFC 1213) Bridge MIB (RFC 1493) RMON MIB (RFC 1757)-statistics Ethernet-like MIB (RFC 1643) Web browser support based on HTTP Server and CGI parser TFTP software-upgrade capability.

Note: Any specification is subject to change without notice.

Appendix B

Null Modem Cable Specifications

The DB-9 cable is used for connecting a terminal or terminal emulator to the Managed Switch's RS-232 port to access the command-line interface.

The table below shows the pin assignments for the DB-9 cable.

Function	Mnemonic	Pin
Carrier	CD	1
Receive Data	RXD	2
Transmit Data	TXD	3
Data Terminal Ready	DTR	4
Signal Ground	GND	5
Data Set Ready	DSR	6
Request To Send	RTS	7
Clear To Send	CTS	8

9 Pin Null Modem Cable

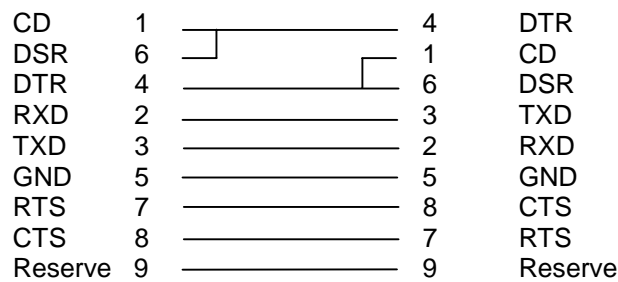

Free Manuals Download Website

<http://myh66.com>

<http://usermanuals.us>

<http://www.somanuals.com>

<http://www.4manuals.cc>

<http://www.manual-lib.com>

<http://www.404manual.com>

<http://www.luxmanual.com>

<http://aubethermostatmanual.com>

Golf course search by state

<http://golfingnear.com>

Email search by domain

<http://emailbydomain.com>

Auto manuals search

<http://auto.somanuals.com>

TV manuals search

<http://tv.somanuals.com>