

Einlochmischer für Lavabo und Bidet
Mitigeurs monotrou pour lavabo et bidet
Miscelatori monoforo per lavabo e bidet
Mezclador monoblock para lavabo y bidé
Faucets for lavatory and bidet

KWC MARLINO

KWC MARLINO

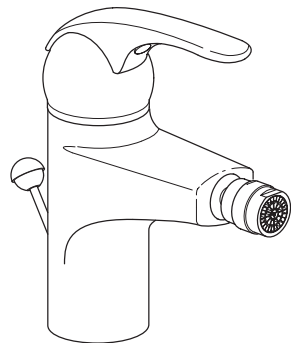

K.13.21.41

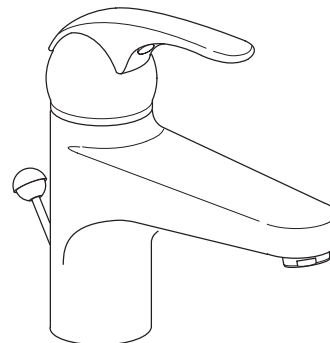

K.12.21.42/52

D Betriebsdaten:
 Idealer Betriebsdruck : 3 bar
 Max. Betriebsdruck : 5 bar
 Druckgleichheit empfohlen
 Ideale Wassertemperatur : 65 °C
 Max. Wassertemperatur : 90 °C

Achtung:
 Vor Montage die Leitungen gründlich durchspülen!

F Caractéristiques de fonctionnement
 Pression de service idéale : 3 bar
 Pression de service max. : 5 bar
 Egalité de pression recommandée
 Température idéale de l'eau : 65 °C
 Température max. de l'eau : 90 °C

Attention:
 Rincer à fond la tuyauterie avant le montage!

I Caratteristiche di funzionamento
 Pressione di servizio ideale : 3 bar
 Pressione di servizio mass. : 5 bar
 Si raccomanda pressioni uguali
 Temperatura acqua calda ideale : 65 °C
 Temperatura acqua calda mass. : 90 °C

Attenzione:
 Risciacquare bene le tubazioni prima del montaggio!

Sp Características de funcionamiento
 Presión ideal de servicio : 3 bar
 Presión máxima de servicio : 5 bar
 Se recomienda la igualdad de las presiones
 Temperatura ideal del agua : 65 °C
 Temperatura máxima del agua : 90 °C

Atención:
 Limpiar escrupulosamente las tuberías antes del montaje!

E Operating data
 Ideal operating pressure : 3 bar (45 PSI)
 Max. operating pressure : 5 bar (70 PSI)
 Equal pressures cold/warm recommended
 Ideal water temperature : 65 °C (149°F)
 Max. water temperature : 90 °C (194°F)

Attention:
 Before installation flush pipes thoroughly!

Recyclingpapier auf 100% Altpapierbasis.
 Papier de recyclage sur 100% bases de vieux papier.
 Riciclaggio della carta sulla base della carta straccia di 100%.
 Reciclaje del documento sobre base del papel usado del 100%.
 Recycling paper on 100% waste paper basis.

Schweiz, Suisse:
 KWC AG
 Hauptstrasse 57
 CH-5726 Unterkulm

Deutschland:
 KWC Deutschland GmbH
 Rigipsstraße 15
 D-71083 Herrenberg

France:
 Hansa France
 Rue Ettore Bugatti
 F-67038 Strasbourg-Cedex 2

Italia:
 KWC Italia S.r.l.
 Via A. Meucci 54
 I-36057 Arcugnano (VI)

Oesterreich:
 Hansa Austria GmbH
 Rottfeld 7
 A-5020 Salzburg

USA:
 KWC Faucets Inc.
 1770 Corporate Drive #580
 Norcross, Georgia 30093

Tel. : 062 768 67 77
 Fax : 062 768 61 69

Tel. : 07032 7809 0
 Fax : 07032 7809 30

Tel. : 03 88 78 88 08
 Fax : 03 88 76 55 32

Tel. : 0 44 496 48 20
 Fax : 0 44 496 47 35

Tel. : 0662 433 100
 Fax : 0662 433 100 20

Phone: 678 334 2121
 Fax: 678 334 2128

Befestigung
Fixation
Fissaggio
Fijación
Connection

1

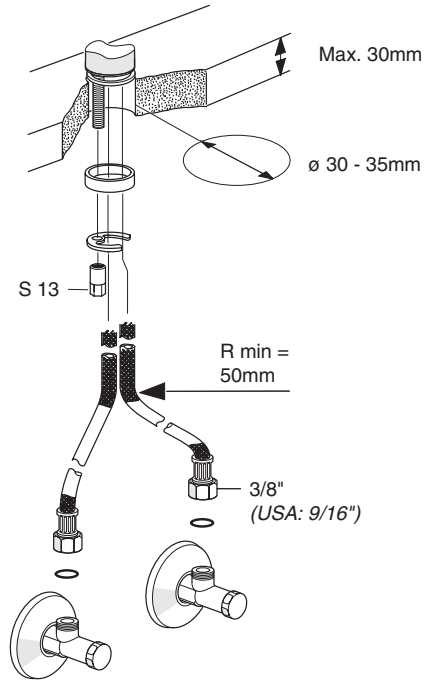

Mengenbegrenzung
Limitation du débit
Limitazione della portata
Limitación del caudal
Limitation of faucet flow rate

3

KWC MARLINO

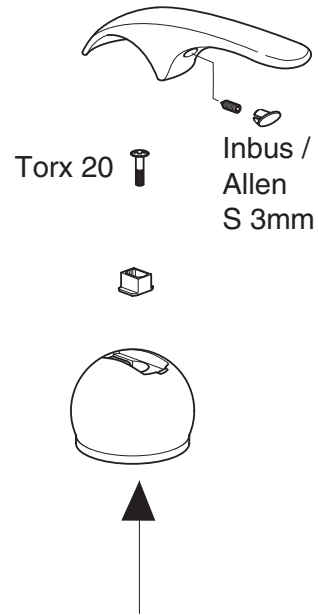

Inbetriebsetzung
Mise en service
Messa in funzione
Puesta en servicio
Taking in service

2

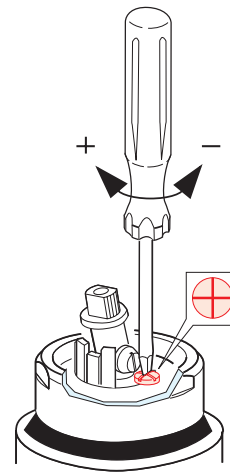
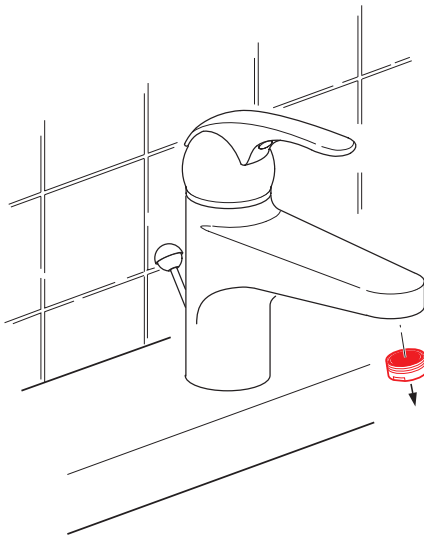

D - Mischer spülen.
 (zuerst Neoperl demonstieren).

Sp - Lavar el mezclador.
 (desmontar primero el aerador).

F - Rincer le mitigeur.
 (demonter d'abord le Neoperl).

E - Flush with cold and hot water.
 (First remove Neoperl aerator).

I - Sciacquare il miscelatore.
 (dopo aver smontato il Neoperl).



Höchsttemperaturbegrenzung
 Limitation de la température max.
 Limitazione della temperatura massima
 Limitación de la temperatura máxima
 Maximum temperature limitation

4

Austausch der Steuerpatrone
 Remplacement de la cartouche
 Sostituzione della cartuccia
 Recambio del cartucho de mando
 Replacing of the control cartridge

5

KWC MARLINO

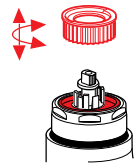
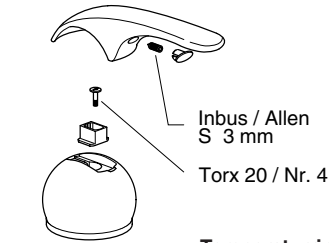

Temperurring
 Anneau de limitation
 Anello di limitazione
 Anillo de la temperatura
 Temperature ring

Max. Temperaturbereich :
 Plage de température max. :
 Campo di temperatura mass. :
 Gama de temperaturas máx. :
 Max. temperature range :

Begrenzter Temperaturbereich :
 Plage de température réduite :
 Campo di temperatura ridotto :
 Gama de temperaturas reducidas :
 Reduced temperature range :

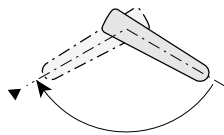
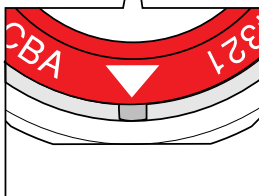
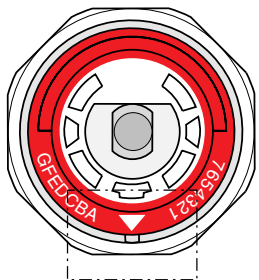

Pfeil auf Kerbe.
 Flèche sur encoche.
 Freccia su scanalatura.
 Flecha en la hendidura.
 Arrow on groove.

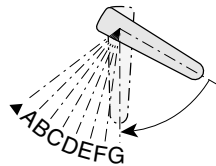
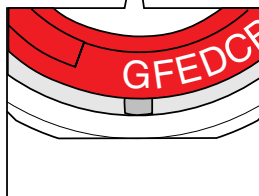
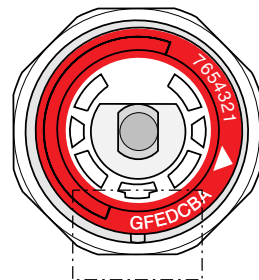

Position A - G.
 Position A - G.
 Position A - G.
 Posición A - G.
 Positions A - G.

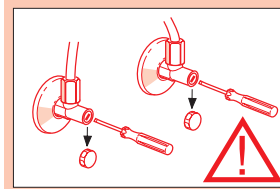

- Kalt- und Warmwasser absperren.
 - Fermer eau froide et chaude.
 - Chiudere acqua fredda e calda.
 - Interrumpir la salida de agua fría y caliente.
 - Turn off cold and hot water.

KWC MARLINO

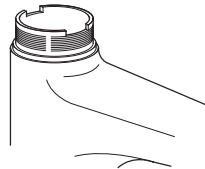
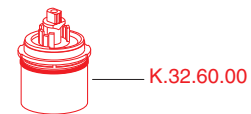
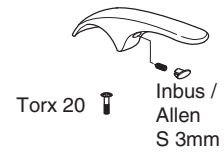

KWC MARLINO

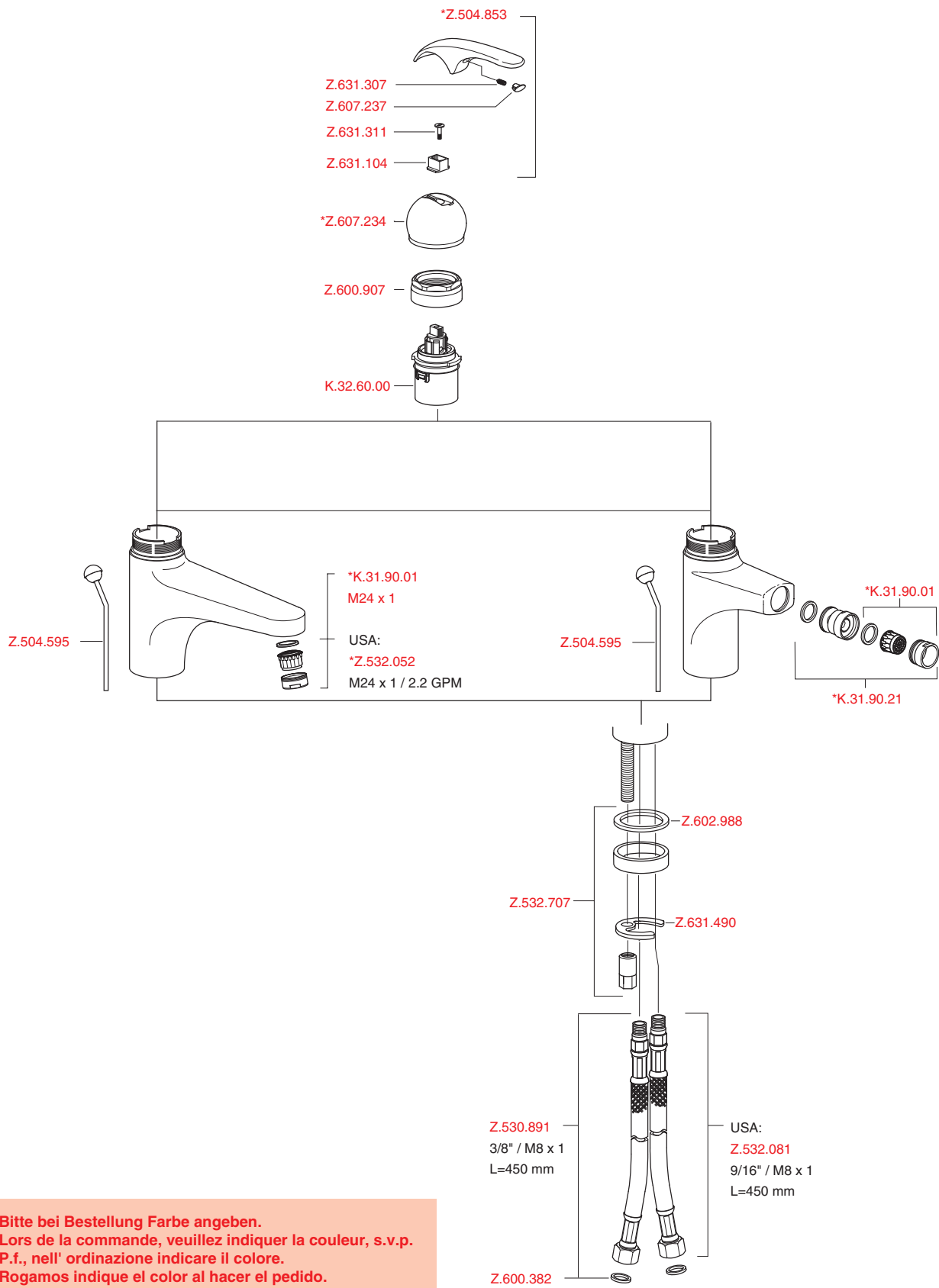

D * Bitte bei Bestellung Farbe angeben.
F * Lors de la commande, veuillez indiquer la couleur, s.v.p.
I * P.f., nell' ordinazione indicare il colore.
Sp * Rogamos indique el color al hacer el pedido.
E * Please specify the color when placing your order.

Free Manuals Download Website

<http://myh66.com>

<http://usermanuals.us>

<http://www.somanuals.com>

<http://www.4manuals.cc>

<http://www.manual-lib.com>

<http://www.404manual.com>

<http://www.luxmanual.com>

<http://aubethermostatmanual.com>

Golf course search by state

<http://golfingnear.com>

Email search by domain

<http://emailbydomain.com>

Auto manuals search

<http://auto.somanuals.com>

TV manuals search

<http://tv.somanuals.com>