

KA300TX / KA300RX / KBS300RX
Alarm Monitor

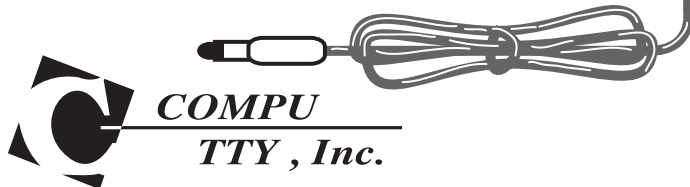

INSTRUCTION MANUAL



PATENT PENDING

Important

Warranty

Compu-TTY, Inc. warrants that the Alarm Monitor sold by Compu-TTY, Inc. is free from defects in materials and workmanship under normal use and service for one year. This warranty is applicable only to the original purchaser of the Alarm Monitor when accompanied by a sale receipt stating the date of purchase and the name of the company from which purchased. This warranty is in lieu and excludes all other warranties, expressed or implied, including any implied warranty of merchantability or fitness and of any obligation on the part of Compu-TTY, Inc. If the Alarm Monitor shall prove the defective, then Compu-TTY, Inc shall either replace or repair the Alarm Monitor at no cost to the original purchaser within one year of the date of purchase. During the one-year period you may return the Alarm Monitor to Compu-TTY, Inc. at the following address:

Compu-TTY Inc.

3408 Indale Rd.

Fort Worth, TX 76116

Shipping charges are at the customer's expense. Please include a check or money order made out to Krown Manufacturing in the amount of \$10.00 to cover for the shipping and handling. This warranty does not extend to any Alarm Monitor sold by Compu-TTY, Inc., which has been subjected to misuse, neglect, accident, improper application, improper installation, or any use in violation of the instruction furnished by Compu-TTY, Inc. This warranty does not extend to or apply to any Alarm Monitor, which has been repaired or altered by any persons who have not been expressly approved by Compu-TTY, Inc.

This warranty does not apply to the alarm monitor if it has been damaged, modified, abused or altered after the date of purchase or if it fails to operate due improper maintenance or inadequate AC or DC power.

In no event, shall Compu-TTY, Inc. be liable for loss of use of this product or for any indirect, special, incidental, or consequential damages, personal injury, property damage, or cost, or expenses incurred by the consumer or any other user of this products. This warranty is only applicable to a product purchased through Krown Manufacturing, Compu-TTY, or a Krown dealer. Other than state herein, there is no other warranty whether by the sample or model, by description or quantity, whether expressed or implied, and there are no implied warranties of fitness for a particular purpose or of merchantability.

Record your operation code for future reference:

OP CODE 1 _____
OP CODE 2 _____
OP CODE 3 _____

ALARM MONITOR | Instruction | 1st Edition | November 2004

Compu-TTY, Inc.

3408 Indale Road, Fort Worth, Texas 76116

Voice or TTY: (817) 738-8993 or (817) 738-2485, Fax: (817) 738-1970

E-mail: info@computty.com, Website: <http://www.computty.com>

Download from www.Somanuals.com. All Manuals Search And Download.

CONTENTS

i.	Introduction	ii
ii.	KA300 System.....	1
1.	How your Alarm Monitor KA300 Works	2
	Using KA300 for a Single Family Household.....	2
	Install KA300 for Single Family Home.....	3
	Time-Condition-Signal.....	4
	For Hotel, Dormitory or Multi-Family Household	4
	Install KA3000 for Multi-Family or Hotel	5
2.	Installing Battery.....	6
	KA300TX, KA300RX, and KBS300RX	6
3.	Setup Operation Code	7
	KA300TX Transmitter	7
	Mounting the KA300TX on the Existing Alarm	8
	KA300RX Receiver	8
	Erase KA300RX Memory.....	8
	Mounting the KA300RX on the wall.....	9
	KBS300RX Bed Shaker Receiver.....	9
	Bed Shaker LED Indicator.....	10
	Installing the KA300 System for first time.....	10
4	Test & TroubleShooting	12
	Testing	12
	TroubleShooting	13
5	Specification	14

i. INTRODUCTION

The alarm Monitor KA300 is developed to bridge the gap created by the existing warning devices designed only for the hearing. It provides a totally reliable source for the Deaf and Hard of Hearing to watch and to be alerted when there is a fire, smoke, propane, gas leak alarm, tornado, hurricane, severe thunder storm alert, or when a national attack warning activates its siren. You will be worry free to select any alarm system designed without considering whether it supports the hearing impaired.

You will find its lifesaving features especially with multifamily, dormitory, or hotel's alarm system while you are asleep and the evacuating siren is activated. It also lets you know what source triggered the alarm.

It is very easy to install the KA300TX sensor directly to the existing alarm system. It could save you a great cost to equip the local Hearing Impaired compatible alarm device. Most of existing alarm devices, if it is separated from source of the smoke, will not alert you when there is a fire that happens somewhere in a multi-room building or will not respond to the evacuating siren.

For a single-family household, KA300 gives you great flexibility to build your own system with multiple transmitters and multiple receivers. It operates based upon code protection. The wireless link will save you from wiring the system and help to install the whole alarm monitor system within minutes.

For maximum safety, the KA300RX main receiver works with both AC and battery backup. In AC adapter mode, KA300RX triggers the alarm with the 177,000mCd strobe light, loud siren and ultra-light 1,000mCd LEDs. If the AC power failed, the unit will go to battery backup mode. The ultra-light LED and the siren will be activated. The strobe light will not work in battery backup mode.

KBS300RX is equipped with a strong bed shaker that will guaranty to wake the deepest sleeper.

The technique of Time-Condition-Signal verifying, combined with a fine tuning threshold, substantially reduces the possibility of a nuisance alarm. The operation code can be changed easily to stop false alarms that are caused from a neighboring Alarm Monitor system.

Since you are solely responsibility for your fire and hazards protection, test the system weekly and check battery backup regularly to maintain the efficiency operation. A failed operating system will not protect you.

Please read this user manual carefully first to understand the operation of the system before planning anything and keep it for future reference.

** Keep your sale receipt with this manual in case that you need warranty service.*

ii. KA300 SYSTEM

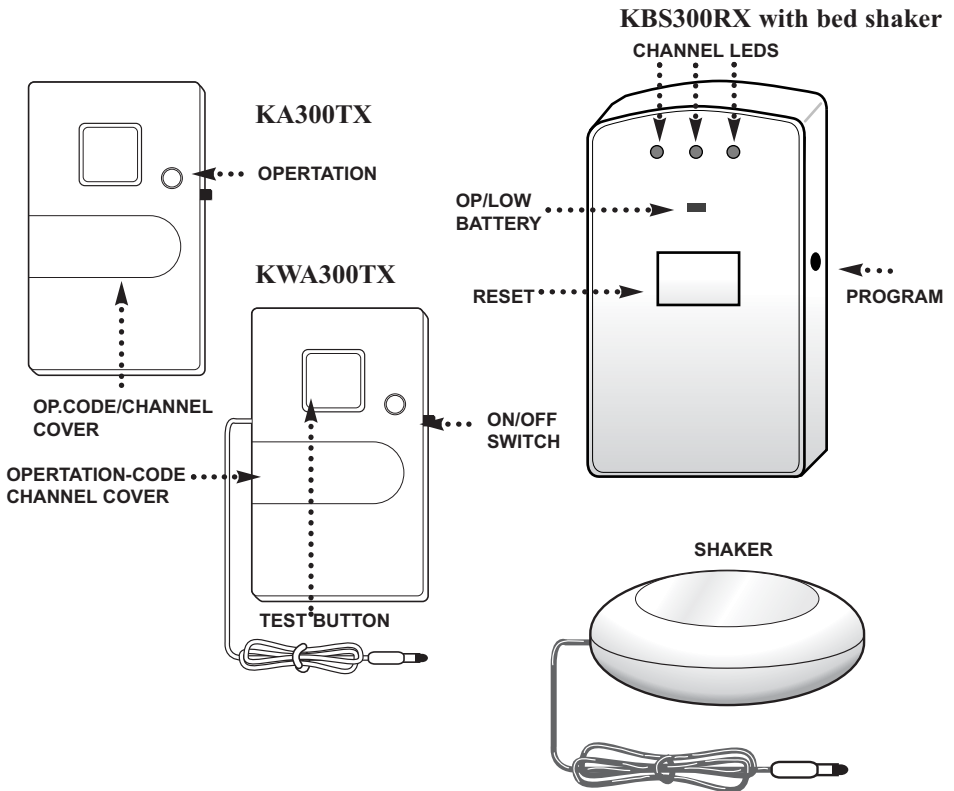
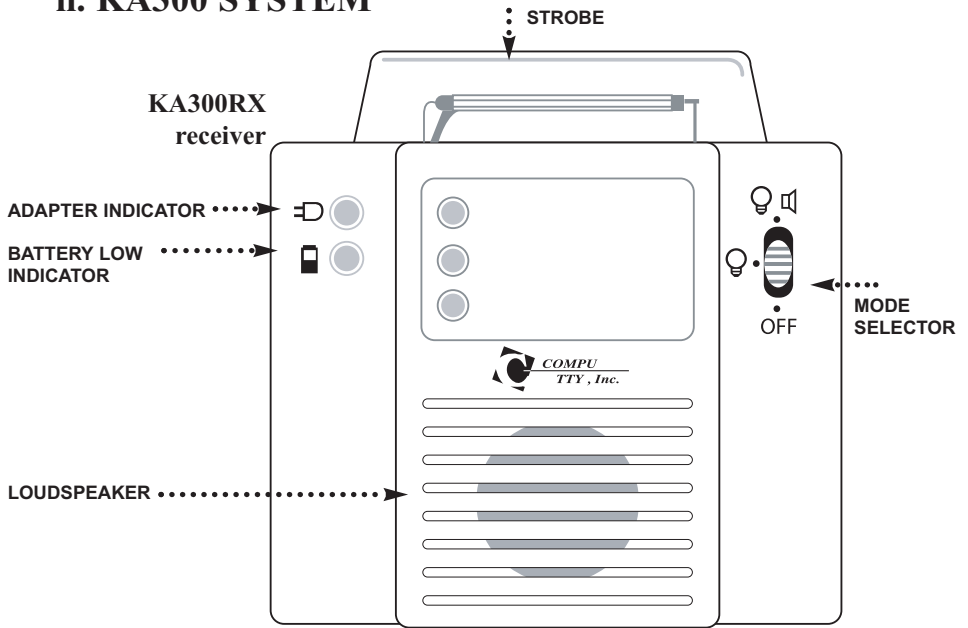

HOW YOUR....

ALARM MONITOR KA300 WORKS

KA300system is designed to monitor all existing acoustic alarm units in your living area and transfer it to a visual and vibration alarm. It will quickly help you to determine what source triggered the alarm and give you enough time to evacuate from the building or to locate a shelter. The KA300 is not an alarm system but it is the vital source for the Deaf and Hearing Impaired to rely upon in an emergency. In most cases, the alarm was caused by Fire, Smoke, Carbon monoxide, hurricane, tornado, earthquake, etc.

USING KA300 FOR A SINGLE FAMILY HOUSEHOLD

You must choose one operation code for KA300 system used for your house. Set all transmitters KA300TX to that operation code. All KA300TX used for a smoke detector will be set to channel one. The other will be set for channel two and three. There will be no limit for the number of transmitters used in the same channel setting. However, the distance from the TX to the RX will be limited to around 100 feet. If you have a KBS300RX bed shaker, you need to program the operation code for it when you program the KA300RX. You can program the bed shaker at a different time. It will be more convenient to program the operation code for both receivers at the same time.

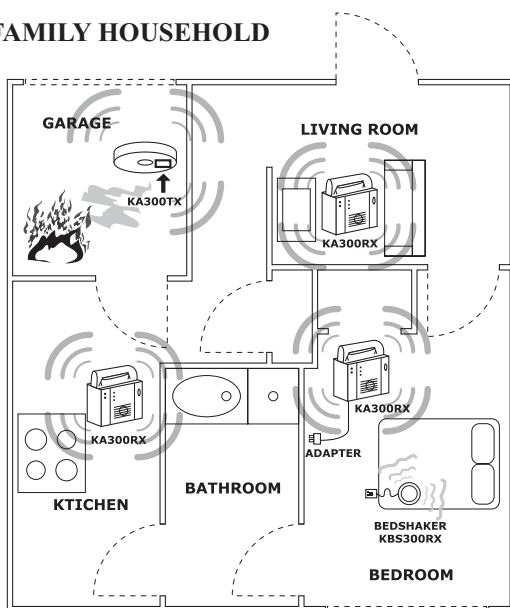

Note: The toggle switch will be either in the ON or OFF position. We will call ON position 1 and the OFF position 0. For example, if all 8 switches are in the ON position, we will write 1111 1111 for that setup code.

1: HOW YOUR ALARM MONITOR KA300 WORKS (CONT.)

Example:

There are 4 smoke alarms and 3 Carbon Monoxide alarms that need to be monitor in your household. You will need seven KA300TX transmitters. All seven transmitters will be set at the same operation code as: 1000101010

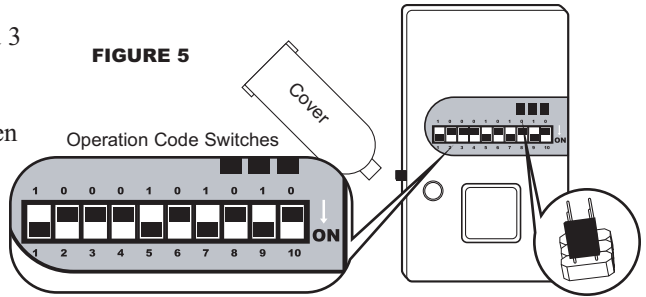

FIGURE 5

Four transmitters installed on the smoke detectors will be set at channel one.

The other three transmitters will be set at channel two.

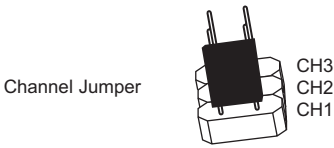

FIGURE 6

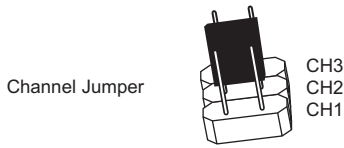

FIGURE 7

If you use the KA300 system with the weather channel, hurricane, tornado, or earthquake alarms combine with the fire alarm as illustrated in figure 8, you can choose for the weather alert at channel 3. Set the same house code for these KA300TX units and channel jumper to be channel 3.

INSTALL KA300 FOR SINGLE-FAMILY HOME.

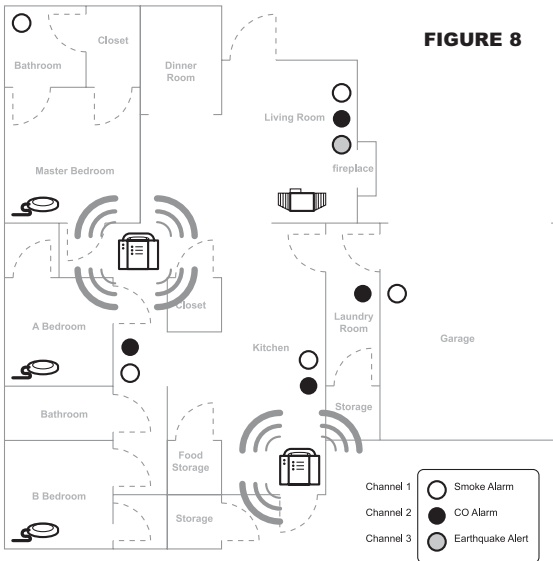

FIGURE 8

Plan the location of the KA300RX. Refer to Figure 8 to find the ideal spot to install the receiver for your house. Hallway or living room will be a perfect spot to install the receiver.

Since KA300 system is only an alarm monitor system, you must create a fire protection plan for your family and practice the plan to make sure that every member in the family knows what to do when the alarm triggers. Buy one or two KA300RX receivers and install them where they can be seen from every room in the house.

If you have a 2 story house, each story needs to have one KA300RX receiver. The programming process for the KA300RX receiver will be discussed later in Chapter 3.

CHAPTER 1 (CONT.)

Keep the battery installed and turn the power switch to OFF before bringing it to the location. Mark on the given label for channel location as fire, mono-carbon, or weather alert and coordinate them with the installed transmitters. This label is available only for the KA300RX.

Hearing Impaired people will need one KBS300RX in their bedroom for the best protection. You can buy many receivers for your needs as long as it still within the 100 feet range. If the house is larger than the range, you will need a wired-fire alarm system. If one triggers the other will trigger also. In this case, the transmitter only needs to be installed on the closest fire alarm to the receiver.

TIME-CONDITION-SIGNAL

When an alarm unit triggers, the red LED on the transmitter will stay lit. The address of the transmitter will be sent to all receivers. After two seconds, if the transmitter continuously sends an alert signal, the KBS300RX receivers will activate the alarm. This Time-Condition-Signal process will prevent a “nuisance” alarm.

Important note: In case of a false alarm, you can turn off the power switch of the receiver and search for which transmitter triggered the alarm by looking for a red LED on each KA300TX. Try to find out what caused the false alarm at the transmitter. If the red LED on the transmitter is OFF or free from the alarm signal source, pressing the reset button on the KBS300RX will turn off the shaker.

FOR HOTEL, DORMITORY OR MULTI-FAMILY HOUSEHOLD

A single fire alarm unit cannot trigger when there is fire or smoke somewhere in the building. The KA300 system will activate the alarm when the alarm system of the hotel, dormitory, or apartment turns on the siren. Therefore, if there is an evacuation signal sent out from the fire alarm center of that building, you will be notified whether you are sleeping or awake, and regardless where you are.

Select only one operation code for your hotel or apartment. Write the code on the cover of this book and keep it for future reference. There are 1022 combinations available for you to pick for each room in your hotel or apartment complex. Keep a record of what combination has been given out to each room so there will not be two rooms operating with the same code.

Install several KA300TX transmitters on the existing alarm siren in the hallway in 50, or 70 feet coverage. Set the channel jumper of those transmitters to channel 3.

1: HOW YOUR ALARM MONITOR KA300 WORKS (CONT.)

INSTALL KA300 FOR MULTI-FAMILY HOME OR HOTEL

There is one hotel code applied for all KA300TX installed in the hallway. The room code is applied for each KA300TX in each room.

With this set up, when there is an alarm triggered from a local fire alarm, the KA300RX receiver and KBS300RX will activate with channel one LED indicator. If the evacuating signal comes from the hallway siren, the receivers will activate and indicate channel three LED.

Program the KA300RX receiver to respond for either room code or hotel code.

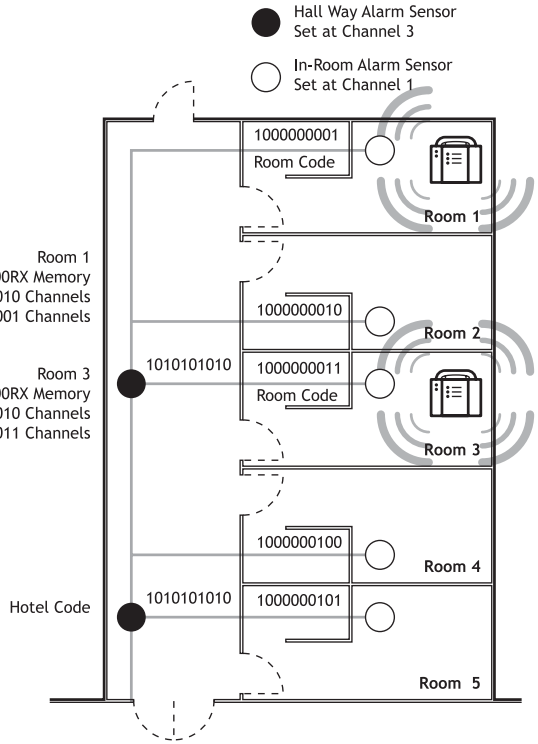

Important note: Failing to install a transmitter in the hallway for the evacuation siren, may cause the receiver to not respond to this signal. The range of the transmitter is 100 feet. The receiver will not respond if the transmitter is out of range. It is recommend to install the transmitter at a 70 feet distance for the area covered.

INSTALLING BATTERY

KA300TX

Uses 3VDC, CR2032 battery and it will be installed by the manufacturer.

KA300RX

Uses alkaline 9V battery. Do not use rechargeable batteries.

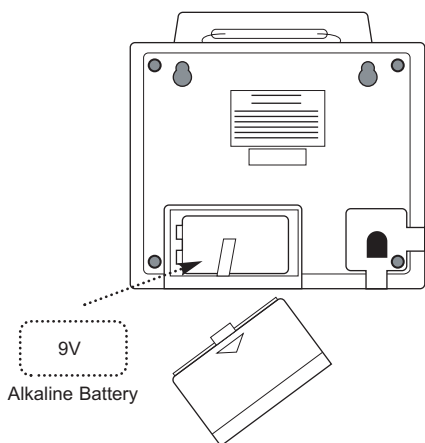

KBS300RX

Uses a 9V rechargeable battery (included). Do not use alkaline batteries.

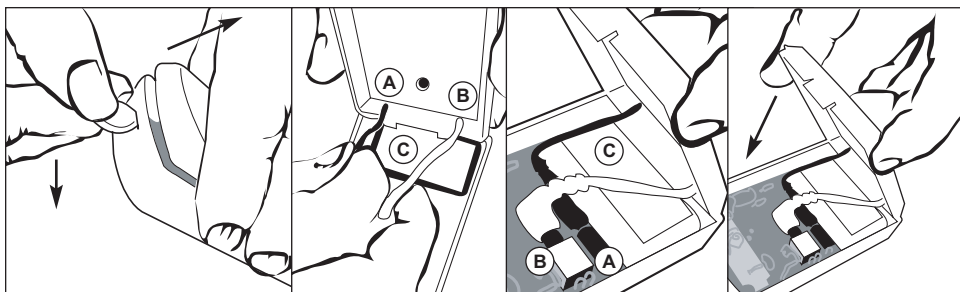

Use a coin to open the back cover of the KBS300RX

Install (A) Adapter Plug (B) Shaker Plug (C) 9V Rechargeable Battery
Fit the cable through the gaps on the cover and close it

SETUP OPERATION CODE

The operation code is set by DIP-switches located in the front of the KA300TX transmitter, and they are preset at the factory. If your KA300RX receiver does not respond to your KA300TX transmitter signal when the test button is pressed, or it activates from a false signal of a neighboring KA300 system, you need to change the operation code. After the code change on the transmitter, you need to program the new code into the KA300RX receiver memory.

KA300TX TRANSMITTER:

To protect the other system from interfering with your alarm monitor system, you need to set up an operation code for all transmitters. There are 10 switches located in the front of the transmitter used to set the operation code. Choose one combination by toggling the switches between the ON and the OFF position.

For example:

1ON 2OFF 3OFF 4OFF 5ON 6OFF 7ON 8OFF 9ON 10OFF

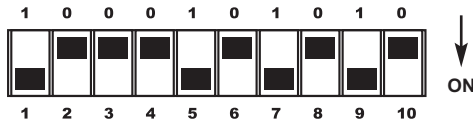

Set all transmitters with your own combination and record it into this book for later reference. Press the test button on the KA300TX. The red LED will light up to show that it is active.

Set the operation channel jumper for each transmitter and record the alarm location onto the given label. This label will be installed with a plastic cover to the channel LED later.

Important note: Do not set all switches in ON or OFF position.

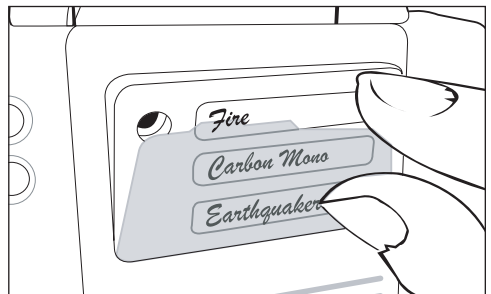

Clear plastic cover

For Example:

Fire: All KA300TX units installed on smoke alarms will be set to channel 1

Carbon Mono: All TX installed on Co Alarm unit be set to channel 2

Weather alert: TX installed on Quake alert or Weather alert will be set to channel 3

The op code is the same for all transmitter in a house.

CHAPTER 3 (CONT.)

MOUNTING THE KA300TX ON THE EXISTING ALARM

Use the self adhesive Velcro to attach the KA300TX to the siren of the existing alarm unit. Do not block the window of the smoke chamber or on top of the alarm sensor.

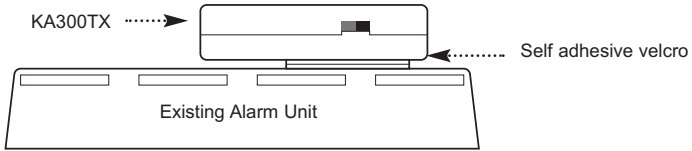

KA300RX RECEIVER

The alarm monitor KX300RX is designed to learn the operation code from your transmitter and program it to the memory.

Important note: To protect your hearing from the loud siren when you are programming the receiver, do not set the power switch to position of strobe and siren combined. Do not remove the protection cover on the strobe and do not plug in the adapter. Exposing your eyes to the ultra-bright light from the RX at a close distance may be harmful to your vision.

KA300RX can program up to three operation codes in memory. These memories will make the KA300RX becomes an extremely flexible device to setup for a multi-family dwelling. The status of these memories will be shown on the three alarm LEDs, 10 seconds after you turn on power switch. If these memories are empty, all three LED will flash when the power is turned on. If one memory is taken, one LED will stay lit when the other will continue to flash. After a code is recorded into memory, the KA300RX will extend 10 sec more to accept a new operation code sent from the other transmitters. When the start-up is finished and the LEDs are off; the receiver will not accept any new codes.

Follow these steps every time you change the operation code:

1. Make sure your KA300TX is turn on.
2. Take one of the KA300TX and set it by the KA300RX.
3. Turn on the KA300RX by sliding the power switch to strobe only position while pressing the test button on the KA300TX for 2 seconds.
4. Release the test button when one of the event LED becomes stable. The new operation code is programmed to KA300RX memory.

After the KA300RX has learned your operation code, there will be no need to repeat these steps even it you turn off the unit.

If your system does not work properly, check and make sure the system's units are installed correctly and battery levels are adequate before inspecting the DIP switch. If you wish to change to a new code, use a small screwdriver to set the DIP switches. Repeat the learning process for all KA300RX receivers.

ERASE KA300RX MEMORY

If all three LEDs on the KA300RX are stable when you turn on the power switch, your KA300RX memory is full. To erase those memories, unplug the AC adapter cord and detach the battery from the unit for 10 seconds. Repeat the previous steps to set up a new operation code.

3: SETUP OPERATION MODE (CONT.)

MOUNTING THE KA300RX ON THE WALL

The adapter of the KA300 is supplied with a nine feet line cord for installation to a normal outlet box.

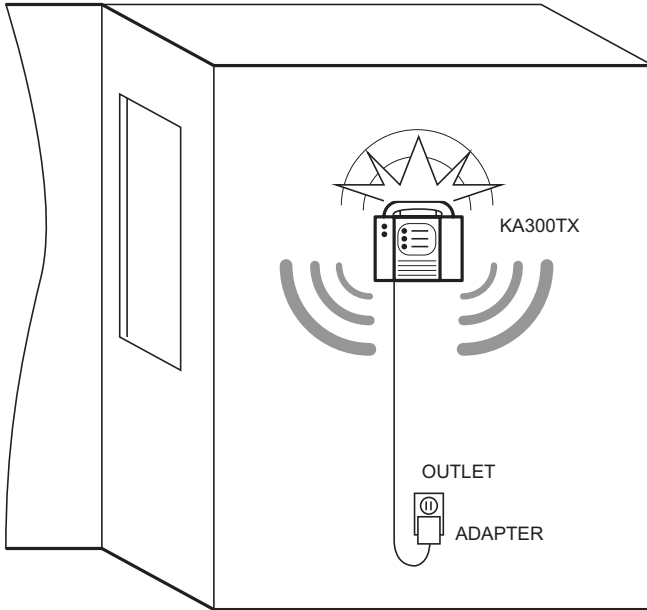

KBS300RX BED SHAKER RECEIVER:

The bed shaker KBS300RX is a receiver. It needs to be programmed like the KA300RX before you can actually use it in the system. To program the operation code, follow these steps:

1. Use a small screwdriver or a penny to open the top cover. (See Chapter 2)
2. Install a rechargeable 9V battery.
3. Plug in the bedshaker and the adapter cords.
4. Feed the cord through the open gaps.
5. Close the cover and plug adapter to an electric outlet.
6. Insert one end of a paper clip into the small program hole of the KBS300RX located on the side.
7. Press the test button on KA300TX and hold for two seconds.
8. Watch the channel LEDs. If one LED turns out stable then release the test button on the transmitter.
9. Press test button on the TX again to make sure the bed-shaker is working properly.

The bed shaker receiver has three memories available. If the memory is full and you want to program a new code, you can erase the memory by unplugging the adapter and the battery for one minute.

BED SHAKER LED INDICATOR

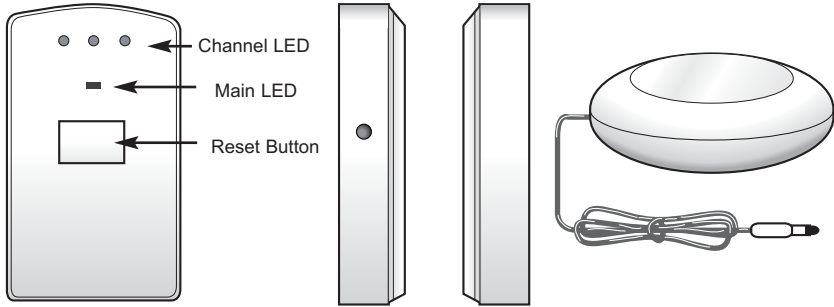

1 Main LED:

- Turns ON when there is a channel triggered by an alarm in the system.
- Low flashing when there is AC power failure.
- Fast flashing for battery low warning. It needs to be recharged soon.

2 Channel indicator LEDs:

- Turns ON to indicate the corresponding channel has triggered the receiver.
- Flashing to indicate a transmitter battery is low.

NOTE: The supplied battery of KA300TX transmitters can last more than 2 years under normal conditions. If one transmitter battery is getting low, it is recommended that you change all of the transmitter batteries.

KBS300RX is designed to wake you up when the alarm triggered. It will not stop until you are aware of the alarm and recognize the source that caused the alarm. To stop the vibrator on the KBS300RX press the reset button. However if the source continues to send an alarm signal to the bed shaker receiver, the bed shaker will reactivate after a two second pause.

INSTALLING THE KA300 SYSTEM FOR FIRST TIME

- Plan the fire alarm system on a drawing with desired channel indicator when the alarm triggers.
- Record the operation code to the first page of the manual.
- Setup the operation code and channel jumper for all KA300TX transmitters. Turn on and set aside.
- Install battery for all receivers KA300RX and KBS300RX.
- Plug in power supply.
- Do the operation code learning process for each set. Turn the KA300RX on (or hit program button of the KBS300RX). Press and hold the test button on KA300TX for two seconds. One LED on the KA300RX and/or KBS300RX will become stable and the code learning process is finished. If there are several more codes, repeat the above process, if there is only one operation code for all

3: SETUP OPERATION MODE (CONT.)

KA300TX Transmitter, program the KA300RX with one KA300TX.

- Install the KA300TX on the existing sensors and KA300RX on the wall.
- Perform a test on each KA300TX,

USING ALARM MONITOR WITH WEATHER ALERT RADIO.

- Set operation code for the KWA300TX (weather alert transmitter).
- Select channel 3 on KWA300TX and record it into the label on channel LED of KA300RX.
- Turn on KWA300TX.
- Repeat code learning process if the operation code is different from the previous house code.
- Plug the KWA300TX to the weather alert through the external output pin.
- Test the weather alert siren to make sure the unit is set up properly.

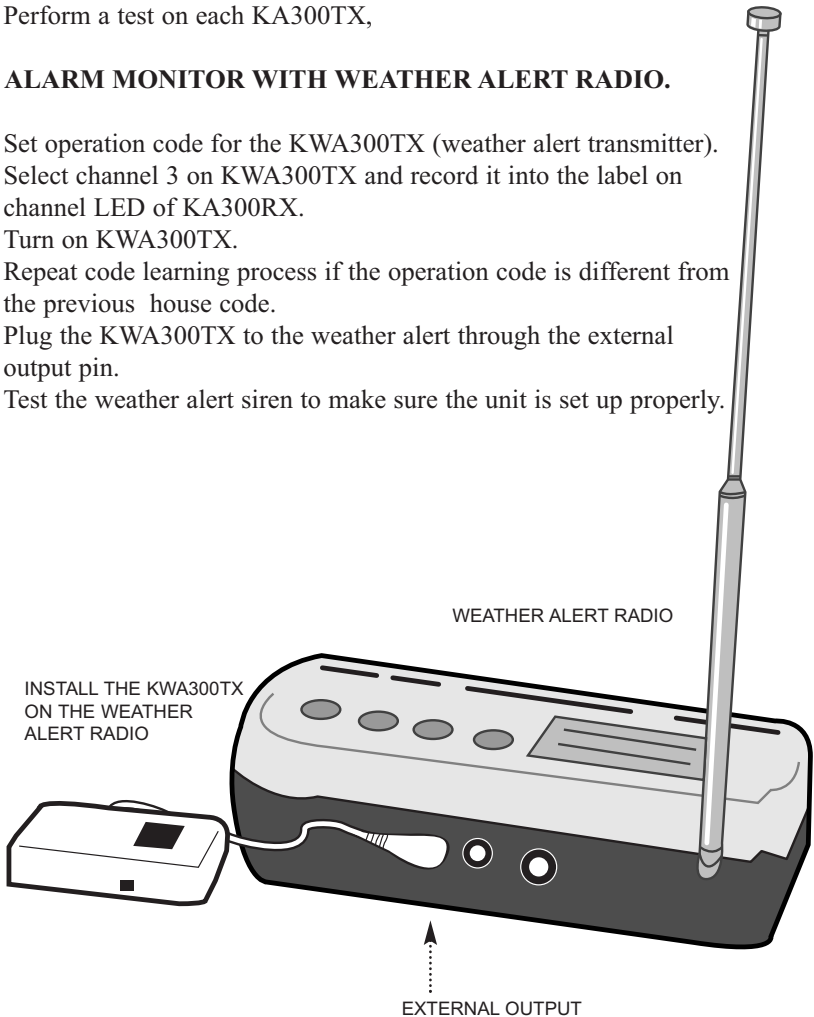

TESTING

It is important to perform a test for your alarm system at least once a month to make sure the system is operating properly. You are responsible for your family safety from fires, and any other possible disasters. Repair or replace your Alarm Monitor, and all other alarm systems when they no longer function.

To test the KA300 system

1. Place the cover over the strobe bulb to protect your vision from the strong light.
2. Turn KA300RX power switch to the last position where it will activate both siren and strobe light. You need to test all alarm outputs to make sure it works when needed. Cover the strobe light before going to the next step.
3. Press and hold the test button on KA300TX for more than three seconds or use test button on the existing alarm device to activate the alarm system.
4. Check the KA300RX to make sure it shows the correct channel. Release the test button on the transmitter.

Repeat the same process to test the KBS300RX. Press the reset button on the KBS300RX to turn off the shaker.

Replace the old battery when you see the orange LED flashing rapidly on the KA300RX. Follow this procedure when installing a new battery for your KA300RX to protect the operation code from being erased.

1. Do not unplug the AC adapter. Take the KA300RX out from the wall.
2. Locate the battery compartment door in the back of the unit.
3. Press your thumb down firmly and slide the door toward the arrow direction.
4. Take the old battery out of the compartment.
5. Install the new battery and replace the battery door.

If the memory of KA300RX is erased by accident, you must follow Chapter 3 to program the operation code for your receiver. Do not program the other KA300RX if it has not lost memory.

Press the test button on the KA300TX to test the unit. If the red LED does not stay lit, you need to replace the battery.

4: TEST & TROUBLESHOOTING

TROUBLESHOOTING:

If any question should arise during the installation and testing, follow through the frequently asked questions below. Contact CompuTTY or your authorized dealer if you should have any more questions that these FAQs do not answer.

1. I have more than three different kinds of alarm devices, how can I program it to one receiver?

The KA300RX has only three LEDs to indicate the channel triggered the alarm. For example: you have five alarm devices for fire, flame, carbon monoxide, hurricane, and tornado alert. You must use two receivers to have enough LEDs to indicate the cause of the alarm. Set the devices to two groups. One is for fire alarm purpose and the other is for weather alert. Set two different operation codes. One is for each group. Program each the receiver with transmitter in the same group follows the instructions in Chapter 5. Test thoroughly to make sure it functions as desired. IMPORTANT NOTE: Install the KA300RX receivers five feet away from each other to prevent interference.

2. My bed shaker does not work.

The KBS300RX is a receiver. Check the LEDs to make sure that the AC power is good and the battery is installed. Program it following steps in Chapter 3. If you use only one operation code for your household, you need only one transmitter to program the bed-shaker receiver.

3. There is channel LED on my KA300RX blinking.

Your transmitter battery may be getting low. If you have more than one KA300TX, change the batteries for all of them at same time. The battery should last for more than two years under normal conditions.

4. The battery LED on my KA300RX is blinking.

Battery back up on your receiver is getting low. Replace with new battery.

5. I moved to a different house and took KA300 system with me. The transmitter shows a wrong channel when I test it.

Change the channel jumper on the front of the transmitter KA300TX to the correct channel.

6. The KA300RX did not respond to my transmitter after I tried to program a new operation code to the memory. All three LEDs stay stable when reset.

The memory is full. Reset the KA300RX and erase the memory by unplugging the battery and AC adapter. Test the KA300RX by plugging the battery back up. If the LEDs stay stable, leave the machine unplugged for longer than one minute before trying it again.

SPECIFICATION

Working Frequency.....	433MHz
Transmitter codes.....	1024
Receiver Memories.....	3
Display Channel.....	3

SIZE

KA300TX.....	65 x 40 x 17.5mm
KWA300T	
KA300RX.....	130 x 126 x 58mm
KBS300RX.....	60 x 97 x 25mm
KBS300RX Shaker.....	83mm diameter

WEIGHT

KA300TX.....	40g
KWA300TX.....	45g
KA300RX.....	(no battery) 380g
KBS300RX.....	(no battery) 100g
KBS300RX Shaker.....	110g

OPERATION VOLTAGE

KA300TX.....	3VDC
KWA300TX	
KA300RX.....	24VAC
KBS300RX.....	12VDC

BATTERIES

KA300TX.....	CR2032
KWA300TX	
KA300RX.....	9VDC Alkaline
KBS300RX.....	9VDC rechargeable

Strobe Light.....	177mCd
Siren.....	95 dB

APPROVAL.....	FCC part 15
.....	UL listed



3408 Indale Road, Fort Worth, TX 76116
Voice or TTY: (817) 738-2485 or (817) 738-8993
Fax: (817) 738-1970
E-mail: info@computy.com

ORDERS: (800) 366-9950

www.computy.com

Free Manuals Download Website

<http://myh66.com>

<http://usermanuals.us>

<http://www.somanuals.com>

<http://www.4manuals.cc>

<http://www.manual-lib.com>

<http://www.404manual.com>

<http://www.luxmanual.com>

<http://aubethermostatmanual.com>

Golf course search by state

<http://golfingnear.com>

Email search by domain

<http://emailbydomain.com>

Auto manuals search

<http://auto.somanuals.com>

TV manuals search

<http://tv.somanuals.com>