

KRUPS

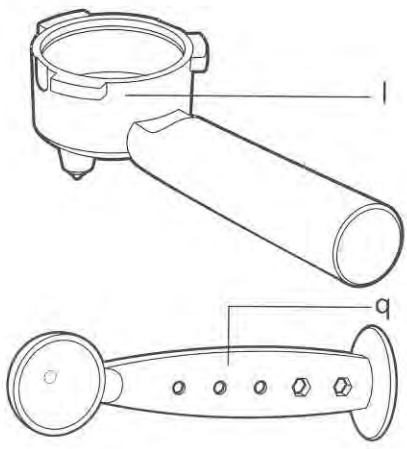

www.krups.com

Download from Www.Somanuals.com. All Manuals Search And Download.

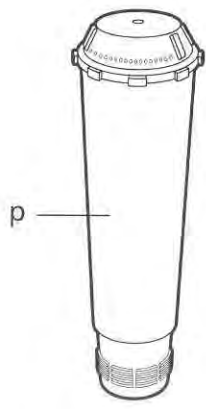
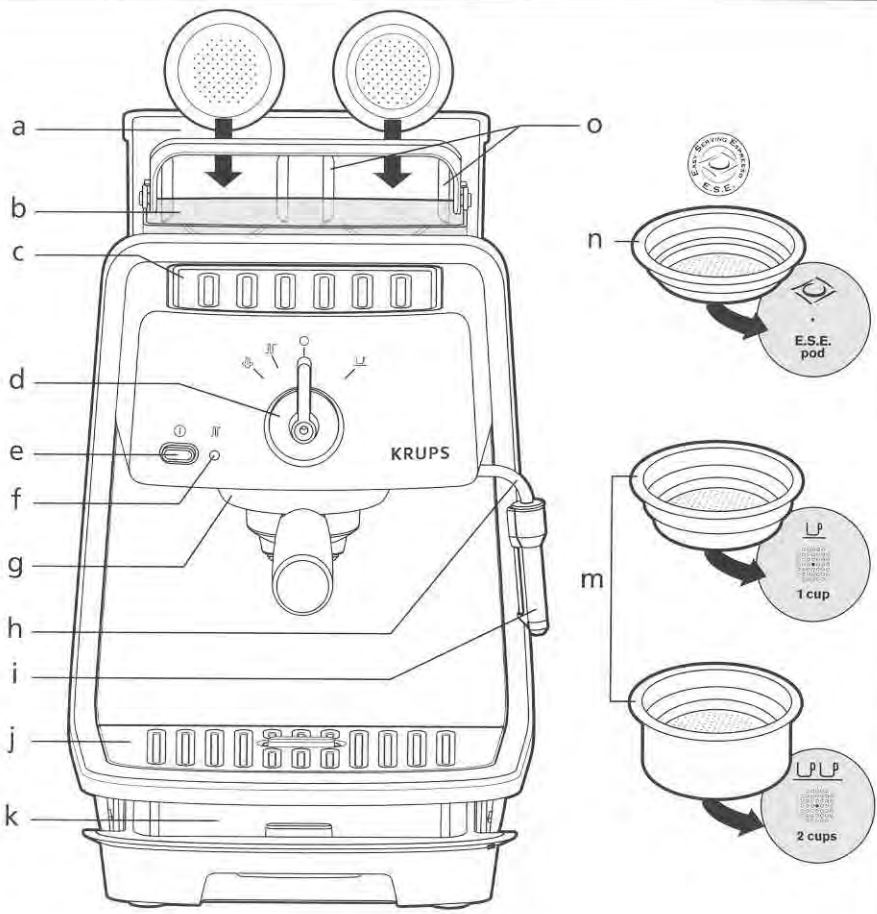

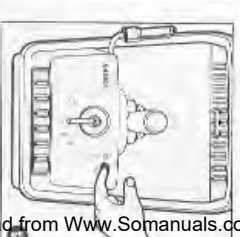
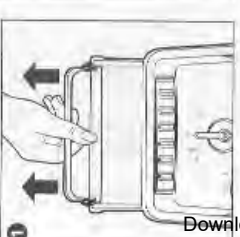
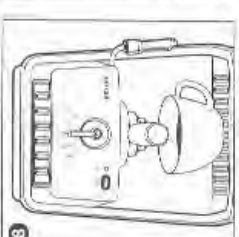
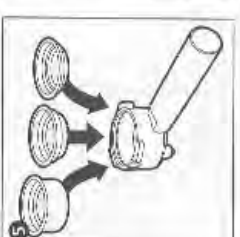
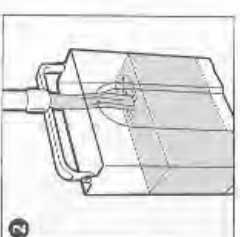
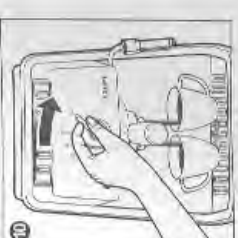
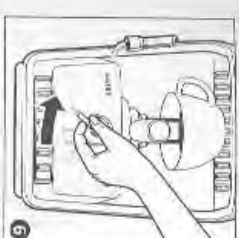
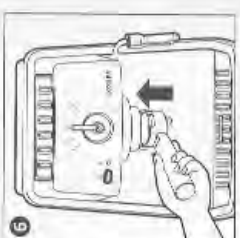
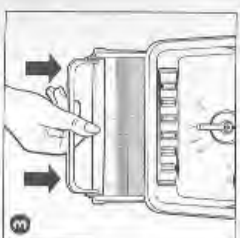
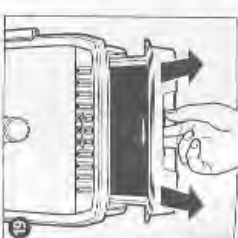
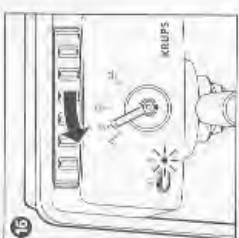
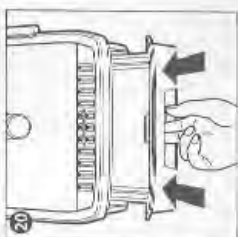
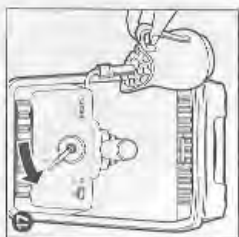
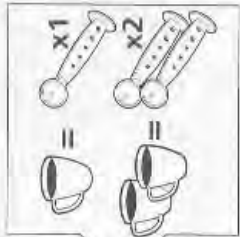
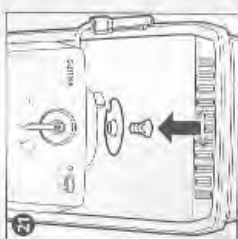
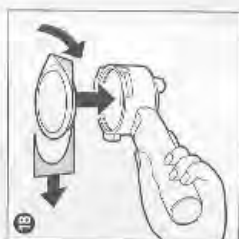
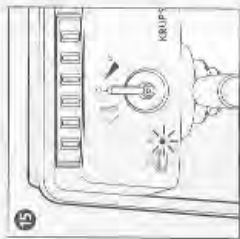
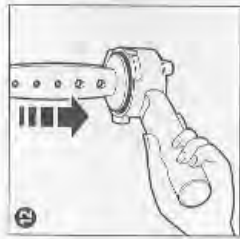

IMPORTANT SAFEGUARDS

When using electrical appliances, basic safety precautions should always be followed to reduce the risk of fire, electric shock, and/or injury to persons including the following :

1. Read all instructions.
2. Do not touch hot surfaces. Use handles or knobs.
3. To protect against fire, electric shock and injury to persons, do not place cord, plugs or appliance in water or other liquid.
4. Close supervision is necessary when any appliance is used near children. Keep appliance out of reach of children.
5. Not intended for use by children.
6. Burns can occur from touching hot plate, hot metal parts, hot water or steam. Exercise caution.
7. Unplug from outlet when not in use and before cleaning. Allow to cool before putting on or taking off parts, before cleaning the appliance, and before storing.
8. Do not operate any appliance with a damaged cord or plug or after the appliance malfunctions, or has been damaged in any manner. Return appliance to the nearest KRUPS Service Center for examination, repair or adjustment.
9. To reduce the risk of injury do not drape cord over the counter top or table top where it can be pulled on by children or tripped over unintentionally.
10. Do not let cord hang over edge of table or counter, or touch hot surfaces.
11. The use of accessory attachments not recommended by KRUPS may result in fire, electric shock or injury to persons.
12. Do not use outdoors.
13. Do not place on or near a hot gas or electric burner, or in a heated oven.
14. Always attach plug to appliance first, then plug cord into the wall outlet. To disconnect, turn the control to «off» then remove plug from wall outlet. Do not yank cord, instead grasp plug and pull to disconnect.
15. Do not use the appliance for other than intended use.
16. Do not pour liquids other than water and descaling solutions specified in this manual into the water tank.

SAVE THESE INSTRUCTIONS

CAUTION

This appliance is for household use only. Any servicing other than cleaning and user maintenance should be performed by the nearest authorized KRUPS Service Center. Visit our website at www.krups.com or contact our Consumer Service department for the service center nearest to you.

- Do not immerse appliance in water.
- To reduce the risk of fire or electric shock, do not dismantle the appliance. Repair should be done by an authorized KRUPS Service Center only.

SHORT CORD INSTRUCTIONS

- A. We do not recommend using an extension cord with this device.
 - 1) the marked electrical rating of the extension cord should be at least as great as the electrical rating of the appliance,
 - 2) the longer cord should be arranged so that it will not drape over the counter top or table top where it can be pulled on by children or tripped over.
- B. If an extension cord is absolutely necessary,
 - 1) the marked electrical rating of the extension cord should be at least as great as the electrical rating of the appliance,
 - 2) the longer cord should be arranged so that it will not drape over the counter top or table top where it can be pulled on by children or tripped over.
- C. This appliance has a polarized plug (one blade is wider than other). To reduce risks of electric shock, this plug is intended to fit into a polarized outlet only one way. If the plug does not fit fully into the outlet, reverse the plug. If it still does not fit, contact a qualified electrician. Do not attempt to modify the plug in any way.

In the interest of improving products, Krups reserves the right to change specifications without prior notice.

Espresso Coffee

Your new Krups espresso machine has been constructed to make café quality espresso, cappuccino, and latte at home.

Espresso is a style of coffee that comes from a unique process, not a particular type of coffee bean. Hot water, under pressure, is passed through tightly packed, finely ground coffee. The resulting liquid is rich, dark, and extremely flavourful; the concentrated essence of the coffee bean.

Espresso is not served in regular coffee cups, but in small 1.5-oz "shots". The perfect espresso shot is topped by beautiful, thick, golden foam known as crema, a product of the natural oils in the coffee bean, and the source of its rich flavour and aroma.

It is important to note that your espresso coffee must be both well roasted coffee and correctly ground. If you cannot buy ground espresso coffee, use a coffee grinder to grind the beans. The coffee must not be ground too fine; it must be slightly granulated, with a consistency somewhat between flour and sugar. Too fine a grind results in bitter, over-extracted espresso and a risk of blocking the grid of the brewing head and the filter; too coarse and the espresso will be weak and under-extracted.

In addition to the coffee you use, the other three factors that determine perfect espresso results are water, temperature and pressure. Your Krups machine ensures all three are precision controlled by expertly designed technology. What you must ensure is that the water you use is freshly-drawn (so that it has not had time to stagnate in the air), without any chlorine odor and at a fairly cold temperature.

There are a number of misconceptions surrounding espresso. The first is that espresso should be bitter and burnt tasting. In fact, the ideal espresso shot should be aromatic, bitterness (not bitter) and assertive, with a lingering aftertaste.

• Plug the machine into the electrical socket. Verify that the voltage indicated on the technical specifications on the bottom of the unit corresponds to your electrical installation.

• Ensure the drip tray and drip tray grid are in place when using the machine.

• Before using your appliance for the first time, clean the system completely as follows:

• Open the lid and lift out the water container using the handle (1). Fill the water container with fresh, cold water (2).

• Place the water container back into the appliance by positioning it firmly in the water container compartment (3) and close the lid.

• Turn on the appliance (4). The blue operating light and the orange temperature control indicator light will both come on.

• Two filters are set in the tank lid.

• Place one of the filter baskets in the filter holder (5). Then put the filter holder up against the appliance's brewing head.

• To ensure that the filter holder is in the correct position, turn the handle so it points to the left at a 45 degree angle (6), place the filter holder flat against the brewing head, then turn the handle towards the right (7) as far as it can go.

• Place a container, as large as possible, beneath the filter holder (8).

• As soon as the orange indicator light goes off, turn the selector to the **LP** setting (9) and allow all the water in the water tank to run through.

• If necessary, you can stop the operation by turning the selector to the **O** setting to empty the container, then resume operation.

• It is recommended to rinse the system 2 times prior to first use.

(N° art. F088) not delivered with the appliance.

Using the various functions of your espresso machine

1. ESPRESSO MAKING

• WITH GROUND COFFEE

For best results, we recommend that you first pre-heat the accessories (filter holder, filter basket and cups) without putting in ground coffee. To do this:

• Fill the water container with fresh, cold water (1) (2) (3) and turn on the appliance (4).

• Put the filter holder and an empty filter basket in place (6) (7), and place the espresso cups underneath.

• As soon as the appliance reaches the correct temperature, the orange indicator light will go out.

• Turn selector to the **LP** setting (10).

• When the cups are full of hot water, reset the selector to the **O** setting.

After making your first espresso and the appliance is hot, the espresso cups can then be pre-heated on the cup warming plate.

• Preparing an espresso :

• Fill the water container (1) (2) and turn on the appliance (4).

• Put the filter basket (for one or two cups into the filter holder (5).

• Place some ground coffee in the filter basket (1 or 2 measuring scoops), and then tamp it down firmly, the coffee should reach the lip of the filter (11) (12).

• Remove any ground coffee which is lying around the filter (13).

• Replace the filter holder into the machine, turn the filter holder until it is firmly locked into place (6) (7).

• Place one or two espresso cups beneath the filter holder.

As soon as the appliance reaches the correct temperature the orange indicator light will go out.

• Then turn the selector to the **LP** setting (9) (10).

• When the cups are full, reset the selector to the **O** setting.

The second myth is that drinking espresso will keep you awake all night. Actually, despite its strong flavour, espresso contains less caffeine than regular coffee: typically 60-80 mg per shot compared to 80-100 mg per cup of coffee and espresso's longer, darker roasting.

And finally, many people think that espresso takes too long to prepare. The truth is, as the name implies, an espresso is intended to be served quickly, without elaborate preparation. As you will discover, your Krups espresso machine has been intuitively designed for easy use and built for the long term.

Description

a	Lark lid
b	Removable water tank
c	Warning plate for cups
d	Stream / coffee selector
e	Start / Stop switch with indicator light (blue)
f	Temperature control light (orange)
g	Brewing head
h	Stream nozzle
i	Cappuccino accessory
j	Drip tray grid
k	Drip tray
l	Filter holder
m	Filter for one or two cups (ground coffee)
n	E.S.T. Filter
o	Storage for filter sieves
p	Claris water filter (not included)
q	Measuring spoon with tamper

Getting Started

In successfully enjoy the full benefits of your new Krups espresso machine, please carefully read these instructions in their entirety before using this product.

• Place your espresso machine on a stable, heat resistant surface away from an electrical heating plate for example or near a flame.

- Remove the filter holder and the filter from the machine, and take out the coffee grounds (14). Use caution not to accidentally discard the filter basket. The filter basket can be refilled to make more espressos.

Caution: If the water container is empty and the pump is running, you will hear a very distinct noise, which is louder than the normal operating sound. If this happens, turn the machine "off". Check the water container and refill as needed. Never let the pump run when the water container is empty as this can damage the pump.

If you are preparing more than one cup of espresso, disregard the orange thermostat light. It simply indicates that the thermostat is regulating the temperature.

WITH THE SPECIAL "E.S.E." FILTER

"E.S.E.", which stands for "Easy Serving Espresso", is a selected measure of coffee, ground and pressed between two filter papers making a coffee pod which is ready to use (for example "illy" pods). This system makes it easy for you to prepare your espresso and to clean the machine.

The E.S.T. system was designed for making Italian-style "espresso ristretto" or "short espresso". The amount of coffee is about two ounces and the water should take 20 seconds to run through.

We do not intend, or recommend, that the E.S.E. servings are used for making more than one single serving or a "long espresso".

We recommend that you take care when handling and storing the E.S.E. servings so that they do not become deformed.

For best results, we recommend that you pre-heat the accessories (filter holder, filter basket and cups) without any coffee. To do this, see section entitled "espresso function" above.

Preparing an espresso:

- Fill the water tank (1) (2) (3) and start the appliance (4).
- Place the serving of "illy" in the ESE filter holder (filled with its own filter). The wording "illy" must be pointing towards the bottom.

Setting the ESE pod (18).

Use excess paper from pod at perforated edge. Place the ESE pod with the RED MARKING FACE DOWN (toward the paper corners down).

- Take care to put all the paper inside the filter or you will have some drips.

Placing the ESE pod correctly will create a richer, thicker crema.

LOCKING: the handle TIGHTLY and PROPERLY will avoid leakage from the filter holder and ensure a better brewing cycle.

Place the filter holder inside the brewing head and FIRMLY turn the handle as far RIGHT as possible.

Once the appliance reaches the correct temperature, the orange temperature control light will go out.

- Then turn the selector to the setting **☪** (9).
- At the beginning, there is a time of pre brewing.

When the recommended quantity of coffee has been reached (about two ounces) turn the selector to the **O** position.

Remove the filter holder from the brewing head and throw away the used coffee pod.

NOTE: Other pods (such as those sold by Starbucks®) can be used in your Krups XP 4000/4020 as long as they are E.S.E. standard pods.

illy® is a registered trademark of illy espresso of the Americas, Inc.
Starbucks® is a registered trademark of the Starbucks Coffee Company.

2. STEAM FUNCTION FOR PREPARING CAPPUCCINO AND LATTE

The humming noise which occurs while steam is being produced comes from the pump and has intermittent regulation of the pump, and has no effect on the proper working of the appliance.

If you wish to make an espresso immediately after using the steam function, the appliance must first be allowed to cool down in order to achieve the correct temperature for preparing an espresso.

- Appliance automatically cools down when turning the selector to the **O** setting. When cooling down the orange indicator light comes on and hot water goes into drip tray.
- When correct temperature is reached, appliance is ready to run the espresso cycle.

Caution: during and after use of the machine, the metallic parts of the cappuccino accessory can become extremely hot.

Using the Cappuccino accessory

The Cappuccino accessory makes it easy to produce frothy milk for making cappuccinos, lattes and hot chocolates.

It is best to use fresh, skim or low-fat milk that is well chilled (kept in the refrigerator). The container must also be cold (do not run it under hot water before frothing the milk).

For heating thick liquids, please refer to the section "Heating thick liquids (e.g. soup)".

We recommend that you clean the cappuccino accessory immediately after use.

- At the beginning, there is a time of pre brewing.
- Fill the water container with fresh, cold water (1) (2) (3) and turn on the appliance (4).

Move the cappuccino accessory to the exterior of the appliance.

- Turn the dial to the **☪** setting (16).

Once the appliance reaches the right temperature, the orange temperature control light will go out.

- Immerse the cappuccino accessory in the milk to be heated (you can use a preferably stainless steel container with a capacity of about 0.5 litres).

Hold the container under the cappuccino accessory in such a way that the tip is immersed in the milk.

- Turn the selector to the **☪** setting (17).

Keep the container straight during this operation. Do not allow the tip of the cappuccino accessory to touch the bottom of the container because this could obstruct the steam output.

- Once you have obtained the desired quantity of frothy milk, turn the selector to the **☪** setting (16) for the following

cleaning operation in order to prevent the milk from drying on the cappuccino accessory.

- remove the container.
- place a container with water under the cappuccino accessory.
- select the **☪** setting again (17) to remove the milk residue.
- turn the selector to the **O** setting.
- clean the cappuccino accessory with a damp cloth.

For more thorough cleaning of the cappuccino accessory, please refer to the paragraph on maintenance.

Heating liquids

- Fill the water container (1) (2) (3) and turn on the appliance (4).

Move the cappuccino accessory to the exterior of the appliance.

- Turn the selector to the **☪** setting (16).
- Once the appliance reaches the right temperature, the orange temperature control light will go out.

Immerse the cappuccino accessory in the container holding the liquid to be heated.

- Then turn the selector to the **☪** setting (17) until the liquid is hot enough, then reset the selector to the **O** setting and remove the container.

For liquids other than water, turn the selector to the setting **☪** (16) for the following cleaning operation in order to prevent any blockage of the opening of the cappuccino accessory:

- place a container with water below the cappuccino accessory.
- select the **☪** setting again (17) to remove the residue of the liquid.
- turn the selector to the setting **O**.
- clean the cappuccino accessory with a damp cloth.

For more thorough cleaning of the cappuccino accessory, please refer to the paragraph on maintenance.

Cleaning the Machine

- Never wash your espresso machine accessories in the dishwasher.
- After use, the water container must be emptied.
- Drip tray**
This must be emptied after using the appliance by taking off the filter (19). If several espressos are being prepared one after the other, the drip tray should be emptied from time to time (about once every 7 - 8 espressos). The presence of water is normal and does not signify a leak. If necessary, clean the drip tray and its grid with water and a little non-abrasive washing-up liquid, rinse and dry. When reassembling the machine, ensure that the plastic lining is in the right place (20).
- The brewing head, the filter basket and the filter holder**
These must be cleaned after each use. All you need to do is wipe a damp cloth over the brewing head of your appliance and to wash the other accessories in water and a little non-abrasive dishwashing liquid, rinse and dry. If the brewing head is heavily clogged up, unscrew the grid using a coin, clean it and refit it, pressing down firmly (21). When your espresso machine is not being used, do not leave the filter holder in the appliance to prevent wear on the gasket.
- The cup warming plate:** remove this to clean it with water and a little non-abrasive dishwashing liquid, rinse and dry.
- The cappuccino accessory**
For more thorough cleaning the cappuccino accessory can be dismantled from the appliance.

Descaling

- Descaling is necessary to keep your espresso machine running efficiently.
- As a result, descaling of your espresso machine should be done fairly frequently with citric or tartaric acid.

- Use caution when descaling your espresso machine as the acid substance within the descaling powder may damage counter-tops or any other surface it comes in contact with.

However, we would advise you to use the reference solution as N° F064 that is available from Krups. Descaling depends on the hardness of the water, but also on the frequency of use.

To descale, follow the following method:

- Unscrew the grid from the brewing head of the appliance and clean it (21).
 - Dissolve a packet of KRUPS descaling solution in 17 oz/510 ml of lukewarm water and pour the whole batch into the empty water container.
 - Place a container under the brewing head. Run through about 1/3 of the liquid immediately, setting the selector to the position **U** (9).
 - Stop the appliance, leaving the position (9) engaged and wait for 10 - 15 minutes to allow the descaler to take effect.
 - Next, start the machine again and allow the rest of the liquid to run through.
 - Then rinse with two water containers of fresh water and replace the grid on the head of the appliance (see section on "Cleaning the machine").
- The warranty does not include espresso machines that do not function, or do not function properly, because descaling has not been carried out.**

Troubleshooting

Problems	Probable causes	Corrective actions
Espresso not hot enough.	Cups, filter and filter holder are cold.	Preheat the accessories (cups, filter, filter holder) before use.
Coffee leaks around the filter holder.	The filter holder is not mounted correctly or has not been tightened sufficiently.	See paragraph «Preparing an espresso».

There are coffee grounds on the edge of the filter.	Clear around the filter and the gasket.	Use fresh coffee.
The brewing head gasket is dry.	Clean the gasket with a damp cloth.	
The blowing head gasket is defective.	Contact an approved Krups service center.	
Leaking through paper pot.	Remove excess paper from pot at perforated edge with the BLD MARKING (ACL DOWN) (hand the paper corners down). Take care to put all the paper inside the filter.	
Pump is very noisy.	No water in the water tank. Water tank incorrectly mounted.	Fill the water tank. Press firmly down on the water tank.
Water does not run through.	Coffee grounds too old or very dry and the pump cannot produce pressure. No water in the water tank. Water tank incorrectly mounted.	Use fresh coffee. Fill the water tank. Press firmly down on the water tank.
	The filter is blocked the coffee grounds are too fine or tamped down too hard.	See the paragraph «Maintenance» and try a coarser coffee.
	Brewing head grid is embedded.	Put the grid to soak in descaling solution. See paragraph «Maintenance».
	Appliance needs descaling.	See paragraph «Descaling».
Water runs through too quickly.	Coffee grounds too coarse. Quantity of ground coffee is insufficient.	Try a finer coffee. Use the spoon provided to measure out the coffee.

Recipes

Savor your espresso just as you like it, when you want to relax or to top off a good meal. Here are a few recipes that you will be able to create with your espresso machine.

- Original espresso**
- Take one measuring spoonful of good quality well roasted espresso coffee, and make an espresso directly into a pre-heated cup.
- If you use good, finely ground coffee, the cup will be crowned by a fine head of golden crema.
- Add sugar if desired and enjoy.
- Cappuccino**
- For café quality cappuccino, the ideal quantities are as follows: 1/3 coffee, 1/3 hot, steamed milk, 1/3 frothy milk.
- Use 5 oz. cups/150 ml that have been pre-heated.
- Fill them with 1/3 espresso coffee. Using the cappuccino accessory, fill the cup with another 1/3 of steamed milk and 1/3 of froth.

- Lastly, sprinkle with drinking chocolate powder or cinnamon.

• Cafe latte

For a latte of the art latte, the ideal quantities are as follows: 1/3 espresso, 2/3 hot, steamed milk topped with some frothed milk.

- Prepare a classic espresso in a large cup.
- Add steamed milk.
- Top with some froth.

LIMITED WARRANTY

This Krups product is warranted for 1 year from the date of purchase against defects in material and workmanship. During this period, the Krups product that, upon inspection by Krups, is proved defective, will be repaired or replaced, at Krups' option, without charge to the customer. If a replacement product is sent, it will carry the remaining warranty of the original product. This warranty does not apply to any defect arising from a buyer's or user's misuse of the product, negligence, failure to follow Krups' instructions, use on current or voltage other than that stamped on the product, wear and tear, alteration or repair not authorized by Krups, or use for commercial purposes.

THE WARRANTIES SET FORTH HEREIN ARE EXCLUSIVE AND NO OTHER WARRANTIES, EXPRESS OR IMPLIED, INCLUDING BUT NOT LIMITED TO ANY WARRANTY OF MERCHANTABILITY OR FITNESS FOR A PARTICULAR PURPOSE OR USE, ARE MADE BY KRUPS OR ARE AUTHORIZED TO BE MADE WITH RESPECT TO THE PRODUCT.

Some states do not allow limitation on how long an implied warranty lasts or do not allow the exclusion of incidental or consequential damages, so the above limitations may not apply to you. This warranty gives you specific legal rights, and you may also have other rights, which vary from state to state.

If you believe your product is defective, bring the product (or send it, postage prepaid) along with proof of purchase to the nearest authorized Krups Service Center. (Please contact your respective country's customer service department, indicated below, for the address of the nearest authorized Krups Service Center.)

If you send the product, please include a letter explaining the nature of the claimed defect.

Free Manuals Download Website

<http://myh66.com>

<http://usermanuals.us>

<http://www.somanuals.com>

<http://www.4manuals.cc>

<http://www.manual-lib.com>

<http://www.404manual.com>

<http://www.luxmanual.com>

<http://aubethermostatmanual.com>

Golf course search by state

<http://golfingnear.com>

Email search by domain

<http://emailbydomain.com>

Auto manuals search

<http://auto.somanuals.com>

TV manuals search

<http://tv.somanuals.com>