

# User's guide

EKE 854.1/804.2/604.2  
KC 906.2

---

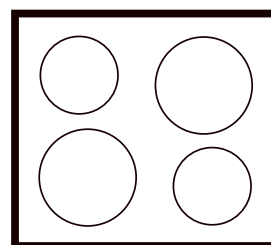



# Warranty

This warranty is extended to the original purchaser and succeeding owners for products purchased for ordinary home use. It does not cover its use in a commercial situation. Should the appliance be sold by the original purchaser during the warranty period, the new owner will continue to be protected until the expiration date of the original purchaser's warranty period. Save your dated receipt or other evidence of the installation/occupancy date. Proof of original purchase date is needed to obtain service under warranty. The warranty applies even if the owner should move during the warranty period.

KÜPPERSBUSCH does not assume any responsibility for consequential or incidental damages. This warranty provides you with certain legal rights. You may also have other rights which may vary from state to state.

## What Is Covered

For one full year from the date of the original purchase, we will provide parts, service and labor in your home to repair or replace any part of the cook top that fails because of a defect in materials or workmanship. This service is provided free of charge. All warranty service will be provided by our authorized Customer Care professionals during normal business hours.

## What Isn't Covered

1. Service by an unauthorized agency will not be reimbursed. Likewise, the warranty doesn't cover any damage or repairs due to service performed by an unauthorized agency, or by the use of unauthorized parts.
2. Service visits to teach you how to use the appliance.
3. Service visits to correct the installation. You are responsible for providing electrical wiring and other connecting facilities.
4. Reset circuit breakers or replace home fuses.
5. Damage resulting from accident, alteration, misuse, improper installation, abuse or installation not in accordance with local electrical codes, or improper storage of the appliance.
6. Repairs due to other than normal household use.

# Disposing of the packaging and the old appliance

Be sure to dispose of the transport packaging properly. Disposal should not have a negative impact on the environment. Recycling the packaging saves raw materials and reduces the amount of waste.

Be sure to dispose of your old appliance properly, as well. Even if it can no longer be used, it still contains useful materials. Before discarding an old appliance, disconnect the power cord to prevent it from becoming a hazard.

# For your information...

Carefully read the information in this manual before you use your appliance. You'll find important information about safety and how to use, maintain and service your appliance so that it enjoys a long service life.

If you experience any problems, first be sure to read the chapter titled "What to do if trouble occurs...". Usually it's easy to solve minor problems yourself and avoid unnecessary service costs.

Please keep this manual in a safe place and pass it on to new owners for their information and safety.

## The following symbols are used in this operating manual:

 The warning triangle will alert you about possible health risks or things that can cause potential damage to your appliance.

 You'll find useful hints and information when you see this symbol.

# Content

Warranty . . . . .	3
Disposing of the packaging and the old appliance . . . . .	3
For your information.... . . . . .	3
Safety instructions . . . . .	4
Before using the first time. . . . .	4
Your appliance at a glance . . . . .	5
Using the cook top . . . . .	5
Sensor sensitivity reset	
Switch on a cooking zone (Stand-by-mode)	
The cooking setting	
Switching off a cooking zone:	
Switching off the cooking surface	
Using the automatic boost function	
Frying or dual-circuit cooking zone	
Cooking zone heating indicator	
Child proof lock (sensor-lock)	
Time limit function (holiday function)	
What happens if...	
Selecting pots and pans . . . . .	8
Cleaning and care . . . . .	9
Please note the information for the cleaning scraper	
Cleaning the cooking surface	
Remove caking	
Care of the cooking surface	
What to do if trouble occurs... . . . . .	9
After Sales Service. . . . .	10

For technical information and/or replacement parts, please contact the **Küppersbusch Customer Care line** at **1-800-459-0844**. For the most efficient assistance, please have the Model and Serial numbers for the appliance available.

# Safety instructions



- The cooktop must be built into a countertop opening! Do not use the appliance if it has not been installed!
- Be sure the appliance is properly installed and grounded by a qualified technician.
- The appliance may only be installed and connected to the power supply, maintained, and repaired by a qualified electrician in accordance with safety regulations. Do not repair or replace any part of the appliance unless specifically recommended in this manual. Work performed incorrectly puts your safety at risk.
- This appliance is for residential use only. Use for any other purpose is at the owner's risk and could be dangerous. The manufacturer can't be held responsible for damage caused by improper use of this appliance.

- **Danger of burning!** The cook top becomes hot during operation. **CAUTION!** Keep children away from this appliance.

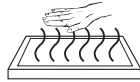

- **CAUTION!** Items of interest to children should not be stored in cabinets above a cooktop. A child can be seriously injured by climbing on a cooktop to reach them.
- Do not leave children alone - children should not be left alone or unattended in area where appliance is in use. They should never be allowed to sit or stand on any part of the appliance.
- Do not touch the cooking surface or areas near it. The cooking surface may be hot even though it's dark in color. Areas near it may become hot enough to cause burns. During and after use, do not touch the surface, or let clothing or other flammable materials come in contact with it until it had time to cool.
- Use proper pan size - This appliance is equipped with some surface units of different size. Select utensils having flat bottoms large enough to cover the surface unit heating element. The use of undersized utensils will expose a portion of the heating element to direct contact and may result in ignition of clothing. Proper relationship of utensil to burner will also improve efficiency. See also „Selecting pots and pans“ on page 8.
- Flammable materials should not be stored near surface units. Do not place combustible or inflammable objects upon the cooking top which might be dangerous in case of unintentional switching on.
- Protective liners – Do not use aluminium foil to line surface unit drip bowls. Improper installation may result in a risk of fire.
- The glass ceramic surface is very durable and can easily withstand light to medium impacts and loads distributed over large areas. Be sure to avoid concentrated loads (i.e. spice bottles) from falling on the surface to avoid cracking or breaking the cooking surface.
- **CAUTION!** If the cooking surface becomes cracked or fractured, quit using the appliance immediately. Disconnect the power and call Customer Service. Cleaning solutions and spillovers may penetrate the broken cooktop and create a risk of electric shock.
- **Never flambé under the cooker hood - the fat in the filter can ignite!**
- **CAUTION!** Overheated greases and oils may ignite themselves. Prepare meals with greases and oils very carefully and control the heat. Should fats or oils ignite, do not use water to extinguish them! Smother fire or flame or use dry chemical or foam-type extinguisher.

- The connecting cable must not come in contact with the hot cooking surface.
- Don't switch the cooking surface on unless you're using it for cooking. Never use a cooking zone without a pot or pan set on it. Never use the appliance to heat a room!
- Never leave the cooking surface unattended at high heat settings. Boilover can cause smoking and greasy spillovers that may ignite.
- Wear proper apparel. Loose-fitting or hanging garments should not come in contact with the cooking surface. Dish cloths, potholders and aprons should not be stored near the surface units.
- To reduce the risk of burns, ignition of flammable materials, and spillage due to unintentional contact with the utensil, the handle of an utensil should be positioned so that it is turned inward, and does not extend over adjacent surface units.
- Use only dry potholders. Moist or damp potholders on hot surfaces may result in burns from steam. Do not let potholder touch a hot surface. Do not use a towel or other bulky cloth.
- **CAUTION!** Only certain types of glass, glass/ceramic, ceramic, earthenware, or other glazed utensils are suitable for range-top service without breaking due to the sudden change in temperature. Follow the manufacturer's instructions!
- Do not place non-food items on the cooking surface when it's hot.
- Be careful when working with attachments! The connecting cord must not come in contact with the hot cooking surface.
- **Do not put plastic on the cooking surface.** Things that can melt (i.e. plastics, foils or sugar), must be kept away from the cooking surface. Be sure to **immediately remove or lift off any melted item from the hot cooking surface.** Use the supplied cleaning scraper in order to avoid damage to the cooking surface.
- Clean and remove any burned-on materials. Don't heat these materials repeatedly.
- If a wet sponge or cloth is used to wipe spills on a hot cooking area, be careful to avoid steam burn. Some cleaners can produce noxious fumes if applied to a hot surface.
- Lime deposits are harmful to the cooking surface.
- Please follow the cleaning and maintenance instructions carefully!

## Before using the first time

- Before using the appliance the first time, be sure to clean the cooking surface with a mixture of water and mild detergent on a clean cloth. Then wipe the surface dry with a non-fluffy cloth.

# Your appliance at a glance

EKE 854.1  
KC 906.2

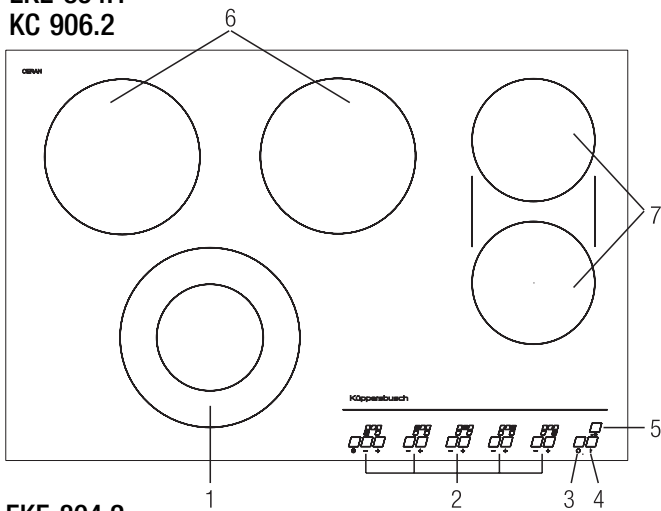

EKE 804.2

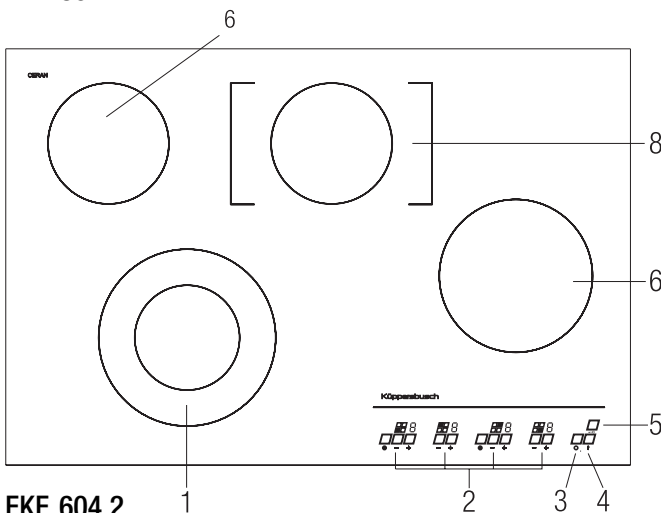

EKE 604.2

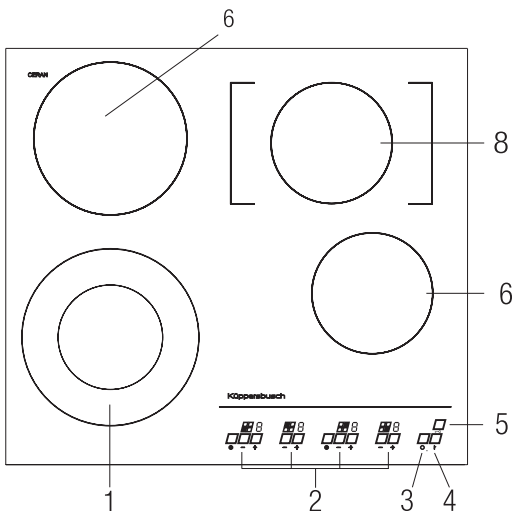

- 1 Dual circuit cooking zone
- 2 Sensor buttons for cooking settings
- 3 Off-sensor
- 4 Stand-by-Sensor
- 5 Child proof lock (sensor-lock)
- 6 Normal cooking zone
- 7 Normal cooking zones, usably as a frying zone
- 8 Frying zone

# Using the cook top

Read the safety instructions!

## Sensor sensitivity reset

### Important:

**There must be no objects on the sensors while the sensor sensitivity is being set.**

**After initial connection and after a power failure** the abbreviations "C R L" appears briefly in the LED displays. Then rotating circles are displayed. This means that the sensors are being checked in a self-test and at the same time the button sensitivity reset.

– Acknowledge this display by touching the Off-sensor.

**Be sure that no objects are lying on the sensors!** These symbols are switched off immediately.

– Otherwise remove objects and disconnect the cooking zone again briefly from the main power source.

## Switch on a cooking zone (Stand-by-mode)

If you start to use a cooking zone, the cook top must be first set into the stand-by mode before you can activate the cooking zone.

When you turn the cooking surface on, you will hear a short buzzing noise as it heats. This is design-specific and does not affect the quality and operation of the appliance.

– Press the sensor-button for approx. 2 seconds.

The LED-display above the sensor lights up and the appliance is in operation (stand-by mode).

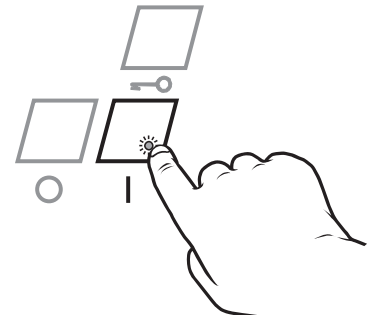

The stand-by mode automatically switches itself off,

– if no cooking zone is activated within 20 seconds (after 10 seconds an acoustic signal indicates that the appliance switches itself off after another 10 seconds)

or

– if the appliance is not used 1 minute after starting operation.

## The cooking setting

You have 9 cooking settings available.

Cooking setting	Suitable for
1-3	Heating, warming, browning, defrosting
4-5	Steaming, poaching, boiling
6-8	Roasting, deep-frying
9	Heating large quantities

Select the required cooking setting with the plus- or minus-sensor. It will be indicated in the display.

Using the minus-sensor, you start with a boost. If you use the plus-sensor, you start without a boost.

When **pressing the plus-sensor** the cooking zone **starts** at cooking setting 5, **without boost**.

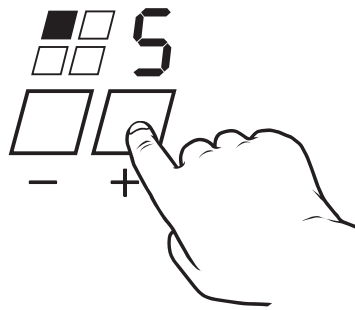

When **pressing the minus-sensor** the cooking zone starts at cooking setting 9. This **automatically starts the automatic boost**.

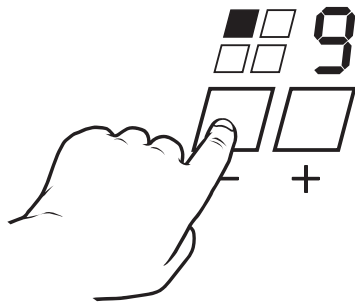

### Switching off a cooking zone:

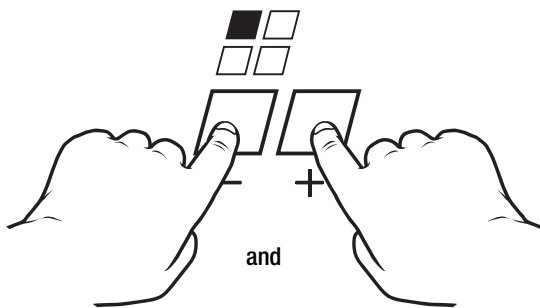

Press the plus- and minus-sensor at the same time.  
The "0" position is visible for about 2 seconds after the appliance switches off.

### Switching off the cooking surface

All the cooking zones can be switched off quickly with the Off-sensor.

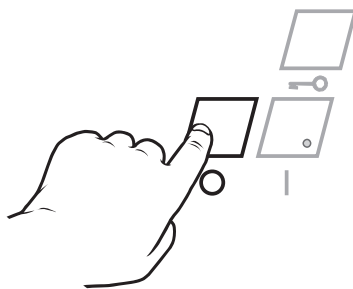

### Using the automatic boost function

All cooking zones are equipped with an automatic boost function. Maximum power is used for the boost. The time period of the boost depends on the selected cooking setting. After the elapsed time the cooking zone automatically switches back to the selected cooking setting.

#### If the cooking zone is yet not in use

- Press the minus-sensor until the required cooking setting is displayed, the boost function switches on automatically.

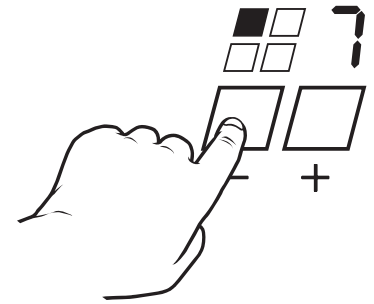

During automatic operation a "A" lights up in the display alternately with the selected cooking setting.

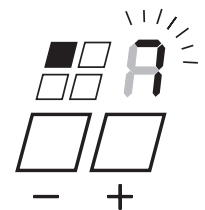

#### If you already use the cooking zone

- Press the plus-sensor again after reaching cooking setting 9. The automatic boost function is activated.

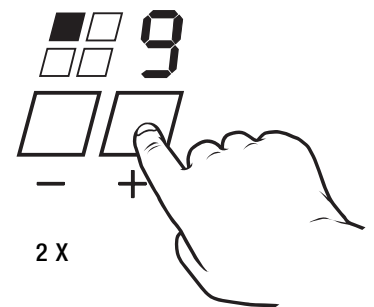

Select the required cooking setting.

"A" lights up in the display alternately with the selected cooking setting.

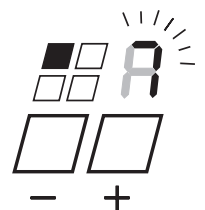

## Frying or dual-circuit cooking zone

As a rule, only the smaller cooking zone diameter is heated. However, when using frying pans and large saucepans, you may decide to switch on the outer cooking zone circuit.

### Switching the frying or dual-circuit zone on:

- Press the cooking zone symbol next to the plus/minus-sensor.
- Pressing the cooking zone symbol once again deactivates the dual circuit cooking zone or frying zone.

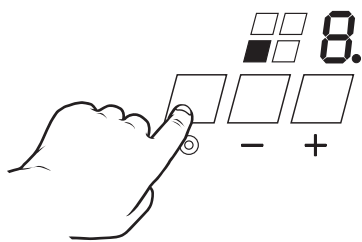

### Model EKE 854.2 and KC 906.2 only:

To heat a frying pan you can use the two small, closely adjacent cooking zones. The temperature must be controlled via the setting controls for both cooking zones. We recommend to set both cooking zones at the same cooking level.

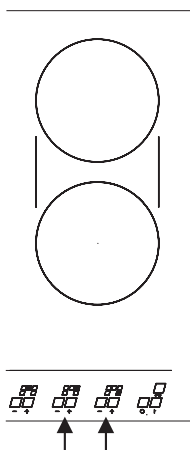

## Cooking zone heating indicator

As long as the cooking zone is still hot, an "H" will appear in the display when the cooking zone has been switched off.

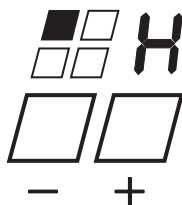

## Child proof lock (sensor-lock)

Operating the sensor lock detains unauthorised persons from using the appliance. In order to activate this lock the cooking area has to be in operation.

### Activating child proof lock:

Press the sensor lock (2 seconds). The child proof lock can be activated if the cooking area is in operation. In this case you can only choose a lower cooking setting or switch off.



The lock is indicated by 3 flashing control indicators.

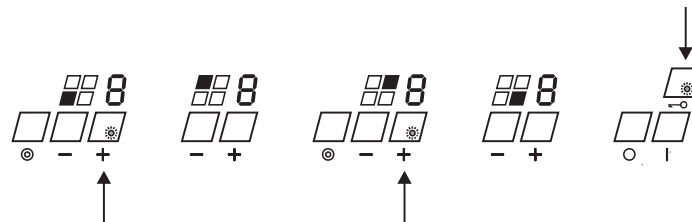

**Be careful:** Switching off the cooking area does not deactivate the lock!

### Deactivating the child proof lock:

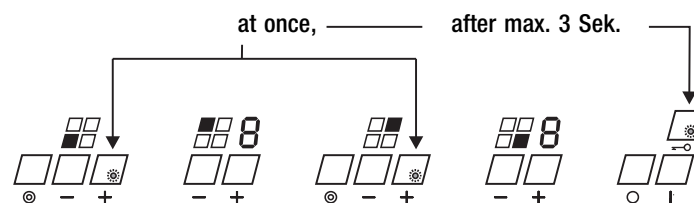

Press the sensors under the two left flashing control indicators at once. After not more than 3 seconds press the sensor under the flashing control indicator on the right.

**Note:** When the power supply has been interrupted the child proof lock is no longer active.

## Time limit function

The appliance is equipped with an automatic time limit function. This function makes sure that the appliance is not in operation for a long time. The time period of the time limit depends on the selected cooking setting, eg.: The higher the selected cooking setting, the faster the appliance is switched off.

Cooking setting	Switching off time after
9 8 7 6	1 hours
5	3 hours
4	4 hours
3 2	5 hours
1	10 hours

The function to limit operation time works separately for each cooking zone..

## What happens if...

- **...pressing two or more sensor keys – at the same time e.g. when a pan is mistakenly put onto the sensor key?**  
No function is activated. An audible signal sounds after 10 seconds. The appliance switches off automatically after 20 seconds.
- **...you continue to press a sensor button even after having set the highest cooking setting?**  
An audible signal sounds after 10 seconds. After 20 seconds the appliance switches off automatically.
- **...there is a power outage?**  
The appliance does not automatically switch on again. If the child proof lock was activated before the power failure, this is now deactivated.
- **...the electronics overheat?**  
The cooktop will switch off. All 4 LED indicators will flash and a cyclical signal will be heard.

## Selecting pots and pans

**⚠ CAUTION!** Only certain types of glass, glass/ceramic, ceramic, earthenware, or other glazed utensils are suitable for range-top service without breaking due to the sudden change in temperature. Follow the manufacturer's instructions!

**You can save time and power by using ideal pots and pans.**

- Use pots and pans with flat, smooth bottoms. Uneven bottom surfaces can increase the amount of time needed to start the cooking process and increase energy usage.

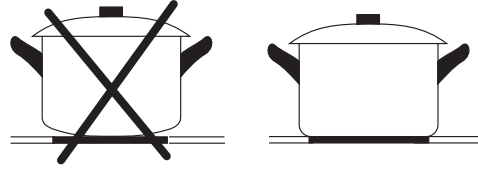

- Rough pan bottom surfaces will scratch the glass-ceramic cooking area when moved around.
- Use a pan with a diameter at least as large as the cooking area. Using an undersized utensil will expose a portion of the heating element to direct contact and may result in ignition of clothing.

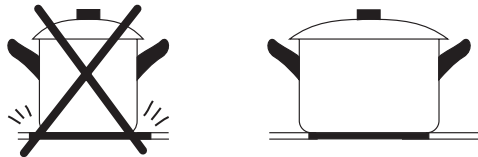

- Wherever possible, always place a lid on the pan. You'll save a lot of energy by cooking in a closed pan. Liquids and foods will only boil over if the temperature is too high. The cooking zones allow you to precisely set the temperature required. With a little practice, you'll learn how to choose the perfect cooking settings so nothing will boil-over even when a lid is in place!

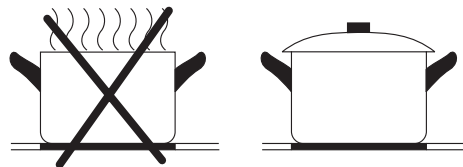



# Cleaning and care

⚠ **Sugar and food containing sugar** (i.e. marmalade) and **melted plastic** must **immediately** be removed from the hot cooking surface with the cleaning scraper. If not, the cooking surface can be ruined while it's cooling down.

⚠ Steam and/or pressure cleaning machines can't be used to clean the appliance! This can damage the unit, resulting in the risk of **personal injury**.

⚠ **Risk of burning!** Make sure the appliance has cooled down before cleaning. If a wet sponge or cloth is used to wipe spills on a hot surface, be careful to avoid steam burn. Some cleaners can produce noxious fumes if applied to a hot surface.

⚠ Please note the instructions regarding cleansers.

☞ Clean the cooking surface after every use. Food residue that hasn't been removed will burn into the surface the next time it's turned on and then these incrustations may be permanent.

☞ Cleanser residues can cause discoloration the next time you turn on the cook top. Cloths and sponges that have been used to clean other surfaces can cause discoloring, too.

☞ VSR O-FIX-C is the perfect cleanser for glass ceramic. You can get it from KÜPPERSBUSCH Customer Service.

## Do not use any

- aggressive or bleaching cleaning agents that contain active oxygen, chlorine or corrosive components.
- abrasive or aggressive cleaning or scouring agents like steel wool, soap-filled steel wool, metal or plastic sponges or similar agents with an abrasive surface.

## Please note the information for the cleaning scraper

⚠ **CAUTION!** Risk of cutting! The blade of the cleaning scraper is very sharp! Always keep the cleaning scraper flat on the surface and push the caking away.

⚠ Do not scratch the surface with the edge of the scraper and don't damage the sealing with the edge.



## Cleaning the cooking surface

- Use the cleaning scraper to remove all food residue and fat splashes from the hot cooking surface.
- When the cooking surface has cooled, clean it with water and a small amount of detergent, with a cleanser for glass ceramic surfaces or with VSR O-FIX-C. A soft brush or a soft sponge can also be used.
- Wipe off the surface with clear water.
- Dry it thoroughly.

## Remove caking

Heavy food residue should be soaked first. Use a wet cloth for best results. It will be easier to remove the food residue.

## Care of the cooking surface

Clean the glass ceramic surfaces with a cleanser to protect it from discoloring, and reduce the danger of damage from sugar. It can also remove stains and discoloration

# What to do if trouble occurs...

⚠ Never unscrew the appliance! Repairs may only be carried out by a qualified technician!

However, there are some problems that you can handle yourself. First, check and see if there have been any operating errors. Remember – repairs during the warranty period are not free of charge if they are caused by operating errors or non-observance of the following instructions:

Fault	Possible cause	Remedy
Cooking surface can't be switched off.	Regulator or electronic component is defective.	See below: "What is to be done if..."
The LED indicator for the cooking level or heat indicator does not light up or only partly lights up.	LED indicator defective.	Call customer service. ⚠ Risk of burning, as there is no temperature warning.
Circulating dash symbols on all 4 LED displays.	No faults; normal display after power interruption.	If no objects have been lying on or obstructing the sensors, confirm this by pressing the Off-sensor.
Horizontal dashes that are shown on the display running from top to bottom.	Failure of electronic component.	Switch off the fuse. Call Customer Service.
Cooking area does not heat.	Fuse is defective.	Check the fuse and replace, if necessary.
	Child proof lock activated.	Deactivate child proof lock.
	Cooking area is defective.	Call Customer Service.
Individual / all sensors do not react to touch.	Inner circuit of the dual-circuit zone is defective.	⚠ Do not, under any circumstances, continue to use the outer circuit which is still working! It will destroy the glass ceramic surface. Call Customer Service.
		See below: "What is to be done if..."

## What is to be done if...

### ... one or more sensors don't react to touch?

**Possible cause:** The sensors constantly adapt in sensitivity to ambient conditions. Unfavorable conditions such as e.g. if something is laying on a sensor, may cause them not to react for several minutes.

*Wait for about 15 minutes or pull the relevant fuse and then re-insert it. Repeat this procedure if necessary!*

The keys have adapted and now react to touch again.

### ... one or more sensors don't react to touch despite repeating this procedure?

Possible cause: Faulty sensor key or component.

*If you've repeated the procedure and the keys still don't react, pull the fuse again and then contact our Customer Service.*

# After Sales Service

In the event of a problem that you can't easily fix yourself, or for spare part service, please contact the Küppersbusch Customer Care line at

**.1-800-459-0844**

☞ Always have the information from the identification panel handy when calling Customer Service.

The panel is located on the underside of the cook top and on the cover page of this manual.

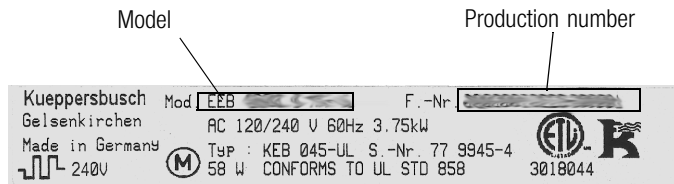



## KÜPPERSBUSCH

112 N. East Street, Suite C

Tampa, Florida 33602

Telephone: 813-229-7096 Fax: 813-229-0982

**Customer Care line: 1 - 800 - 459 - 0844**

[www.kuppersbuschusa.com](http://www.kuppersbuschusa.com)

KÜPPERSBUSCH is a brand of Teka USA, Inc.

**Küppersbusch**

THE HEART OF A GOOD KITCHEN

## Free Manuals Download Website

<http://myh66.com>

<http://usermanuals.us>

<http://www.somanuals.com>

<http://www.4manuals.cc>

<http://www.manual-lib.com>

<http://www.404manual.com>

<http://www.luxmanual.com>

<http://aubethermostatmanual.com>

Golf course search by state

<http://golfingnear.com>

Email search by domain

<http://emailbydomain.com>

Auto manuals search

<http://auto.somanuals.com>

TV manuals search

<http://tv.somanuals.com>