

# User's guide

EEB 9800.0

---

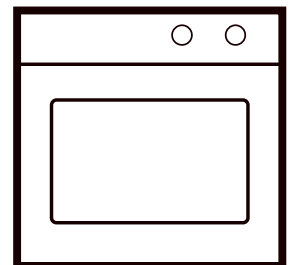

## For your information...

Be sure to read the information in this manual carefully before you use your oven. You'll find important information about safety and how to use, maintain and service your appliance to ensure a long service life. If you experience any problems, first be sure to read the chapter titled, "What to do if trouble occurs...". Usually it's easy to solve minor problems yourself and avoid unnecessary service costs.

Please keep this manual in a safe place and pass it on to future owners for their information and safety.

### The following symbols are used in this operating manual:

 The warning triangle will alert you about possible health risks or things that can cause potential damage to your appliance.

 You'll find useful hints and information when you see this symbol.

## Warranty

This warranty is extended to the original purchaser and succeeding owners for products purchased for ordinary home use. It does not cover its use in commercial situations. Should the appliance be sold by the original purchaser during the warranty period, the new owner will continue to be protected until the expiration date of the original purchaser's warranty period. Save your dated receipt or other evidence of the installation/occupancy date. Proof of original purchase date is needed to obtain service under warranty. The warranty applies even if the owner should move during the warranty period.

KÜPPERSBUSCH does not assume any responsibility for consequential or incidental damages. This warranty provides you with certain legal rights. You may also have other rights which may vary from state to state.

### What Is Covered







For one full year from the date of the original purchase, we will provide parts, service and labor in your home to repair or replace any part of the oven that fails because of a defect in materials or workmanship. This service is provided free of charge. All warranty service will be provided by an authorized technician during normal business hours.

### What Isn't Covered

1. Service by an unauthorized agency will not be reimbursed. Likewise, the warranty doesn't cover any damage or repairs due to service performed by an unauthorized agency, or by the use of unauthorized parts.
2. Service visits to teach you how to use the appliance.
3. Service visits to correct the installation. You are responsible for providing electrical wiring and other connecting facilities.
4. Reset circuit breakers or replace home fuses.
5. Damage resulting from accident, alteration, misuse, improper installation, abuse or installation not in accordance with local electrical codes, or improper storage of the appliance.
6. Repairs due to other than normal household use.

For technical information and/or replacement parts, please contact the **Küppersbusch Customer Care line** at **1-800-459-0844**. For the most efficient assistance, please have the Model and Serial numbers for the appliance available.

# Contents

<b>For your information...</b> . . . . .	<b>2</b>	<b>Overview of heating programmes.</b> . . . . .	<b>17</b>
<b>Warranty</b> . . . . .	<b>2</b>	<b>The minute minder</b>  . . . . .	<b>17</b>
<b>Contents.</b> . . . . .	<b>3</b>	<b>The child safety lock</b>  . . . . .	<b>17</b>
<b>Safety instructions.</b> . . . . .	<b>4</b>	Activating / deactivating the child safety lock	
<b>Before using the appliance for the first time.</b> . . . . .	<b>4</b>	<b>Setting optional functions.</b> . . . . .	<b>18</b>
Disposing of the packaging and the old appliance		Overview of optional functions	
Setting the clock		1. Select language	
Initial cleaning		2. Activate "Optional functions" selection menu	
<b>Your appliance at a glance</b> . . . . .	<b>5</b>	3a. Memory functions 1 and 2	
<b>The control panel - sensor keys and displays</b> . . . . .	<b>6</b>	3b. Eco function ON / OFF	
<b>General information on your oven</b> . . . . .	<b>7</b>	3c. Maximum cooking time	
General Information		4. End selection mode	
Oven trays		<b>How to use the telescopic glide-out shelves (acc.-no. 601).</b> . . . . .	<b>19</b>
Rack levels		Inserting the oven trays correctly	
Telescopic glide-out shelves (acc.-no. 601)		Pulling out the trays	
Turning the oven light on and off		Pushing in the trays	
<b>Using your oven</b> . . . . .	<b>8</b>	Shelf levels, cooking times and temperatures	
General Information		Special accessories	
Explanation of the colored symbols.		<b>Cleaning and Care.</b> . . . . .	<b>20</b>
Switching on the oven		For all surfaces	
Selecting a roasting programme		Remove caking	
Selecting a baking programme		Information about the cleaning scraper	
Select the heating programme		The use of oven sprays - information	
Altering the cooking temperature		Enamel	
Altering / Setting the cooking time		Stainless steel	
Setting the finish time		Glass	
Automatic turn-on and shut-off		Aluminium	
Change automatic weight  / weight system		Door sealing	
Switching the oven off		Knobs	
Resuming interrupted programmes		Removing and installing the oven door	
Blend in the actual oven temperature		Removing and installing the side racks	
<b>Additional functions.</b> . . . . .	<b>9</b>	Folding heating element down/up	
Rapid heating 		Unscrewing/reinstalling the individual telescopic glide-out shelves (acc.-no. 601)	
Memory function  / 		Regenerating the ökotherm <sup>®</sup> catalyst	
<b>Roasting.</b> . . . . .	<b>10</b>	<b>What to do if trouble occurs....</b> . . . . .	<b>22</b>
Selecting a programme		Replacing a halogen bulb	
Turning the roast		Replacing the door sealing	
Roasting on the oven rack		<b>After Sales Service</b> . . . . .	<b>23</b>
Roasting in a pan		<b>Rating Label</b> . . . . .	<b>24</b>
Roast using the heating programmes			
Some instructions on roasting programmes			
Overview of roasting programmes			
Guideline values for roasting using the heating programmes			
<b>Roasting thermometer and core temperature function</b> . . . . .	<b>12</b>		
Correct roasting thermometer insertion			
Using the roasting thermometer			
Setting the core temperature function			
Setting delayed cooking begin			
Recommended core temperatures			
<b>Baking</b> . . . . .	<b>13</b>		
Selecting a programme			
Baking programme overview			
Baking with heating programmes			
Baking pizza			
Notes on the table: "Guidelines for baking"			
Guidelines for baking			
Grilling			
Guidelines for grilling			
Defrosting and proving 			
Preserving			

# Safety instructions



- Be sure your appliance is properly installed and grounded by a qualified technician.
- Check after installation that the fastening screws are securely seated and that the appliance cannot be moved.
- KÜPPERSBUSCH built-in ovens may only be connected to the corresponding KÜPPERSBUSCH built-in cook tops by a qualified and authorized technician. Only qualified personnel should perform installations and repairs on electrical appliances. Do not repair or replace any part of the appliance unless specifically recommended in this manual. Do not put your safety at risk.
- Do not operate the appliance until it has been properly installed within cabinetry.
- **Do not leave children alone!** Children should not be left alone or unattended in area where appliance is in use. They should never be allowed to sit or stand on any part of the appliance.
- The surfaces of the oven door and the appliance are hot when in operation. Do not let children in, on or around the appliance or its controls!
- Never use your appliance for warming or heating the room.
- Make sure connection cables for electrical devices are not jammed in the oven door.
- **WARNING!** Never use steam and/or pressure cleaning machines to clean the oven! This can damage the unit and increase the risk of personal injury.
- The appliance is intended for residential use only. Use for any other purpose is at the owner's risk and could be dangerous. The manufacturer cannot be held responsible for damage caused by improper use of this appliance.
- When performing repairs and replacing oven light bulbs, be sure to disconnect the power supply by either removing the plug or manually "tripping" the circuit breaker.
- Do not store objects in your oven that could become a hazard if the oven is unintentionally turned on.
- **CAUTION!** Items of interest to children should not be stored in cabinets above a cooktop. A child can be seriously injured by climbing on a cooktop to reach items.
- Do not heat unopened food containers. Build-up of pressure may cause container to burst and result in injury.
- Heat resistant oven mitts/gloves are recommended when placing items in the oven, turning them, or removing them from the oven. The top heating element and oven racks can become very hot and cause burns, even though they are dark in color.
- Use only dry potholders. Moist or damp potholders on hot surfaces may result in burns from steam. Do not let potholder touch hot heating elements. Do not use a towel or other bulky cloth.
- Always place oven racks in desired location while oven is cool. If rack must be moved while oven is hot, do not let potholder contact hot heating element in the oven.
- Be careful when opening the oven door when the oven is hot. Don't position yourself directly in front of the oven door. Allow hot air or steam to escape before placing or removing food.
- Wear proper apparel. Loose-fitting or hanging garments should not be stored in an oven or near surface units.

- Do not use water on grease fires. Smother fire or flame or use dry chemical or foam-type extinguisher.
- The oven door must close well. In the event of damage to the hinges or to the glass pane, do not use the appliance until it's been repaired and checked by a qualified professional.
- If the door sealing is damaged, it must be replaced. The oven must not be used with damaged door sealing.
- Keep the oven vent ducts unobstructed.
- Always be sure to close the oven door completely.
- Keep a distance of at least 5 cm (2 inches) from the grill and top heat.
- Only use the original roasting thermometer.
- Do not jam the cable of the roasting thermometer in the oven door.
- Take roasting thermometer out of the oven when not being used.
- Keep it at a distance of at least 5 cm (2 inches) from the grill and top heat.

## Before using the appliance for the first time



### Disposing of the packaging and the old appliance

Be sure to dispose of the transport packaging properly. Disposal should not have a negative impact on the environment. Recycling the packaging saves raw materials and reduces the amount of waste.

Be sure to dispose of your old appliance properly, as well. Even if it can no longer be used, it still contains useful materials. Before discarding an old appliance, disconnect the power cord and remove the door to prevent it from becoming a hazard.

### Setting the clock

The clock must be set before the oven is used and whenever power has been disconnected to the appliance. The display in such cases is "0.00".

- Touch the surface next to the OFF-key  on the left until it blinks and <set time> is displayed.
- Set the current time using the knob.
- Confirm with 



### Initial cleaning

- Remove labels, accessories and packaging from the oven.
- Clean the appliance before preparing food for the first time. Clean the drip pan, oven rack etc. with a damp cloth and a solution of warm water and a non-abrasive detergent. Dry the interior with a soft cloth.
- **Heating the oven**  
Close the oven door.  
Heat up the oven with top heat/bottom heat  at 480 °F / 250 °C for 60 minutes.  
Make sure that the room is well ventilated.

# Your appliance at a glance

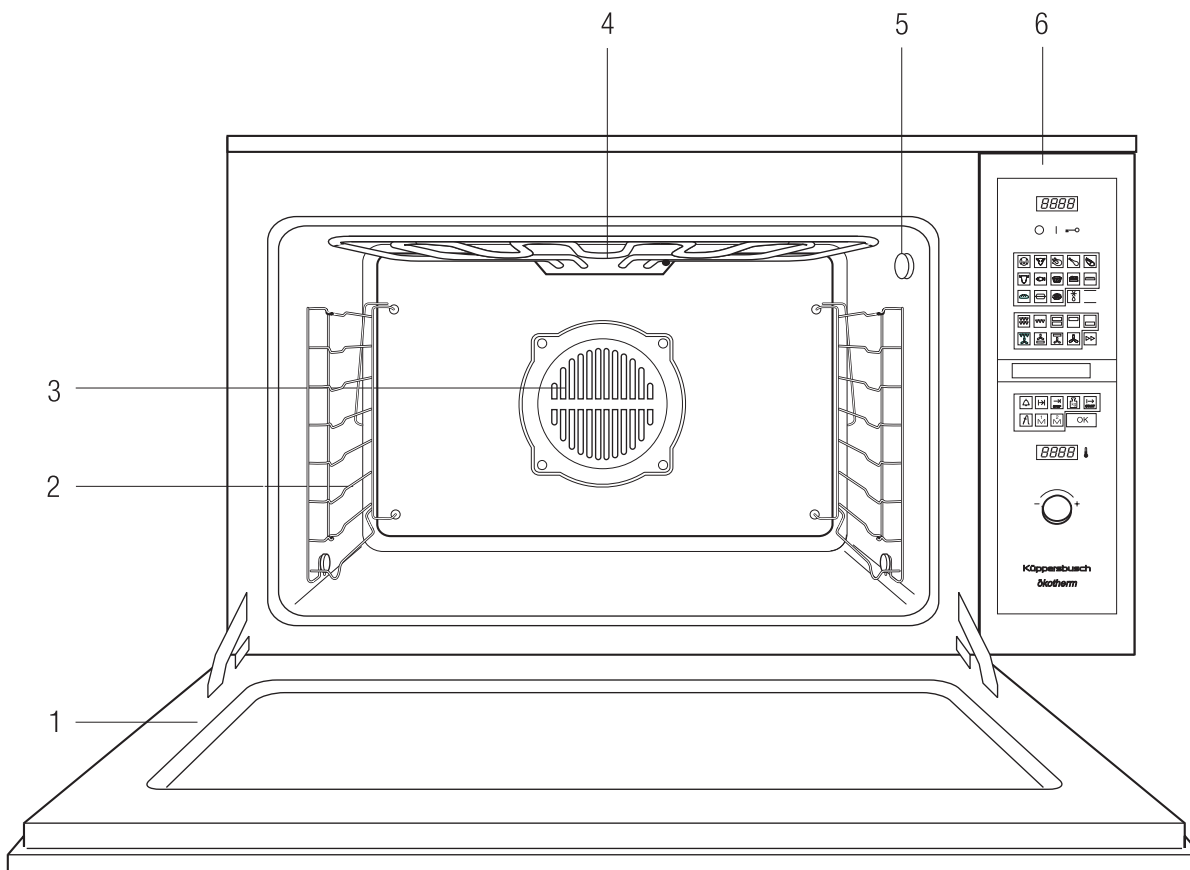

- 1 Oven door
- 2 Rack levels
- 3 Hot air fan
- 4 Fold-down grill (top heat and grill)
- 5 Socket for roasting thermometer
- 6 Control panel

An overview of the control panel is given on page 6.

## Accessories supplied:

- Oven Rack
- 2 Baking tray (enamel)
- Drip pan (enamel)
- Roasting thermometer

## Accessories available:

- Maxi Pizza stone (acc. no. 146)
- Telescopic glide-out shelves (acc. no. 601)

## for the telescopic glide-out shelves:

- Oven rack, depressed, e.g. for large poultry (acc. no. 752)
- Glass drip pan, for use with accessory item 752 (acc. no. 753)

# The control panel - sensor keys and displays

All oven functions are controlled from this panel.

- ☞ All the sensor fields are simultaneously sensor keys that react to even the lightest touch.
- ☞ The knob can be retracted by gently turning it and returned to its original position by turning the other way. It is can be turned either way.

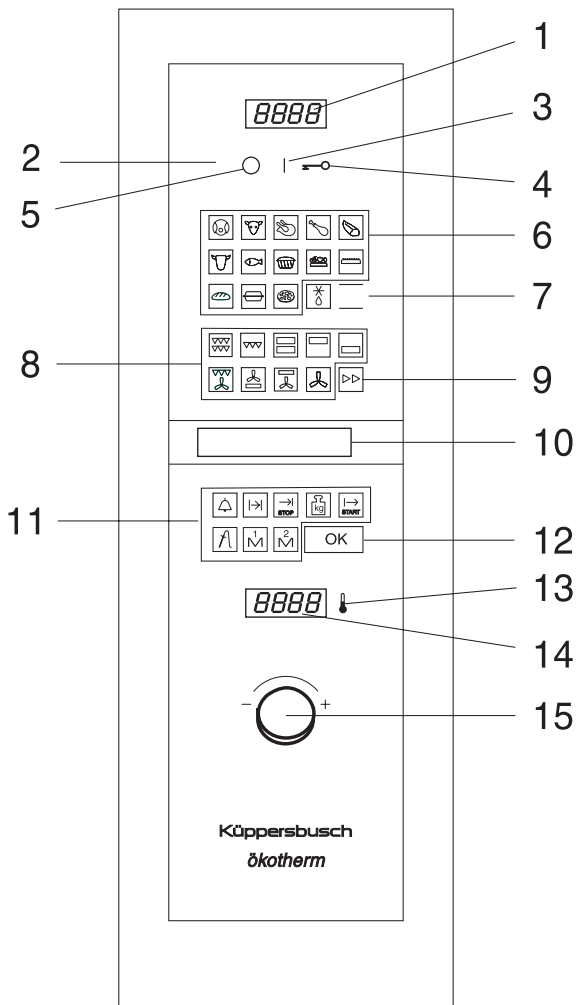

1		Time display	clock.
2		Time key (invisible)	for setting the time.
3		ON-key	switches the oven on (standby mode).
4	∞	Children's safety key	for activating / de-activating the child lock ∞, see page 17, for information on using the additional functions, see page 18.
5	○	OFF-key	switches the oven off.
6 / 8		Programmes and functions (symbols / sensor keys)	are both display symbols and sensor keys with which to select programmes or functions.
6		Keys roasting programme	basic programmes for roasting meat and fish. See page 11 for an overview.
		Keys baking programmes	basic programmes for baking cakes and pizza. See page 13 for an overview.
7		Key defrosting	programme "Defrosting and proving [☒]", see page 16.
8		Keys heating programmes	displays and sensors for the various heating means. See page 17 for an overview.
9		Key rapid heating	additional function, see page 9.
10		Text display	shows information on the next step, current settings and other details.
11	[☒]	Key minute minder	for setting the minute minder, see page 17.
	[☓]	Key cooking time	for setting the cooking time, see page 8.
	[☔]	Key finish time	for setting the finish time, see page 8.
	[☕]	Automatic weight system key	for adjusting the system weight [☕], see page 9.
	[☖]	Key core temperature function.	for setting the core temperature see "Roasting thermometer and core temperature function" on page 12.
	[☗]	Key cooking begin	for setting cooking begin by using core temperature function.
12	[OK]	OK-key	for confirming input.
13	↓	Actual temperature selection key	displays a brief text giving current baking oven temperature.
14		Temperature display	indicates the set oven temperature.
15		Knob	for changing all variable values.

# General information on your oven

## General Information

- ⚠ Please note the safety instructions on page 4!
- ⚠ **Attention! Risk of overheating!** Do not cover the bottom of the oven with aluminum foil, or place any kind of pot or pan directly on it. This can cause heat to build up and it can damage the enamel.
- 👉 When the oven is in use, it becomes hot. In order to cool the housing, the cooling fan is switched on as soon as the housing heats up. The cooling fan continues to run until the housing has cooled down - even after the appliance has been switched off. The fan noises are normal.
- 👉 If you are preparing a dish with alcohol or yeast as an ingredient, and are using Hot air convection, Intensive hot air convection or Pizza Mode, there will be a noticeable vinegar odor. If you find the odor disturbing, use Top/Bottom Heat or another alternate mode.

## Oven trays

- 👉 If you use telescopic glide-out shelves (acc. no. 601) please note the instructions on page 19.

### Baking trays:

- Lift slightly when removing.  
Place the baking trays back into the oven, with the sloping edge pointing toward the oven door.
- Push the drip pan and baking tray with the two slots right at the back into the oven.

### Oven rack:

- Make sure the catches of the racks always point toward the back (away from you).

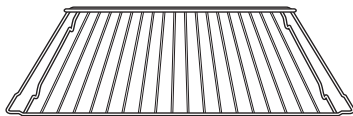

## Rack levels

- 👉 If you use telescopic glide-out shelves (acc. no. 601) please note the instructions on page 19.

There are eight levels in the side racks. The rack levels are numbered from 0 to 7 from the bottom up. For example, the drip pan can be inserted into rack level 0.

### Side racks:

Rack level 0 is the lowest possible level.

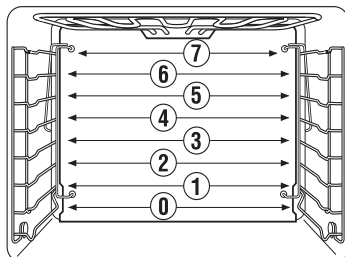

## Telescopic glide-out shelves (acc.-no. 601)

These are oven rails that are available as accessories. They replace the side racks and make it easier to work in a hot oven. Trays or oven racks are placed on the glide-out shelves. They can be pulled out separately and independently of each other. If your oven is fitted with glide-out shelves, please read the instructions on page 19.

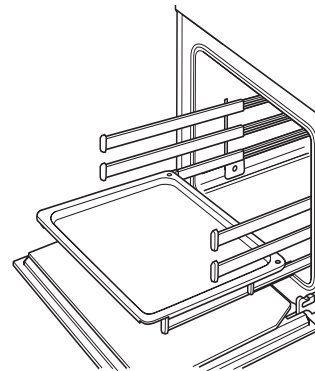

## Turning the oven light on and off

If the knob is in the depressed position, the lighting is OFF.

- Press it in to have it extend fully.  
This turns the lighting ON.

To turn it OFF again, depress the knob.

The lighting is independent of oven operation. The light can also be turned off while the oven is in use. This will save energy and increase the life of the halogen lamps.

# Using your oven

## General Information

- ☞ A safety cut-out prevents the oven being accidentally left on for extended periods. Once the maximum cooking time set has expired, the oven turns off if operation has been continuous. If you want to use the oven for longer, you will have to switch it on again for the remaining time. Please see "Setting optional functions" on page 18 for how to set maximum cooking time.
- ☞ After a few minutes operation, the knob is secured against unintentional use. It must first be turned before it is re-activated and settings can be re-adjusted.
- ☞ In some programmes, the fan turns ON and OFF. This is intentional.

## Explanation of the colored symbols.

Color	Means
green symbol	can be selected
red symbol	is active
red / green symbol	has to be set now
orange symbol	is active but has been modified

- ☞ Not all programmes and functions can be combined with one another. Those that cannot be so combined cannot be selected, i.e. do not illuminate.
- ☞ -<...>+ in the text display means: values can be changed using the knob.

## Switching on the oven

- Touch the sensor key  .  
The programme symbols illuminate green. The oven is ready for use and the text display shows <select programme OK>.
- Select a programme.
- ☞ If you do not select a programme within 10 seconds, the oven will switch off again.

## Selecting a roasting programme

- The oven is switched on, the text display shows <select programme ok>.
- Touch the sensor key with the symbol for the programme you wish to select. The symbol illuminates red and the "automatic weight system" blinks green / red.
  - Set the weight of the material to be cooked with the knob. This setting governs cooking time and temperature.
  - If you wish, change the predefined cooking time and cooking temperature.
  - Now start the programme by touching .

## Selecting a baking programme

- The oven is switched on, the text display shows <select programme ok>.
- Touch the sensor key with the symbol for the programme you wish to select. The symbol lights up red.

### Only baking programmes Bread and fruit cake :

- Select the sub-programme desired with the knob and confirm your choice by touching .

### Only baking programmes Bread :

- Set the weight of the material to be cooked with the knob. This setting governs cooking time and temperature.
- If you wish, change the predefined cooking time and cooking temperature.
- Now start the programme by touching .

### All other baking programmes:

- If you wish, change the predefined cooking time and cooking temperature.
- Now start the programme by touching .

## Select the heating programme

The oven is switched on, the text display shows <select programme ok>.

### - Heating programmes:

- Touch the sensor key with the symbol for the programme you wish to select.
- If you wish, change the predefined cooking temperature.
- Cooking duration and end are not pre-set but can be input. (See "Altering / Setting the cooking time" and "Setting the finish time").
- Now start the programme by touching .

## Altering the cooking temperature



Cooking temperature is pre-set in all programmes and shown on the temperature display.

When you select a baking and roasting programme, you can only alter the cooking temperature within certain limits. The heating programmes' temperature is in the range 32 °F / 0 °C (no temperature setting) to 555 °F / 290 °C and freely selectable.

- Altering the cooking temperature: Turn knob.





## Altering / Setting the cooking time

Cooking duration in the baking and frying programmes is pre-set but changeable. No cooking duration is pre-set in the heating programmes.

- Touch the sensor key : The text display shows, for example, <Cooking time ok>.
- This time can be changed with the knob as desired.
- Confirm with .

## Setting the finish time

Cooking completion is the moment the oven is turned off.

- ☞ You can combine the cooking duration  and the cooking completion . See "Automatic turn-on and shut-off".
- Touch the sensor key : The display shows <set end of cook time ok> or if the duration has already been chosen e.g. <end of cooking 13.24>.
- This time can be changed with the knob as desired.
- Confirm the modification with .





## Automatic turn-on and shut-off

---

If you wish use the oven's time-delay feature, you may pre-select both cooking time and finish time. The automatic start time itself cannot be specified, but this is derived from both settings.

### Example:

It is 8.00 and you wish to have your roast ready at 13.00. The roast needs to be cooked for 90 minutes.

- Change the cooking time  from 0.00 to 1.30.
  - Then change the finish time  from 9.30 to 13.00.
  - Confirm with .
- The oven turns on at 11.30 and off at 13.00.

## Change automatic weight / weight system



---

In the roasting programmes and the "Bread " baking programme, cooking time and temperature can be selected dependent on the weight. The text display requests you to select the weight of the food to be cooked.

**In these programmes, input weight immediately after selecting the programme.**

## Switching the oven off

---

- Touch the key .
- The oven is switched off.
-  If you have accidentally turned the oven off while a programme is running, you can resume that programme.

## Resuming interrupted programmes

---

Did you accidentally turn the oven off while a programme was running?

- Switch the oven on again. The text display will ask you: <progr. interrupted! Continue? OK>
- Confirm by touching .

## Blend in the actual oven temperature

---







- Touch the key . The current oven temperature is briefly displayed.

# Additional functions

## Rapid heating

---

Use this function to have the oven heat at higher performance to the temperature set.





-  The "Rapid heating"  function can be added in many heating programmes. (See "Using your oven" on page 8.)
- Choose a heating programme and then touch "Rapid heating" . Both sensor keys light up red.
- Select all the values as usual and confirm your input with .
-  When heating has completed, the illuminated "Rapid heating" symbol  no longer shows red.

## Memory function /



---

The oven has a memory function you can use to store **two programmes you have composed yourself as additional programmes.**

### Saving an additional programme:

- Select a baking, roasting or heating programme.
  - Set the desired temperature and time.
  - Then select "Rapid heating"  if applicable.
  - **Hold the** memory sensor  or  **depressed**, until the text displays <programme saved>.
- The programme set can now be saved with  or  and can be used like every other baking, roasting or heating programme.

### Choosing an additional programme:

- Press the  or  sensor and confirm by touching .
- The programme starts.
- The values set can be changed without such changes being saved.

# Roasting

☞ We recommend that you use the roasting thermometer. As cooking duration is determined by it, it is optimally adjusted to roasting. It cannot be adjusted. Please read the notes on page 12.

## Selecting a programme

### 1. Set the roasting programme.

Cooking temperature is determined based on the weight of the food to be cooked or cooking duration if the thermometer is not used. Both values are pre-set but can be changed (see page 8).

If you use the roasting thermometer you must adjust the core temperature (see page 12)

or

### 2. Select the heating programme

Every heating programme is turned on with a pre-set temperature. This temperature can be changed.

Cooking duration and expiry can be set (see page 8.) when roasting, as can cooking begin and core temperature when the thermometer is used. (see page 12).

## Turning the roast

In the **heating programmes**, turn the food to be roasted over after about 2/3 of the total time to ensure even cooking.

In the hot air  program this turning over is not needed.

In the **roasting programmes** a **signal** reminds you to turn the food over after about 70% of the total cooking time.

## Roasting on the oven rack

☞ Use the drip pan and the oven rack.

- Cook large roasts directly in the drip pan or on the oven rack with the drip pan inserted underneath (i.e. turkey, 3-4 chickens).
- We recommend to cook the fish in upright position (as if it were swimming) in the drip pan. By doing this you do not have to turn the fish: It does not brake as easily and the cooking is more even. If the fish does not stay in upright position it can be for example propped up with vegetable or put over a cup: Set the cup upside down into the drip pan and put the fish with its open side over the cup.

## Roasting in a pan

- Roast lean meats in the roasting pan with the lid closed (i.e. veal roast, marinated beef, braised beef or frozen meat). The meat remains juicier that way.
- Use any kind of pan (stainless steel, enameled, cast iron or glass) that doesn't have plastic or wooden handles.
- If you use an earthenware cooking pot, follow the manufacturer's instructions.

The following procedure is recommended:

- Rinse out the pan with water or grease it lightly.
- Prepare the meat with desired spices and place it into the pan. Put the lid on the pan and place the pan on the rack in the cold oven.
- Select the right roasting programme or the Intensive Hot air convection programme  to between 355-390 °F / 180-200 °C.

## Roast using the heating programmes

☞ If cooking using the thermometer, the cooking time is determined automatically and the notes that follow can be ignored.





☞ The programmes and figures in the tables are for a cold oven, unless otherwise stated.

- Cooking time depends on the type of meat, its quality and its thickness. To measure the joint, lift it slightly, as a joint tends to compress under its own weight. Information on this is given in the table "Roast using the heating programmes" on page 11.
- If the meat you are roasting has a layer of fat, cook it twice as long.
- If you are cooking several small pieces of meat or small poultry in the oven, increase the cooking time by about 10 minutes per piece. Roast a single chicken for about an hour, roast two chickens 65-75 minutes.

### Rack levels (count from bottom!):

A rule of thumb is: the bigger the roast the lower the oven rack should be inserted.

For large roast, the following applies:

<b>Grille roasting</b> 	Drip pan: rack level 0, Oven rack: rack level 1
<b>Intensive hot air convection</b> 	Drip pan: rack level 0, Oven rack: rack level 1
<b>Hot air convection</b> 	Drip pan: rack level 1, Oven rack: rack level 2
<b>Top/Bottom heat</b> 	Drip pan: rack level 1, Oven rack: rack level 2

## Some instructions on roasting programmes

☞ The programmes and figures in the tables are for a cold oven, unless otherwise stated.







☞ The roasting programmes are automatically adjusted to the food weight and it is hence important you **set the weight immediately after choosing your programme** and before changing e.g. cooking time, temperature or core temperature, (see page 8)!

### When using the roasting programmes without the roasting thermometer

The roasting programmes are set to deal with pieces of fish or meat up to 7 cm thick without any fat layer. Select the automatic weight system after entering the weight and **adjust the roasting programme if needed as below:**





















- Cooking time is shorter for several pieces.
- Cooking time is greatly increased for meat with a fat layer.
- Food over 7 cm thick weighing **less than 6.6 lb / 3 kg** increase cooking time 10 minutes per additional cm over the pre-set value.
- Food **over 6.6 lb / 3 kg** the cooking time as set is OK as differences are compensated for by the pre-set duration.

# Overview of roasting programmes

Dial symbol	Name	Preset temperature	Preset cooking time	Automatic weight system	Roasting thermometer	Rack level	Cooking with the oven
	Roast pork	depending on weight		1.1 – 22 lb 0.5 – 10 kg	recommended	1	Pork, game
	Roast veal	depending on weight		1.1 – 13 lb 0.5 – 6 kg	recommended	1	Veal, roast ham, stuffed roast, venison, mincemeat roast
	Poultry (whole bird)	depending on weight		1.1 – 22 lb 0.5 – 10 kg	recommended	1	Poultry (whole bird), e.g. chicken, duck, goose Large pieces of poultry weighing over 4.4 lb / 2 kg
	Chicken drumsticks	depending on weight		1.1 – 4.4 lb 0.5 – 2 kg	not possible	2 or 3	Poultry pieces, e.g. chicken drumsticks, breast of duck
	Fillet steak	depending on weight		1.1 – 8.8 lb 0.5 – 4 kg	recommended	3	Steak, e.g. game, veal, pork, beef
	Joint of beef	depending on weight		1.1 – 11 lb 0.5 – 5 kg	recommended	1	Beef, lamb, knuckle of veal
	Fish	depending on weight		1.1 – 11 lb 0.5 – 5 kg	recommended	1	Whole fish

## Guideline values for roasting using the heating programmes

The recommended temperatures for the preferred operating modes **are highlighted**.

Type of meat	Recommended roasting programme	Hot air convection 	Top heat/ Bottom heat 	Grill frying 	Intensive hot air convection 	Roasting time
Joint of beef		320 / 160	<b>340-375 / 170-190</b>	<b>320 / 160</b>		18
Roast beef		355 / 180	390-430 / 200-220	355 / 180	<b>355-390 / 180-200</b>	8-10
Fillet		355 / 180	390-430 / 200-220	355 / 180	<b>355-390 / 180-200</b>	8
Veal		<b>320 / 160</b>	340-375 / 170-190	320 / 160	320-355 / 160-180	12
Roast pork		<b>320 / 160</b>	340-375 / 170-190	320 / 160	320-355 / 160-180	12-15
Smoked loin of pork		<b>320 / 160</b>	340-375 / 170-190	320 / 160	320-355 / 160-180	8
Shoulder of pork		<b>320 / 160</b>	340-375 / 170-190	320 / 160	320-355 / 160-180	12-15
Roast pork with crackling		320 / 160	340-375 / 170-190	320 / 160	<b>320-355 / 160-180</b>	12-15
Game		<b>320 / 160</b>	340-375 / 170-190	320 / 160		15
Fillet of game		<b>355 / 180</b>	355-390 / 180-200	355 / 180	355-390 / 180-200	8-10
Lamb		300-320 / 150-160	<b>340-375 / 170-190</b>	<b>320 / 160</b>		15
Duck		320 / 160	340-375 / 170-190	320 / 160	<b>320-355 / 160-180</b>	12
Goose		320 / 160	340-375 / 170-190	320 / 160	<b>320-355 / 160-180</b>	12
Chicken		320 / 160	355-390 / 180-200	320 / 160	<b>320-355 / 160-180</b>	8*
Turkey		<b>320 / 160</b>	355-375 / 180-190	320 / 160	320-355 / 160-180	12
Fish		<b>320 / 160</b>	390-430 / 200-220			8

\* whole chicken 45 - 60 min.

# Roasting thermometer and core temperature function

The roasting thermometer measures the temperature inside the food. When the core temperature has reached a certain value, the roast is done just right: Not too dry and not too bloody.

- ☞ Cooking time depends on how long it takes for the internal temperature to reach the set core temperature. It is not adjustable. The cooking time can vary with the weight and type of meat and with the cooking temperature and programme.
- ☞ The roasting thermometer can be used with virtually all roasting and heating programmes. Those not so useable cannot be selected and hence are not illuminated.

## Correct roasting thermometer insertion

- Insert the tip of the roasting thermometer horizontally from the side right into the center of the food.
- Always insert the roasting thermometer into the roast up to the handle.
- The tip must not be located near the fat or the bone of the meat.
- When cooking poultry, don't touch any bones when inserting the roasting thermometer.

## Using the roasting thermometer

- Place the prepared roast with the roasting thermometer inserted in the oven.

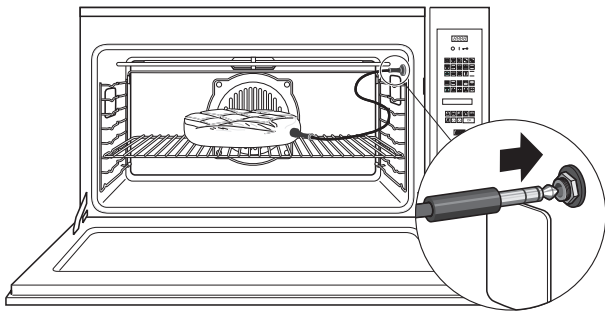

- Insert the roasting thermometer plug into the jack at the top right of the oven side wall.  
The text display states: <roasting probe plugged in>
- Close the oven door.

## Setting the core temperature function

- ☞ The roasting thermometer must already be in the holster!
- Turn the oven on. The display states: <Select programme ok>
- Select one of the programmes illuminated green by touching the sensor.
- **Roasting programmes only:** set the weight with the knob.
- **All programmes:** Touch the "core temperature function" sensor [A], the value set will be shown.
- Change the set core temperature with the knob if desired.
- Confirm by touching [OK].  
The programme starts. The top line of the display shows the current core temperature and the lower that set.
- ☞ After about 70 % of the cooking time, an audio signal sounds and the message "please turn the roast" displays.  
Turn the roast. The programme resumes when the door is closed.

Once the preset core temperature is reached, the oven automatically switches off and a signal sounds.

## Setting delayed cooking begin

As no fixed cooking time is set, it is not possible to set a finish time. To have the oven start at a later time, cooking start can be set.

- After setting core temperature (see above) touch the "starting time" sensor [B]. The text display states <Start in 0h 0 min.>. The time of the start set is shown on the clock display.
- Change the start time with the knob and confirm by touching [OK].

## Recommended core temperatures

Dish	Core temperature	
	in °F	in °C
<b>Beef</b>		
Roast beef/Fillet of beef, rare	105-115	40-45
Roast beef/Fillet of beef, medium	120-130	50-55
Roast beef/Fillet of beef, well done	140-150	60-65
Joint of beef	175-185	80-85
<b>Pork</b>		
Loin of pork	150-160	65-70
Roast pork/ham	175-185	80-85
Neck, knuckle of pork	175-185	80-85
Chops, rack of ribs	165-175	75-80
Chops without the bone	160	70
Smoked loin of pork	150-160	65-70
Meat loaf	160-165	70-75
<b>Veal</b>		
Roast veal	160-165	70-75
Roast veal stuffed with kidneys	165-175	75-80
Knuckle of veal	175-185	80-85
<b>Game</b>		
Meat of game	165-175	75-80
Rack of game	140-160	60-70
Fillet of game, rare	105-115	40-45
Fillet of game, medium	120-130	50-55
Fillet of game, well done	140-150	60-65
<b>Lamb</b>		
Lamb	175-185	80-85
<b>Stuffed roast</b>		
Stuffed roast	160-165	70-75
<b>Poultry</b>		
Poultry	185-195	85-90
<b>Fish</b>		
Fish	160-175	70-80

# Baking

## Selecting a programme

### 1. Set baking programme.

Baking temperature and duration are pre-set but can be changed.

or







### 2. Select the heating programme

Every heating programme is turned on with a pre-set temperature. This temperature can be changed.

Duration can also be changed, as can cooking end, (see page 8).

## Baking programme overview

☞ All baking programmes are only suitable for baking at one level. If you want to bake at several levels at once, please use the Hot air convection programme .

Dial symbol	Name	Preset temperature (range available)	Preset cooking time	Automatic weight system	Rack level(s)	Preheating	Cooking with the oven
	Pound cake	320 °F (285-340 °F) 160 °C (140-170 °C)	70 minutes	none	2	no preheating time	Cakes in tins, e.g. cake mixture, yeast dough, cheesecake, fruit loaf
	Fruit cake*			none			Tray-baked cakes, sponges, yeast dough, short pastry
	Fruit cake 1	340 °F (300-355 °F) 170 °C (150-180 °C)	50 min.	none	2	no preheating time	with very moist fruit topping
	Fruit cake 2	340 °F (300-355 °F) 170 °C (150-180 °C)	35 min.	none	2	no preheating time	with slightly moist or normal fruit topping
	Flat cake with a dry topping	340 °F (300-355 °F) 170 °C (150-180 °C)		none	2	no preheating time	Tray-baked cakes, sponges, yeast dough, short pastry without fruit topping
	Bread*						
	White bread	355 °F (320-375 °F) 180 °C (160-190 °C)	Depending on weight	1.1 - 4.4 lb 0.5 - 2 kg	2	with preheating time	
	Rye- and wheat-flour bread	355 °F (320-375 °F) 180 °C (160-190 °C)	Depending on weight	2.2 - 8.8 lb 1 - 4 kg	1	with preheating time	
	Coarse wholemeal bread	355 °F (320-375 °F) 180 °C (160-190 °C)	Depending on weight	2.2 - 6.6 lb 1 - 3 kg	1	no preheating time	
	Soufflé	355 °F (320-375 °F) 180 °C (160-190 °C)	60 min.	none	2	no preheating time	Gratin dishes and casseroles with raw vegetables, potatoes, noodles
	Pizza	355 °F (375-500 °F) 250 °C (190-260 °C)	35 min.	none	0	with preheating time	Pizza and speciality doughs on a baking tray

\* These programmes have sub-programmes. Select with the knob.

### Notes on the pre-set values:

The baking programmes are based on 1.1 lb / 500 gr. of pastry / dough or 2.2 lb / 1 kg raw potatoes or raw vegetables.

- If you are cooking larger quantities, you should reduce the temperature slightly and increase the cooking time by around 10 minutes per 2.2 lb / 1 kg.
- For smaller quantities use a high temperature and a shorter cooking time.

# Baking with heating programmes

☞ Notes on rack levels are given in a table on page 15!

## Hot air convection

☞ No need to preheat the oven - baking is possible on several levels simultaneously.

### Rack levels:

- 1 tray: 3rd rack level from the bottom
- 2 trays: 3rd and 6th rack levels from the bottom

- If you are baking several cakes in baking pans at the same time, add about 5 to 10 minutes for each additional tray used.
- You can take out one baking tray at a time if you wish, and leave the others to continue baking.
- If your recipe doesn't include directions for baking by hot air convection, bake it using Hot air convection  at a temperature of 320 °F / 160 °C.
- **Important!** When baking cakes with a moist fruit topping, the development of humidity is particularly high. Do not bake more than two cakes at the same time.

## Top/Bottom heat

☞ Preheating - baking on one level

- Preheating:  
Use the "Rapid heat" function  and wait until the symbol no longer shows red.
- Black metal or aluminum pans are ideal.

## Intensive hot air convection

☞ There's no need to preheat the oven - baking on one level

- Use only for baking large, flat cakes with a dry topping, (i.e. crumble topping.)

## Pizza mode

☞ Baking on one level

- for moist cakes
- for pizzas: preheat the oven with a baking tray or a pizza stone (accessory)
- for bread: preheat

# Baking pizza

☞ Select the "Pizza"  or the baking programme or the "Pizza Mode"  heating programme.

- If you use a pizza stone (separate accessory), the pizza gets a particularly crispy base. Preheat for at least 30 minutes! Read the instructions enclosed with the pizza stone.

## Basic recipe for pizza dough

4 ¼ cups of all-purpose flour, 2 ¼ of dry yeast, 1 ½ cups of lukewarm water, 2 tablespoons of olive oil, 2 teaspoons salt, 2 teaspoons of sugar

## To bake pizza on a baking tray

- Make a yeast dough out of the specified ingredients.
- Let the dough rise for approx. 30 minutes until it has doubled in size.
- Knead the dough for a few minutes and allow it to rise for another 15 minutes.
- Start the "Pizza"  baking programme – the oven preheats.
- Grease the baking tray.  
If you are making small, round pizzas, insert the baking tray into the oven and preheat.
- Roll out the dough, place on a baking tray and form an edge.
- Add your desired toppings quickly, so the dough doesn't get moist.

- **Small pizzas:** Put dough with topping on the preheated baking tray.
- Place the baking tray in rack level 0 once the audio signal has sounded.
- When the door closes, the programme starts and has a baking time of 12 minutes.

## Baking pizzas on the pizza stone

- Prepare the pizza dough as described above.
- Place the pizza stone on the oven rack and insert at rack level 0.
- Preheat the oven using the "Pizza Mode" heating programme to 480 °F / 250 °C for about 30 minutes.
- Dust the lifter with flour before placing the dough on top. Add toppings quickly so the dough doesn't get moist. Don't leave the pizza on the lifter for too long, or the dough won't slide off.
- When the oven is preheated, push the pizza off the lifter onto the hot pizza stone.
- Bake for approximately 8 - 12 minutes.

# Notes on the table: "Guidelines for baking"

































The table on page 15 contains a list of cakes etc., the necessary temperatures, cooking times and rack levels.

A range of temperatures are provided, because it depends on the composition, quantity and shape of the dough.

- Try using the lower temperature the first time. Only select a higher temperature if you need more browning or if the baking time is too long.
- If your recipes don't provide specific temperatures, use a similar cake in the chart as a guide.
- If your food items are of varying height, it will affect the degree of browning at the beginning of the baking process. Do not change the temperature setting, as the differences in browning intensity will even out during the course of baking.



# Guidelines for baking

The recommended temperatures for the preferred operating modes are highlighted. Please refer to the notes on the table on p.14.



Type of cake or biscuit	Recommended baking program		Hot air convection 		Top heat/Bottom heat 		Intensive hot air convection  Pizza mode 		Baking duration in minutes	
	Rack level	Program	Rack level	Temperature in °F / °C	Rack level	Temperature in °F / °C	Rack Level	Temperature in °F / °C		
<b>Cake mixture</b>										
Ring cake	2		2	<b>300-320 / 150-160</b>	1	340-355 / 170-180				50-65
Tin cake	2		2	<b>300-320 / 150-160</b>	1	340-355 / 170-190				50-70
Madeira cake	2		2	<b>300-320 / 150-160</b>	1	320-355 / 160-180				60-70
Gateaux and flans	2		2	<b>300-320 / 150-160</b>	1	340-355 / 170-180				40-60
Flan bases			2	<b>340-355 / 170-180</b>	2	355-390 / 180-200				20-30
Fine fruit flans	2		2	300-320 / 150-160	1	340-355 / 170-180	2	 <b>300-320 / 150-160</b>		45-60
Small biscuits			2	300 / 150	2	<b>340-355 / 170-180</b>				15-30
<b>Large flat cakes:</b>										
with a dry topping	2		2	300-320 / 150-160	2	355-375 / 180-190	2	 <b>300-320 / 150-160</b>		25-35
with a moist topping	2		2	320-340 / 160-170	2	340-355 / 170-180	2	 <b>320-340 / 160-170</b>		35-50
<b>Kneaded dough</b>										
Flan bases			2	340-355 / 170-180	2	<b>355-390 / 180-200</b>				25-35
Cheese cake			2	285-300 / 140-150	1	320-340 / 160-170	2	 <b>285-300 / 140-150</b>		70-90
Small biscuits			2	285-300 / 140-150	2	<b>355-375 / 180-190</b>				15-35
<b>Large flat cakes:</b>										
with a dry topping	2		2	300-320 / 150-160	2	355-375 / 180-190	2	 <b>300-320 / 150-160</b>		25-35
with a moist topping	2		2	320-340 / 160-170	2	340-355 / 170-180	2	 <b>320-340 / 160-170</b>		30-50
<b>Leavened dough</b>										
Ring cake	2		2	<b>300-320 / 150-160</b>	1	350-355 / 175-180				40-65
Yeast cake	2		2	<b>300-320 / 150-160</b>	2	350-355 / 175-180				40-50
Rich sweet bread (preheated)	2		2	<b>300-320 / 150-160</b>	2	350-355 / 175-180				50-70
Small biscuits			2	<b>285-300 / 140-150</b>	2	355-390 / 180-200				15-30
<b>Large flat cakes:</b>										
with a dry topping	2		2	300-320 / 150-160	2	350-355 / 175-180	2	 <b>300-320 / 150-160</b>		30-40
with a moist topping	2		2	320-340 / 160-170	2	340-355 / 170-180	2	 <b>320-340 / 160-170</b>		30-50
<b>Sponge cake</b>										
Gateaux and flans			2	300-320 / 150-160	2	<b>350-355 / 175-180</b>				30-40
Rolls			2	340-355 / 170-180	2	<b>355-390 / 180-200</b>				12-25
<b>Biscuits made with white of egg</b>										
Meringue			2	<b>175-195 / 80-90</b>	2	210-250 / 100-120				80-120
Cinnamon stars			2	<b>210-250 / 100-120</b>	2	250-285 / 120-140				20-40
Macaroons			2	<b>210-250 / 100-120</b>	2	250-285 / 120-140				20-50
<b>Other doughs</b>										
Puff pastry			2	<b>340-355 / 170-180</b>	2	375-410 / 190-210				15-30
Puff pastry made with leavened dough			2	<b>340-355 / 170-180</b>	2	375-410 / 190-210				30-40
Puff pastry made with curd cheese			2	<b>320-355 / 160-180</b>	2	355-390 / 180-200				30-40
Choux pastry			2	<b>340-355 / 170-180</b>	2	375-410 / 190-210				30-40
Dough made with curd cheese and oil			2	<b>300-320 / 150-160</b>	2	340-355 / 170-180				30-40
Honey cake			2	<b>285-300 / 140-150</b>	2	340-355 / 170-180				20-35
<b>Bread and pizza</b>										
Leaven and bread made with yeast (preheat: 445 °F/230 °C, prebake: 10 min., 445 °F/230 °C)	1				1	355 / 180	1/2	 <b>320 / 160</b>		50-65
Bread made with yeast/white bread.	2		2	<b>355 / 180</b>	2	390 / 200	2	 355 / 180		30-50
Pretzels (preheat: 445 °F/230 °C)			2	<b>390 / 200</b>	2	430 / 220				15-20
Pizza (preheat: 480 °F/250 °C)	0						0	 <b>480 / 250</b>		8-12

## Grilling

 Always close the oven door when grilling!

 For small amounts of food to be grilled: select heating programme  or for larger amounts of food to be grilled: select heating programme .

 The preset temperature is ideal for grilling small and medium sized items. When grilling larger items, select a temperature between 390 and 480 °F (200-250 °C) to avoid burning the food.



- Select heating programme  or .
- Preheat the oven for 5 minutes.
- Put the food on the oven rack.
- Slide the drip pan into rack level 0 or 1 and place your oven rack on the rack level recommended in the table.
- Close the oven door.

## Guidelines for grilling

Dish	Rack level	Grill		Large area grill	
		1 <sup>st</sup> side	2 <sup>d</sup> side	1 <sup>st</sup> side	2 <sup>d</sup> Side
		in minutes			
Pork chops/cutlet	6	6-8	4-6	8-9	5-7
Fillet of pork	5	10-12	8-10	12-13	8-10
Sausages	6	6-8	4-6	8-10	5-7
Shish kebabs	4	7-8	5-6	8-10	7-10
Meatballs	4	8-10	6-8	10-15	10-12
Beef steak	6	4-6	3-5	6-7	4-6
Slices of liver	6	3-4	2-3	4-5	3-4
Veal cutlet	5	5-7	4-5	7-8	5-6
Veal steak	5	6-8	4-6	8-9	5-6
Mutton chops	5	8-10	6-8	10-11	7-8
Lamb chops	5	8-10	6-8	10-11	7-8
Half a chicken	3	10-12	8-10	14-15	10-11
Fillet of fish	6	6-7	4-5	7-8	5-6
Trout	4	4-7	3-6	8-11	5-6
Toast	5	2-3	2-3	2-3	2-3
Toasted sandwiches	4	6-8		6-8	

## Defrosting and proving

### Defrosting

 Select the "Defrost/proving" programme  with a temperature of max. 95 °F / 35 °C for delicate foods such as butter or cream cakes.

For higher temperatures please select hot air convection programme .

 When defrosting frozen dinners, please follow the instructions on the packaging.

- Remove the frozen food from the packaging, place it in a dish and insert into the oven with the rack on the third rack level from the bottom.

- Select  or  and set the temperature.

### Fermentation:

 Ideal for raising yeast dough.

- Select the heating programme  and a temperature of 95 °F / 35 °C.

## Preserving

 **Attention!** Do not use jars with twist-off<sup>®</sup> lids if the lids have been already in use. The jars could explode under certain circumstances!

 Use conventional preservative jars with a rubber ring and glass lid or standard jars with a twist-off<sup>®</sup> lid (new lids only).

Do not use metal cans.

 Do not pour water into the drip pan! Steam will escape from the vapor opening - you could be burned! Place a cup of water in the drip pan, not on the bottom of the oven!

 Use the Pizza mode .

■ Use only fresh food and follow a recipe.

■ Prepare only six quart-sized preserving jars at a time.

■ Use jars that are the same height and fill 3/4 full with the same contents.

■ The jars shouldn't touch each other.

- Place the drip pan on the first rack level from the bottom.

- Set 1 cup with water in the drip pan.

- Select Pizza mode  at 320 °F / 160 °C and follow preserving process. After 10-20 minutes (jars with a capacity of 1 qt.) the liquid in the jars will start to bubble, beginning usually with the jar located on the front right.

### Fruit

- Turn the oven off and keep the jars in the closed oven for another 30 min. (shorten time to approx. 15 min if you're preserving very sensitive fruit like strawberries.)

### Vegetables and meat









- When the liquid starts to bubble, turn the oven down to 210 °F / 100 °C and continue to heat for another 30-60 minutes.

- Turn the oven off and keep the jars in the closed oven for another 30 min.







# Overview of heating programmes

☞ An overview of roasting and baking programmes is to be found under "Overview of roasting programmes" on page 11 and "Baking programme overview" on page 13.

Dial symbol	Name	Preset temperature (range available)	Rack level(s)	Cooking with the oven
	Large area grill	555 °F / 290 °C	Shelf on position 2	Grilling large quantities
	Grilling	555 °F / 290 °C	2	Grilling small portions.
	Top/Bottom heat	345 °F / 175 °C	2	Preheating, baking sponges and moist cakes
	Top heat	430 °F / 220 °C	2	Browning toppings
	Bottom heat	355 °F / 180 °C	2	Prebaking very moist cake
	Grille roasting	320 °F / 160 °C	2	Roasting meat, fish and poultry
	Pizza mode	320 °F / 160 °C	2	Baking bread, pizzas and moist cakes, making preserves.
	Intensive hot air convection	320 °F / 160 °C	2	Baking large flat cakes with a dry topping (such as a crumble topping), intensive roasting of large joints and large poultry such as goose or turkey.
	Hot air convection	320 °F / 160 °C	2	for roasting, baking and cooking on several levels

## The minute minder

- ☞ The minute minder display has **priority over all others**. This text display shows the minute minder even when the oven is on!
  - ☞ The minute minder alarm is a pure reminder function and does not turn the oven off!
  - ☞ If a programme has been selected beforehand the key will not illuminate, as the minute minder has no influence on any programme cycle. The minute minder can be used despite this.
  - Touch the key . The symbol blinks green/red and <minute minder> is displayed.
  - Set the duration in minutes with the knob.  
Duration and current time will be displayed as will the estimated end time.
  - Confirm with : The minute minder operates.
- When the time set expires an audio signal sounds that you can turn off by pressing .
- ☞ The time running can be changed by touching the  key again and re-setting using the knob.

## The child safety lock

- The child lock prevents accidental maladjustment of the oven and offers additional child protection.
- When the child safety lock is **activated, the oven can only be turned off**. The values input cannot be changed and the oven cannot be turned on.

### Activating / deactivating the child safety lock

Touch the sensor key with the symbol "→". The text display states: <child safety lock -<...>+>. After a brief period, the child lock status displays: <child lock inactive> or <child safety lock active>.

#### Activating the child safety lock:

- Turn the knob **clockwise** until <child safety lock active> is displayed.
- **Confirm with !** The child lock is activated now.

#### Deactivating the child safety lock:

- Turn the knob **counter-clockwise** until <child lock inactive> is displayed.
- **Confirm with !** The child lock is deactivated now.

# Setting optional functions

## Overview of optional functions

---

Select language The language used in the display can be selected.

### Available special functions:

Demonstration mode Only accessible to KÜPPERSBUSCH Customer Service!

### Memory functions 1 and 2

**Memory function 1:**  
After 20 minutes operation without automated shutoff, an audio signal will sound every 10 minutes and must be acknowledged. The oven shuts off when the max. cooking time has been reached.

**Memory function 2:**  
After 20 minutes operation without automated shutoff, an audio signal will sound every 10 minutes and must be acknowledged. If it is not, the oven switches off after a further 5 minutes operation.

**Eco function** When the eco function is activated the clock display is turned off with the oven and power consumption cut to a minimum.

**Maximum cooking time** After this set time the oven switches off automatically (safety shutdown).

Default setting: 6 hours.  
minimum possible 2 hours,  
maximal possible: 28 hours, but temperature is cut to 120° C from 6 hours to cooking time expiry.

☞ The special functions can be **altered within the first few minutes after a power cut-off** (plug or fuse pulled), **and before you touch the ON sensor for the first time!**

## 1. Select language

---

- After power cut-off please wait until <USA AM/PM CLOCK / °F / Pound ok> is displayed. **According to the pre-selection you will see a different language than "USA AM/PM CLOCK / °F / Pound ok".**
- Use the knob to select language if it is not displayed as having been selected already.
- Confirm with .

☞ Eine andere, für die USA vorgesehene Ländereinstellung ist:  
<USA 24h / °C / kg ok>

## 2. Activate "Optional functions" selection menu

---

- After selecting your language, touch the **child lock** → sensor. The text display shows <optional functions select ok>
- Turn the knob clockwise until the desired function can be chosen. Touch the sensor key .

Several such functions can be set in sequence.

## 3a. Memory functions 1 and 2

---

Text display shows: <Memory function ok>.

- Touch the sensor key .
- Turn the knob to the desired position: <Memory OFF ok>, <Memory function 1 ok> and <Memory function 2 ok>.
- Confirm the selection with .

## 3b. Eco function ON / OFF

---

Text display shows: <Eco function ok>.

- Touch the sensor key .  
The text display shows <Eco function off> or <Eco function on>.
- To activate the eco function, turn the knob clockwise to <Eco function ON>, then anti-clockwise for <Eco function OFF>.
- Confirm the selection with .

## 3c. Maximum cooking time

---

Text display shows: <max. cooking time 6 h ok>

- Touch sensor  and use the knob to set the desired maximum time.
- Confirm the selection with .

## 4. End selection mode

---

- Turn the knob clockwise until the text display <quit selection ok> is displayed.
- Confirm with .

# How to use the telescopic glide-out shelves (acc.-no. 601)

⚠ Take care when working with a hot oven. Use cloths, oven gloves or similar.

## Inserting the oven trays correctly

☞ The individual telescopic glide-out shelves must be pushed fully into the oven to safely position the trays and oven racks!

– Push all the glide-out shelves fully into the oven.

– Turn the trays so that the holes are at the rear



and that oven racks with cross bars point towards the front.

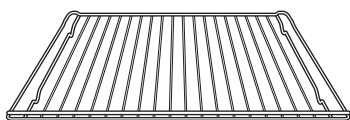

– Place the trays and oven racks with the back edge **on the front side** of the glide-out shelf and push them into the oven.

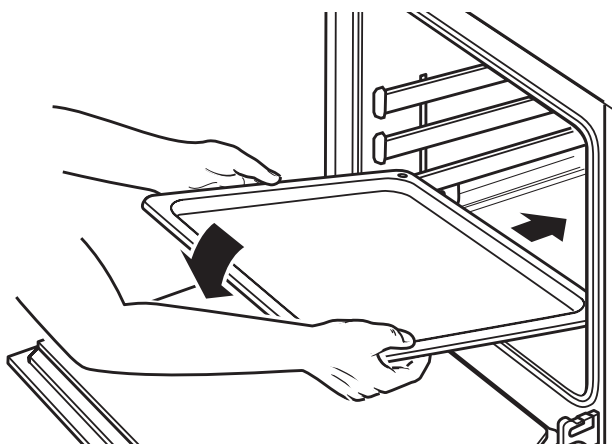

☞ Do not try to clasp the holes in the back of the oven. The holes are conditional to production and do not have any function!

## Pulling out the trays

– Pull the trays and oven racks out of the oven using cloths or similar. The trays can be pulled out by their front edge up to the front edge of the individual telescopic glide-out shelves.

The oven racks do not move on the glide-out shelves when they are being pulled out.

☞ The two top racks can be pulled out to the simple length, the bottom more slightly further.

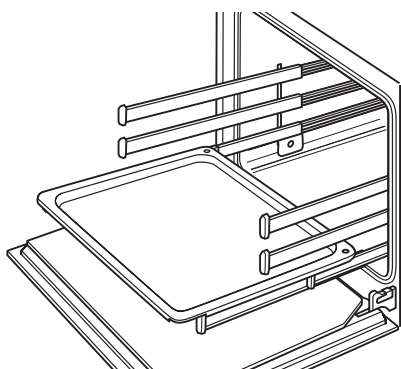

## Pushing in the trays

– Slowly push the glide-out shelves right in full using a cloth or similar.

## Shelf levels, cooking times and temperatures

The individual telescopic glide-out shelves have three shelf levels (1-3) which are counted from the bottom up. The recommended times, temperatures and modes in the instructions for use of your oven also apply to the use of the individual telescopic glide-out shelves.

The shelf levels given in this users guide are only suitable for shelf racks.

☞ We recommend the following levels for the individual telescopic glide-out shelves:

Food	Hot air convection	Top heat/ bottom heat	Intensive hot air convection	Grill or
Rack levels (counted from bottom up)				
<b>Baking</b>				
Cake on 1 baking tray	2	1	2	
Cakes on 2 baking trays	1, 3			
Cake in tins (e.g. rings cake)	1	1		
<b>Roasting - drip tray and rack tray</b>				
Large pieces of meat and poultry	1*	1*	1*	
<b>Grilling</b>				
Flat pieces of meat/fish				3
Thick pieces of meat/fish				2

\* For roasting very large poultry please use the depressed rack tray with the glass drip pan (accessory).

## Special accessories

### Rack tray, depressed, and glass drip pan:

For roasting very large poultry, you need the depressed oven rack with the glass drip pan. And for cooking in two dishes at two levels, you can get the necessary space with the depressed oven rack at the lowest level.

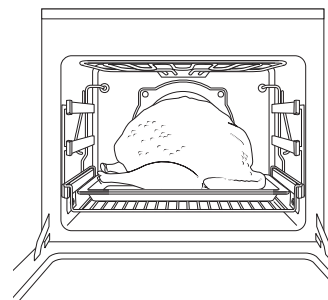

### Accessory numbers:

Rack tray, depressed: acc.-no. 752

Glass drip pan: acc.-no. 753

# Cleaning and Care

Carefully read this chapter before you use your appliance the first time. If it's cleaned properly and regularly, it will remain beautiful and clean for many years. Here are a few tips for cleaning and maintaining the appliance surfaces.

## For all surfaces

- ⚠ Do not, under any circumstances, use steam or pressure cleaning machines to clean the appliance! Damage caused to your appliance by cleaning it this way can make it **lethally dangerous**.
- ⚠ **Risk of burning!** Make sure the appliance has cooled down before cleaning.
- ⚠ Please follow the instructions provided with the cleaning agents you plan to use.

Clean the appliance each time you use it. Dirt that isn't removed will burn into the surface when you switch it on again and will be difficult or impossible to remove.

Use a damp cloth or a soft sponge with warm water and a little detergent to clean light amounts of surface dirt. Always wipe off the surface completely with cold water to remove residues from cleansers than can cause discoloration and stains. Wipe dry afterwards.

- ☞ For information about cleaning individual surfaces and parts and removing heavy dirt, review the information below.
- ☞ VSR O-FIX-C is perfect for the cleaning of glass ceramic, enamel and the coated door interior. It is available from KÜPPERSBUSCH Customer Service.

### Do not use any

- Harsh cleansers or cleansers with bleach or active oxygen, chlorine or corrosive components.
- Abrasive or harsh cleansers or scouring products like steel wool, soap-filled steel wool, metal or plastic sponges or similar products with an abrasive surface.

## Remove caking

Be sure to soak any crusty food debris with a wet cloth. It will make it easier to remove the dirt.

## Information about the cleaning scraper

⚠ Be careful! The blade of the cleaning scraper is very sharp and will cut! Always keep the cleaning scraper flat on the surface and push the dirt away.

⚠ Don't scratch the surface with the edge of the scraper and don't damage the sealing with the edge.



## The use of oven sprays - information

- ⚠ Please follow the instructions from the manufacturer. Oven sprays damage aluminum, lacquered surfaces and plastic!
- ⚠ Do not spray into the opening of the ventilator at the backplate! The ökotherm<sup>®</sup> catalyst will be destroyed if you use oven spray.

For environmental reasons, don't use oven spray at all. However, if you do use it, just spray it in the oven interior and on enamel baking trays.

## Enamel

### Oven interior, front, baking trays, drip pan

Some plastic sponges with an abrasive side can be used. However, some products have grains in the abrasive side of the sponge that can scratch the surface.

Test the sponge on a small surface before using!

- ☞ A cleaning scraper for glass ceramic surfaces is perfect for removing heavy dirt.
- ☞ Use VSR O- FIX-C to clean your oven. Oven spray can also be used.

## Stainless steel

### Stainless steel door front, control panel, telescopic glide-out shelves (acc. no. 601)

⚠ Stainless steel is easily scratched!  
**Do not use a cleaning scraper!**

⚠ Remove any calcium deposits, grease spots and starch as soon as possible or stains will appear!

A cleanser for stainless steel is perfect. Be sure to clean the stainless steel with a stainless steel cleanser at least once a week. This creates a protective film for the stainless steel surface and will prevent discoloration.

You should clean the stainless steel surfaces with a stainless steel cleanser at least once a week. This will create a protective film to prevent the stainless steel surface from discoloring.

## Glass

### Inside of the door - coated glass

⚠ Don't use oven spray because it can destroy the coated glass surface if used frequently.

To remove heavy dirt, use a cleaning scraper for glass ceramic surfaces.

- ☞ VSR O- FIX-C or glass detergent is ideal to clean your glass ceramic surface.

### Door front, control panel

- ☞ Using a damp cloth or soft sponge, clean the **front of the oven** with warm water and a little detergent. You may use glass cleaners.

## Aluminium

### Door ledges and handles in aluminium

⚠ Aluminium is very sensitiv to scratches and oven spray spray causes damage!

**Do not use a cleaning scraper!**

## Door sealing

- ☞ Since dirt can collect under the sealing, be sure to remove the door sealing when cleaning the oven. See "Replacing the door sealing" on page 23.

Clean the sealing with detergent or dishwashing liquid.

## Knobs

Using a damp cloth or soft sponge, clean the knobs with warm water and a little detergent.

## Removing and installing the oven door

### Removing the oven door

- Open the oven door as far as it will go.
- Fold up the clamps on the door hinges.

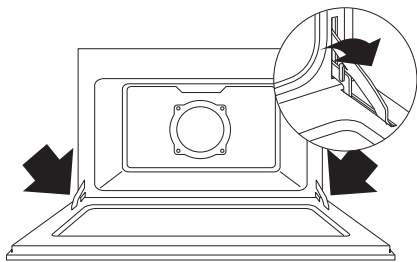

- Take hold of the oven door on both sides and close it slowly. When the oven door is about half-closed, the hinges will fall out of the catches. The oven door can now be removed.

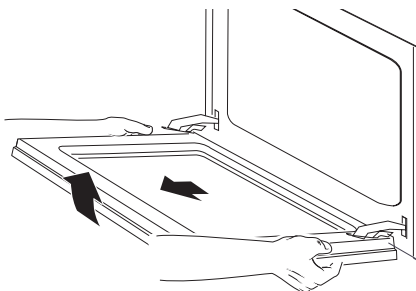

### Reassembling the oven door

- Take hold of the oven door on both sides and push the hinges into the appropriate holes on the oven.
- Slowly open the oven door until it is fully open.
- Fold down the clamps on the door hinges.
- Close the oven door.

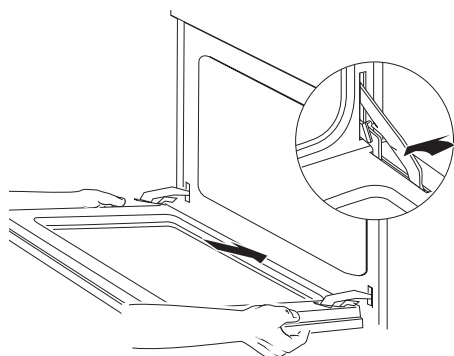

## Removing and installing the side racks

### Removing the side racks.

- Loosen the screws.
- Remove the slot-in racks.

### Installing side racks

- Insert side racks and tighten down in front.

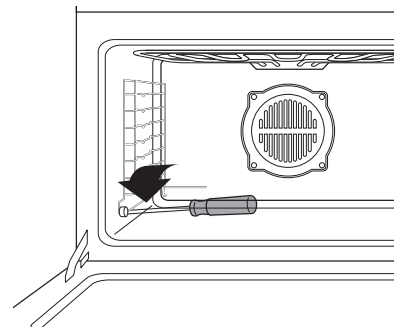

## Folding heating element down/up

### Folding heating element (top heat/grill) down

- Open lock and fold heating element down.

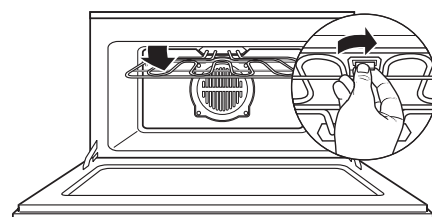

### Folding heating element up

- Fold heating element up and close again with the lock.

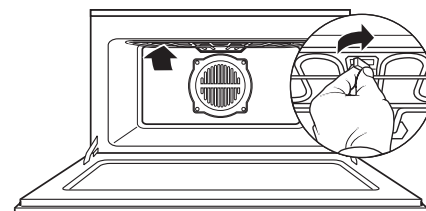

## Unscrewing/reinstalling the individual telescopic glide-out shelves (acc.-no. 601)

### Unscrewing the individual telescopic glide-out shelves

If you want, you can screw the individual telescopic glide-out shelves off the side walls with a screwdriver so that it is easier to clean the walls.

- For this purpose unscrew the bottom holding screw on each side.

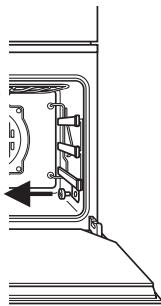

### Reinstalling the individual telescopic glide-out shelves



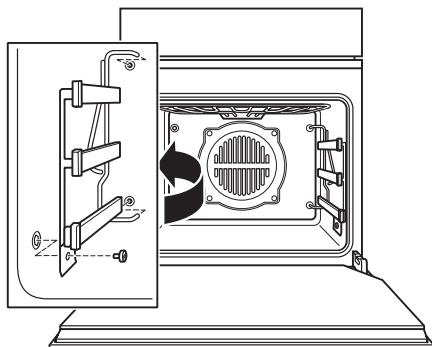

- Insert the individual telescopic glide-out shelves at the back into the holes in the intermediate wall and screw the individual telescopic glide-out shelves at the bottom front to the side walls.



## Regenerating the ökotherm<sup>®</sup> catalyst

The ökotherm catalyst scrubs the grease particles and odor arising when roasting in Hot air convection mode. The catalyst cleansing capability is usually adequate. In rare cases of very intensive roasting of very large amounts of food grease particles may settle on the catalyst. Next time you use hot air convection, e.g. for baking a pizza, the deposits will be disposed of over time.

Should you feel the catalyst cleansing effect has weakened (e.g. if there is a strong odour), the catalysts can be regenerated by removing the fatty deposits:

- Select the programme Hot air convection .
- Then touch the Rapid Heating sensor .
- Set the temperature to 555 °F / 290 °C and cooking duration  to 60 minutes.
- Touch the sensor key .

## What to do if trouble occurs...

 Use a qualified technician for repairs!

However, there are some problems that you can handle yourself. First, check and see if there have been any operating errors. Remember--repairs during the guarantee period are not free of charge if they are caused by operating errors or non-observance of the following instructions:

### What is to be done if...

#### ... neither sensors nor lighting function?

Please check: Is the mains plug in the wall socket? Is the domestic fusing OK? Power failure?

#### ... one or more sensors don't react to touch but the lighting can be turned on?

**Possible cause:** The sensors constantly adapt in sensitivity to ambient conditions. Unfavorable conditions such as e.g. if you lean against them for a lengthy period, may cause them not to react for several minutes.

Wait for about 15 minutes or pull the relevant fuse and then re-insert it. Repeat this procedure if necessary!

The keys have adapted and now react to touch again.

#### ... one or more sensors don't react to touch despite repeating this procedure?

**Possible cause:** Faulty sensor key or component.

If you've repeated the procedure and the keys still don't react, pull the fuse again and then contact our Customer Service.

#### ... if <demonstration mode> is displayed and the oven won't heat?

Have this mode de-activated by Customer Service!

#### ... the oven door glass cracked?

Switch the oven off and have the door replaced by Customer Service.

#### ... the door sealing is damaged?

Replace the door sealing. (See page 23) **Do not use the oven with a damaged sealing!**

#### ...the oven lighting is defective?

The oven can still be used. Replace the halogen bulbs as soon as possible - when the oven has cooled down - see "Replacing a halogen bulb".

#### ...there is a powerful odor?

Regenerate the ökotherm<sup>®</sup>-catalyst (see page 22).

#### ... the oven generates a strong smell of vinegar?

Cooking a dish containing alcohol or yeast using programmes with Hot air convection will produce a vinegar smell. If you find the smell disturbing, use one of the modes without fan, such as Top/Bottom heat.

#### ... fruit juice or albumin gets onto enameled surfaces?

This is a harmless enamel change that cannot be changed.

## Replacing a halogen bulb

- ⚠ **Attention!** The halogen bulb become very hot after being in use for a while. Only change the bulbs when they have cooled down.
- ⚠ Only replace the halogen bulbs with bulbs of the same type. You can obtain new halogen bulbs from KÜPPERSBUSCH Customer Service.
- ✍ Do not grip the halogen bulbs with your bare hands. Finger marks burn into the bulb glass and reduce the light intensity and service life of the bulbs.
- ⚠ If the fitting has become solid due e.g. to dirt or long use then glass may splinter during removal. Hold a towel or cloth over the fitting to catch any splinters.

### Changing the halogen lamp:

- Unscrew the shelf rack.

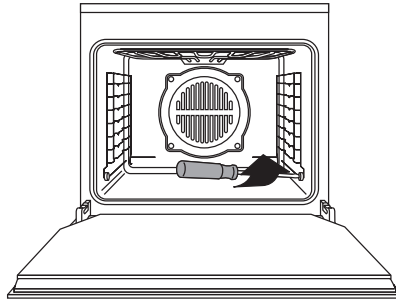

- Carefully lever out the glass cover with a screwdriver.

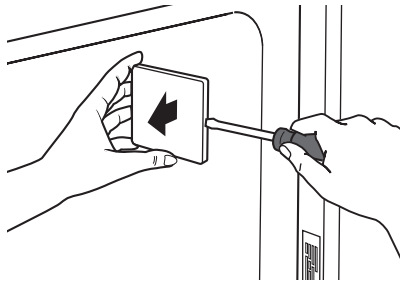

- Remove the halogen bulb from its socket.
- Hold the new bulb **with a cloth** (i.e. tissue) and push it into the socket.
- Reinstall the glass cover.
- Screw the shelf rack on again.

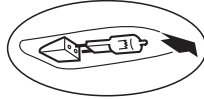

## Replacing the door sealing

- ⚠ Do not use the oven with damaged or missing door sealing! If the sealing is damaged or can't be cleaned anymore, it must be replaced. You can get a new sealing from KÜPPERSBUSCH Customer Service.

### Removing the sealing

- To remove the sealing, gently pull each corner out.
- Anschließend die beiden Mittelbefestigungen aushängen.

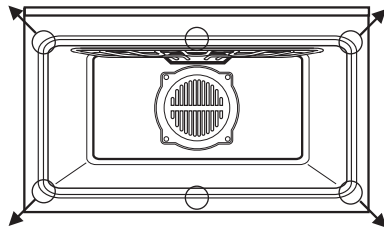

### Fitting the new sealing

- Clasp one corner after the other into the oven front. Be sure not to bend or mutilate the hooks!
- Die beiden Mittelbefestigungen wieder einhängen.

## After Sales Service

In the event of a problem that you can't easily fix yourself, or for spare part service, please contact the Küppersbusch Customer Care line at

**1-800-459-0844**

- ✍ Always have the information from the identification panel handy when calling Customer Service.

The rating label for the oven is located on the underside of the front panel and is visible when the oven door is open.

- Make a note of this information in case you have to consult our customer service.

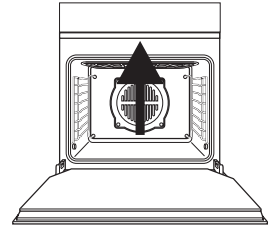

Production-no. oven											

Model designation oven											

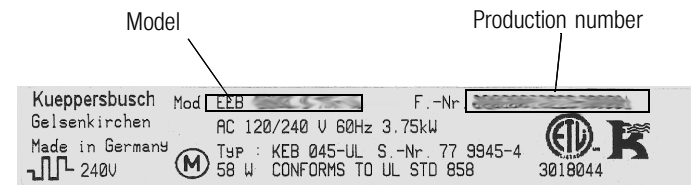

**KÜPPERSBUSCH USA**

4920 W. Cypress Street, Suite 106

Tampa, Florida 33607

Telephone: 800-459-0844 Fax: 813-288-8604

**Customer Care line: 1 - 800 - 459 - 0844**

[www.kuppersbuschusa.com](http://www.kuppersbuschusa.com)

KÜPPERSBUSCH USA is a division of Teka USA



**EXTRAORDINARY KITCHENS BY DESIGN**



## Free Manuals Download Website

<http://myh66.com>

<http://usermanuals.us>

<http://www.somanuals.com>

<http://www.4manuals.cc>

<http://www.manual-lib.com>

<http://www.404manual.com>

<http://www.luxmanual.com>

<http://aubethermostatmanual.com>

Golf course search by state

<http://golfingnear.com>

Email search by domain

<http://emailbydomain.com>

Auto manuals search

<http://auto.somanuals.com>

TV manuals search

<http://tv.somanuals.com>