

KUSTOM[®]

OWNER'S MANUAL

GROOVE 115C BASS AMPLIFIER



Congratulations on the purchase of your new Kustom amplifier! Your new GROOVE 115C offers unsurpassed sound quality and performance characteristics. Inside this manual you'll find detailed information regarding the amplifier's features. We wish you many years of enjoyment with your Kustom GROOVE 115C.

ENGLISH

Danger

Exposure to extremely high noise levels may cause a permanent hearing loss. Individuals vary considerably to noise induced hearing loss but nearly everyone will lose some hearing if exposed to sufficiently intense noise for a sufficient time. The U.S. Government's Occupational Safety and Health Administration (OSHA) has specified the following permissible noise level exposures:

DURATION PER DAY (HOURS)	8	6	4	3	2	1
SOUND LEVEL (dB)	90	93	95	97	100	103

According to OSHA, any exposure in the above permissible limits could result in some hearing loss. Ear plugs or protectors in the ear canal or over the ears must be worn when operating this amplification system in order to prevent a permanent hearing loss. If exposure in excess of the limits as put forth above, to insure against potentially harmful exposure to high sound pressure levels, it is recommended that all persons exposed to equipment capable of inducing high sound pressure levels, such as this amplification system, be protected by hearing protectors while this unit is in operation.

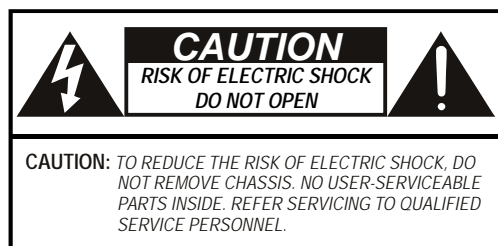

AVIS: RISQUE DE CHOC ELECTRIQUE-NE PAS OUVRIR.



THIS SYMBOL IS INTENDED TO ALERT THE USER TO THE PRESENCE OF NON-INSULATED "DANGEROUS VOLTAGE" WITHIN THE PRODUCT'S ENCLOSURE THAT MAY BE OF SUFFICIENT MAGNITUDE TO CONSTITUTE A RISK OF ELECTRIC SHOCK TO PERSONS.



THIS SYMBOL IS INTENDED TO ALERT THE USER TO THE PRESENCE OF IMPORTANT OPERATING AND MAINTENANCE (SERVICING) INSTRUCTIONS IN THE LITERATURE ACCOMPANYING THE UNIT.



APPARATUS SHALL NOT BE EXPOSED TO DRIPPING OR SPLASHING AND THAT NO OBJECTS FILLED WITH LIQUIDS, SUCH AS VASES, SHALL BE PLACED ON THE APPARATUS.

IMPORTANT SAFETY INSTRUCTIONS

1. Read all safety and operating instructions before using this product.
2. All safety and operating instructions should be kept for future reference.
3. Read and understand all warnings listed on the operating instructions.
4. Follow all operating instructions to operate this product.
5. This product should not be used near water, i.e. Bathtub, sink, swimming pool, wet basement, etc.
6. Only use dry cloth to clean this product.
7. Do not block any ventilation openings, It should not be placed flat against a wall or placed in a built-in enclosure that will impede the flow of cooling air.
8. Do not install this product near any heat sources ;such as,radiators, heat registers, stove or other apparatus (including heat producing amplifiers) that produce heat.
9. Do not defeat the safety purpose of the polarized or grounding-type plug. A polarized plug has two blades with one wider than the other. A grounding-type plug has two blades and a third grounding prong. The wide blade or the third prong are provided for your safety. If the provided plug does not fit into your outlet, consult an electrician for replacement of the obsolete outlet.
10. Protect the power cord being walked on or pinched, particularly at Plugs, convenience receptacles and the point where they exit from the apparatus. Do not break the ground pin of the power supply cord.
11. Only use attachments specified by the manufacturer.
12. Use only with the cart, stand, tripod, bracket, or table specified by the manufacturer or sold with the apparatus. When a cart is used, use caution when moving cart/apparatus combination to avoid injury from tip-over.
13. Unplug this apparatus during lightning storms or when unused for long periods of time.
14. Care should be taken so that objects do not fall and liquids are not spilled into the unit through the ventilation ports or any other openings.
15. Refer all servicing to qualified service personnel. Servicing is required when the apparatus has been damaged in any way; such as, power-supply cord or plug is damaged, liquid has been spilled or objects have fallen into the apparatus, the apparatus has been exposed to rain or moisture, does not operate normally or has been dropped.
16. **WARNING:** To reduce the risk of fire or electric shock, do not expose this apparatus to rain or moisture.

FRENCH

Danger

L'exposition a des niveaux eleves de bruit peut provoquer une perte permanente de l'audition, Chaque organisme humain reagit differemment quant a la perte de l'audition, mais quasiment tout le monde subit une diminution de l'acuite auditive lors d'une exposition suffisamment longue au bruit intense. Les autorites competentes en reglementation de bruit ont defini les expositions tolerees aux niveaux de bruits:

DURE EN HEURES PAR JOUR	8	6	4	3	2	1
INIVEAU SONORE CONTINU EN dB	90	93	95	97	100	103

Selon les autorites, toute exposition dans les limites citees ci-dessus, peuvent provoquer certaines pertes d'audition. Des bouchons ou protections dans l'appareil auditif ou sur l'oreille doivent etre portes lors de l'utilisation de ce systeme d'amplification afin de prevenir le risque de perte permanente de l'audition, Dans le cas d'expositions superieures aux limites precitees il est recommande, afin de se premunir contre les expositions aux pressions acoustiques eleves potentiellement dangeure u ses, aux personnes exposees aux equipements capables de delivrer de telles puissances, tels ce systeme d'amplification en fonctionnement, de proteger l'appareil auditif.



CE SYMBOLE A POUR BUT D'AVERTIR L'UTILISATEUR DE LA PRESENCE DE VOLTAGE DANGEREUX NON-ISOLE A L'INTERIEUR DE CE PRODUIT QUI PEUT ETRE DE PUISSANCE SUFFISAMMENT IMPORTANTE POUR PROVOQUER UN CHOC ELECTRIQUE AUX PERSONNES.



CE SYMBOLE A POUR BUT D'AVERTIR L'UTILISATEUR DE LA PRESENCE D'INSTRUCTIONS D'UTILISATION ET DE MAINTENANCE DANS LES DOCUMENTS FOURNIS AVEC CE PRODUIT.



AFIN DE REDUIRE LES RISQUÉ D'INCENDIE ET DE DECHARGE ELECTRIQUE, NE PAS EXPOSER CET APPAREIL A LA PLUIE OU A L'HUMIDITE.

IMPORTANTES INSTRUCTIONS DE SECURITE

1. Lire avec attention toutes les recommandations et précautions d'emploi avant d'utiliser ce produit.
2. Toutes les recommandations et précautions d'emploi doivent être conservées afin de pouvoir s'y reporter si nécessaire.
3. Lire et comprendre tous les avertissements énumérés dans les précautions d'emploi.
4. Suivre toutes les précautions d'emploi pour utiliser ce produit.
5. Ce produit ne doit pas être utilisé près d'eau, comme par exemple baignoires, éviers, piscine, sous-sol humides ... Etc.
6. Utiliser exclusivement un chiffon sec pour nettoyer ce produit.
7. Ne bloquer aucune ouverture de ventilation. Ne pas placer le produit tout contre un mur ou dans une enceinte fermée, cela générerait le flux d'air nécessaire au refroidissement.
8. Ne pas placer le produit près de toute source de chaleur telle que radiateurs, arrivées d'air chaud, fourneaux ou autres appareils générant de la chaleur (incluant les amplificateurs producteurs de chaleur).
9. Ne pas négliger la sécurité que procure un branchement polarisé ou avec raccordement à la terre, Un branchement polarisé comprend deux fiches dont l'une est plus large que l'autre. Un branchement à la terre comprend deux fiches plus une troisième reliée à la terre. Si la fiche secteur fournie ne s'insère pas dans votre prise de courant. consulter un électricien afin de remplacer votre prise obsolète.
10. Protéger le cordon d'alimentation de tout écrasement ou pincement, particulièrement au niveau des fiches, des réceptacles utilisés et à l'endroit de sortie de l'appareil. Ne pas casser la fiche de terre du cordon d'alimentation.
11. Utiliser uniquement les accessoires spécifiés par le constructeur.
12. Utiliser uniquement avec le chariot de transport, le support, le trépied, la console ou la table spécifiés par le constructeur ou vendus avec l'appareil. Lors de l'utilisation d'un chariot, bouger avec précaution l'ensemble chariot/l'appareil afin d'éviter les dommages d'un renversement.
13. Débrancher cet appareil lors d'orages ou s'il n'est pas utilisé pendant une longue période.
14. Des précautions doivent être prises afin qu'aucun objet ne tombe et qu'aucun liquide ne se répande à l'intérieur de l'appareil par les orifices de ventilation ou n'importe quelle autre ouverture.
15. Pour toutes interventions techniques s'adresser à un technicien qualifié. L'intervention technique est nécessaire lorsque l'appareil a été endommagé de n'importe quelle façon, comme par exemple si le cordon secteur ou sa fiche sont détériorés, si du liquide a coulé ou si des objets sont tombés à l'intérieur de l'appareil, si l'appareil a été exposé à la pluie ou à l'humidité, s'il ne fonctionne pas normalement ou s'il est tombé.
16. ATTENTION: Pour réduire le risque d'incendie ou de choc électrique ne pas exposer l'appareil à la pluie ou à l'humidité.

Product Contents

These items are included with your GROOVE 115C amplifier.
Be sure to contact your dealer if any items are missing.

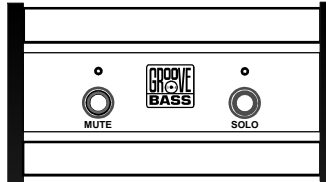

**Footswitch
KAC-GFS100**

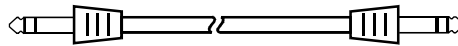

Footswitch Cable

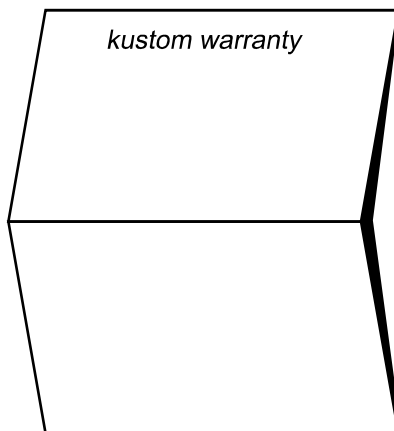

Warranty Card

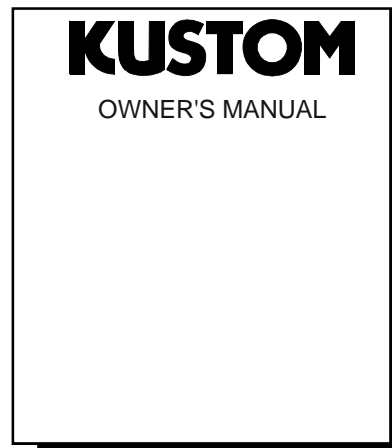

Owners Manual

Quick Setup

Your GROOVE 115C is ready to play right out of the box. After reviewing this Quick Setup page, feel free to experiment with the controls and create your own unique sound.

- ① Set tone controls flat and **Master Volume Control** down.

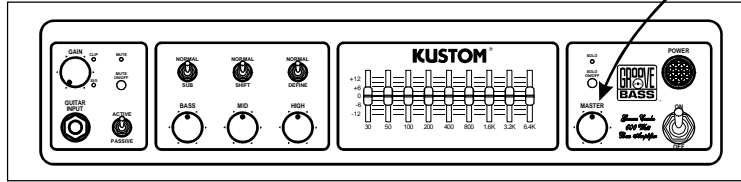

- ② Connect input, AC power cord, and the footswitch cable. If using a passive bass, toggle the **Active/Passive Switch** to Passive. If the Red **Clip Indicator** lights while playing, toggle the **Active/Passive Switch** to Active.

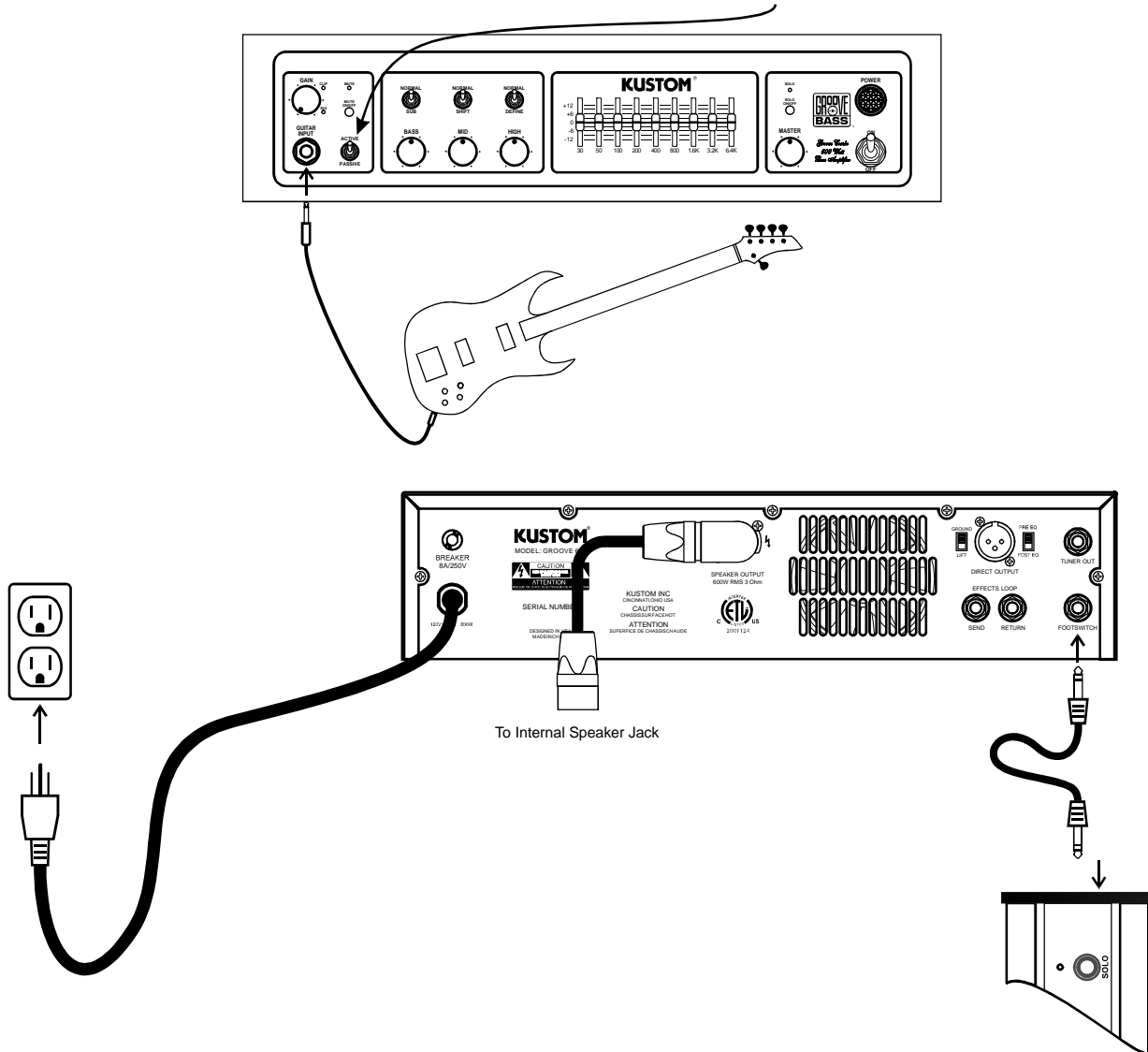

- ③ Turn on the **Power Switch**, adjust the **Gain Control** until the Green **Signal Indicator** lights regularly, turn up **Master Volume Control** slowly, and start playing.

Front Panel

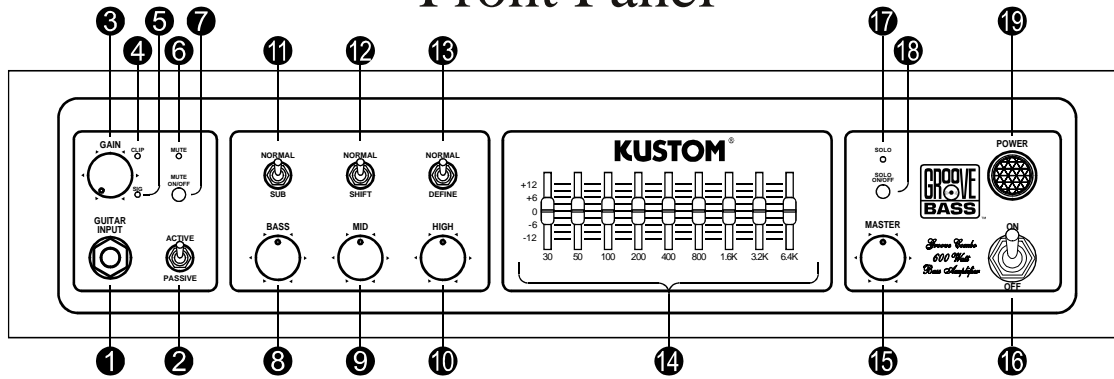

- 1 Guitar Input Jack:**
This is a 1/4" 2-conductor input jack for plugging in your instrument. It is intended for bass guitar but will accept other instruments as well.
- 2 Active/Passive Switch**
Set this switch to Active when using an active bass guitar. Setting to Active will lower the input gain by 12 dB.
- 3 Gain Control:**
Adjust clockwise to increase the amount of preamp volume. When set too low, the **Signal Indicator** will not light.
- 4 Clip Indicator:**
Indicates when the input signal has reached maximum level. **Note:** The **Active / Passive Switch** is the only control on the amplifier that has an effect on this. If the switch is set to Active and the Clip Indicator still lights, lower the output of your instrument to correct.
- 5 Signal Indicator:**
Indicates when sufficient signal is applied to the preamp. Adjusting the **Gain Control** will affect this.
- 6 Mute Indicator:**
This indicator will light when the preamp is muted. This can be done by either pressing the **Mute On/Off Button** on the front panel or by pressing Mute on the footswitch. **Note:** The **Tuner Out Jack** will still be active when this is lit.
- 7 Mute On/Off Button:**
When this switch is active the preamp will be muted. However, the **Tuner Out Jack** is always active. **Note:** When using the footswitch, this button will be disabled.
- 8 Bass Control:**
Controls the amount of low frequency in the signal. The **Normal / Sub Switch** changes the center frequency for this control. (See **11**)
- 9 Mid Control:**
Controls the amount of mid frequency in the signal. The **Normal / Shift Switch** changes the center Frequency for this control. (See **12**)
- 10 High Control:**
Controls the amount of high frequency in the signal. The **Normal / Define Switch** changes the center frequency of this control. (See **13**)
- 11 Normal / Sub Switch:**
When this switch is set to Normal, the **Bass Control** frequency is centered at 100Hz. When this switch is set to Sub, the **Bass Control** frequency is centered at 50Hz.
- 12 Normal / Shift Switch:**
When this switch is set to Normal, the **Mid Control** frequency is centered at 800Hz. When this switch is set to Shift, the **Bass Control** frequency is centered at 400Hz.
- 13 Normal / Define:**
When this switch is set to Normal, the **High Control** frequency is centered at 3KHz. When this switch is set to Define, the **High Control** frequency is centered at 5KHz.
- 14 Graphic Equalizer Section:**
This 9-band graphic equalizer is used to finely adjust the sound to taste.
- 15 Master Volume Control:**
Controls the overall output of the amplifier.
- 16 Power Switch:**
Turns AC power on and off.
- 17 Solo Indicator:**
Indicates when the **Solo On/Off Button** is pressed. This will also light when Solo on the footswitch is pressed.
- 18 Solo On/Off Button:**
When this is active, the signal to the power amp will be boosted by 6dB. **Note:** When using the footswitch, this button will be disabled.
- 19 Power Jewel:**
Indicates when AC power is applied to the amplifier.

Rear Panel

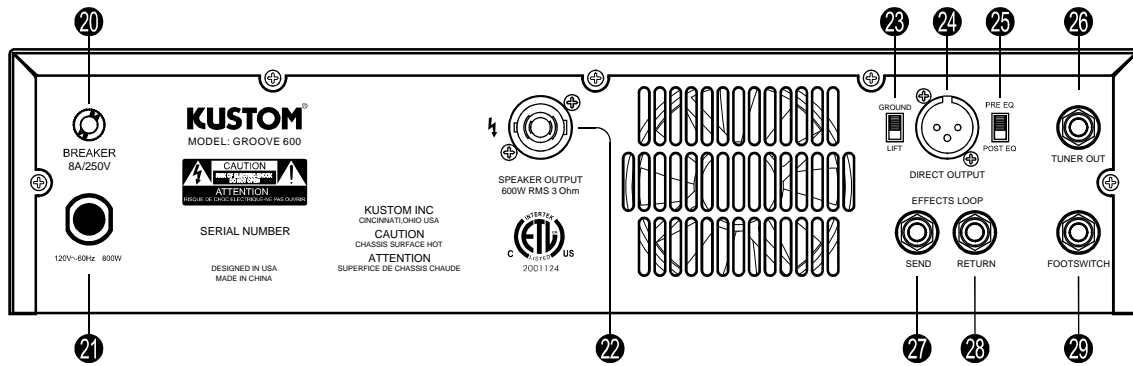

20 Circuit Breaker:

This circuit breaker will trip when too much current is applied to the amplifier. To reset: Turn off **Power Switch**, press circuit breaker button, and turn the **Power Switch** on. Note: If the Circuit Breaker trips repeatedly when AC power is applied, take the amplifier to an authorized service center for repair.

21 Power Cord:

This supplies AC power to the amplifier. If the cord becomes damaged, take the amplifier to an authorized service center for repair.

22 Speaker Output:

This jack is used to connect the amplifier to internal speakers, or an external speaker cabinet, using a heavy duty Speakon® speaker cable.
Note: To prevent overheating and possible loss of signal, do not connect a load lower than 2 ohms. (To connect a cable: Align tab on speaker cable connector slot. Insert and twist one quarter turn clockwise to lock. To remove a cable: Pull back release button on cable connector, twist connector counter clockwise one quarter turn, and pull out connector.)

23 Ground Lift Switch:

Activating this switch removes the ground connection on the **Direct Output Jack**. Removing the ground connection will eliminate ground related signal hum and noise.

24 Direct Output Jack:

This is a line level output used to connect the amplifier to another device, such as a mixer or recorder.

25 Pre EQ / Post EQ Switch:

When set to Pre EQ, the **Direct Output Jack** signal will be unaltered by the EQ sections of the preamp. When set to Post EQ, the **Direct Output Jack** signal will reflect the entire sound (including EQ settings) of the preamp. **Note:** The **Master Volume Control** and **Solo On/Off Button** have no effect on the **Direct Output Jack** signal.

26 Tuner Out Jack:

Use this jack to connect to a tuner or other line level device. This jack is always active and is a pre-gain output.

27 Effects Send Jack:

Use this jack to connect to the input of an external effects processor. This jack can also be used as a preamp out.

28 Effects Return Jack:

Use this jack to connect to the output of an external effects processor. This jack can also be used as a power amp in.

29 Footswitch Jack:

This 3-conductor 1/4" jack may be used for connecting a footswitch to the amplifier (Footswitch model KAC-GFS100 is included with the amplifier). The footswitch will then control the Mute and Solo features.

Rear Panel on Cabinet

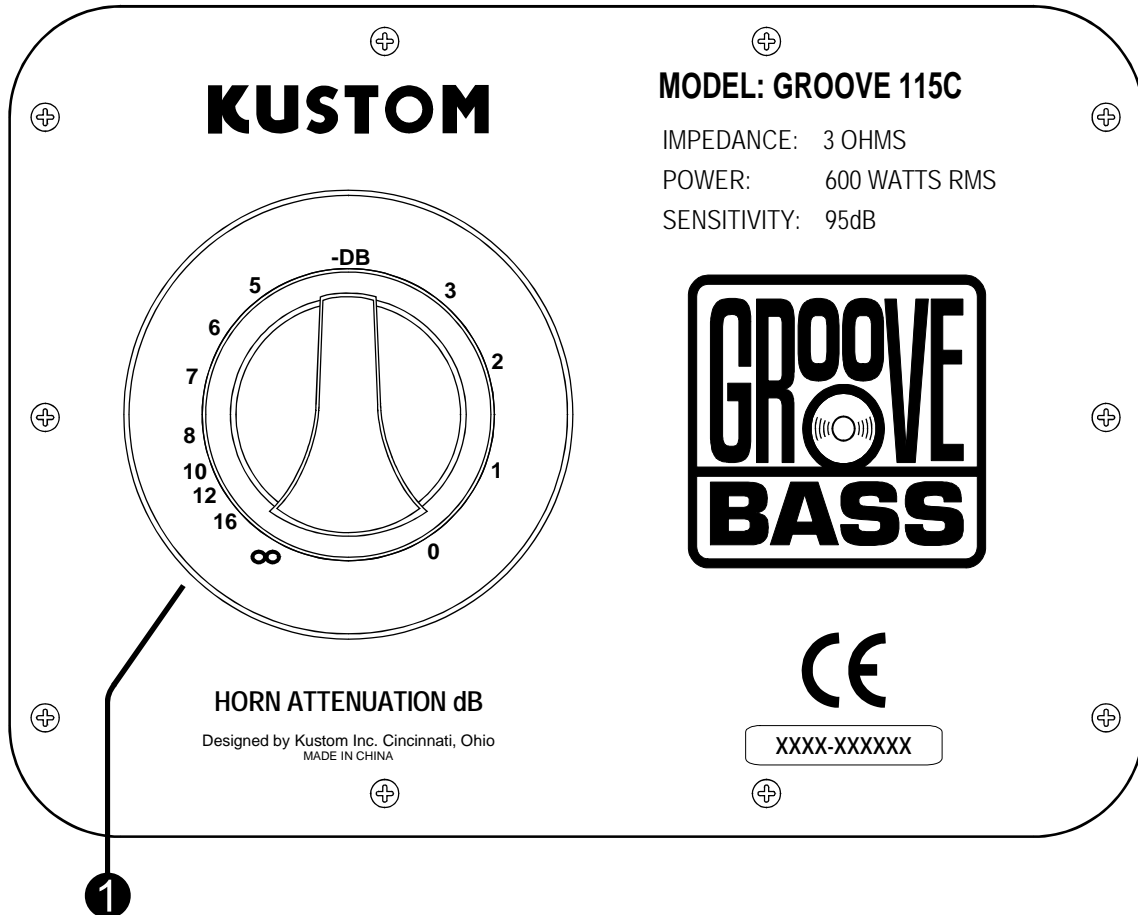

1 Horn Attenuator:

This is a “volume” control for the horn. To disable the horn, turn the knob counter clockwise until the indicator reaches ∞ . To set the horn for maximum output, turn the knob clockwise until the indicator reaches 0.

GROOVE 115C

Specifications

Model	Groove 115C	Bass guitar amplifier
Input Impedance	200K Ohm	
Output Power	600 Watts	3 Ohms @ 5% THD
Frequency Response	20HZ-20kHz	Actual response is tailored to speakers for accurate acoustical response using a bass guitar as input.
Hum & Noise	-60db	Residual Noise, all level controls 0% (minimum)
System Gain	27db	Preamp output
	15db	Preamp output, Active
	25db	Tuner output
	27db	Direct output
	32db	Power amp gain
All measurements taken with 1 KHz input signal, Tone controls flat, Gain and Volume Maximum. Measured at effects send output jacks on rear unless noted.		
Amplifier Type	Class B	Discrete device Class B amplifier
Speaker	1 X 15"	Specially Designed Eminence® Speaker
Footswitch	Any non-momentary two-button foot switch can be used.	
	Use any standard tip-ring-sleeve cable	
Power Requirements	USA/Canada	120VAC/60Hz, 800W nominal
	Europe	230VAC/50Hz, 800W nominal
	UK	230VAC/50Hz, 800W nominal
	Australia	240VAC/50Hz, 800W nominal
	Japan	100VAC/50-60Hz, 800W nominal
Dimensions	mm/kg	798 (Height) x 483 (Width) x 508 (Depth), 48 kg
	Inches/Pounds	31.5 (Height) x 19 (Width) x 20 (Depth), 106 lbs

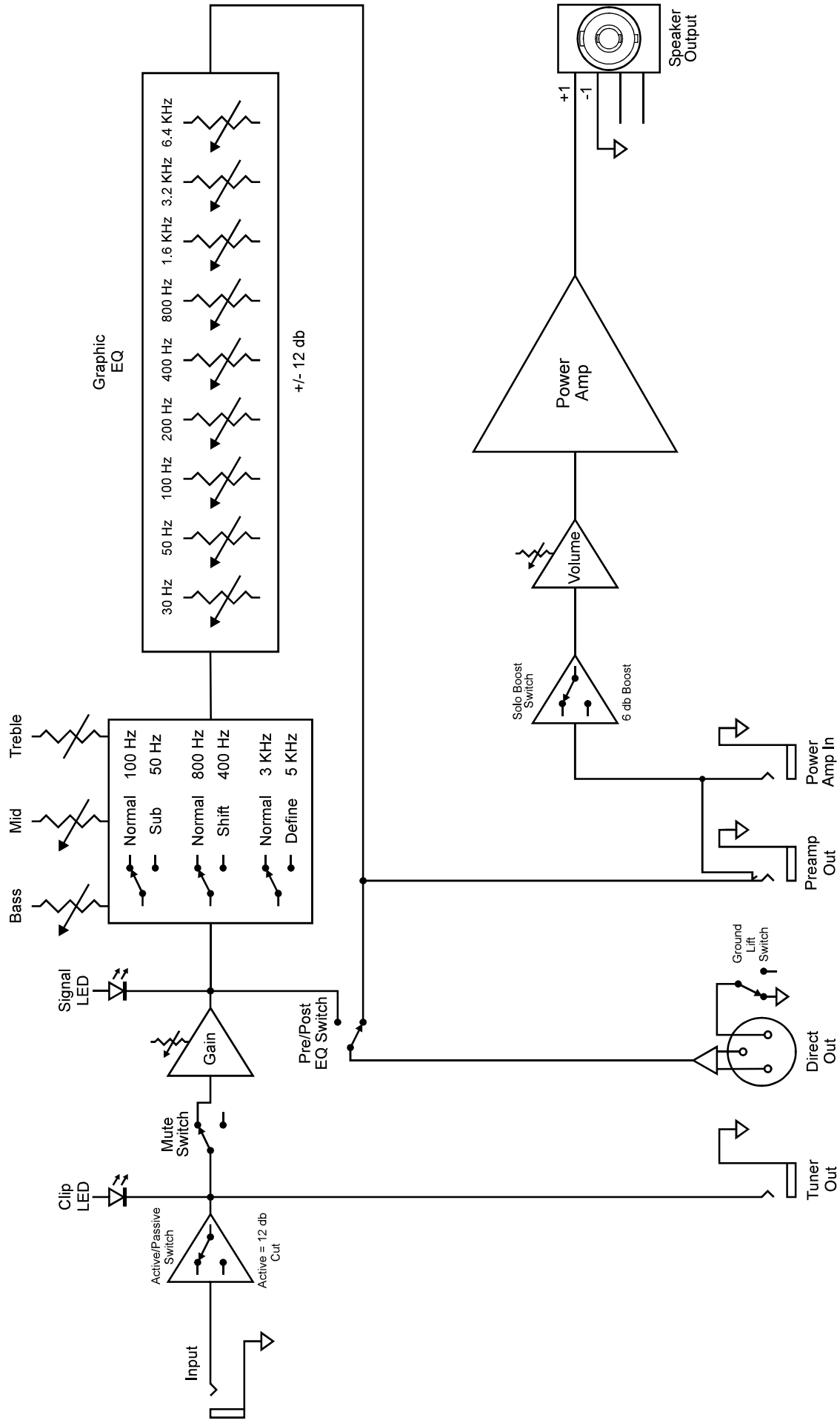

GROOVE 115C

Signal Flow Diagram

EC Declaration of Conformity

We: Kustom Musical Amplification Inc.
4940 Delhi Pike
Cincinnati, OH 45238
Tel: 1-513-451-5000 Fax: 1-513-347-2192

Declare that the product

Product name: Kustom

Product model number: Groove 115C

to which this declaration relates is in conformity with the following standards;

EN55013 (A12) : 1995	Limits and methods of measurement of radio disturbance characteristics of broadcast receivers and associated equipment.
EN55020: 1995	Electromagnetic immunity of broadcast receivers and associated equipment.
EN61000-3-2: 1995	Limits for harmonic current emissions (equipment input current \leq 16A per phase).
EN61000-3-3: 1995	Limitation of voltage fluctuations and flicker in low voltage supply systems for equipment with rated currents \leq 16A.
EN55103-1: 1995	Electromagnetic Compatibility - Product family standard for Audio, Video Audio-visual and entertainment Lighting Control Apparatus.
EN60065: 1994	Safety requirements for main operated electronic and related apparatus for household and similar general use.

Following the provisions of EU Council Directive(s): 72/73 EEC and 89/336/EEC.

We the undersigned, hereby declare that the equipment specified above conforms to the aforementioned directive(s).

Name of authorized person: James Brown, Chief Engineer

Signature:

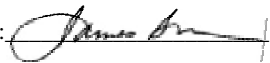

Date: 17 November 2004

Kustom Amplification Inc.
4940 Delhi Pike
Cincinnati, OH 45238
Tel: 1-513-451-5000 Fax: 1-513-347-2192

KUSTOM

Kustom Amplification Inc., 4940 Delhi Pike, Cincinnati, OH • USA
(800) 999-5558 Web: www.kustom.com

Free Manuals Download Website

<http://myh66.com>

<http://usermanuals.us>

<http://www.somanuals.com>

<http://www.4manuals.cc>

<http://www.manual-lib.com>

<http://www.404manual.com>

<http://www.luxmanual.com>

<http://aubethermostatmanual.com>

Golf course search by state

<http://golfingnear.com>

Email search by domain

<http://emailbydomain.com>

Auto manuals search

<http://auto.somanuals.com>

TV manuals search

<http://tv.somanuals.com>