

KUSTOM

OWNER'S MANUAL

WAV[®] 1000

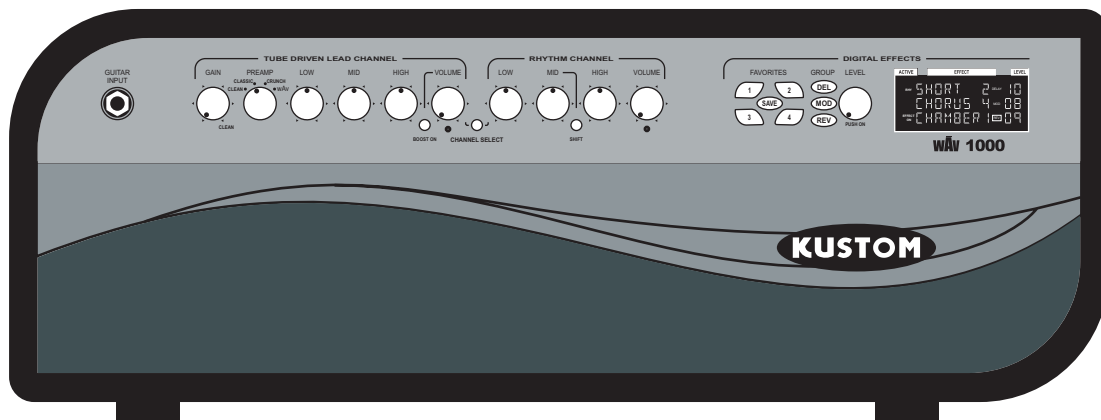

Congratulations on the purchase of your new Kustom amp! Your new WAV[®] 1000 offers an exciting blend of killer tones, unsurpassed flexibility and a unique new look. Inside this manual you'll find detailed information regarding the amp's features. We wish you many years of enjoyment with your Kustom WAV[®] 1000.

ENGLISH

Danger

Exposure to extremely high noise levels may cause a permanent hearing loss. Individuals vary considerably to noise induced hearing loss but nearly everyone will lose some hearing if exposed to sufficiently intense noise for a sufficient time.

The U.S. Government's Occupational Safety and Health Administration (OSHA) has specified the following permissible noise level exposures:

| | | | | | | |
|--------------------------|----|----|----|----|-----|-----|
| DURATION PER DAY (HOURS) | 8 | 6 | 4 | 3 | 2 | 1 |
| SOUND LEVEL (dB) | 90 | 93 | 95 | 97 | 100 | 103 |

According to OSHA, any exposure in the above permissible limits could result in some hearing loss. Ear plugs or protectors in the ear canal or over the ears must be worn when operating this amplification system in order to prevent a permanent hearing loss. If exposure in excess of the limits as put forth above, to insure against potentially harmful exposure to high sound pressure levels, it is recommended that all persons exposed to equipment capable of inducing high sound pressure levels, such as this amplification system, be protected by hearing protectors while this unit is in operation.

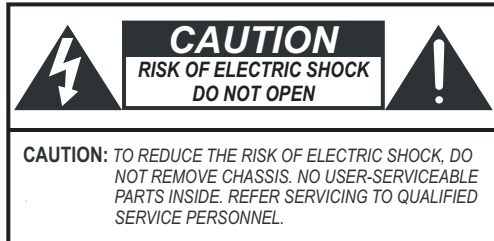

AVIS: RISQUE DE CHOC ELECTRIQUE-NE PAS OUVRIR.



THIS SYMBOL IS INTENDED TO ALERT THE USER TO THE PRESENCE OF NON-INSULATED "DANGEROUS VOLTAGE" WITHIN THE PRODUCT'S ENCLOSURE THAT MAY BE OF SUFFICIENT MAGNITUDE TO CONSTITUTE A RISK OF ELECTRIC SHOCK TO PERSONS.



THIS SYMBOL IS INTENDED TO ALERT THE USER TO THE PRESENCE OF IMPORTANT OPERATING AND MAINTENANCE (SERVICING) INSTRUCTIONS IN THE LITERATURE ACCOMPANYING THE UNIT.

IMPORTANT SAFETY INSTRUCTIONS

1. Read all safety and operating instructions before using this product.
2. All safety and operating instructions should be kept for future reference.
3. Read and understand all warnings listed on the operating instructions.
4. Follow all operating instructions to operate this product.
5. This product should not be used near water, i.e. Bathtub, sink swimming pool, wet basement, etc.
6. Only use dry cloth to clean this product.
7. Do not block any ventilation openings, It should not be placed flat against a wall or placed in a built-in enclosure that will impede the flow of cooling air.
8. Do not install this product near any heat sources ;such as, radiators, heat registers, stove or other apparatus (including heat producing amplifiers) that produce heat.
9. Do not defeat the safety purpose of the polarized or grounding-type plug. A polarized plug has two blades with one wider than the Other.A grounding-type plug has two blades and a third grounding prong. The wide blade or the third prong are provided for your safety. If the provided plug does not fit into your outlet, consult an electrician for replacement of the obsolete outlet.
10. Protect the power cord from being walked on or pinched, particularly at Plugs, convenience receptacles and the point where they exit from the apparatus. Do not break the ground pin of the power supply cord.
11. Only use attachments specified by the manufacturer.
12. Use only with the cart, stand, tripod, bracket, or table specified by the manufacturer or sold with the apparatus. When a cart is used, use caution when moving cart/apparatus combination to avoid injury from tip-over.
13. Unplug this apparatus during lightning storms or when unused for long periods of time.
14. Care should be taken so that objects do not fall and liquids are not spilled into the unit through the ventilation ports or any other openings.
15. Refer all servicing to qualified service personnel. Servicing is required when the apparatus has been damaged in any way; such as, power-supply cord or plug is damaged, liquid has been spilled or objects have fallen into the apparatus, the apparatus has been exposed to rain or moisture, does not operate normally or has been dropped.
16. **WARNING:** To reduce the risk of fire or electric shock, do not expose this apparatus to rain or moisture.

FRENCH

Danger

L'exposition a des niveaux eleves de bruit peut provoquer une perte permanente de l'audition, Chaque organisme humain reagit differemment quant a la perte de l'audition, mais quasiment tout le monde subit une diminution de l'acuite auditive lors d'une exposition suffisamment longue au bruit intense. Les autorites competentes en reglementation de bruit ont defini les expositions tolerees aux niveaux de bruits:

| | | | | | | |
|------------------------------|----|----|----|----|-----|-----|
| DURE EN HEURES PAR JOUR | 8 | 6 | 4 | 3 | 2 | 1 |
| INIVEAU SONORE CONTINU EN dB | 90 | 93 | 95 | 97 | 100 | 103 |

Selon les autorites, toute exposition dans les limites citees ci-dessus, peuvent provoquer certaines pertes d'audition. Des bouchons ou protections dans l'appareil auditif ou sur l'oreille doivent etre portes lors de l'utilisation de ce systeme d'amplification afin de prevenir le risque de perte permanente de l'audition, Dans le cas d'expositions superieures aux limites precitees il est recommande, afin de se premunir contre les expositions aux pressions acoustiques lvees potentiellement dangeure u ses, aux personnes exposees aux equipements capables de delivrer de telles puissances, tels ce systeme d'amplification en fonctionnement, de proteger l'appareil auditif.



CE SYMBOLE A POUR BUT D'AVERTIR L'UTILISATEUR DE LA PRESENCE DE VOLTAGE DANGEREUX NON-ISOLE A L'INTERIEUR DE CE PRODUIT QUI PEUT ETRE DE PUISSANCE SUFFISAMMENT IMPORTANTE POUR PROVOQUER UN CHOC ELECTRIQUE AUX PERSONNES.



CE SYMBOLE A POUR BUT D'AVERTIR L'UTILISATEUR DE LA PRESENCE D'INSTRUCTIONS D'UTILISATION ET DE MAINTENANCE DANS LES DOCUMENTS FOURNIS AVEC CE PRODUIT.

IMPORTANTES INSTRUCTIONS DE SECURITE

1. Lire avec attention toutes les recommandations et precautions d'emploi avant d'utiliser ce produit.
2. Toutes les recommandations et precautions d'emploi doivent être conservees afin de pouvoir s'y reporter si necessaire.
3. Lire et comprendre tous les avertissements énumérés dans les precautions d'emploi.
4. Suivre toutes les precautions d'emploi pour utiliser ce produit.
5. Ce produit ne doit pas être utilisé près d'eau, comme par exemple baignoires, évier, piscine, sous-sol humides ... Etc.

6. Utiliser exclusivement un chiffon sec pour nettoyer ce produit.
7. Ne bloquer aucune ouverture de ventilation. Ne pas placer le produit tout contre un mur ou dans une enceinte fermée, cela générerait le flux d'air nécessaire au refroidissement.
8. Ne pas placer le produit près de toute source de chaleur telle que radiateurs, arrivées d'air chaud, fourneaux ou autres appareils générant de la chaleur (incluant les amplificateurs producteurs de chaleur) .
9. Ne pas négliger la sécurité que procure un branchement polarisé ou avec raccordement à la terre, Un branchement polarisé comprend deux fiches dont l'une est plus large que l'autre. Un branchement à la terre comprend deux fiches plus une troisième reliée à la terre. Si la fiche secteur fournie ne s'insert pas dans votre prise de courant. consulter un 'électricien afin de remplacer votre prise obsolète.
10. Protéger le cordon d'alimentation de tout écrasement ou pincement, particulièrement au niveau des fiches, des réceptacles utilisés et à l'endroit de sortie de l'appareil. Ne pas casser la fiche de terre du cordon d'alimentation.
11. Utiliser uniquement les accessoires spécifiés par le constructeur.
12. Utiliser uniquement avec le chariot de transport, le support, le trépied, la console ou la table spécifiés par le constructeur ou vendus avec l'appareil. Lors de l'utilisation d'un chariot, bouger avec précaution l'ensemble chariotlappareil afin d'éviter les dommages d'un renversement.
- 13 Débrancher cet appareil lors d'orages ou s'il n'est pas utilisé pendant une longue période.
14. Des précautions doivent être prises afin qu'aucun objet ne tombe et qu'aucun liquide ne se répande à l'intérieur de l'appareil par les orifices de ventilation ou n'importe quelle autre ouverture.
15. Pour toutes interventions techniques s'adresser à un technicien qualifié.L'intervention technique est nécessaire lorsque l'appareil a été endommagé de n'importe quelle façon, comme par exemple si le cordon secteur ou sa fiche sont détériorés,si du liquide a coulé ou si des objets sont tombés à l'intérieur de l'appareil, si l'appareil a été exposé à la pluie ou à l'humidité, s'il ne fonctionne pas normalement ou s'il est tombé.
16. ATTENTION:Pour réduire le risque d'incendie ou de choc electrique ne pas exposer l'appareil à la pluie ou à l'humidité.

Product Contents

These items are included with your WAV® 1000 amplifier.
Be sure to contact your dealer if any items are missing.

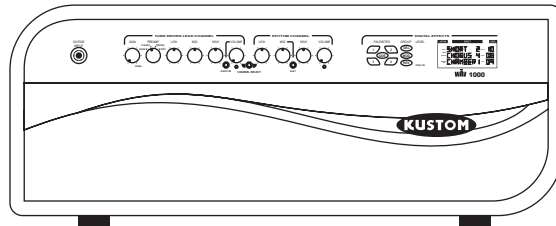

**Amplifier
WAV® 1000**



AC Power Cord



**Two Speaker Cables
10' (3.1 meter) w/Molded 1/4" male plugs**

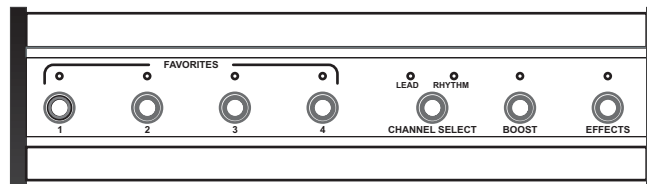

**Footswitch
KAC-FSWAV**

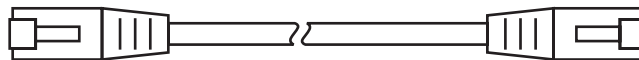

**Footswitch Cable
25' (7.6 meter) CAT5 568A**

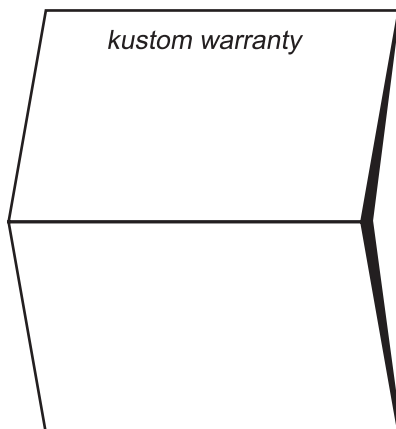

Warranty Card

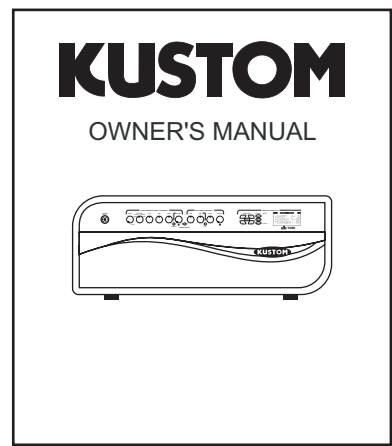

Owners Manual

Quick Setup

Your WAV® 1000 is ready to play right out of the box. After going through this Quick Setup page, feel free to play the amp and experiment with the controls. If you get lost, you can always restore the factory default presets by repeating step 3 below. Factory presets are shown on page 9, Fig. B.

- ① Set tone controls flat. Volume controls down.

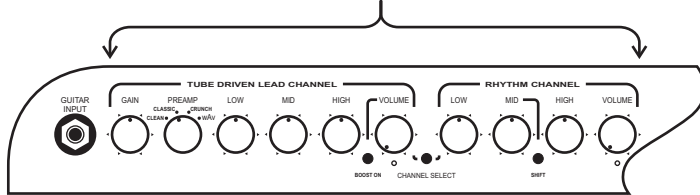

- ② Connect input, AC power cord, and Footswitch cable

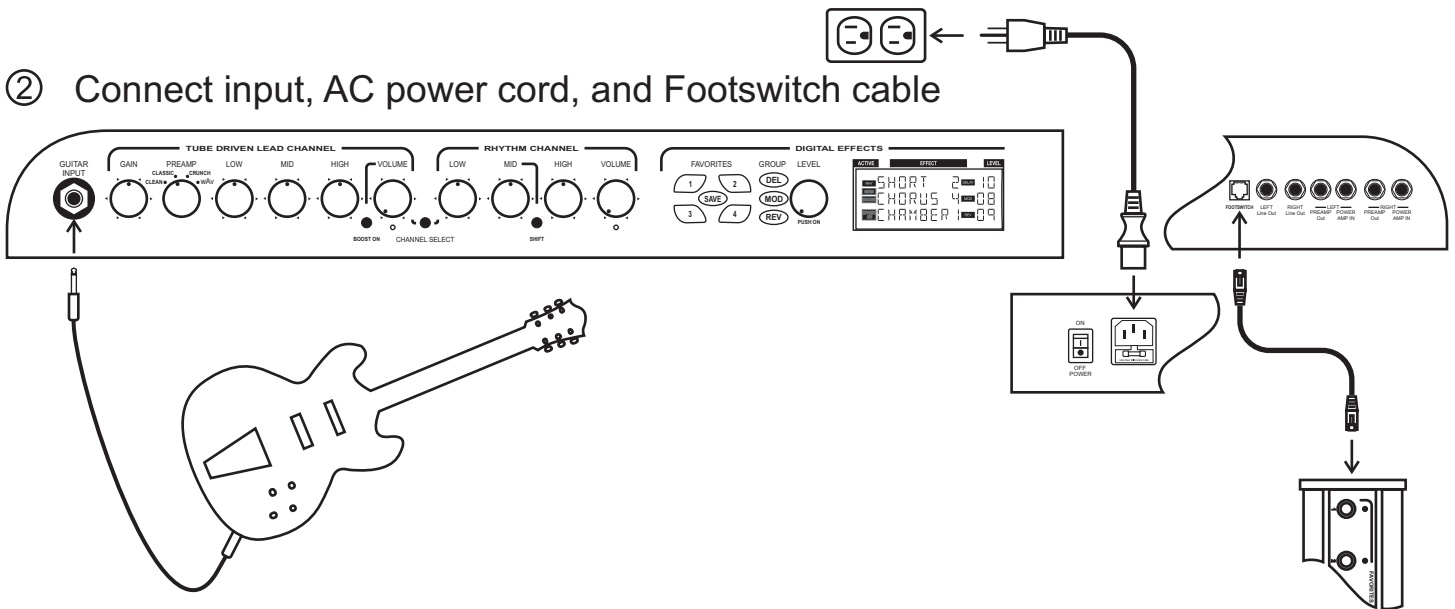

- ③ Do one of the following:

- **Reset amp to factory presets-** Hold down Favorites 1 (1) and REV (REV) then turn on power. Hold Favorites 1 and REV 2 seconds after power is on, then release. Your WAV® amp is now set to Factory settings.
- **Use saved presets-** Turn power on without holding or pressing any buttons.

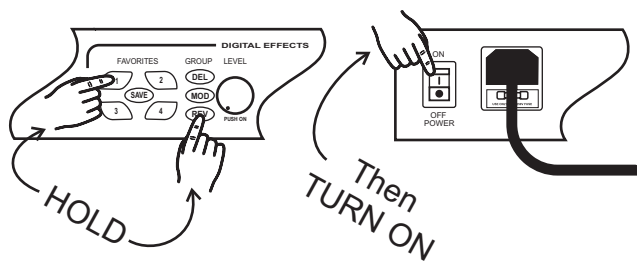

RESET (Optional)

- ④ Start playing (don't forget to turn up the volume).

Front Panel

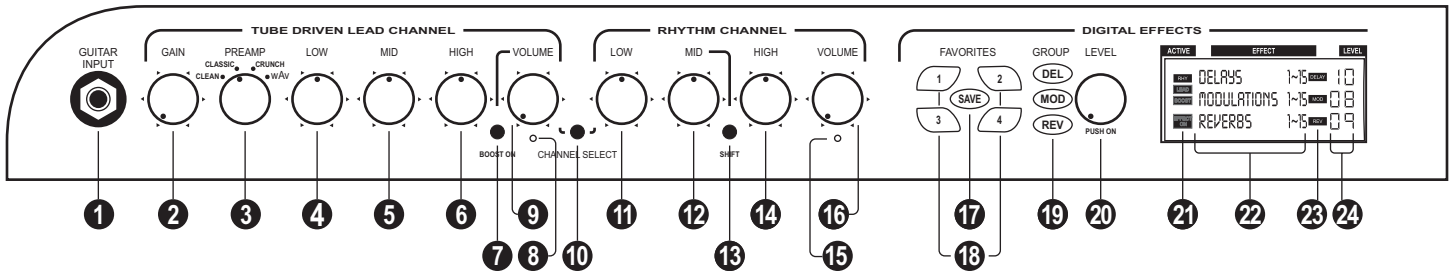

1 Guitar Input Jack:

This is a 1/4" 2-conductor input jack for plugging in your instrument. It is intended for guitars but will accept other instruments as well.

2 Lead Channel Gain:

Adjust clockwise to increase the amount of distortion. Used in the lower ranges of the control, you get a less distorted sound, a "bluesy" tone. As you increase the gain, you add tremendous amounts of distortion to the signal for a harder edged "crunch" tone.

3 Lead Channel Preamp Selector:

This 4-way switch selects which preamp you are using. Rotating it will switch between the uniquely voiced Clean, Classic, Crunch, and WAV® sounds.

- **Clean-** A warm and balanced tone with a light overdrive
- **Classic-** Vintage-style tube gain with an edgy British character.
- **Crunch-** High gain with a cutting midrange.
- **wAv-** Modern, extreme high gain.

4 Lead Channel Low:

Controls the selected passive tone stack's low frequencies when Lead Channel is selected.

5 Lead Channel Mid:

Controls the selected passive tone stack's mid frequencies when Lead Channel is selected.

6 Lead Channel High:

Controls the selected passive tone stack's high frequencies when Lead Channel is selected.

7 Lead Channel Boost switch:

Gives a 6 dB boost to the current lead channel setting and selects the Boost preset that is stored in the selected favorites bank. It works with or without the footswitch connected. This option is perfect for bringing you above the mix when taking a solo.

8 Lead Channel LED:

Indicates Lead channel is active.

9 Lead Channel Master Volume:

Controls the overall output of the amplifier when the lead channel is selected.

10 Channel Select switch:

Selects Lead or Rhythm channel and Lead or Rhythm preset stored in selected Favorites Bank.

11 Rhythm Channel Low:

Controls the passive tone stack's low frequencies when Rhythm Channel is selected.

12 Rhythm Channel Mid:

Controls the passive tone stack's Mid frequencies when Rhythm Channel is selected.

13 Rhythm Channel Shift switch:

When engaged, this switch will boost the bass response of the rhythm channel and give you a fuller, rounder tone.

14 Rhythm Channel High:

Controls the passive tone stack's high frequencies when Rhythm Channel is selected.

15 Rhythm Channel LED:

Indicates Rhythm channel is active.

16 Rhythm Channel Master Volume:

Controls the overall output of the amplifier when the Rhythm channel is selected.

17 Save Button:

This button saves any changes that were made to the Favorites. Whenever a favorite has been edited, the button pad will blink to indicate edit mode. Now you have the choice of storing the change by pressing Save, or just use the change temporarily by not permanently altering your last saved setting.

Front Panel and Footswitch

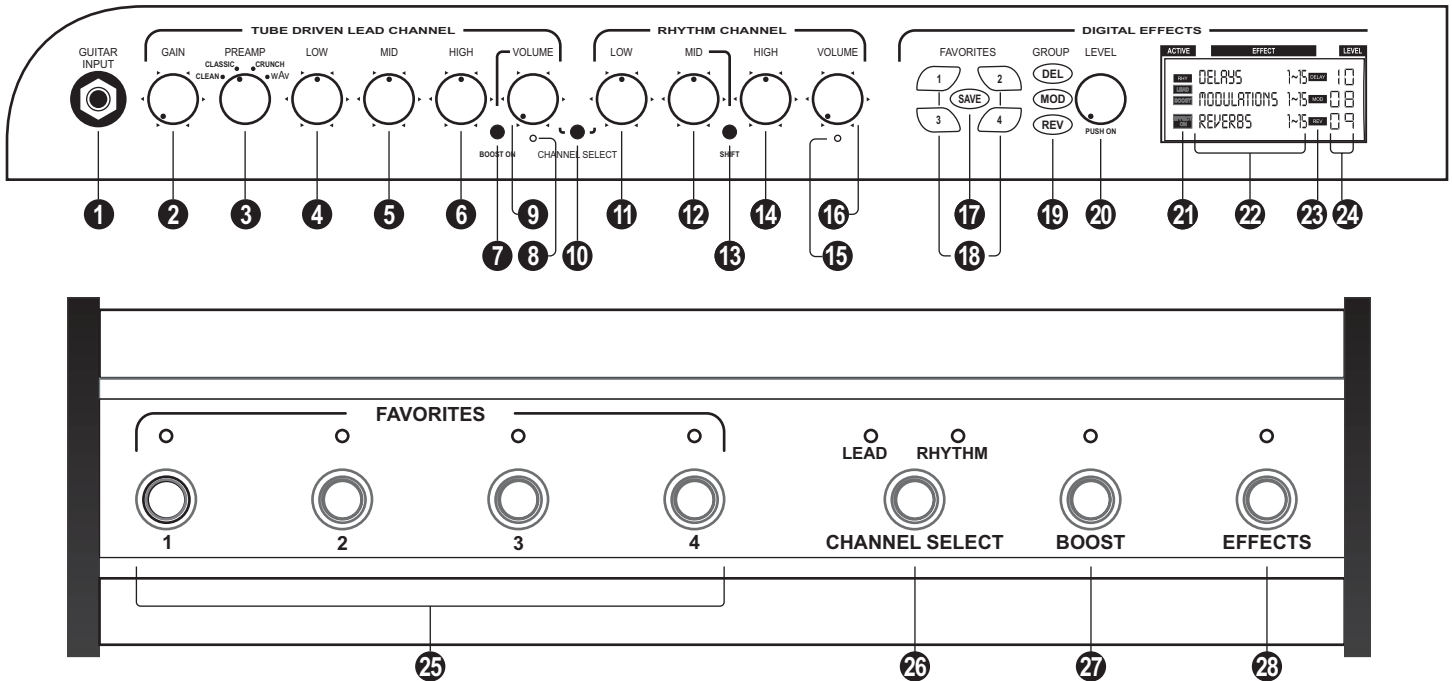

- 18 Favorites buttons:**
These buttons select a Favorites bank. Each channel (Lead or Rhythm) and the “Boost On” function, has 4 Favorites banks associated with it for a total of 12 Favorites Presets. These presets are activated by the “CHANNEL SELECT” button **10** and the “BOOST ON” button **7**. The “BOOST ON” preset cannot be selected in the rhythm channel. For more information, see “Using the Effects Processor” on page 9.
- 19 Group Buttons:**
These buttons allow you to select one of 15 effects or to bypass each group. The 3 types of groups are Delay, Modulation, and Reverb. For more information, see “Using the Effects Processor” on page 9.
- 20 Level/Push on:**
When rotated, this control adjusts the level of the lighted effect group. Pushing the knob turns the digital effects section on and off. For more information, see “Using the Effects Processor” on page 9.
- 21 Active Status:**
This section of the display shows which preset is active and if the digital effects section is on or off.
- 22 Effect Status:**
This section of the display indicates the name of the effect selected in each group. The word “BYPASS” is used when no effect in that group is used.
- 23 Group Edit Status:**
The name of the effect group is displayed at all
- times. The Effect Group name with an illuminated red rectangle around it will be edited by rotating the “LEVEL” control **20**. Press one of the 3 “GROUP” buttons **18** once to edit the level of selected effect group.
- 24 Level Status:**
Indicates the level of each effect group.
- 25 Footswitch Favorites Buttons:**
Duplicates Favorites buttons **18** on Front Panel. LED above switch is lit when selected. Front panel buttons **18** still work when Footswitch is connected.
- 26 Footswitch channel select:**
Duplicates “CHANNEL SELECT” button **26** on front panel. LEDs above this switch indicate which channel is selected. Front Panel channel select switch **26** still works when Footswitch is connected.
- 27 Footswitch Boost:**
Duplicates “BOOST ON” button **7** on front panel. LED above this switch indicates Boost is on. Lead channel must first be active to activate boost. Switching to Rhythm channel or pressing “Boost” again de-activates Boost. Front Panel channel Boost switch **7** still works when footswitch is connected.
- 28 Footswitch Effects On/Off:**
Turns on and off the Digital effects. LED is lit when effects are on. Level push switch **20** still works when Footswitch is connected.

Rear Panel

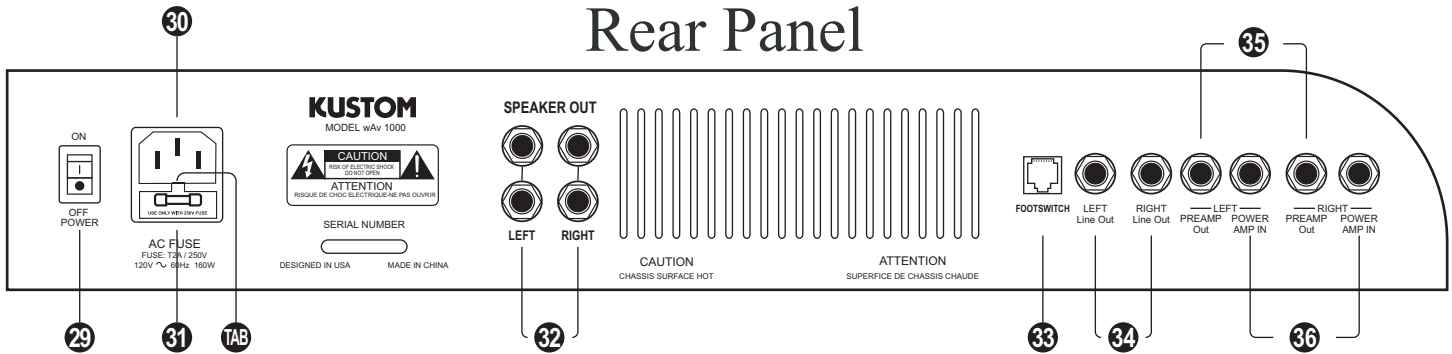

29 Power ON/OFF Switch:

Turns AC power on and off.

30 AC Power Cord Receptacle:

Insert the AC cord (provided) firmly into the AC connector. NOTE: Replace the AC power cord if protective jacket is damaged or ground pin is damaged or removed.

31 FUSE:

The fuse is located in a housing just below the receptacle. Replace only with same type and size. To remove the fuse, remove AC power cord and pull out on the tab ^{TAB} above the fuse symbol located on the fuse carriage. Place the new fuse in the carriage clip and re-insert. NOTE: To prevent an electrical hazard, DO NOT replace fuse without using the fuse carriage. Replace the fuse carriage if lost or damaged before re-inserting the AC power cord.

32 Speaker Output Jacks:

These jacks are used to connect external speakers to the head. Each channel has 2 jacks wired in parallel that function the same. **Never** connect a left and right output to a single mono cabinet. This will cause the amp to load itself, overheat, distort and shut down. It is not recommended to load either channel below 4 ohms because it will not produce maximum output and may cause overheating and shutting down.

For best results, connect external speakers using one of the following methods.

- **One “WAV® 412” cabinet-** Connect a speaker cable from one of the left output jacks on the amp to the left input jack on the cabinet. Repeat for the right channel. This puts an 8 ohm load/per channel on the amp. You can add speakers using the other jacks as long as they are not lower than 8 ohms per channel.
- **Two “WAV® 412” cabinets, wide separation-** Connect a speaker cable from one of the LEFT SPEAKER OUT jacks on the amp to the MONO Jack of the WAV® 412 cabinet on the left. Repeat for right channel. You can increase stereo separation by moving the cabinets further apart. This method is recommended when both cabinets are on the floor. This method puts a 4 ohm load on each channel. The remaining two jacks on amplifier should not be used.

- **Two “WAV® 412” cabinets stacked-** Use the method described for connecting one “WAV® 412” cabinet for both cabinets. This is best when stacking the cabinets on top of each other because it maintains Left and Right channel separation inside both cabinets in the stack. This method uses all 4 speaker jacks and requires 4 speaker cables. The amp load is 4 ohms per channel so no additional speakers should be used.
- **When used with third-party mono cabinets-** Because this is a stereo amp, you will need to connect mono cabinets in pairs. **NEVER** sum the left and right channels into a single Mono cabinet. You can use up to four 16 ohm pairs, two 8 ohm pairs, or one 4 ohm pair of cabinets. The total load should not be less than 4 ohms per channel.

33 Footswitch Jack:

Plug Footswitch into this connector using the supplied cable. If the cable is lost or damaged, a standard CAT 5 cable can be used. CAT 5 cables can be purchased at your local retail electronic and computer stores.

34 Left and Right Line Out:

These 1/4” mono jacks deliver the signal going to the speakers at an unbalanced line level. The main purpose of these jacks is to deliver line level outputs to external sound reinforcement devices such as powered monitors or speakers. They will not drive external non-powered speakers. To prevent an undesirable feedback oscillation, do not use these jacks on signal processors or effects that will be using the Power Amp Input jacks.

35 Left and Right Preamp out:

These 1/4” mono jacks deliver an unbalanced line level output from the preamp and digital effects. The main purpose of these jacks is to send a signal to the input of third-party signal processors or effects that will be using the Power Amp Input jacks. These jacks do not interrupt signal flow from the preamp to the power amp.

36 Left and Right Power Amp In:

These 1/4” mono jacks allow the left and right power amplifiers to be used with an external line level input. The main purpose of these jacks is to receive the return signal from a third-party signal processor or effect. NOTE: When used, these jacks will interrupt the signal flow from the preamp to the power amp.

Using the Digital Effects Processor

Description

The digital effects section is designed to allow quick changes during a performance. This is done by assigning each of the 3 channel selections an effect preset. The channel selections are Rhythm, Lead, and Lead Boost. The 3 channel selection presets are stored in banks called Favorites. There are 4 Favorites banks giving a total of 12 presets.

Each preset stores 3 different effect groups. The effect groups are Delays, Modulations, and Reverbs. Each effect group has 15 different effect selections to choose from and a level adjustment. They also include a bypass allowing the signal to pass through to the next group. Bypassing all 3 groups is the same as turning the effects off. This feature is useful if you want to switch channels and bypass the effects using a single switch. A Favorites preset stores parameters for each of the 3 Effect Groups giving a total of 6 effect parameters stored in each

preset. When any of the 6 parameters are changed, the Effect select and Favorites button flash to indicate the change is not saved. Press the Save button to save the changes or select another preset to ignore the changes when the preset is selected again. Switching to a different Favorite or selecting another channel changes presets.

The block diagram in Fig. A uses "Stomp Boxes" to represent the 3 Effect Groups. Notice how the "Stomp Box" parameters change for the different Preamp channel selections. The display shows these parameters. This gives the user a great advantage over a standard amplifier with "Stomp Boxes" where the changes would need to be made manually.

The chart in Fig. B lists the factory defaults for the 4 favorite banks. To restore the presets to factory defaults, hold Favorite 1 and REV buttons and turn power on (see page 5).

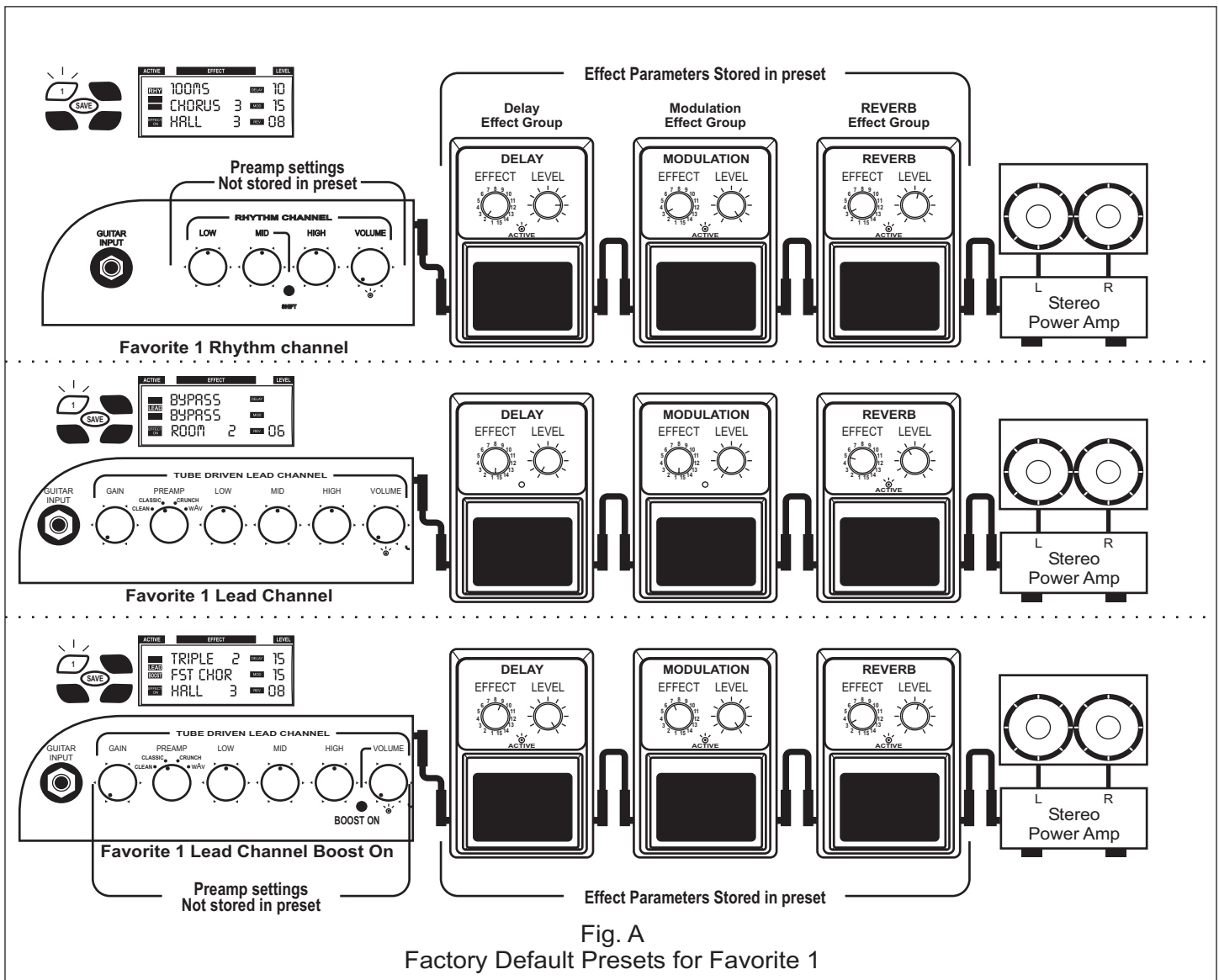

Fig. B
Factory Default Presets (To restore, see page 5)

| FAV 1 | DELAY | | MOD | | REV | |
|--------|----------|-------|----------|-------|----------|-------|
| | TYPE | LEVEL | TYPE | LEVEL | TYPE | LEVEL |
| RHYTHM | 100 MS | 10 | CHORUS 3 | 15 | HALL 3 | 8 |
| LEAD | BYPASS | | BYPASS | | ROOM 2 | 6 |
| BOOST | TRIPLE 2 | 15 | FST CHOR | 15 | HALL 3 | 8 |
| FAV 2 | DELAY | | MOD | | REV | |
| | TYPE | LEVEL | TYPE | LEVEL | TYPE | LEVEL |
| RHYTHM | 350 MS | 15 | BYPASS | | ROOM 5 | 15 |
| LEAD | 50MS | 15 | FLANGE 3 | 15 | L-R GATE | 5 |
| BOOST | BYPASS | | LESLIE F | 15 | L-R GATE | 15 |
| FAV 3 | DELAY | | MOD | | REV | |
| | TYPE | LEVEL | TYPE | LEVEL | TYPE | LEVEL |
| RHYTHM | BYPASS | | TREMO 1 | 15 | REV LOW | 8 |
| LEAD | 4/4 2 | 10 | DOUBLER | 15 | REV LOW | 6 |
| BOOST | 250 MS | 11 | FLANGE 2 | 15 | ROOM 1 | 8 |
| FAV 4 | DELAY | | MOD | | REV | |
| | TYPE | LEVEL | TYPE | LEVEL | TYPE | LEVEL |
| RHYTHM | 50MS | 15 | LESLIE F | 15 | HALL 1 | 6 |
| LEAD | 100 MS | 8 | TREMO 2 | 15 | HALL 2 | 10 |
| BOOST | REGEN 2 | 15 | BYPASS | | REV HI | 15 |

Using the digital effects while playing

The amplifier can be played with or without the Footswitch. You can select Favorites Banks, Channels, Boost, and turn effects on and off with the Footswitch without ever touching the amp. All front panel switches can still be used with Footswitch connected.

Selecting Channels and Presets:

- Press Channel Select Button to select Rhythm or Lead channel Favorites preset. The LEDs under each channel Volume control indicates the active channel. The VFD (Vacuum fluorescent display) indicates the Active channel, Preset Parameters, and Effect ON/OFF status. Notice the parameters change when switching channels.
- To select the Boost On and its Favorites preset, select Lead channel and press the Boost On button. The LED under the Lead Volume control is lit and the VFD display will show Lead Boost is selected. The parameters in the display change showing the Lead Boost Preset.

Preset/channel select Buttons

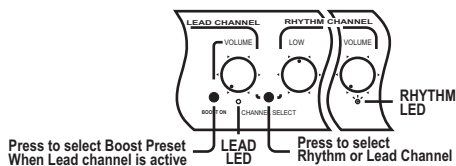

Information shown on VFD Display

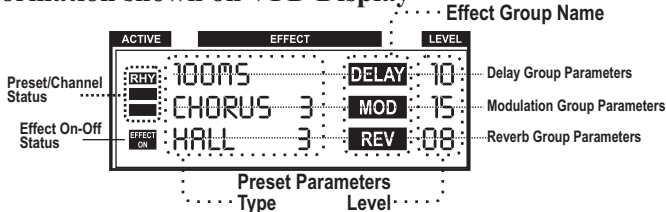

EXAMPLE Front panel Display and settings using Factory presets stored in "FAV 1" shown in Fig.B

When using Rhythm channel

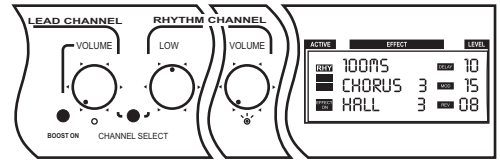

When using Lead channel

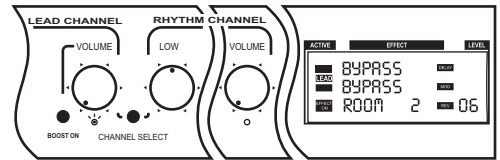

When using Lead Boost channel

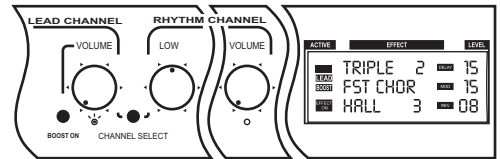

Selecting Favorite Preset Banks:

The 3 different presets used for the channels and Lead Boost are stored in banks called Favorites. There are 4 favorites to choose from. When a favorite button is pressed, the 3 presets stored in that favorite are assigned to the active and non-active channels. The active Favorite button is lit along with the LED on the Footswitch indicating the active Favorite bank.

EXAMPLE Favorite Banks 2 and 4 with Factory Defaults Fig. B

When using Favorite Bank 2

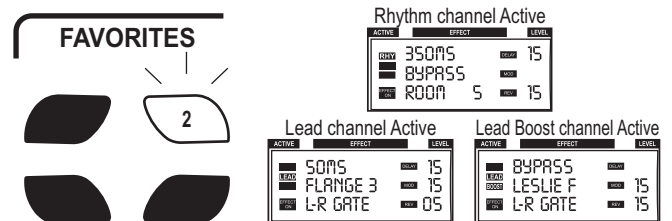

When using Favorite Bank 4

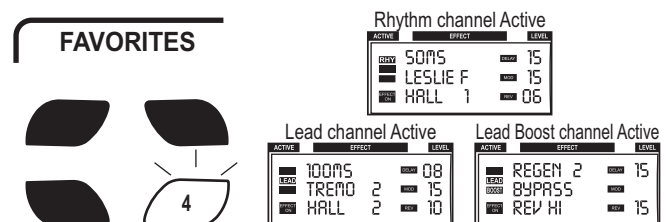

Editing the Digital Effects

The presets contain valid parameters under any condition. This makes Programming and Editing the same function. The word "Edit" will describe both programming and editing functions.

The parameters of the 3 presets stored in the active Favorite bank can be edited while in the Edit mode. This allows you to hear your changes and compare them between channel selections before saving. The active Favorite button and one of the group buttons will flash while in the edit mode. The effect group button lit or flashing indicates the Level can be adjusted. Notice there is also a red rectangle around the effect group name to the left of the level on the VFD display.

How to edit the Digital Effects:

Selecting different effects

Press any of the Effect Group buttons. They flash indicating you are in edit mode but no changes are made, even when the illuminated group button is pressed. An illuminated or flashing effect Group button indicates it is selected.

Select any of the 15 effects in a selected group or bypass it by repeat pressing the group button. The effect name is indicated on the display. The word "BYPASS" on the display indicates the effect group is turned off. Each time you press a flashing group button, the effect in that group moves up to the next one. You can also hold down the button to scroll through the effects. If you pass up the effect you want, continue scrolling until you reach the effect again. The chart in Fig. C shows how the effects in the 3 groups are organized.

Change the level of an effect group

The selected effect group button is illuminated. Rotate the Level control to raise or lower the level of the selected effect group. The effect group levels (1~15) are indicated on the display to the right of the group name. A red illuminated rectangle around a group name indicates it can be adjusted using the Level control.

EXAMPLE

The Reverb Group of Favorites 1 Rhythm channel preset is being edited.

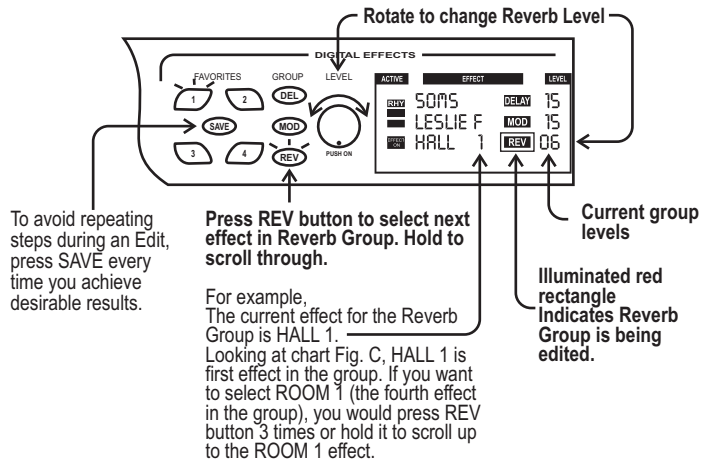

Making temporary changes

Once you get your effects set up, you may not want to make permanent changes during a performance. As long as you stay on the same Favorites bank and not disrupt the AC power, you can make temporary changes without saving. This makes it easy to change settings for different room acoustics.

Saving the temporary changes

Press the Save button. All 3 presets in the selected Favorites bank are saved.

Delete temporary changes and use saved Presets

Method 1

Select a different Favorites Bank without pressing save. The temporary changes are lost and originals restored the next time the un-saved Favorite Bank is selected.

Method 2

Turn power off then on again. Any changes not saved before turning off power will be lost.

Fig. C
Effect group selections

| DELAY | | | MODULATION | | | REVERB | | |
|---------------------|----------------|--------------|-----------------|---------------|--------------|--------------|----------------|--------------|
| Type | Variation | Display Name | Type | Variation | Display Name | Type | Variation | Display Name |
| Not Active | | BYPASS | Not Active | | BYPASS | Not Active | | BYPASS |
| Single Short Delay | 50ms | 50 MS | Chorus | Light Depth 1 | CHOR 1 | Hall 1 | 1s | HALL 1 |
| Single Medium Delay | 100ms | 100 MS | Chorus | Light Depth 2 | CHOR 2 | Hall 1 | 3s | HALL 2 |
| Single Medium Delay | 200ms | 200 MS | Chorus | Hi Depth 1 | CHOR 3 | Hall 1 | 5s | HALL 3 |
| Single Medium Delay | 250ms | 250 MS | Chorus | Hi Depth 2 | CHOR 4 | Room | .5s | ROOM 1 |
| Single Medium Delay | 300ms | 300 MS | Tremolo | Slow | TREMO 1 | Room | 1s | ROOM 2 |
| Single Medium Delay | 350ms | 350 MS | Tremolo | Fast | TREMO 2 | Room | 2s | ROOM 3 |
| Single Medium Delay | 400ms | 400 MS | Chorus | Fast2 | FST CHOR | Room | 4s | ROOM 4 |
| Multi Tap Delay | Triplet | TRIPLE 1 | Leslie | Slow | LESIE 5 | Room Hi Damp | 3s | ROOM 5 |
| Multi Tap Delay | Triplet Pan | TRIPLE 2 | Leslie | Fast | LESIE F | Hall 2 | 6s | HALL 4 |
| Multi Tap Delay | 4/4 Time 1 | 4/4 1 | Flanger | Light 1 | FLANGE 1 | Hall 2 | 10s | HALL 5 |
| Multi Tap Delay | 4/4 Time pan 1 | 4/4 2 | Flanger | Light 2 | FLANGE 2 | L to R Gate | Hi Dens. 500ms | L-R GATE |
| Multi Tap Delay | 4/4 Time 2 | 4/4 3 | Flanger | Deep Stereo | FLANGE 3 | Reverse Gate | Lo Dens. 100ms | REV LOW |
| Multi Tap Delay | 4/4 Time Pan 2 | 4/4 3 | Pitch Shifter 1 | Doubler | DOUBLER | Reverse Gate | Hi Dens. 300ms | REV HIGH |
| Regen 40% Delay | 100ms | REGEN 1 | Pitch Shifter 1 | Light Detune | L DETUNE | Forward Gate | Lo Dens. 100ms | FWD LOW |
| Regen 40% Delay | 200ms | REGEN 2 | Pitch Shifter 1 | Deep Detune | D DETUNE | Forward Gate | Hi Dens. 300ms | FWD HIGH |

FAQ Frequently Asked Questions:

1. Does using the Footswitch disable any features on the front panel?

ANSWER: No, any settings on the Footswitch that are repeated on the front panel can be changed using either the Footswitch or front panel buttons.

2. Can I use a different Footswitch with this amp, or use a different amp with this footswitch?

ANSWER: No. The KAC-FSWAV Footswitch supplied with your amp is the only one compatible. Do not use the KAC-FSWAV Footswitch on other third party amplifiers even if the CAT5 cable fits the Footswitch jack. Use only with Kustom WAV® series amps.

3. How are the line outputs different from the preamp output on the rear panel?

ANSWER: The Line outputs signal is taken from the power amp speaker outputs and attenuated 30 db so it can be used with powered speakers and monitors to give an accurate reproduction of the sound from the internal speakers. These jacks cannot be used with an effects loop because it is after the power amp in. The Preamp outputs are before the power amp inputs. These are best to use with third party signal processors or effects.

4. There is a low frequency hum in our PA when I connect the line level outputs to it. Any suggestions?

ANSWER: What you are most likely hearing is a ground loop hum. This happens when the AC outlets used by the PA and WAV® 1000 are on two different circuits. One way to correct this is to plug the WAV® 1000 into the same AC circuit as the PA. On larger PAs, several AC circuits may be used or the outlets on the same circuit are too far away to be practical. In this situation, a direct box will be needed (two if Stereo) to convert the un-balanced line outputs on the WAV® 1000 to balanced line outputs. If the direct box has a ground lift switch, be sure it's in the "lifted" position. To prevent an electrical hazard, DO NOT attempt to correct the ground loop problem by lifting or removing the AC ground pin on the power cord.

5. Can I run both Right and Left speaker outputs to a single mono cabinet with one speaker.

ANSWER: No. The right and Left speaker outputs use separate power amps. To prevent severe distortion and possible over-heating, do not sum these together. The WAV® 412 cabinet is Stereo. This cabinet is designed for use with the WAV® 1000 head.

6. I want to use digital effects on the lead channel and lead boost, but not on the rhythm channel. Is there a way to do this without having to press the effects button every time I switch between lead and rhythm channels?

ANSWER: Yes, select the rhythm channel and the Favorites Bank you want to store the setting in. Select "bypass" in all 3 groups for the effects to use. Press the "Save" button. Now select the Lead channel and set the 3 effect groups for desired sound and press "Save". Now press the Lead channel "Boost on" button and set the 3 effect groups for desired sound and press Save again.

7. I get different effects when switching channels. Is there something wrong?

ANSWER: No. One of the features of the effects is having the presets track the channels when switched. This is especially useful when playing live by allowing the musician to spend more time performing and less time changing amplifier and effect settings.

8. On the display, what causes an effects group to have a blank level display?

ANSWER: If an effects group is bypassed, the level is blank because there is nothing to adjust.

9. The amplifier has a mono input, so how does the amp have a stereo output?

ANSWER: The preamp is in mono up to the digital effects. The digital effects processor has a mono input with a stereo output. Both speakers will produce the same sound when the effects are not active or all three groups are bypassed.

10. I understand the Effect Group button that is illuminated can be controlled by the Level without pressing the button first. On some of my Presets, I usually need to just adjust the Reverb. Can I set this as my default for these presets so I don't have to press the Reverb (REV) button first before adjusting the level ?

ANSWER: Yes, and it's a simple thing to do. Go to the preset you want (Ex: Favorites 1 Rhythm), press the Reverb Group Button, then press the Save Button. All of your setting are the same except now the Reverb Group will be the selected Effect Group for that preset.

wAv[®] 1000 Specifications

| | | |
|----------------------------------|--|--|
| Model | wAv 1000 | Stereo guitar amp with digital effects and selectable preamps |
| Input Impedance | 200K Ohm | |
| Output Power | 100W per channel | 8 Ohms @ 5% THD |
| | 120W per channel | 4 Ohms @ 5% THD |
| Frequency Response | 20HZ-20kHz | Actual response is tailored to speakers for accurate acoustical response using a guitar as input. |
| Total Harmonic Distortion | Less than 0.4% | Because of the intentional distortion created by using some of the preamps and effects, this Distortion is measured from the power amp input signal to the output to speakers. |
| Hum & Noise | -50dB | Residual Noise, all level controls 0% (minimum) |
| System Gain | 30 dB | Lead Channel, Clean Preamp output |
| | 40dB | Lead Channel, Classic Preamp output |
| | 60dB | Lead Channel, Crunch Preamp output |
| | 60dB | Lead Channel, Wave Preamp output |
| | 6dB | Lead Channel added gain for all settings with Boost on |
| | 35dB | Rhythm Channel, Shift Out |
| | 40dB | Rhythm Channel, Shift In |
| | 35dB | Power amp gain |
| Digital Effects | 64K User Memory | |
| | 18 Bit 44.1Khz sampling rate Stereo Processor with onboard firmware flash memory | |
| | There are 45 selectable effects separated into 3 groups of 15. One effect from each group active at the same time. Up to 3 groups active at the same time. | |
| | There are 12 user presets. Each preset stores all setting for the 3 groups. There are 4 Favorites banks. Each favorites bank contains 3 user presets. Presets in the banks are selected by tracking the channel select and Lead Boost button status. | |
| Footswitch | Use only with Model: KAC-FSWAV (supplied with amplifier) | |
| | Use any standard CAT 5 cable wired to the 568A or 568B standard | |
| Power Requirements | USA/Canada | 120VAC/60Hz, 350W nominal |
| | Europe | 230VAC/50Hz, 350W nominal |
| | UK | 230VAC/50Hz, 350W nominal |
| | Australia | 240VAC/50Hz, 350W nominal |
| | Japan | 100VAC/50-60Hz, 300W nominal |
| Dimensions | mm/kg | 250 (Height) x 700 (Width) x 280 (Depth), 16.2kg |
| | Inches/Pounds | 9.75 (Height) x 27.5 (Width) x 11 (Depth), 35.6 lbs |

Speaker output loading Chart

This stereo amplifier is designed to operate external speaker systems down to 4 ohms per channel. Use the chart below to determine the total load of different cabinets connected to the two jacks on each channel. Loads shaded gray are not recommended. If two cabinets are daisy chained together and plugged into one speaker jack, you will have twice the load and half the impedance (Ohms) as one cabinet. For example: If two 8 ohm cabinets are daisy chained together, then you have the equivalent load of one 4 ohm cabinet.

| Load (Ohms) on each speaker jack | | Speaker Load, Top Jack | | | | |
|----------------------------------|------|------------------------|------|------|------|------|
| | | None | 16 | 8 | 4 | 2 |
| Speaker Load, Bottom Jack | None | No Load | 16 | 8 | 4 | 2 |
| | 16 | 16 | 8.00 | 5.33 | 3.20 | 1.78 |
| | 8 | 8 | 5.33 | 4.00 | 2.67 | 1.60 |
| | 4 | 4 | 3.20 | 2.67 | 2.00 | 1.33 |
| 2 | 2 | 1.78 | 1.60 | 1.33 | 1.00 | |

Total load on channel

Example (left channel shown):

The left channel has a 16 ohm load plugged into the top jack and an 8 ohm load plugged into the bottom jack. The bottom jack load is 8 ohms because the two bottom 16 ohm cabinets are daisy chained together which doubled the load. When a load is doubled, the impedance (ohms) drops proportionally (divides in half).

Looking at the chart, you can see the total load on the two left channel jacks = 5.33 ohms. This value is not in the shaded gray area making it OK to use.

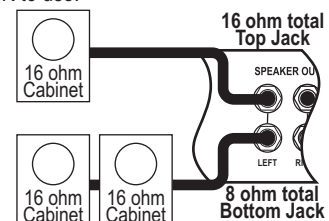

From chart, total load on left channel = 5.33 Ohm

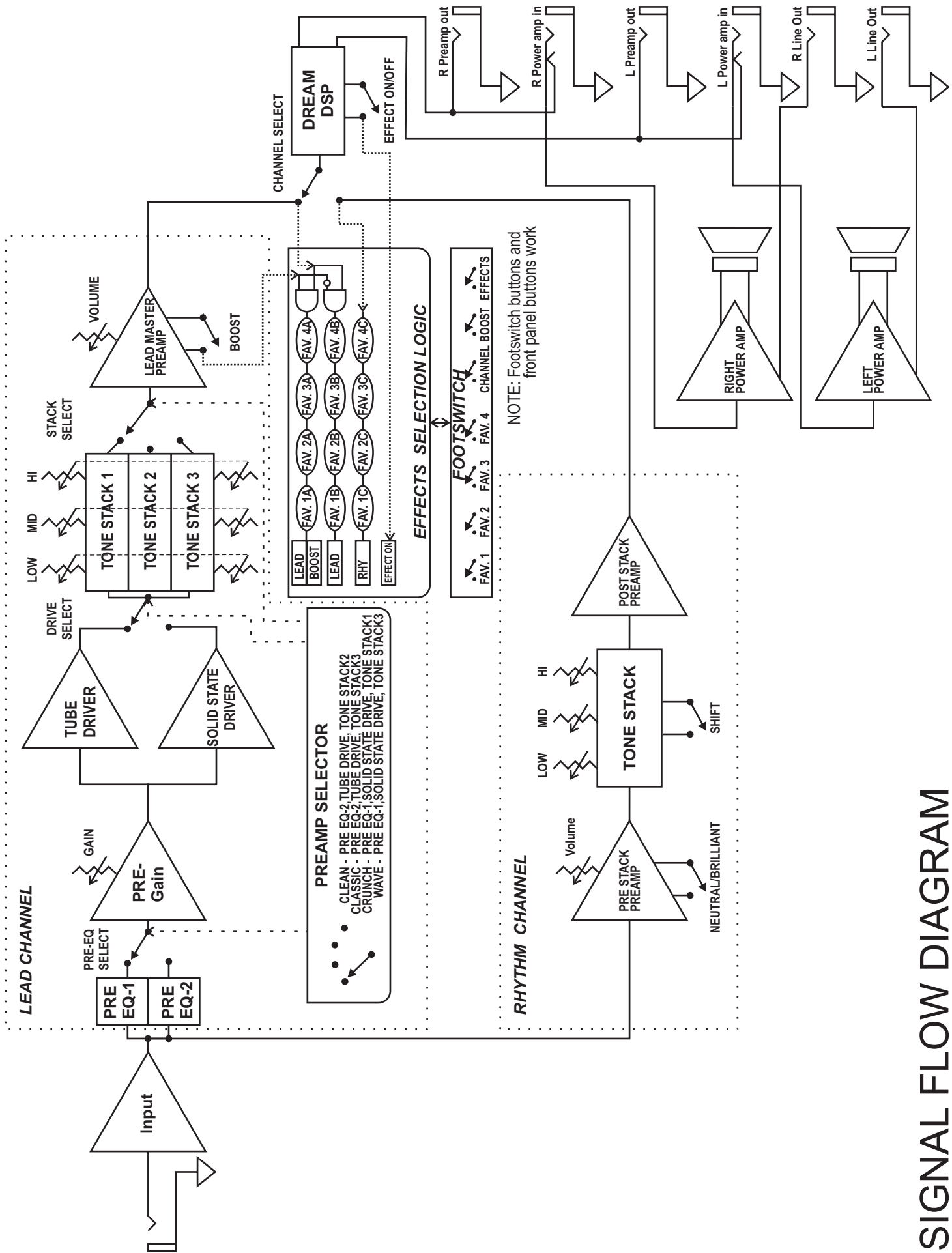

SIGNAL FLOW DIAGRAM

EC Declaration of Conformity

We: Kustom Musical Amplification Inc.
4940 Delhi Pike
Cincinnati, OH 45238
Tel: 1-513-451-5000 Fax: 1-513-347-2192

Declare that the product

Product name: Kustom

Product model number: wAv 1000

to which this declaration relates is in conformity with the following standards;

| | |
|----------------------|---|
| EN55013 (A12) : 1995 | Limits and methods of measurement of radio disturbance characteristics of broadcast receivers and associated equipment. |
| EN55020: 1995 | Electromagnetic immunity of broadcast receivers and associated equipment. |
| EN61000-3-2: 1995 | Limits for harmonic current emissions (equipment input current \leq 16A per phase). |
| EN61000-3-3: 1995 | Limitation of voltage fluctuations and flicker in low voltage supply systems for equipment with rated currents \leq 16A. |
| EN55103-1: 1995 | Electromagnetic Compatibility - Product family standard for Audio, Video Audio-visual and entertainment Lighting Control Apparatus. |
| EN60065: 1994 | Safety requirements for main operated electronic and related apparatus for household and similar general use. |

Following the provisions of EU Council Directive(s): 72/73 EEC and 89/336/EEC.

We the undersigned, hereby declare that the equipment specified above conforms to the aforementioned directive(s).

Name of authorized person: Rick Kukulies, VP Engineering

Signature: 

Date: 05 June 2001

Kustom Musical Amplification Inc. (BC Rich)
4940 Delhi Pike
Cincinnati, OH 45238
Tel: 1-513-451-5000 Fax: 1-513-347-2192

KUSTOM

Kustom Amplification Inc., 4940 Delhi Pike, Cincinnati, OH • USA
(800) 999-5558 Web: www.kustom.com

Free Manuals Download Website

<http://myh66.com>

<http://usermanuals.us>

<http://www.somanuals.com>

<http://www.4manuals.cc>

<http://www.manual-lib.com>

<http://www.404manual.com>

<http://www.luxmanual.com>

<http://aubethermostatmanual.com>

Golf course search by state

<http://golfingnear.com>

Email search by domain

<http://emailbydomain.com>

Auto manuals search

<http://auto.somanuals.com>

TV manuals search

<http://tv.somanuals.com>