

USER'S MANUAL

Lanzar MAX PRO



AMPLIFIERS:

MAXP 1200 / 1055D / 1201D / 1601D / 2051D / 2055D / 2651D

TABLE OF CONTENTS

Contents and introduction	Page 1
Amplifier featurer descriptions	Page 2
Monoblock amplifier applications (MAXP 1200)	Page 3
Monoblock class D amplifier applications (MAXP1055D/MAXP1201D/MAXP1601D/MAXP2051D/MAXP2055D/MAXP2651D)	Page 4
Setting up systems after installation for best performance	Page 5
Max pro series amplifier specifications	Page 6
Troubleshooting	Page 7

INTRODUCTION

Thank you for purchasing the Lanza MAXP PRO series amplifier. Rest assured you have purchased a quality product designed and engineered to give you many years of uncompromised musical service. The MAXP PRO series amplifier has been designed using the latest in electronic technology available today

This mono subwoofer amplifier is the result of advanced high speed switching technology that overcomes the less-efficient classAB design. The MAXP PRO series amplifier reflects your true appreciation for powerful bass reproduction in the mobile environment.

This amplifier is designed for low-frequency information only and it is not capable of reproducing any mid/high-frequency information.

This is due to the noise introduced into the signal by the switching speed of the power supply, which must be filtered out of the audio signal.

The power supply incorporated into MAXP PRO series amplifier is a DC to DC switching power supply designed to have adequate headroom for even the most demanding peak and dynamic range found on today's Cds and recording.

AMPLIFIER FEATURE DESCRIPTIONS

MAXP1200

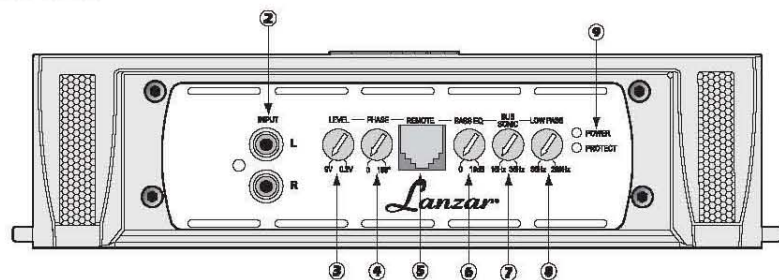

- 1. Line Out RCA Jacks** - The LINE OUT allows you to build multiple amplifier systems without having to use splitter cords to distribute the signal. Now it is simple a matter of bringing one set of RCAs into the first amplifier, then using the line out RCA jacks as the feed to the next amplifier.
- 2. Line Input RCA Jacks** - These inputs are for signal cables from the source. Always use high quality shielded RCA cables.
- 3. Input Level Controls** - Enables the matching of input levels to the output levels from the head unit[or other signal source].
- 4. Phase Shift** - Allows you to change the phase of your subwoofer from 0 to 180 degrees to help compensate for timing differences between drivers.

MAXP1055D/MAXP1201D/MAXP1601D MAXP2051D/MAXP2651D/MAXP2055D

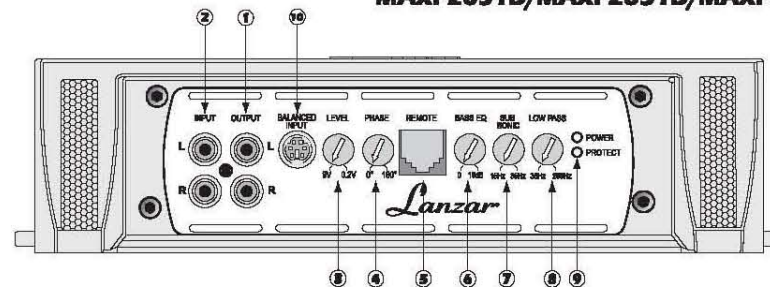

- 5. Bridge Mode**
- 6. Variable Bass Boost Control** - 0 ~ +10dB
- 7. Variable Subsonic Filter** - 15Hz~35Hz
- 8. Low Pass Filter** - When Crossover Mode Selector is in Low Pass Mode, this control limits the frequencies which will be distributed to the speakers to those below the value to which this is set within the range 35Hz~250Hz.
- 9. Power & Protection Indicators**- Provide instant information on status of amplifier, including short-circuit and thermal overload alerts.
- 10. Balanced input:** Accepts line level balanced input from 0.4v to 18v.

Amplifier Feature Descriptions:

BALANCED INPUT: Accepts balanced line inputs from 0.4 volts to 18 volts.

LINE INPUT: The Line Inputs are the RCA input jacks labeled "LINE INPUT". This is where the Radio/CD player RCA outputs connect to. The Line Inputs accept unbalanced RCA inputs from 0.2 volts to 9 volts.

LINE OUTPUT: The Line Outputs are a direct pass-through from the inputs. The RCA input signal from the radio/CD player is routed through the amplifier and out of the Line Outputs. The outputs would connect to another amp Line Inputs in a multi-amp set-up. This allows you to daisy chain multiple amps from a single set of RCA cables from the radio/CD player.

LEVEL: The input level control allows you to match the amplifier input sensitivity to the output level of the RADIO/CD player from 0.2 Volts to 9 volts when using unbalanced RCA cables. The Level control needs to be adjusted to match the Line Level Sensitivity (this is the amount of voltage the radio/CD player RCA's provide. Example: If the radio/CD player Line Level Sensitivity is 4 volts, adjust the amp level control to 4 volts

SUBSONIC: The variable Subsonic filter is for subwoofer applications that require very low tuning frequencies typically around 15Hz - 35Hz.

BASS EQ: Variable Bass Boost from 0 to 10dB at a fixed 45Hz.

LOW PASS: Fully adjustable crossover from 35 to 250Hz.

PHASE SHIFT: The Phase Shift is fully adjustable from 0 to 180 degrees and this allows you to control the timing of the subwoofers. This is commonly used when the subwoofers are installed in each front door.

SYSTEM DIAGNOSTICS: The amplifier has built-in monitoring devices and protection circuits that monitor all vital functions of the amplifier. The Protection light does not come on to indicate there is a failure, it comes on when it detects an improper operation. Common issues that cause.

Protection status are:

- **THERMAL:** The amp has an internal temperature sensor that will automatically shut off the amp if it reaches dangerous temperature levels.
 - **OVER LOAD:** If the amp is run at an improper impedance, the amp will shut down. If you are "CLIPPING" speakers / subwoofer(s), the light will blink to indicate a hard clip.
 - **DC PROTECT:** In the unlikely event the amp should internally fail, the amp will shut down to prevent a DC voltage output to the speakers or sub.
- REMOTE:** The Remote Module plugs into the Remote jack and allows you to adjust the level.

MAXP1200 MONO BLOCK AMPLIFIER APPLICATIONS

Basic application

Interconnect cable checklist:

- Connect the line inputs to a Radio/CD RCA outputs or line output of the full range primary amplifier with good quality RCA cables. A "Y" adapter may be needed as shown in the diagram.

- Use at least 16 gauge speaker wiring. These amplifiers have dual speaker terminals, simplifying the hookup of multiple speakers

Crossover frequency control checklist:

- LOWPASS: 35Hz to 250Hz
- SUBSONIC: 15Hz to 35Hz
- BASS EQ: 0 to 10dB
- PHASE: 0 to 180 degrees

Level control checklist:

- Refer to the section "Setting up systems after installation for best performance"

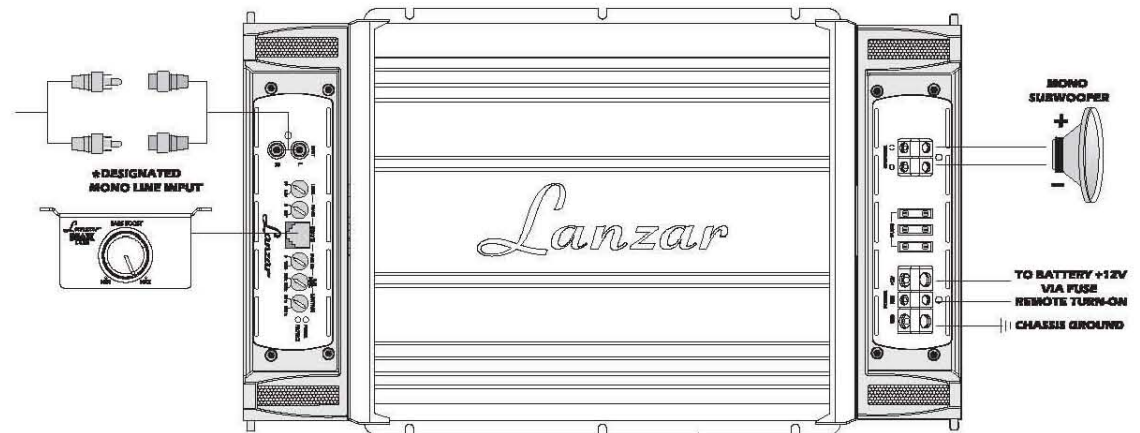

Minimum final loudspeaker impedance:

- 1 ohm.

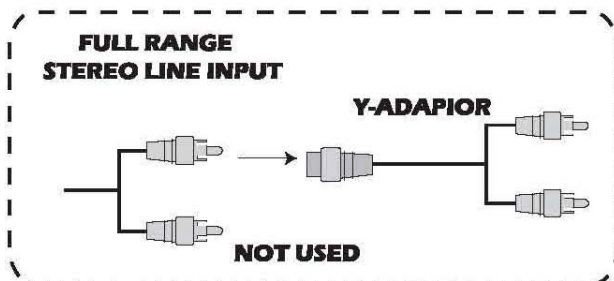

***Note: You can use the Radio/CD designated mono line output or a full range stereo line output. For full range stereo line output, you will need an optional "Y-Adaptor" as shown**

Dual Subwoofer Application

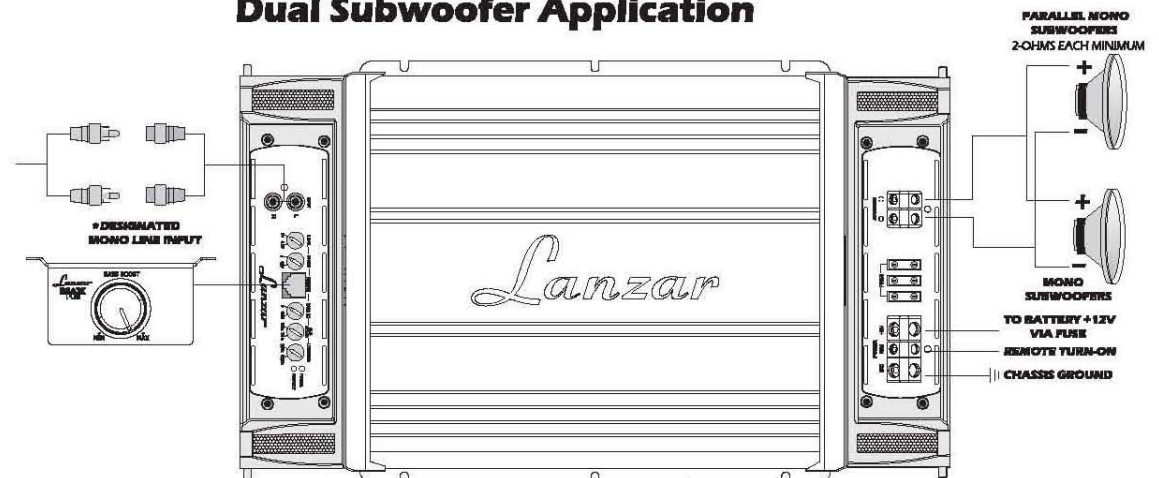

MAXP1055D/MAXP1201D/MAXP1601D/MAXP2051D/MAXP2651D MAXP2055D MONO BLOCK CLASS D AMPLIFIER APPLICATIONS

Basic application

Interconnect cable checklist:

- Connect the line inputs to a Radio/CD RCA outputs or line output of the full range primary amplifier with good quality RCA cables. A "Y" adapter may be needed as shown in the diagram.

- Use at least 16 gauge speaker wiring. These amplifiers have dual speaker terminals, simplifying the hookup of multiple speakers

Crossover frequency control checklist:

- LOWPASS: 35Hz to 250Hz
- SUBSONIC: 15Hz to 35Hz
- BASS EQ: 0 to 10dB
- PHASE: 0 to 180 degrees

Level control checklist:

- Refer to the section "Setting up systems after installation for best performance"

Minimum final loudspeaker impedance:

-1 ohm.

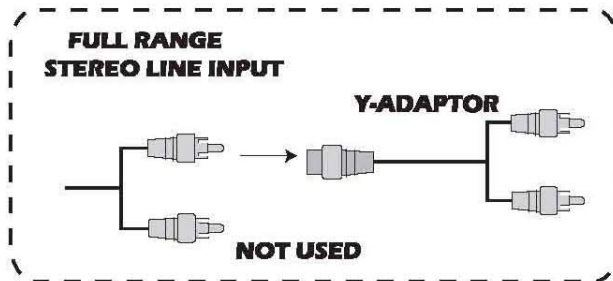

***Note: You can use the Radio/CD designated mono line output or a full range stereo line output. For full range stereo line output, you will need an optional "Y-Adaptor" as shown**

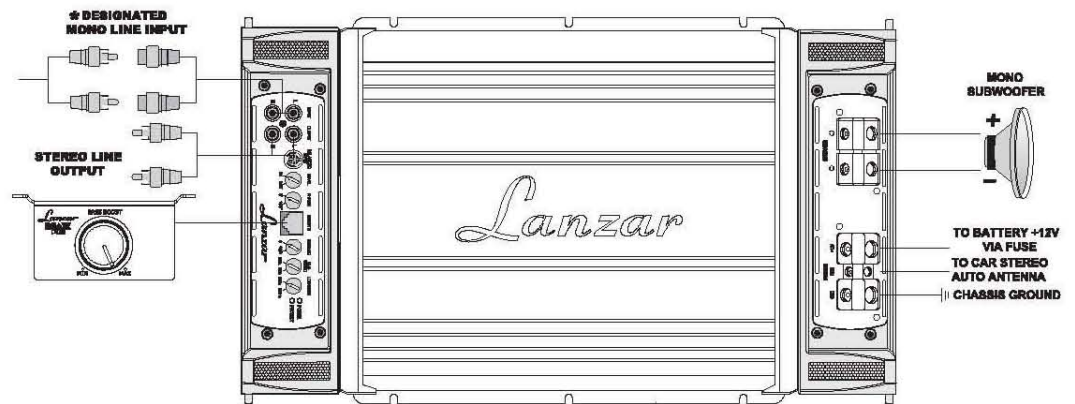

Dual Subwoofer Application

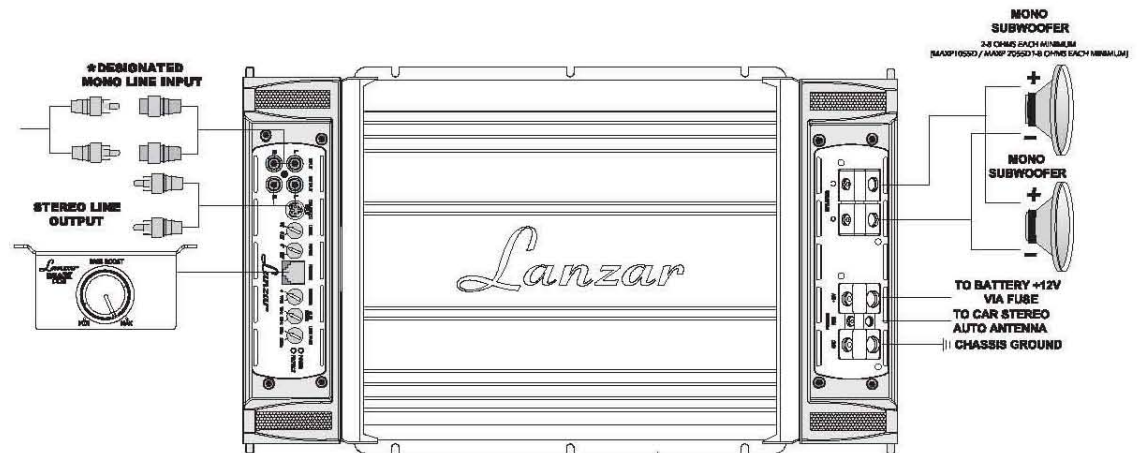

SETTING UP SYSTEMS AFTER INSTALLATION FOR BEST PERFORMANCE

General:

At this point you are ready to get more specific on the settings for your amplifier.

Subsonic:

This setting acts as a low frequency cut off for your system bass reproduction. The point that you set it at cuts off any frequencies from reproduction beyond this point. The 12 o'clock position is a great starting point. **EXAMPLE:** If you adjust the Subsonic to 25Hz, the amplifier will not play frequencies below 25Hz but will play frequencies from 25Hz to the chosen Low Pass frequency.

Bass EQ:

This setting is a fixed bass boost at 45Hz that is variable from 0-10dB. This feature provides impact to your bass, but if not adjusted correctly, it can be over used and cause damage to your subwoofers and amplifiers. It is best to slowly turn this setting clockwise until the desired punch is felt. It is not recommended to exceed the 12 o'clock position unless listening at a low volume or a low recording quality as this can result in high distortion and possibly clipping.

Low Pass:

The Low pass control acts as a ceiling and doesn't allow frequencies to the right of the desired setting to be reproduced. The 12 o'clock position is a great starting point. **EXAMPLE:** If you adjust the Low Pass to 80Hz, the amplifier will not play frequencies above 80Hz but will play frequencies from 80Hz to the chosen Subsonic frequency.

Phase:

The variable Phase adjustment allows you to change the relative time that the waveform meets your ear. With standard subwoofer installations where the subwoofer is behind you, the Phase should generally be at 0. When subwoofers or woofers are in the kick panels or door panels, the Phase adjustment is useful in delaying the timing of the wave meeting your ear by adjusting the potentiometer to 180 degrees.

Level (GAIN) Control Setup:

Ensure that the Level is turned completely to the left prior to turning the system on. Next you should insert a CD or cassette that you are familiar with to use as a reference, and turn the head unit volume control to about 80% of its full setting. The system sound level will of course be very low, and the following procedures will help you to match the amplifier input sensitivities properly to the head unit output signal level. It is important to match the amplifier **LEVEL** input sensitivity to the Radio/CD output sensitivity. This can be located in the Radio/CD manual. If the Radio/CD output sensitivity is 2 volts, then adjust the amplifier **LEVEL** input to 2 volts.

If you are not sure what the Radio output sensitivity is, follow these general guide lines:

Turn the level control up slowly, till you hear distortion, then back off a few degrees on the control. If at any point your amplifier goes into protection, you will need to turn the Level to the left a bit and then try again. If you reach a point where the output does not increase, stop turning the Level control to the right as the amplifier/subwoofer combo has reached its max output in this application.

Lanzar MAX PRO SERIES AMPLIFIER FEATURES

output Power Rating	MAXP1200	MAXP1055D	MAXP1201D	MAXP1601D	MAXP2051D	MAXP2055D	MAXP2651D
4-Ohm load	450x1	1x250W	1x500W	1x750W	1x1000W	1x625W	1x1250W
2-Ohm load	900x1	1x500W	1x1000W	1x1500W	1x2000W	1x1250W	1x2500W
1-Ohm load	1800x1	1x1000W	1x2000W	1x3000W	1x4000W	1x2500W	1x5000W
0.5-Ohm load	NA	1x2000W	NA	NA	NA	1x5000W	NA
Electrical Specifications							
Slow Un-Mute Turn-On (soft start)	YES	YES	YES	YES	YES	YES	YES
Dampening Factor	>200	>300	>300	>300	>300	>300	>300
Signal To Noise Ratio (A-weighted)	>95dB	>95dB	>95dB	>95dB	>95dB	>95dB	>95dB
THD & Noise	<0.05%	<0.50%	<0.50%	<0.50%	<0.50%	<0.50%	<0.50%
Variable Input level Control (unbalanced)	0.2V - 9V	0.2V - 9V	0.2V - 9V	0.2V - 9V	0.2V - 9V	0.2V - 9V	0.2V - 9V
Input Level Control (balanced)	0.04V - 18V	0.04V - 18V	0.04V - 18V	0.04V - 18V	0.04V - 18V	0.04V - 18V	0.04V - 18V
Input Impedance (un-balanced)	47k-Ohm	47k-Ohm	47k-Ohm	47k-Ohm	47k-Ohm	47k-Ohm	47k-Ohm
Input Impedance (balanced)	20k-Ohm	20k-Ohm	20k-Ohm	20k-Ohm	20k-Ohm	20k-Ohm	20k-Ohm
Power / Diagnostic L.E.D.	Yes	Yes	Yes	Yes	Yes	Yes	Yes
Protection:							
DC, Speaker Short, Thermal, Overload	Yes	Yes	Yes	Yes	Yes	Yes	Yes
Power Supply MOSFET	Yes	Yes	Yes	Yes	Yes	Yes	Yes
Audio Output MOSFET	Yes	Yes	Yes	Yes	Yes	Yes	Yes
Crossover:							
Variable Low Pass Filter / 24dB	35Hz - 250Hz	35Hz - 250Hz	35Hz - 250Hz	35Hz - 250Hz	35Hz - 250Hz	35Hz - 250Hz	35Hz - 250Hz
Variable Subsonic Filter / 24dB	15Hz - 35Hz	15Hz - 35Hz	15Hz - 35Hz	15Hz - 35Hz	15Hz - 35Hz	15Hz - 35Hz	15Hz - 35Hz
Variable Bass EQ	0dB - + 10dB	0dB - + 10dB	0dB - + 10dB	0dB - + 10dB	0dB - + 10dB	0dB - + 10dB	0dB - + 10dB
Phase Shift (0 - +180 degrees)	Yes	Yes	Yes	Yes	Yes	Yes	Yes
Cronnector Type:							
Unbalanced Inputs (RCA)	Yes	Yes	Yes	Yes	Yes	Yes	Yes
Balanced Inputs (DIN)	Yes	Yes	Yes	Yes	Yes	Yes	Yes
Line Output (RCA)	Yes	Yes	Yes	Yes	Yes	Yes	Yes
Speaker Terminals (molded)	12 ga.	12 ga.	12 ga.	12 ga.	0 ga.	0 ga.	0 ga.
Power/Ground Terminals (molded)	4 ga.	4 ga.	4 ga.	4 ga.	0 ga.	0 ga.	0 ga.
Remote	INCLUDED	INCLUDED	INCLUDED	INCLUDED	INCLUDED	INCLUDED	INCLUDED
Fuses:							
	30A x 3	40A x 3	35A x 3	40A x 4	200A (not included)	250A (not included)	250A (not included)
Dimensions (W x H x L) Inches	10.16" x 2.56" x10.91"	10.16" x 2.56" x12.8"	10.16" x 2.56" x12.8"	10.16" x 2.56" x15.63"	10.16" x 2.56" x18"	10.16" x 2.56" x21.73"	10.16" x 2.56" x21.73"

Note: All features subject to change without notice

TROUBLESHOOTING

Before removing your amplifier, refer to the list below and follow the suggested procedures. Always test the speakers and their wires first.

AMPLIFIER WILL NOT POWER UP.

- Check for good ground connection.
- Check that remote DC terminal has at least 13.8v DC.
- Check that there is battery power on the +terminal.
- Check all fuses.
- Check that Protection LED is not lit. If it is lit, shut off amplifier briefly and then repower it.

HIGH HISS OR ENGINE NOISE (ALTERNATOR WHINE) IN SPEAKERS.

Disconnect all RCA inputs to the amplifier(s)-if hiss / noise disappears, then plug in the component driving the amplifier and unplug its inputs. If hiss / noise disappears, go on until the faulty /noisy component is found.

It is best to set the amplifier's input level as insensitive as possible. The best subjective S/N ratio is obtainable this way. Try to drive as high a signal level from the head unit as possible.

PROTECTION LED COMES ON WHEN THE AMPLIFIER IS POWERED UP.

- Check for shorts on speaker leads.
- Check that the volume control on the head unit is turned down low.
- Remove speaker leads, and reset the amplifier. If the Protection LED still comes on, then the amplifier is faulty.

AMPLIFIER(S) GETS VERY HOT.

- Check that the minimum speaker impedance for that model is correct.
- Check for speaker shorts.
- Check that there is good airflow around the amplifier. In some applications, an external cooling fan may be required.

DISTORTED SOUND

- Check that the Level control(s) is set to match the signal level of the head unit.
- Check that all crossover frequencies have been properly set.
- Check for shorts on the speaker leads.

HIGH SQUEAL NOISE FROM SPEAKERS.

- This is always caused by a poorly-grounded RCA patch cord.

WARRANTY LIMITED

Lanzar[®]
MAXPRO

WWW.LANZAR.COM

1600 63RD STREET • BROOKLYN N.Y. 11204 • 718 535 - 1800 • FAX: 718 236-2400

Free Manuals Download Website

<http://myh66.com>

<http://usermanuals.us>

<http://www.somanuals.com>

<http://www.4manuals.cc>

<http://www.manual-lib.com>

<http://www.404manual.com>

<http://www.luxmanual.com>

<http://aubethermostatmanual.com>

Golf course search by state

<http://golfingnear.com>

Email search by domain

<http://emailbydomain.com>

Auto manuals search

<http://auto.somanuals.com>

TV manuals search

<http://tv.somanuals.com>