



Comet 40-150kVA

Uninterruptible Power Supply

Installation and User Manual



Comet

40 - 150kVA

Installation and User Manual

Revision History

Comet 40-150kVA UPS *Installation and User Manual* 86-160310-00

| | | | |
|-----------|-----|-----------------|---------|
| Revision: | A00 | Initial Release | 03/1997 |
| | B00 | ECN#: 289-91 | 01/1998 |
| | C00 | ECN#: 290-30 | 07/1998 |
| | D00 | ECN#: 002456 | 02/2002 |
| | E00 | ECN#: 004466 | 08/2005 |

Copyright © 2005 MGE UPS SYSTEMS, INC.
All rights reserved. Printed in U.S.A.

MGE UPS SYSTEMS, INC.
1660 Scenic Avenue
Costa Mesa, CA 92626
(714) 557-1636

Customer Care Center:
1-800-438-7373 (Hours: 24/7)



IMPORTANT SAFETY INSTRUCTIONS

SAVE THESE INSTRUCTIONS – This manual contains important instructions for the Comet 40-150kVA that must be followed during operation and maintenance of the equipment.



WARNING

Opening enclosures expose hazardous voltages. Always refer service to qualified personnel only.

ATTENTION

L'ouverture des cabinets expose des tensions dangereuses. Assurez-vous toujours que le service ne soit fait que par des personnes qualifiées.

WARNUNG!

Das Öffnen der Gehäuse legen gefährliche Spannungen bloss.
Service sollte immer nur von qualifizierten Personal durchgeführt werden.



WARNING

As standards, specifications, and designs are subject to change, please ask for confirmation of the information given in this publication.

ATTENTION

Comme les normes, spécifications et produits peuvent changer, veuillez demander confirmation des informations contenues dans cette publication.

WARNUNG!

Normen, Spezifizierungen und Pläne unterliegen Änderungen. Bitte verlangen Sie eine Bestätigung über alle Informationen, die in dieser Ausgabe gemacht wurden.



NOTE

This equipment has been tested and found to comply with the limits for a Class A digital device, pursuant to part 15 of the FCC rules. These limits are designed to provide reasonable protection against harmful interference when the equipment is operated in a commercial environment.

This equipment generates, uses, and can radiate radio frequency energy and, if not installed and used in accordance with the instruction manual, may cause harmful interference to radio communications. Operation of this equipment in a residential area is likely to cause harmful interference in which case the user will be required to correct the interference at user's own expense.



WARNING

To reduce the risk of fire or electric shock, install in a controlled indoor environment free of conductive contaminants.

This equipment is intended only for installations in a **RESTRICTED ACCESS LOCATION**.

ATTENTION

Pour réduire le risque d'incendie ou d'électrocution, installer dans une enceinte intérieure contrôlée en température et humidité et sans contaminants conducteurs.

Ce matériel est destiné seulement pour des installations dans un **EMPLACEMENT RESTREINT D'ACCES**.

WARNUNG!

Um die Gefahr von Feuer und elektrischem Schock zu reduzieren, muss das Gerät in einem temperatur- und feuchtigkeitskontrollierten Raum, frei von leitungsfähigen Verunreinigungen, installiert werden. Dieses Gerät ist nur für die Installation an einem Ort mit geingschränkter Zugangserlaubnis vorgesehen.

Diese Ausrüstung ist nur für Anlagen in einem **EINGESCHRÄNKTEN ZUGRIFF STANDORT** bestimmt.

**WARNING**

HIGH LEAKAGE CURRENT. Earth connection essential before connecting supply.

ATTENTION

COURANT DE FUITE ELEVE. Raccordement a la terre indispensable avant le raccordement au reseau.

WARNUNG!

Hoher Ableitstrom Vor Inbetriebnahme Schutzleiterverbindung herstellen.

Certification Standards - Three Phase UPS

- ▶ IEC 1004/ANSI C62.41 Standards for Surge Withstand Ability.
- ▶ FCC Part 15, Subpart J, Class A.
- ▶ UL/cUL 1778, Standard for Uninterruptible Power Supply Equipment.
- ▶ NEMA PE 1 - Uninterruptible Power Systems.
- ▶ NFPA 70 - National Electrical Code.
- ▶ ISO 9001.

Safety of Persons

- ▶ The UPS has its own internal power source (the battery). Consequently, the power outlets may be energized even if the UPS is disconnected from the AC power source.
- ▶ The UPS must be properly grounded.
- ▶ The battery supplied with the UPS contains small amounts of toxic materials. To avoid accidents, the directives listed below must be observed:
 - Never burn the battery (risk of explosion).
 - Do not attempt to open the battery (the electrolyte is dangerous for the eyes and skin).
 - Comply with all applicable regulations for the disposal of the battery.
 - Batteries constitute a danger (electrical shock, burns). The short-circuit current may be very high. Precautions must be taken for all handling: remove watches, rings, bracelets and any other metal objects, use tools with insulated handles.
 - Do not lay tools or metal parts on top of batteries.

Product Safety

- ▶ A protection circuit breaker must be installed upstream and be easily accessible.
- ▶ The UPS can be disconnected from the AC power source by opening the input circuit breaker.
- ▶ UPS must be connected to a nearby power source that is easily accessible.
- ▶ Never block the ventilation grates of the UPS.
- ▶ The UPS must be installed in a controlled environment.

Special Precautions

- ▶ The UPS connection instructions and operation described in the manual must be followed in the indicated order.
- ▶ Check that the indications on the rating plate correspond to your AC powered system and to the actual electrical consumption of all the equipment to be connected to the UPS.
- ▶ Before and after the installation, if the UPS remains de-energized for a long period, the UPS must be energized for a period of 24 hours, at least once every 3 months (for a normal storage temperature less than 25°C). This charges the battery, thus avoiding possible irreversible damage.

(This page left blank intentionally)

| section | description | page |
|------------------|--|---------|
| | Revision History | .i |
| | IMPORTANT SAFETY INSTRUCTIONS | .ii |
| | Certification Standards - Three Phase UPS | .iii |
| | Safety of Persons | .iii |
| | Product Safety | .iii |
| | Special Precautions | .iii |
| | CAUTION: Record All Serial Numbers! | .c iv |
| | Symbol Usage | .c vi |
| | Section Descriptions | .c vi |
| Section 1 | System Description and Specifications | |
| 1.0 | Scope | .1 — 1 |
| 1.1 | General Description | .1 — 1 |
| 1.2 | Major Components | .1 — 3 |
| 1.3 | Specifications | .1 — 8 |
| 1.3.1 | AC Input Ratings | .1 — 9 |
| 1.3.2 | AC Output Ratings | .1 — 9 |
| 1.3.3 | DC Ratings | .1 — 9 |
| 1.3.4 | Mechanical Specifications (UPS Cabinet Only) | .1 — 10 |
| 1.3.5 | Environmental Specifications | .1 — 10 |
| 1.3.6 | DB15 Connector Pinouts and Designations | .1 — 10 |
| 1.4 | Options and Accessories | .1 — 11 |
| 1.4.1 | UPS Options | .1 — 11 |
| 1.4.2 | Software and Communication Package | .1 — 11 |
| Section 2 | Installation | |
| 2.0 | Scope | .2 — 1 |
| 2.1 | Receiving | .2 — 1 |
| 2.2 | Handling | .2 — 1 |
| 2.3 | Storage | .2 — 2 |
| 2.4 | Prerequisite to Installation | .2 — 2 |
| 2.4.1 | Environmental | .2 — 2 |
| 2.4.2 | Mechanical | .2 — 3 |
| 2.4.3 | Electrical | .2 — 3 |
| 2.5 | Installation Procedures | .2 — 4 |
| 2.5.1 | Placement | .2 — 4 |

| section | description | page |
|------------------|---|--------|
| Section 2 | Installation (continued) | |
| 2.6 | Connections | 2 — 4 |
| 2.6.1 | Main AC Input | 2 — 4 |
| 2.6.2 | Bypass AC Input (Optional) | 2 — 4 |
| 2.6.3 | Remote Emergency Power Off (REPO) | 2 — 4 |
| 2.6.4 | AC Output | 2 — 5 |
| 2.6.5 | Battery | 2 — 5 |
| Section 3 | Operation | |
| 3.0 | Scope | 3 — 1 |
| 3.1 | Power Flow | 3 — 1 |
| 3.1.1 | Power Flow, For Normal Operation | 3 — 1 |
| 3.1.2 | Power Flow, For On Battery Operation | 3 — 1 |
| 3.1.3 | Power Flow, For Bypass Operation | 3 — 2 |
| 3.2 | Graphical User Interface, Controls and Indicators | 3 — 2 |
| 3.3 | Startup Procedures | 3 — 5 |
| 3.3.1 | Preliminary Checks | 3 — 5 |
| 3.3.2 | Powering Up the Comet | 3 — 5 |
| 3.4 | Inverter Manual Startup | 3 — 5 |
| 3.5 | Operating Procedures | 3 — 6 |
| 3.5.1 | Normal Operation | 3 — 6 |
| 3.5.2 | Operation on Battery Power | 3 — 6 |
| 3.5.3 | Battery Duration | 3 — 6 |
| 3.5.3.1 | Return to AC Power | 3 — 6 |
| 3.5.4 | Overload | 3 — 7 |
| 3.6 | Emergency Shutdown Using EPO/REPO | 3 — 8 |
| 3.7 | Forced Transfer | 3 — 8 |
| 3.8 | Maintenance Bypass | 3 — 8 |
| 3.8.1 | From Normal Maintenance Bypass Mode | 3 — 8 |
| 3.8.2 | From Maintenance Bypass to Normal Mode | 3 — 9 |
| 3.9 | Shutdown Procedures | 3 — 10 |
| 3.9.1 | Inverter Shutdown | 3 — 10 |
| 3.9.2 | Powering Down | 3 — 10 |
| 3.10 | Alarms | 3 — 10 |
| Section 4 | Maintenance | |
| 4.0 | Scope | 4 — 1 |
| 4.1 | Battery Safety | 4 — 1 |
| 4.2 | Preventive Maintenance | 4 — 1 |
| 4.3 | Replacement Parts | 4 — 2 |

Figures

| | | |
|--------|--|--------|
| figure | description | page |
| 1-1: | Comet 40-80kVA | 1 — 1 |
| 1-2: | Comet 100-150kVA | 1 — 1 |
| 1-3: | Single Line Diagram for the Comet 40-80kVA | 1 — 2 |
| 1-4: | Single Line Diagram for the Comet 100-150kVA | 1 — 2 |
| 1-5: | Front View of the Comet 40-80kVA | 1 — 4 |
| 1-6: | Rear View of the Comet 40-80kVA | 1 — 5 |
| 1-7: | Front View of the Comet 100-150kVA | 1 — 6 |
| 1-8: | Front View of Communications Components for the Comet 100-150kVA | 1 — 7 |
| 1-9: | Pinouts on the DB15 Connector | 1 — 10 |
| 2-1: | The Comet 100-150kVA on Pallet | 2 — 2 |
| 3-1: | Power Flow, For Normal Operation | 3 — 1 |
| 3-2: | Power Flow, For On Battery Operation | 3 — 1 |
| 3-3: | Power Flow, For Bypass Operation | 3 — 2 |
| 3-4: | Comet Front Panel GUI, Controls and Indicators | 3 — 3 |
| 3-5: | Output Current Overload Curve | 3 — 7 |
| 3-6: | Output Power Overload Curve | 3 — 7 |

Tables

| | | |
|-------|---|--------|
| table | description | page |
| 1-1: | Comet 40-150kVA Specifications | 1 — 8 |
| 1-2: | UPS Manager Dry Contact Interface | 1 — 10 |
| 2-1: | Recommended upstream protective device sizing * | 2 — 3 |

MGE Warranty & Proprietary Rights for Three Phase Products

MGE Standard Three Phase Warranty
 Proprietary Rights Statement

Warranty and Product Registration

User Information
 Product Information
 Warranty Extension (Warranty+)

Customer Care Center - Three Phase Products

Technical Support and Product Services
 Who to Contact
 Scheduling Field Service Engineer Support
 Return Policy for Repair of Three Phase Products (RGA)

Glossary

Reorder Form

CAUTION: Record All Serial Numbers!

**RECORD ALL SERIAL NUMBERS FOR THE COMET UPS AND ACCESSORIES.
THESE SERIAL NUMBERS WILL BE REQUIRED IF YOUR SYSTEM NEEDS SERVICE.
KEEP THIS MANUAL IN A PLACE WHERE YOU CAN REFERENCE THE SERIAL
NUMBERS IF SERVICE IS REQUIRED!**

UPS SERIAL NUMBER: _____

BATTERY SERIAL NUMBER: _____

ADDITIONAL MODULES SERIAL NUMBERS:

| | |
|-------|-------|
| _____ | _____ |
| _____ | _____ |
| _____ | _____ |
| _____ | _____ |
| _____ | _____ |
| _____ | _____ |

NOTES:

(This page left blank intentionally)

Symbol Usage

This manual uses five icon symbols with text to convey important information and tips.



WARNING

Information provided to protect the user and service personnel against safety hazards and/or possible equipment damage.



CAUTION

Information provided to protect the user and service personnel against possible equipment damage.



ELECTRICAL

Information provided to protect the user and service personnel against possible electrical hazard and equipment damage.



IMPORTANT

Information provided as an operating instruction, or as an operating tip.



NOTE

Information provided as an operating tip or an equipment feature.

Section Descriptions

1 System Description and Specifications

Provides a general description of the Comet 40-150kVA Uninterruptible Power Systems major components, available options, and system specifications.

2 Installation

Installation of the Comet 40-150kVA UPS, which include receiving, handling, and storage procedures; prerequisites to installation; installation procedures; and startup procedures.

3 Operation

Important information on the Comet 40-150kVA systems' operation procedure sequences; for normal, on battery, and bypass operation, with descriptions of the control and display indicators.



NOTE

For details on the Graphical User Interface (GUI) display, please refer to manual 86-160316-00.

4 Maintenance

Preventive maintenance and battery safety instructions for Comet 40-150kVA UPS, and information about replacement parts, and customer service.

A Glossary provides definitions of abbreviations and terms used in this manual.



NOTE

This manual provides technical information required for operation and maintenance of the Comet 40-150kVA Uninterruptible Power System (UPS). Please read this manual before operating the Comet 40-150kVA equipment. Please retain this manual for future reference.

System Description and Specifications

1.0 Scope

Provides a general description of the Comet 40-150kVA Uninterruptible Power Systems major components, available options, and system specifications.

1.1 General Description

The Comet family consists of compact, high-efficiency Uninterruptible Power Systems which are available in power ratings from 40-150kVA, and are optimized for compatibility with nonlinear computer-type loads. Computer-aided UPS diagnostics and modular construction assure that any required service can be identified and completed rapidly. Remote system monitoring, remote annunciation of UPS performance signals and communication capabilities allow total control of the UPS by its user. See Figures 1-1 and 1-2.

The Comet UPS and its auxiliary equipment are designed for installation in a room where humidity and temperature can be controlled. The recommended and maximum environmental parameters are listed in the Specifications section of this document.

Figure 1-1: Comet 40-80kVA.



Figure 1-2: Comet 100-150kVA.



Figure 1-3, and 1-4 show single-line diagrams of a typical UPS system installation. During normal operation, utility power (Main Input) is supplied to the UPS Rectifier where it is converted to DC voltage. The Inverter converts the DC voltage from the Rectifier to three-phase regulated AC voltage, which supplies the critical load. During power failure conditions, the Inverter is supplied by the stored energy in the batteries, and the load is powered continuously with no disruption.

Figure 1-3: Single Line Diagram for the Comet 40-80kVA.

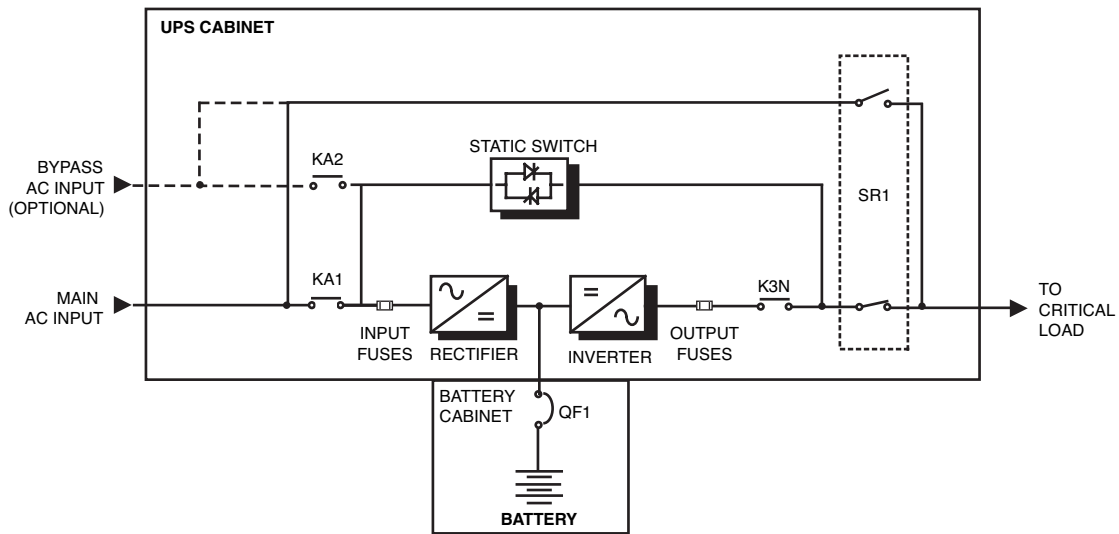
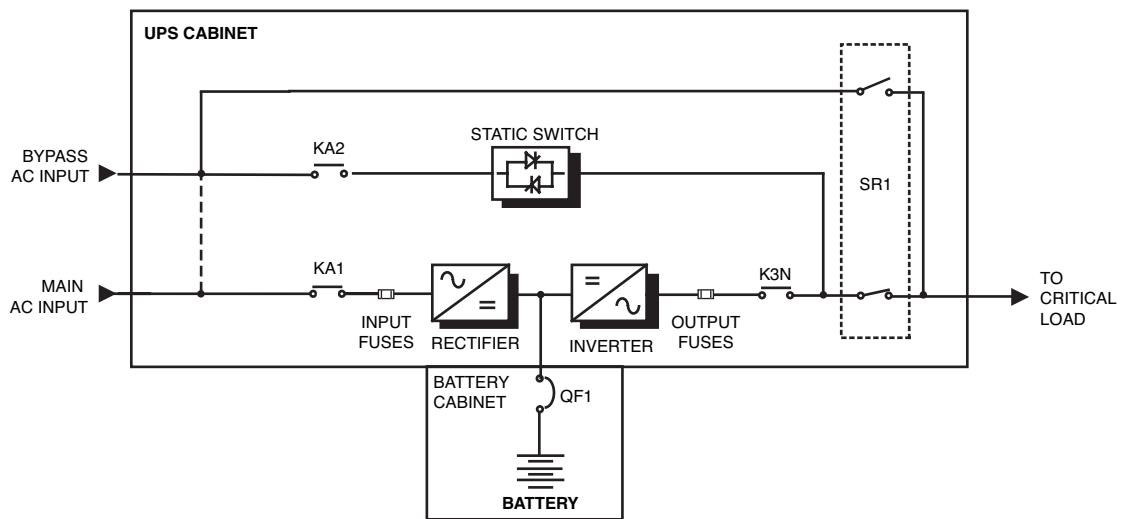

Figure 1-4: Single Line Diagram for the Comet 100-150kVA.



1.2 Major Components

The following is a description of the cabinets and major components. Refer to Figures 1-5 to 1-8.

| | |
|--------------------------|--|
| UPS Cabinet | Converts the input AC power to direct current and charges the battery. DC power is converted back to clean AC power by the inverter for the critical load. Section 3 describes the operation in detail. |
| Auxiliary Cabinet | Performs the voltage conversion for the input AC and/or bypass AC using step-up and/or step-down transformers. |
| Battery Cabinet | <p>The battery cabinet stores energy for use by the Inverter. The stored energy is utilized in the event that the AC input power from the utility source fails, or falls outside of acceptable tolerances. The internal Battery Charger maintains the charge of the battery system. The DC output voltage of the charger is temperature regulated to ensure an optimal charge voltage. If a customer supplied battery system is to be used, an external battery charger may be necessary.</p> <p>The standard battery system is housed in a separate enclosure. For systems where additional back-up time is required, up to two (2) additional battery cabinets are available.</p> <p>A standard battery cabinet is available in an adjacent configuration or a stand-alone configuration. Adjacent battery cabinets are attached to the right side of the UPS using c-brackets provided with the cabinet. Stand-alone battery cabinets are remote from the UPS. Refer to the battery cabinet installation drawing for more details. An external battery system can also be supplied by the customer.</p> |
| Rectifier | Converts the AC input voltage from the utility source into a DC voltage, supplying the Inverter. |
| Inverter | Converts the DC voltage supplied from either the Rectifier or the battery system into a three-phase AC voltage. An AC output filter is used to achieve a computer-grade sinewave output voltage waveform, with a total harmonic distortion of less than 2% under linear-load conditions. |
| Static Switch | Transfers the load between the Inverter output and the bypass AC source without interrupting the supply of power to the load, allowing the load to continue operation in the event of a UPS fault. The Static Switch circuit assures that voltage from the UPS output cannot be fed back to the utility input lines. |
| Battery System | Stores energy for use by the Inverter. The stored energy is utilized in the event that the AC input power from the utility source fails, or falls outside of acceptable tolerances. The internal Battery Charger maintains the charge of the battery system. The DC output voltage of the charger is temperature regulated to ensure an optimal charge voltage. If a customer supplied battery system is to be used, an external battery charger may be necessary. |

Figure 1-5: Front View of the Comet 40-80kVA.

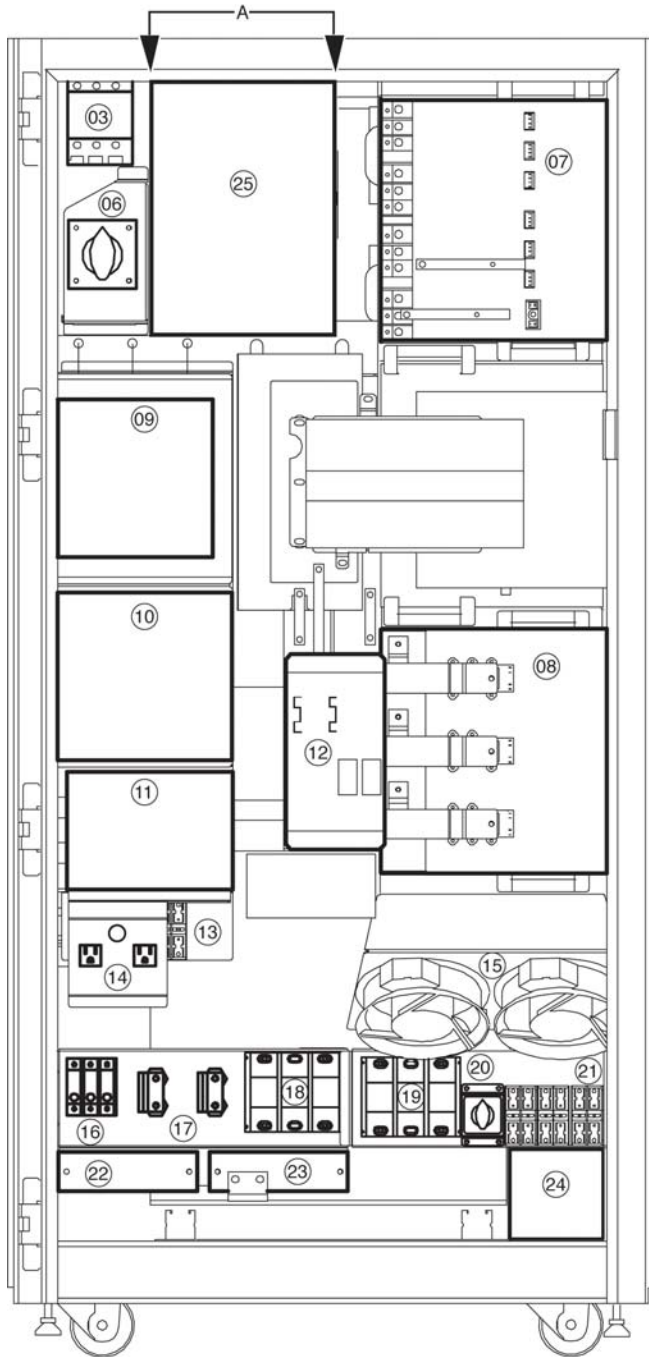

- ① (KA1) Input Contactor
- ② (K3N) Output Contactor
- ③ (KA2) Bypass Input Contactor (Optional)
- ④ (F1, F2, F3) Input Fuses
- ⑤ (F4, F5, F6) Output Fuses
- ⑥ (SR1) Rotary Switch
- ⑦ Rectifier/Static Switch Assembly
- ⑧ Inverter Assembly
- ⑨ Feedback PCA
- ⑩ DC Power Supply PCA
- ⑪ Interconnect PCA
- ⑫ High-Frequency Power Supply PCA
- ⑬ (FU1-FU6) Power Supply Fuses
- ⑭ Teleservice Receptacles (J1-J2) & Fuse (FU13)
- ⑮ Heatsink Cooling Fans
- ⑯ (TB3) Separate Bypass Input Terminal Block
- ⑰ Battery Connections
- ⑱ (TB1) Main Input Terminal Block
- ⑲ (TB2) Output Terminal Block
- ⑳ (SR2) Fan Control Switch
- ㉑ (FU7-FU12) Fan and Teleservice Fuses
- ㉒ Ground Busbar
- ㉓ Neutral Busbar
- ㉔ Bottom of Top-Entry Channel
- ㉕ Battery Charger

DETAIL BEHIND ITEM 25

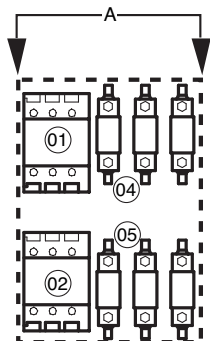

Figure 1-6: Rear View of the Comet 40-80kVA.

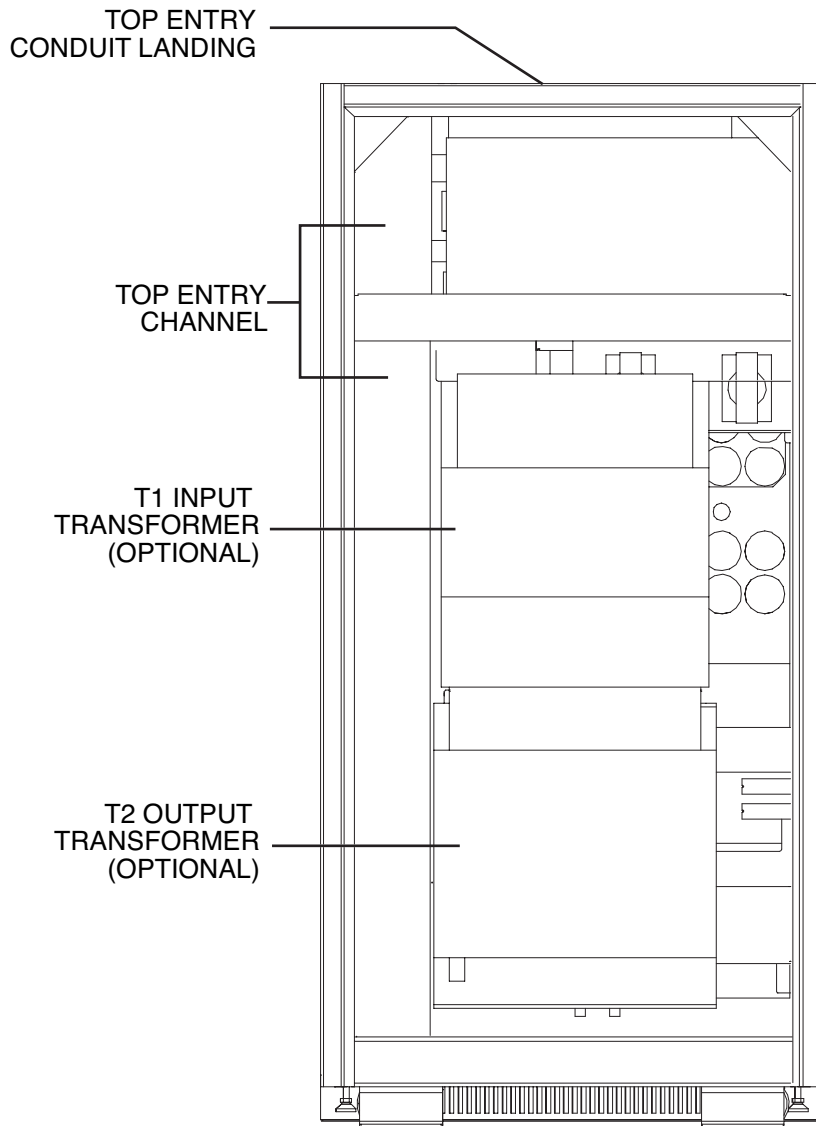
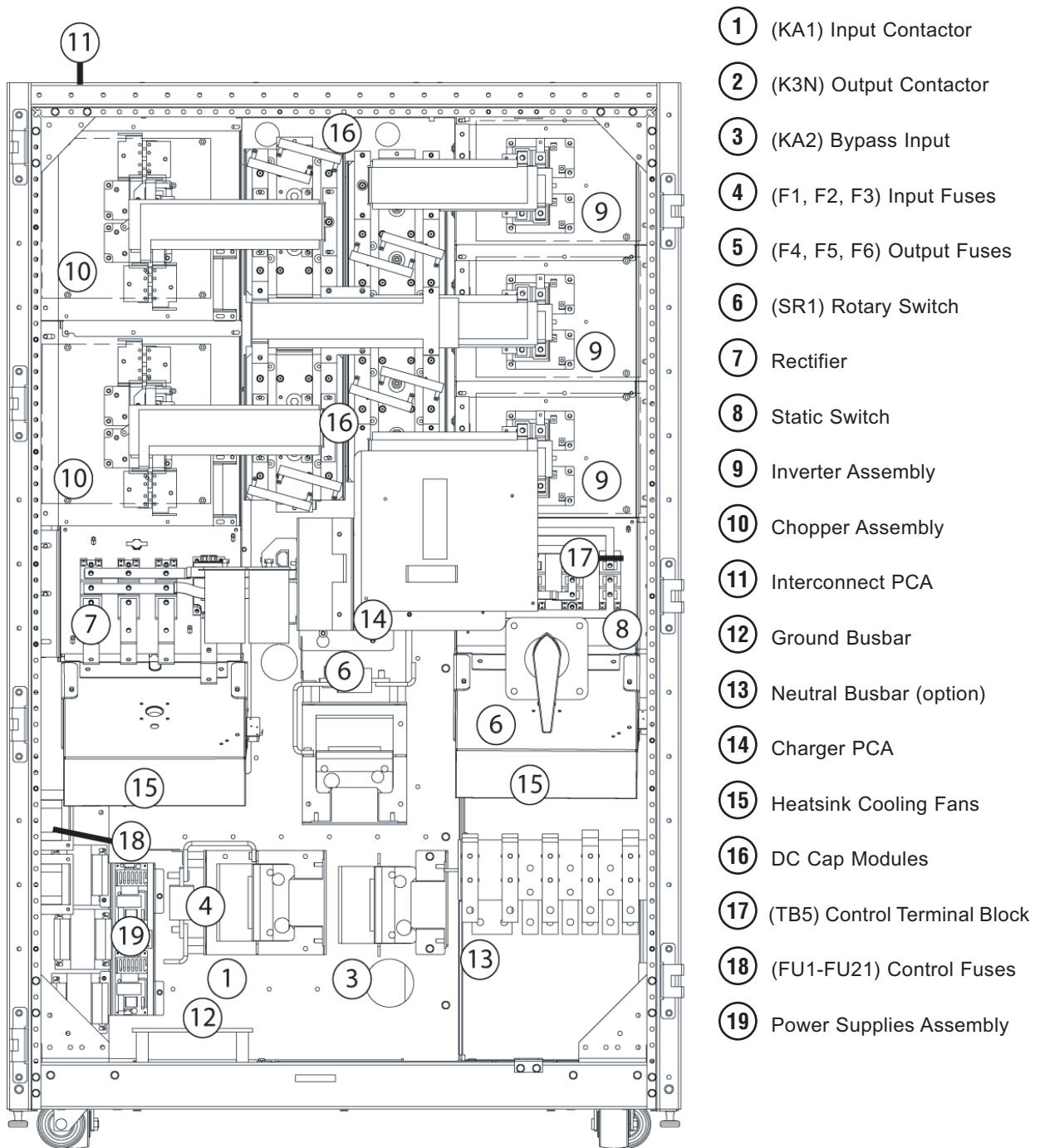
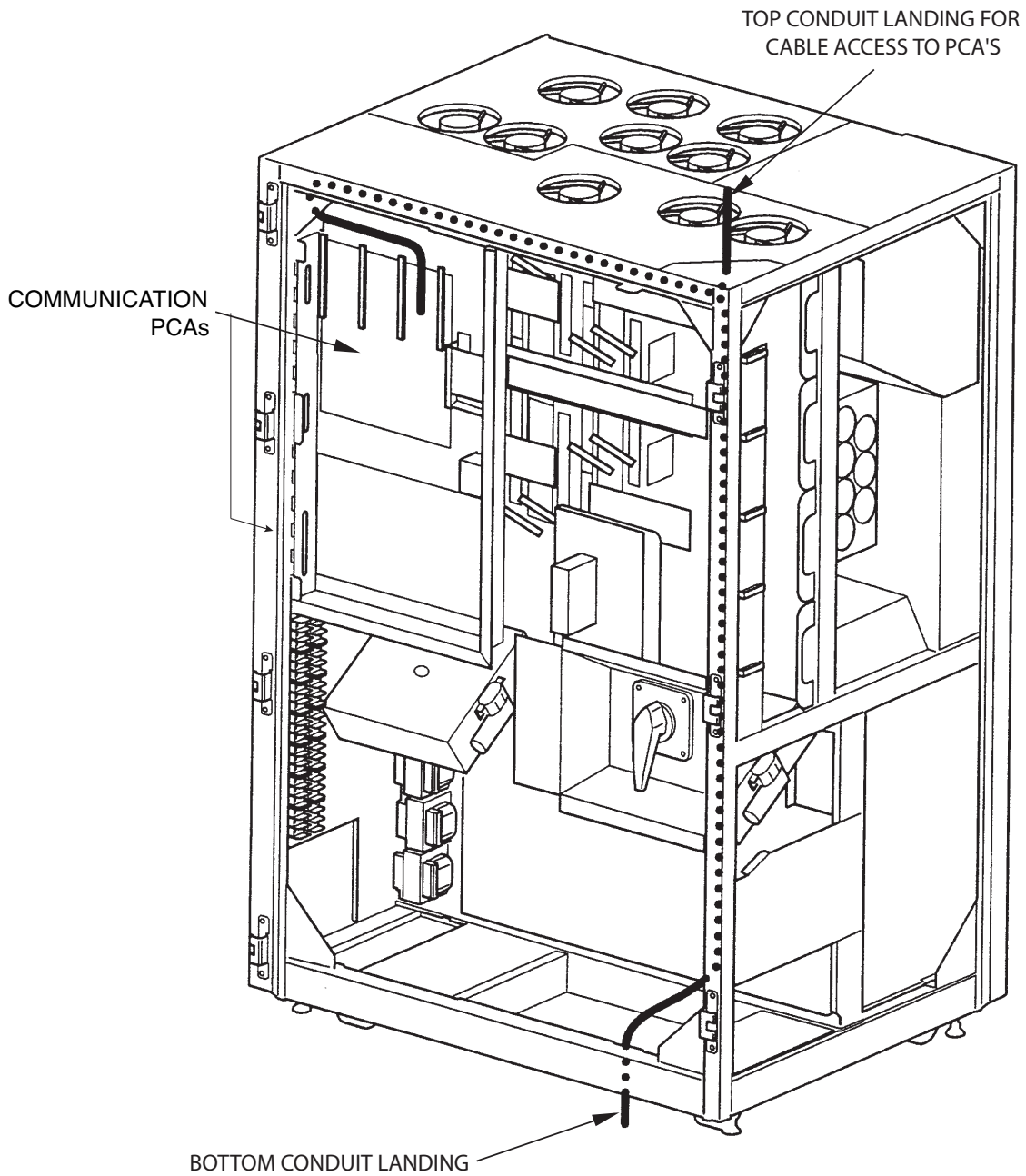

Figure 1-7: Front View of the Comet 100-150kVA.



- ① (KA1) Input Contactor
- ② (K3N) Output Contactor
- ③ (KA2) Bypass Input
- ④ (F1, F2, F3) Input Fuses
- ⑤ (F4, F5, F6) Output Fuses
- ⑥ (SR1) Rotary Switch
- ⑦ Rectifier
- ⑧ Static Switch
- ⑨ Inverter Assembly
- ⑩ Chopper Assembly
- ⑪ Interconnect PCA
- ⑫ Ground Busbar
- ⑬ Neutral Busbar (option)
- ⑭ Charger PCA
- ⑮ Heatsink Cooling Fans
- ⑯ DC Cap Modules
- ⑰ (TB5) Control Terminal Block
- ⑱ (FU1-FU21) Control Fuses
- ⑲ Power Supplies Assembly

Figure 1-8: Front View of Communications Components for the Comet 100-150kVA.



1.3 Specifications

The Comet 40-150kVA UPS systems are rated for various input and output voltages (see Table 1-1). When different input and/or output voltages are specified, optional transformers provide step up/down functions as required.

Table 1-1: Comet 40-150kVA Specifications.

| | INPUT VOLTAGE (VAC) | OUTPUT VOLTAGE (VAC) | OUTPUT CURRENT (Amperes) | INPUT CURRENT (on UPS/ on bypass) (Amperes) | TOTAL WIDTH (in/mm) | NET WEIGHT (lb/kg) | HEAT LOSS (Btu/hr) |
|----------------------|---------------------|----------------------|--------------------------|---|---------------------|--------------------|--------------------|
| 40kVA/32 kW | 208 | 208 | 111 | 102/111 | 32.75/832 | 1760/800 | 13500 |
| | 220 | 220 | 105 | 96/105 | 32.75/832 | 1760/800 | 13500 |
| | 480 | 208 | 111 | 43/111 | 32.75/832 | 1360/617 | 12135 |
| | 480 | 480 | 48 | 43/48 | 32.75/832 | 880/400 | 8220 |
| | 600 | 208 | 111 | 35/111 | 60.00/1524 | 2820/1279 | 13500 |
| 50kVA/40 kW | 208 | 208 | 139 | 127/139 | 32.75/832 | 1760/800 | 16873 |
| | 220 | 220 | 131 | 120/131 | 32.75/832 | 1760/800 | 16873 |
| | 480 | 208 | 139 | 54/139 | 32.75/832 | 1360/617 | 15169 |
| | 480 | 480 | 60 | 54/60 | 32.75/832 | 880/400 | 10276 |
| | 600 | 208 | 139 | 44/139 | 60.00/1524 | 2820/1279 | 16873 |
| 65kVA/52 kW | 208 | 208 | 180 | 162/180 | 32.75/832 | 2115/960 | 17552 |
| | 220 | 220 | 170 | 153/170 | 32.75/832 | 2115/960 | 17552 |
| | 480 | 208 | 180 | 70/180 | 32.75/832 | 1590/721 | 15433 |
| | 480 | 480 | 78 | 70/78 | 32.75/832 | 970/440 | 11328 |
| | 600 | 208 | 180 | 57/180 | 60.00/1524 | 2910/1320 | 17552 |
| 80kVA/64 kW | 208 | 208 | 222 | 200/222 | 32.75/832 | 2115/960 | 21603 |
| | 220 | 220 | 210 | 190/210 | 32.75/832 | 2115/960 | 21603 |
| | 480 | 208 | 222 | 86/222 | 32.75/832 | 1590/721 | 21603 |
| | 480 | 480 | 96 | 86/96 | 32.75/832 | 970/440 | 13992 |
| | 600 | 208 | 222 | 70/222 | 60.00/1524 | 2910/1320 | 21603 |
| 100kVA/80 kW | 208 | 208 | 278 | 256/278 | 69.50/1765 | 3400/1543 | 28300 |
| | 220 | 220 | 263 | 242/263 | 69.50/1765 | 3400/1543 | 28300 |
| | 480 | 208 | 278 | 109/278 | 42.75/1086 | 2450/1112 | 22278 |
| | 480 | 480 | 120 | 109/120 | 42.75/1086 | 1460/662 | 15420 |
| | 600 | 600 | 96 | 89/96 | 96.00/2438 | 3700/1678 | 28300 |
| | 600 | 208 | 278 | 91/278 | 69.50/1765 | 3400/1543 | 28300 |
| 125kVA/100 kW | 208 | 208 | 347 | 316/347 | 69.50/1765 | 3400/1543 | 38247 |
| | 220 | 220 | 328 | 298/328 | 69.50/1765 | 3400/1543 | 38247 |
| | 480 | 208 | 347 | 134/347 | 42.75/1086 | 2450/1112 | 30662 |
| | 480 | 480 | 150 | 134/150 | 42.75/1086 | 1460/662 | 20804 |
| | 600 | 600 | 120 | 109/120 | 96.00/2438 | 3700/1678 | 38247 |
| | 600 | 208 | 347 | 109/347 | 69.50/1765 | 3400/1543 | 38247 |
| 150kVA/120 kW | 208 | 208 | 417 | 378/417 | 69.50/1765 | 3400/1543 | 50759 |
| | 220 | 220 | 394 | 375/394 | 69.50/1765 | 3400/1543 | 50759 |
| | 480 | 208 | 417 | 160/417 | 42.75/1086 | 2450/1112 | 41560 |
| | 480 | 480 | 180 | 160/180 | 42.75/1086 | 1460/662 | 26351 |
| | 600 | 600 | 145 | 131/145 | 69.50/1765 | 3700/1678 | 50759 |
| | 600 | 208 | 417 | 131/417 | 96.00/2438 | 3400/1543 | 50759 |

(See notes that follow)

NOTES:

1. Total width, weight, and heat loss are for system line-up excluding battery cabinets.
2. Data does not include battery data; refer to the installation drawings supplied with your equipment. Consult the installation drawings provided with your equipment.

1.3.1 AC Input Ratings

| | |
|---------------------|---|
| Voltage | 480 VAC, + 12%, -15% |
| Frequency | 60 Hz ± 4% |
| Phases | 3 Ø (phase sequence must be A, B, C, clockwise) |
| Wires | 3 wires plus ground (480-480 VAC only) |
| Power factor | Approximately 0.98 at full load |

Current (on UPS/ on BYPASS) @ 480 VAC

| 40kVA | 50kVA | 65kVA | 80kVA | 100kVA | 125kVA | 150kVA |
|---------|---------|---------|---------|-----------|-----------|-----------|
| 43A/48A | 54A/60A | 70A/78A | 86A/96A | 109A/120A | 134A/150A | 160A/180A |

1.3.2 AC Output Ratings

| | |
|--------------------------------|---|
| Voltage (inverter only) | 480 ± 1% VAC (steady-state conditions) 480 ± 5% VAC (transient conditions from 0% to 100% or 100% to 0%) |
| Frequency | 60 Hz ± 0.1% (free-running) |
| Phases | 3 Ø (phase sequence must be A, B, C, clockwise) |
| Wires | 3 wires plus ground (480-480 VAC only) |
| Power factor | 0.8 |

Current @ 480 VAC

| 40kVA | 50kVA | 65kVA | 80kVA | 100kVA | 125kVA | 150kVA |
|-------|-------|-------|-------|--------|--------|--------|
| 48A | 60A | 78A | 96A | 120A | 150A | 180A |

| | |
|--|--|
| Total harmonic distortion (THD) | <2% (linear load) <3% (for 100% non-linear load with a crest factor of less than 3.0) |
| Dynamic regulation | ± 1% for balanced load ± 2.5% for 100% unbalanced load |
| Dynamic response | ± 5% for 100% step load change |
| Overload | 105% - 110% of rated current for 10 minutes >110% - 130% of rated current for 1 minute >130% - 150% of rated current for 10 seconds >150% of rated current for 0.15 seconds |

1.3.3 DC Ratings

| | | |
|--------------------------------|----------|---------|
| Battery voltage (25° C) | float: | 490 Vdc |
| | nominal: | 432 Vdc |
| | minimum: | 360 Vdc |

Maximum Current at cut-off voltage

| 40kVA | 50kVA | 65kVA | 80kVA | 100kVA | 125kVA | 150kVA |
|--------|---------|---------|---------|---------|---------|---------|
| 96 ADC | 120 ADC | 154 ADC | 189 ADC | 235 ADC | 294 ADC | 353 ADC |

1.3.4 Mechanical Specifications (UPS Cabinet Only)

Height 66.70 in/1694 mm
Width 32.75 in/832 mm
Depth 33.42 in/823 mm

Weight at 480 VAC in and 480 VAC out

| | | |
|----------------|----------------|-----------------|
| 40/50kVA | 65/80kVA | 100-150kVA |
| 880 lbs/400 kg | 970 lbs/440 kg | 1460 lbs/662 kg |

1.3.5 Environmental Specifications

Temperature

Operating: 0° C to 30° C (32° F to 86° F) continuous
 15°C(60°F) to <25° C (<77° F) recommended
 40° C (104° F) up to 8 hrs at 75% load

Non-operating and storage: -30° C to 70° C (-22° F to 158° F)

Humidity 0 to 95% non-condensing

Altitude <3000 ft. (1000m), up to 6000 ft. (<2000 m) @ 28° C (82°F) maximum

1.3.6 DB15 Connector Pinouts and Designations

The UPS Manager connector enables communication with the most common computer systems (AS/400, NOVELL, etc.), or with the optional "UPS Manager UM1" software.

Table 1-2: UPS Manager Dry Contact Interface.

| UPS Manager Dry Contact Interface (DB15) | Softunor (DB9) |
|--|---|
| Operation on Inverter | Diagnostics (for MGE Customer Care Center use only) |
| Operation on Bypass | |
| Operation on Battery | |
| Low Battery Shutdown Warning | |
| UPS Remote Inverter Shutdown | |

Figure 1-9: Pinouts on the DB15 Connector.

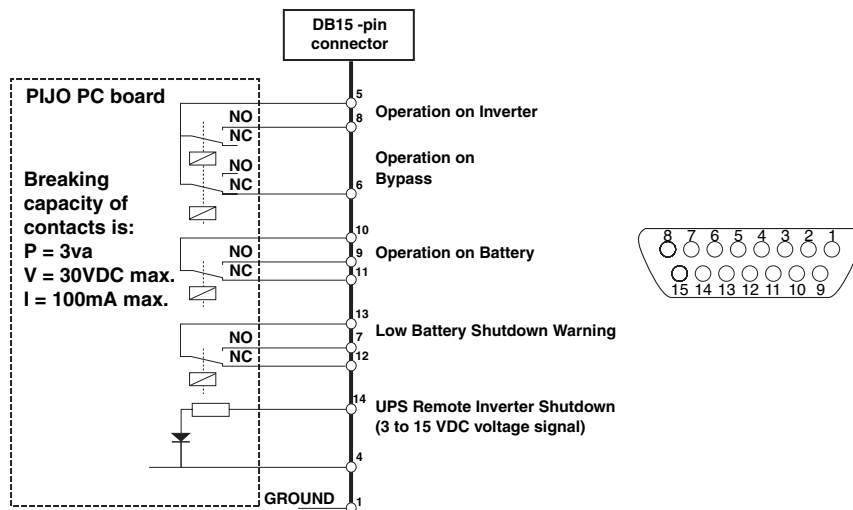

Please note that once the UPS remote inverter shutdown signal is applied, the Inverter stops and the load transfers to bypass after a predetermined time (typically 2 minutes).

1.4 Options and Accessories

Options are available for the Comet 40-150kVA UPS's. Most options must be specified at the time of the original order for factory installation. Some options can be field installed; contact your MGE Sales Representative for further information.

Auxiliary Cabinet The auxiliary cabinet may provide one or both of the following options: an input bypass step up/down transformer, and an output distribution panel. An output distribution panel provides connection points for distribution of AC power to computers and other equipment. Also available are external maintenance bypass cabinets.

Extended Battery Cabinets Up to two Extended Battery Cabinets are available to provide extra back-up time during power outage.

1.4.1 UPS Options

These options are internal to the Comet.

Isolated Redundant System This option is used to connect the static switch and maintenance bypass to a reserve UPS source for redundancy

UPS without Standard Battery Subsystem (External Batteries) This option allows for the connection of a customer-supplied battery system to the UPS.

Communication Options Communication options may be used simultaneously on the Comet, thus enabling communication with a wide number of computers and control devices.

Monitor Plus Mini terminal for control and display of system parameters. This option can be installed locally or remotely.

Contact 5 This option offers communication of five different signals via dry relay contacts:

- ▶ Load on UPS
- ▶ Load on Bypass
- ▶ Operation on Battery
- ▶ Low Battery Shutdown Warning
- ▶ Summary Alarm (major or minor faults)

U-Talk This option manages an RS232 serial interface using an ASCII protocol.

JBUS/RS485 This option enables remote monitoring of the Comet.

1.4.2 Software and Communication Package

Solution-Pac

- ▶ Automatic file shutdown during power outage or severe brownout for stand-alone systems.
- ▶ Automatic file shutdown for network servers plus additional monitoring and network communication functions.
- ▶ Automatic file shutdown with user-friendly control panel and advanced decision-making functions for Windows. This package includes an easy to use load.

(This page left blank intentionally)

2.0 Scope

Installation of the Comet 40-150kVA UPS, which include receiving, handling, and storage procedures; prerequisites to installation; installation procedures; and startup procedures.



CAUTION

Scheduling of the MGE Field Service Engineers typically should be done 7 to 10 days before they are required on-site. If the startup of the product is critical to maintaining your schedule, please call the MGE toll free telephone number at 1-800-438-7373 for assistance.

2.1 Receiving

Before accepting the shipment from the freight carrier, inspect the exterior surfaces of shipping container(s), packaging, and equipment for damage that may have occurred during transit. If the shipping containers or equipment show evidence of damage, note the damage on the receiving document (bill of lading) prior to signing for receipt of equipment. Verify that the equipment nameplate corresponds with the equipment ordered.

Damage claims should be filed directly with the carrier. Replacements for damaged components can be ordered by calling 1-800-438-7373.

2.2 Handling

Any equipment shipped on a shipping pallet is intended for handling by a pallet jack or a fork lift truck. Move the equipment to its intended location while still mounted on its pallet, and remove the equipment from the pallet when it is near its final location. See Figure 2-1.

The Comet UPS and optional auxiliary cabinets have heavy-duty casters to allow the equipment to be moved into position easily once they have been unloaded from the shipping truck. Once the UPS is in its final position, the leveling jacks on all four-bottom corners should be lowered to secure the cabinet in place. Refer to the installation drawings that were shipped with the cabinets.

Battery cabinet weighing less than 3000 lbs. are equipped with casters for ease of handling on site. For shipment, these cabinets are mounted on pallets to prevent movement on ramps and other inclined surfaces. A forklift (4000 lbs capacity or greater) is required to remove the battery cabinet from its pallet. The 42" battery cabinets should be lifted from the side only. For battery cabinets weighing more than 3000 lbs., no casters are provided, and therefore must be moved by forklift only.

If the equipment is to be stored for more than three months before installation, it should be unpacked and connected to an AC input source to allow the batteries to be recharged. Refer to the installation instructions that follow, and the installation drawings.

Figure 2-1: The Comet 100-150kVA on Pallet.

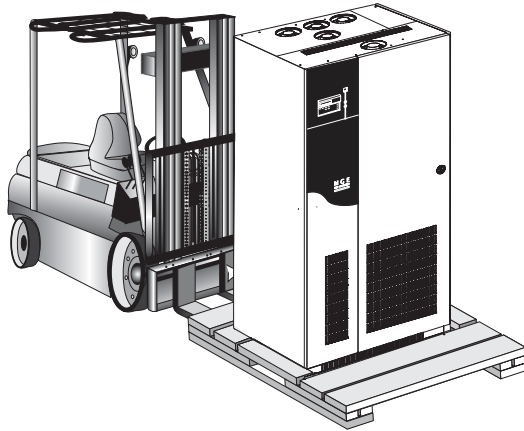

2.3 Storage

If the equipment is to be stored prior to installation, it should be stored in a cool, dry, well-ventilated location that is protected against rain, splashing water, chemical agents, etc. The equipment should be covered with a tarpaulin or plastic wrapper to protect it against dust, dirt, paint, or other foreign materials.



IMPORTANT

Batteries should be stored no longer than three (3) months at approximately 25°C (77° F) prior to recharging. Too high or too low a temperature will damage batteries. Exceeding the recommended ambient storage temperature will reduce back-up time and may adversely affect life.

2.4 Prerequisite to Installation

This section provides more information for a successful and efficient installation of the Comet 40-150kVA. Installation of equipment must be handled by skilled technicians and electrician's familiar with the requirements of high energy electrical equipment. The installation must comply with the requirements of the National Electrical Code (NEC, ANSI/NFPA 70, latest issue) and with local codes and requirements as applicable. We strongly recommend contracting MGE Customer Support Services for startup. Do not allow unqualified personnel to handle or operate the equipment.

2.4.1 Environmental

The Comet 40-150kVA UPS is intended for use in an environment where control of temperature and humidity is provided. The maximum operating and recommended environmental parameters are provided in the Specifications section of this document.

The Comet UPS generates heat and exhausts air through the top portion of its enclosure. Heat loss data is provided in Table 1-1.

Consult the installation drawings provided with your equipment.

2.4.2 Mechanical

The Comet UPS can be mounted on a raised computer room floor, or flush-mounted on a concrete floor. All floors must be level. On a raised floor, conduits can be run below the floor, with cut-outs made in the floor tiles as shown on the installation drawings.

Allow at least three feet of clearance in front of the UPS for normal operation (access to the UPS controls). The Comet requires at least 36 inches top clearance for ventilation.

2.4.3 Electrical

Electrical service for the Comet UPS should be supplied on its own dedicated branch circuit. Main input cables and upstream protective devices must be provided and sized per the National Electrical Code (NEC, ANSI/NFPA 70, latest issue), and as appropriate for your load and distribution requirements. Cable sizing data is provided on the installation drawings supplied with the equipment. The Comet 480/480V UPS is not a separately-derived source. The Comet 208/208V UPS is a separately derived source. The neutral must be grounded on a separately derived source (like the Comet 208/208V UPS).



CAUTION

The customer supplied upstream protective device shall open in one cycle when 10 times the output rated current is applied or in the event of an output short circuit when the unit is working on “Static Switch.”

Refer to the upstream circuit breaker manufacturer’s characteristic curves for proper trip settings.

Table 2-1: Recommended upstream protective device sizing *

| INPUT VOLTAGE | 40kVA | 50kVA | 65kVA | 80kVA | 100kVA | 125kVA | 150kVA |
|----------------------|--------------|--------------|--------------|--------------|---------------|---------------|---------------|
| 208 | 150A | 175A | 225A | 300A | 350A | 450A | 500A |
| 220 | 150A | 175A | 225A | 300A | 350A | 450A | 500A |
| 480 | 70A | 80A | 100A | 125A | 150A | 200A | 225A |
| 600 | 60A | 70A | 80A | 100A | 125A | 150A | 200A |

* Size determined using nominal input currents.

2.5 Installation Procedures

The steps to be followed are:

- ▶ Placement of the UPS and associated equipment.
- ▶ Connection of input power, output power, and control cables.

Installation of UPS equipment must be handled by skilled technicians and electrician's familiar with the special requirements of high-energy electrical equipment. We strongly recommend contracting MGE Customer Support Services for start-up of the installed Comet UPS system. Do not allow unqualified personnel to handle or operate the Comet UPS.

Refer to the installation drawings for proper placement and connections of auxiliary cabinets.

2.5.1 Placement

Move the Comet UPS, battery cabinets (if any), and auxiliary cabinets (if any), to their final location (see Figure 2-2). For cabinets installed adjacent to each other, alignment is critical to properly install the mechanical and cable interconnections. Allow at least 36 inches clearance above all cabinets for maintenance and cooling.

Figure 2-2: Placement of UPS and other Cabinets.

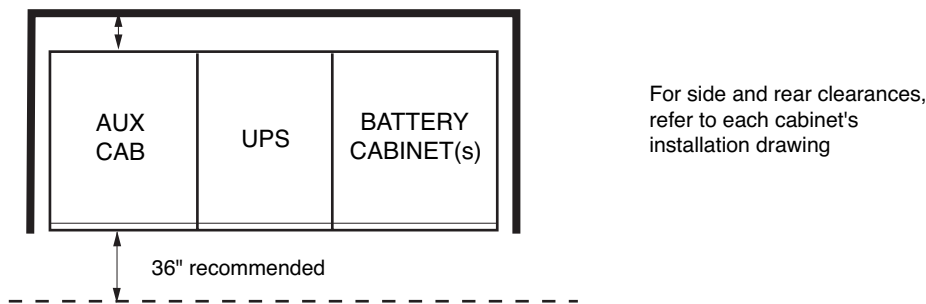

2.6 Connections

Electrical connections and cabinet interconnection will vary depending upon the configuration of your Comet UPS system. Refer to Figures 2-3 & 2-4 and to the installation drawings supplied with your equipment.



CAUTION

Before making any electrical connections, verify that all battery disconnect circuit breaker (QF1) are in the "off" position. Customer-supplied upstream protective devices and distribution circuits should be OFF.

2.6.1 Main AC Input

The connections to be made are the three phases, and ground cables from the utility AC power source to the UPS. The main AC input cables are terminated at the "Main Input" Terminal Block (TB1) for 40-80kVA and the input busbars for 100-150kVA. Complete wiring instructions for your installation are provided on the installation drawings supplied with the equipment.

2.6.2 Bypass AC Input (Optional)

The connections to be made are the three phases, and ground cables from the bypass AC input power source to the UPS. The bypass AC input cables are terminated at the "Bypass Input" Terminal Block (TB3) for 40-80kVA and the bypass busbars for 100-150kVA. This option provides a separate AC input source for bypass operation.

2.6.3 Remote Emergency Power Off (REPO)

The control connections are available for "Remote Emergency Power Off" (REPO) through a customer-supplied normally closed pushbutton. With REPO connected, the jumper on the "REPO" terminal blocks must be removed.

2.6.4 AC Output

The connections to be made are the three phases, and ground cables from the load source to the UPS. The output cables are terminated at the Output Terminal Block (TB2) for 40-80kVA, and the output busbars for 100-150kVA.

Load cables must be run separately from all other cables (power supply or computer-system interconnection cables). They should not pass near interference-emitting equipment or sensitive loads.

2.6.5 Battery

The connections to be made are the positive, negative, and ground cables from the battery cabinet to the UPS. These are terminated at the appropriate connections in the UPS cabinet (see Figures 2-3 and 2-4). Additionally, control wires and temperature sensors in the battery cabinet must be terminated. Refer to the battery cabinet installation drawings for more details.

Figure 2-3: Connections for Comet 40-80kVA UPS.

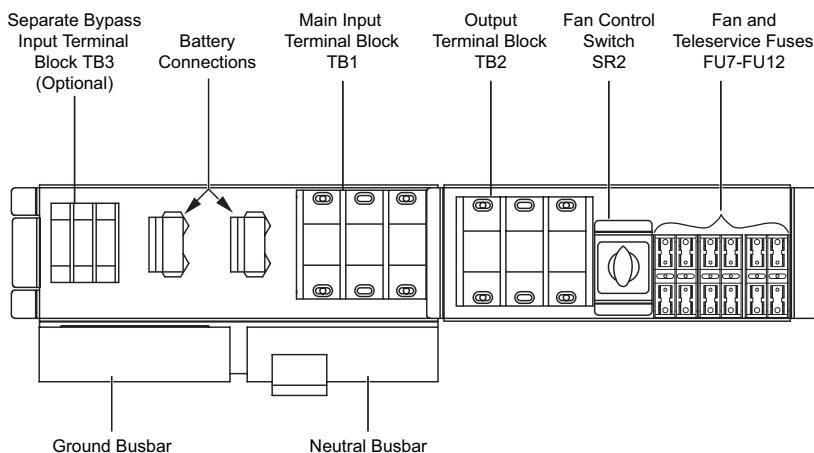
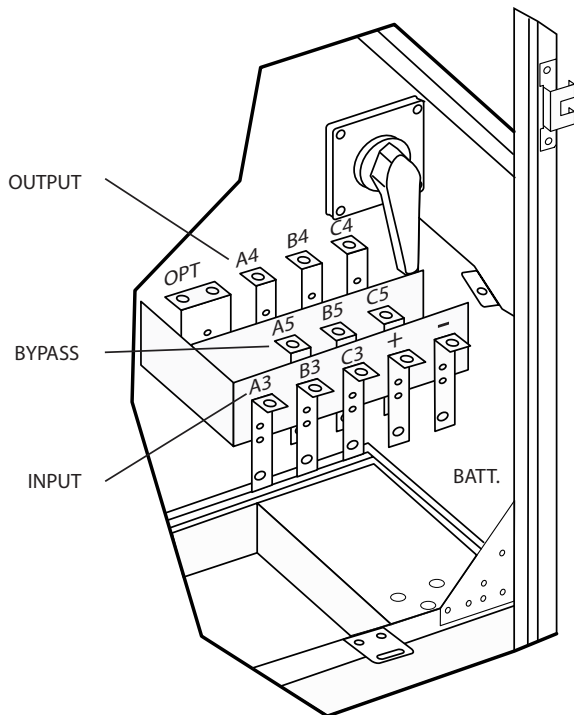

Figure 2-4: Connections for Comet 100-150kVA UPS.



(This page left blank intentionally)

3.0 Scope

Important information on the Comet 40-150kVA systems' operation procedure sequences; for normal, on battery, and bypass operation, with descriptions of the control and display indicators.

3.1 Power Flow

3.1.1 Power Flow, For Normal Operation

During normal operation the AC input source supplies the Rectifier, which converts the incoming AC power to DC. The rectifier in turn supplies the Inverter, which converts DC power to AC to supply the attached load (see Figure 3-1).

Figure 3-1: Power Flow, For Normal Operation.

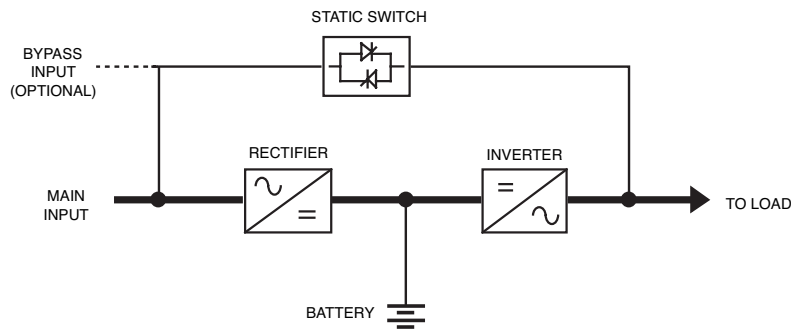

3.1.2 Power Flow, For On Battery Operation

When AC input power fails, the UPS goes to on-battery operation. DC power is supplied from the UPS battery system to the inverter, which converts battery power (DC) to AC power to supply the attached load (see Figure 3-2).

Figure 3-2: Power Flow, For On Battery Operation.

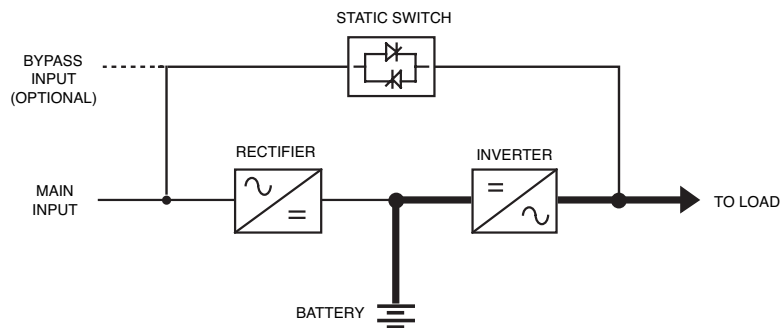

3.1.3 Power Flow, For Bypass Operation

Should there be an internal fault in the UPS, the load will automatically be transferred to the "Static Switch". (If bypass AC input is within tolerance). The load is supplied without interruption while the UPS is bypassed (see Figure 3-3).

Figure 3-3: Power Flow, For Bypass Operation.

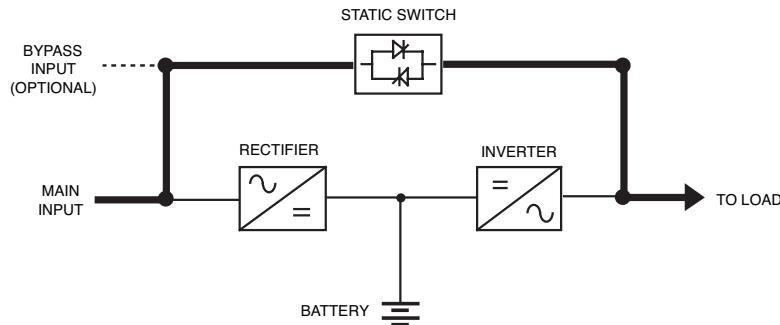

3.2 Graphical User Interface, Controls and Indicators

The Graphical User Interface (GUI) display, controls and indicators are located on the front panel in the upper left-hand corner of the Comet UPS, and consist of the following: (See Figure 3-4 for arrangement.)

- ▶ A Graphical User Interface (GUI) display.
- ▶ An alert buzzer.
- ▶ Four (4) LED's which indicate the overall operating status of the UPS.
- ▶ An "Inverter ON", an "Inverter OFF", and an "EPO" pushbutton.
- ▶ Three (3) control keys.

The basic Comet indications consist of the following:

- ▶ Normal operation (load protected)
- ▶ Battery power is not available (load not protected)
- ▶ Downgraded operation (fault)
- ▶ Danger of a break in the supply of power to the load (load not protected)
- ▶ Operation on battery power

When the buzzer is activated it will provide an audible warning to the operator by sounding a pulsed "beep" when any of the following conditions occur:

- ▶ The load is supplied directly by AC input power via the "Static Switch".
- ▶ The Inverter is operating on battery power.
- ▶ Any operating faults or change in operating status.

It beeps softly and slowly for minor faults and during Inverter operation on battery power. When the low battery shutdown warning level has been reached, the sound volume and the frequency of the beeps increase.

In the event of an Inverter shutdown, a continuous alarm is emitted. A buzzer reset key is provided on the front panel. Detection of a new fault will reactivate the buzzer.

Figure 3-4: Comet Front Panel GUI, Controls and Indicators.

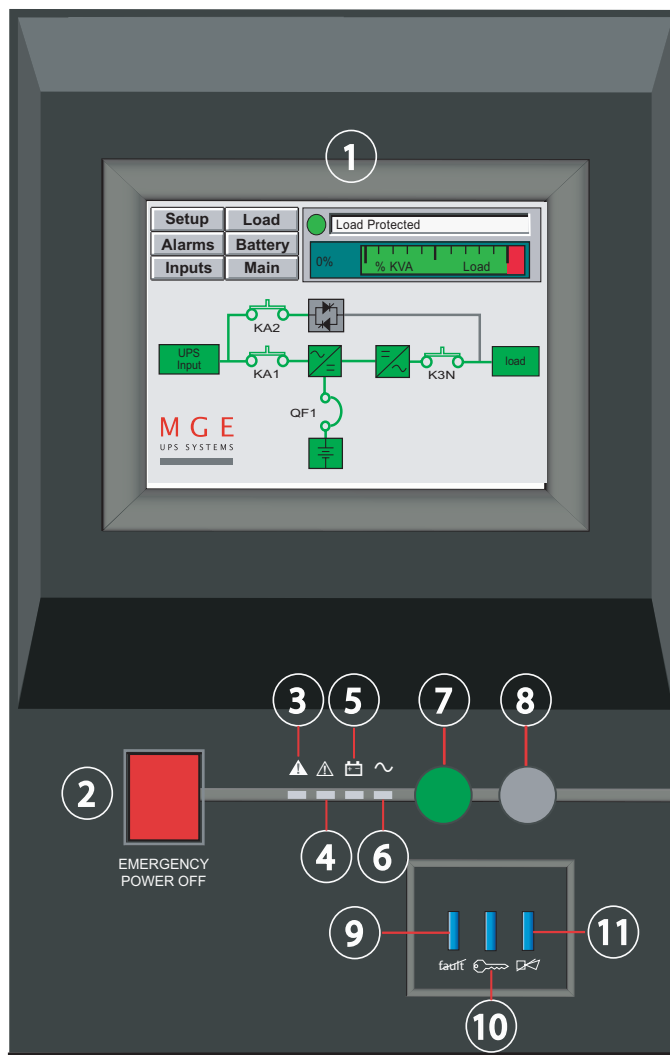

- | | |
|--|----------------------------------|
| ① Graphical User Interface (GUI) Display | ⑦ Inverter ON (green) pushbutton |
| ② Emergency Power Off Switch | ⑧ Inverter OFF (gray) pushbutton |
| ③ Load Not Protected (red) LED | ⑨ Fault Reset Key |
| ④ Fault (yellow) LED | ⑩ Security Key |
| ⑤ Battery Status (yellow) LED | ⑪ Buzzer Reset Key |
| ⑥ Load Protected (green) LED | |



NOTE

For details on the Graphical User Interface (GUI) display, please refer to manual 86-160316-00.

| | |
|---|--|
| Graphical User Interface Display | This display provides specific information concerning normal UPS operation as well as faults. |
| Emergency Power Off | This red Emergency Power Off (EPO) pushbutton is used to stop the unit during an emergency situation only. All power is removed from the load. |
| Load not protected LED | This red LED turns on when any of these conditions occur: <ul style="list-style-type: none">▶ Direct supply of power to the load by AC input power via the "Static Switch" because of Inverter shutdown (voluntary or following an overload or an internal fault).▶ Battery power is not available. Battery circuit breaker is in the "OFF" position or battery not connected. |
| Fault LED | This yellow LED indicates an operating fault or an environmental fault. However, the load continues to be supplied by the Inverter. |
| Battery Status LED | This yellow LED indicates: <ul style="list-style-type: none">▶ Inverter operation on battery power following an AC input failure or detection of an AC input voltage outside of tolerances.▶ It flashes to indicate that the low battery shutdown warning level has been reached.▶ If the LED flashes when the system is not on battery power, battery conditions should be checked. |
| Load protected LED | This green LED indicates that the Comet is operating normally. The load is protected and supplied via the Inverter output. Bypass Switch SR1 must be in the "NORMAL" position. |
| Inverter on | This green pushbutton is used to start the inverter. |
| Inverter off | This gray pushbutton is used to stop the inverter. |
| Fault Reset | This key clears the faults stored in memory. Clearing of alarms in memory is accepted only after the alarm conditions themselves have been corrected. |
| Security Key | This key enables forced operation. The security key must be held down while the desired function is executed. Refer to the Forced Transfer section. |
| Buzzer Reset | This key allows the user to silence the buzzer after a particular alarm. However, the buzzer will sound if another alarm occurs. |

3.3 Startup Procedures

3.3.1 Preliminary Checks

- ▶ Check the settings of the protection devices.
- ▶ Verify that the battery circuit breaker(s) are in the "OFF" position.
- ▶ Verify that the Manual Bypass Switch SR1 is set to the "NORMAL" position.
- ▶ Verify that the fan switch (SR2) is set to the "ON" position.
- ▶ Check that the ventilation system is not blocked (air entry through the bottom front and exhaust through the top).
- ▶ Check that there is a minimum of 36 inches clearance at the front and top for ventilation.
- ▶ Check that the Comet no longer rests on its 4 wheels (lifting levelers in place).
- ▶ Check that the load-circuit breaker(s) (where applicable) are in the "OFF" position.

3.3.2 Powering Up the Comet

**CAUTION**

As soon as AC input power is supplied to the Comet (customer supplied upstream circuit breaker is in the "ON" position), the load is initially supplied via the "Static Switch." The Graphical User Interface (GUI) display will begin to startup.

- ▶ Apply AC input power to the unit by closing the upstream circuit breaker.
- ▶ Put the battery circuit breaker(s) in the "ON" position.
- ▶ The buzzer sounds.
- ▶ The status LED's go on.
- ▶ The rectifier starts up.
- ▶ The cooling fans startup.
- ▶ The inverter automatically starts up, except if the system is in "manual startup" mode (optional).
- ▶ If the transfer conditions (AC input power within tolerances) are correct, the Inverter comes on line and supplies the load. The green "Load Protected" LED goes on.

3.4 Inverter Manual Startup

Typically, the Inverter is configured for automatic startup mode. For manual startup mode configuration, contact MGE Customer Support Services.

For manual startup:

- ▶ Press the green "Inverter ON" pushbutton.
- ▶ The green "Load Protected" LED flashes.
- ▶ The Inverter starts and if the transfer conditions are correct, the load is transferred to the Inverter.
- ▶ The red "Load Not Protected" LED goes off.
- ▶ The green "Load Protected" LED goes on.
- ▶ The GUI display indicates Load Protected.

3.5 Operating Procedures

3.5.1 Normal Operation

- ▶ The AC input power is present.
- ▶ The green "Load Protected" LED is on. The GUI display indicates the operating status of the UPS.
- ▶ The power drawn by the load is supplied by AC input power via the Rectifier and Inverter modules. The Battery Charger float charges or recharges the battery.
- ▶ The GUI display indicates "Load Protected".

3.5.2 Operation on Battery Power

When AC input power fails or is out of tolerance, the Rectifier shuts down and the battery supplies the power required by the Inverter to supply the load. The battery discharges.

- ▶ The green "Load Protected" LED is on. The GUI display indicates the operating status of the UPS.

The user is warned of operation on battery power by the buzzer and by the yellow "Battery Status" LED. This information is also available via the standard UPS MANAGER DB15 connector.

3.5.3 Battery Duration

During an AC input power failure, the duration of Inverter operation on battery power depends on:

- ▶ The rated capacity of the battery.
- ▶ The power drawn by the load.
- ▶ The battery temperature.
- ▶ The charge level of the battery.
- ▶ The age of the battery.

The real backup time, which depends on the actual load, may be greater if the Inverter operates at less than full rated load. It is possible, during operation on battery power, to increase the battery backup time by reducing the power drawn by the load (shedding of non-priority load).

A low battery shutdown warning signal is available via the standard UPS MANAGER DB15 connector for remote indications. It warns the user of upcoming battery shutdown at a user-determined level of remaining power.

On the UPS itself, the buzzer beeps louder and more rapidly, and the yellow "Battery Status" LED flashes rapidly.

The end of battery power occurs when the battery reaches shutdown level. At this point, the Inverter shuts down and the UPS goes into "Stand-By" mode. Load is no longer supported. If the input AC power does not return to within tolerance within approximately 2 hours, the unit will shutdown.

Once input AC power returns, the batteries begin their charging cycle. It takes approximately 10 hours of online operation to restore 10 minutes of backup time.

3.5.3.1 Return to AC Power

When the AC input power failure ends or power returns to within tolerances:

- ▶ If the end of battery backup power was not reached, the Comet returns to normal operating mode.
- ▶ If the end of battery backup power was reached and unit is in "Standby" mode, the Rectifier and the Inverter automatically start up (the inverter must be manually started if the system is in manual startup mode).
- ▶ If the end of "Stand-By" mode was reached, follow the Startup procedure.

3.5.4 Overload

When an Inverter temporary overload occurs, the load is transferred to the "Static Switch". Return to normal mode of operation is automatic, following elimination of the overload.

The Inverter can handle a continuous overload for a given duration depending on the size of the output current overload (see Figure 3-5) or the output power overload (see Figure 3-6).

When an overload occurs:

- ▶ The buzzer sounds.
- ▶ The yellow "Fault" LED goes on.
- ▶ The Inverter shuts down at the end of its corresponding overload time.
- ▶ The load is supplied by AC input power via the "Static Switch".
- ▶ The green "Load Protected" LED goes off.
- ▶ The red "Load Not Protected" LED goes on.

The operating status of the UPS is provided by the GUI display. If the overload continues during operation via the "Static Switch", the supply of power to the load is interrupted after a specified time.

When the Comet shuts down because of a continuous overload, the "Fault Reset" key must be pressed prior to return to normal operation and after elimination of the overload.

Figure 3-5: Output Current Overload Curve.

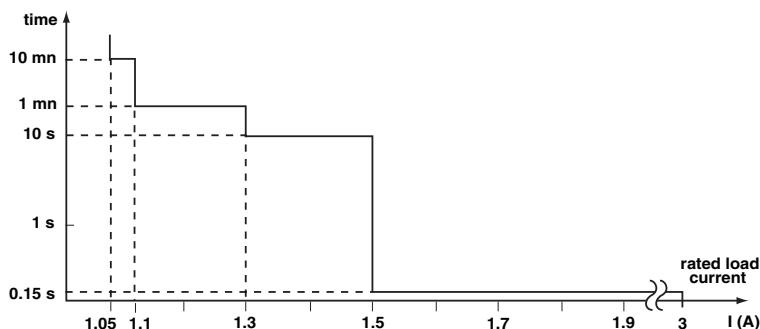
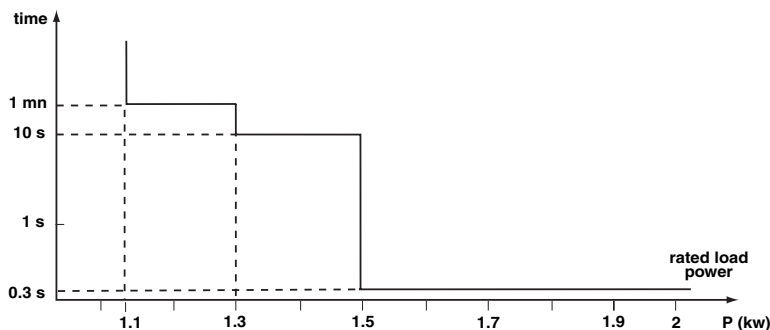

Figure 3-6: Output Power Overload Curve.



3.6 Emergency Shutdown Using EPO/REPO



CAUTION

Pressing the “Emergency Power Off” (EPO) or “Remote Emergency Power Off” (REPO) pushbutton disconnects the attached load. The EPO is to be used during emergency situations only, where a hazard to personnel or equipment exists, such as during a fire. **DO NOT USE THE EPO TO TURN THE UPS ON OR OFF.**

Follow the procedures listed in this section for turning the Inverter on and off.

During an emergency situation, such as a fire in the computer or electrical room, the UPS and all downstream devices can be instantly shut down by pressing the EPO pushbutton on the front panel of the UPS cabinet, or by pressing the "Remote Emergency Power Off" (REPO) optional pushbutton.

The EPO or REPO pushbuttons should not be used for normal shutdown of the equipment.

If the EPO pushbutton has been pressed, it must be reset by pressing it again and by pressing the "Fault Reset" key on the front panel to allow the UPS to restart.

3.7 Forced Transfer



CAUTION

Using the forced transfer functions will cause the load to experience a power interruption for a minimum of 500 milliseconds. Be certain that the load can tolerate this interruption.

Forced transfer is required if bypass input is out of tolerance. The load can be transferred from the Inverter output to the bypass input source, or back, with a power interruption of 500 milliseconds.

Transferring the Load to Bypass Input From Inverter

On the front panel, press the "Security" key and hold it while pressing the gray "Inverter OFF" pushbutton for 3 seconds.

Transferring the Load to Inverter From Bypass Input

On the front panel, press the "Security" key and hold it while pressing the green "Inverter ON" pushbutton for 3 seconds.

3.8 Maintenance Bypass

This procedure assumes that the UPS is operating normally, with the attached load supplied via the Inverter.

3.8.1 From Normal Maintenance Bypass Mode

1. Stop the Inverter by pressing the gray "Inverter OFF" pushbutton on the UPS front panel for approximately three (3) seconds. The audible alarm will sound; silence the alarm by pressing the "Buzzer Reset" pushbutton. If the transfer conditions are not satisfied (bypass out of tolerance or other reason), a forced transfer will be required. Refer to the "Forced Transfers" section for more information.
2. Switch the battery circuit breaker QF1 to the "OFF" position.



NOTE

The battery circuit breaker QF1 will automatically trip open if left in the “ON” position when the UPS is placed in the Maintenance Bypass mode.

3. Turn the manual bypass switch to the "TRANSFER" position, then to the "BYPASS" position.
4. All indicating LED's go off.

**NOTE**

The cooling fans will remain operational when the UPS is placed on Maintenance Bypass mode to prevent the optional input/output transformers inside the UPS from overheating. If it is necessary to de-energize the fans, move the fan control switch (SR2) to the "OFF" position.

**CAUTION**

In this mode of operation, the UPS is ready for maintenance, but voltage is still present on terminal blocks and various internal components.

Now the UPS is ready for maintenance.

3.8.2 From Maintenance Bypass to Normal Mode

**WARNING**

Failure to follow the proper Startup sequence will result in load loss. After SR1 is set to "TRANSFER," it takes the UPS five (5) to six (6) seconds to test the input power before turning on the "Static Switch". During this time, the load is still supplied by the Maintenance Bypass line, and moving SR1 to "NORMAL" will result in interruption of power to the load.

1. Move the fan control switch (SR2) to the "ON" position if the cooling fans were de-energized during maintenance.
2. Turn the manual bypass switch SR1 to the "TRANSFER" position.
3. Wait for the GUI display to go on (at least 5 seconds).
4. Turn the Inverter off by pressing the gray "Inverter OFF" pushbutton on the front panel for approximately 3 seconds if your Comet has been programmed to automatically restart.

**CAUTION**

ALWAYS turn the Inverter off before rotating the Manual Bypass Switch (SR1).

5. Close the battery disconnect circuit breaker(s) QF1.
6. Turn the manual bypass switch SR1 to the "NORMAL" position.
7. Turn the Inverter on by pressing the green "Inverter ON" pushbutton on the front panel. If the transfer conditions are not satisfied (bypass out of tolerance or other reason), a forced transfer will be required. Refer to the "Forced Transfers" section for more information.

Now the UPS is in normal operating mode. The green "Load Protected" LED is illuminated on the front panel, and the operating status of the UPS is provided by the GUI display.

3.9 Shutdown Procedures

3.9.1 Inverter Shutdown

- ▶ Press and hold the gray "Inverter OFF" pushbutton for 3 seconds.
- ▶ The green "Load Protected" LED goes off.
- ▶ The red "Load Not Protected" LED goes on.
- ▶ The buzzer sounds.
- ▶ The Inverter stops if the transfer conditions are correct.
- ▶ The load is transferred and supplied via the "Static Switch".

3.9.2 Powering Down

It is recommended not to power down the Comet for long periods because the battery should remain charged. However, to carry out a power down, proceed as follows:

- ▶ Shut down the Inverter.
- ▶ Put the battery circuit breaker in the "OFF" position.
- ▶ Put the upstream main circuit breaker in the "OFF" position.
- ▶ All the indicating LED's on the control panel go off.

















































3.10 Alarms

Any state other than normal operation (green "Load Protected" LED on) is considered a fault by the diagnostics system.





Before undertaking any servicing or other action, note the status of the different LED's and the GUI messages displayed on the panel.

If an alarm is present and the load still functions, it is supplied via the "Static Switch", i.e. it is not protected.

Table 3-1: Alarm Indications.

|  |  |  |  |  |  | status or action producing the indication |
|---|---|---|---|---|---|--|
|  |  |  |  |  |  | <ul style="list-style-type: none"> ■ inverter start-up phase prior to load transfer. The "inverter on" button has been pressed. |
|  |  |  |  |  |  | <ul style="list-style-type: none"> ■ normal operation; ■ load supplied by Comet UPS (SR1 in normal position) |
|  |  |  |  |  |  | <ul style="list-style-type: none"> ■ inverter shutdown following pressing of the "inverter off" button or a major fault; ■ load supplied via the "static switch" |
|  |  |  |  |  |  | <ul style="list-style-type: none"> ■ operation on battery power; ■ load supplied by Comet UPS |
|  |  |  |  |  |  | <ul style="list-style-type: none"> ■ end of battery power or battery should be checked |
|  |  |  |  |  |  | <ul style="list-style-type: none"> ■ minor fault; (load continues to be supplied via inverter) |
|  |  |  |  |  |  | <ul style="list-style-type: none"> ■ UPS shutdown; ■ load supplied via maintenance bypass |

Legend of alarm indications table:

-  buzzer off,
-  light off,
-  buzzer on,
-  light on,
-  light flashing

4.0 Scope

Preventive maintenance and battery safety instructions for Comet 40-150kVA UPS, and information about replacement parts, and customer service.

4.1 Battery Safety

IMPORTANT SAFETY INSTRUCTIONS FOR SERVICING BATTERIES

- A. Servicing of batteries should be performed or supervised by personnel knowledgeable with batteries and the required precautions. Keep unauthorized personnel away from batteries.
- B. When replacing batteries, use the same model and manufacturer of batteries.
- C. CAUTION — Do not dispose of battery or batteries in a fire. The battery may explode.
- D. CAUTION — Do not open or mutilate the battery or batteries. Released electrolyte is harmful to the skin and eyes. It may be toxic.
- E. CAUTION — A battery can present a risk of electrical shock and high short-circuit current. The following precautions should be observed when working with batteries:
 - 1. Remove watches, rings, or other metal objects.
 - 2. Use tools with insulated handles.
 - 3. Wear rubber gloves and boots.
 - 4. Do not lay tools or metal parts on top of batteries.
 - 5. Disconnect charging source prior to connecting or disconnecting battery terminals.
 - 6. Determine if ground faults exists. If so, remove the source of ground. Contact with any part of a grounded battery can result in electrical shock. The likelihood of such shock will be reduced if such grounds are removed during installation and maintenance.

4.2 Preventive Maintenance

The following preventive maintenance routines should be considered the minimum requirements; your installation and site may require additional preventive maintenance to assure optimal performance from your installed Comet UPS and associated equipment. These routines should be performed twice a year (more often if required). We strongly recommend contracting MGE Customer Support Services for preventive and remedial maintenance at 1-800-438-7373.

The technician or electrician performing preventive maintenance on the UPS must be familiar with the indicators, controls, and operation of the UPS.

- a. Isolate and de-energize all Comet UPS equipment for all maintenance operations. Lock and tag all upstream circuit breaker(s) during maintenance.
- b. Ensure that all equipment is clean and free of dust, dirt, and debris. The exterior of the UPS enclosure may be cleaned with a mild solution of soap and water, lightly applied with a lint-free cloth.
- c. Clean/replace the air intake filters, exhaust plates, and the enclosure interior with a vacuum cleaner.
- d. Initiate the startup procedure, as described in Section 3.
- e. Test the main operating sequences as applicable to your installation (see Section 3).

4.3 Replacement Parts

There are no user serviceable parts inside the Comet UPS.

Three levels of replacement parts are available for the Comet. The three levels are designated A, B, and C. The level that you should keep on hand for your installation will vary depending on the type of maintenance planned on site, and the configuration of your UPS system.

Having the replacement parts on hand will prevent any unacceptable delays (because of time involved obtaining spares) during critical periods, such as system startup. Any items used during start-up will be replaced by MGE at no charge. Contact MGE Customer Care Center at 1-800-438-7373 for specific recommendations.

A description of each level is provided below:

| Level | Description |
|--------------|--------------------|
|--------------|--------------------|

- | | |
|----------|---|
| A | This level of replacement parts consists of consumable items, specifically power and control fuses. It is recommended to have these items on hand during installation of the UPS systems, including initial startup. |
| B | This level of replacement parts is recommended when the user can tolerate short-duration UPS down-time to obtain replacement parts in the event of a major UPS failure. This level of replacement parts consists of consumable items, specifically power and control fuses, fans, and the most critical circuit board assemblies. |
| C | This level of replacement parts is recommended when the user can tolerate only a minimum of down-time in the event of a major UPS failure. This level of replacement parts consists of consumable items, specifically power and control fuses, fans, and a significant set of circuit board assemblies. |

MGE Warranty & Proprietary Rights Statement for Three Phase Products

(Applicable within the United States, Canada and Mexico)

MGE Standard Three Phase Warranty

MGE UPS SYSTEMS, INC. ("MGE") warrants three phase products it manufactures to be free from defects in materials and workmanship for a period of three hundred sixty five (365) days counting from the date of purchase by or for the first end user ("Purchaser"), or, if applicable, the date of MGE's completion of initial startup of the subject product, provided however said warranty shall not exceed eighteen (18) months from the date of delivery of the subject product to Purchaser (the "Warranty Period"). MGE's liability hereunder is limited to replacing or repairing at MGE's factory or on the job site, at MGE's option, any part or parts that are defective and reported to MGE during the Warranty Period. MGE shall have the sole right to determine if the parts are to be repaired at the job site or whether they are to be returned to the factory for repair or replacement. All items returned to MGE for repair or replacement must be sent freight prepaid to its factory. Purchaser must obtain MGE's Return Goods Authorization ("RGA") prior to returning items. The conditions stated herein must be met for MGE's warranty to be valid. MGE will not be liable for any damage done by unauthorized repair work, unauthorized replacement parts, from any misapplication of the subject product, for damage due to accident, abuse, or act of God (such as earthquake, flood, inclement weather, rain or fire), or relating to Purchaser's failure to follow proper environmental conditions for the product.

In no event shall MGE be liable for loss, damage, or expense directly or indirectly arising from the use of or any defects in the subject product, or from any other cause, except as expressly stated in this warranty. EXCEPT AS EXPRESSLY STATED IN THIS WARRANTY, MGE UPS SYSTEMS, INC. MAKES NO WARRANTIES, EXPRESS OR IMPLIED, INCLUDING ANY WARRANTY AS TO MERCHANTABILITY OR FITNESS FOR A PARTICULAR PURPOSE OR USE OR NON-INFRINGEMENT. MGE is not liable for and Purchaser waives any right of action it has or may have against MGE for any consequential or special damages arising out of any breach of warranty, and for any damages Purchaser may claim for damage to any property or injury or death to any person arising out of its purchase or the use, operation or maintenance of the subject product. The warranty stated herein includes parts and labor; however, MGE will not be liable for any labor subcontracted or performed by Purchaser for preparation of the warranted item for return to MGE's factory or for preparation work for field repair or replacement, and MGE will not be responsible to pay any invoice therefore.

This warranty shall be exclusive of any and all other warranties express or implied and may be modified only by a writing signed by an authorized officer of MGE UPS SYSTEMS, INC. This warranty shall extend to the Purchaser but to no one else. Accessories supplied by MGE, but manufactured by others, carry any warranty the manufacturers have made to MGE, and which can be passed on to Purchaser.

MGE UPS SYSTEMS, INC. makes no warranty with respect to whether the products sold hereunder infringe any patent, U.S. or foreign, and Purchaser represents that any specially ordered products do not infringe any patent. Purchaser agrees to indemnify and hold MGE UPS SYSTEMS, INC. harmless from any liability by virtue of any patent claims where Purchaser has ordered a product conforming to Purchaser's specifications, or conforming to Purchaser's specific design.

Purchaser has not relied and shall not rely on any oral representation regarding any products sold hereunder and any oral representation shall not bind MGE UPS SYSTEMS, INC. and shall not be part of any warranty.

There are no warranties which extend beyond the description on the face hereof. In no event shall MGE UPS SYSTEMS, INC. be responsible for consequential damages or for any other damages except as expressly stated herein.

Proprietary Rights Statement

The information in this manual is the property of MGE UPS SYSTEMS, INC., and represents a proprietary article in which MGE UPS SYSTEMS, INC. retains any and all intellectual property rights, including exclusive rights of use and/or manufacture and/or sale. Possession of this information does not convey any permission to reproduce, print, manufacture or have made the article or articles shown herein. Such permission may be granted only by specific written authorization signed by an authorized officer of MGE UPS SYSTEMS, INC.

IBM, PC-AT, ES/9000, and AS/400 are trademarks of International Business Machines Corporation. MGE and MGE UPS SYSTEMS are trademarks of MGE UPS SYSTEMS, INC. Other trademarks that may be used herein are owned by their respective companies and are referred to in an editorial fashion only.

For Three Phase Warranty outside of the United States, Canada and Mexico, refer to Three Phase International Warranty.

January 2005 Rev C00

Warranty and Product Registration

Thank you for choosing MGE UPS SYSTEMS, INC. for your power protection, distribution, and quality requirements. We are pleased to have you join our increasing family of users.

In order to maximize the value you receive from this product, and to ensure that you are kept informed of product or software updates, we recommend that you take a few minutes to register your new purchase. You may register online at the URL noted below. Should you not have Internet access, you may mail or fax this form back (attn: Warranty Registration) as indicated at the bottom of the page.

Register your product at: <http://www.mgeups.com/email/warranty/menu.htm>

Please be prepared with the following information to register and validate your product's warranty, keep informed on software and product updates, and register your extension "Warranty+" if purchased with the product.

User Information

Last name _____
First name _____
Company name _____
Address _____
Zip code _____
City _____
State/Province _____
Country _____
Tel _____
Fax _____
Email _____

Product Information

Model _____
Serial Number _____
Date of purchase _____

Warranty Extension (Warranty+)

I have purchased a warranty extension (Warranty+)

Reference: _____ Contract Number: _____

Thank you from all of us at MGE.

MGE UPS SYSTEMS, INC., 1660 Scenic Avenue, Costa Mesa, CA 92626, USA
Tel: 714-557-1636 Fax: 714-557-9788

41-000154-53 Rev B02 8/2005

MGE Customer Care Center - Three Phase Products

Technical Support and Product Services



Technical questions? If you encounter a problem while following the instructions in this manual, or have questions about the operation, repair, or servicing of your equipment, please direct calls to MGE UPS SYSTEMS, INC. Customer Care Center or visit our web site www.mgeups.com for complete service information.

To insure that your questions are correctly answered, please obtain the serial number of the unit and include them in any discussions or correspondence.

Serial number: _____

Who To Contact

Customer Care Center: **1-800-438-7373** (Hours: 24/7)

**Customer FAQ
or International calls:** **1-714-557-1636**

Commitment: MGE UPS SYSTEMS, INC. is committed to providing easy to access factory trained experts that will provide responses to any questions that you might have.

Scheduling Field Service Engineer Support

Scheduling of the MGE Field Service Engineers typically should be done 7 to 10 days before they are required on-site. If the startup of the product is critical to maintaining your schedule, please call the MGE toll free telephone number at **1-800-438-7373** for assistance.

Return Policy for Repair of Three Phase Products (RGA)

Should you require factory service for your equipment, contact MGE Customer Care Center and obtain a Return Goods Authorization (RGA) prior to shipping your unit. Never ship equipment to MGE without first obtaining an RGA number.

Date: _____

RGA Number: _____

Contact Name: _____

Rev B00 8/2005

(This page left blank intentionally)

| Term used | Definition / Meaning |
|------------------|---|
| @ | At. |
| / | And/or. |
| +/- | Plus or Minus. |
| ≤ | Equal to or less than. |
| # | Number. |
| °C | Degree Celsius. |
| °F | Degree Fahrenheit. |
| ∅ | Phase angle. |
| Ω | Ohm; unit of resistance. |
| ® | Trade Mark. |
| 2nd | Second. |
| AC or ac | Alternating current, also implies root-mean-square (rms). |
| Ambient Temp. | Temperature of surrounding air. |
| Ambient noise | Acoustical noise of surrounding environment. |
| ANSI | American National Standard Institute. |
| AWG | American Wire Gauge. |
| Breaker | Electrical circuit interrupter. |
| BTU or Btu | British thermal unit. Defined as the amount of heat required to raise the temperature of one pound of water by 1°F. |
| BYPASS | See "Static Transfer switch". |
| BYPASS mode | See "off-line mode". |
| Carrier | The company or individual responsible for delivering goods from one location to another. |
| C | Common. |
| CB | Circuit breaker. |
| cm | Centimeter. |
| CSA | Canadian Standards Association. |
| dB | Decibels. |
| DC | Direct current. |
| Conduit | A flexible or rigid tube enclosing electrical conductors. |

| | |
|----------------------|---|
| C.S.S. | Customer Support Service. |
| Current rating | The maximum current that a conductor or equipment can carry reliably without damage. |
| dBA | Decibel Adjusted. |
| dBrnC | Decibel above reference noise. |
| DC or dc | Direct current, or voltage. |
| Digital Meter | The LCD display on the front panel of inverter system. |
| Earth ground | A ground circuit that has contact with the earth. |
| ECO Mode | Operating mode by which the load is supplied directly by the AC source if it is within the tolerances defined by the user. This mode reduces the consumption of electrical power. |
| Electrician | Refers to an installation electrician qualified to install heavy-duty electrical components in accordance with local codes and regulations. Not necessarily qualified to maintain or repair electrical or electronic equipment. |
| FCC | Federal Communications Commission. |
| FET | Field effect transistor. |
| Freq. | Frequency. |
| Frequency slew rate | The change in frequency per unit of time. Given in term of Hz per second (Hz/sec.). |
| GND | Ground (safety). |
| Hz | Hertz, frequency measurement unit, 1Hz is one cycle per second. |
| Inverter mode | See "on-line" mode. |
| I | Current. |
| IEC | International Electrotechnical Commission. |
| IEEE | Institute of Electrical and Electronic Engineers. |
| Input branch circuit | The input circuit from the building power panel to the equipment. |
| Inverter | An electrical circuit that generates an AC voltage source from a DC voltage source. |
| IGBT | Insulated gate bipolar transistors. |
| I/O | Input/Output. |
| I/T or IT | Information Technology. |
| kVA | KiloVolt-Ampere; is equal to 1000 Volt-Ampere. |
| L | Line. |
| LCD | Liquid-Crystal Display unit. |
| LED | Light Emitting Diode. |
| Mains or Mains 1 | Main AC input source. |
| Mains 2 | Bypass AC input source. |
| mA | Milliampere. |
| MAX. | Maximum. |
| MCM | Thousand circular mil; standard wire sizes for multiple stranded conductors over 4/0 AWG in diameter. M is from Roman numerical system indicating 1000. |

| | |
|-----------------|--|
| Module | Refers to individual power inverter module. |
| N | Neutral. |
| NC | Normally closed. |
| NO | Normally open. |
| NEC | National Electrical Code. |
| NEMA | National Electrical Manufacturers Association. |
| NFPA | National Fire Protection Association. |
| PF | Power factor. |
| PN | Part number. |
| On-line mode | Inverter output power is the primary energy source to load. |
| Off-line mode | Inverter output is off, and the load connected at the inverter output receives power from utility line via a static transfer switch or maintenance bypass relay. |
| OSHA | Occupational Safety and Health Agency. |
| PCA | Printed circuit assembly. |
| PCB | Printed circuit board. |
| PWM | Pulse Width Modulation. |
| SCR | Silicon controlled rectifier. |
| Shipping damage | Any damage done to an article while it is in transit. |
| SPDT | Single Pole Double Throw. |
| Static Transfer | An solid state switching mechanism electronically controlled to pass AC power directly from the utility to an output load. |
| Technician | Refers to an electronic technician qualified to maintain and repair electronic equipment. Not necessarily qualified to install electrical wiring. |
| Test connector | DB-9 type connector on the LCD panel allowing MGE UPS SYSTEMS Customer Support Service technician to access programmable and diagnostic features of the system. |
| UL | Underwriter's Laboratories, Inc. |
| UPS | Uninterruptible Power Supply or Uninterruptible Power System. |
| V | Volts |
| VA | Volt amperes |
| VA | Volt-amps, unit for apparent power measurement, equal $V \times I$. |
| VAC or Vac | Voltage of AC type. |
| VDC or Vdc | Voltage of DC type. |
| ve | Battery voltage. |
| Via | By way of. |

(This page left blank intentionally)

Reorder Form



**1660 Scenic Avenue
Costa Mesa, CA 92626**

Use this form to report any errors, omissions, or other problems you have experienced, or to order additional hardcopies of this document. A free copy of this document may be downloaded from the proprietary MGE Rep Web site. Please contact your MGE UPS SYSTEMS, INC. Representative for assistance.

NAME _____

COMPANY _____

STREET ADDRESS _____

CITY _____ STATE _____ ZIP _____

I would like to order _____ (quantity @ \$75.00 each) additional copies of the:

Comet 40-150kVA

Installation and User Manual

86-160310-00 E00

I would like to report the following problems with this document:

Contact MGE

United States

MGE UPS SYSTEMS

1660 Scenic Ave.
Costa Mesa, CA 92626

Tel: (714) 557-1636
CCC: (800) 438-7373
Fax: (714) 557-9788
email: info@mgeups.com
www: mgeups.com

Canada

MGE UPS SYSTEMS

#9, 2789 Thamesgate Drive
Mississauga, ON L4T 4E8

Tel: (905) 672-0990
(877) 672-0990
Fax: (905) 672-7667
email: info@mgeups.com
www: mgeups.com

Latin America and Other International

MGE UPS SYSTEMS

1660 Scenic Ave.
Costa Mesa, CA 92626

Tel: (714) 513-7831
Fax: (714) 434-0199
email: info@mgeups.com
www: mgeups.com

M G E
UPS SYSTEMS

Free Manuals Download Website

<http://myh66.com>

<http://usermanuals.us>

<http://www.somanuals.com>

<http://www.4manuals.cc>

<http://www.manual-lib.com>

<http://www.404manual.com>

<http://www.luxmanual.com>

<http://aubethermostatmanual.com>

Golf course search by state

<http://golfingnear.com>

Email search by domain

<http://emailbydomain.com>

Auto manuals search

<http://auto.somanuals.com>

TV manuals search

<http://tv.somanuals.com>