

Memorex[®]

Mini Compo CD Player with Radio

Model: MX9790

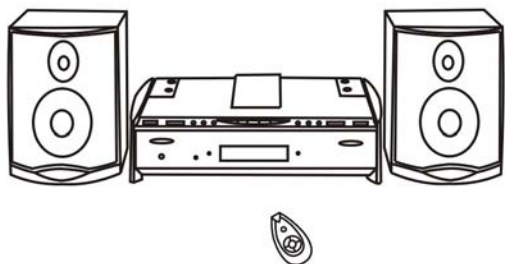

**Memcorp, Inc.
Weston, FL
Printed in Hong Kong**



Note: Please read and follow these instructions before using your unit.

Visit our website at www.memorexelectronics.com

WARNING



TO PREVENT ELECTRIC SHOCK; DO NOT USE THIS PLUG WITH AN EXTENSION CORD RECEPTACLE OR OTHER OUTLET UNLESS THE BLADES CAN BE FULLY INSERTED TO PREVENT BLADES EXPLOSURE.

TO PREVENT FIRE OR SHOCK HAZARD; DO NOT EXPOSE THIS APPLIANCE TO RAIN OR MOISTURE.

 <p>The lightning flash with arrowhead symbol, with an equilateral triangle is intended to alert the user to the presence of uninsulated dangerous voltage within the products enclosure that may be of sufficient magnitude to constitute a risk of electric shock to persons.</p>	<p>CAUTION</p> <p>RISK OF ELECTRONICS SHOCK DO NOT OPEN</p> <p>CAUTION: TO REDUCE THE RISK ELECTRIC SHOCK, DO NOT REMOVE COVER (OR BACK). NO USER SERVICEABLE PARTS INSIDE. REFER SERVICING TO QUALIFIED SERVICE PERSONNEL.</p>	 <p>The exclamation point within an equilateral triangle is intended to alert the user to the presence of important operating and maintenance (servicing) instruction in the literature accompanying the appliance.</p>
<p>LASER SAFETY</p> <p>This unit employs a laser. Only a qualified service person should remove the cover or attempt to service this device to due possible eye injure.</p> <p>Caution: USE OF CONTROLS OR ADJUSTMENT OF PERFORMANCE OF PROCEDURE OTHER THAN SPECIFIED HEREIN MAY RESULT IN HAZARDOUS RADIATION EXPOSURE</p>	<p>DANGER:</p>  <p>INVISIBLE LASER RADIATION WHEN OPEN AND INTERLOCK FAILED OR DEFEATED. AVOID DIRECT EXPOSURE TO LASER BEAM.</p>	

"CAUTION - TO PREVENT ELECTRICAL SHOCK, MATCH WIDE BLADE PLUG TO WIDE SLOT FULLY INSERT."

IMPORTANT SAFETY INSTRUCTIONS

<p>WARNING:</p> <p>TO PREVENT FIRE OR SHOCK HAZARD, DO NOT USE THE PLUG WITH AN EXTENSION CORD, RECEPTACLE OR OTHER OUTLET UNLESS THE BLADES CAN BE FULLY INSERTED TO PREVENT BLADE EXPOSURE. TO PREVENT FIRE OR SHOCK HAZARD, DO NOT EXPOSE THIS APPLIANCE TO RAIN OR MOISTURE.</p>		
 <p>The lightning flash with arrowhead symbol within the triangle is a warning sign alerting the user of "dangerous voltage" inside the unit.</p>	<p>CAUTION</p> <p>RISK OF ELECTRIC SHOCK DO NOT OPEN</p> <p>ATTENTION: To reduce the risk of electric shock, do not remove the cover. There are no user serviceable parts inside the unit. Refer all servicing to qualified personnel.</p>	 <p>The exclamation point within the triangle is a warning sign alerting the user of important instructions accompanying the product.</p>

1. Read these instructions.
2. Keep these instructions.
3. Heed all warnings.
4. Follow all instructions.
5. Do not use this apparatus near water.
6. Clean only with dry cloth.
7. Do not block any ventilation openings. Install in accordance with the manufacturer's instructions.
8. Do not install near any heat sources such as radiators, heat registers, stoves, or other apparatus (including amplifiers) that produce heat.
9. Do not defeat the safety purpose of the polarized or grounding-type plug. A polarized plug has two blades with one wider than the other. A grounding-type plug has two blades and a third grounding prong. The wide blade or the third prong is provided for your safety. If the provided plug does not fit into your outlet, consult an electrician for replacement of the obsolete outlet.
10. Protect the power cord from being walked on or pinched particularly at plug, convenience receptacles, and the point where they exit from the apparatus.
11. Only use attachments/accessories specified by the manufacturer.
12. Unplug this apparatus during lightning storms or when unused for long periods of time.
13. Refer all servicing to qualified service personnel. Servicing is required when the apparatus has been damaged in any way, such as power-supply cord or plug is damaged, liquid has been spilled or objects have fallen into the apparatus, the apparatus has been exposed to rain or moisture, does not operate normally, or has been dropped.
14. This appliance shall not be exposed to dripping or splashing water and that no object filled with liquids such as vases shall be placed on the apparatus.

LOCATION OF CONTROLS

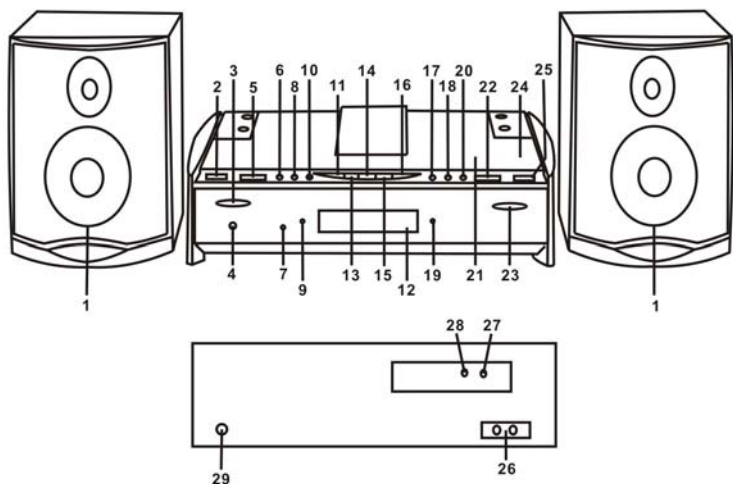

- | | |
|--|-------------------------|
| 1. Speakers | 16. Minute Set Button |
| 2. Function Switch | 17. Repeat Button |
| 3. Power Switch | 18. Play/Pause Button |
| 4. Stereo Headphones Jack | 19. FM Stereo Indicator |
| 5. Volume Control Knob | 20. Stop Button |
| 6. Skip / Backward Search Button | 21. CD Door |
| 7. Remote Sensor | 22. Tuning Knob |
| 8. Skip / Forward Search Button | 23. CD Door Open Button |
| 9. Power Indicator | 24. CD Door Close |
| 10. Program Button | 25. Band Switch |
| 11. ON / OFF Alarm Switch | 26. AC Socket |
| 12. Display | 27. Left Speaker Jack |
| 13. Alarm Set Button
(CD, Time, AM/FM Station, Alarm) | 28. Right Speaker Jack |
| 14. Time Set Button | 29. FM Wire Antenna |
| 15. Hour Set Button | |

CONNECTING THE LOUDSPEAKERS

Connect the cables of the two loudspeakers to the corresponding input **(R)** for the right speaker and input **(L)** for the left speaker, located at the back of the unit.

Warning:

- Connect the loudspeakers before powering the unit;
- The unit may not work properly or get damaged if you use speakers different than the ones supplied with the unit

AC OPERATION

Connect the plug to the AC socket of the unit and the other end to a standard AC outlet.

ATTENTION

1. Do not plug or unplug the power cable while you have wet hands;
2. When planning not to use this unit for a long time, disconnect the power cable from the wall outlet;
3. When disconnecting the power cord from the wall outlet, do not pull on the cord in order to avoid shock risks caused by damaged cable.

SET THE CORRECT TIME

Before starting to set the time, make sure that the Function Switch is not on Radio position.

Press and hold the time button as well as the Hour and Minute buttons simultaneously, in order to set the time. Release all buttons when reaching the correct time.

RADIO OPERATION

1. Set the Function Selector to Radio position;
2. Set the band selector to AM/FM position;
3. Adjust the TUNING control to tune in a radio station.

SET THE ALARM TIME

Before starting to set the alarm time, make sure that the Function Switch is not on Radio position.

Press and hold simultaneously the Alarm button as well as the Hour and Minute buttons, to adjust the alarm time. Release all buttons when reaching the desired alarm time and the display will go back to regular time.

RADIO WAKE UP FUNCTION

Select the desired radio station and set the volume to the desired level and make the following steps:

1. Slide the Function Switch to auto position;
2. Press the **ALARM ON/OFF** button once to activate the alarm function and the display will show "(((•" indicating that the alarm is ON and press the ALARM ON/OFF button again to cancel;
3. Set the alarm time as indicated at the **SET ALARM TIME** section and the unit's radio will turn on at the pre-selected time.

BUZZER WAKE UP FUNCTION

Follow the same instructions as for Radio Wake up Function, but slide the Function Switch to Alarm position. The buzzer will sound for 3 minutes.

CD PLAYER OPERATION

To play a CD, please follow the steps underneath:

1. Set the Function Selector to the CD position;
2. Press the **OPEN** button in order to open the CD door;
3. Insert the CD with the printed side facing up and close the CD door;
4. Disc information (total number of tracks) will appear on the LED display;
5. Press **PLAY/PAUSE** button to start playing the CD;
6. Adjust the volume control to the desired volume level;
7. Press **STOP**, to stop playing the CD

SKIP DURING PLAY MODE

1. Press **SKIP ►** button once to skip to the beginning of the next track;
2. Press **SKIP ◀** button once to skip to the beginning of the correct track;
3. Press **SKIP ◀** twice quickly in succession to go back to previous tracks.

SEARCH DURING PLAY MODE

1. Press and hold the search buttons to quickly advance or reverse through the music at high speed;
2. Release the **►SEARCH◀** button to return to normal play mode.

- 5 -

PROGRAMMING THE CD PLAYER

The programming of the CD player should be done during **STOP** mode.

1. Press the **PROGRAM** button to begin programming the CD player;
2. Press **►SKIP** or **SKIP◀** buttons, to select desired track;
3. Press **PROGRAM** button again to store this track in memory;
4. Repeat steps from 2 to 3 to store more tracks in memory. You can store a maximum of 19 tracks in the memory.
5. Press **PLAY/PAUSE** button to play the disc in the programmed order;
6. To stop playing, press **STOP**;
7. To cancel the programming, press **STOP** button and open the CD player door or select a different function (**OFF/RADIO** etc.)

REPEAT FUNCTION

To repeat the same track:

- Press **REPEAT** button before or while playing the song. The **REPEAT** symbol "↶" will light up on the display.

To repeat the whole disc:

- Press **REPEAT** button twice. The **REPEAT** symbol "↶^{ALL}" will light up on the display.

To cancel the repeat function:

- Press **REPEAT** button three times. The **REPEAT** indicator will be cleared from the display.

PAUSE FUNCTION

1. While playing a CD, press **PLAY/PAUSE** button once to temporarily pause the play.
2. Press **PLAY/PAUSE** button again to resume play.

REMOTE CONTROL OPERATION

Open the Battery Compartment Door and insert two pieces "AAA" size batteries into the battery compartment with battery polarity as shown inside the battery compartment.

Point the remote control at the remote sensor. The functions of the buttons on the remote control are same as the corresponding controls on the main unit.

- 6 -

1. Stop Button
2. Skip/Search ⏪ Button
3. Skip/Search ⏩ Button
4. Repeat Button
5. Play/Pause Button
6. Battery Compartment

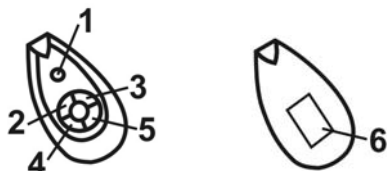

Warning:

When the remote will not be used for a long time, remove the batteries in order to prevent damage due to electrolyte leakage.

HANDLING A DISC

Always protect a disc against scratches, soil and dust etc. We recommend that the discs should be stored in the original case during non-use periods.

Bear in mind the following points, since any dirt, scratches or warping of the disc can cause broken or intermittent sound and also noise.



- When holding the discs, take care not to touch the playing surface.
- Store the discs in their cases. Return them to their cases with the label surface facing up and push down lightly on the label surface.
- Do not place discs near a heating device or a place where the temperature is high or in dusty areas.
- Do not write on the label surface using a ballpoint pen and do not stick labels on the CD.
- Wipe away any fingerprints or dust on the playing surface of a disc using a soft cloth.

Bear in mind the following points:

- Always wipe from the inside toward the outside of the disc.
- Never in a circular motion.
- Do not use conventional record cleaners, anti-static agents, benzene, thinner or other solvents.

USEFUL ADVICE BEFORE REQUIRING SERVICE SUPPORT

Many of the problems are probably caused by improper adjustments of the product or by simple problems. Before contacting your Service Centre for help, check the following table.

PROBLEM	CAUSE AND REMEDY
GENERAL	
No Power Supply	- Check that the power cord is properly connected to wall out.
No Audio	- Adjust the volume. - You have not connected the speaker boxes; plug the main unit speaker terminals.
Evident Audio Disturbances	- Your Hi-Fi system is too close to a TV set or a VCR; move away from the TV set or the VCR.
RADIO RECEPTION	
The FM Stereo Indicator Blinks.	- Rotate the set and extend the FM Antenna.
Evident Audio Disturbance.	- Rotate the set and extend the FM Antenna.
CD OPERATION	
The CD Compartment does not close	- The disc is not placed correctly in its compartment.
The Playback does not start	- The CD is dirty. - The CD was placed wrongly. - The pause mode was activated. - Inside the CD player some moisture condensation occurred; leave the unit in a warm room for one or two hours.
No Audio During Playback	- The CD surface is dirty or scratched.

If after checking this table the unit fails to operate normally. Consult the nearest Authorized Service centre.

CARE AND MAINTENANCE

Precautions

1. Always turn OFF the unit after use;
2. Keep the unit away from magnetic objects, water or any heat sources;
3. Use a clean soft moist cloth to clean the unit's cabinet. Do not use chemical cleaners that could damage the finishing of the unit;
4. Never touch the CD pickup lens. If fingerprints get on the pickup lens, use a commercial lens cleaner.
5. Disconnect the unit from any power sources before starting the cleaning operation.

SPECIFICATION

CD SECTION

Channels: 2 channels
Pick up light source: semiconductor laser

RADIO SECTION

Frequency range: AM 520 - 1710 KHz
FM 87.5 - 108 MHz
Antenna: FM antenna wire

GENERAL

Power output 2W + 2W
Power consumption 15W
Power source AC 120V ~ 60Hz

Specifications are subject to change without further notice.

FOR ADDITIONAL SET-UP OR OPERATING ASSISTANCE, PLEASE VISIT OUR WEBSITE AT WWW.MEMOREXELECTRONICS.COM OR CONTACT CUSTOMER SERVICE AT (954) 660-7100

PLEASE KEEP ALL PACKAGING MATERIAL FOR AT LEAST 90 DAYS IN CASE YOU NEED TO RETURN THIS PRODUCT TO YOUR PLACE OF PURCHASE OR MEMOREX.

FOR PARTS AND ACCESSORIES, CONTACT FOX INTERNATIONAL AT 1-800-321-6993

Free Manuals Download Website

<http://myh66.com>

<http://usermanuals.us>

<http://www.somanuals.com>

<http://www.4manuals.cc>

<http://www.manual-lib.com>

<http://www.404manual.com>

<http://www.luxmanual.com>

<http://aubethermostatmanual.com>

Golf course search by state

<http://golfingnear.com>

Email search by domain

<http://emailbydomain.com>

Auto manuals search

<http://auto.somanuals.com>

TV manuals search

<http://tv.somanuals.com>