

## Trouble Shooting:

No picture or sound  
Poor reception

Picture smaller than screen or volume weak even when set on high volume

Picture hard to see at outdoors  
Picture too dark or too light  
Picture weak or fuzzy  
Picture rolls jumping

## Specifications:

### General

Item  
Receiving system(Optional)  
Tuning range  
Antenna input impedance

CRT  
Resolution  
Power source

Power consumption  
Unit dimension  
Net weight  
Gross weight  
Accessories

- Check power source
- Adjust antenna & turn the channel tuner slightly for optimum reception. If using the outdoor antenna please make sure that the antenna adapter pad is plug in properly.
- Power weak, please replace the batteries or check the car battery whether it's in low power or not then to get change if necessary.
- Place in shade to avoid direct sunlight outdoors.
- Adjust Brightness control
- Adjust Contrast control
- Adjust Vertical hold control

- 5" Black & White TV
- NTSC-M or CCIR B/G or I or OIRT D/K or KI or SECAML
- VHF/UHF
- 75 $\Omega$  telescopic antenna/  
300 $\Omega$  external antenna (use antenna pad) (optional)
- 5" Diagonal 20 $\emptyset$  Neck, 70° deflection
- More than 280 lines
- 10 pcs x UM-2 or C size batteries (not included) and AC adapter or cigarette lighter adapter.
- <12W
- 290(W) x 180(H) x 230(D) mm
- 2.5Kg
- 2.9Kg
- Cigarette lighter adapter, AC adapter & External antenna adapter

**NOTE:** Specifications are subject to change without notice.

"FOR ADDITIONAL SET UP OR OPERATING ASSISTANCE, PLEASE CONTACT CUSTOMER SERVICE AT (954)660-7100. PLEASE KEEP ALL PACKAGING MATERIAL FOR AT LEAST 90 DAYS IN CASE YOU NEED TO RETURN THIS PRODUCT TO PLACE OF PURCHASE. FOR PARTS AND ACCESSORIES, CONTACT FOX INTERNATIONAL AT 1-800-321-6993"

# TV RADIO CD PLAYER

## INSTRUCTION MANUAL

 **Vextra**

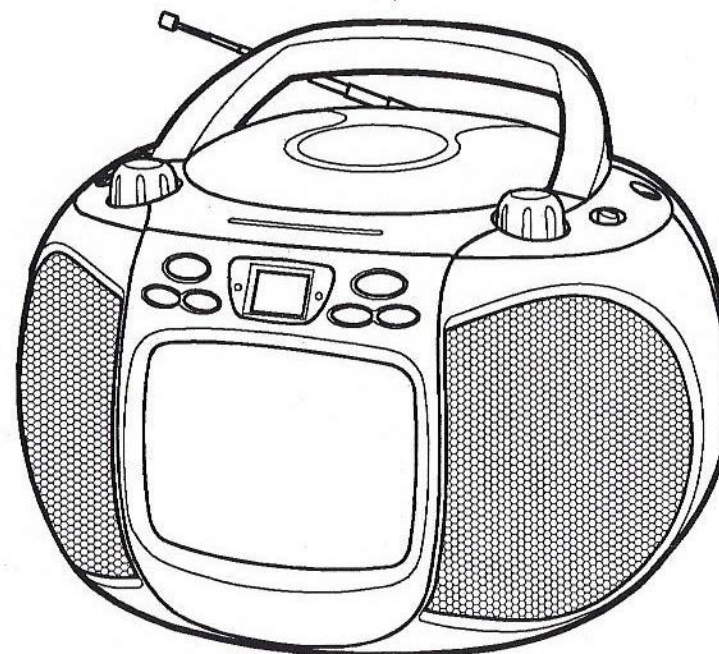

**MODEL NO. VX339**

- 5" B/W TELEVISION
- AM/FM RADIO
- EARPHONES JACK
- DC INPUT JACK
- USES 10 "C" SIZE BATTERIES (Not Included)



The lightning flash with arrowhead symbol, inside the equilateral triangle, is intended to alert the user to the presence of uninsulated DANGEROUS VOLTAGE within the products enclosure that may be of sufficient magnitude to constitute a risk of electric shock to persons.



The exclamation point with an equilateral triangle is intended to alert the user to the presence of important operating and maintenance (servicing) instructions in the literature accompanying the appliance.

### IMPORTANT SAFETY INSTRUCTIONS

**PLEASE READ AND OBSERVE ALL WARNINGS AND INSTRUCTIONS LISTED BELOW WHICH RETAIN THIS MANUAL FOR REFERENCE.**

This unit has been engineered and manufactured to assure you personal safety. However, improper use can potentially result in electrical shock or fire hazard. In order not to defeat the safeguards incorporated into this unit, observe all the following basic rules for installation, use and servicing.

- Your unit is fully electronic and does not have any user-serviceable parts. Hence, **DON'T REMOVE THE CABINET COVER OF THIS UNIT IN WHICH MAY EXPOSE YOU TO DANGEROUS VOLTAGES.** Please refer all servicing to a qualified service technician.
- After unpacking the unit, check it carefully for possible damage. If any is found, do not insert batteries or plug it into an outlet of your unit.
- This unit should only be operated on the following power source:
  - 1.5V x 10 pcs. of UM-2 or C size batteries.
  - AC adapter for DC 12V.
  - Cigarette lighter socket of motor vehicle with a 12V DC, negative ground battery system.

**IMPORTANT:** If you are not certain your vehicle operates on a 12V DC negative ground system, please consult the vehicle manual.
- Use only AC and DC adaptors included with your unit. Others adaptors with wrong specifications may damage your set.
- This plug will fit into the power outlet only one way. This is designed as a safety feature. If you are unable to insert the plug should still fail to fit, please contact your electrician to replace the obsolete outlet. Do not attempt to defeat the safety purpose of the polarized plug by forcing it to prevent your unit from overheating. This will only damage your adapter and outlet.
- Don't use power cords or plugs that have been damaged or frayed.
- Slot at the both sides of the cabinet are provided for ventilation. To prevent your unit from overheating, please do not block or cover these openings.
  - Don't cover the unit with a cloth or other material.
  - Don't allow drapes or curtains to block ventilation grilles.
  - Don't block these grilles by nestling the unit on a bed, sofa, rug, blanket or similar surface.
  - Don't place the unit near or above a radiator heat register.
  - Don't place the unit in an enclosed space - a bookcase for instance - unless proper ventilation is provided.

### TV Operation:

- Press the Power Button to turn on the unit and the Power LED will light.
- Slide the Function Switch to "TV" position.
- Select the desired channel by switching the Band Switch.
- Adjust the Volume Control to a desired level.
- Use the Tuning Control to tune a desired broadcast station.
- If the picture is too bright or too dark, please adjust the Brightness Control & Contrast Control for better reception if necessary.
- If the picture is rolling up and down, please adjust the Vertical Control.
- After using the unit, press the Power Button to turn off the unit.

### Radio Operation:

- Press the Power Button to turn on the unit and the Power LED will light.
- Slide Function Switch to "RADIO" position.
- Slide the Band Switch to a desired band.
- Tune a desired radio broadcast station by using the Tuning Control.
- Adjust the Volume Control to a desired level.
- After using the unit, press the Power Button to turn off the unit.

### Antenna:

The antenna is a telescopic type. For best reception extend the antenna fully.

**NOTE:** To avoid damaging the antenna, always collapse it one section at a time starting with the largest diameter first. Do not push on the antenna from the top or it may buckle or bend.

### External TV Antenna:

In some areas where the reception is weak or affected by local interference, it is better to connect an external antenna (not included) to get better reception. You will need an adapter pad (not included) to connect an external antenna.

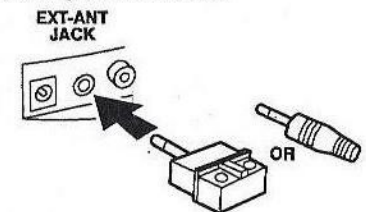

### Earphones Jack:

Insert earphones plug into the Earphones Jack for private listening (earphones not included).

**NOTE:** The speakers will not operate when earphones are connected.

### CD Playback:

- Press the Power Button to turn on the unit and the Power LED will light.
- Set the Function Switch to "CD" position.
- Press the CD door open area to open the CD Door.
- Insert a disc with the label side facing up.
- Close the CD door. The CD LED will display track number 1 and playback will begin automatically.
- Press the Pause/Play button during playback, the CD will pause and the CD LED will flash.
- Press the Stop Button to stop playback, then the total tracks of the disc will be shown on the CD Display and the CD Play LED will off.

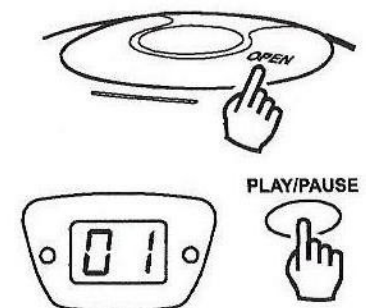

### To Skip Track:

Press either one of the F.R. NP Button or F.F. NP Button according to the desired skip direction.

- When the F.R. NP Button is pressed once during playback, the previous track starts again.
- When the F.F. NP Button is pressed once during playback, the next track plays.



### Repeat Playback:

This function allows a single track or all tracks on a disc to be played repeatedly.

- Press the PROGRAM/REPEAT button once to continuously playback a single track. The Repeat LED will light.
- Press the PROGRAM/REPEAT twice during playback to repeat the entire disc again. The Repeat LED will flash.
- Press the PROGRAM/REPEAT three times to cancel the REPEAT function.

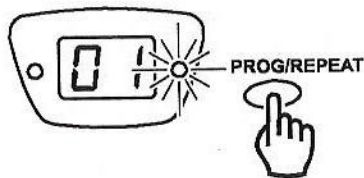

### Program Function:

- Press the Stop Button.
- Press the Program/Repeat Button. The CD Display will show "00".
- Press the F.R. NP Button or F.F. NP button to select the track number.
- Press the Program/Repeat Button again to enter the track number.
- Repeat steps 2 and 3 to program other tracks till finish.
- Press the Play/Pause Button to start the programmed play.

**NOTE:** Program function just is up to 10 memory tracks ("00" to "09"). If over 10 memory tracks, the unit has not any response.

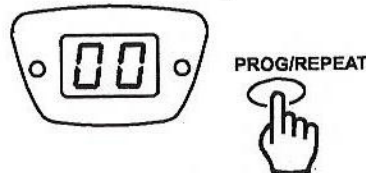

### Random Play:

- Press the Random Button. The CD disc will play randomly.
- Press the F.R. NP Button or F.F. NP Button to select the track randomly.

**Warning:** Should the CD Door be opened, before the CD is read completely, a jamming noise may occur. This can be resolved by closing the CD Door.

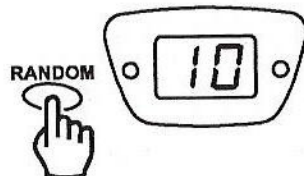

### AV Input:

To watch videos on the TV screen use a cable(not included) to connect the plugs from Audio In and Video In on the unit, to a VCR output.

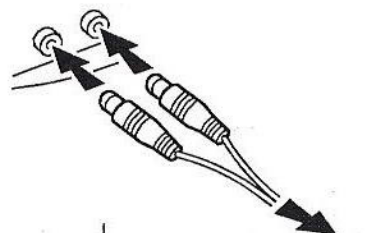

### Audio Output:

Use a cable(not included) to connect the plugs from the Audio L- and R- out on the unit to the amplifier.

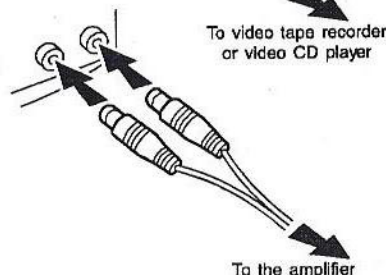

8. Don't push objects of any kind through the ventilation slots into the sides of the unit. This could result in shock from contact with dangerous voltage points, shorting out of parts of fire hazard.
9. Don't place glasses or containers filled with liquid on top of the unit. Liquid spilled into the set could severely damage the unit and cause electrical shock.
10. Do not expose the unit to rain or moisture. Don't use in or near water area (such as bathtub, sink, pool, wet basement, etc.).
11. Don't expose the unit to direct, intense sunlight. If using out doors, keep it shaded to prevent interior heat build up.
12. Before cleaning the unit, always unplug it from the wall outlet. Do not apply liquid or aerosol cleaners which instead to use a soft & dry cloth.
13. If an outside antenna is going to be attached to this unit, make certain the antenna system is properly set up and grounded for protection against voltage surges and built up static charges.
14. An Outdoor antenna system should not be located in the vicinity of overhead power lines, electric lights or power circuits, nor where the antenna can fall into such power lines or circuits. When installing an outdoor antenna system, take extreme care not to touch power lines or circuits as contact with them could prove fatal.
15. For protection during lightning storms or when the unit is left unused for long periods, unplug the set from the wall outlet, disconnect it from the antenna, and of remove the batteries. These measures will prevent damage to the unit from lightning. Power surges and battery acid leakage.
16. If using the indoor antenna (the one attached to the set), don't let any part of it to touch other electrical equipment, metals parts on a lamp, audio components etc.
17. Don't place your unit on an unstable cart, stand, shelf or table. A serious injury to individuals and damage to the unit may result if it's falling, please place the unit on flat, secure surfaces only.
18. Avoid exposing the unit to dust, shock or vibration.
19. Don't add accessories (speakers, headphone, etc.) that have not been specifically designed for this unit.
20. Don't overload wall outlets and extension cords as this can result in fire, electric shock or blown fuses.
21. Don't allow anything to rest on power cords if they are used with this unit. Do not locate the unit in a place where passerby will step or trip on these cords.
22. Unplug the unit from the wall outlet, and refer it to a qualified service technician under any of the following conditions:
  - a) Liquid has been spilled into the unit.
  - b) The unit has been exposed to rain or water.
  - c) The unit has been dropped or damaged.
  - d) The unit exhibits erratic changes in performance.
  - e) The unit does not operate normally.
23. Don't attempt to make any adjustments other than the normal operating procedures described in this manual. Do not unscrew panels on unit or attempt any repairs yourself. It is necessary to refer all servicing to qualified personnel only.

**Location of Controls:**

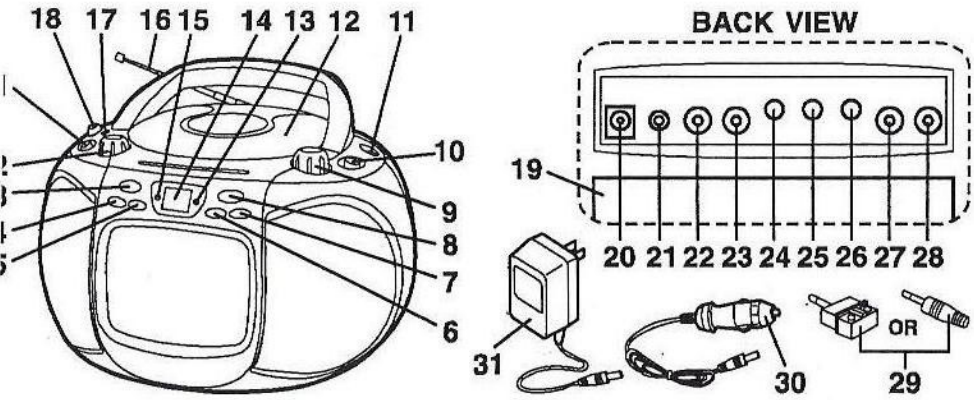

- |                          |                     |                               |
|--------------------------|---------------------|-------------------------------|
| 1. FUNCTION SWITCH       | 11. EARPHONES JACK  | 21. EXTERNAL ANT. JACK        |
| 2. VOLUME CONTROL        | 12. CD DOOR         | 22. AUDIO IN JACK             |
| 3. STOP BUTTON           | 13. REPEAT LED      | 23. VIDEO IN JACK             |
| 4. F.R. NP BUTTON        | 14. CD DISPLAY      | 24. VERTICAL HOLD CONTROL     |
| 5. RANDOM BUTTON         | 15. CD PLAY LED     | 25. BRIGHTNESS CONTROL        |
| 6. PROGRAM/REPEAT BUTTON | 16. ROD ANTENNA     | 26. CONTRAST CONTROL          |
| 7. F.F. NP BUTTON        | 17. POWER LED       | 27. AUDIO L-OUT JACK          |
| 8. PLAY/PAUSE BUTTON     | 18. POWER BUTTON    | 28. AUDIO R-OUT JACK          |
| 9. TUNING CONTROL        | 19. BATTERY DOOR    | 29. EXTERNAL ANT. ADAPTER     |
| 10. BAND SWITCH          | 20. DC ADAPTER JACK | 30. CIGARETTE LIGHTER ADAPTER |
|                          |                     | 31. AC ADAPTER                |

**Battery Installation:**

Press and pull outwards to open the door (1). Insert 10 "C" 1.5V UM-2) (not included) batteries (alkaline batteries are recommended) into the battery compartment (2). Be sure the polarity (+ and -) matches, as marked inside the battery compartment.

**NOTE:** ● Weak or dead batteries may leak or corrode the set. Always remove batteries when the set will not be used for a long period of time.

- Do not mix old and new batteries.
- Please throw the dead batteries into garbage can.

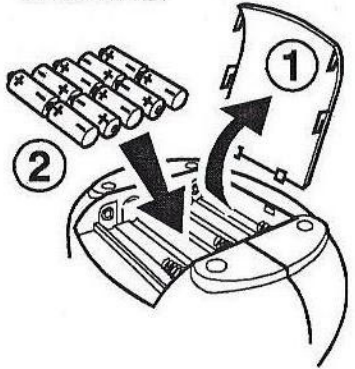

**DC Jack:**

**For AC Adapter**  
Insert the AC adapter plug into the DC 12V Adapter Jack and plug the other end into an AC wall socket.

**For Cigarette Lighter Adapter**  
Insert the cigarette lighter adapter plug into the DC 12V Adapter Jack and plug the other end into a car cigarette lighter socket.

**NOTE:** If an abnormal display indication or an operating problem occurs, disconnect the adapters or remove the batteries, wait for at least 5 seconds, then reconnect the adapters or reinstall the batteries.

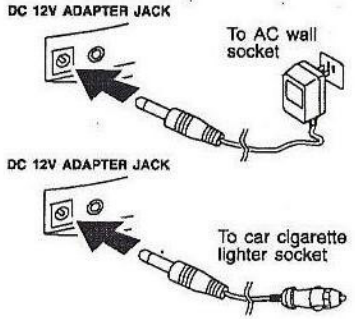

**Cleaning Discs:**

Fingerprints should be carefully wiped from the surface of disc with a soft cloth. To compact discs have no grooves to collect dust and microscopic dirt, so gently wiping them with a soft cloth could remove most particles. Wipe in a straight motion from the center to the edge.

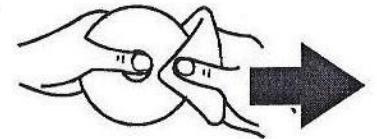

**Cleaning CD Lens:**

If the CD lens is dusty, clean it with a rushblower. Blow several times on the lens and remove the dust with the brush. Fingerprints may be removed with a cotton swab moistened with alcohol.

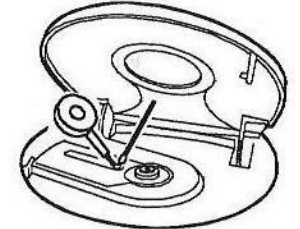

**Cleaning Unit:**

Never use thinner, benzene, record cleaner or anti-static spray on a compact disc. Such chemicals can damage its plastic surface.

## Free Manuals Download Website

<http://myh66.com>

<http://usermanuals.us>

<http://www.somanuals.com>

<http://www.4manuals.cc>

<http://www.manual-lib.com>

<http://www.404manual.com>

<http://www.luxmanual.com>

<http://aubethermostatmanual.com>

Golf course search by state

<http://golfingnear.com>

Email search by domain

<http://emailbydomain.com>

Auto manuals search

<http://auto.somanuals.com>

TV manuals search

<http://tv.somanuals.com>