

Memorex® INSTRUCTION MANUAL ENGLISH

COLOR TELEVISION MT1130C

FEATURES

- On-Screen graphics guide you through setup features and operations.
- Automatic programming of channels allows easy selection of stations available in your viewing area.
- Sleep timer programs the TV to turn itself off at a preset time.
- One day timer programs the TV to come on once at a preset time.
- Weekly timer programs the TV to come on at a preset time every day.
- 25 button infrared remote control allows remote operation.
- VHF/UHF/CATV tuning allows reception of standard broadcasts or cable TV channels.
- Close caption decoder displays captions or half-screen text.
- V-BLOCK function.

SPECIFICATIONS

AC Power Input	120 V, 60 Hz
AC Power Consumption	77 Watts
Chassis Construction	IC Solid State
Picture Tube (measured diagonally)	13"
Speaker	3.5 x 2 in (90 x 50 mm) Oval, 8 ohm
Tuner	161 Channel, Freq. Synthesized
Remote Control	Infrared, Direct Access 2 x AA batteries
Receiving Channels	VHF 2-13 UHF 14-69
CATV:	
Mid Band	14-22
Super Band	23-36
Hyper Band	37-65
Ultra Band	66-94, 100-125
Sub Mid Band	1, 95-99
Antenna Input Impedance	75 ohm (VHF/UHF) Coaxial Input



As an ENERGY STAR® Partner, MEMOCORP has determined that this product meets the ENERGY STAR® guidelines for energy efficiency.

CAUTION

- Place your TV in a room with adequate ventilation.
- Keep your TV set away from sources of direct heat, such as heat registers or direct sunlight.
- Do not place your TV on soft surfaces, such as rugs or blankets.
- Leave enough room for air to circulate around the bottom, top and back of the set.
- Your TV works on normal household current (120 volts, 60 Hz). For safety purpose, your TV's electrical plug has one blade wider than the other. If you cannot insert the plug fully into the socket, try reversing it.

In the space provided, record the serial and model numbers, located on the rear of the unit.

SERIAL NO. _____ MODEL NO. _____

WARNING:
TO REDUCE THE RISK OF FIRE OR ELECTRIC SHOCK, DO NOT EXPOSE THIS APPLIANCE TO RAIN OR MOISTURE.

CAUTION
RISK OF ELECTRIC SHOCK
DO NOT OPEN

CAUTION: TO REDUCE THE RISK OF ELECTRIC SHOCK, DO NOT REMOVE COVER (OR BACK). NO USER SERVICEABLE PARTS INSIDE. REFER SERVICING TO QUALIFIED SERVICE PERSONNEL.

The lightning flash with the arrowhead symbol within an equilateral triangle, is intended to alert the user to the presence of unshielded "dangerous voltage" within the product's enclosure that may be of sufficient magnitude to constitute a risk of electric shock to someone.

The exclamation point within an equilateral triangle is intended to alert the user to the presence of important operating and maintenance (servicing) instructions in the literature accompanying the appliance.

PRINTED IN MALAYSIA
1111-4030M178 MP0108-1

IMPORTANT SAFEGUARDS

- Read Instructions** - All the safety and operating instructions should be read before the TV is started.
- Retain Instructions** - The safety and operating instructions should be retained for future reference.
- Heed Warnings** - All warnings on the TV and in the operating instructions should be adhered to.
- Follow Instructions** - All operating and use instructions should be followed.
- Cleaning** - Unplug TV from the wall outlet before cleaning. Do not use liquid cleaners or aerosol cleaners. Use a damp cloth for cleaning.
- Attachments** - Do not use attachments not recommended by the TV manufacturer as they may cause hazards.
- Water and Moisture** - Do not use this TV near water - for example, near a bath tub, wash bowl, kitchen sink, or laundry tub; in a wet basement; or near a swimming pool; and the like.
- Accessories** - Do not place this TV on an unstable cart, stand, tripod, bracket, or table. The TV may fall, causing serious injury to someone and serious damage to the TV. Use only with a cart, stand, tripod, bracket, or table recommended by the manufacturer, or sold with the TV.
- Any mounting of the TV should follow the manufacturer's instructions, and should use a mounting accessory recommended by the manufacturer.**
- The TV and cart combination should be moved with care. Quick stops, excessive force, and uneven surfaces may cause the TV and cart combination to overturn.
- Ventilation** - Slots and openings in the cabinet are provided for ventilation and to ensure reliable operation of the TV and to protect it from overheating, and these openings must not be blocked or covered. The openings should never be blocked by placing the TV on a bed, sofa, rug, or other similar surface. This TV should not be placed in a built-in installation such as a bookcase or rack unless proper ventilation is provided or the manufacturer's instructions have been adhered to.
- Power Sources** - This TV should be operated only from the type of power source indicated on the marking label. If you are not sure of the type of power supply to your home, consult your TV dealer or local power company. For TVs intended to operate from battery power, or other sources, refer to the operating instructions.
- Grounding or Polarization** - This TV may be equipped with a polarized alternating current line plug (a plug having one blade wider than the other). This plug will fit into the power outlet only one way. This is a safety feature. If you are unable to insert the plug fully into the outlet, try reversing the plug. If the plug should still fail to fit, contact your electrician to replace your obsolete outlet. Do not defeat the safety purpose of the polarized plug.
- Power-Cord Protection** - Power-supply cords should be routed so that they are not likely to be walked on or pinched by items placed upon or against them, paying particular attention to cords at plugs, convenience receptacles, and the point where they exit from the TV.
- Outdoor Antenna Grounding** - If an outside antenna or cable system is connected to the TV, be sure the antenna or cable system is grounded so as to provide some protection against voltage surges and built-up static charges. Article 810 of the National Electrical Code ANS/NFPA 70, provides information with regard to proper grounding of the mast and supporting structure, grounding of the lead-in wire to an antenna-discharge unit, size of grounding conductors, location of antenna-discharge unit, connection to grounding electrodes and requirements for the grounding electrode. See Figure 1.



- Lightning** - For added protection of this TV during a lightning storm, or when it is left unattended and unused for long periods of time, unplug it from the wall outlet and disconnect the antenna or cable system. This will prevent damage to the TV due to lightning and power-line surges.
- Power Lines** - An outside antenna system should not be located in the vicinity of overhead power lines or other electric light or power circuits, or where it can fall into such power lines or circuits. Never touch power lines or circuits or objects that come in contact with them. Never touch power lines or circuits or objects that come in contact with them. Never touch power lines or circuits or objects that come in contact with them.
- Overloading** - Do not overload wall outlets, extension cords, or integral convenience receptacles as this can result in a risk of fire or electric shock.
- Object and Liquid Entry** - Never push objects of any kind into this TV through openings as they may touch dangerous voltage points or short-out parts that could result in a fire or electric shock. Never spill liquid of any kind on the TV.
- Servicing** - Do not attempt to service this TV yourself as opening and removing covers may expose you to dangerous voltage or other hazards. Refer all servicing to qualified service personnel.
- Damage Requiring Service** - Unplug this TV from the wall outlet and refer servicing to qualified service personnel under the following conditions:
 - When the power-supply cord or plug is damaged.
 - If liquid has been spilled, or objects have fallen into the TV.
 - If the TV has been exposed to rain or water.
 - If the TV does not operate normally by following the operating instructions. Adjust only those controls that are covered by the operating instructions as an improper adjustment of those controls may result in damage and will often require extensive work by a qualified technician to restore the TV to its normal operation.
 - If the TV has been dropped or damaged in any way.
 - If the TV exhibits a distinct change in performance - this indicates a need for service.
- Replacement Parts** - When replacement parts are required, be sure the service technician has used replacement parts specified by the manufacturer or have the same characteristics as the original part. Unauthorized substitutions may result in fire, electric shock, or other hazards.
- Safety Check** - Upon completion of any service or repairs to this TV, ask the service technician to perform safety checks to determine that the TV is in proper operating condition.
- Wall or Ceiling Mounting** - The TV should be mounted to a wall or ceiling only as recommended by the manufacturer.
- Heat** - The TV should be situated away from heat sources such as radiators, heat registers, stoves, or other products (including amplifiers) that produce heat.

Note to CATV system installer:

This reminder is provided to call the CATV system installer's attention to Section 820-40 of the NEC which provides guidelines for proper grounding and, in particular, specifies that the cable ground shall be connected to the grounding system of the building, as close to the point of cable entry as practical.

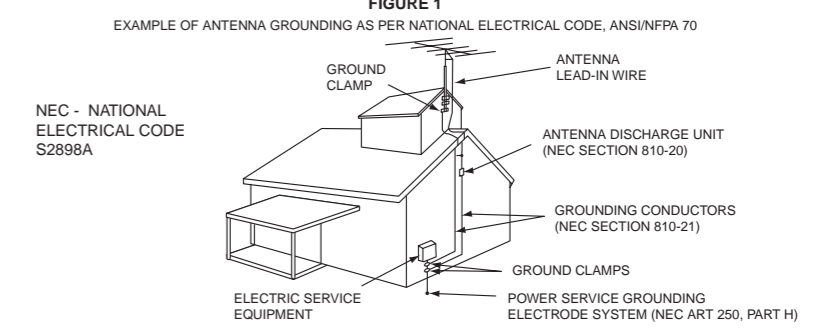

ANTENNA CONNECTIONS

COMBINATION VHF/UHF ANTENNA (Single 75 ohm cable or 300 ohm twin-lead wire)

Connect the 75 ohm cable from combination VHF/UHF antenna to the antenna jack. If your combination antenna has a 300 ohm twin-lead wire, use the 300-75 ohm matching transformer (not included).

To prevent problems it is recommended that you use only the specified transformer. (Transformer Part No.: 1398-00301) (USA only)

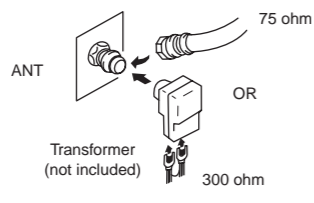

CATV CONNECTIONS

For Subscribers to Basic Cable Service:

For basic cable service without a converter/descrambler box, connect the CATV 75 ohm coaxial cable directly to the antenna jack on the rear of the TV.

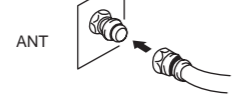

Some cable companies offer "premium pay" channels in which the signal is scrambled. Descrambling these signals for normal viewing requires the use of a descrambler device which is generally provided by the cable company. Below are illustrations for connection of these types of converter/descrambler devices with the TV's VHF antenna jack.

For Subscribers to Scrambled Cable Service:

To allow viewing of all channels through converter/descrambler, TV must be set to the output channel of the converter/descrambler (usually ch 3 or 4).



For Subscribers to Unscrambled Basic Cable with Scrambled Premium Channels:

You may need to use a two-set signal splitter (sometimes called a "two-set coupler") and an A/B switch box from the cable installer or an electronics supply store. With the A/B switch in "B" position you can directly tune to any non-scrambled channels using your TV's tuning system or remote control. With the switch in "A" position, you can tune your TV to the output channel of the decoder (usually CH 3 or 4) and use the box to tune scrambled channels. Since cable systems vary, you may wish to consult your local cable company.

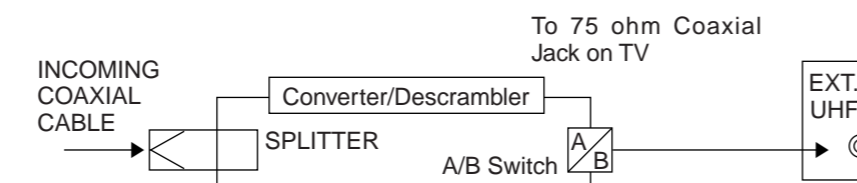

OPERATING CONTROLS AND FUNCTIONS

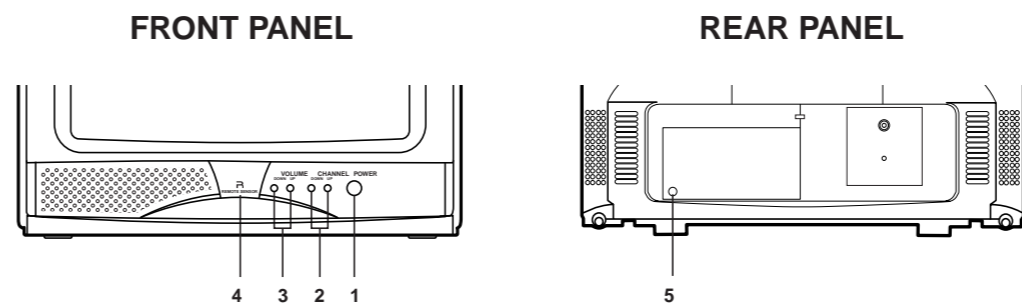

- POWER SWITCH
- CHANNEL UP/DOWN BUTTON
- VOLUME UP/DOWN BUTTON
- REMOTE CONTROL SENSOR
- VHF/UHF EXT. ANT. JACK (REAR OF SET)

REMOTE CONTROL

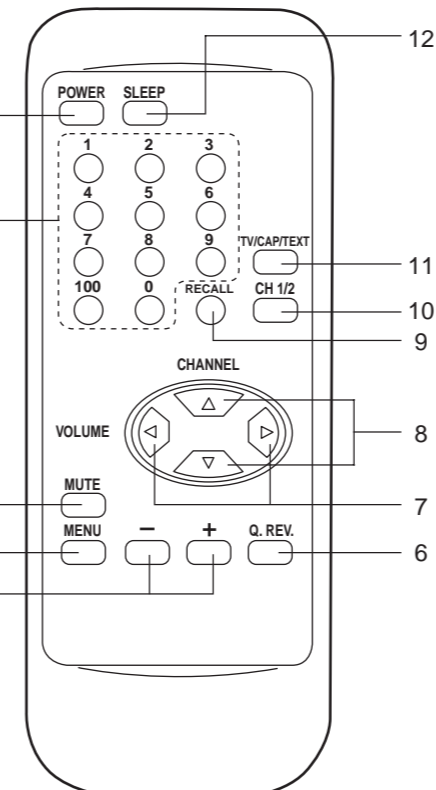

- The remote control unit requires two 1.5 volt "AA" size batteries. The battery compartment is located on the back of the unit. To open, press down on the lid and slide toward the bottom of the unit. Install the batteries exactly as shown by the diagram in the compartment.
- If one or both of the batteries are reversed, the REMOTE CONTROL will not operate and the unit may be damaged.
- Do not allow strong sunshine to fall on the TV set front panel as this may affect the operation of the remote control.

- POWER BUTTON** - Press to turn the TV on or off.
- NUMBER BUTTONS** - Press to select a channel. For channels 1-9, press 0, then the channel you want to watch. For example, for channel 6, press 0, 6. For channels 100-125, press the 100 button, then press the last two digits of the channel you want to watch. For example, for channel 116, press 100, 1, 6. Note: Make sure you press the second or third digit of a channel within a few seconds of pressing the first digit. If you don't, you'll have to start over.
- MUTE BUTTON** - Press once to eliminate sound. Press again to restore sound.
- MENU BUTTON** - Press to call up the main menu screen. Also, press to enter data when going to the next step of an operation.
- AND + BUTTONS** - Press to adjust or select functions listed in on-screen displays.
- Q. REV. (QUICK REVIEW) BUTTON** - Press to return to the previous channel. For example, if you were watching channel 2, then use the Number buttons to switch to channel 6, pressing the Q. REV button will return the TV to channel 2.
- VOLUME (UP/DOWN) BUTTONS** - Press to raise or lower the sound.
- CHANNEL (UP/DOWN) BUTTONS** - Press to scroll up or down through the channels.
- RECALL BUTTON** - Press to display the channel being viewed. Press again to display the time. Press again to remove the on-screen display. Note: If the RECALL button is pressed when the TV is in closed caption mode, captions or text will not be displayed.
- CH1/CH2 BUTTON** - Switches between channel 1 and channel 2 of the closed caption mode.
- TV/CAP(tion)/TEXT BUTTON** - When you are watching a closed caption program, press this button to switch between the standard TV screen, closed captioning and half-screen text.
- SLEEP BUTTON** - Press to start the sleep time or to display the time left in a sleep timer.

TV OPERATIONS SET UP

SETTING LANGUAGE

The menu screen can be programmed to appear in English, French or Spanish as procedure below:

- Press MENU to display main menu.
- Select (+) or (-) until LANGUAGE, press MENU to select the desired language.
- Select (+) or (-) until EXIT, press MENU to exit.

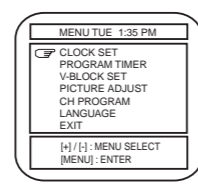

SETTING THE CLOCK

- Press MENU twice until CLOCK SET screen.
- Set the correct day, hour(s), minute(s) and AM/PM for the CLOCK using (+) or (-) and press MENU after each entry to go to the next step.
- While EXIT is flashing, press (+) or (-) to exit.

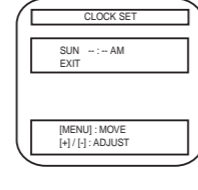

You may have to reset the clock if there is a power outage or if you unplug the TV. To correct day or time, repeat step 1, press MENU repeatedly until the desired item is flashing, make correction using (+) or (-). Finally press MENU until EXIT flashing and press (+) or (-) to exit.

PROGRAMMING CHANNELS

Automatic Programming

- Press MENU to display main menu.
- Select (+) or (-) until CH Program, press MENU.
- Press MENU until the mode (AIR or CABLE) that corresponds to your TV signal system appears beside AIR/CABLE.
- Select (+) or (-) until AUTOSEARCH, press MENU to start it. The TV will automatically cycle through all the TV or CABLE channel depending on the mode selected, and store active channel in its memory. When complete, the CH PROGRAM screen will re-appear on-screen.
- Select (+) or (-) until CH Program, press MENU to exit.

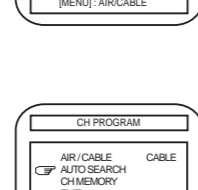
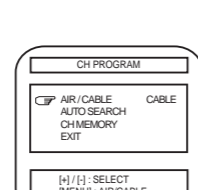
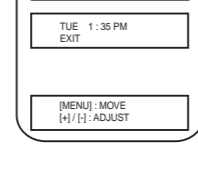

To stop automatic programming while it is in progress, press MENU.

Manual Programming (Add/Delete Channels)

- Press MENU to display main menu.
- Select (+) or (-) until CH PROGRAM, press MENU.
- Select (+) or (-) until CH MEMORY, press MENU.
- Select the desired channels to be added or deleted using either the NUMBER or CHANNEL (▲▼) buttons.
- Press (+) to add (it will turn white) or (-) to delete (it will turn red) the channel.
- Repeat steps 4 and 5 to add or delete other channels.
- Press MENU to return to the CH PROGRAM screen.
- Press MENU to exit while EXIT is highlighted.

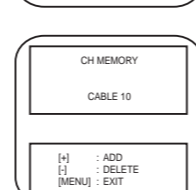
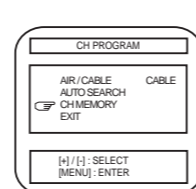
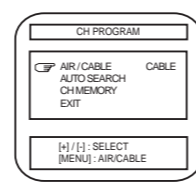

If you don't program channels, you will still receive channels when you press either the CHANNEL (▲▼) or Number buttons. But you will also have to scan through channel that have no reception or very poor reception when you press the CHANNEL (▲▼) buttons.

TIMERS SET UP

One Day Timer

- Press MENU to display main menu.
- Select (+) or (-) until PROGRAM TIMER, press MENU. (Clock time must be set before proceeding this step, go to Setting the Clock)
- While ONE DAY is highlighted, press MENU, the OFF (or ON) beside ONE DAY will flash.
- Select (+) or (-) until ON, press MENU to enter the one day timer screen.
- Set the hour, minute(s) and AM/PM for both ON TIME and OFF TIME using (+) or (-) and press MENU after each entry to go to the next step. (The OFF TIMER changes to exactly three hours after the ON TIME).
- Select the desired channel using either Number, CHANNEL ▲▼ or (+) or (-) buttons then press MENU.
- While EXIT is blinking, press (+) or (-) to exit.

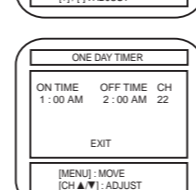
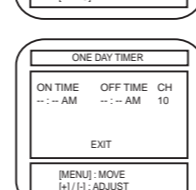
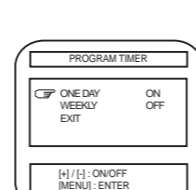

To cancel a timer, follow steps 1 to 3. At step 4, use the (+) or (-) to change the ON to OFF. The one day timer has priority when the same time value is set for the ON TIME field of both the one day timer and the weekly timer. You may have to reprogram the timer if there is a power outage or if the TV is unplugged.

V-BLOCK SETUP

V-Block allow users to program their TV to automatically block an incoming program with certain level of violence, sexual content and strong language based on age, content or both ratings.

V-BLOCK SET UP

- Press MENU to display main menu.
- Select (+) or (-) until V-BLOCK SET, press MENU.
- Use the number buttons to input "0000", (the preset pass number is 0000), then press MENU.
- Press MENU, the OFF (or ON) beside V-BLOCK will flash.
- Select (+) or (-) until ON, press MENU.
- Select (+) or (-) until EXIT, press MENU to exit.

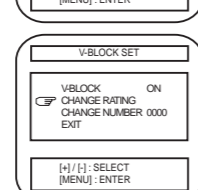
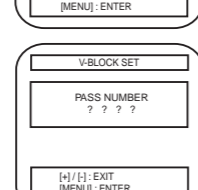
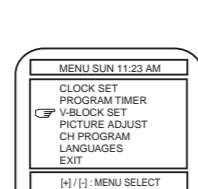

To disable block, set V-BLOCK to OFF. If you turn the TV on for the first time, setting V-BLOCK to ON alone will not enable the block unless you change the preset state for MPA and TV Rating from OFF to any rating. In case you forget the pass number call your nearest Service Centre for assistance.

MPAA RATING SET UP

- Go to V-BLOCK SET menu screen.
- Select (+) or (-) until CHANGE RATING, press MENU.
- While MPA RATING is highlighted, press MENU, the OFF (or any rating) beside MPA RATING will flash.
- Select (+) or (-) until the desired rating, press MENU.
- Select (+) or (-) until EXIT, press MENU to exit.

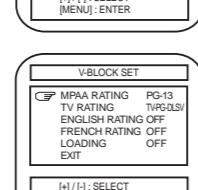
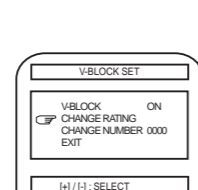

Rating rotates from lower to higher. X is the highest rating.

OFF → G → PG → PG-13 → R → NC-17 → X

All programs with a higher rating than the one selected will automatically be blocked. If you don't want to block MPA RATING, set it to OFF. V-BLOCK is activated only on programs and tapes that have the rating signal and if activated "V-BLOCK" message together with the rating level appears on-screen. The channel blocking will cease if the input source or if the channel is changed.

TV RATING SET UP

- Go to CHANGE RATING sub-menu screen.
- Select (+) or (-) until TV RATING, press MENU.
- Select (+) or (-) until the desired rating appears beside TV RATING, press MENU.

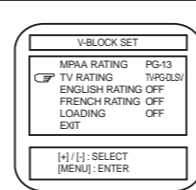

When user select TV-Y7, TV-PG, TV-14 or TV-MA and press MENU, the sub-ratings (content-based rating) will appear beside the selected main rating. User can select either only main rating or combine with the sub-ratings as below:

TV-Y(FV), TV-PG(DSLV), TV-14(DSLV), TV-MA(LSV)

FV : Fantasy Violence
D : Suggestive Dialogue
L : Adult Language
S : Sexual Situation
V : Violence

- In case of sub-rating selection: While the sub-rating is flashing, press (+) or (-) repeatedly to add or delete the sub-ratings (yellow blank indicate delete) then press MENU after each entry.
- Select (+) or (-) until EXIT, press MENU to exit.

Rating rotates from lower to higher. TV-MA is the highest rating.

OFF → TV-Y → TV-Y7 → TV-G → TV-PG → TV-14 → TV-MA

All programs with a higher rating than the one selected will automatically be blocked. If you don't want to block TV RATING, set it OFF. When user select only main rating without any sub-rating then program will be blocked only for main rating, ignoring the sub-rating. But if user select in combination then programs with higher rating plus similar sub-rating than the one selected will automatically be blocked.

CHANGING A PASS NUMBER

- Go to V-BLOCK SET menu screen.
- Select (+) or (-) until CHANGE NUMBER, press MENU, the numbers beside it will flash.
- Input the desire numbers using the Number button, press MENU.
- Press MENU to re-confirm your entry then select exit. To make correction press (+) or (-) and repeat from step 2.
- Select (+) or (-) until EXIT, press MENU to exit.

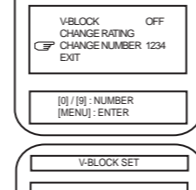
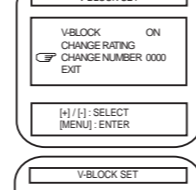
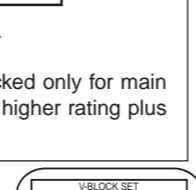

ENGLISH RATING/FRENCH RATING SET UP

This setting is use to receive data service for Canadian English/French Language Rating System in according with EIA-744-A Standard.

- Go to CHANGE RATING sub-menu screen.
- Select (+) or (-) until ENGLISH or FRENCH RATING, press MENU, the OFF (or ON) beside it will flash.
- Select (+) or (-) until ON, press MENU.
- Select (+) or (-) until the desire rating, press MENU, the OFF (or ON) beside it will flash.
- Select (+) or (-) until ON, press MENU.
- Select (+) or (-) until EXIT, press MENU to exit.

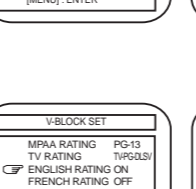
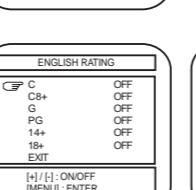
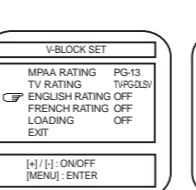

LOADING SET UP

- Go to CHANGE RATING sub-menu screen.
- Select (+) or (-) until LOADING, press MENU, the OFF (or ON) beside it will flash.
- Select (+) or (-) until ON, press MENU.
- Press MENU to exit.

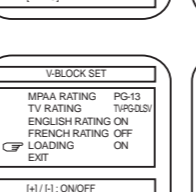
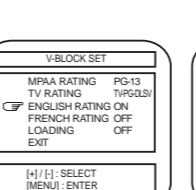

Set ENGLISH or FRENCH RATING to OFF if you don't want to block. With LOADING ON, if you don't want to load any ENGLISH or FRENCH RATING. For threshold rating system if any rating is set to ON then other higher rating will automatically become ON. For individual rating system user can select ON or OFF for each level individually. With LOADING ON, English or French Rating signal is detected, a "PRCC LOADING" message in red will appear on-screen. If there is error in loading, the "PRCC LOADING" message will change color from red to white and data will not load if the channel is change during loading. The current English or French Ratings are automatically overwrite as new data are received.

BEFORE REQUESTING SERVICE

Before requesting service, check the following list of problems and solutions. You may be able to solve the problems yourself.

PROBLEM	SOLUTION
No Power	<ul style="list-style-type: none"> Make sure the unit is plugged in. Unplug the unit from electrical outlet for 60 seconds. Then plug it in and turn it on again.
No Picture	<ul style="list-style-type: none"> Make sure the antenna is properly connected at the back of the TV. Make sure the antenna is not broken. Adjust the brightness and contrast controls.
No Sound	<ul style="list-style-type: none"> Use the VOLUME (Up/Down) buttons to turn up the volume. Make sure the sound is not muted by pressing the MUTE button.
No Color	<ul style="list-style-type: none"> Make sure the show is being transmitted in color by checking to see if another channel is in color. Adjust the color control.
Wrong Color	<ul style="list-style-type: none"> Adjust the color and tint controls.
Picture Too Light/Dark	<ul style="list-style-type: none"> Adjust the brightness and contrast controls.
Picture Interference	<ul style="list-style-type: none"> Check the antenna for shorted or broken wires. Reposition the antenna. Try another channel to make sure there is no station trouble or local interference (such as electric motors). If possible, minimize by adjusting the antenna.
Remote Control Doesn't Work	<ul style="list-style-type: none"> Make sure batteries are inserted in the remote control. Make sure the remote control is aimed directly at the remote sensor on the TV.
Big black box on screen	<ul style="list-style-type: none"> Press the TV/CAP/TEXT button until the CAP or TEXT box disappears from the screen

Free Manuals Download Website

<http://myh66.com>

<http://usermanuals.us>

<http://www.somanuals.com>

<http://www.4manuals.cc>

<http://www.manual-lib.com>

<http://www.404manual.com>

<http://www.luxmanual.com>

<http://aubethermostatmanual.com>

Golf course search by state

<http://golfingnear.com>

Email search by domain

<http://emailbydomain.com>

Auto manuals search

<http://auto.somanuals.com>

TV manuals search

<http://tv.somanuals.com>