



SPECIFICATIONS

Model	MT1132A	MT1192A
AC Power Input:	120V, 60Hz	
AC Power Consumption:	54 Watts	73 Watts
Chassis Construction:	IC Solid state	
Picture Tube:	13" (measured diagonally)	19" (measured diagonally)
Horizontal resolution:	260 lines	
Audio Power Output Rating:	1.0 Watts	1.5 Watts
Speaker:	3" Full Range, 8 ohm	
Tuner Type:	181 Channel, Quartz PLL Frequency Synthesized	
Remote Control:	Infrared, Direct Access, 2 x AAA batteries (not supplied)	
Receiving Channels:	VHF 2-13 UHF 14-69 CATV 01-97 (5A)-(A-3) 98-99 (A-2)-(A-1) 14-22 (A)-(I) 23-36 (J)-(W) 37-65 (AA)-(FFF) 66-125 (GGG)-(125)	
Antenna Input Impedance:	75 Ohm (VHF/UHF/CATV) Coaxial Input	
Input:	Video: 1.0 Vp-p 75 ohm Audio: 300 mV, 47k ohm	
Dimensions:	14-1/4" (W) x 14-3/16" (D) x 12-5/8" (H)	19-3/16" (W) x 18-5/16" (D) x 16-3/8" (H)
Weight:	20.9 lbs	38.6 lbs

ACCESSORIES

Remote Control
Telescopic Antenna (MT1132A only)



FOR ADDITIONAL SET-UP INFORMATION OR CUSTOMER SERVICE
PLEASE CALL:
1-800-919-3647

3J81201A U
01/02

Printed in Thailand

ENGLISH OWNER'S MANUAL

Memorex®

COLOR TELEVISION

MT1132A MT1192A

CAUTION

Changes or modifications not expressly approved by the party responsible for compliance with the FCC Rules could void the user's authority to operate this equipment.

ATTENTION

If you purchase a universal remote control from your local retailer, please contact the remote manufacturer for the required programming code.

TV/CATV MODE SELECTION

When shipped from the factory, the TV/CATV menu option is set to the "CATV" (Cable Television) mode. If not using CATV, set this menu option to "TV" mode.

FEATURES

Quartz PLL Frequency Synthesized Tuning System - Electronically locks in and memorizes available channels for perfect reception.

181 Channel Tuner - The tuning system is capable of receiving all 68 VHF/UHF standard broadcast channels that are available in your area. When operating on a cable system, it can tune to the standard VHF channel frequencies plus up to 113 cable channel frequencies. The actual number of channels received depends upon channel reception in your area or your cable system.

On-Screen 3 Language Display - This TV can display the on screen language in English, Spanish or French.

Picture Adjustments Using The Remote Control - The On-Screen display allows precise remote control adjustment of BRIGHTNESS, COLOR, CONTRAST, SHARPNESS and TINT.

Sleep Timer - Operable from the remote control, this TV can be programmed up to 120 minutes to turn off automatically.

Memory Back Up - This system prevents loss of memorized channel selections in case a power interruption to the TV should occur.

Closed Captioned Decoder - Displays text captions or 1/2 of full screen text on the screen for hearing impaired viewers.

V-Chip - The V-Chip function can read the rating of a TV program or movie content if the program is encoded with this information. V-Chip will allow you to set a restriction level.

ANTENNA/CATV CONNECTIONS

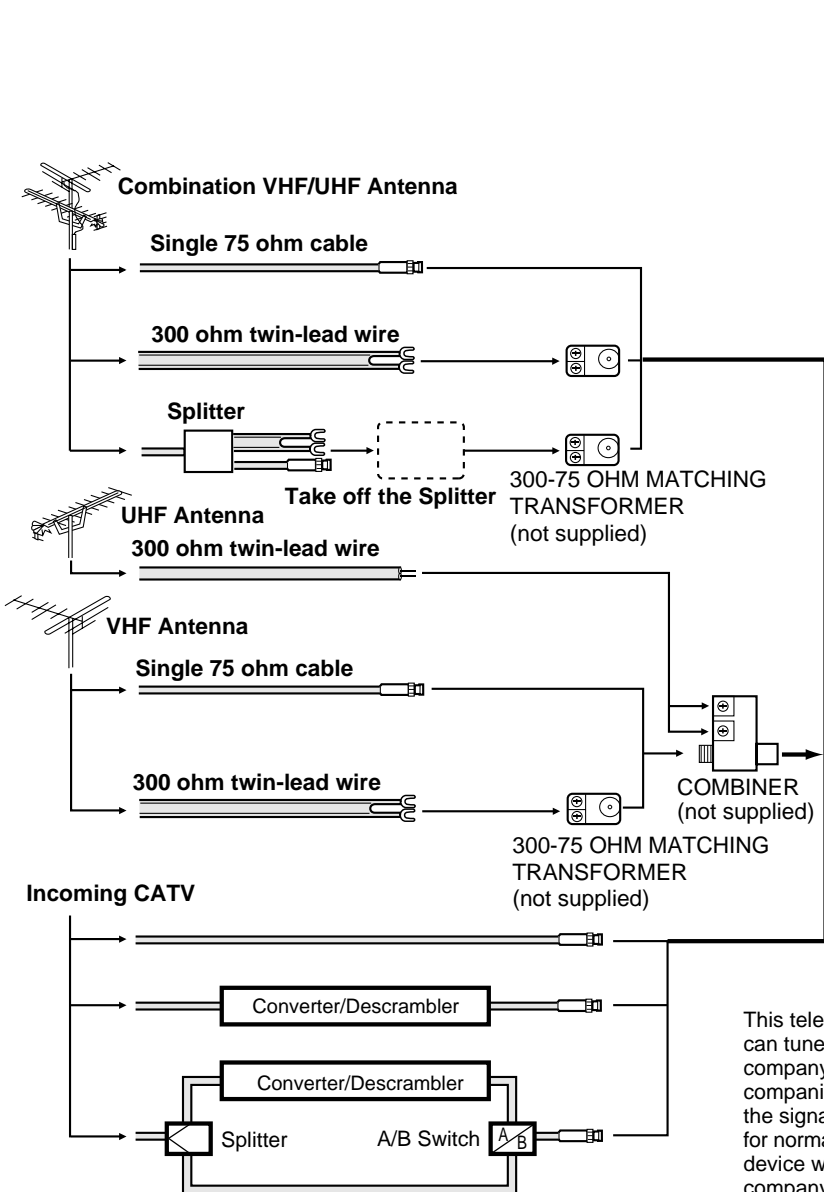

Indoor Antenna

A single pole antenna is supplied with the unit (MT1132A only), insert the antenna holder into the mounting hole on the back of the cabinet until it locks into place. Attach the antenna plug to the antenna jack. Adjust the length and angle of the antenna rod to receive the best possible picture.

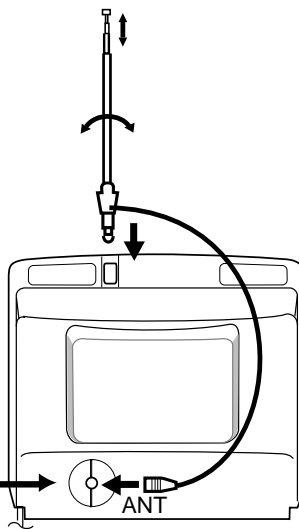

Combination VHF/UHF Antenna (Single 75 ohm cable or 300 ohm twin-lead wire)

Connect the 75 ohm cable from a combination VHF/UHF antenna to the antenna jack. If your combination antenna has a 300 ohm twin-lead wire, use the 300-75 ohm matching transformer (not supplied).

Combination VHF/UHF Antenna (Separate VHF and UHF 300 ohm twin-leads)

Connect the UHF twin-lead wire to a combiner (not supplied). Connect the VHF twin-lead to the 300-75 ohm matching transformer (not supplied). Attach the transformer to the combiner. Attach the combiner to the antenna jack.

Separate VHF/UHF Antennas

Connect the 75 ohm cable from the VHF antenna and the UHF antenna twin-lead to a combiner (not supplied). Attach the combiner to the antenna jack. **NOTE:** If your VHF antenna has a twin-lead wire, use the 300-75 ohm matching transformer (not supplied), then connect the transformer to the combiner.

For Subscribers to Basic Cable TV Service

For basic cable service not requiring a converter/descrambler box, connect the CATV 75 ohm coaxial cable directly to the antenna jack on the back of the television.

For Subscribers to Scrambled Cable TV Service

If you subscribe to a cable service which requires the use of a converter/descrambler box, connect the incoming cable to the converter/descrambler box and connect the output of the box to the antenna jack on the back of the television. Follow the connections shown left. Set the television to the output of the converter/descrambler box (usually channel 3 or 4) and use the converter/descrambler box to select channels.

For Subscribers to Unscrambled Basic Cable with Scrambled Premium Channels

If you subscribe to a cable service in which basic cable channels are unscrambled and premium channels require the use of a converter/descrambler box, you may wish to use a two-set signal splitter (sometimes called a "two-set coupler") and an A/B switch box from the cable installer or an electronics supply store. Follow the connections shown left. With the switch in the "B" position, you can directly tune any unscrambled channels on your TV. With the switch in the "A" position, tune your TV to the output of the converter/descrambler box (usually channel 3 or 4) and use the box to tune scrambled channels.

This television has an extended tuning range and can tune most cable channels without using a cable company supplied converter box. Some cable companies offer "premium pay channels" in which the signal is scrambled. Descrambling these signals for normal viewing requires the use of a descrambler device which is generally provided by the cable company.

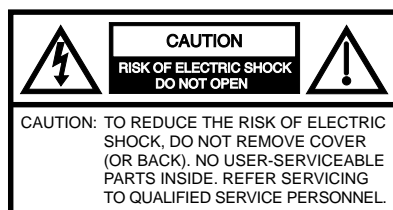

The lightning flash with arrowhead symbol, within an equilateral triangle is intended to alert the user to the presence of uninsulated dangerous voltage within the product's enclosure that may be of sufficient magnitude to constitute a risk of electric shock.

The exclamation point within an equilateral triangle is intended to alert the user to the presence of important operating and maintenance (servicing) instructions in the literature accompanying the appliance.

WARNING: TO PREVENT FIRE OR SHOCK HAZARD, DO NOT EXPOSE THIS APPLIANCE TO RAIN OR MOISTURE.

IMPORTANT SAFEGUARDS

- 1. READ INSTRUCTIONS-** All the safety and operating instructions should be read before the unit is operated.
- 2. RETAIN INSTRUCTIONS-** The safety and operating instructions should be retained for future reference.
- 3. HEED WARNINGS-** All warnings on the unit and in the operating instructions should be adhered to.
- 4. FOLLOW INSTRUCTIONS-** All operating and use instructions should be followed.
- 5. CLEANING-** Unplug this unit from the wall outlet before cleaning. Do not use liquid cleaners or aerosol cleaners. Use a damp cloth for cleaning the exterior cabinet only.
- 6. ATTACHMENTS-** The manufacturer of this unit does not make any recommendations for attachments, as they may cause hazards.
- 7. WATER AND MOISTURE-** Do not use this unit near water. For example, near a bathtub, washbowl, kitchen sink, laundry tub, in a wet basement, or near a swimming pool.
- 8. ACCESSORIES-** Do not place this unit on an unstable cart, stand, tripod, bracket, or table. The unit may fall, causing serious injury, and serious damage to the unit.
- 9. VENTILATION-** Slots and openings in the cabinet back or bottom are provided for ventilation, to ensure reliable operation of the unit and to protect it from overheating. These openings should never be blocked by placing the unit on a bed, sofa, rug, or other similar surface. This unit should never be placed near or over a radiator or heat source. This unit should not be placed in a built-in installation, such as a bookcase, or rack unless proper ventilation is provided or the manufacturer's instructions have been adhered to.
- 10. POWER SOURCE-** This unit should be operated only from the type of power source indicated on the rating plate. If you are not sure of the type of power supply to your home, consult your appliance dealer or local power company. For units intended to operate from battery power, or other sources, refer to the operating instructions.
- 11. GROUNDING OR POLARIZATION-** This unit is equipped with a polarized alternating current line plug (a plug having one blade wider than the other). This plug will fit into the power outlet only one way. This is a safety feature. If you are unable to insert the plug fully into the outlet, try reversing the plug. If the plug still fails to fit, contact your electrician to replace your obsolete outlet. Do not defeat the safety purpose of the polarized plug. If your unit is equipped with a 3-wire grounding-type plug, a plug having a third (grounding) pin, this plug will only fit into a grounding-type power outlet. This too, is a safety feature. If you are unable to insert the plug into the outlet, contact your electrician to replace your obsolete outlet. Do not defeat the safety purpose of the grounding-type plug.
- 8A.** An appliance and cart combination should be moved with care. Quick stops, excessive force, and uneven surfaces may cause the appliance and cart combination to overturn.

PORTABLE CART WARNING
(symbol provided by RETAC)



S3126A

REMOTE CONTROL

Before using the remote control transmitter, batteries must first be installed.

HOW TO INSTALL BATTERIES

1. Open the battery compartment cover.

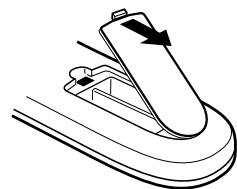

2. Install two "AAA" (penlight size) batteries.

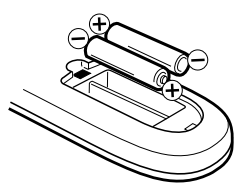

3. Replace the battery compartment cover.

Use two "AAA" size penlight batteries (not supplied) for the transmitter. The batteries may last approximately one year depending on how much the remote control is used. For best performance, it is recommended that batteries should be replaced on a yearly basis, or when the remote operation becomes erratic. Do not mix old and new batteries or different types.

BATTERY PRECAUTIONS

These precautions should be followed when using batteries in this device:

1. Use only the size and type of batteries specified.
2. Be sure to follow the correct polarity when installing the batteries as indicated in the battery compartment. Reversed batteries may cause damage to the device.
3. Do not mix different types of batteries together (e.g. Alkaline and Carbon-zinc) or old batteries with fresh ones.
4. If the device is not to be used for a long period of time, remove the batteries to prevent damage or injury from possible battery leakage.
5. Do not try to recharge batteries not intended to be recharged; they can overheat and rupture. (Follow battery manufacturer's directions.)

POWER SOURCE

TO USE AC POWER SOURCE

Use the AC polarized line cord provided for operation on AC. Insert the AC cord plug into a standard 120V 60Hz polarized AC outlet.

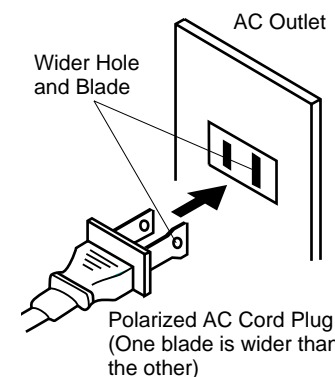

NOTE:

1. Never connect the AC line cord plug to other than the specified voltage (120V 60Hz). Use the attached power cord only.
2. If the polarized AC cord does not fit into a non-polarized AC outlet, do not attempt to file or cut the blade. It is the user's responsibility to have an electrician replace the obsolete outlet.
3. If you cause a static discharge when touching the unit, and the unit fails to function, simply unplug the unit from the AC outlet, wait a few minutes, and plug it back in. The unit should return to normal operation.

- 12. POWER-CORD PROTECTION-** Power-supply cords should be routed so that they are not likely to be walked on or pinched by items placed upon or against them, paying particular attention to cords at plugs, convenience receptacles, and the point where they exit from the appliance.
- 13. LIGHTNING-** To protect your unit during a lightning storm, or when it is left unattended and unused for long periods of time, unplug it from the wall outlet and disconnect the antenna or cable system. This will prevent damage to the unit due to lightning and power line surges.
- 14. POWER LINES-** An outside antenna system should not be located in the vicinity of overhead power lines, or other electric light or power circuits, or where it can fall into such power lines or circuits. When installing an outside antenna system, extreme care should be taken to keep from touching such power lines or circuits as contact with them might be fatal.
- 15. OVERLOADING-** Do not overload wall outlets and extension cords as this can result in a risk of fire or electric shock.
- 16. OBJECT AND LIQUID ENTRY-** Do not push objects through any openings in this unit as they may touch dangerous voltage points or short out parts that could result in fire or electric shock. Never spill or spray any type of liquid into the unit.
- 17. OUTDOOR ANTENNA GROUNDING-** If an outside antenna or cable system is connected to the unit, be sure the antenna or cable system is grounded to provide some protection against voltage surges and built-up static charges. Section 810 of the National Electrical Code, ANSI/NFPA 70, provides information with respect to proper grounding of the mast and supporting structure, grounding of the lead-in wire to an antenna discharge unit, size of grounding conductors, location of antenna discharge unit, connection to grounding electrodes, and requirements for the grounding electrode.
- 18. SERVICING-** Do not attempt to service this unit yourself as opening or removing covers may expose you to dangerous voltage or other hazards. Refer all servicing to qualified service personnel.
- 19. DAMAGE REQUIRING SERVICE-** Unplug this unit from the wall outlet and refer servicing to qualified service personnel under the following conditions:
 - a. When the power-supply cord or plug is damaged.
 - b. If liquid has been spilled, or objects have fallen into the unit.
 - c. If the unit has been exposed to rain or water.

- d. If the unit does not operate normally by following the operating instructions. Adjust only those controls that are covered by the operating instructions, as an improper adjustment of other controls may result in damage and will often require extensive work by a qualified technician to restore the unit to its normal operation.
 - e. If the unit has been dropped or the cabinet has been damaged.
 - f. When the unit exhibits a distinct change in performance, this indicates a need for service.
- 20. REPLACEMENT PARTS-** When replacement parts are required, be sure the service technician uses replacement parts specified by the manufacturer or those that have the same characteristics as the original part. Unauthorized substitutions may result in fire, electric shock or other hazards.
 - 21. SAFETY CHECK-** Upon completion of any service or repairs to this unit, ask the service technician to perform safety checks to determine that the unit is in proper operating condition.
 - 22. HEAT-** The product should be situated away from heat sources such as radiators, heat registers, stoves, or other products (including amplifiers) that produce heat.
 - 23. NOTE TO CATV SYSTEM INSTALLER**
This reminder is provided to call the CATV system installer's attention to Article 820-40 of the NEC that provides guidelines for proper grounding and, in particular, specifies that the cable ground shall be connected to the grounding system of the building, as close to the point of cable entry as practical.

EXAMPLE OF ANTENNA GROUNDING AS PER NATIONAL ELECTRICAL CODE

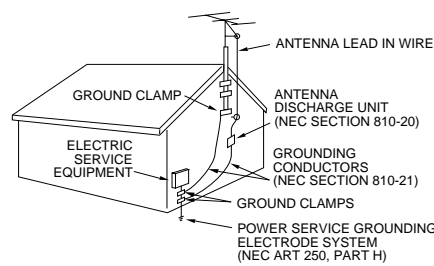

NEC-NATIONAL ELECTRICAL CODE
S2898A

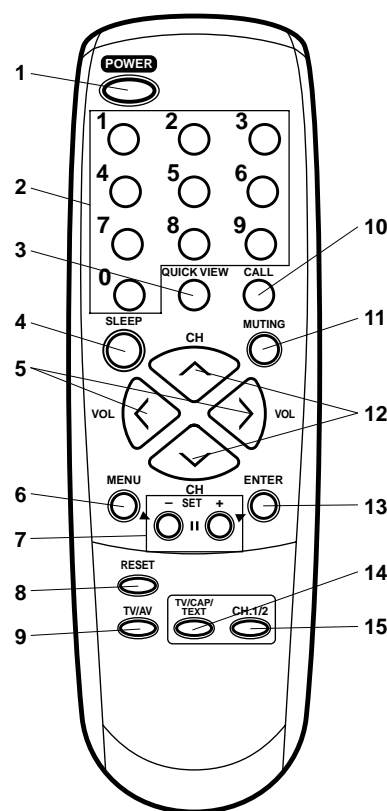

- 1. POWER Button** - Press to turn the TV on. Press again to turn the TV off.
- 2. Direct Channel Selection Buttons (0-9)** - Allows direct access to any channel.
- 3. QUICK VIEW Button** - This button allows you to go back to the previous channel selected by just pressing the QUICK VIEW button. Press this button again to return to the channel you were watching.
- 4. SLEEP Button** - To set the TV to turn off after a preset amount of time, press the SLEEP button on the remote control. The clock will count down 10 minutes each time the button is pressed in the order of 120, 110, 100, 20, 10, 0.
- 5. VOL (VOLUME) < / > Buttons** - Press the > button to increase, or the < button to decrease the volume level.
- 6. MENU Button** - Press to display the On-Screen menu function.
- 7. SET - / + Buttons** - Press to select the desired setting during On-Screen operations.
- 8. RESET Button** - Press to reset the On-Screen picture adjustments to their factory preset positions.
- 9. TV/AV Button** - Switches between TV and external inputs.
- 10. CALL Button** - When you press this button, the channel number will appear on the upper right corner of the screen. Press the button again to remove display from the screen.
- 11. MUTING Button** - To turn off the sound, press this button once. The TV will be silenced and the symbol "MUTING" will appear on the screen. The muting feature can be released by pressing the MUTING button again or one of the VOL < or > buttons.
- 12. CH (CHANNEL) ^ / v Buttons** - Press the ^ button to change to a higher numbered channel set into memory. Press the v button to change to a lower numbered channel set into memory.
- 13. ENTER Button** - Press to enter or select information for On-Screen operations.
- 14. TV/CAP/TEXT Button** - Press this button to switch between normal TV and the two Closed Caption modes (captions and 1/2 of full screen text). Closed Captioning will display text on screen for hearing impaired viewers.
- 15. CH.1/2 Button** - Switches between Channel 1 and Channel 2 in the Closed Caption mode.



LOCATION OF CONTROLS

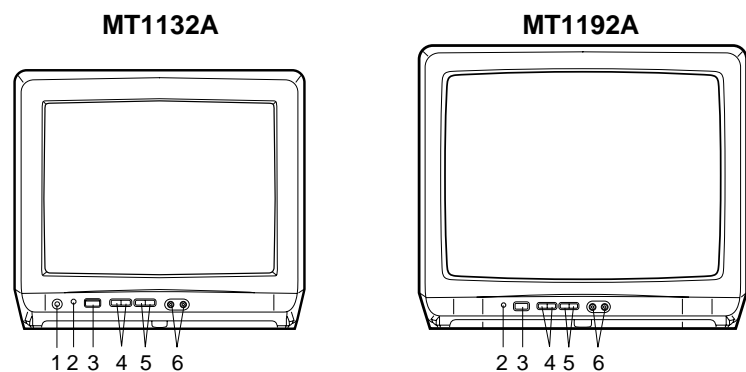

- 1. EAR (Earphone) Jack** - Plug an earphone or monaural headphones with an 1/8 miniplug into this jack for private listening.
- 2. Remote Sensor** - Signals from the Remote Control unit are received here.
- 3. POWER Button** - Press to turn the TV on or off.
- 4. VOLUME ▲/▼ Buttons** - Press to raise or lower the level of the sound.
(MENU Buttons) - Press both VOLUME ▲/▼ Buttons at the same time to display the On-Screen menu functions.
(SET +/- Buttons) - Press to select the desired setting during On-Screen operations.
- 5. CHANNEL ▲/▼ Buttons** - Press to select a higher or lower numbered channel set into memory.
(ENTER Button) - Press to enter or select information for On-Screen operations.
(RESET Button) - Press, while in the On-Screen menu mode, to reset the On-Screen picture adjustments to their factory preset positions.
- 6. AUDIO VIDEO IN Jack** - Audio and video signal cables from an external source can be connected here.

SETTING LANGUAGE

This TV can display the channel number, on screen displays and picture adjustments on the screen in English, Spanish or French.

On-screen language selection (step 3) will automatically appear on the screen when you press the MENU button initially. Select the language you prefer first, then proceed with the other menu options.

- 1 Press the MENU button.
- 2 Press the SET + or - button to select the LANGUAGE mode, then press the ENTER button.
- 3 Press the SET + or - button until the "▶" indicator points to the desired language: English (ENGLISH), Spanish (ESPAÑOL) or French (FRANCAIS), then press the ENTER button.
- 4 Press the MENU button again.

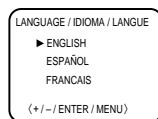
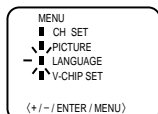

NOTE:

If Spanish or French is chosen, the Closed Caption indicators will be in the selected language, but the Closed Caption text will not be affected by the language selection.

TV OPERATION

- 1 To turn on the TV, press the POWER button.
- 2 The VOLUME can be adjusted to a desired level by pressing the VOL (VOLUME) < or > DOWN button.

The sound level will be indicated on the TV screen by GREEN BARS AND A NUMBER. As the sound level increases, so do the number of BARS AND THE NUMBER on the screen. The same is true for decreasing the level.

- 3 Set the TV/CATV menu option to the appropriate position. When shipped from the factory, this menu option is in the CATV setting. See "To Memorize Channels".

TV - VHF/UHF channels
CATV - CABLE TV channels

- 4 **CH (CHANNEL) ^ and v buttons**
Press and release the CH (CHANNEL) ^ or v button. The channel automatically stops at the next channel set into memory. Press and hold the button down to change channels more quickly.

For proper operation, before selecting channels, they should be set into the TV's memory. See "To Memorize Channels".

DIRECT CHANNEL SELECTION buttons (0-9) - Press these buttons to select a channel. The channel number will appear on the upper right corner of the TV screen. If an invalid channel number is selected, the display will revert to the previous channel.

TV MODE DIRECT CHANNEL SELECTION - When the TV/CATV menu option is in the TV position, all channels can be instantly selected by using two buttons (For example, to select channel 2, press "0", then "2". If you press only "2", channel selection will be delayed for a few seconds). For channels 10 and above, press the 2 digits in order.

CATV mode direct channel selection

When the TV/CATV menu option is in the CATV position, channels can be selected as follows:

- | | |
|---------|--|
| 1-9 | Press "0" twice, then 1-9 as needed.
Example, to select channel 2, press "002". |
| 10-12 | Press "0", then remaining 2 digits.
Example, to select channel 12, press "012". |
| 13-99 | Press the 2 digits in order.
Example, to select channel 36, press "36". |
| 100-125 | Press the 3 digits in order.
Example, to select channel 120, press "120". |

NOTE: If the station being viewed stops broadcasting, the TV will automatically shut off after 15 minutes.

CLOSED CAPTION

WHAT IS CLOSED CAPTIONING?

This television has the capability to decode and display Closed Captioned television programs. Closed Captioning will display text on the screen for hearing impaired viewers or it will translate and display text in another language.

TO VIEW CLOSED CAPTIONS

Press the TV/CAP/TEXT button on the remote control to switch between normal TV and the two Closed Caption Modes (Captions and 1/2 of Full Screen Text).

Captions: This Closed Caption Mode will display text on the screen in English or another language (depending on the setting of the Closed Captions CH. 1/2 button). Generally, Closed Captions in English are transmitted on Captions Channel 1 and Closed Captions in other languages are transmitted on Captions Channel 2.

Text: The Text Closed Caption Mode will usually fill 1/2 of full screen with a programming schedule or other information. After selecting a Closed Caption Mode, it will stay in effect until it is changed, even if the channel is changed. If the Captions signal is lost due to a commercial or a break in the signal, the Captions will reappear when the signal is received again. If the channels are changed, the Captions will be delayed approximately 10 seconds. The Captions will appear in places on the screen where they will least interfere with the picture, usually on the bottom of the screen. News programs will usually show three-line Closed Captions which scroll onto the screen. Most other shows provide two or three lined Captions placed near the character who is speaking so the viewer can follow the dialogue. Words in italics or underlined describe titles, words in foreign languages or words requiring emphasis. Words that are sung usually appear enclosed by musical notes. For television programs broadcasting with Closed Captions, look in your TV guide for the Closed Captions symbol (CC).

- When activating the Closed Captioned Decoder, there will be a short delay before the Closed Captioned text appears on the screen.
- Closed Captioned text is only displayed in locations where it is available.
- If no caption signal is received, no captions will appear, but the television will remain in the Caption Mode.
- Misspellings or unusual characters may occasionally appear during Closed Captioning. This is normal with Closed Captioning, especially with live programs. This is because during live programs, captions are also entered live. These transmissions do not allow time for editing.
- When Captions are being displayed, on-screen displays, such as volume and mute may not be seen or may interfere with Closed Captions.
- Some cable systems and copy protection systems may interfere with the Closed Captioned signal.
- If using an indoor antenna or if TV reception is very poor, the Closed Caption Decoder may not appear or may appear with strange characters or misspelled words. In this case, adjust the antenna for better reception or use an outdoor antenna.

SETTING V-CHIP

This TV is fitted with a V-CHIP controller which provides you with channel viewing access controls and restrictions. This function allows adult screening of TV programs based upon ratings.

- 1 Press the MENU button.
- 2 Press the SET + or - button to select the V-CHIP SET option, then press the ENTER button.
- 3 Enter your password (4 digits) using the Direct channel selection buttons (0-9). In the event of entering incorrect password press the RESET button. Then press the ENTER button.
- 4 Enter the same password for confirmation, then press the ENTER button.
- 5 Press the SET + or - button to select the V-CHIP option. Press the ENTER button to select the ON.
- 6 Press the SET + or - button to select the TV RATING or MOVIE RATING option. Press the ENTER button.
- 7 Press the SET + or - button to select the desired rating for the applicable video or TV channel. Press the ENTER button.

TV RATING SET- ↔ SET+

OFF ↔ TV-Y ↔ TV-Y7 ↔ TV-G ↔ TV-PG ↔ TV-14 ↔ TV-MA

TV-Y : all children
TV-Y7 : 7 years old and above
TV-G : childrens program

TV-PG : parental guidance
TV-14 : 14 years old and above
TV-MA : 17 years old and above

When you select TV-Y7, TV-PG, TV-14 or TV-MA, press the CALL button to explain the rating. Press the SET + or - button to select the desired rating you want. Press the ENTER button to select the setting ON or OFF.

MOVIE RATING SET- ↔ SET+

OFF ↔ G ↔ PG ↔ PG-13 ↔ R ↔ NC-17 ↔ X

G : all ages
PG : parental guidance
PG-13 : parental guidance less than 13 years old

R : under 17 years old parental guidance suggested
NC-17 : 17 years old and above
X : adult only

- 8 Press the MENU button until the MENU screen is cleared.

NOTES:

- If you want to change password, follow step 1 and 2 and select "CHANGE PASSWORD" option then enter your new password.
- The V-Chip function is activated only on programs and tapes that have the rating signal.
- Once you block a program using the V-Chip function, the blocked program cannot be watched based on the content of the show. When the program starts, the "ENTER PASSWORD" will appear on the screen. When you want to release the V-Chip temporarily, enter the password. If you change the channel or turn off the TV while the V-Chip function was temporarily released, the original setting will be resumed. If you return to the channel you were watching you must re-enter your password to temporarily release your V-Chip function again.
- When you watch the TV from the cable box or the VCR with the RF Modulator, then you release the V-Chip temporarily, the V-Chip setting will not be resumed until you turn off the TV. The TV channel is not used in this case.
- When changing the channel with the cable box or the VCR, approximately 10 seconds will pass until the program appears.



TO MEMORIZE CHANNELS

This TV is equipped with a channel memory feature which allows channels to skip up or down to the next channel set into memory, skipping over unwanted channels. Before selecting channels, they must be programmed into the TV's memory. In addition to normal VHF and UHF channels, this TV can receive up to 113 Cable TV channels. To use this TV with an antenna, set the TV/CATV menu option to the TV setting. When shipped from the factory, this menu option is in the CATV setting.

TV/CATV SELECTION

- 1 Press the MENU button.
- 2 Press the SET + or - button until the indicator next to "CH SET" begins to flash, then press the ENTER button.
- 3 Press the SET + or - button until the indicator next to "TV/CATV" begins to flash.
- 4 Press the ENTER button to select the TV or CATV mode. The arrow indicates the selected mode.
- 5 Press the MENU button twice to return to normal TV viewing.

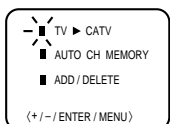
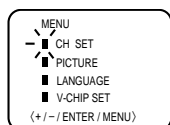

The chart below is typical of many cable system channel allocations.

CATV CHART

Number on this TV	14	15	16	17	18	19	20	21	22
Corresponding CATV channel	A	B	C	D	E	F	G	H	I
23	24	25	26	27	28	29	30	31	32
J	K	L	M	N	O	P	Q	R	S
41	42	43	44	45	46	47	48	49	50
EE	FF	GG	HH	II	JJ	KK	LL	MM	NN
59	60	61	62	63	64	65	66	67	68
WW	AA	BB	CC	DD	EE	FF	GG	HH	II
77	78	79	80	81	82	83	84	85	86
RRR	SSS	TTT	UUU	VVV	WWW	XXX	YYY	ZZZ	88
95	96	97	98	99	100	101	102	103	104
A-5	A-4	A-3	A-2	A-1	100	101	102	103	104
113	114	115	116	117	118	119	120	121	122
113	114	115	116	117	118	119	120	121	122
									01
									5A

NOTE:

Contact your cable company to determine the type of cable system used in your area.

AUTOMATIC CHANNEL MEMORY

- 1 Press the MENU button.
- 2 Press the SET + or - button until the indicator next to "CH SET" begins to flash, then press the ENTER button.
- 3 Press the SET + or - button until the indicator next to "AUTO CH MEMORY" begins to flash, then press the ENTER button. The TV will begin memorizing all the channels available in your area. Channel numbers will remain red until auto memorizing is complete.
- 4 Press the MENU button twice to return to normal TV viewing.

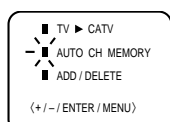
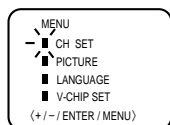

TO ADD/DELETE CHANNELS

- 1 Press the MENU button.
- 2 Press the SET + or - button until the indicator next to "CH SET" begins to flash, then press the ENTER button.
- 3 Press the SET + or - button until the indicator next to "ADD/DELETE" begins to flash, then press the ENTER button.
- 4 Select the desired channels to be added or deleted using the Direct Channel Selection buttons (10 keys: 0-9), the CH ▲ or ▼ button or the SET + or - button.
- 5 Press the ENTER button to select ADD or DELETE. If an unmemorized channel was selected (step 4), the channel indication will be red. Press the ENTER button if you wish to ADD the unmemorized channel. The channel indicator will change from red to green when a channel is added and the channel will be memorized. If a memorized channel was selected (step 4), the channel indication will be green. Press the ENTER button if you wish to DELETE the channel from memory. The channel indicator will change from green to red when a channel is deleted. Repeat Steps 4 and 5 for each channel to be added or deleted.
- 6 Press the MENU button three times after adding or deleting all of the desired channels, to return to normal TV viewing.

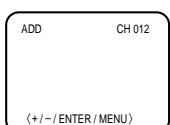
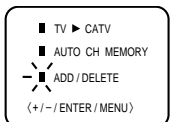
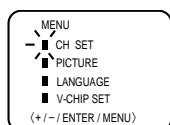

ADJUSTING PICTURE

You can adjust the settings for color, sharpness, contrast, brightness and tint.

- 1 Press the MENU button.
- 2 Press the SET + or - button until the indicator next to "PICTURE" begins to flash, then press the ENTER button.
- 3 Press the ENTER button repeatedly to select the item you want to adjust.
BRIGHTNESS → CONTRAST → COLOR → TINT → SHARPNESS
- 4 Press the SET + or - button to adjust the setting.

	+	-
BRIGHTNESS	increase brightness	decrease brightness
CONTRAST	increase contrast	decrease contrast
COLOR	be brilliant color	be pale color
TINT	be greenish color	be reddish color
SHARPNESS	makes picture clearer	makes picture softer

TO RETURN TO INITIAL SETTING

Press the RESET button while the picture adjusting mode appears on-screen.

CONNECTION TO OTHER EQUIPMENT

The exact arrangement you use to interconnect various video and audio components to the TV is dependent on the model and features of each component. Check the Owner's Manual provided with each component for the location of video and audio inputs and outputs.

The connection diagrams below are offered as suggestions. You may need to modify them to accommodate your particular assortment of components. The diagrams are intended to show component video and audio interconnections only.

Press the TV/AV selector button to select the AV mode to use the TV as a monitor. Operate your VCR as usual.

TV/AV SELECTION

If you connect the TV to a VCR, camcorder or TV game, through the audio/video in jacks, use the TV/AV button to make your selection.

Press the TV/AV button repeatedly to select the desired mode. "AUX" will display on the screen for 4 seconds.

2. To connect the TV to a TV Game

The TV can also be used as a display device for many video games. However, due to the wide variety of different types of signal generated by these devices and subsequent hook-up variations required, they have not all been included in the suggested connection diagrams. You'll need to consult each component's Owner's Manual for additional information.

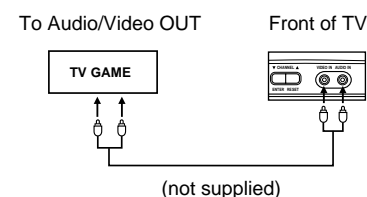
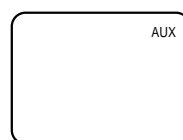

1. To connect the TV to a VCR

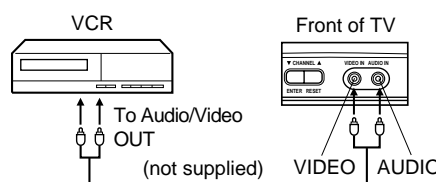

3. To connect the TV to a camcorder

To playback from the camcorder, connect the camcorder to the TV as shown.

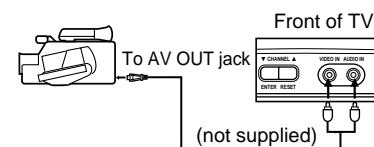

TROUBLESHOOTING GUIDE

Before requesting service, please refer to the following chart for the symptom and possible solution.

SYMPTOMS	POSSIBLE SOLUTIONS
TV does not operate	<ul style="list-style-type: none"> Make sure the power cord is plugged in. Try another AC outlet. Power is off, check fuse or circuit breaker. Unplug unit for an hour, then plug it back in.
Poor sound or No sound	<ul style="list-style-type: none"> Station or CATV experiencing problems, tune to another station. Check sound adjustments (VOLUME and MUTING). Check for sources of possible interference.
Poor picture or No picture	<ul style="list-style-type: none"> Station or CATV experiencing problems, tune to another station. Make sure channels are set into memory. Check antenna or CATV connections, adjust antenna. Check for sources of possible interference. Check picture control adjustments.
Poor reception on some channels	<ul style="list-style-type: none"> Station or CATV experiencing problems, tune to another station. Make sure channels are set into memory. Station is weak, adjust antenna to receive desired station. Check for sources of possible interference.
Poor color or no color	<ul style="list-style-type: none"> Station or CATV experiencing problems, tune to another station. Make sure channels are set into memory. Check picture control adjustments. Check antenna or CATV connections, reorient antenna. Check for sources of possible interference.
Picture wobbles or drifts	<ul style="list-style-type: none"> Station or CATV experiencing problems, tune to another station. Make sure channels are set into memory. CATV company is scrambling signal. Adjust antenna.
No CATV reception	<ul style="list-style-type: none"> Check all CATV connections. Set TV/CATV menu option to the CATV mode. Station or CATV system problems, try another station.
Horizontal or diagonal bars on screen	<ul style="list-style-type: none"> Check antenna connections, adjust or re-direct antenna. Check for sources of possible interference.
No reception above channel 13	<ul style="list-style-type: none"> Make sure TV/CATV menu option is in the appropriate mode. If using antenna, check UHF antenna connections.
No Remote operation	<ul style="list-style-type: none"> Batteries are weak, dead or inserted incorrectly. Remote is out of range, move closer to TV (within 15 feet). Make sure Remote is aimed at sensor. Confirm there are no obstructions between the Remote and the TV. Make sure the power cord is plugged in.
TV shuts off	<ul style="list-style-type: none"> No broadcast on station tuned. Sleep Timer is set. Power interrupted.
Closed - Caption is not activated	<ul style="list-style-type: none"> TV station experiencing problems or program tuned is not closed captioned. Try another channel. Check CATV connection or VHF/UHF antenna, reposition or rotate antenna. Press TV/CAP/TEXT button to turn on the closed caption decoder.
Display is not shown in your language	<ul style="list-style-type: none"> Select proper language in the menu options.

Free Manuals Download Website

<http://myh66.com>

<http://usermanuals.us>

<http://www.somanuals.com>

<http://www.4manuals.cc>

<http://www.manual-lib.com>

<http://www.404manual.com>

<http://www.luxmanual.com>

<http://aubethermostatmanual.com>

Golf course search by state

<http://golfingnear.com>

Email search by domain

<http://emailbydomain.com>

Auto manuals search

<http://auto.somanuals.com>

TV manuals search

<http://tv.somanuals.com>