

Memorex®

Is it live or is it Memorex?™

MT2024

User's Guide

20" COLOR TV WITH
REMOTE CONTROL

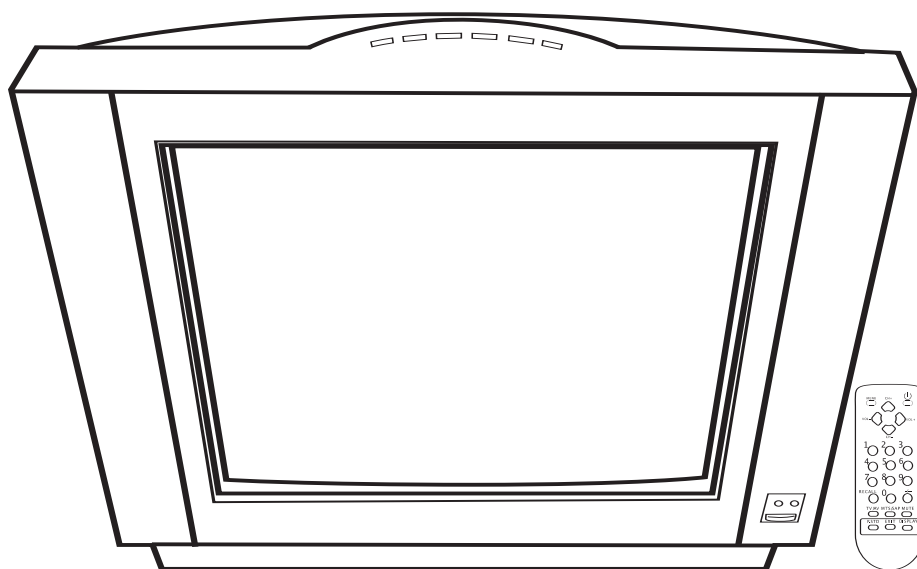

**Before operating this product,
please read these instructions completely.**

CONTENTS

Contents	1	• Volume Buttons	30
Important Safety Instructions	2	• P.STD (Picture Standard)	30
Power Source	5	• MTS/SAP	30
Location of Controls	5	Closed Captions	31
• Front	5	Troubleshooting Guide	32
• Rear Panel.....	6	Reception Disturbances	33
• Remote	6	Care and Maintenance	33
Remote Control	7	Specifications	34
• Battery Installation	7		
• Effective Distance of the Remote Control Transmitter	7		
Antenna Connections	8		
Connection Using the Side A/V In Jacks	8		
Cable (CATV)/Satellite Connections	9		
Connection from an External Unit	10		
• Connection Using Coaxial Cable.....	10		
• Connection Using A/V Cables	10		
• Connection Using S-Video Cable	11		
Connection to an External Unit	11		
• Connection Using the Audio/Video Out Jacks	11		
Setting the Menus	12		
• Video Setup Menu	12		
• Audio Setup Menu	12		
• Timer Setup Menu	13		
• Setting the On Timer	14		
• Setting the Off Timer.....	15		
• Setting the Sleep Timer	15		
• Setting the Remind Timer	16		
• Setup Menu	17		
• Channel Setup Menu	20		
• Setting Channels into Memory	21		
• Adding and Deleting Channels	22		
• Calendar Setup Menu.....	23		
TV Parental Control	24		
• Parental Control Setup	24		
• TV Rating Setup	25		
• MPAA Rating Setup	26		
• Lock Menu	27		
TV Basic Operation	28		
• Display	29		
• Recall.....	29		
• Mute.....	29		
• TV/AV.....	30		

IMPORTANT SAFETY INSTRUCTIONS

WARNING:

TO REDUCE THE RISK OF FIRE OR ELECTRIC SHOCK, AND ANNOYING INTERFERENCE, USE THE RECOMMENDED ACCESSORIES ONLY.

SURGE PROTECTORS:

It is recommended to use a surge protector for AC connection. Lightning and power surges ARE NOT covered under warranty for this product.



The symbol for class II
(Double Insulation)

ATTENTION:

POUR ÉVITER LES CHOC ÉLECTRIQUES, INTRODUIRE LA LAME LA PLUS LARGE DE LA FICHE DANS LA BORNE CORRESPONDANTE DE LA PRISES ET POUSSER JUSQU'AU FOND.

FCC NOTICE:

This equipment has been tested and found to comply with the limits for a Class B digital device, pursuant to part 15 of the FCC Rules. These limits are designed to provide reasonable protection against harmful interference in a residential installation. This equipment generates, uses and can radiate radio frequency energy and, if not installed and used in accordance with the instructions, may cause harmful interference to radio communications.

However, there is no guarantee that interference will not occur in a particular installation. If this equipment does cause harmful interference to radio or television reception, which can be determined by turning the equipment off and on, the user is encouraged to try to correct the interference by one or more of the following measures:

- Reorient or relocate the receiving antenna.
- Increase the separation between the equipment and receiver.
- Connect the equipment into an outlet on a circuit different from that to which the receiver is connected.
- Consult the dealer or an experienced radio/TV technician for help.

FCC WARNING:

To assure continued compliance, follow the attached installation instructions and use only shielded cables when connecting to other devices. Modifications not authorized by the manufacturer may void user's authority to operate this device.

IMPORTANT SAFETY INSTRUCTIONS (CONTINUED)

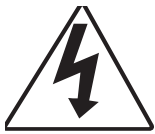

CAUTION

**RISK OF ELECTRIC SHOCK
DO NOT OPEN**



The lightning flash with arrowhead symbol within an equilateral triangle is intended to alert the user to the presence of uninsulated dangerous voltage within the product's enclosure that may be of sufficient magnitude to constitute a risk of electric shock to persons.



The exclamation point within an equilateral triangle is intended to alert the user to the presence of important operating and maintenance (servicing) instructions in the literature accompanying the appliance.

CAUTION: TO REDUCE THE RISK OF ELECTRIC SHOCK, DO NOT REMOVE COVER (OR BACK). NO USER-SERVICEABLE PARTS INSIDE. REFER SERVICING TO QUALIFIED SERVICE PERSONNEL.
(This Caution Marking is located at the rear enclosure of the unit.)

WARNING: TO REDUCE THE RISK OF FIRE OR ELECTRIC SHOCK, DO NOT EXPOSE THIS APPLIANCE TO RAIN OR MOISTURE.

Before using the unit, be sure to read all operating instructions carefully. Please note that these are general precautions and may not pertain to your unit. For example, this unit may not have the capability to be connected to an outdoor antenna.

1. READ INSTRUCTIONS

All the safety and operating instructions should be read before the product is operated.

2. RETAIN INSTRUCTIONS

The safety and operating instructions should be retained for future reference.

3. HEED WARNINGS

All warnings on the product and in the operating instructions should be adhered to.

4. FOLLOW INSTRUCTIONS

All operating and use instructions should be followed.

5. CLEANING

Unplug this product from the wall outlet before cleaning. Do not use liquid cleaners or aerosol cleaners. Use a dry cloth for cleaning.

6. ATTACHMENTS

Do not use attachments not recommended by the product's manufacturer as they may cause hazards.

7. WATER AND MOISTURE

Do not use this product near water—for example: near a bathtub, washbowl, kitchen sink or laundry tub; in a wet basement; or near a swimming pool.

8. ACCESSORIES

Do not place this product on an unstable cart, stand, tripod, bracket or table. The product may fall, causing serious injury and serious damage to the product. Use only with a cart, stand, tripod, bracket or table recommended by the manufacturer or sold with the product. Any mounting of the product should follow the manufacturer's instructions, and should use a mounting accessory recommended by the manufacturer.

8A. An appliance and cart combination should be moved with care. Quick stops, excessive force and uneven surfaces may cause the appliance and cart combination to overturn.

9. VENTILATION

Slots and openings in the cabinet and in the back or bottom are provided for ventilation, to ensure reliable operation of the product and to protect it from overheating. These openings must not be blocked or covered. The openings should never be blocked by placing the product on a bed, sofa, rug or other similar surface. This product should never be placed near or over a radiator or heat source. This product should not be placed in a built-in installation such as a bookcase or rack unless proper ventilation is provided or the manufacturer's instructions have been adhered to.

10. POWER SOURCES

This product should be operated only from the type of power source indicated on the marking label. If you are not sure of the type of power supply to your home, consult your appliance dealer or local power company. For products intended to operate from battery power, or other sources, refer to the operating instructions.

11. GROUNDING OR POLARIZATION

This product is equipped with a polarized alternating-current line plug (a plug having one blade wider than the other). This plug will fit into the power outlet only one way. This is a safety feature. If you are unable to insert the plug fully into the outlet, try reversing the plug. If the plug should still fail to fit, contact your electrician to replace your obsolete outlet. Do not defeat the safety purpose of the polarized plug.

12. POWER-CORD PROTECTION

Power-supply cords should be routed so that they are not likely to be walked on or pinched by items placed upon or against them, paying particular attention to cords at plugs, convenience receptacles, and the point where they exit from the appliance.

13. LIGHTNING

To protect your product from a lightning storm, or when it is left unattended and unused for long periods of time, unplug it from the wall outlet and disconnect the antenna or cable system. This will prevent damage to the product due to lightning and power-line surges.

14. POWER LINES

An outside antenna system should not be located in the vicinity of overhead power lines or other electric light or power circuits, or where it can fall into such power lines or circuits. When installing an outside antenna system, extreme care should be taken to keep from touching such power lines or circuits as contact with them might be fatal.

PORTABLE CART WARNING
(symbol provided by RETAC)



S3126A

IMPORTANT SAFETY INSTRUCTIONS (CONTINUED)

15. OVERLOADING

Do not overload wall outlets and extension cords as this can result in a risk of fire or electric shock.

16. OBJECT AND LIQUID ENTRY

Never push objects of any kind into this product through openings as they may touch dangerous voltage points or short out parts that could result in fire or electric shock. Never spill or spray any type of liquid on the product.

17. OUTDOOR ANTENNA GROUNDING

If an outside antenna is connected to the product, be sure the antenna system is grounded so as to provide some protection against voltage surges and built-up static charges. Section 810 of the National Electric Code, ANSI/NFPA 70, provides information with respect to proper grounding of the mast and supporting structure, grounding of the lead-in wire to an antenna discharge product, size of grounding conductors, location of antenna discharge product, connection to grounding electrodes and requirements for grounding electrodes.

18. SERVICING

Do not attempt to service this product yourself as opening or removing covers may expose you to dangerous voltage or other hazards. Refer all servicing to qualified service personnel.

19. REPLACEMENT PARTS

When replacement parts are required, be sure the service technician uses replacement parts specified by the manufacturer or those that have the same characteristics as the original part. Unauthorized substitutions may result in fire, electric shock or other hazards.

20. SAFETY CHECK

Upon completion of any service or repairs to this product, ask the service technician to perform safety checks to determine that the product is in proper operating condition.

21. WALL OR CEILING MOUNTING

The product should be mounted to a wall or ceiling only as recommended by the manufacturer.

22. DAMAGE REQUIRING SERVICE

Unplug the product from the wall outlet and refer servicing to qualified service personnel under the following conditions:

- When the power-supply cord or plug is damaged.
- If liquid has been spilled or objects have fallen into the product.
- If the product has been exposed to rain or water.
- If the product does not operate normally by following the operating instructions. Adjust only those controls that are covered by the operating instructions, as an adjustment of other controls may result in damage and will often require extensive work by a qualified technician to restore the product to its normal operation.
- If the product has been dropped or the cabinet has been damaged.
- When the product exhibits a distinct change in performance—this indicates a need for service.

23. HEAT

The product should be situated away from heat sources such as radiators, heat registers, stoves or other products (including amplifiers) that produce heat.

24. NOTE TO CATV SYSTEM INSTALLER

This reminder is provided to call the CATV system installer's attention to Article 820-40 of the NEC that provides guidelines for proper grounding and, in particular, specifies that the cable ground shall be connected to the grounding system of the building, as close to the point of cable entry as practical.

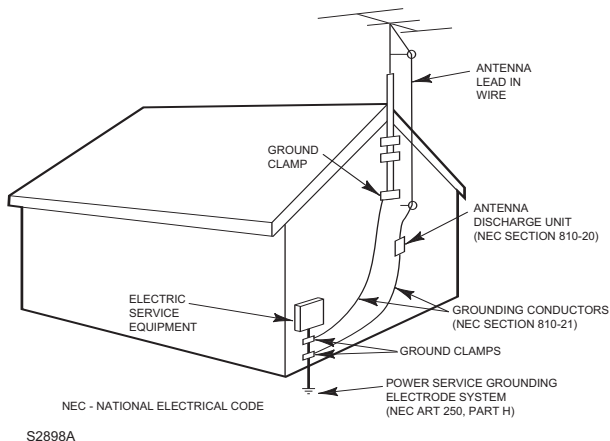

EXAMPLE OF ANTENNA GROUNDING AS PER NATIONAL ELECTRICAL CODE

POWER SOURCE

Insert the AC plug (with the 2 blades) into a conveniently located AC outlet having 120V, 60Hz.

NOTE: The AC plug supplied with the unit is polarized to help minimize the possibility of electric shock. If the AC plug does not fit into a nonpolarized AC outlet, do not file or cut the wide blade. It is the user's responsibility to have an electrician replace the obsolete outlet.

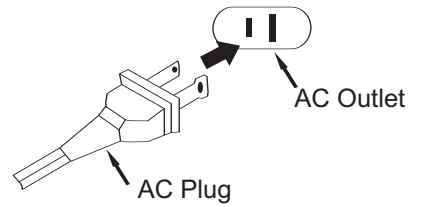

LOCATION OF CONTROLS

FRONT

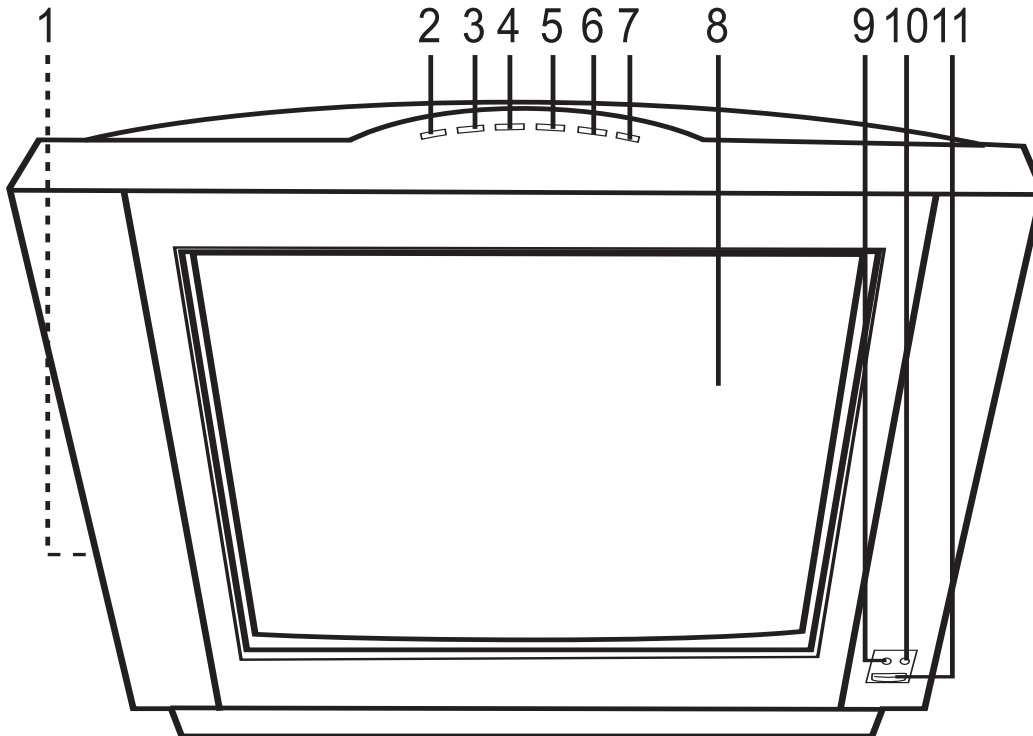

1. Audio 1 IN/Video 1 IN/Headphone Jacks
(Side of Unit)
2. MENU Button
3. TV/AV Button
4. VOLUME Down Button
5. VOLUME Up Button
6. CHANNEL Down Button
7. CHANNEL Up Button
8. Display
9. Remote Sensor
10. Power Indicator—Standby light red, Power On light green
11. Power Button

NOTE:

When setting the TV Menus, the Channel Up/Down buttons are used as Navigation Up/Down and the Volume Up/Down buttons are used as Navigation Right/Left.

LOCATION OF CONTROLS (CONTINUED)

REAR

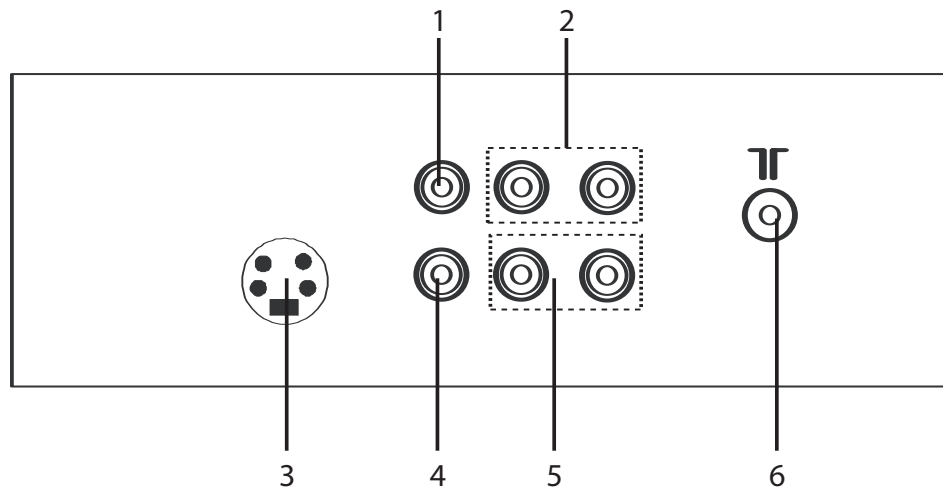

1. Video OUT Jack
2. Audio OUT Jacks
3. S-Video IN Jack

4. Video 2 IN Jack
5. Audio 2 IN Jacks
6. Antenna Jack

REMOTE

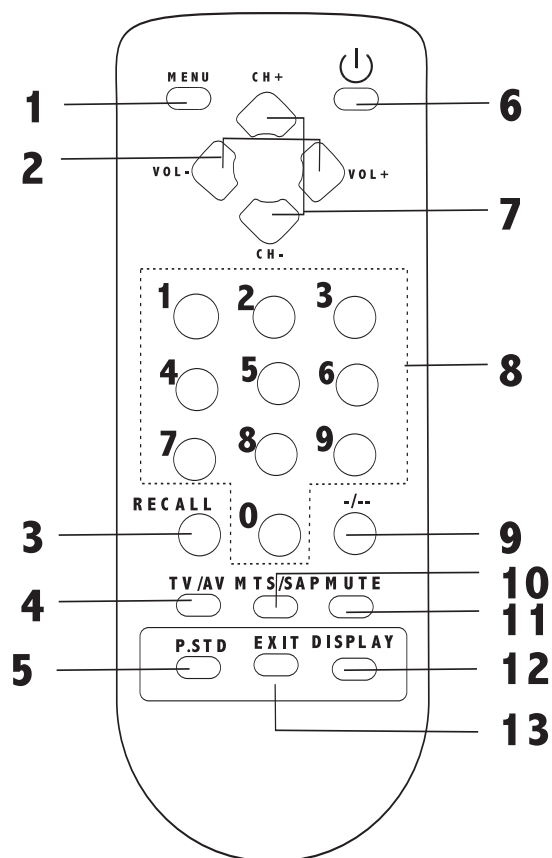

1. MENU Button
2. VOLUME Up/Down Buttons
3. RECALL Button
4. TV/AV Button
5. P. STD (Picture) Button
6. Power Button
7. CHANNEL Up/Down Buttons
8. Direct Channel Selection Buttons (0-9)
9. -/-- Button
10. MTS/SAP Button
11. MUTE Button
12. DISPLAY Button
13. EXIT Button

NOTE:

When setting the TV Menus, the Channel Up/Down buttons are used as Navigation Up/Down and the Volume Up/Down buttons are used as Navigation Right/Left.

REMOTE CONTROL

BATTERY INSTALLATION

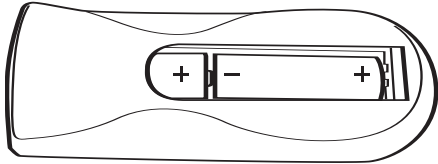

1. Remove the Battery Compartment cover by pushing in on the tab and lifting the cover off.
2. Install two (2) "AA" batteries (not included), paying attention to the polarity diagram in the Battery Compartment.
3. Replace the Battery Compartment cover.

BATTERY PRECAUTIONS

Follow these precautions when using batteries in this device:

1. Use only the size and type of batteries specified.
2. Be sure to follow the correct polarity when installing the batteries as indicated next to the battery compartment. Reversed batteries may cause damage to the device.
3. Do not mix different types of batteries together (e.g. Alkaline, Rechargeable and Carbon-zinc) or old batteries with fresh ones.
4. If the device is not to be used for a long period of time, remove the batteries to prevent damage or injury from possible battery leakage.
5. Do not try to recharge batteries not intended to be recharged; they can overheat and rupture. (Follow battery manufacturer's directions.)

EFFECTIVE DISTANCE OF THE REMOTE CONTROL TRANSMITTER

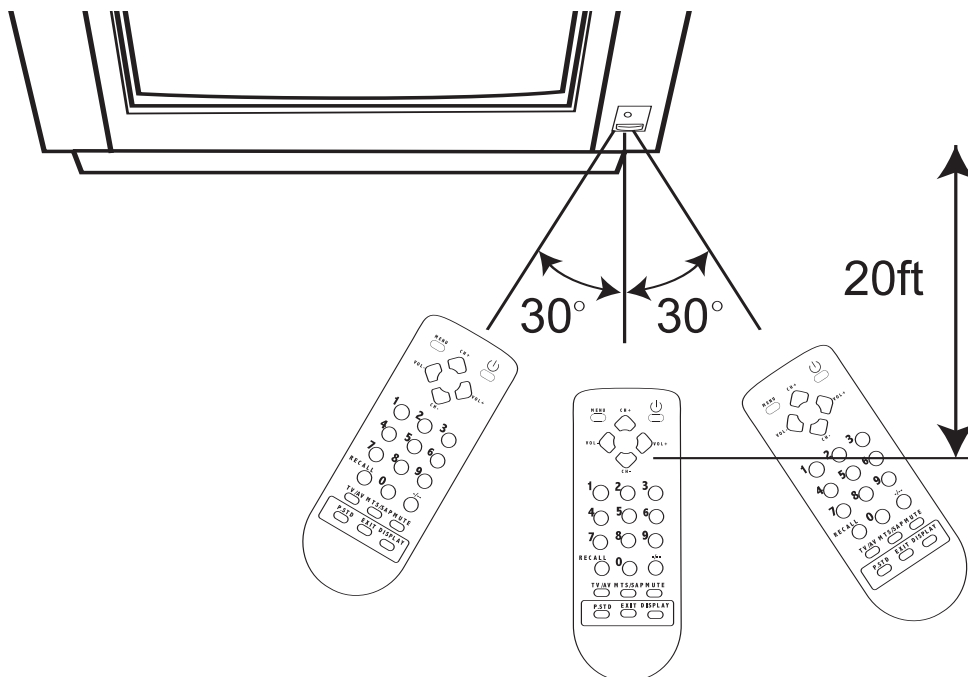

NOTES:

- When there is an obstacle between the TV and the transmitter, the transmitter may not operate.
- When direct sunlight, an incandescent lamp, fluorescent lamp or any other strong light shines on the Remote Sensor of the TV, the remote operation may be unstable.

ANTENNA CONNECTIONS

OUTDOOR VHF/UHF ANTENNA CONNECTION (ANTENNA NOT INCLUDED)

Follow the instructions for the type of antenna system you intend to use. If using Cable or satellite, see the next page.

Combination VHF/UHF Antenna (Single 75 ohm cable or 300 ohm twin-lead wire)

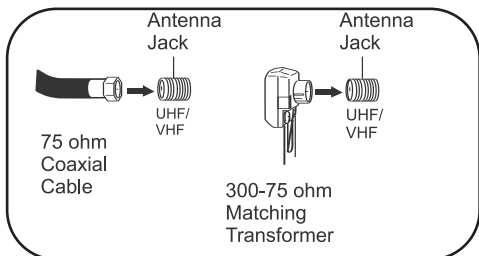

Connect the 75 ohm cable from combination VHF/UHF antenna to the antenna jack.

OR

If your combination antenna has a 300 ohm twin-lead wire, use a 300-75 ohm matching transformer (NOT SUPPLIED).

Combination VHF/UHF Antenna (Separate VHF and UHF 300 ohm twin-leads)

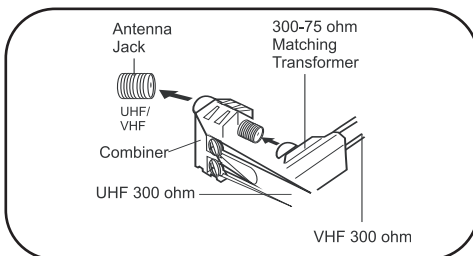

Connect the UHF twin-lead wire to a combiner (NOT SUPPLIED). Connect the VHF twin-lead to a 300-75 ohm matching transformer (NOT SUPPLIED). Attach the transformer to the combiner. Attach the combiner to the antenna jack.

Separate VHF/UHF Antennas

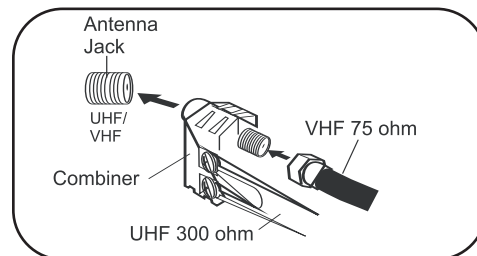

Connect the 75 ohm cable from the VHF antenna and the UHF antenna twin-lead wire to a combiner (NOT SUPPLIED). Attach the combiner to the antenna jack. **NOTE:** If your VHF antenna has a twin-lead wire, use a 300-75 ohm matching transformer, then connect the transformer to the combiner.

CONNECTION USING THE SIDE AUDIO/VIDEO IN JACKS

The optimal use for the side A/V jacks are to connect an A/V component that is used only occasionally, such as a camcorder or video game. Connect the Audio/Video output jacks of the external unit to the Audio 1 Input jacks and the Video 1 Input jack.

To access the unit connected to these jacks, press the TV/AV button repeatedly until VIDEO 1 appears on the screen. To resume normal TV viewing, simply press the TV/AV button repeatedly until the TV channel appears in the display.

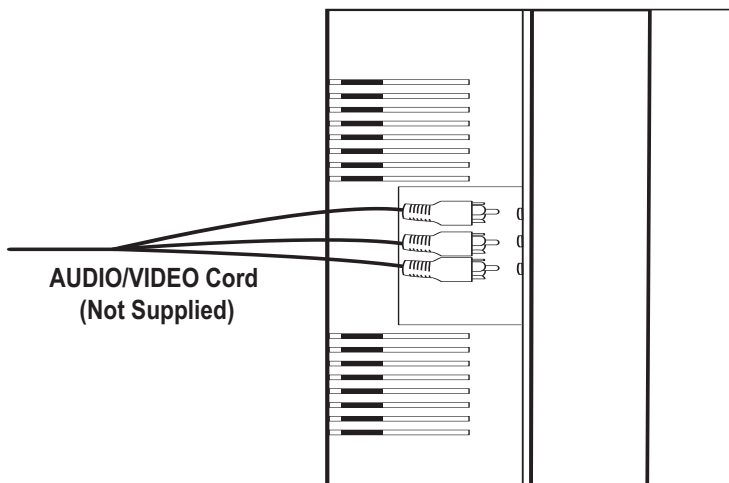
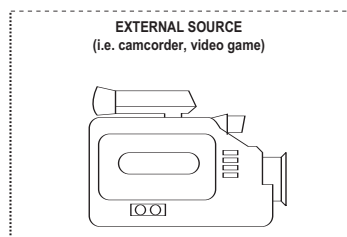

FAQs:

My external unit has only 1 audio jack, but this unit has two Audio Input jacks, how do I connect it?
Simply connect it to the "L (Mono)" Audio Input jack, but the sound will be monaural.

How do I watch the external unit connected to the Audio/Video Input jacks?

Press the TV/AV button repeatedly until VIDEO 1 appears on the screen, then start the external source.

Are the cables included?

No, the cables are sold separately, visit your local electronics store.

CABLE (CATV)/SATELLITE CONNECTIONS

This TV has an extended tuning range and can tune most cable channels without using a Cable TV converter box. Some Cable TV companies offer "premium pay channels" in which the signal is scrambled. Descrambling these signals for normal viewing requires the use of a descrambler device which is generally provided by the cable company.

FOR SUBSCRIBERS TO BASIC CABLE TV SERVICE

For basic cable service not requiring a converter/descrambler box, connect the CATV 75 ohm coaxial cable to the VHF/UHF jack on the rear of the TV.

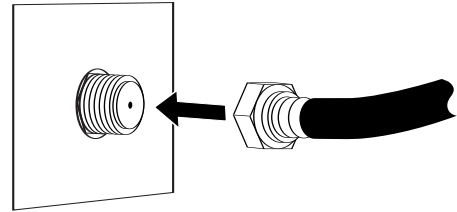

FOR SUBSCRIBERS TO SCRAMBLED CABLE TV SERVICE OR SATELLITE

If you subscribe to a satellite service or a cable TV service which requires the use of a converter/descrambler box, connect the incoming 75 ohm coaxial cable to the converter/descrambler box. Using another 75 ohm cable, connect the output of the converter/descrambler or satellite box to the antenna jack on the TV. Follow the connections shown below. Set the TV/VCR to the output channel of the converter/descrambler or satellite box (usually 3 or 4) and use the converter/descrambler or satellite box to select channels.

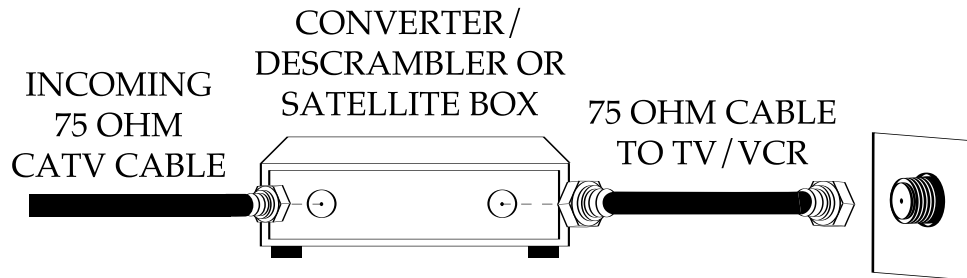

FOR SUBSCRIBERS TO UNSCRAMBLED BASIC CABLE TV SERVICE WITH SCRAMBLED PREMIUM CHANNELS

If you subscribe to a satellite service or a cable TV service in which basic channels are unscrambled and premium channels require the use of a converter/descrambler box, you may wish to use a signal splitter and an A/B switch box (available from the cable company or an electronic supply store). Follow the connections shown below. With the switch in the "B" position, you can directly tune any unscrambled channels on your TV. With the switch in the "A" position, tune your TV to the output of the converter/descrambler box (usually channel 3 or 4) and use the converter/descrambler box to tune scrambled channels.

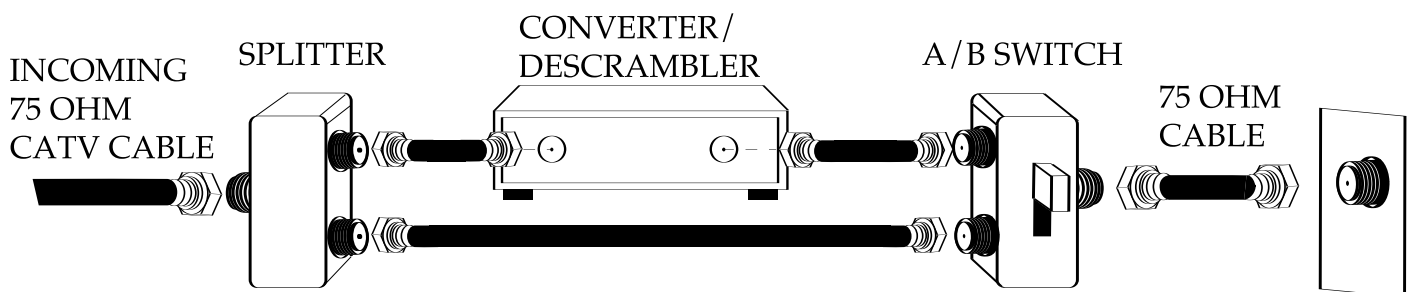

FAQ:

I connected my cable, but why can't I get channels above 69?

Make sure the TV (VHF/UHF Channels)/CATV (Cable TV) option is set to CATV (Cable TV), see page 21. Also, make sure your cable company broadcasts channels in the range you are searching.

CONNECTION FROM AN EXTERNAL UNIT

CONNECTION USING COAXIAL CABLE:

Follow the instructions below to connect an external unit, such as a VCR, to your unit using a 75 ohm coaxial cable. (CABLES NOT INCLUDED.)

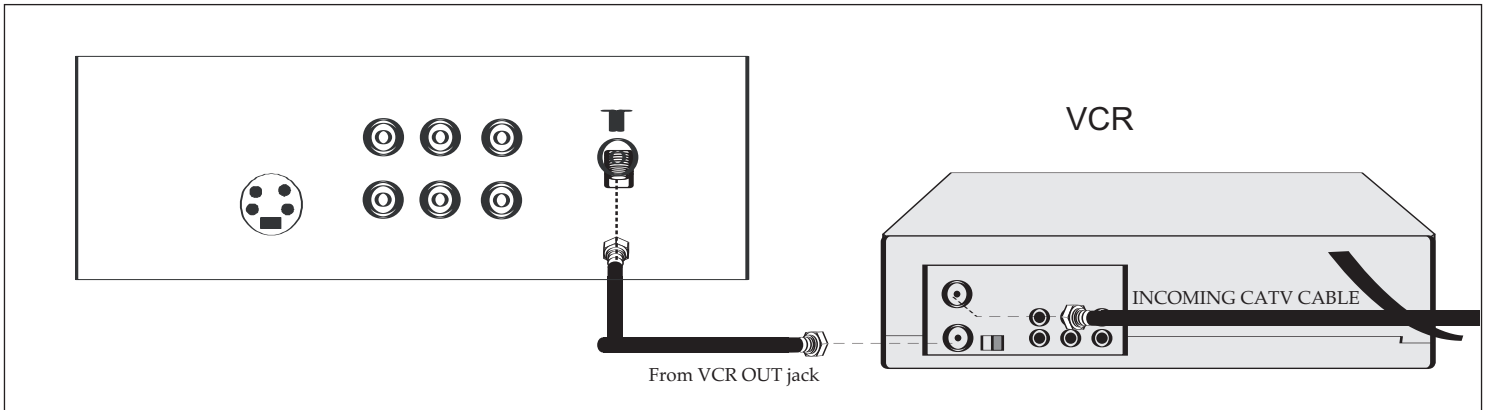

1. Connect the cable, satellite or incoming antenna to the VHF/UHF IN jack on the rear of the VCR.
2. Connect a 75 ohm coaxial cable from the VCR's 75 ohm OUT jack to the ANT jack on the rear of the TV.
3. Press the TV/AV button until regular TV or CATV channel appears on the TV screen and press PLAY on the VCR to watch a tape.

CONNECTION USING AUDIO/VIDEO CABLES:

Follow the instructions below to connect an external unit, such as a VCR or a DVD player, to your unit using Audio/Video cables. (CABLES NOT INCLUDED.)

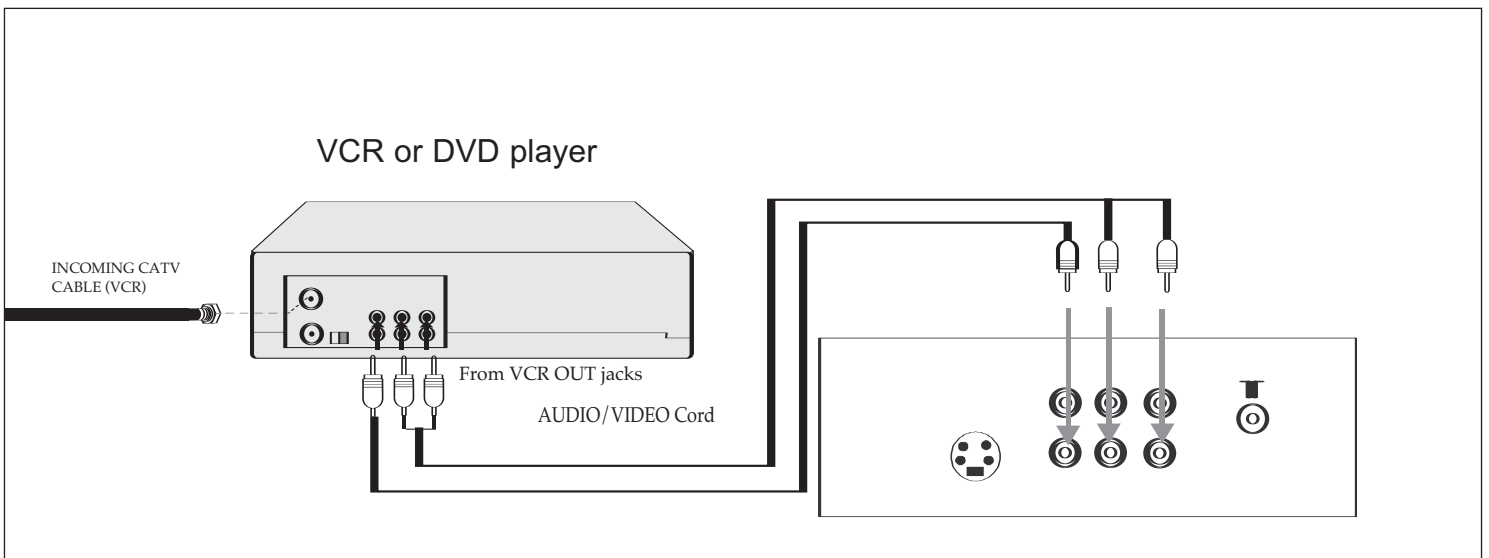

1. Connect the cable, satellite or incoming antenna to the VHF/UHF IN jack on the rear of the VCR or DVD player.
2. Connect the left and right audio cable from the VCR/DVD's Audio OUT jacks to the TV's left and right Audio 2 IN jacks. Connect the VCR/DVD's Video OUT jack to the TV's VIDEO 2 IN jack.
3. Press the TV/AV button until VIDEO2 appears on the TV screen.

CONNECTION FROM AN EXTERNAL UNIT (CONTINUED)

CONNECTION USING S-VIDEO CABLE:

Follow the instructions below to connect an S-VIDEO VCR/DVD to your television using an S-video cable. (CABLES NOT INCLUDED.)

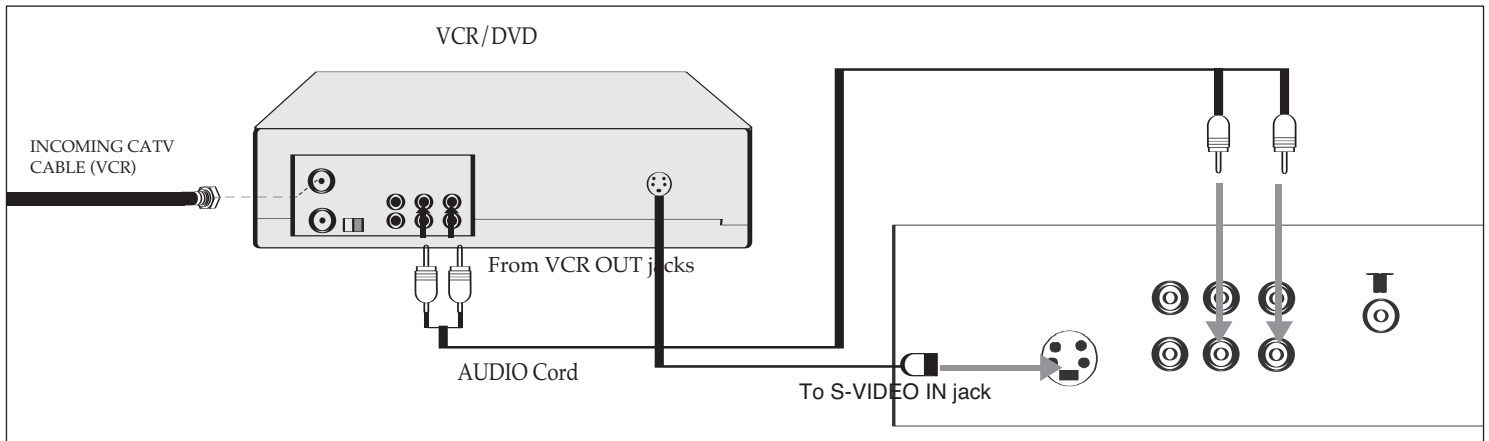

1. For VCR, connect the cable, satellite or incoming antenna to the ANT jack on the rear of the VCR.
2. Connect the left and right audio cable from the DVD/ VCR's Audio OUT jacks to the TV's left and right AUDIO 2 IN jacks.
3. Connect the DVD/VCR's S-VIDEO OUT jack to the TV's S-VIDEO IN jack.
4. Press the TV/AV button until S-VHS appears on the TV screen.

CONNECTION TO AN EXTERNAL UNIT

CONNECTION USING THE AUDIO/VIDEO OUT JACKS:

Follow the instructions below to connect an external audio unit. This will output the sound from the TV into the external audio unit's speakers.

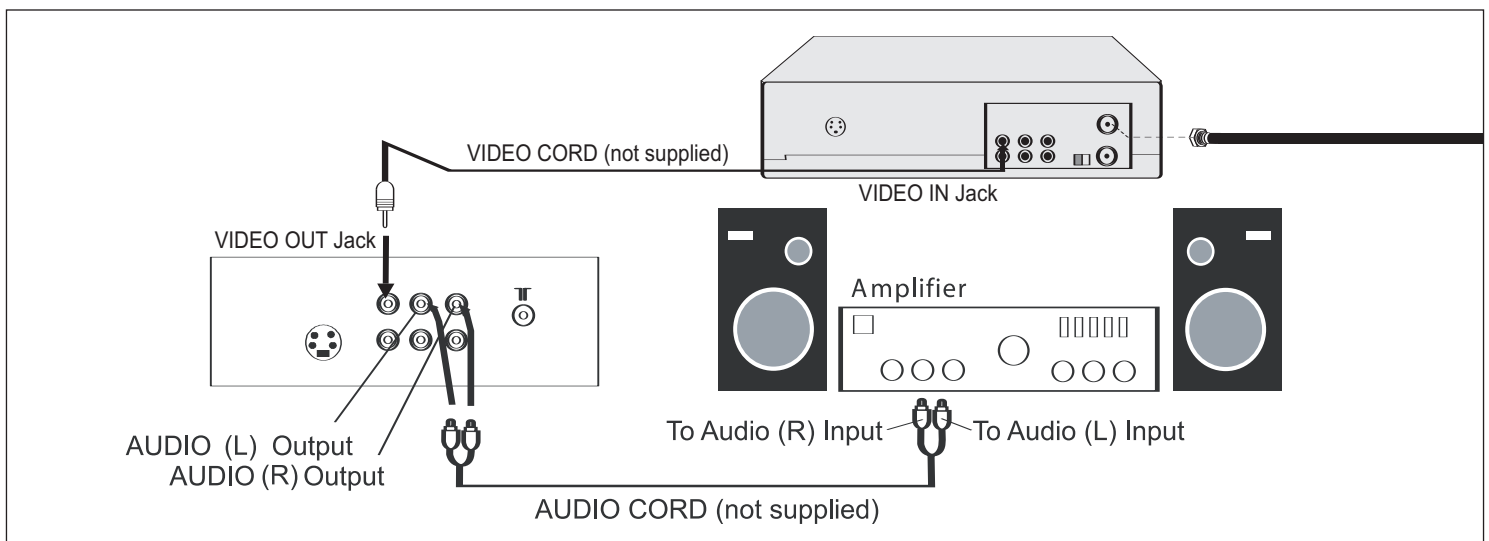

1. Connect the left and right audio cable from the Amplifier's Audio IN jacks to this unit's AUDIO OUT jacks.
2. If desired, connect an external unit's Video IN jack to this unit's Video OUT jack.

SETTING THE MENUS

VIDEO SETUP MENU:

SETTING THE PICTURE

1

Video	
Picture	85
Brightness	60
Color	60
Sharpness	80
Hue	0
Color Temp.	Cool

Press the MENU button **1** once; the Video menu will appear. Press the CHANNEL Up **2** or Down **3** button until the desired picture setting is selected (PICTURE, BRIGHTNESS, COLOR, SHARPNESS, HUE).

NOTE: The HUE option is only available while there is input signal to VIDEO 1, VIDEO 2 & SVHS mode.

2

Video	
Picture	85
Brightness	60
Color	60
Sharpness	80
Hue	0
Color Temp.	Cool

Press the VOLUME Up **1** or Down **2** button to adjust the setting.

When done, press the MENU button **3** once to return to the Video menu.

3

Video	
Picture	85
Brightness	60
Color	60
Sharpness	80
Hue	0
Color Temp.	Cool

Press the CHANNEL Up **1** or Down **2** button until COLOR TEMP is selected.

4

Video	
Picture	85
Brightness	60
Color	60
Sharpness	80
Hue	0
Color Temp.	Cool

Press the VOLUME Up **1** or Down **2** button to set the desired color balance (COOL, NEUTRAL or WARM). When done, press the MENU button **3** twice to exit the menus.

AUDIO SETUP MENU:

1

Audio	
Volume	10

Press the MENU button **1** once; the Video menu will appear. Press the VOLUME Up **2** or Down **3** button to select the Audio setting.

2

Audio	
Volume	10

Press the CHANNEL Up **1** or Down **2** button until VOLUME is selected; volume will be highlighted in red. Press the VOLUME Up **3** or Down **4** button to set the desired volume.

NOTES:

- To exit the menus, press the EXIT button.
- Use the Volume Up/Down buttons to adjust the volume directly while in TV/AV mode.

SETTING THE MENUS (CONTINUED)

TIMER SETUP MENU:

SETTING THE CLOCK

1

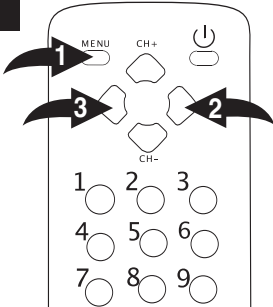

Timer

Clock	01:13
Time-On	--:--
Ch. Select	1
Time-Off	--:--
Sleep Time	0
Remind Time	--:--
Ch. Switch	1

Press the MENU button ❶ once; the Video menu will appear. Press the VOLUME Up ❷ or Down ❸ button to select the Timer setting.

2

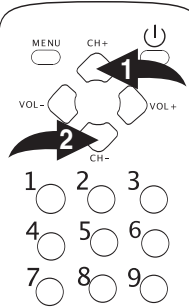

Timer

Clock	01:13
Time-On	--:--
Ch. Select	1
Time-Off	--:--
Sleep Time	0
Remind Time	--:--
Ch. Switch	1

Press the CHANNEL Up ❶ or Down ❷ button until CLOCK is selected; the hours will be highlighted in red.

NOTE: The clock is a 24 hour (military time) type clock.

3

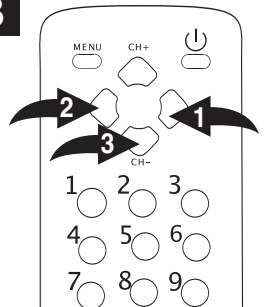

Timer

Clock	01:13
Time-On	--:--
Ch. Select	1
Time-Off	--:--
Sleep Time	0
Remind Time	--:--
Ch. Switch	1

Press the VOLUME Up ❶ or Down ❷ button to set the current hour, then press the CHANNEL Down button ❸; the minutes will be highlighted in red.

4

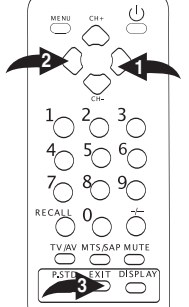

Timer

Clock	01:13
Time-On	--:--
Ch. Select	1
Time-Off	--:--
Sleep Time	0
Remind Time	--:--
Ch. Switch	1

Press the VOLUME Up ❶ or Down ❷ button to set the current minute. When done, press the EXIT button ❸ to exit the menus.

SETTING THE MENUS (CONTINUED)

SETTING THE ON TIMER

1

Timer

Clock	01:13
Time-On	--:--
Ch. Select	1
Time-Off	--:--
Sleep Time	0
Remind Time	--:--
Ch. Switch	1

Press the MENU button **1** once; the Video menu will appear. Press the VOLUME Up **2** or Down **3** button to select the Timer setting.

2

Timer

Clock	01:13
Time-On	12:--
Ch. Select	1
Time-Off	--:--
Sleep Time	0
Remind Time	--:--
Ch. Switch	1

Press the CHANNEL Up **1** or Down **2** button until TIME ON is selected; the hours will be highlighted in red.

3

Timer

Clock	01:13
Time-On	12:--
Ch. Select	1
Time-Off	--:--
Sleep Time	0
Remind Time	--:--
Ch. Switch	1

Press the VOLUME Up **1** or Down **2** button to set the desired On hour, then press the CHANNEL Down button **3**; the minutes will be highlighted in red.

4

Timer

Clock	01:13
Time-On	12:30
Ch. Select	1
Time-Off	--:--
Sleep Time	0
Remind Time	--:--
Ch. Switch	1

Press the VOLUME Up **1** or Down **2** button to set the desired On minute.

5

Timer

Clock	01:13
Time-On	12:30
Ch. Select	5
Time-Off	--:--
Sleep Time	0
Remind Time	--:--
Ch. Switch	1

Press the CHANNEL Down button until CH. SELECT is selected.

6

Timer

Clock	01:13
Time-On	12:30
Ch. Select	5
Time-Off	--:--
Sleep Time	0
Remind Time	--:--
Ch. Switch	1

Press the VOLUME Up **1** or Down **2** button to set the desired On Channel (the channel the unit will turn on to). When done, press the EXIT button **3** to exit the menus.

NOTE:

- When the actual time matches the "On time", the unit will automatically turn on.

SETTING THE MENUS (CONTINUED)

SETTING THE OFF TIMER

1

Timer	
Clock	01:13
Time-On	--:--
Ch. Select	1
Time-Off	--:--
Sleep Time	0
Remind Time	--:--
Ch. Switch	1

Press the MENU button **1** once; the Video menu will appear. Press the VOLUME Up **2** or Down **3** button to select the Timer setting.

2

Timer	
Clock	01:13
Time-On	12:30
Ch. Select	5
Time-Off	12:--
Sleep Time	0
Remind Time	--:--
Ch. Switch	1

Press the CHANNEL Up **1** or Down **2** button until TIME OFF is selected; the hours will be highlighted in red.

3

Timer	
Clock	01:13
Time-On	12:30
Ch. Select	5
Time-Off	12:45
Sleep Time	0
Remind Time	--:--
Ch. Switch	1

Press the VOLUME Up **1** or Down **2** button to set the desired Off hour, then press the CHANNEL Down button **3**; the minutes will be highlighted in red.

4

Timer	
Clock	01:13
Time-On	12:30
Ch. Select	5
Time-Off	12:45
Sleep Time	0
Remind Time	--:--
Ch. Switch	1

Press the VOLUME Up **1** or Down **2** button to set the desired Off minute. When done, press the EXIT button **3** to exit the menus.

NOTE:

- When the actual time matches the "Off time", the unit will automatically turn off.

SETTING THE SLEEP TIMER

1

Timer	
Clock	01:13
Time-On	12:30
Ch. Select	5
Time-Off	12:45
Sleep Time	10
Remind Time	--:--
Ch. Switch	1

Press the MENU button **1** once; the Video menu will appear. Press the VOLUME Up **2** or Down **3** button to select the Timer setting. Press the CHANNEL Up **4** or Down **5** button until SLEEP TIME is selected.

2

Timer	
Clock	01:13
Time-On	12:30
Ch. Select	5
Time-Off	12:45
Sleep Time	10
Remind Time	--:--
Ch. Switch	1

Press the VOLUME Up **1** or Down **2** button to set the desired Sleep Time. When done, press the EXIT button **3** to exit the menus. The sleep timer will count down and when it reaches 0, the unit will turn off.

NOTE: For the Sleep Timer, you can select from 0-180. For example, set to 10 for the unit to turn off automatically after 10 minutes; set to 180 or the unit to turn off automatically after 180 minutes.

SETTING THE MENUS (CONTINUED)

SETTING THE REMIND TIMER

1

Timer

Clock	01:13
Time-On	--:--
Ch. Select	1
Time-Off	--:--
Sleep Time	0
Remind Time	--:--
Ch. Switch	1

Press the MENU button **1** once; the Video menu will appear. Press the VOLUME Up **2** or Down **3** button to select the Timer setting.

2

Timer

Clock	01:13
Time-On	12:30
Ch. Select	5
Time-Off	12:45
Sleep Time	0
Remind Time	16:--
Ch. Switch	1

Press the CHANNEL Up **1** or Down **2** button until REMIND TIME is selected; the hours will be highlighted in red.

3

Timer

Clock	01:13
Time-On	12:30
Ch. Select	5
Time-Off	12:45
Sleep Time	0
Remind Time	16:30
Ch. Switch	1

Press the VOLUME Up **1** or Down **2** button to set the desired Remind hour, then press the CHANNEL Down button **3**; the minutes will be highlighted in red.

4

Timer

Clock	01:13
Time-On	12:30
Ch. Select	5
Time-Off	12:45
Sleep Time	0
Remind Time	16:30
Ch. Switch	1

Press the VOLUME Up **1** or Down **2** button to set the desired Remind minute.

5

Timer

Clock	01:13
Time-On	12:30
Ch. Select	5
Time-Off	12:45
Sleep Time	0
Remind Time	--:--
Ch. Switch	7

Press the CHANNEL Down button **1**, CH.SWITCH will be highlighted in red. Press the VOLUME Up **2** or Down **3** button to set the desired channel which you want to switch to when the actual time reaches the Remind Time. When done, press the MENU button **4** repeatedly to exit the menus.

NOTE:

- When the actual time matches the "Remind time", the TV will switch to the channel which you set. This is useful so that you won't miss a favorite TV program while you are watching another program on a different channel.

SETTING THE MENUS (CONTINUED)

SETUP MENU:

SETTING THE LANGUAGE

1

Setup	
Language	English
Background	On
Black Stretch	On
VNR	On
Fade	Off
C. Caption	CC1
Demo Mode	

Press the MENU button **1** once; the Video menu will appear. Press the VOLUME Up **2** or Down **3** button to select the Setup setting. Press the CHANNEL Up **4** or Down **5** button until LANGUAGE is selected.

2

Press the VOLUME Up **1** or Down **2** button to set the desired Language (ENGLISH, FRENCH or SPANISH). When done, press the EXIT button **3** to exit the menus.

SETTING THE BACKGROUND (TV/CATV MODE ONLY)

1

Setup	
Language	English
Background	On
Black Stretch	On
VNR	On
Fade	Off
C. Caption	CC1
Demo Mode	

Press the MENU button **1** once; the Video menu will appear. Press the VOLUME Up **2** or Down **3** button to select the Setup setting. Press the CHANNEL Up **4** or Down **5** button until BACKGROUND is selected.

2

Press the VOLUME Up **1** or Down **2** button to turn the Background ON (the background will be blue if no signal is received) or OFF. When done, press the EXIT button **3** to exit the menus.

SETTING THE BLACK STRETCH

1

Setup	
Language	English
Background	On
Black Stretch	On
VNR	On
Fade	Off
C. Caption	CC1
Demo Mode	

Press the MENU button **1** once; the Video menu will appear. Press the VOLUME Up **2** or Down **3** button to select the Setup setting. Press the CHANNEL Up **4** or Down **5** button until BLACK STRETCH is selected.

2

Press the VOLUME Up **1** or Down **2** button to turn the Background ON (the contrast range will automatically be increased) or OFF. When done, press the EXIT button **3** to exit the menus.

SETTING THE MENUS (CONTINUED)

SETTING THE VNR (VIDEO NOISE REDUCTION)

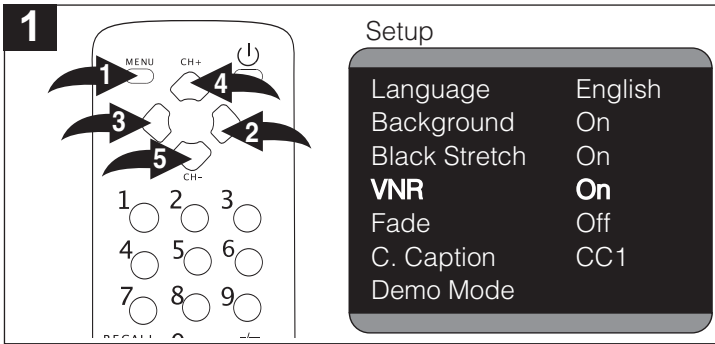

Press the MENU button **1** once; the Video menu will appear. Press the VOLUME Up **2** or Down **3** button to select the Setup setting. Press the CHANNEL Up **4** or Down **5** button until VNR is selected.

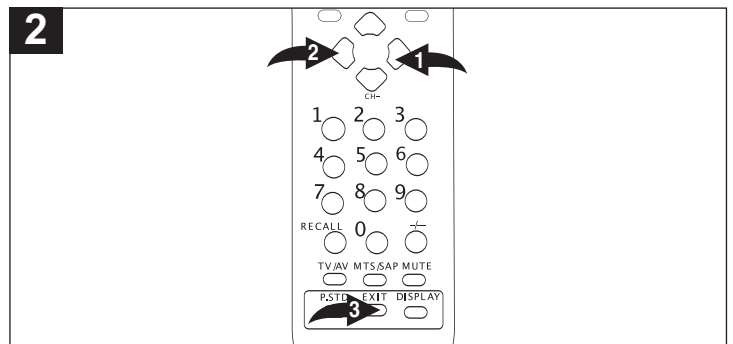

Press the VOLUME Up **1** or Down **2** button to turn the VNR ON (this will allow the picture tube to warm up and gently turn on, thus increasing the life of the picture tube) or OFF. When done, press the EXIT button **3** to exit the menus.

SETTING THE FADE

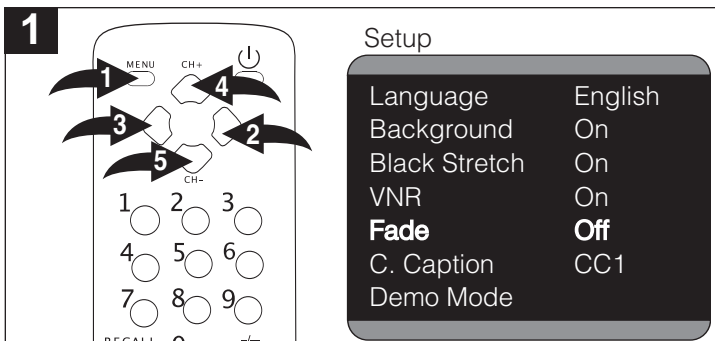

Press the MENU button **1** once; the Video menu will appear. Press the VOLUME Up **2** or Down **3** button to select the Setup setting. Press the CHANNEL Up **4** or Down **5** button until FADE is selected.

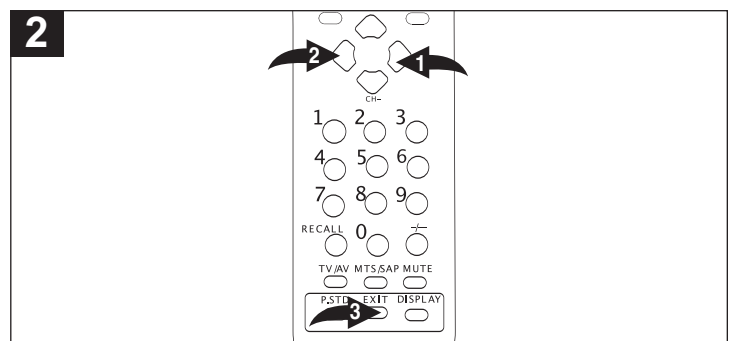

Press the VOLUME Up **1** or Down **2** button to turn the Fade ON (While the Fade function is on, the picture will fade in when the TV is turned on and fade out when it is turned off.) or OFF. When done, press the EXIT button **3** to exit the menus.

SETTING THE MENUS (CONTINUED)

SETTING THE CLOSED CAPTIONS

1

Setup

Language	English
Background	On
Black Stretch	On
VNR	On
Fade	Off
C. Caption	CC1
Demo Mode	

Press the MENU button **1** once; the Video menu will appear. Press the VOLUME Up **2** or Down **3** button to select the Setup setting. Press the CHANNEL Up **4** or Down **5** button until C. CAPTION is selected.

2

Press the VOLUME Up **1** or Down **2** button to turn Closed Captions off or on and select a mode (see page 31 for details). When done, press the EXIT button **3** to exit the menus.

SETTING THE TV TO DEMO MODE

1

Setup

Language	English
Background	On
Black Stretch	On
VNR	On
Fade	Off
C. Caption	CC1
Demo Mode	

Press the MENU button **1** once; the Video menu will appear. Press the VOLUME Up **2** or Down **3** button to select the Setup setting. Press the CHANNEL Up **4** or Down **5** button until DEMO MODE is selected.

2

Press the VOLUME Up button to activate the Demo mode; the unit will then enter the Demo mode and the screen will show various features.

3

To stop Demo mode, press the EXIT button.

SETTING THE MENUS (CONTINUED)

CHANNEL SETUP MENU:

SETTING THE CHANNEL SYSTEM

1

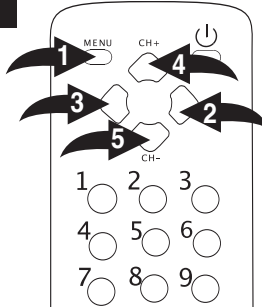

Channel	
Channel System	Auto
Antenna	CATV
Skip	Off
Current Ch.	13
Fine	
Auto Program	

2

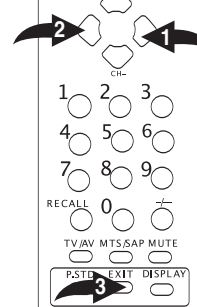

Press the MENU button ❶ once; the Video menu will appear. Press the VOLUME Up ❷ or Down ❸ button to select the Channel Setting. Press the CHANNEL Up ❹ or Down ❺ button until CHANNEL SYSTEM is selected.

Press the VOLUME Up ❶ or Down ❷ button to set the desired Channel System (AUTO, NTSC or NTSC443). When done, press the EXIT button ❸ to exit the menus.
NOTE: In the USA, the system is NTSC.

SETTING THE FINE TUNING

1

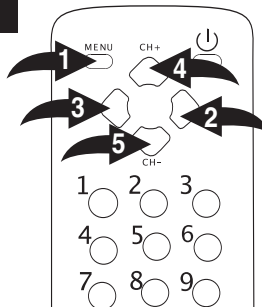

Channel	
Channel System	Auto
Antenna	CATV
Skip	Off
Current Ch.	13
Fine	
Auto Program	

2

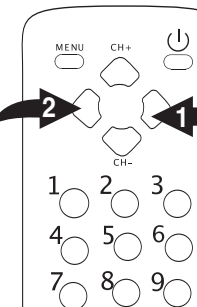

While in the TV mode, press the MENU button ❶ once; the Video menu will appear. Press the VOLUME Up ❷ or Down ❸ button to select the Channel Setting. Press the CHANNEL Up ❹ or Down ❺ button until CURRENT CH. is selected.

Press the VOLUME Up ❶ or Down ❷ button to select a desired channel to fine tune.

3

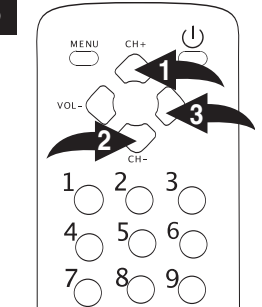

Channel	
Channel System	Auto
Antenna	CATV
Skip	Off
Current Ch.	13
Fine	
Auto Program	

4

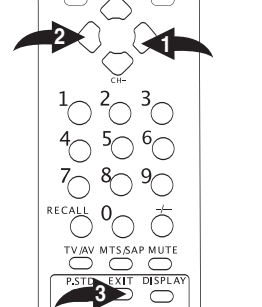

Press the CHANNEL Up ❶ or Down ❷ button until FINE is selected, then press the VOLUME Up button ❸.

Fine tune the channel using the VOLUME Up ❶ or Down ❷ button. When done, press the EXIT button ❸ to exit the menus.

SETTING THE MENUS (CONTINUED)

SETTING CHANNELS INTO MEMORY

This unit is equipped with a channel memory feature which allows channels to skip up or down to the next channels set into memory, skipping over unwanted channels. Before selecting channels, they must be programmed into the unit's memory. In addition to normal VHF/UHF channels, this unit can receive up to 125 Cable TV channels.

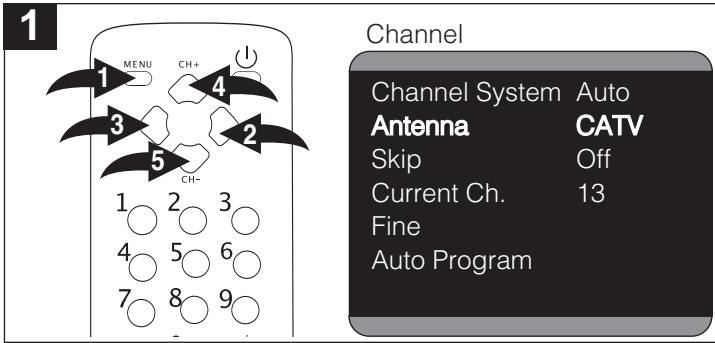

While in the TV mode, press the MENU button ❶ once; the Video menu will appear. Press the VOLUME Up ❷ or Down ❸ button to select the Channel Setting. Press the CHANNEL Up ❹ or Down ❺ button until ANTENNA is selected.

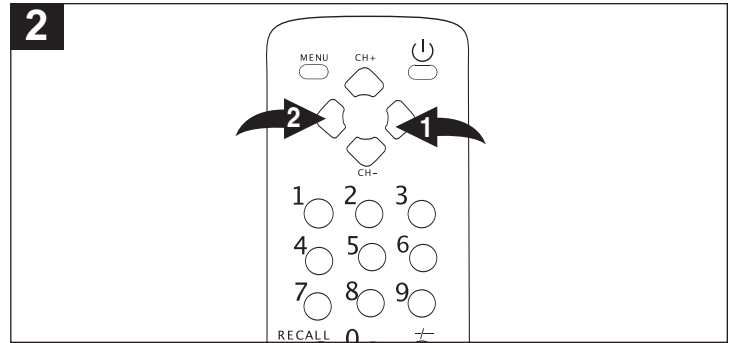

Press the VOLUME Up ❶ or Down ❷ button to select TV (VHF/UHF Channels) or CATV (Cable TV).

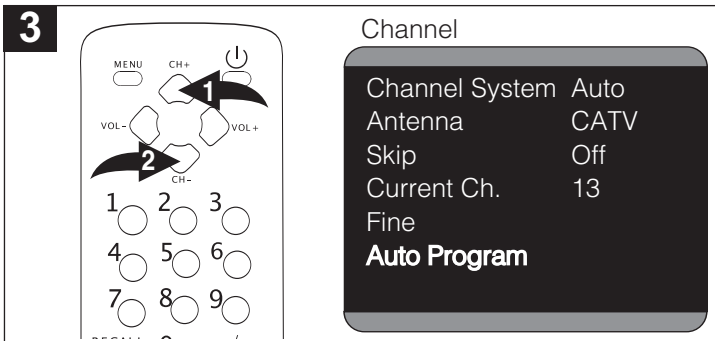

Press the CHANNEL Up ❶ or Down ❷ button until AUTO PROGRAM is selected.

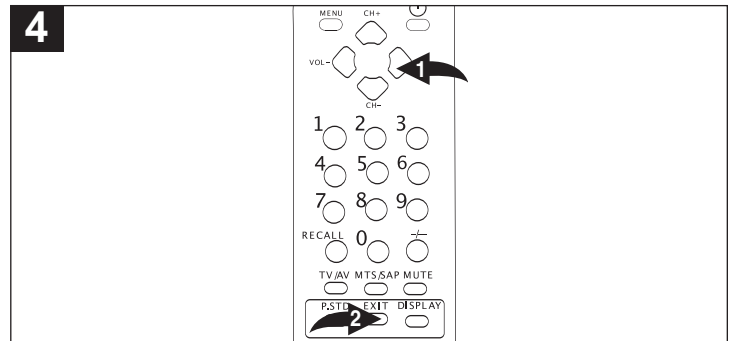

Press the VOLUME Up button ❶ to start Auto Programming and the unit will automatically cycle through all the channels and store active channels into memory. When finished, press the EXIT button ❷ to exit the menu settings.

FAQs:

How many channels will I actually receive?

The actual number of channels that can be received depends on how many channels your cable or satellite company, or local area, provides. Contact your company to determine the number of channels in your area.

SETTING THE MENUS (CONTINUED)

ADDING AND DELETING CHANNELS

After setting channels into memory, you can add or delete channels as follows:

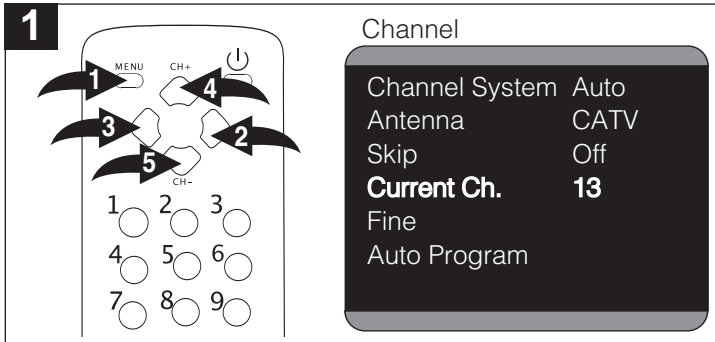

While in the TV mode, press the MENU button ❶ once; the Video menu will appear. Press the VOLUME Up ❷ or Down ❸ button to select the Channel Setting. Press the CHANNEL Up ❹ or Down ❺ button until CURRENT CH. is selected.

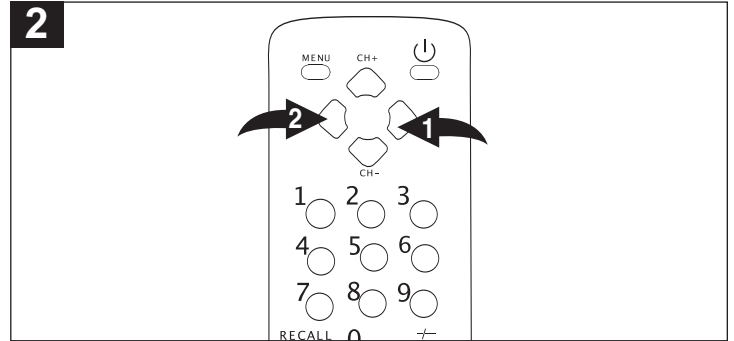

Press the VOLUME Up ❶ or Down ❷ button to select a desired channel to add or delete.

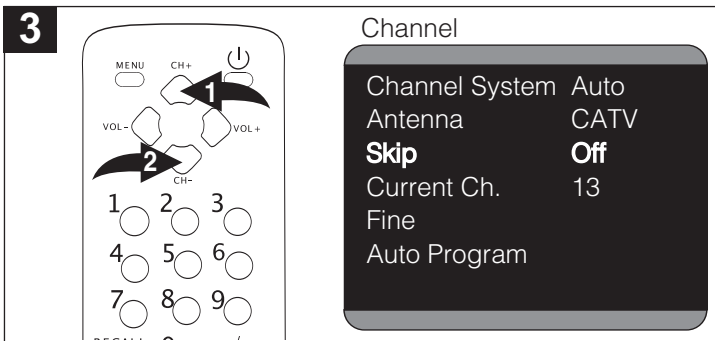

Press the CHANNEL Up ❶ or Down ❷ button until SKIP is selected.

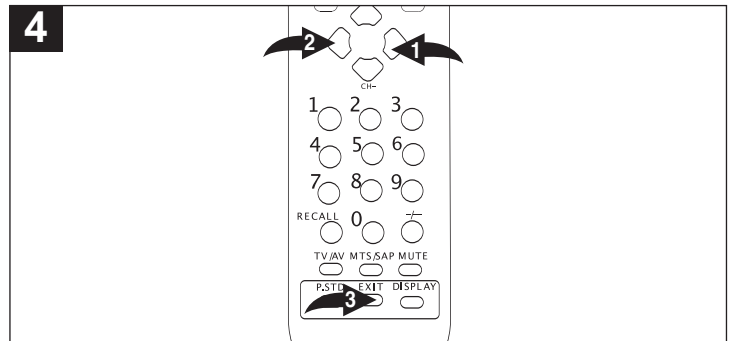

Press the VOLUME Up ❶ or Down ❷ button to turn Skip feature ON (to skip the channel) or OFF (to memorize the channel). When done, press the EXIT button ❸ to exit the menus.

SETTING THE MENUS (CONTINUED)

CALENDAR SETUP MENU:

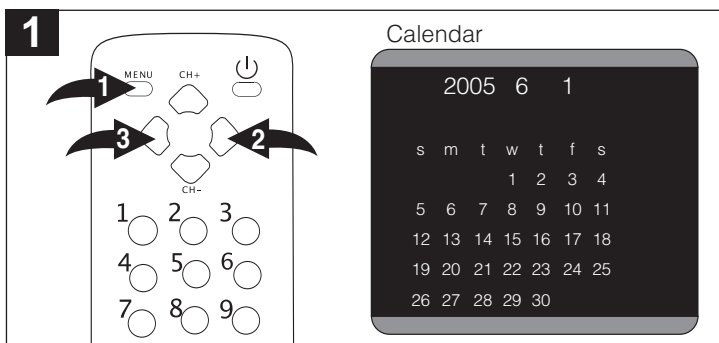

Press the MENU button ❶ once; the Video menu will appear. Press the VOLUME Up ❷ or Down ❸ button to select the Calendar setting.

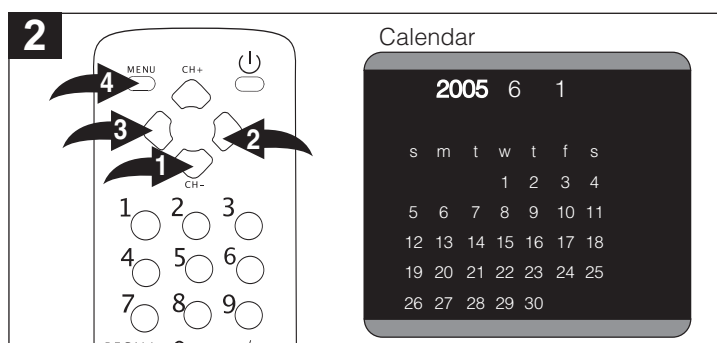

Press the CHANNEL Down button ❶ until the year is selected. Press the VOLUME Up ❷ or Down ❸ button to set the year, then press the CHANNEL Down button ❶; the month will be highlighted.

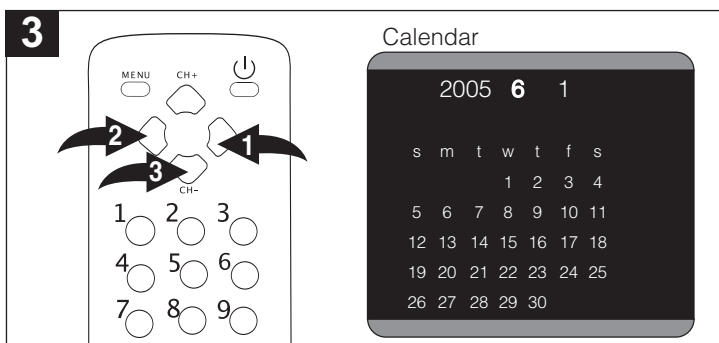

Press the VOLUME Up ❶ or Down ❷ button to set the month, then press the CHANNEL Down button ❸; the day will be highlighted.

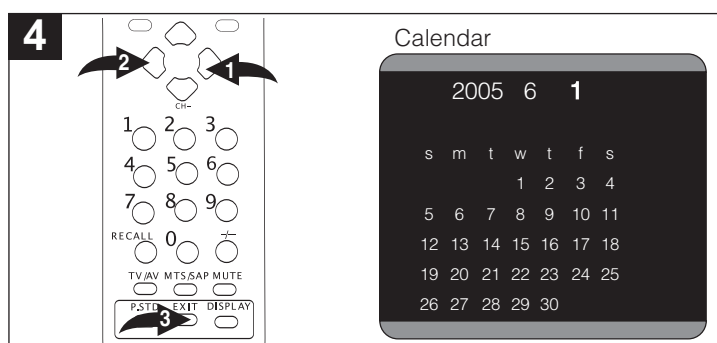

Press the VOLUME Up ❶ or Down ❷ button to set the day. When done, press the EXIT button ❸ to exit the menus.

TV PARENTAL CONTROL

V-Chip enables parents to prevent their children from watching inappropriate material on TV. V-Chip reads the ratings for programming (except for news, sports, unedited movies on premium cable and Emergency System signals), then denies access to programming if the program's rating meets the limitations you select. In this case, the program will be blocked.

PARENTAL CONTROL SET-UP

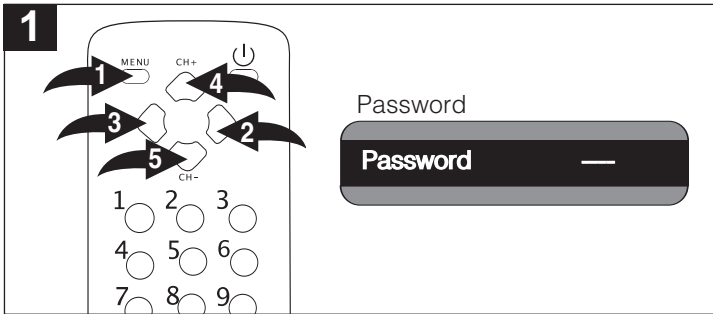

Press the MENU button ❶ once; the Video menu will appear. Press the VOLUME Up ❷ or Down ❸ button to select the Password. Press the CHANNEL Up ❹ or Down ❺ button until PASSWORD is highlighted in red.

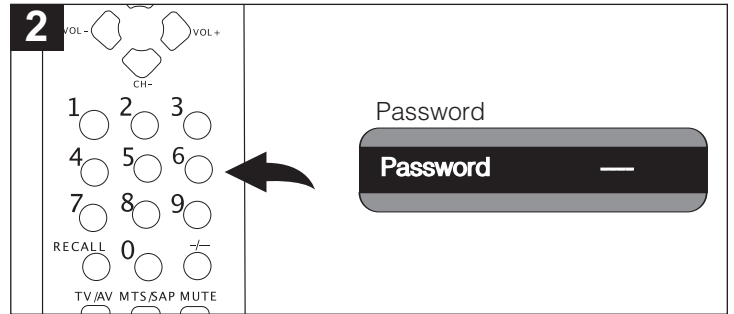

You will be prompted to enter the password to enter this menu. Enter the four digit password (The default password is 1234) using the Direct Channel Selection/Number (0-9) buttons.

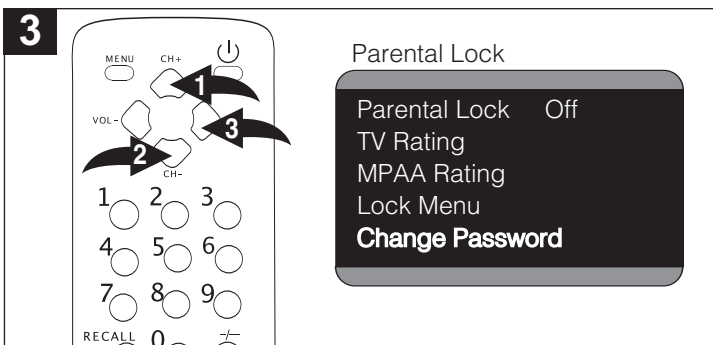

TO CHANGE THE PASSWORD: After entering the menu, press the CHANNEL Up ❶ or Down ❷ button until CHANGE PASSWORD is selected, then press the VOLUME Up button ❸.

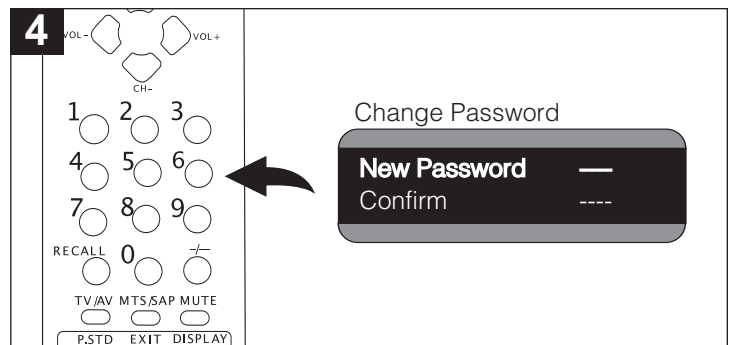

Using the Direct Channel Selection/Number (0-9) buttons, enter the desired password, then enter again to confirm and make sure to write it down.

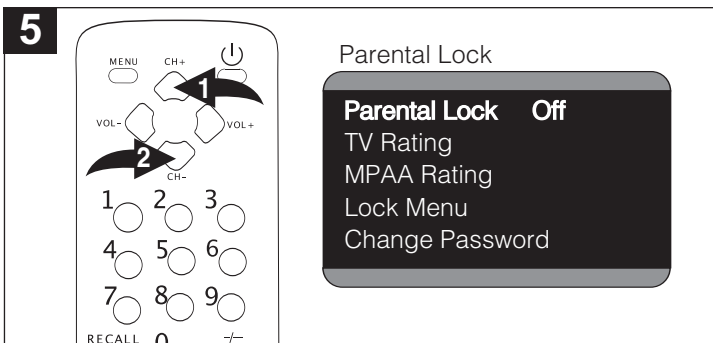

Press the CHANNEL Up ❶ or Down ❷ button until PARENTAL LOCK is selected.

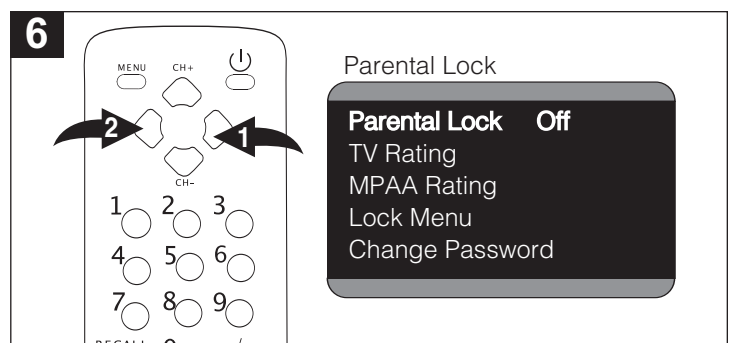

Press the VOLUME Up ❶ or Down ❷ button to turn PARENTAL LOCK option On or Off.

NOTE: To exit the menus, press the Exit button.

TV PARENTAL CONTROL (CONTINUED)

TV RATING SET-UP

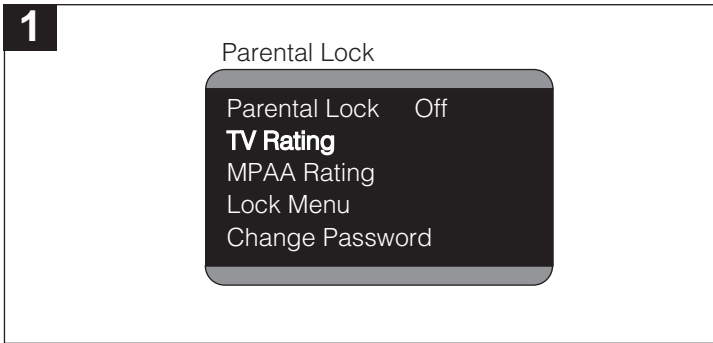

Enter the Parental Lock menu and turn on the V-chip option as described on page 24 (steps 1 and 2).

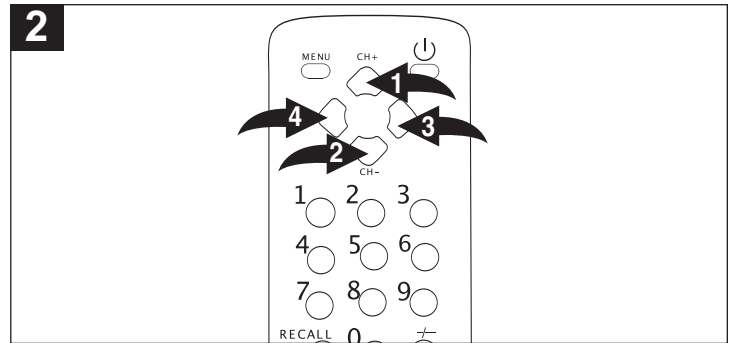

Press the CHANNEL Up **1** or Down **2** button until TV RATING is selected, then the VOLUME Up **3** or Down **4** button to select it.

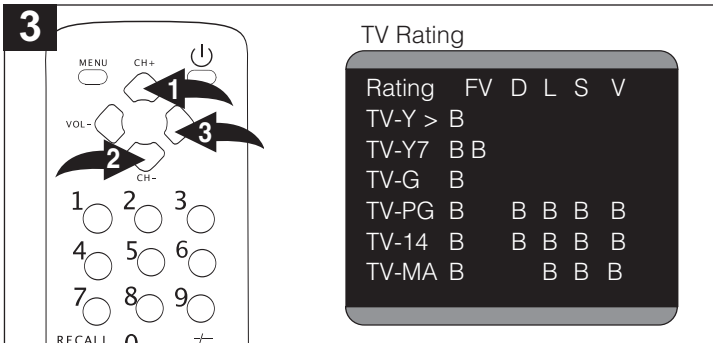

Press the CHANNEL Up **1** or Down **2** button to select a rating and then the VOLUME Up button **3** to BLOCK (ratings at or above cannot be viewed) or UNBLOCK (ratings at or under can be viewed).

Y: All ages less than 14 years old
Y7: Ages 7 and up old
G: General Audience **MA:** Mature Audiences Only
PG: Parental Guidance
14: Parental Guidance

"B" is Blocked and "U" is Unblocked.

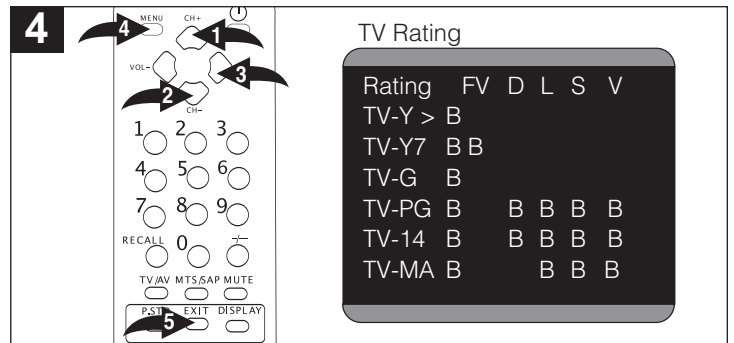

You can also block some or all criteria for each level for Fantasy Violence (FV), Sexual Dialogue (D), Language (L), Sexual Situations (S) or Violence (V).

Using the CHANNEL Up **1** or Down **2** button, select the desired criteria (to reach the criteria, cycle through the columns using these buttons), then press the VOLUME Up button **3** to turn the option On or Off.

When finished, press the Menu button **4** to return to the Parental Lock menu or press the Exit button **5** to exit the menus.

TV PARENTAL CONTROL (CONTINUED)

MPAA RATING SET-UP

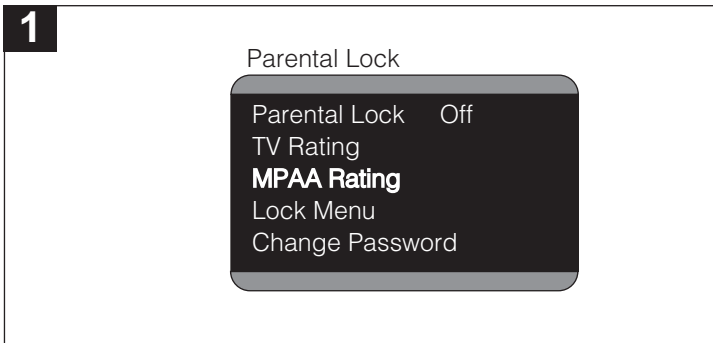

Enter the Parental Lock menu and turn on the V-chip option as described on page 24 (steps 1 and 2).

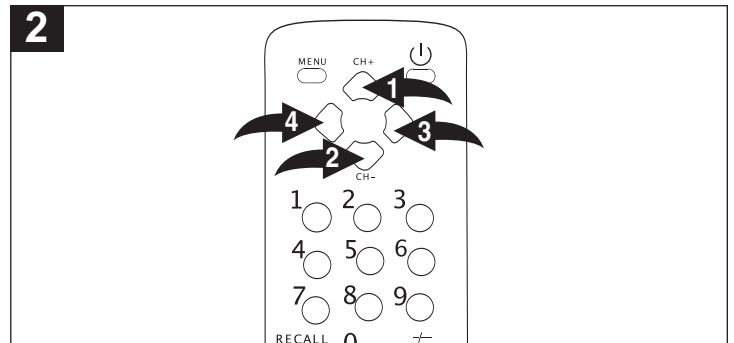

Press the CHANNEL Up **1** or Down **2** button until MPAA RATING is selected, then press the VOLUME Up **3** or Down **4** button to select it.

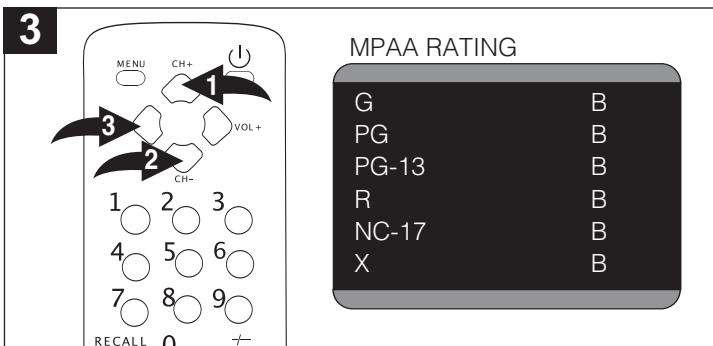

Press the CHANNEL Up **1** or Down **2** button to select a rating and then the VOLUME Down button **3** to BLOCK (ratings at or above cannot be viewed) or UNBLOCK (ratings at or under can be viewed).

G: All ages	R: Under 17 years old,
PG: Parental Guidance	Parental Guidance
PG-13: Parental Guidance	suggested
less than 13 years	NC17: 17 years old and
old	above
	X: Adult only

"B" is Blocked and "U" is Unblocked.

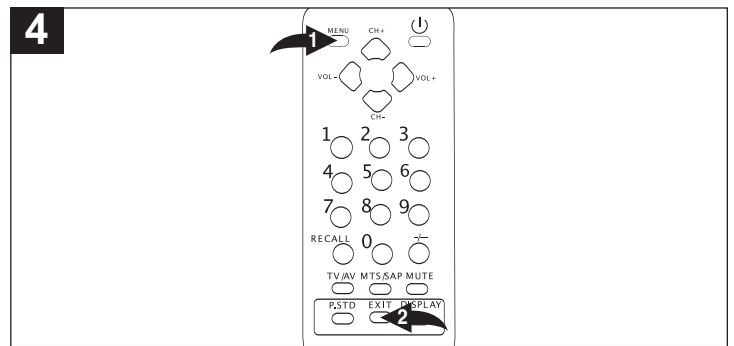

When finished, press the Menu button **1** to return to the Parental Lock menu or press the Exit button **2** to exit the menus.

TV PARENTAL CONTROL (CONTINUED)

LOCK MENU

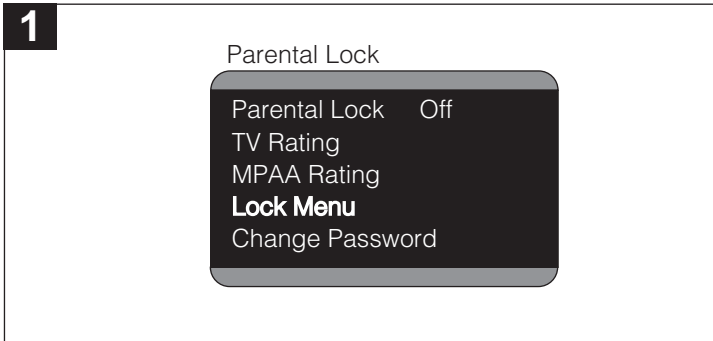

Enter the Parental Lock menu and turn on the V-chip option as described on page 24 (steps 1 and 2).

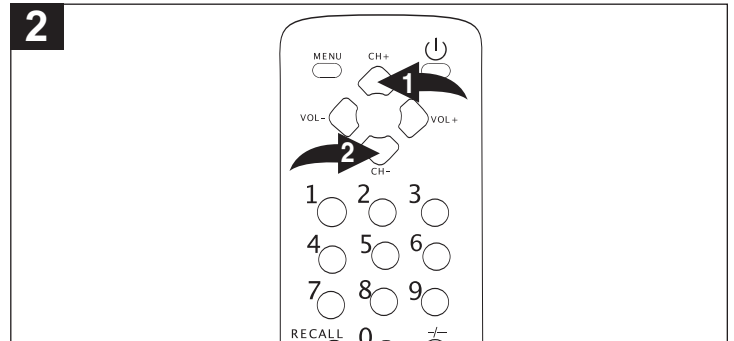

Press the CHANNEL Up **1** or Down **2** button until LOCK MENU is selected.

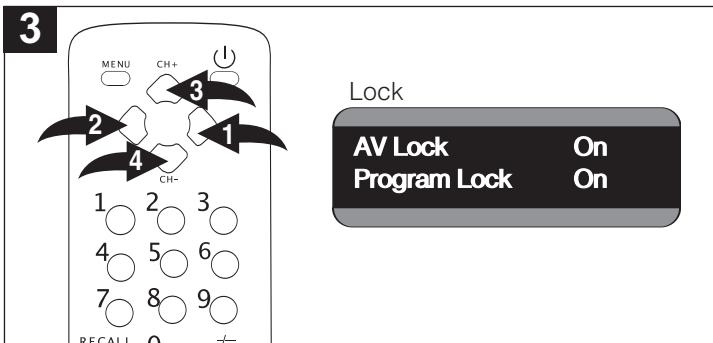

Press the VOLUME Up **1** or Down **2** to enter the Lock menu. Press the CHANNEL Up **3** or Down **4** button to select AV Lock or Program Lock. Press the VOLUME Up **1** or Down **2** to turn the option ON or OFF.

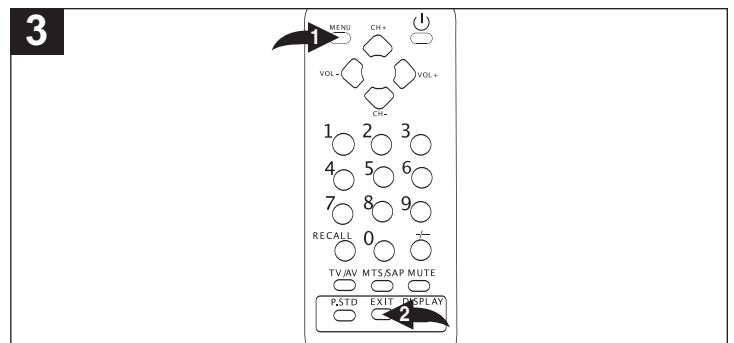

When finished, press the Menu button **1** to return to the Parental Lock menu or press the Exit button **2** to exit the menus.

NOTE: When AV Lock is ON, the Audio/Video connections will be locked (cannot be used).

For Program Lock, you must select the channel which needs to be locked before entering the Parental Lock menu in step 1. When Program Lock is ON, the selected channel will be locked.

TV BASIC OPERATION

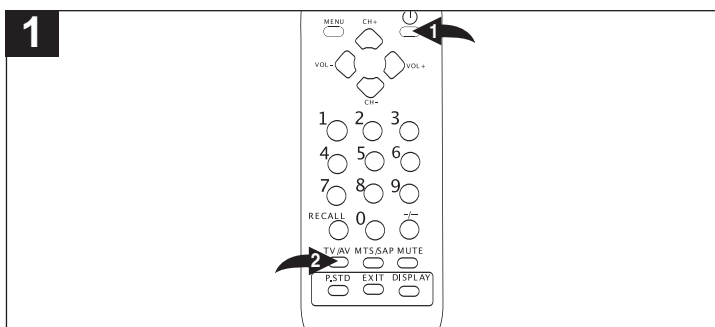

Press the **POWER** button ❶ on the remote, or front of the unit, to turn on the unit; the **POWER** indicator will light green. Press the **TV/AV** button ❷ repeatedly to select the TV mode.

2 OPTIONS

TV: If using a VHF/UHF antenna.

CATV: If using Cable TV.

Change the Antenna option to select between TV or CATV. Select TV if using VHF/UHF antenna, and select CATV if using Cable TV (see page 21, steps 1 and 2).

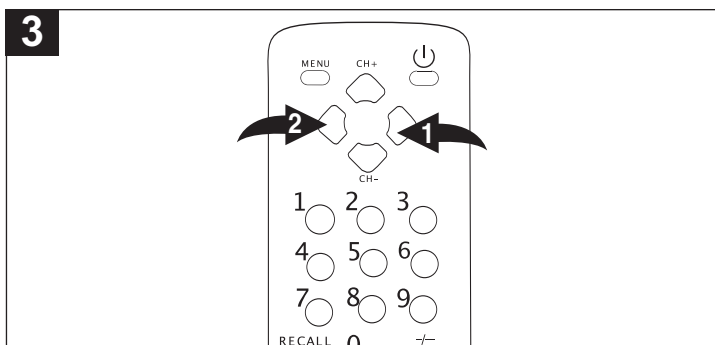

Adjust the volume level by pressing the **VOLUME Up** ❶ or **Down** ❷ button.

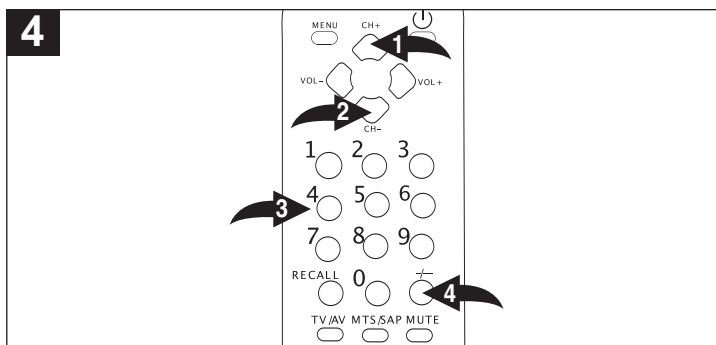

For proper operation, before selecting channels, they must be set into the unit's Program memory, see page 21. Press and release the **CHANNEL Up** ❶ or **Down** ❷ button. The unit automatically stops at the next channel set into memory.

Direct Program Selection/Number buttons (0-9) ❸
Use these buttons to select a channel.

- For Channels 1 through 9, press 1-9 ❸ as desired.
- For Channels 10 through 99, press **-/--** button ❹ once, then enter the 2 digit channel number in order.
- For Channels 100 through 125, press **-/--** button ❹ twice, then enter the 3 digit channel number in order.

NOTES:

- When **ANTENNA** option is set to TV, only channels up to 69 can be chosen. When set to CATV, channels up to 125 can be chosen.

FAQs:

Why do I only receive 69 channels, when my cable goes much higher?
The TV/CATV option must be set to CATV when using cable, see step 2 above.

Why are some channels scrambled?
You must subscribe to these channels through your cable company.

HEADPHONE JACK (SIDE OF UNIT)
For private listening, connect 3.5mm (32 ohm) stereo headphones (not included) to this jack. The speakers are automatically disconnected when the headphone plug is inserted in the jack.

TV BASIC OPERATION (CONTINUED)

DISPLAY

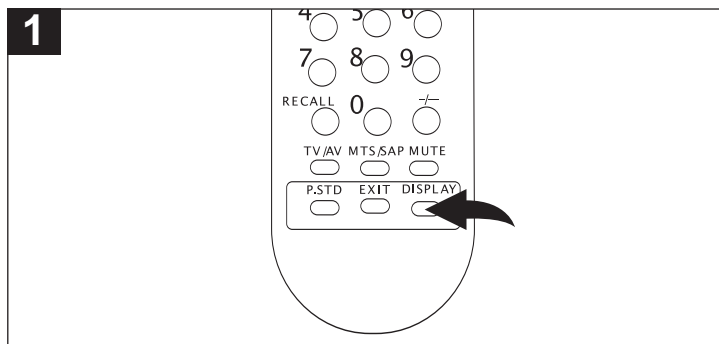

Press the DISPLAY button once to display the current information on the screen (Channel number or Video mode). Press again to clear.

RECALL

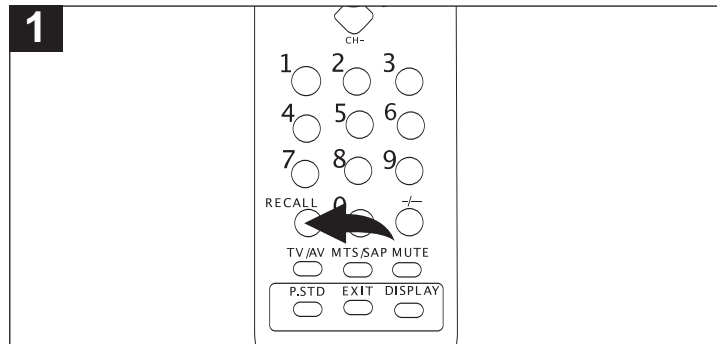

Press the RECALL button to switch between the present channel and the last channel chosen.

FAQ:

How do I watch the device connected to the side audio/video jacks?

Press the TV/AV button as described in the step at the top left of the next page.

MUTE

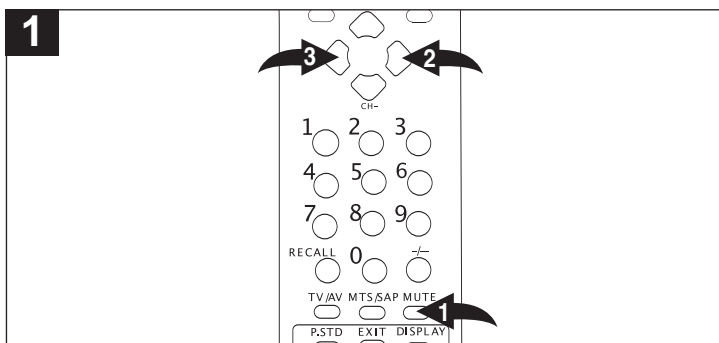

Press the Mute button ❶ to turn off the sound; the TV's sound will be silenced and "Mute" will appear on the screen. The sound can be turned back on by pressing this button again or one of the VOLUME Up ❷ or Down ❸ buttons; "Mute" will disappear from the screen.

TV BASIC OPERATION (CONTINUED)

VOLUME Buttons

Set the sound as follows:

TV/AV

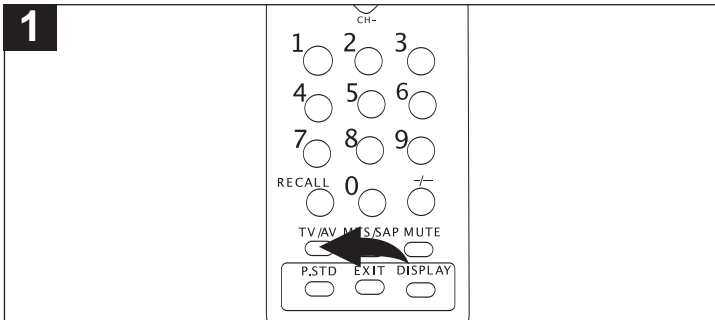

Press to select TV (CATV), VIDEO 1 (Side jacks), VIDEO 2 (Rear jacks) or SVHS (S-Video jack).

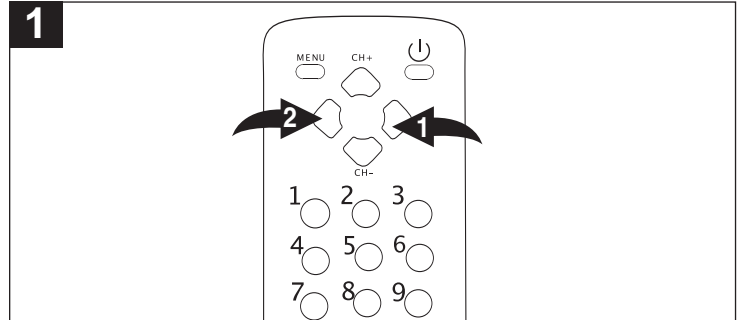

Press the VOLUME Up ①/Down ② buttons to adjust the sound level.

P.STD (Picture Standard)

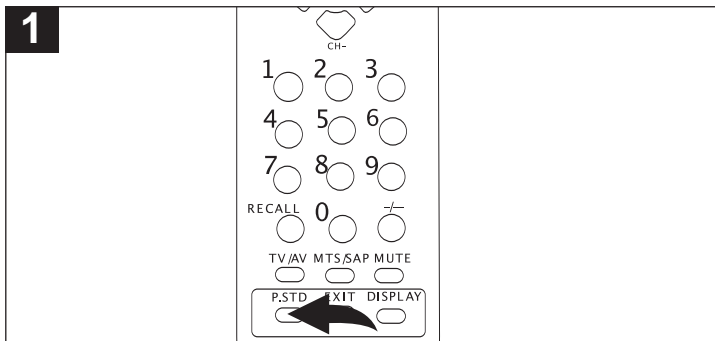

Press to select between the picture modes (Standard, Vivid, Personal, Listen {select just to listen, not to watch}, or Movie).

MTS/SAP

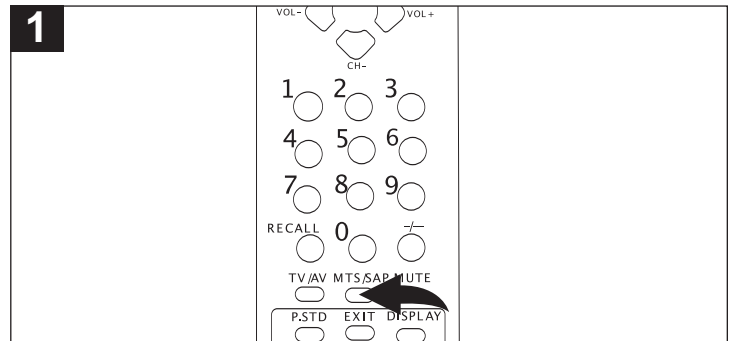

Press to select between Auto Sap (Second Audio Program), Stereo or Mono.

NOTE: This function is for TV mode only.

CLOSED CAPTIONS

WHAT IS CLOSED CAPTIONING?

This television has the capability to decode and display Closed Captioned television programs. Closed Captioning will display text on the screen for hearing-impaired viewers or it will translate and display text in another language.

CLOSED CAPTIONING WITH A VCR

Closed Captioned programs can be recorded and played back on a VCR with the Closed Captioned text intact. The Closed Captioned text will disappear during Cue (Fast Forward Search), Review (Rewind Search) and Pause modes or if the VCR tracking is not adjusted properly.

TO VIEW CLOSED CAPTIONS

Select the CC option in the menu to switch between normal TV and the Closed Caption Modes (Captions and Full Screen Text).

CC1: This Closed Caption Mode will display text on the screen in English or another language. Generally, Closed Captions in English are transmitted on Captions 1.

CC2-4: These Closed Caption Modes will display text on the screen in English or another language. Generally, Closed

Captions in other languages are transmitted on these channels.

TEXT: The Text Closed Caption Mode will usually fill the screen with a programming schedule or other information. Select between T1, T2, T3 or T4.

After selecting a Closed Caption Mode, it will stay in effect until it is changed, even if the channel is changed. If the Captions signal is lost due to a commercial or a break in the signal, the Captions will reappear when the signal is received again. If the channels are changed, the Captions will be delayed approximately 10 seconds.

The Captions will appear in places on the screen where they will least interfere with the picture, usually on the bottom of the screen. News programs will usually show three-line Closed Captions which scroll onto the screen. Most other shows provide two or three lined Captions placed near the character who is speaking so the viewer can follow the dialogue.

Words in italics or underlined describe titles, words in foreign languages or words requiring emphasis. Words that are sung usually appear enclosed by musical notes.

For television programs broadcasting with Closed Captions, look in your TV guide for the Closed Captions symbol (CC).

NOTES:

- When selecting Closed Captions, the captioning will be delayed approximately 10 seconds.
- Misspellings or unusual characters may occasionally appear during Closed Captioning. This is normal with Closed Captioning, especially with live programs. This is because during live programs, captions are also entered live. These transmissions do not allow time for editing.
- When Captions are being displayed, on-screen displays, such as Mute, may not be seen or may interfere with Closed Captions.
- Some cable systems and copy protection systems may interfere with the Closed Captioned signal.
- If using an indoor antenna or if TV reception is very poor, the Closed Caption Decoder may not appear or may appear with strange characters or misspelled words. In this case, adjust the antenna for better reception or use an outdoor antenna.

FAQs:

When I press the RECALL or MUTE button, the captions do not appear, is this normal?

Yes, this is normal for this unit. Once the display information disappears, the captions will continue.

I entered the Captions mode, but no captions are appearing, why?

If no caption signal is received, no captions will appear, but the television will remain in the Caption mode.

Why is there a big black box on the screen?

Because you are in a Captions mode. Turn the captions off, or select a different Captions mode.

NOTE: To set the CLOSED CAPTIONS option, please see page 19.

TROUBLESHOOTING GUIDE

Check the following before requesting service.

SYMPTOM	POSSIBLE CAUSE	POSSIBLE SOLUTION
POWER		
No power.	The AC power cord is not connected.	Connect the AC power cord to the AC outlet.
TV BROADCAST RECEPTION		
Poor or no picture.	TV station experiencing problems.	Try another channel.
	Picture control is not adjusted.	Check picture control adjustments.
	Possible local interference.	Check for source of reception disturbance.
	Antenna/CATV connector is not connected.	Check CATV connection or VHF/UHF antenna.
Picture wobbles or drifts.	TV station experiencing problems.	Try another channel.
	Cable TV channel is scrambled.	A cable box needs to be used (if desired).
	Possible local interference.	Check for source of reception disturbance.
No CATV reception.	CATV connected incorrectly or not connected.	Check all CATV connections.
	ANTENNA option set to TV.	Set ANTENNA option to CATV.
	Cable TV service interrupted.	Contact your Cable TV company.
No reception above ch13.	ANTENNA option set to TV.	Set ANTENNA option to CATV.
Poor or no sound.	TV station experiencing problems.	Try another channel.
	MUTE button is pressed.	Press MUTE button again.
	Possible local interference.	Check for source of reception disturbance.
	Antenna/CATV connector is not connected.	Check CATV connection or VHF/UHF antenna.
	Volume is set to minimum.	Increase volume.
TV shuts off.	TV station stopped broadcasting.	Tune to a new channel.
	Sleep Timer is set.	Turn off Sleep Timer function.
	Home circuit breaker is blown.	Reset or replace breaker.
Closed Captioning not working.	TV Signal is weak.	Check CATV or VHF/UHF antenna.
	TV station experiencing problems or program tuned is not closed captioned.	Try another channel.
	Closed Captioning not turned on.	Turn on via the menu.
REMOTE CONTROL		
Remote control does not operate.	The remote control is not aimed at the sensor.	Aim the remote control at the Remote Sensor.
	Distance is too far or too much light in the room.	Operate within 20 feet or reduce the light in the room.
	There is an obstacle in the path of the beam.	Clear the path of the beam.
	The batteries are weak.	Replace the batteries.
	The batteries are not inserted correctly.	Insert correctly.
V-CHIP		
Parental Control not working properly.	Parental Control setting is turned off.	Turn Parental Control setting on.
	News or sports event being broadcast.	Parental Control does not work with news or sporting events.
	Ratings not set.	Set ratings as desired.

RECEPTION DISTURBANCES

Most types of television interference can be remedied by adjusting the height and position of the VHF/UHF antenna. Outdoor antennas are recommended for best results if not using cable or a satellite. The most common types of television interference are shown below. If one of these symptoms appear when the TV is connected to a Cable TV system, the disturbance may be caused by the local cable company broadcast.

IGNITION:

Black spots or horizontal streaks may appear, picture may flutter or drift. Usually caused by interference from automobile ignition systems, neon lamps, electric drills and other electric appliances.



GHOSTS:

Ghosts are caused by the television signal following two paths. One is the direct path and the other is reflected from tall buildings, hills or other objects. Changing the direction or position of the antenna may improve the reception.

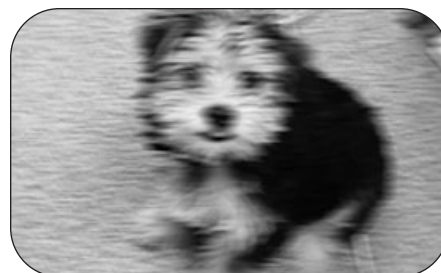

SNOW:

If your receiver is located in the fringe area of a television station where the signal is weak, your picture may be marred by the appearance of small dots. When the signal is extremely weak, it may be necessary to install an external antenna to improve the picture.



RADIO FREQUENCY INTERFERENCE:

This interference produces moving ripples or diagonal streaks, and in some cases, causes loss of contrast in the picture.



PICTURE SIZE VARIATION:

A slight picture size variation is quite normal when you adjust the CONTRAST or BRIGHT setting.

CARE AND MAINTENANCE

To prevent fire or shock hazard, disconnect your unit from the AC power source when cleaning. The finish on the unit may be cleaned with a dust cloth and cared for as other furniture. Use caution when cleaning and wiping the plastic parts. Mild soap and a soft, damp cloth may be used.

SPECIFICATIONS

TELEVISION

Picture Tube	20" (Measured Diagonally)
Antenna Input Impedance.....	VHF/UHF, 75 Ohm Coaxial
Input RCA Video	1Vp-p/75 Ohm
Input RCA Audio	0.5Vrms/50K Ohm
Output RCA Video	1Vp-p/75 Ohm
Output RCA Audio	0.5Vrms/1K Ohm

GENERAL

Power Source	120V, 60Hz AC
Power Consumption	70 W
Dimensions	24.6 (W) x 18.9 (D) x 17.7 (H) inches
Weight	59.4 lbs

Features and specifications are subject to change without notice.

**FOR ADDITIONAL SET-UP OR OPERATING ASSISTANCE, PLEASE VISIT OUR WEBSITE AT
WWW.MEMOREXELECTRONICS.COM OR CONTACT CUSTOMER SERVICE AT
(954) 660-7100**

**PLEASE KEEP ALL PACKAGING MATERIAL FOR AT LEAST 90 DAYS IN CASE YOU NEED TO RETURN
THIS PRODUCT TO YOUR PLACE OF PURCHASE OR MEMOREX.**

FOR PARTS AND ACCESSORIES, CONTACT FOX INTERNATIONAL AT 1-800-321-6993.

Memcorp, Inc.
Weston, FL
Printed in Hong Kong

Visit our website at www.memorexelectronics.com

Free Manuals Download Website

<http://myh66.com>

<http://usermanuals.us>

<http://www.somanuals.com>

<http://www.4manuals.cc>

<http://www.manual-lib.com>

<http://www.404manual.com>

<http://www.luxmanual.com>

<http://aubethermostatmanual.com>

Golf course search by state

<http://golfingnear.com>

Email search by domain

<http://emailbydomain.com>

Auto manuals search

<http://auto.somanuals.com>

TV manuals search

<http://tv.somanuals.com>