

# *Memorex*<sup>®</sup>

## **24" TRUE FLAT STEREO COLOR TV**

**MODEL: MT2245**

**BEFORE OPERATING THIS PRODUCT, PLEASE READ THESE INSTRUCTIONS COMPLETELY.**

**IMPORTANT: CHANNELS MUST BE SET INTO MEMORY BEFORE USING THE CHANNEL +/- BUTTONS.**

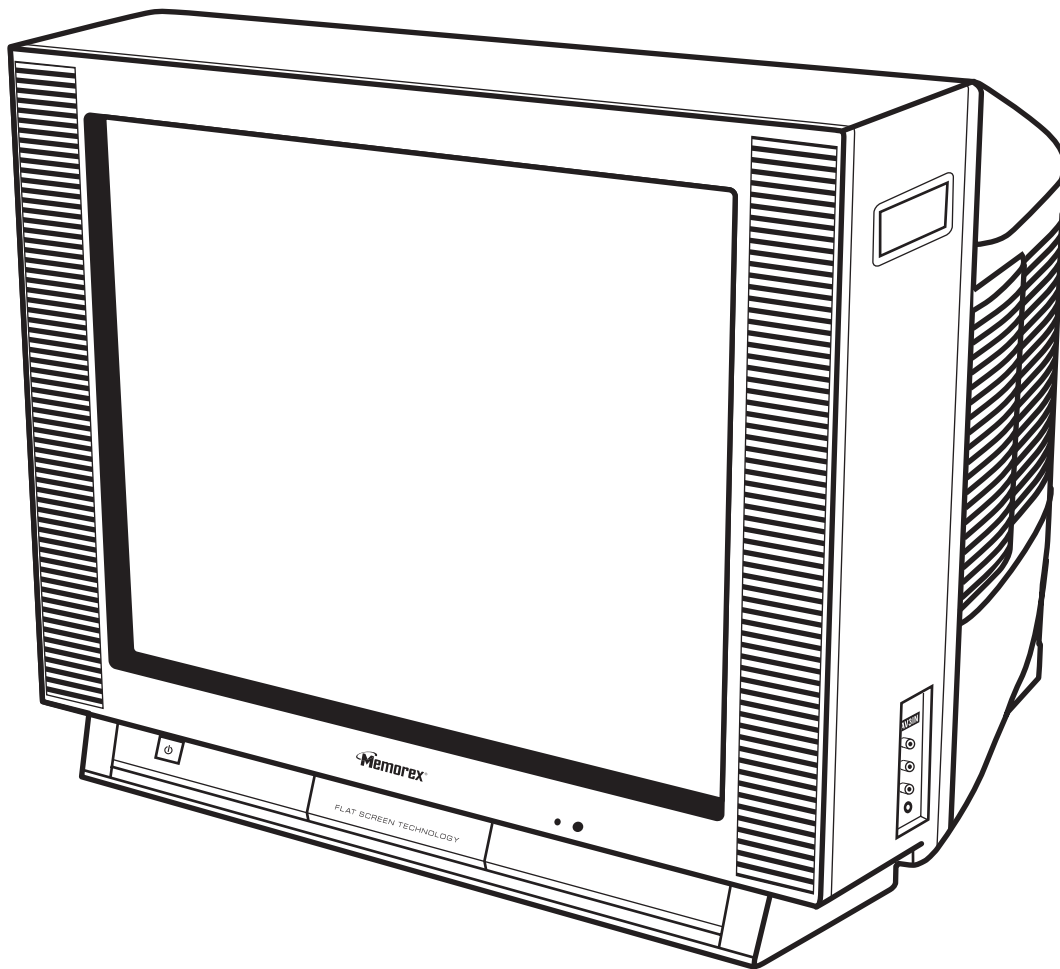

## **OPERATING INSTRUCTIONS**

# CONTENTS

<b>Contents</b> .....	1
<b>Important Safety Instructions</b> .....	2
<b>Power Source</b> .....	4
<b>Location of Controls</b> .....	4
• Front.....	4
• Side.....	5
• Rear Panel.....	5
<b>Remote Control</b> .....	6
• Battery Installation .....	7
• Effective Distance of the Remote Control Transmitter .....	7
• Customizing Your Remote Control .....	8
• Auto Searching Procedure.....	8
• Remote Codes.....	9
<b>Cable (CATV)/Satellite Connections</b> .....	12
<b>Outdoor Antenna Connections</b> .....	13
<b>Using the Front Audio/Video Jacks</b> .....	13
<b>VCR Connections</b> .....	14
<b>DVD Connections</b> .....	16
<b>Stereo Connection</b> .....	17
<b>Setting the Language</b> .....	18
<b>Clock Setting</b> .....	19
<b>Setting the TV/CATV Button</b> .....	20
<b>Setting Channels into Memory</b> .....	20
<b>Adding and Deleting Channels</b> .....	21
<b>Tuning Menu</b> .....	22
<b>TV Operation</b> .....	23
• Mute.....	24
• Sleep.....	24
• Recall.....	24
• Channel Review (C.R.).....	24
• AV .....	24
<b>Closed Captions</b> .....	25
<b>On-Screen Control Adjustments (Picture)</b> .....	26
<b>On-Screen Control Adjustments (Sound)</b> .....	27
<b>Setting Parental Control</b> .....	28
• Parental Control Set-up .....	28
• MPA Rating Set-up.....	29
• TV Rating Set-up .....	30
• Canadian English Rating/French Rating Set-up.....	31
• Changing the Password.....	32
<b>Setting the On Timer</b> .....	33
<b>Setting the Off Timer</b> .....	34
<b>Troubleshooting Guide</b> .....	35
<b>Reception Disturbances</b> .....	36
<b>Care and Maintenance</b> .....	36

# IMPORTANT SAFETY INSTRUCTIONS

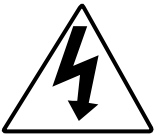

## CAUTION

**RISK OF ELECTRIC SHOCK  
DO NOT OPEN**



The lightning flash with arrowhead symbol, within an equilateral triangle is intended to alert the user to the presence of uninsulated dangerous voltage within the product's enclosure that may be of sufficient magnitude to constitute a risk of electric shock to persons.



The exclamation point within an equilateral triangle is intended to alert the user to the presence of important operating and maintenance (servicing) instructions in the literature accompanying the appliance.

**CAUTION:** TO REDUCE THE RISK OF ELECTRIC SHOCK, DO NOT REMOVE COVER (OR BACK). NO USER-SERVICEABLE PARTS INSIDE. REFER SERVICING TO QUALIFIED SERVICE PERSONNEL.

**WARNING:** TO REDUCE THE RISK OF FIRE OR ELECTRIC SHOCK, DO NOT EXPOSE THIS APPLIANCE TO RAIN OR MOISTURE. TO PREVENT ELECTRIC SHOCK, MATCH THE WIDE BLADE OF PLUG TO WIDE SLOT, FULLY INSERTED.

**Before using the unit, be sure to read all operating instructions carefully. Please note that these are general precautions and may not pertain to your unit. For example, this unit may not have the capability to be connected to an outdoor antenna.**

### 1. READ INSTRUCTIONS

All the safety and operating instructions should be read before the product is operated.

### 2. RETAIN INSTRUCTIONS

The safety and operating instructions should be retained for future reference.

### 3. HEED WARNINGS

All warnings on the product and in the operating instructions should be adhered to.

### 4. FOLLOW INSTRUCTIONS

All operating and use instructions should be followed.

### 5. CLEANING

Unplug this product from the wall outlet before cleaning. Do not use liquid cleaners or aerosol cleaners. Use a damp cloth for cleaning.

### 6. ATTACHMENTS

Do not use attachments not recommended by the product's manufacturer as they may cause hazards.

### 7. WATER AND MOISTURE

Do not use this product near water- for example, near a bathtub, washbowl, kitchen sink, or laundry tub, in a wet basement, or near a swimming pool.

### 8. ACCESSORIES

Do not place this product on an unstable cart, stand, tripod, bracket, or table. The product may fall, causing serious injury and serious damage to the product. Use only with a cart, stand, tripod, bracket, or table recommended by the manufacturer or sold with the product. Any mounting of the product should follow the manufacturer's instructions, and should use a mounting accessory recommended by the manufacturer.

**8A.** An appliance and cart combination should be moved with care. Quick stops, excessive force, and uneven surfaces may cause the appliance and cart combination to overturn.

### 9. VENTILATION

Slots and openings in the cabinet and in the back or bottom are provided for ventilation and to ensure reliable operation of the product and to protect it from overheating. These openings must not be blocked or covered. The openings should never be blocked by placing the product on a bed, sofa, rug, or other similar surface. This product should never be placed near or over a radiator or heat source. This product should not be placed in a built-in installation such as a bookcase or rack unless proper ventilation is provided or the manufacturer's instructions have been adhered to.

### 10. POWER SOURCES

This product should be operated only from the type of power source indicated on the marking label. If you are not sure of the type of power supply to your home, consult your appliance dealer or local power company. For products intended to operate from battery power, or other sources, refer to the operating instructions.

### 11. GROUNDING OR POLARIZATION

This product is equipped with a polarized alternating-current line plug (a plug having one blade wider than the other). This plug will fit into the power outlet only one way. This is a safety feature. If you are unable to insert the plug fully into the outlet, try reversing the plug. If the plug should still fail to fit, contact your electrician to replace your obsolete outlet. Do not defeat the safety purpose of the polarized plug.

### 12. POWER-CORD PROTECTION

Power-supply cords should be routed so that they are not likely to be walked on or pinched by items placed upon or against them, paying particular attention to cords at plugs, convenience receptacles, and the point where they exit from the appliance.

PORTABLE CART WARNING  
(symbol provided by RETAC)



S3126A

## IMPORTANT SAFETY INSTRUCTIONS (CONTINUED)

### 13. LIGHTNING

To protect your product from a lightning storm, or when it is left unattended and unused for long periods of time, unplug it from the wall outlet and disconnect the antenna or cable system. This will prevent damage to the product due to lightning and power-line surges.

### 14. POWER LINES

An outside antenna system should not be located in the vicinity of overhead power lines or other electric light or power circuits, or where it can fall into such power lines or circuits. When installing an outside antenna system, extreme care should be taken to keep from touching such power lines or circuits as contact with them might be fatal.

### 15. OVERLOADING

Do not overload wall outlets and extension cords as this can result in a risk of fire or electric shock.

### 16. OBJECT AND LIQUID ENTRY

Never push objects of any kind into this product through openings as they may touch dangerous voltage points or short out parts that could result in fire or electric shock. Never spill or spray any type of liquid on the product.

### 17. OUTDOOR ANTENNA GROUNDING

If an outside antenna is connected to the product, be sure the antenna system is grounded so as to provide some protection against voltage surges and built-up static charges. Section 810 of the National Electric Code, ANSI/NFPA 70, provides information with respect to proper grounding of the mast and supporting structure, grounding of the lead-in wire to an antenna discharge product, size of grounding conductors, location of antenna discharge product, connection to grounding electrodes, and requirements for grounding electrode.

### 18. SERVICING

Do not attempt to service this product yourself as opening or removing covers may expose you to dangerous voltage or other hazards. Refer all servicing to qualified service personnel.

### 19. REPLACEMENT PARTS

When replacement parts are required, be sure the service technician uses replacement parts specified by the manufacturer or those that have the same characteristics as the original part. Unauthorized substitutions may result in fire, electric shock or other hazards.

### 20. SAFETY CHECK

Upon completion of any service or repairs to this product, ask the service technician to perform safety checks to determine that the product is in proper operating condition.

### 21. WALL OR CEILING MOUNTING

The product should be mounted to a wall or ceiling only as recommended by the manufacturer.

### 22. DAMAGE REQUIRING SERVICE

Unplug the product from the wall outlet and refer servicing to qualified service personnel under the following conditions:

- When the power-supply cord or plug is damaged.
- If liquid has been spilled, or objects have fallen into the product.
- If the product has been exposed to rain or water.
- If the product does not operate normally by following the operating instructions. Adjust only those controls that are covered by the operating instructions, as an adjustment of other controls may result in damage and will often require extensive work by a qualified technician to restore the product to its normal operation.
- If the product has been dropped or the cabinet has been damaged.
- When the product exhibits a distinct change in performance - this indicates a need for service.

### 23. HEAT

The product should be situated away from heat sources such as radiators, heat registers, stoves, or other products (including amplifiers) that produce heat.

### 24. NOTE TO CATV SYSTEM INSTALLER

This reminder is provided to call the CATV system installer's attention to Article 820-40 of the NEC that provides guidelines for proper grounding and, in particular, specifies that the cable ground shall be connected to the grounding system of the building, as close to the point of cable entry as practical.

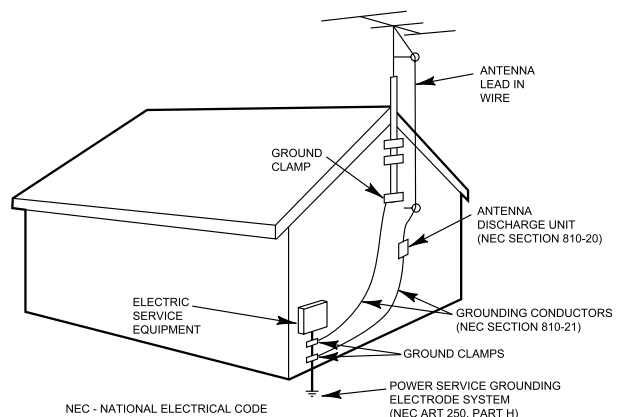

S2898A

EXAMPLE OF ANTENNA GROUNDING AS PER NATIONAL ELECTRICAL CODE

## POWER SOURCE

Insert the AC plug (with the 2 blades) into a conveniently located AC outlet having 120V, 60 Hz.

**NOTE:** The AC plug supplied with the unit is polarized to help minimize the possibility of electric shock. If the AC plug does not fit into a nonpolarized AC outlet, do not file or cut the wide blade. It is the user's responsibility to have an electrician replace the obsolete outlet.

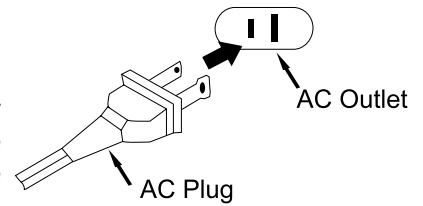

## LOCATION OF CONTROLS

### FRONT

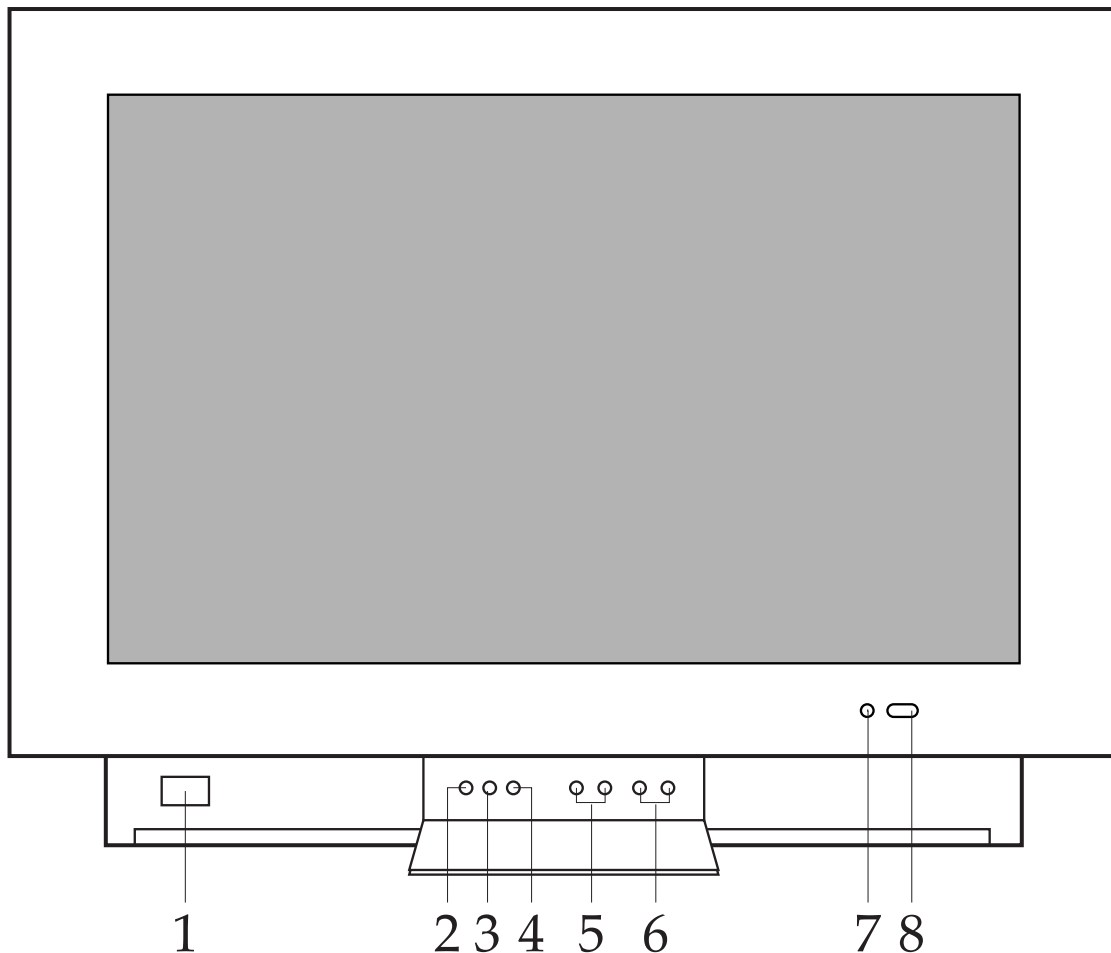

1. **POWER Button** - Press to turn the TV on; the Power indicator will light red. Press again to turn the TV off; the Power indicator will go off.
2. **MENU Button** - Press to access the On-Screen menu.
3. **TV/CATV Button** - Press to switch between the TV and the CATV (Cable TV) mode.
4. **TV/AV Button** - Press to switch between the TV and the video inputs.
5. **VOLUME Up/Down Buttons** - Press to raise or lower the volume.
6. **CHANNEL Up/Down Buttons** - Press to select a channel.
7. **Power/Timer Indicator** - Lights red when the TV is on. Lights orange when the TV is on and the On Timer option is on. Lights green when the TV is off, and the On Timer is on.
8. **REMOTE SENSOR**

## LOCATION OF CONTROLS (CONTINUED)

### SIDE

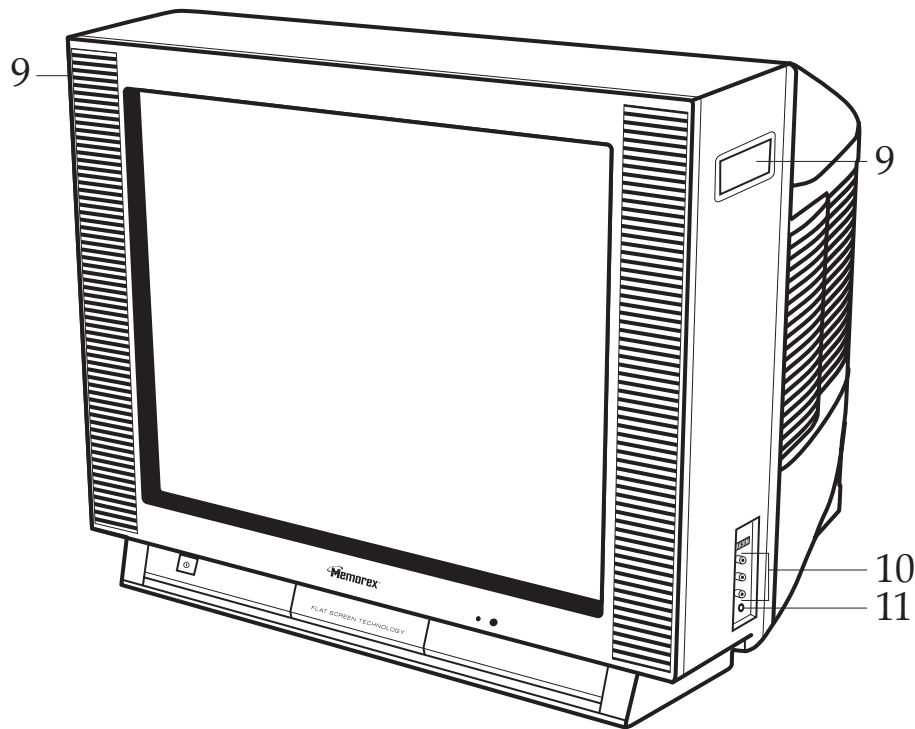

**9. Carrying Handles**

**10. AV3 AUDIO/VIDEO IN Jacks** - Audio and Video signal cables from an external source can be connected here. AV button must be set to VIDEO3.

**11. Headphone Jack** - Headphones (3.5mm) can be connected here for private listening.

### REAR PANEL

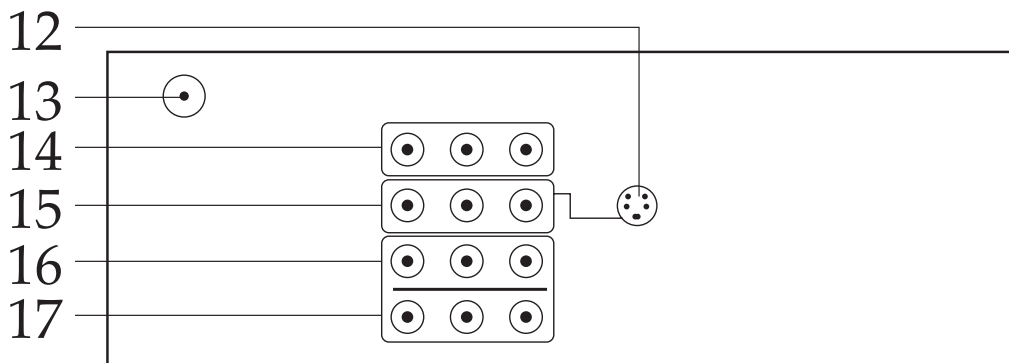

**12. S-VIDEO IN Jack (Rear of Unit)** - Connect an external unit that utilizes an S-video cable to this jack.

**13. VHF/UHF IN Jack (Rear of Unit)** - Connect a VHF/UHF antenna, CATV, VCR, satellite, etc. cable to this jack.

**14. AV AUDIO/VIDEO OUT Jacks** - Audio and Video signal cables from an external source can be connected here. AV button must be set to regular TV or CATV.

**15. AV1 AUDIO/VIDEO IN Jacks** - Audio and Video signal cables from an external source can be connected here. AV button must be set to VIDEO1.

**16. AV2 AUDIO/VIDEO IN Jacks** - Audio and Video signal cables from an external source can be connected here. AV button must be set to VIDEO2.

**17. AV2 (DVD) Cr,Cb,Y IN Jacks** - Cr, Cb, Y signal cables from an external source can be connected here. AV button must be set to VIDEO2.

# REMOTE CONTROL

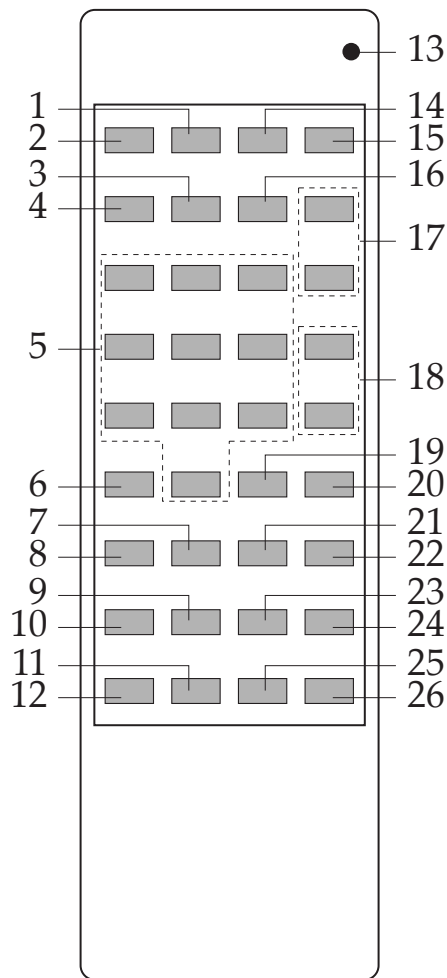

The chart below will show you the remote button's function when in the desired mode (TV, VCR, CABLE, DVD). For example, to Play a tape in a VCR, press the VCR Function button, then the Navigation (▲) button as this button is also the VCR Play button. Please note that you have to program the remote for the external component before using it (except for the TV).

No.	TV	VCR	CABLE	DVD
1.	VCR Function Button	VCR Function Button	VCR Function Button	VCR Function Button
2.	TV Function Button	TV Function Button	TV Function Button	TV Function Button
3.	AV Button	N/A	N/A	SKIP-
4.	POWER Button	POWER Button	POWER Button	POWER Button
5.	Direct Channel Buttons	Direct Channel Buttons	Direct Channel Buttons	Number Buttons
6.	-/-- Button	ENTER	ENTER	+10
7.	Navigation (▲) Button	PLAY	N/A	PLAY
8.	MENU Button	N/A	N/A	MENU
9.	N/A	N/A	N/A	OPEN/CLOSE Button
10.	Navigation (◀) Button	REWIND	N/A	REWIND
11.	Navigation (▼) Button	STOP	N/A	STOP
12.	TV/CATV Button	N/A	N/A	RETURN
13.	Program Indicator	Program Indicator	Program Indicator	Program Indicator
14.	CTV (Cable) Function Button	CTV (Cable) Function Button	CTV (Cable) Function Button	CTV (Cable) Function Button
15.	DVD Function Button	DVD Function Button	DVD Function Button	DVD Function Button
16.	SLEEP Button	N/A	N/A	SKIP +
17.	CH (Channel) +/- Buttons	CH (Channel) +/- Buttons	CH (Channel) +/- Buttons	UP/DOWN
18.	VOL (Volume) +/- Buttons	VOL (Volume) +/- Buttons	VOL (Volume) +/- Buttons	RIGHT/LEFT
19.	RECALL Button	LAST	LAST	SELECT
20.	TV MUTE Button	TV MUTE Button	TV MUTE Button	AUDIO
21.	EXIT Button	N/A	N/A	SETUP
22.	PICTURE Button	PAUSE	N/A	PAUSE
23.	Navigation (▶) Button	FAST FORWARD	N/A	FAST FORWARD
24.	SOUND Button	N/A	N/A	TITLE
25.	C.R. Button	N/A	N/A	DISPLAY
26.	S.MPX Button	RECORD	N/A	INDEX

## REMOTE CONTROL (CONTINUED)

### BATTERY INSTALLATION

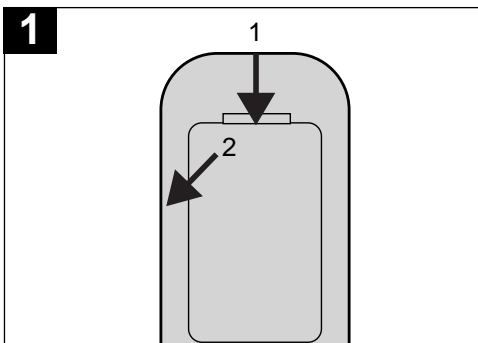

Open the battery compartment cover.

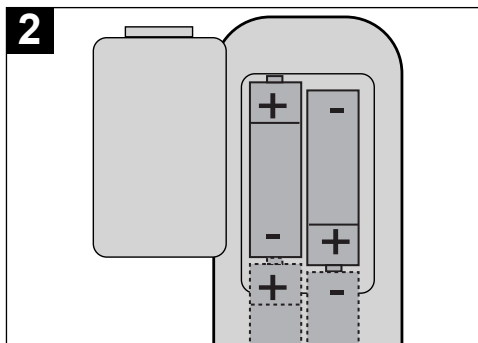

Install four "AAA" batteries, paying attention to the polarity diagram in the battery compartment.

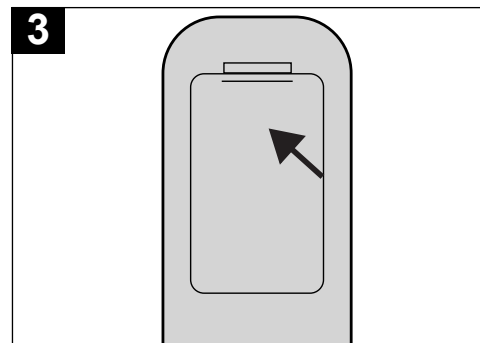

Replace the battery compartment cover.

### BATTERY PRECAUTIONS

Follow these precautions when using batteries in this device:

1. Use only the size and type of batteries specified.
2. Be sure to follow the correct polarity when installing the batteries as indicated in the battery compartment. Reversed batteries may cause damage to the device.
3. Do not mix different types of batteries together (e.g. Alkaline and Carbon-zinc) or old batteries with fresh ones.
4. If the device is not to be used for a long period of time, remove the batteries to prevent damage or injury from possible battery leakage.
5. Do not try to recharge batteries not intended to be recharged; they can overheat and rupture. (Follow battery manufacturer's directions.)

### EFFECTIVE DISTANCE OF THE REMOTE CONTROL TRANSMITTER

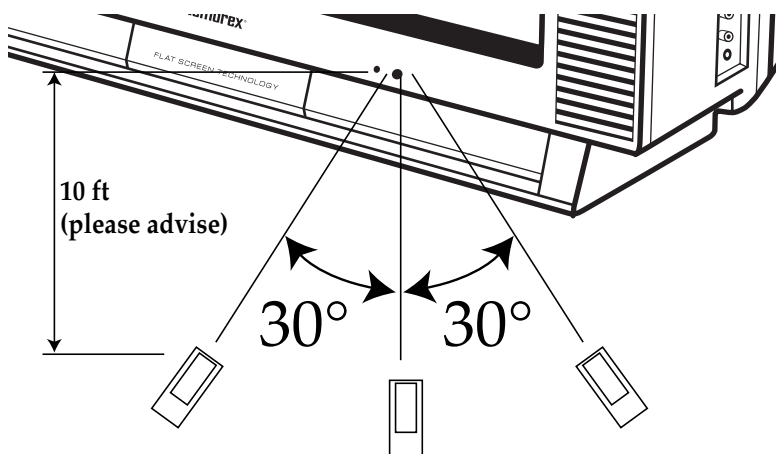

#### NOTES:

- When there is an obstacle between the TV and the transmitter, the transmitter may not operate.
- When direct sunlight, incandescent lamp, fluorescent lamp or any other strong light shines on the REMOTE SENSOR of the TV, the remote operation may be unstable.

#### FAQs:

*Why is the remote control not working properly?*

- The remote control is not aimed at the sensor.
- The remote control is too far away from the remote sensor.
- There is too much light in the room.
- There is an obstacle in the path of the beam.
- The batteries are weak or dead.
- The batteries are inserted incorrectly.
- The TV is not plugged in.
- The proper Function button is not pressed. For Example, press the TV button to use the remote to operate the TV.



## REMOTE CONTROL (CONTINUED)

### CUSTOMIZING YOUR REMOTE CONTROL

Your TV comes equipped with a universal remote control. In addition to controlling the TV, this universal remote can also operate a VCR, DVD player and a cable box (even if your units are made by manufacturers other than Memorex). If you accidentally change the program for your TV, simply use 0001 as the television code.

### SETTING UP YOUR REMOTE TO OPERATE YOUR VCR, DVD AND/OR CABLE BOX

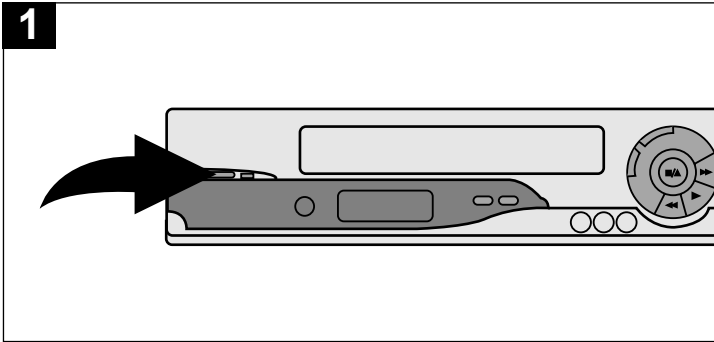

1 Turn the unit you want to program the remote for off.

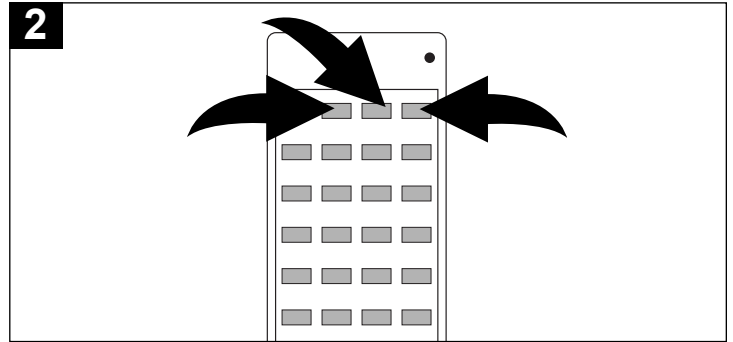

2 Press the desired Function button (VCR, CTV, DVD).

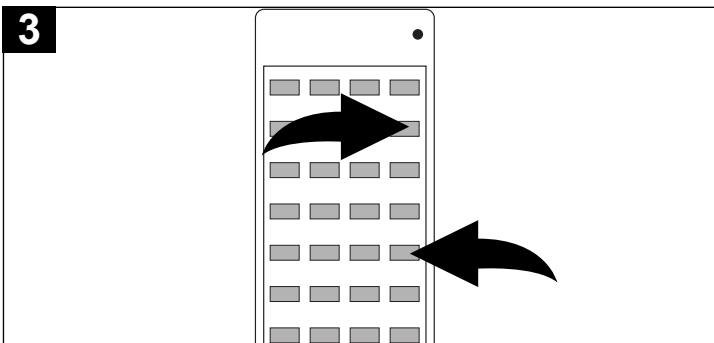

3 Press and hold the CH+ and the VOL- buttons at the same time until the red Program indicator at the top of the remote lights.

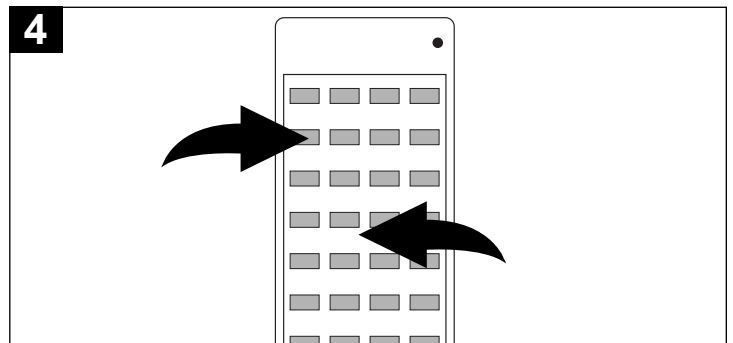

4 Enter the 4 digit code corresponding to your set as listed on the following pages, the indicator will go out immediately. Test the remote by pressing the POWER button, and if it does not work, repeat steps 3 and 4 using another code, or try the Auto Search procedure as described below.

**IMPORTANT:** After pressing another function button and using an external unit (such as a VCR), you must press the TV Function button again to operate the TV.

### AUTO SEARCH PROCEDURE

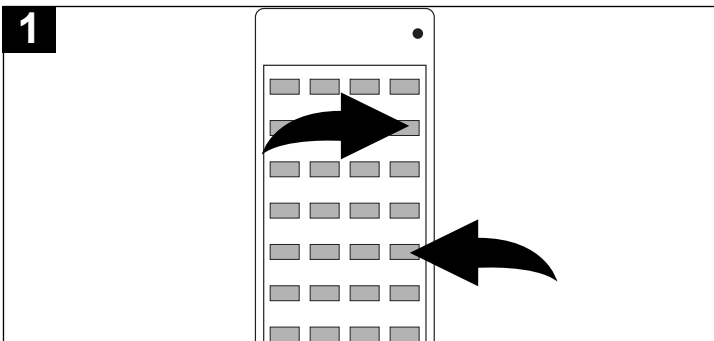

1 Press the desired Function button (VCR, CTV, DVD). Press and hold the CH+ and the VOL- buttons at the same time until the red Program indicator at the top of the remote lights.

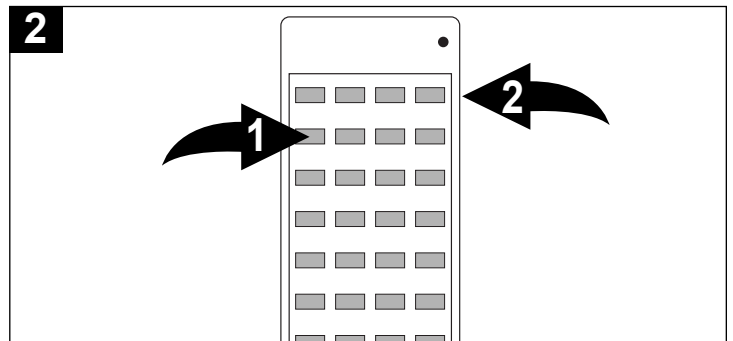

2 Press the POWER button ❶ and the Auto Search mode will begin. Press the desired Function button ❷, or hold the CH+ and VOL- buttons together to exit the search mode.

## REMOTE CODES

### DVD PLAYERS

BRAND	CODE(S)	BRAND	CODE(S)
AKAI	0054	PIONEER	0104,0114
DENON	0184	PROSCAN	0154
HITACHI	0194	RCA	0154
JVC	0084	SAMSUNG	0074
KENWOOD	0144	SHARP	0034
MAGNAVOX	0124	SONY	0014
MEMOREX	0204	TECHNICS	0024
MITSUBISHI	0134	THOMSON	0164
ONKYO	0064,0124	TOSHIBA	0044,0124
PANASONIC	0024	YAMAHA	0004,0024,0094
PHILIPS	0094,0124	ZENITH	0124

### CABLE/SATELLITE BOXES

BRAND	CODE(S)	BRAND	CODE(S)
ABC	0253, 0373	OAK	0103
ANTRONIX	0133	OAK SIGMA 450	0543
ARCHER	0133, 0283	OAK SIGMA 550	0533
BBT	0073	PANASONIC TZ 120/130	0473
CABLETIME	0163	PANASONIC TZ 170/180	0443
CABLEVISION	0193	PANASONIC TZ140	0463
COLOUR VOICE	0303,0343	PANASONIC TZ 150/160	0453
COMTRONICS	0213, 0273	PARAGON	0383
EAGLE COMRONICS	0273	PHILIPS	0033, 0213, 0303, 0313, 0323, 0333, 0343
EASTERN	0063	PIONEER	0083
ELECTRICORD	0203	PIONEER BR50	0003
ELECRUS	0263	PIONEER BR50/ 70/80/81/82	0693
GE	0113, 0123	PIONEER BR90	0553
GEC CABLE SYSTEM	0193	PULSAR	0383
HAMLIN H5	0673	RCA DIGITAL	
HAMLIN H6	0663	SATELLITE SYSTEM	0393, 0403
HAMLIN H6S	0653	REALISTIC	0133
HAMLIN H8	0643	REGENCY/EASTERN	0683
HAMLIN H9	0633	RUNCO	0383
JERROLD	0253	SAMSUNG	0273
JERROLD 400L	0623	SCIENTIFIC ATLANTIC	0573, 0363, 0583, 0563
JERROLD 450L	0613	SIGNAL	0273
JERROLD 550	0603	SL MARX	0273
JERROLD OSD CATV	0593	SPECTRAVISION	0233
JERROLD SPRUCER	0433	STANDARD COMP.	0183
MAGNAVOX/PHILIPS	0413, 0423	STARCOM V	0253
MAMM	0293	STARGATE	0273
MEMOREX	0383	SYLVANIA/TEXSCAN	0373, 0493
MOVIE TIME	0143, 0203	TEKNIKA	0173
NORTHCOAST	0013		
NSC	0143		

## REMOTE CODES (CONTINUED)

### CABLE/SATELLITE BOXES (CONTINUED)

BRAND	CODE(S)	BRAND	CODE(S)
TELESERVICE	0053	TOSHIBA	0383
TELEVIEW	0273	TUDI	0043
TEXSCAN	0183, 0373	UNIKA	0133
TFC	0023	UNIVERSAL	0133, 0153, 0203, 0283
TOCOM	0223, 0353	VIDEOWAY	0093
TOCOM 5503A	0523	VIEWSTAR	0213
TOCOM 5503VIP/5507	0513	ZENITH	0243, 0383, 0483
TOCOM TC56	0503		

### VCRs

BRAND	CODE(S)	BRAND	CODE(S)
A TANDY	0902		0872, 0892, 0912, 0912, 0952, 0992
ADVENTURA	0992		
AIKO	0982	FINLUX	0002, 0992
AIWA	0992	FISHER	0682, 0692, 0642, 0902
AKAI	0262, 0942, 0952, 0962, 0972	FUJI	0672, 0932
AMERICAN HIGH	0932	FUNAI	0992
AMSTRAD	0992	GURRARD	0992
ASA	0002, 0912	GE	0662, 0822, 0932
ASHA	0922	GO VIDEO	0642, 0652
AUDIO DYNAMICS	0202	GOLDSTAR	0082, 0632, 0912
AUDIOVOX	0912	GOODMAN'S	0402
BEAUMARK	0922	GRADIENTE	0992
BELL & HOWELL	0902	GRANDA	0612, 0902
BLAUPUNKT	0412	GRUNDIG	0002
BROKSONIC	0872, 0882, 0892	H/K	0622
BUSH	0852	HARLEY DAVIDSON	0992
CALIX	0912	HARMON KARDON	0622
CANON	0862	HARWOOD	0752, 0852
CCE	0852, 0982	HEADQUARTER	0612
CITIZEN	0912, 0982	HI-Q	0842
COLT	0852	HINARI	0852
CRAIG	0832, 0842, 0852, 0912, 0922	HITACHI	0102, 0562, 0572, 0592, 0602, 0992, 0582
CURTIS MATHIS	0662, 0822, 0932	ITT	0942
CYBERNEX	0922	JVC	0202, 0522, 0532, 0542, 0552
DAEWOO	0802, 0812, 0982	KENWOOD	0202, 0542, 0612, 0632, 0902
DBX	0202	KLH	0852
DYNATECH	0472, 0992	KODAK	0912, 0932
ELECTROHOME	0912	LLOYD	0992
ELECTROPHONIC	0912	LOGIK	0852
EMEREX	0792	LUXOR	0942
EMERSON	0072, 0122, 0132, 0142, 0152, 0162, 0172, 0182, 0192, 0212, 0702, 0712, 0722, 0732, 0742, 0882, 0752, 0762, 0772, 0782,	LXI	0022, 0912
		MAGNAVOX	0002, 0482, 0492, 0502, 0512, 0932
		MAGNIN	0922

## REMOTE CODES (CONTINUED)

### VCRs (CONTINUED)

<b>BRAND</b>	<b>CODE(S)</b>	<b>BRAND</b>	<b>CODE(S)</b>
MARANTZ	0002, 0202, 0402, 0632, 0932	SALORA	0612, 0762
MARTA	0912	SAMSUNG	0212, 0312, 0922, 0962
MATSUSHITA	0932	SANKY	0472, 0512
MATSUI	0722	SANSUI	0292, 0542, 0832
MEI	0222, 0932	SANYO	0242, 0612, 0842, 0902, 0922
MEMOREX	0232, 0242, 0472, 0512, 0612, 0842, 0902, 0912, 0922	SBR	0002, 0282
MITSUBISHI	0452, 0482, 0542, 0762, 0952	SCHNEIDER	0652
MOTOROLA	0472, 0932	SCOTT	0342, 0712, 0762, 0872, 0882, 0892
MTC	0922, 0992	SEARS	0302, 0592, 0602, 0612, 0682, 0692, 0842, 0902, 0912, 0932
MULTITECH	0852, 0992	SHARP	0402, 0472
NAD	0442	SHIMTOM	0652
NEC	0202, 0292, 0422, 0432, 0542, 0632	SHOGUM	0922
NIKKO	0912	SINGER	0852
NOBLEX	0922	SONY	0032, 0332, 0352, 0362, 0672, 0792, 0932
OLYMPUS	0412, 0932	STS	0602
OPTIMUS	0442, 0472, 0912	SUNPAK	0352
OPTONICA	0402	SYLVANIA	0002, 0492, 0502, 0762, 0932, 0992
ORION	0212, 0722, 0742, 0772	SYMPHONIC	0992
OSAKI	0912	TANDY	0992
PANASONIC	0012, 0052, 0092, 0222, 0372, 0382, 0392, 0412, 0932	TASHIKO	0712, 0992
PENNY	0202, 0432, 0602, 0632, 0692, 0912, 0922, 0932	TEAC	0992
PENTAX	0592, 0602	TECHNICS	0932
PERDIO	0992	TEKNIKA	0322, 0912, 0932, 0992
PHILCO	0002, 0932	TELEFUNKEN	0252
PHILIPS	0002, 0282, 0402, 0492, 0932	TMK	0212, 0732, 0772, 0922
PILOT	0912	TOSHIBA	0062, 0302, 0342, 0682, 0712, 0762
PIONEER	0442, 0542	TOTEVISION	0912, 0922
PULSAR	0512	UNITECH	0922
QUARTER	0612	VECTOR RESEARCH	0302, 0432, 0632
QUARTZ	0272, 0612	VICTOR	0542, 0552
QUASAR	0382, 0392, 0932	VIDEO CONCEPTS	0202, 0432, 0632, 0952
RADIO SHACK	0912, 0992	WARDS	0322, 0402, 0472, 0482, 0602, 0712, 0842, 0852, 0922, 0932, 0992
RADIX	0912	YAMAHA	0202, 0632
RANDEX	0912	ZENITH	0042, 0362, 0512, 0672
RCA	0112, 0382, 0392, 0482, 0592, 0602, 0662, 0822, 0942		
REALISTIC	0402, 0472, 0612, 0682, 0842, 0902, 0912, 0922, 0932, 0992		
RICOH	0352, 0382		
SAISHO	0212, 0582, 0722, 0732, 0742, 0772		

## CABLE (CATV)/SATELLITE CONNECTIONS

This TV has an extended tuning range and can tune most cable channels without using a Cable TV converter box. Some Cable TV companies offer "premium pay channels" in which the signal is scrambled. Descrambling these signals for normal viewing requires the use of a descrambler device which is generally provided by the cable company.

### FOR SUBSCRIBERS TO BASIC CABLE TV SERVICE

For basic cable service not requiring a converter/descrambler box, connect the CATV 75 ohm coaxial cable to the VHF/UHF jack on the rear of the TV.

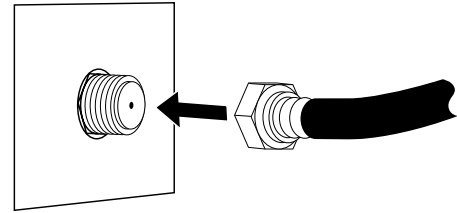

### FOR SUBSCRIBERS TO SCRAMBLED CABLE TV SERVICE OR SATELLITE

If you subscribe to a satellite service or a cable TV service which requires the use of a converter/descrambler box, connect the incoming 75 ohm coaxial cable to the converter/descrambler box. Using another 75 ohm cable, connect the output of the converter/descrambler or satellite box to the antenna jack on the TV. Follow the connections shown below. Set the TV/VCR to the output channel of the converter/descrambler or satellite box (usually 3 or 4) and use the converter/descrambler or satellite box to select channels.

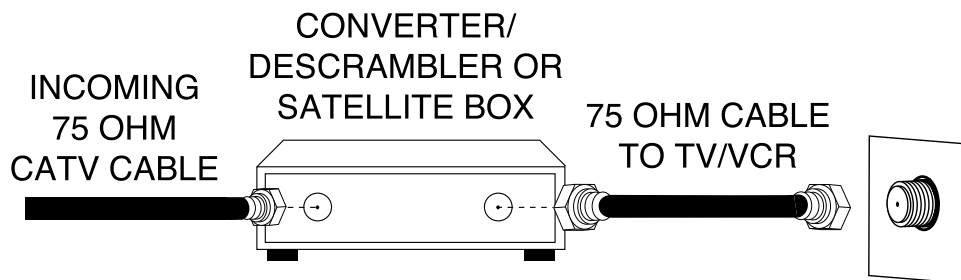

### FOR SUBSCRIBERS TO UNSCRAMBLED BASIC CABLE TV SERVICE WITH SCRAMBLED PREMIUM CHANNELS

If you subscribe to a satellite service or a cable TV service in which basic channels are unscrambled and premium channels require the use of a converter/descrambler box, you may wish to use a signal splitter and an A/B switch box (available from the cable company or an electronic supply store). Follow the connections shown below. With the switch in the "B" position, you can directly tune any unscrambled channels on your TV. With the switch in the "A" position, tune your TV to the output of the converter/descrambler box (usually channel 3 or 4) and use the converter/descrambler box to tune scrambled channels.

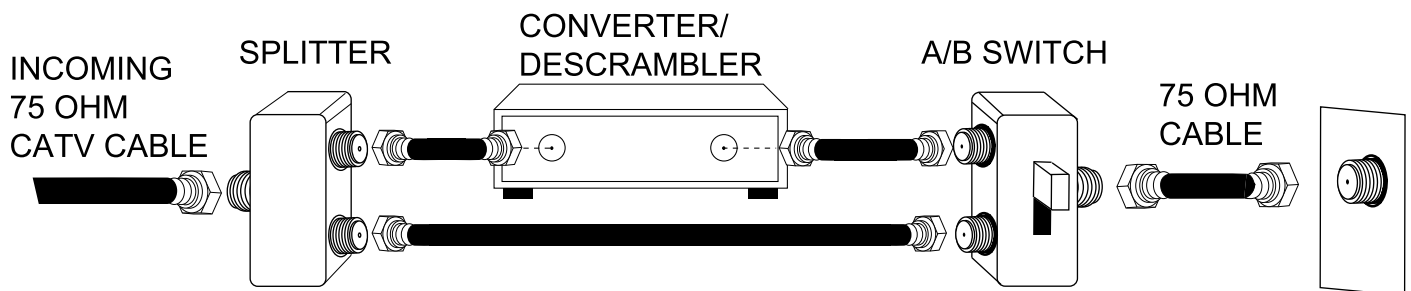

#### FAQS:

*I connected my cable, why can't I get channels above 69?*

Make sure TC/CATV is set to CATV, see page 20. Also, make sure your cable company broadcasts channels in the range you are searching.

*Are the cables included?*

No, the cables are sold separately, visit your local electronics' store.

## OUTDOOR ANTENNA CONNECTIONS

### OUTDOOR VHF/UHF ANTENNA CONNECTION (ANTENNA NOT SUPPLIED)

Follow the instructions for the type of antenna system you intend to use. If using Cable or Satellite, see page 12.

#### Combination VHF/UHF Antenna (Single 75 ohm cable or 300 ohm twin-lead wire)

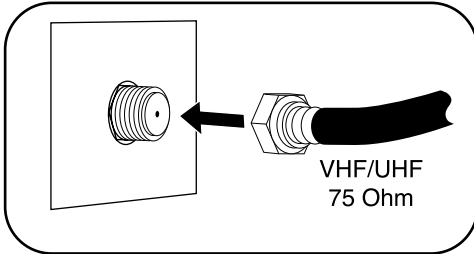

Connect the 75 ohm cable from combination VHF/UHF antenna to the antenna jack.

**OR**

If your combination antenna has a 300 ohm twin-lead wire, use a 300-75 ohm matching transformer (NOT SUPPLIED).

#### Combination VHF/UHF Antenna (Separate VHF and UHF 300 ohm twin-leads)

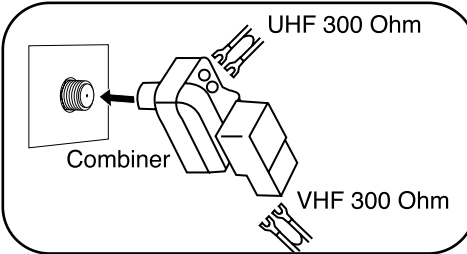

Connect the UHF twin-lead wire to a combiner (NOT SUPPLIED). Connect the VHF twin-lead to a 300-75 ohm matching transformer (NOT SUPPLIED). Attach the transformer to the combiner. Attach the combiner to the antenna jack.

#### Separate VHF/UHF Antennas

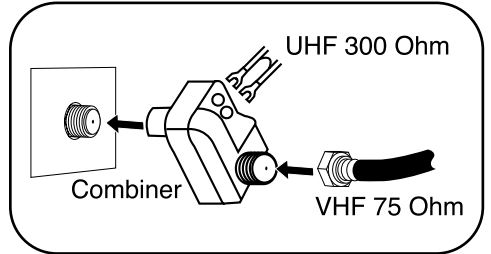

Connect the 75 ohm cable from the VHF antenna and the UHF antenna twin-lead wire to a combiner (NOT SUPPLIED). Attach the combiner to the antenna jack.

**NOTE:** If your VHF antenna has a twin-lead wire use a 300-75 ohm matching transformer, then connect the transformer to the combiner.

## USING THE FRONT AUDIO/VIDEO JACKS

The optimal use for the side A/V jacks are to connect an A/V component that is used only occasionally, such as a camcorder or video game. Connect the Audio/Video output jacks of the external unit to the Audio Input jacks and the Video Input jack.

To access the unit connected to these jacks, press the AV button so VIDEO3 appears on the screen. To resume normal TV viewing, simply press the AV button again.

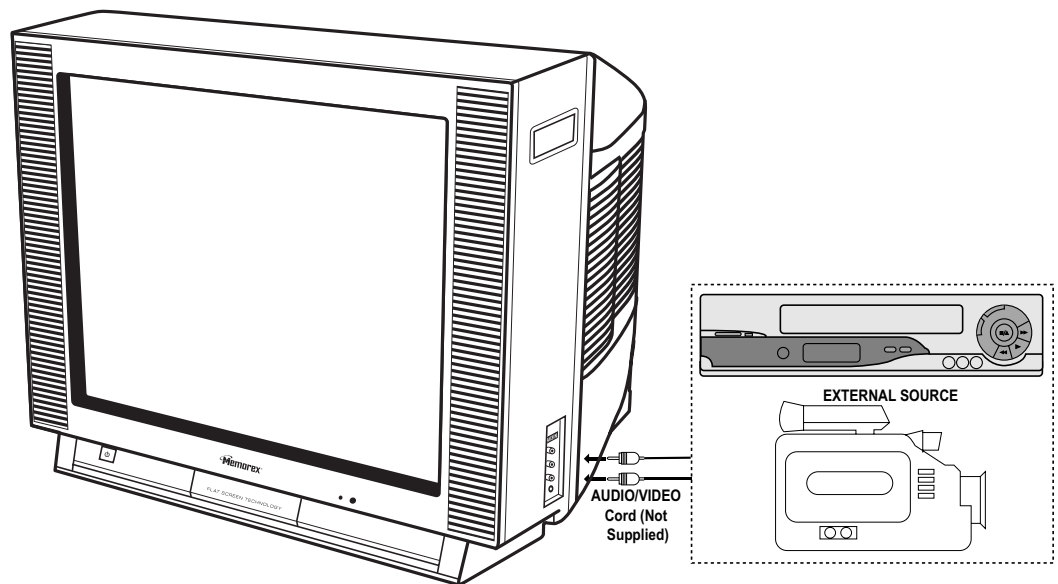

### FAQs:

*My external unit has only 1 audio jack, but this TV has two Audio input jacks, how do I connect it?*  
Simply connect it to the "L (Mono)" Audio input jack, but the sound will be monaural.

*How do I watch the external unit connected to the Audio/Video Input jacks?*

Press the AV button so VIDEO3 appears on the screen, then start the external source.

*Are the cables included?*

No, the cables are sold separately, visit your local electronics' store.

## VCR CONNECTIONS

Follow the instructions below to connect a VCR to your television using a 75 ohm coaxial cable. (CABLES NOT INCLUDED.)

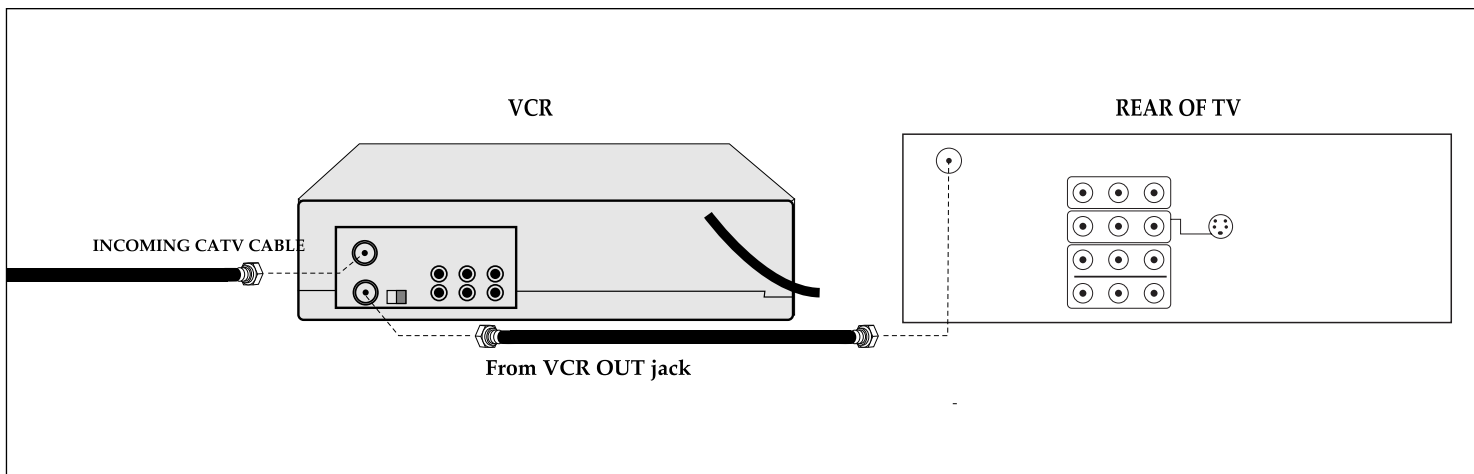

1. Connect the cable, satellite or incoming antenna to the ANT jack on the rear of the VCR.
2. Connect a 75 ohm coaxial cable from the VCR's 75 Ohm OUT jack to the ANT jack on the rear of the TV.
3. Press the AV button until regular TV or CATV appears on the TV screen and press PLAY on the VCR to watch a tape.

Follow the instructions below to connect a VCR to your television using Audio/Video cables. (CABLES NOT INCLUDED.)

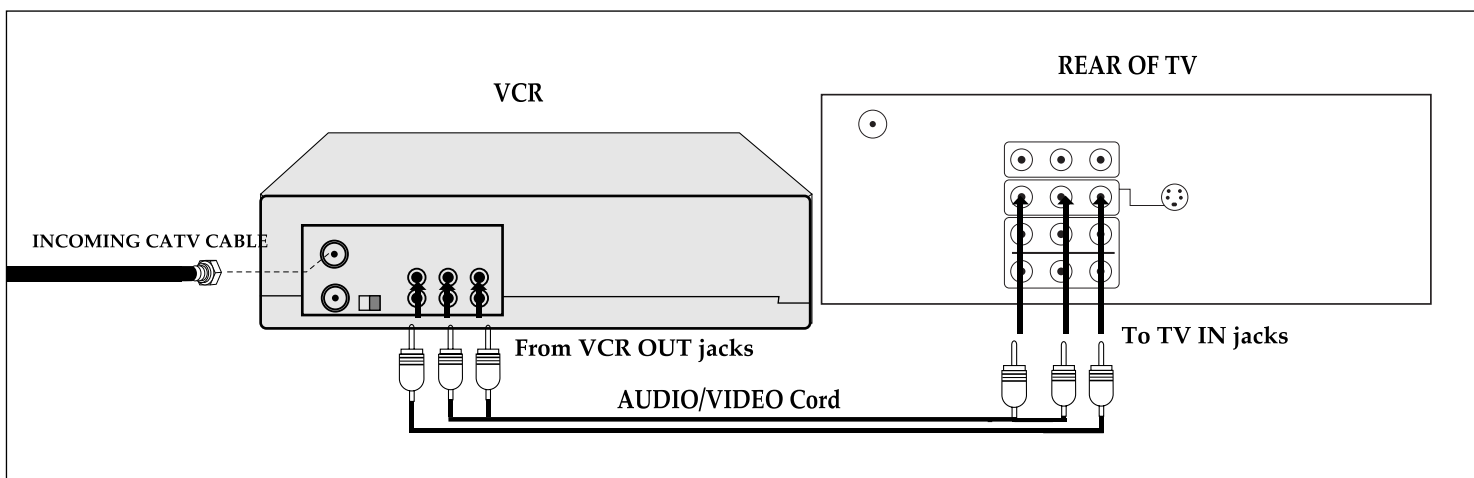

1. Connect the cable, satellite or incoming antenna to the ANT jack on the rear of the VCR.
2. Connect the left and right audio cable from the VCR's Audio OUT jacks to the TV's AV1 or AV2 left and right Audio IN jacks. Connect the VCR's video OUT jack to the TV's video IN jack.
3. Press the AV button until VIDEO1 or VIDEO2 appears on the TV screen and press PLAY on the VCR to watch a tape.

### FAQs:

*My VCR has only 1 Audio jack, but this TV has two Audio input jacks, how do I connect it?*

Simply connect it to the "L (Mono)" Audio input jack, but the sound will be monaural.

*How do I watch the external unit connected to the Audio/Video Input jacks?*

If connected to the coaxial jack, or AV1 jacks, press the AV button so standard TV or CATV appears on the screen, then start the external source.

## VCR CONNECTIONS (CONTINUED)

Follow the instructions below to connect an S-VIDEO VCR to your television using an S-video cable.(CABLES NOT INCLUDED.)

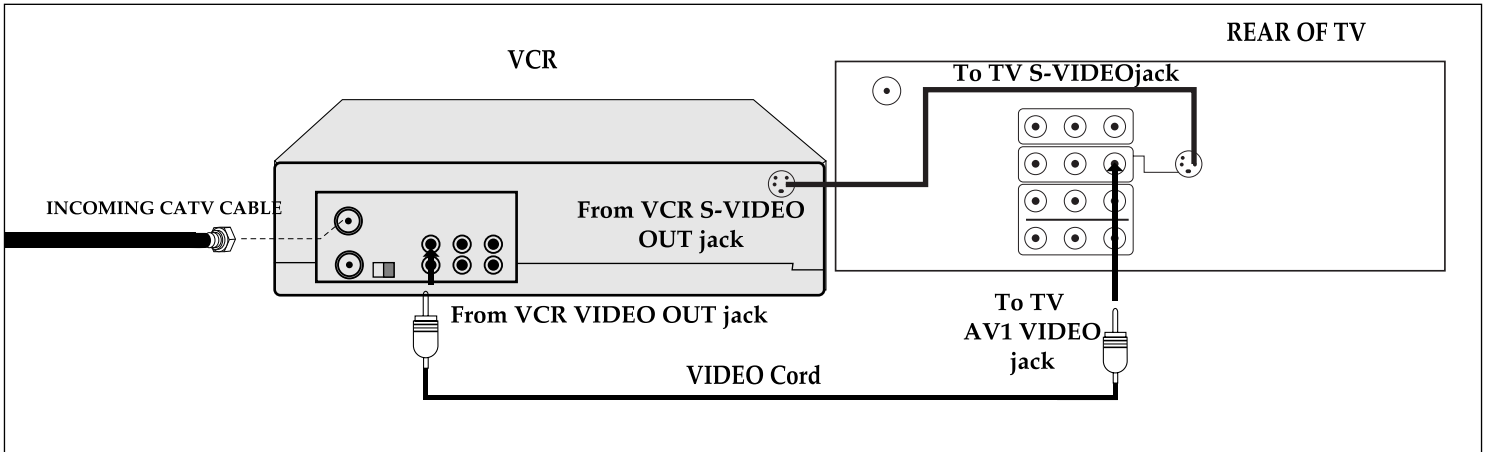

1. Connect the cable, satellite or incoming antenna to the ANT jack on the rear of the VCR.
2. Connect the left and right audio cable from the VCR's Audio OUT jacks to the TV's AV1 left and right Audio IN jacks.
3. Connect the VCR's S-VIDEO OUT jack to the TV's S-VIDEO IN jack.
4. Press the AV button until VIDEO1 appears on the TV screen and press PLAY on the VCR to watch a tape.

Follow the instructions below to connect a second VCR to Record from the TV. (CABLES NOT INCLUDED.)

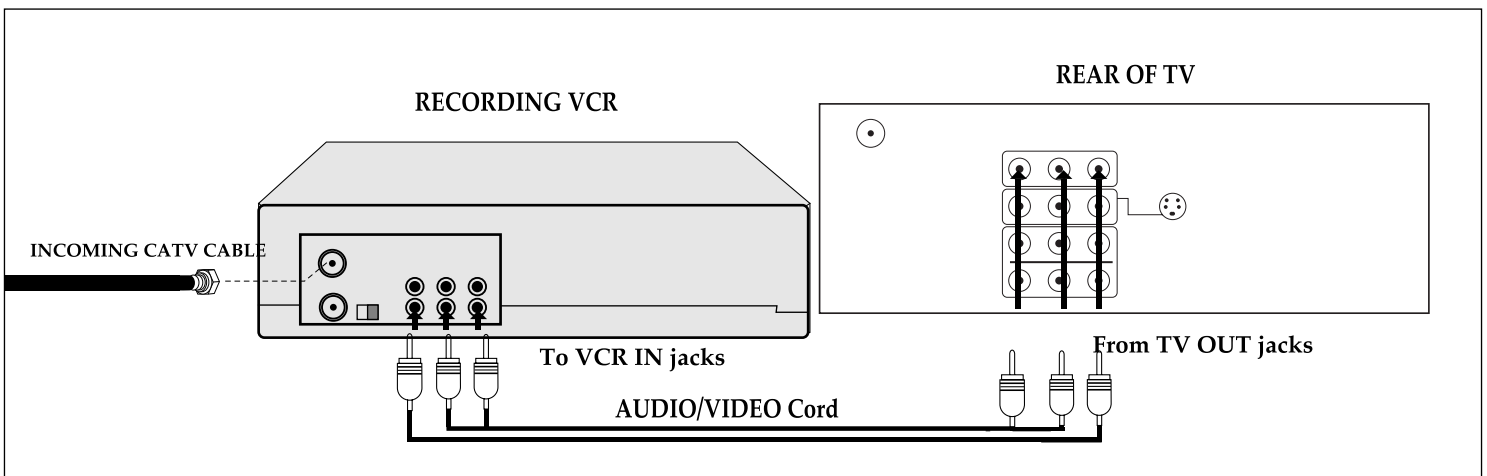

1. Connect the left and right audio cable from the TV's Audio OUT jacks to the VCR's left and right Audio IN jacks. Connect the TV's video OUT jack to the VCR's video IN jack.

Refer to your VCR's manual for more information on this connection.



## DVD CONNECTIONS

Follow the instructions below to connect a DVD player to your television using Audio/Video cables. (CABLES NOT INCLUDED.)

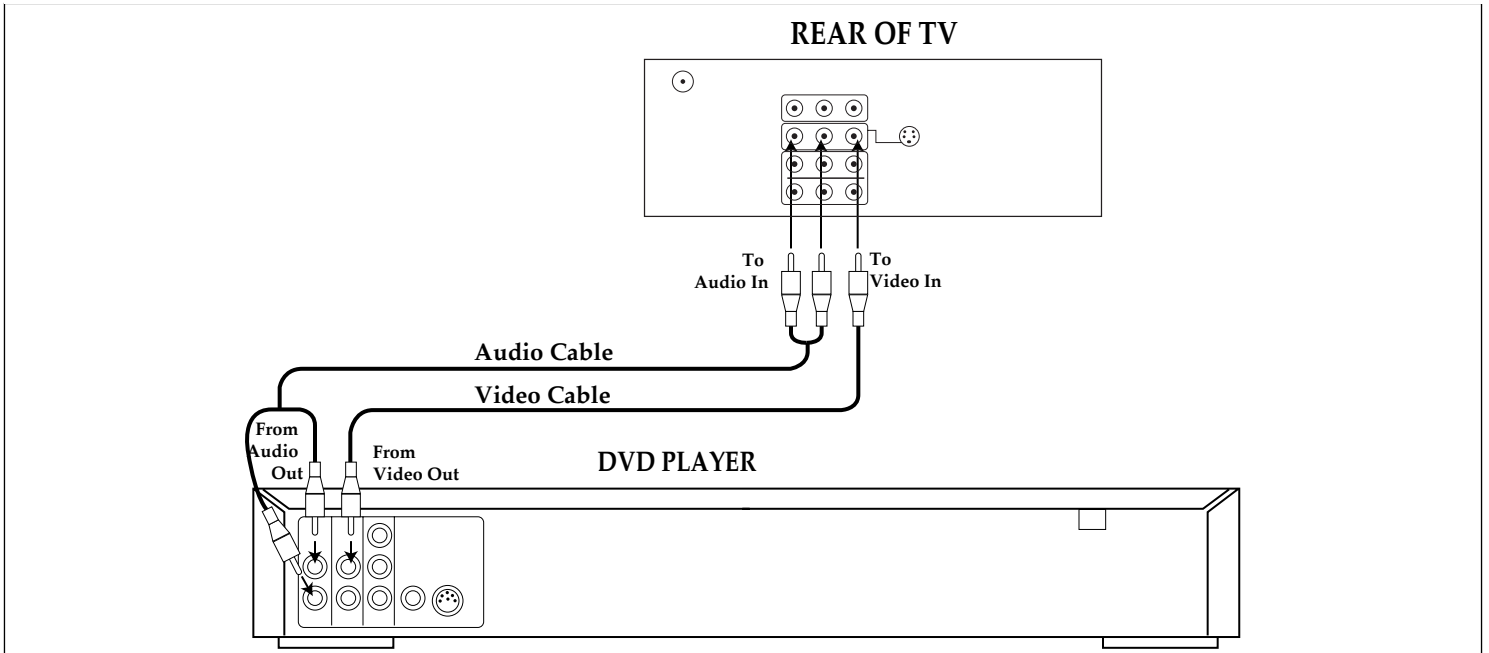

1. Connect the left and right audio cable from the DVD's Audio OUT jacks to the TV's AV1 or AV2 left and right Audio IN jacks. Connect the DVD's video OUT jack to the TV's video IN jack.
2. Press the AV button until VIDEO1 or VIDEO2 appears on the TV screen and press PLAY on the DVD to watch a DVD.

Follow the instructions below to connect a DVD player to your television using the S-Video cable. (CABLES NOT INCLUDED.)

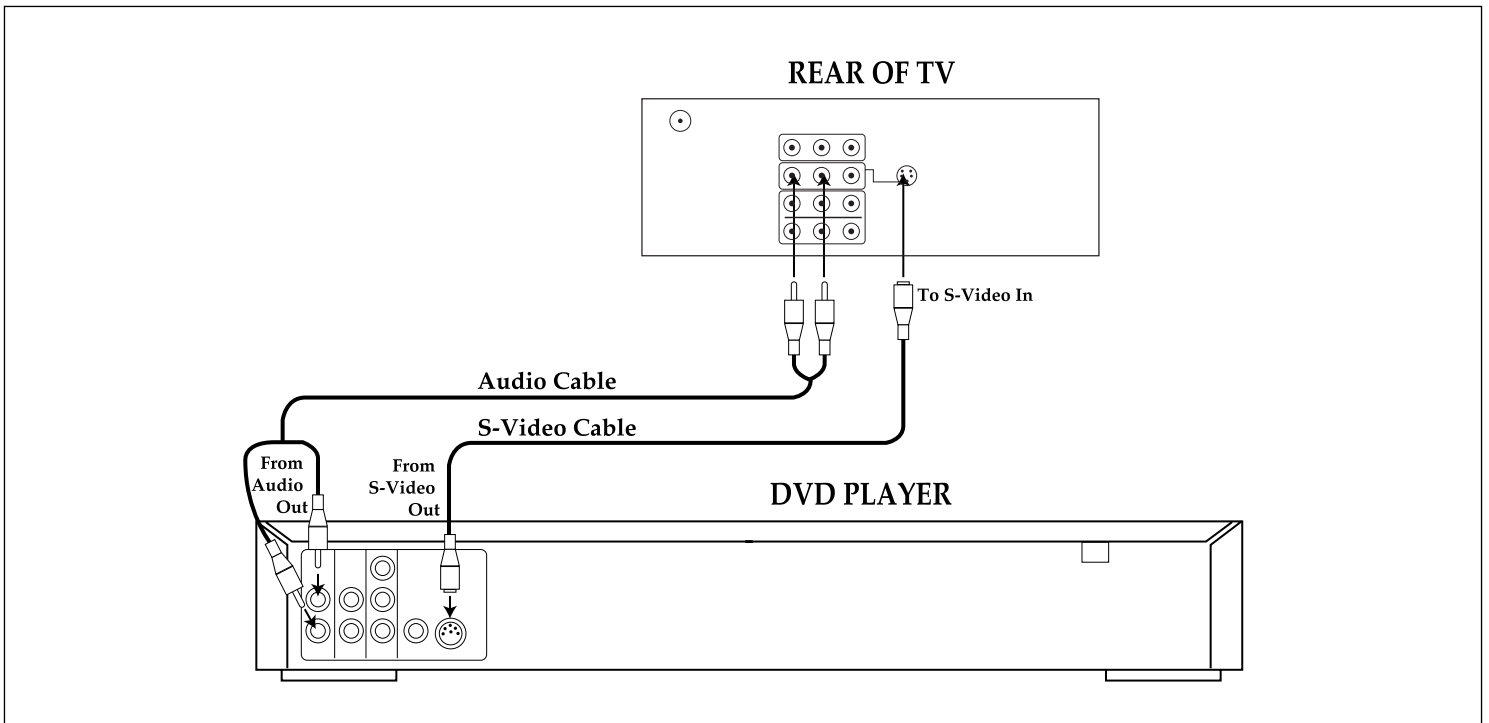

1. Connect the left and right audio cable from the DVD's Audio OUT jacks to the TV's AV1 left and right Audio IN jacks.
2. Connect the DVD's S-VIDEO OUT jack to the TV's S-VIDEO IN jack.
3. Press the AV button until VIDEO1 appears on the TV screen and press PLAY on the DVD to watch the DVD.

## DVD CONNECTIONS (CONTINUED)

Follow the instructions below to connect a DVD player to your television using the Cr, Cb, Y jacks. (CABLES NOT INCLUDED.)

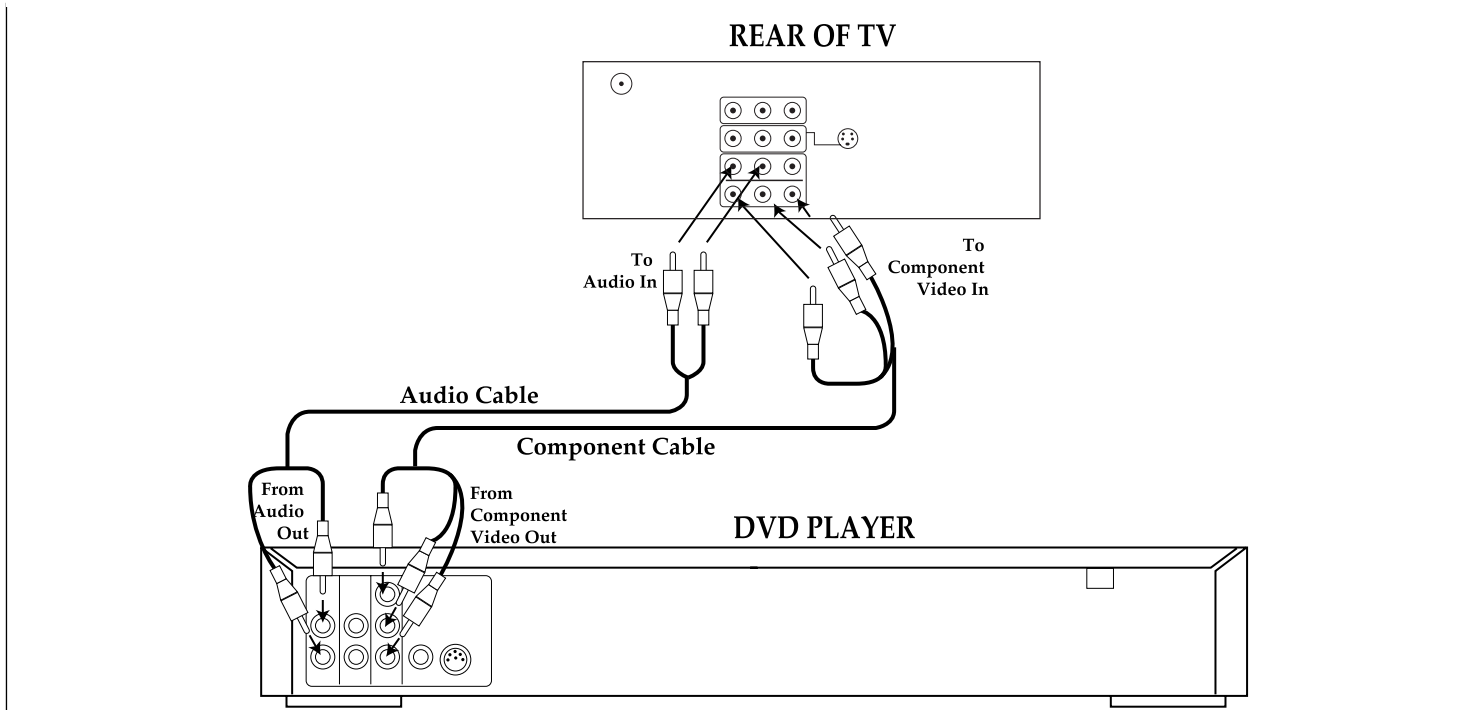

1. Connect the left and right audio cable from the DVD's Audio OUT jacks to the TV's AV2 left and right Audio IN jacks.
2. Connect a video cable from the DVD's Y, Pb, Pr OUT jacks to the TV's AV2 DVD IN (Cr, Cb, Y) jacks.
3. Press the AV button until VIDEO2 appears on the TV screen and press PLAY on the VCR to watch a tape.

## STEREO CONNECTION

Follow the instructions below to connect a stereo system to your television. (CABLES NOT INCLUDED.)

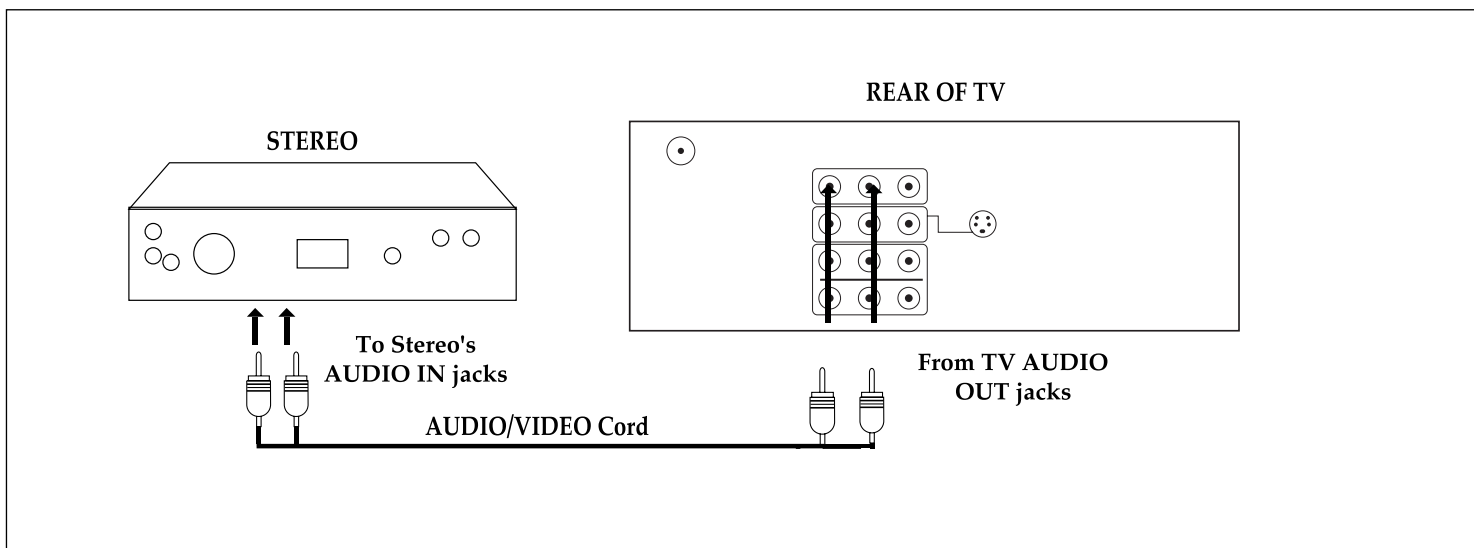

1. Connect the left and right audio cable from the TV's left and right Audio OUT jacks to the stereo system's left and right Audio IN jacks.
2. Refer to the stereo system's owner's manual for instructions.

# SETTING THE LANGUAGE

This TV can show the On-Screen display in English, Spanish or French.

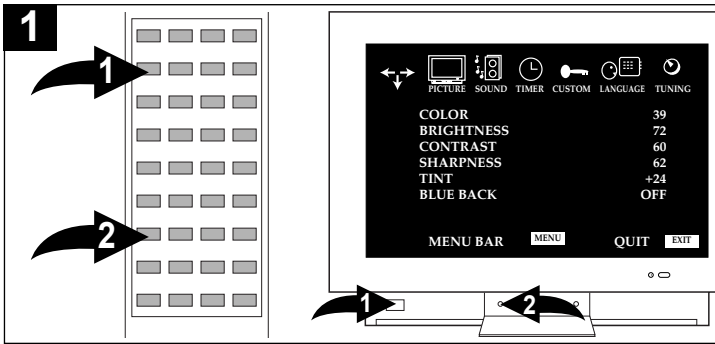

Press the POWER button ❶ to turn on the TV. Press the MENU button ❷; the MENU screen will appear.

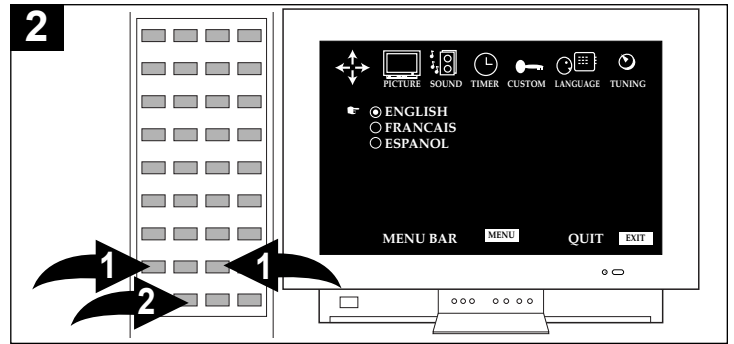

Press the Navigation (◀) or (▶) button ❶ until LANGUAGE is selected, then press the Navigation (▼) button ❷ to select the desired language.

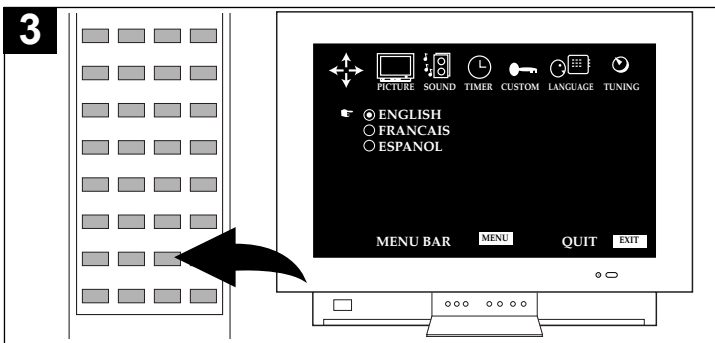

When the desired language is in red, press the Navigation (▶) button to select it.

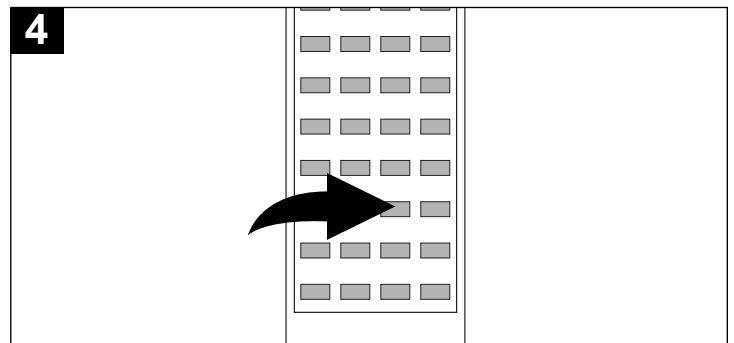

Wait 15 seconds, or press the EXIT button to exit.

## FAQs:

*Will selecting a language change the audio, or only the on-screen menus?*

Selecting a language will only change the on-screen menus.

*When I press a button on the remote, the TV does not respond?*

Refer to the FAQ's on page 7. Make sure that you press the TV Function button to use the remote control to operate the TV.

**NOTE:** After pressing the MENU button, press the Navigation button within 15 seconds, otherwise the TV will revert to normal viewing.

## CLOCK SETTING

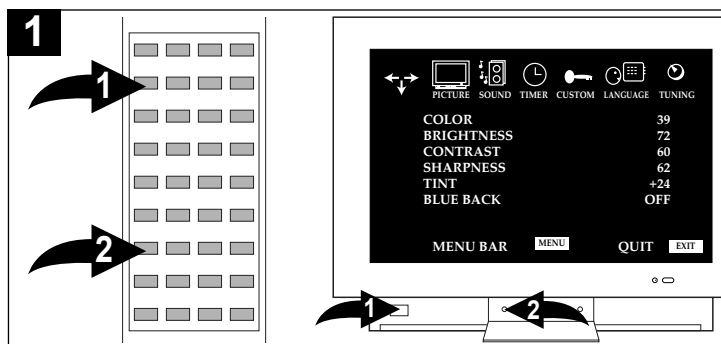

Press the POWER button ❶ to turn on the TV. Press the MENU button ❷; the MENU screen will appear.

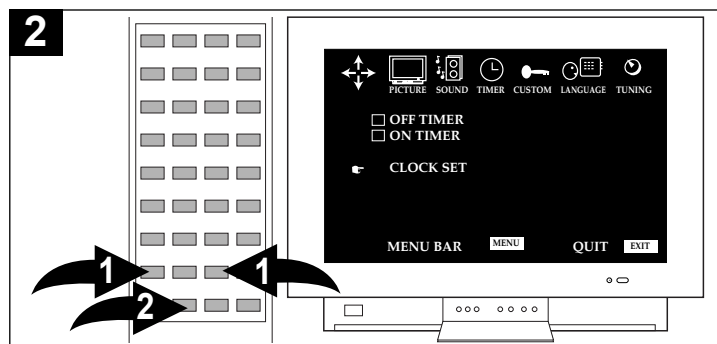

Press the Navigation (◀) or (▶) button ❶ until TIMER is selected, then scroll down using the Navigation (▼) button ❷ and select CLOCK SET.

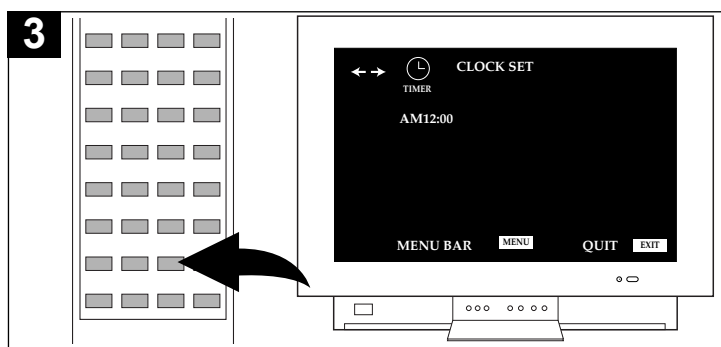

When CLOCK SET is in red, press the Navigation (▶) button to select it.

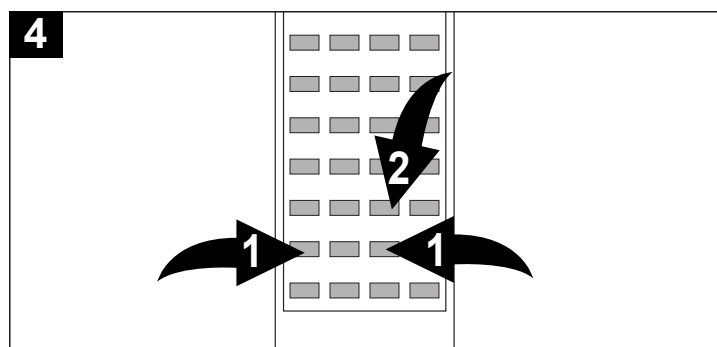

Using the Navigation (◀) and (▶) buttons ❶, set the correct time and AM/PM. Press and hold either button and the time will increase/decrease in 10 minute increments. Wait 15 seconds, or press the EXIT button ❸ to exit.

### FAQs:

*I set the clock previously, but now it is not set, why?*

If there is a power outage, or if your unit was unplugged, you may have to reset the time. Simply repeat the steps above.

*When I press a button on the remote, the TV does not respond?*

Refer to the FAQ's on page 7. Make sure that you press the TV Function button to use the remote control to operate the TV.

**NOTE:** After pressing the MENU button, press the Navigation button within 15 seconds, otherwise the TV will revert to normal viewing.

## SETTING THE TV/CATV BUTTON

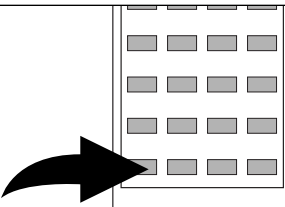
<b>1</b>		<b>OPTIONS</b>  <b>TV:</b> If using a VHF/UHF antenna.  <b>CATV:</b> If using Cable TV.
----------	---	---

Simply press the TV/CATV button to set the TV to TV or CATV (Cable TV) mode. To change the type of cable (STD, HRC, IRC), simply change the TV/CATV option under the TUNING menu.

## SETTING THE CHANNELS INTO MEMORY

This TV is equipped with a channel memory feature which allows channels to skip up or down to the next channels set into memory, skipping over unwanted channels. Before selecting channels, they must be programmed into the TV's memory. In addition to normal VHF/UHF channels, this TV can receive up to 113 Cable TV channels.

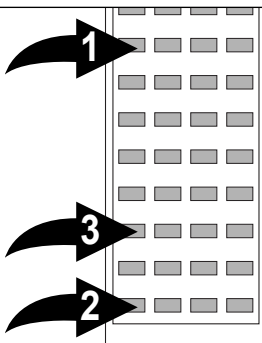
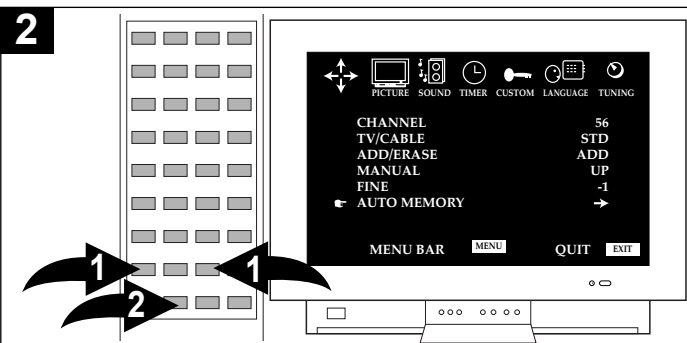
<b>1</b>		<b>2</b>	
----------	---	----------	--

Press the POWER button ❶ to turn on the TV. Set the TV/CATV button ❷ to TV or CATV (see above). Antenna, cable, satellite, etc. must be connected before memorizing channels. Press the MENU button ❸; the MENU screen will appear.

Press the Navigation (◀) or (▶) button ❶ until TUNING is selected, then scroll down using the Navigation (▼) button ❷ and select AUTO MEMORY.

**NOTE:** You cannot access TUNING menu if in VIDEO1, 2 or 3 - see FAQ's below.

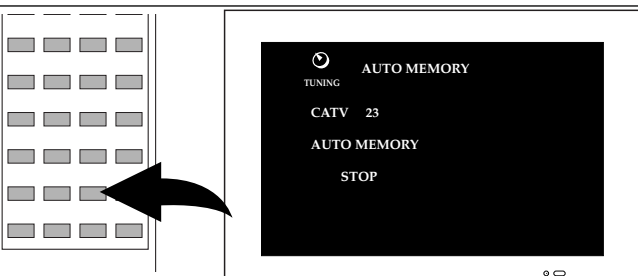
<b>3</b>	
----------	---

When AUTO MEMORY is in red, press the Navigation (▶) button to start the Auto Search. The TV will automatically cycle through all the channels and store active channels into memory. When completed, the TV will be on the first available channel.

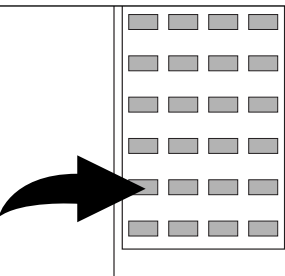
<b>4</b>	
----------	--

Press the Navigation (◀) button to stop Auto Memory while it is searching (if desired).

### FAQs:

#### *Why can't I access TUNING?*

You cannot access the TUNING option if you are in VIDEO1, VIDEO2, or VIDEO3, there is no need to.

#### *How many channels will I actually receive?*

The actual number of channels that can be received depends on how many channels your cable or satellite company, or local area provides. Contact your company to determine the number of channels in your area.

#### *Do channels need to be set into memory before using the CHANNEL Up + or Down - button?*

Yes, the channels must be programmed into memory.

# ADDING AND DELETING CHANNELS

After setting channels into memory, you can add or delete channels as follows:

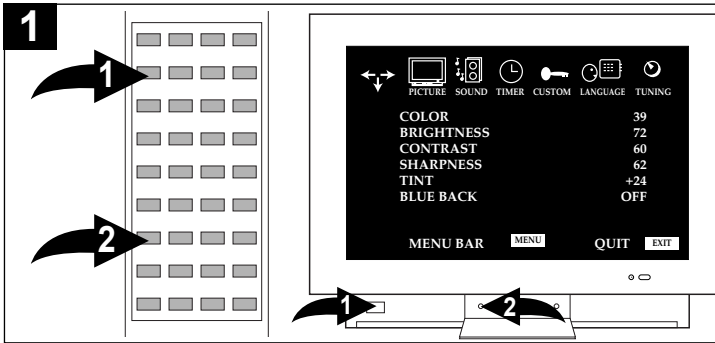

Press the POWER button ❶ to turn on the TV. Press the MENU button ❷; the MENU screen will appear.

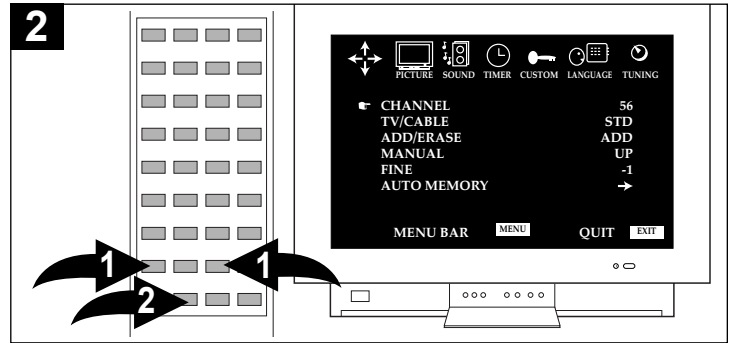

Press the Navigation (◀) or (▶) button ❶ until TUNING is selected, then scroll down using the Navigation (▼) button ❷ and select CHANNEL.

## TO ADD A CHANNEL

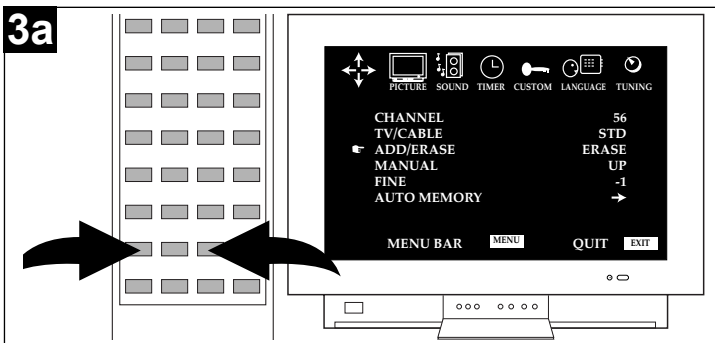

Press the Navigation (◀) or (▶) button to select a channel to be added. If a channel is already memorized, "ADD" will appear next to the ADD/ERASE option. If a channel is not memorized, "ERASE" will appear.

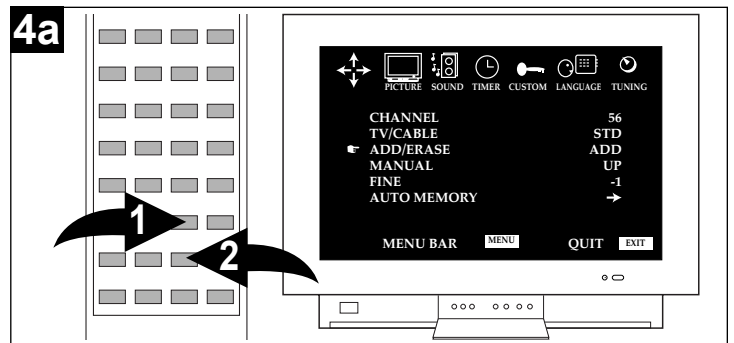

When a channel is selected and ERASE appears next to the ADD/ERASE option, press the Navigation (▶) button ❷ to add the channel. Press the EXIT button ❶ to exit the Tuning screen.

## TO DELETE A CHANNEL

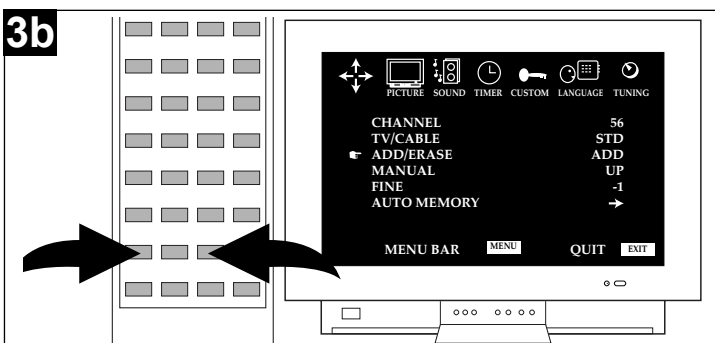

Press the Navigation (◀) or (▶) button to select a channel to be added. If a channel is already memorized, "ADD" will appear next to the ADD/ERASE option. If a channel is not memorized, "ERASE" will appear.

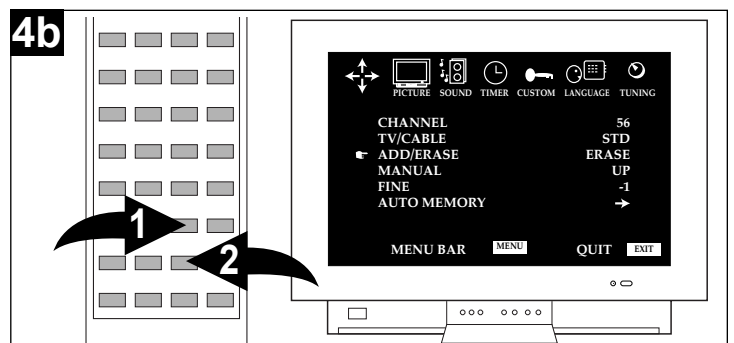

When a channel is selected and ADD appears next to the ADD/ERASE option, press the Navigation (▶) button ❷ to erase the channel. Press the EXIT button ❶ to exit the Tuning screen.

# TUNING MENU

There are 2 more options in the TUNING menu described below:

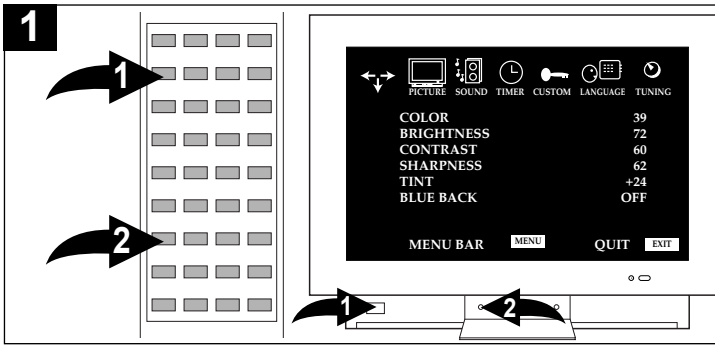

Press the POWER button ❶ to turn on the TV. Press the MENU button ❷; the MENU screen will appear.

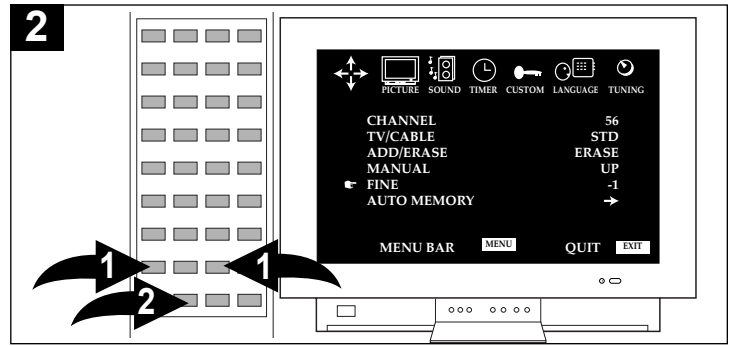

Press the Navigation (◀) or (▶) button ❶ until TUNING is selected, then scroll down using the Navigation (▼) button ❷ and select MANUAL or FINE.

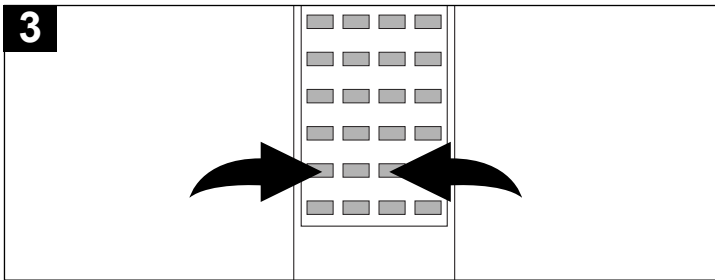

## MANUAL:

Press the Navigation (◀) or (▶) button while MANUAL is selected, the unit will then automatically go up one channel and automatically adjust the fine tuning.

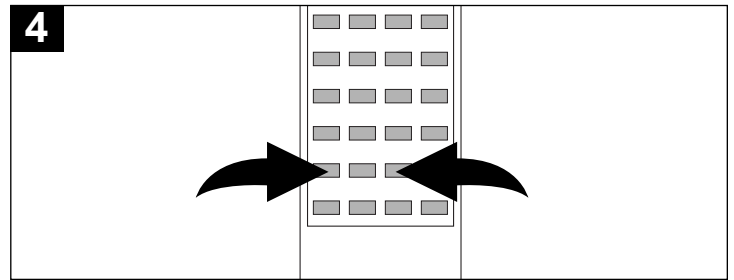

## FINE:

Press the Navigation (◀) or (▶) button while FINE is selected to adjust the Fine Tuning of the selected channel.

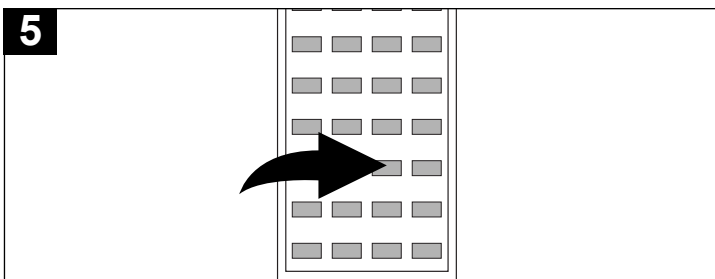

Press the EXIT button to exit.

# TV OPERATION

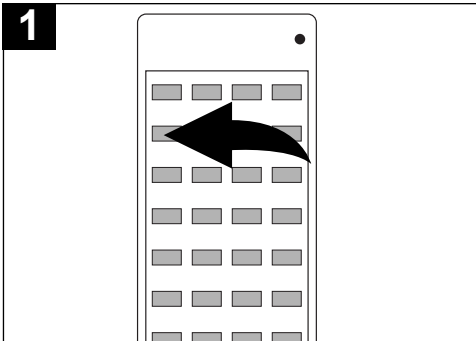

**1** Press the POWER button to turn on the TV.

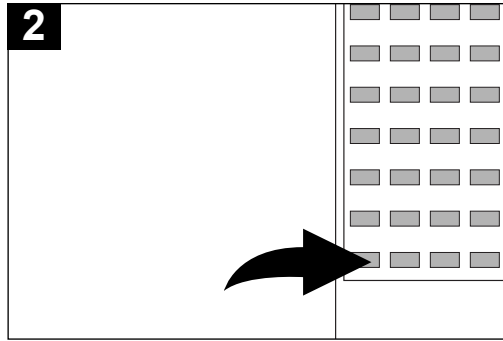

**2** Simply press the TV/CATV button to set the TV to TV or CATV (Cable TV) mode. To change the type of cable (STD, HRC, IRC), simply change the TV/CATV option under the TUNING menu.

## OPTIONS

**TV:** If using a VHF/UHF antenna.

**CATV:** If using Cable TV.

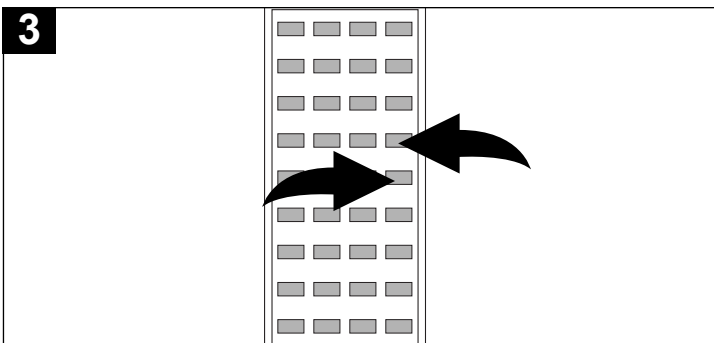

**3** Adjust the volume level by pressing the VOLUME + or – button. The volume level will be indicated on the screen by green bars. As the volume level increases/decreases, so do the number of bars.

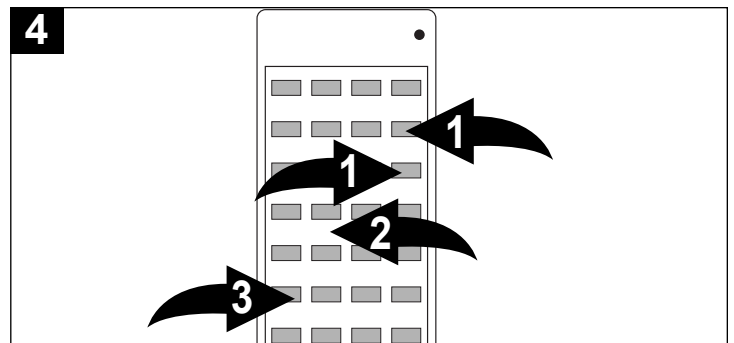

**4** For proper operation, before selecting channels, they must be set into the TV's program memory, see page 20. Press and release the CHANNEL + or – ❶ button. The TV automatically stops at the next channel set into memory. This will not operate if channels are not set into memory.

### Direct Program Selection buttons (0 - 9, 100+)

Use these buttons to select a channel. The channel number will appear at the top right corner of the screen.

- For Channels 1 through 9, press "0", then 1-9 ❷ as desired.
- For Channels 10 through 99, press the 2 digits in order.
- For Channels 100 through 125, press the -/-- button ❸, then the remaining 2 digits.

## NOTES:

- When TV/CATV is set to TV, only channels up to 69 can be selected. When set to CATV, channels up to 125 can be selected.
- The -/-- button is only used with CABLE.
- If an invalid channel is selected, the display will revert to the original channel.

## FAQs:

*Why do I only receive 69 channels, when my cable goes much higher?*  
TV/CATV must be set to CATV when using cable, see step 2 above.

*Why are some channels scrambled?*  
You must subscribe to these channels through your cable company.

*When I press a button on the remote, the TV does not respond?*  
Refer to the FAQ's on page 7. Make sure that you press the TV Function button to use the remote control to operate the TV.



## TV OPERATION (CONTINUED)

### MUTE

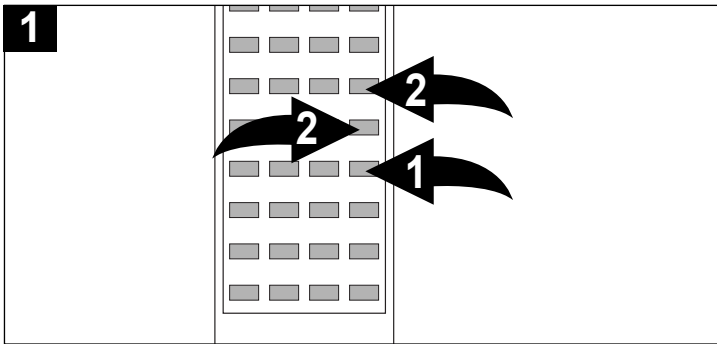

Press the MUTE button ❶ to turn off the sound. The TV's sound will be silenced and "MUTE" will appear on the screen. The sound can be turned back on by pressing this button again or one of the VOLUME + or - buttons ❷.

### SLEEP

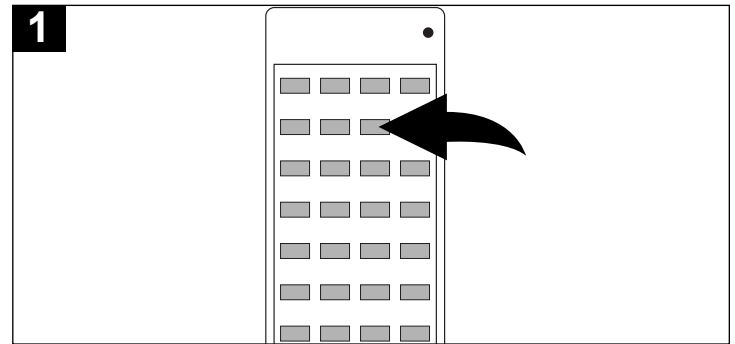

To set the TV to turn off after a preset amount of time, press the SLEEP button on the remote, "SLEEP:OFF" will appear on the screen. Each additional press will decrease the Sleep time by 10 minutes, from 120 minutes to 90 minutes. To confirm remaining sleep time, press the SLEEP button; the remaining time will briefly appear on the screen. To cancel the sleep time, press SLEEP button repeatedly until "SLEEP: OFF" appears on the screen.

### RECALL

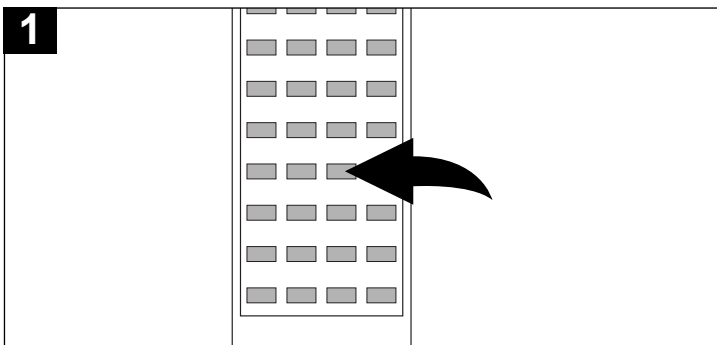

Press the RECALL button once, the channel being viewed and Stereo/Mono will appear.

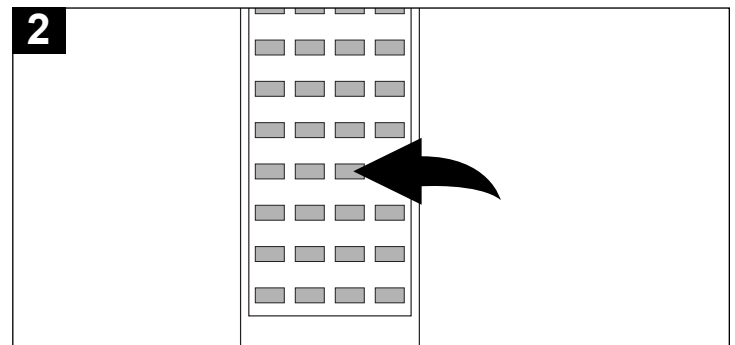

Press the RECALL button again or wait 10 seconds and the display text will disappear.

### CHANNEL REVIEW (C.R.)

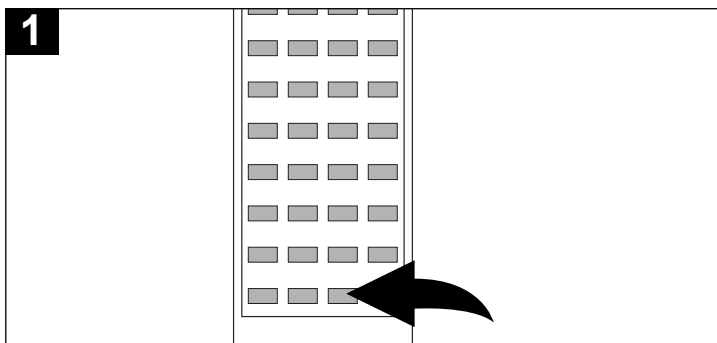

Press the C.R. (Channel Review) button to go back to the last channel selected. Press the C.R. button again to return to the channel you were watching.

### AV

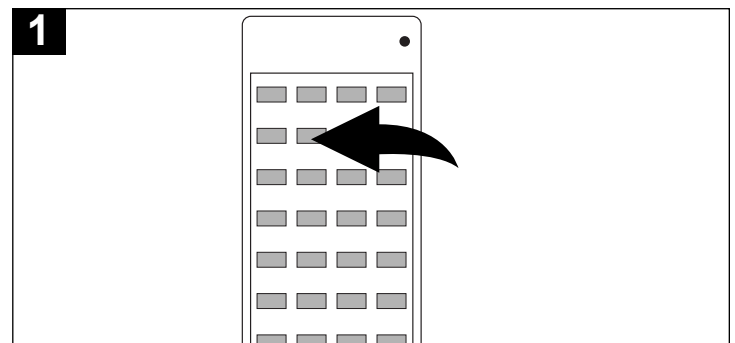

Press the AV button to cycle through the device(s) connected to the INPUT jacks; the jack number will appear on the screen. Repeatedly press to return to the antenna connected to the VHF/UHF IN jack (Cable TV, etc.).

# CLOSED CAPTIONS

## WHAT IS CLOSED CAPTIONING?

This television has the capability to decode and display Closed Captioned television programs. Closed Captioning will display text on the screen for hearing impaired viewers or it will translate and display text in another language.

## CLOSED CAPTIONING WITH A VCR

Closed Captioned programs can be recorded and played back on a VCR with the Closed Captioned text intact. The Closed Captioned text will disappear during Cue (Fast Forward Search), Review (Rewind Search) and Pause modes or if the VCR tracking is not adjusted properly.

## TO VIEW CLOSED CAPTIONS

Enter the CUSTOM MENU and select CLOSED CAPTION. Scroll down and select the desired settings:

**DISPLAY:** Turns the captions On or Off.

**MODE:** Select either C.C (Captions) or TEXT (Full screen text) as follows:

**CAPTIONS:** This Closed Caption Mode will display text on the screen in English or another language. Generally, Closed Captions in English are transmitted on Captions 1

and Closed Captions in other languages are transmitted on Captions 2.

**TEXT:** The Text Closed Caption Mode will usually fill the screen with a programming schedule or other information.

**CHANNEL:** Select between the 4 closed caption channels.

After selecting a Closed Caption Mode, it will stay in effect until it is changed, even if the channel is changed. If the Captions signal is lost due to a commercial or a break in the signal, the Captions will reappear when the signal is received again. If the channels are changed, the Captions will be delayed approximately 10 seconds.

The Captions will appear in places on the screen where they will least interfere with the picture, usually on the bottom of the screen. News programs will usually show three-line Closed Captions which scroll onto the screen. Most other shows provide two or three lined Captions placed near the character who is speaking so the viewer can follow the dialogue.

Words in italics or underlined describe titles, words in foreign languages or words requiring emphasis. Words that are sung usually appear enclosed by musical notes.

For television programs broadcasting with Closed Captions, look in your TV guide for the Closed Captions symbol (CC).

### NOTES:

- When selecting Closed Captions, the captioning will be delayed approximately 10 seconds.
- Misspellings or unusual characters may occasionally appear during Closed Captioning. This is normal with Closed Captioning, especially with live programs. This is because during live programs, captions are also entered live. These transmissions do not allow time for editing.
- When Captions are being displayed, on-screen displays, such as volume and mute may not be seen or may interfere with Closed Captions.
- Some cable systems and copy protection systems may interfere with the Closed Caption signal.
- If using an indoor antenna or if TV reception is very poor, the Closed Caption Decoder may not appear or may appear with strange characters or misspelled words. In this case, adjust the antenna for better reception or use an outdoor antenna.

## CLOSED CAPTIONS

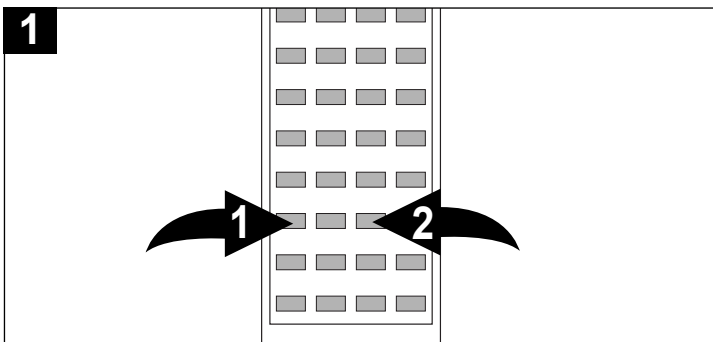

Press the MENU button ❶ to enter the CUSTOM MENU and select CLOSED CAPTION. Scroll down and select the desired settings as described above. Press the EXIT button ❷ when finished.

Closed Captioning will display text on the screen for the hearing impaired.

### FAQs:

*When I press the RECALL or MUTE button, the captions do not appear, is this normal?*

Yes, this is normal for this unit. Once the display information disappears, the captions will continue.

*I entered the Captions mode, but no captions are appearing, why?*

If no caption signal is received, no captions will appear, but the television will remain in the Caption mode.

*Why is there a big black box on the screen?*

Because you are in a Captions mode. Turn the captions off, or select a different Captions mode.

## ON-SCREEN CONTROL ADJUSTMENTS (PICTURE)

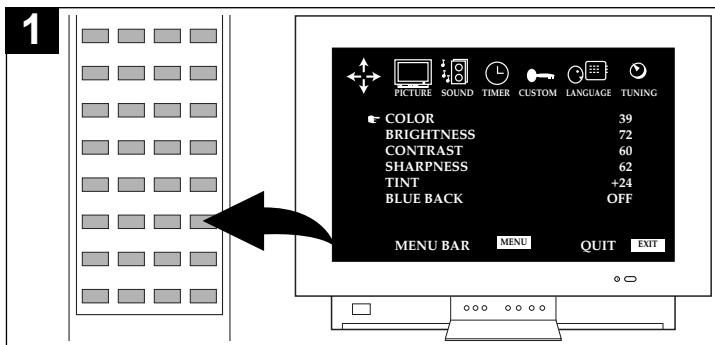

Press the PICTURE button.

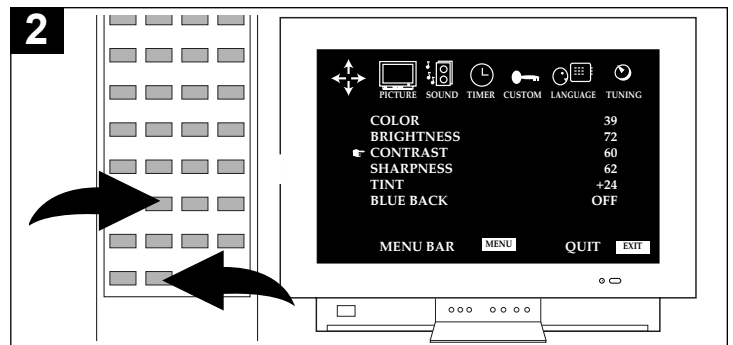

Press the Navigation (▲) or (▼) button to select the desired picture setting (COLOR, BRIGHTNESS, CONTRAST, SHARPNESS, TINT or BLUE BACK).

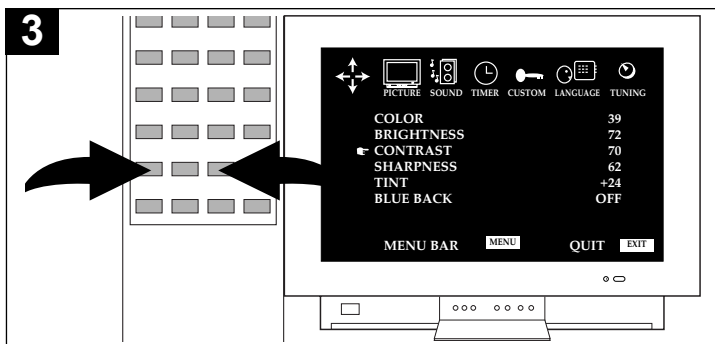

Adjust the setting using the Navigation (◀) and (▶) buttons as desired.

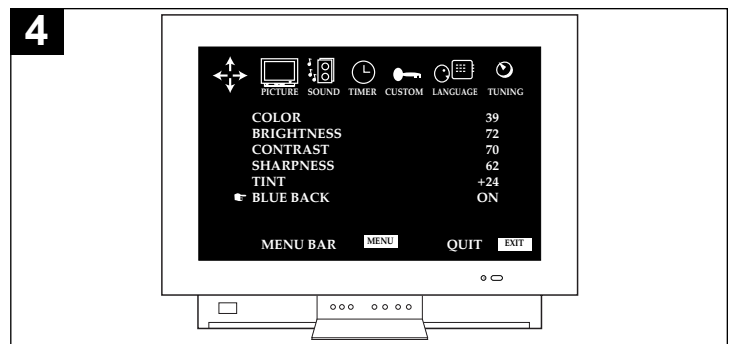

If the Blue Back option is set to ON, when a station is selected with no broadcast signal, a blue screen will appear. Turn this option off if using a DVD player.

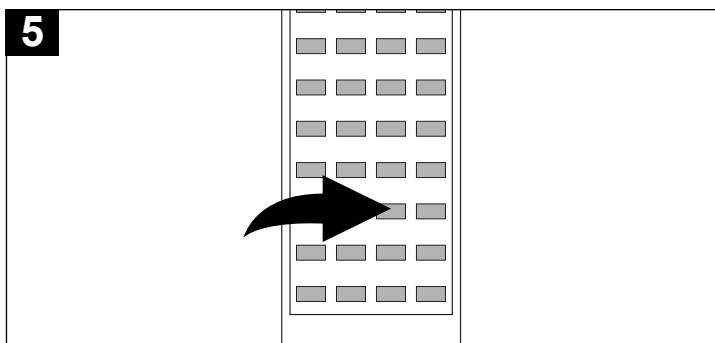

Press the EXIT button to exit the PICTURE menu.

### FAQs:

*Why is the picture very light, or not visible?*  
Brightness and/or Contrast settings are set too low.

### NOTE:

You cannot enter any of the other menus (LANGUAGE, TIMER, etc.) after pressing the PICTURE button. You must enter the menu using the MENU button.

## ON-SCREEN CONTROL ADJUSTMENTS (SOUND)

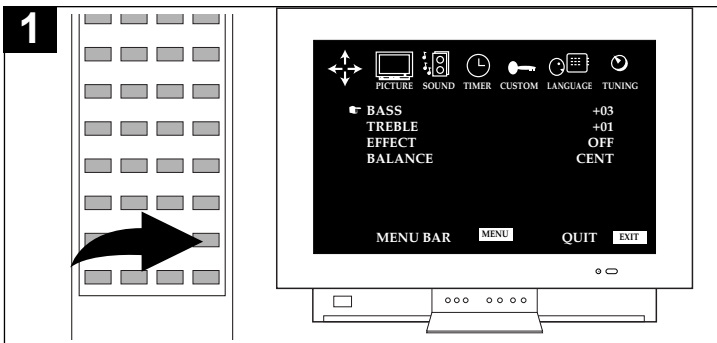

Press the SOUND button.

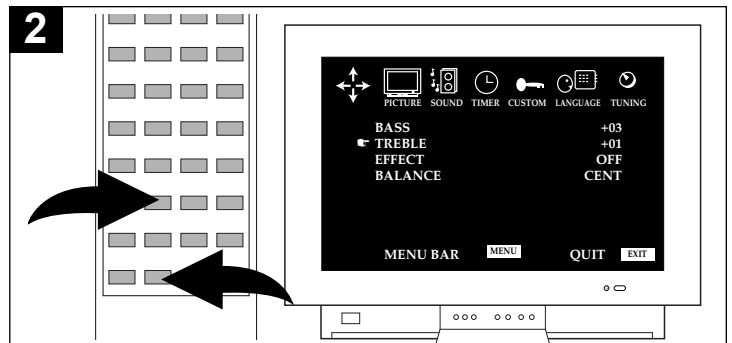

Press the Navigation (▲) or (▼) button to selected the desired sound setting (BASS, TREBLE, EFFECT and BALANCE).

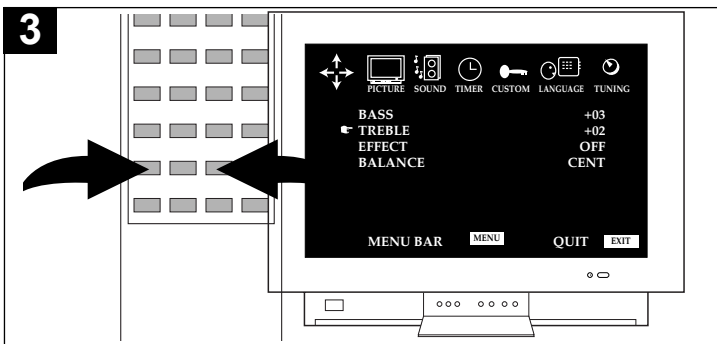

Adjust the setting using the Navigation (◀) and (▶) buttons as desired.

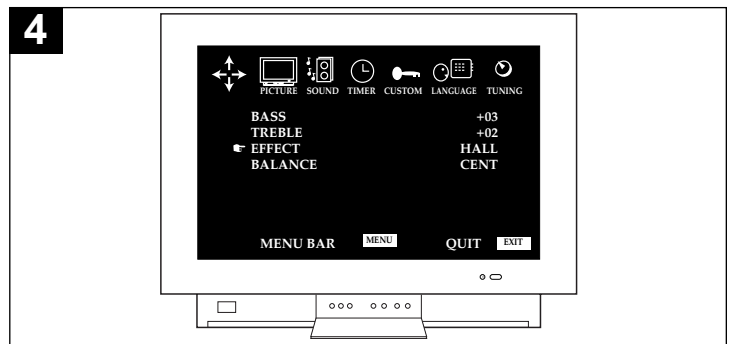

The EFFECT option will simulate a Surround Sound effect. Choose between OFF, MOVIE or HALL.

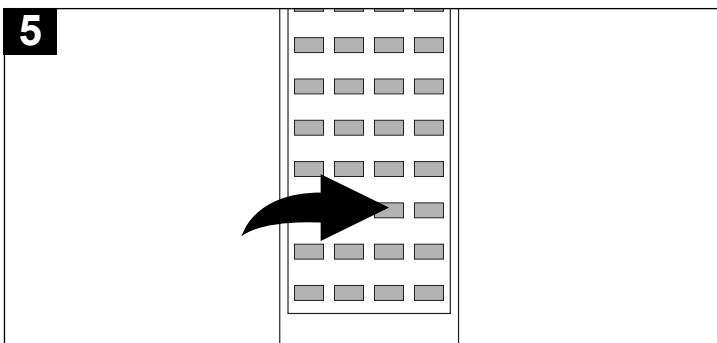

Press the EXIT button to exit the SOUND menu.

### NOTE:

You cannot enter any of the other menus (LANGUAGE, TIMER, etc.) after pressing the SOUND button. You must enter the menu using the MENU button.

# SETTING PARENTAL CONTROL

Parental Control enables parents to prevent their children from watching inappropriate material on TV. Parental Control reads the ratings for programming (except for news, sports, unedited movies on premium cable and Emergency System signals), then denies access to programming if the program's rating meets the limitations you select. In this case, the program will be blocked.

## PARENTAL CONTROL SET-UP

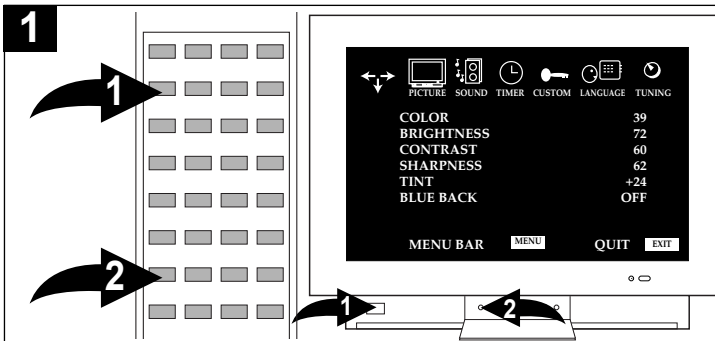

Press the POWER button ❶ to turn on the TV. Press the MENU button ❷; the MENU screen will appear.

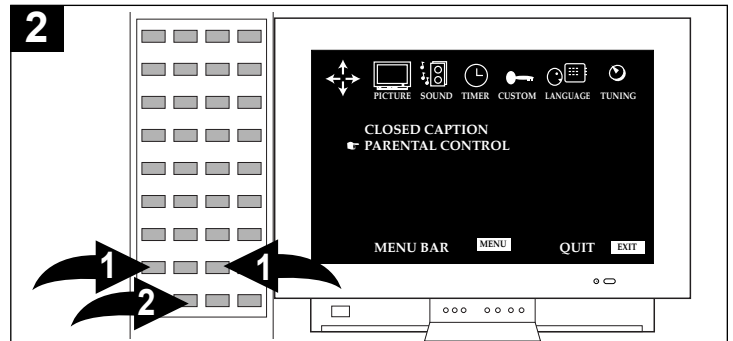

Press the Navigation (◀) or (▶) button ❶ until CUSTOM is selected, then scroll down using the Navigation (▼) button ❷ and select PARENTAL CONTROL.

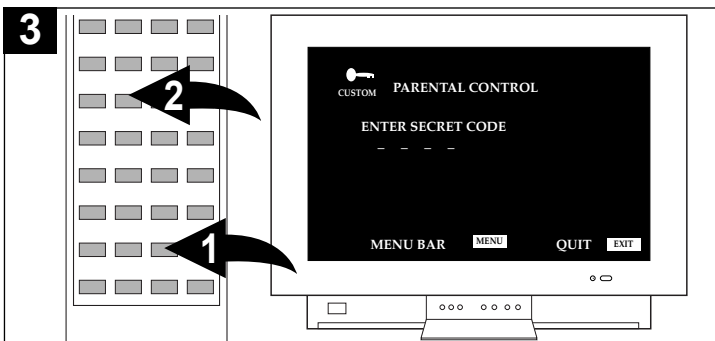

When PARENTAL CONTROL is in red, press the Navigation (▶) button ❶ to select it. Using the Direct Channel Selection buttons (0-9) ❷, enter the password ("0000" is the preset password if you have not changed it). This password can be changed to consist of different numbers (i.e. 1467, 9732) after the original password is entered.

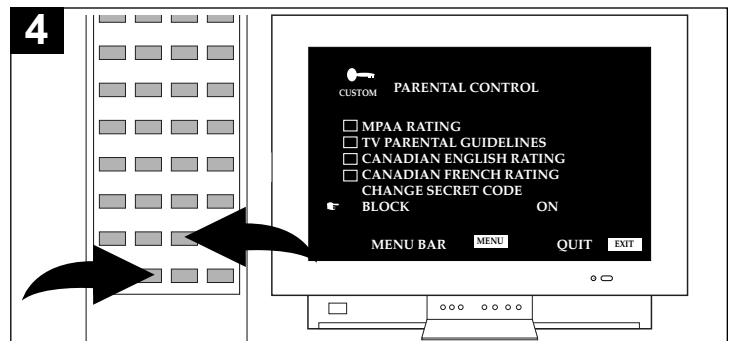

Scroll down to BLOCK using the Navigation (▼) button. When BLOCK is red, press the Navigation (▶) button to turn it on or off.

## FAQ"

### *How do I disable Parental Control?*

If you turn the TV on for the first time, setting the Parental Control to ON alone will not enable the block unless you change the preset rating for MPAA and TV.

### *When I press a button on the remote, the TV does not respond?*

Refer to the FAQ's on page 7. Make sure that you press the TV Function button to use the remote control to operate the TV.

# SETTING PARENTAL CONTROL (CONTINUED)

## MPAA RATING SET-UP

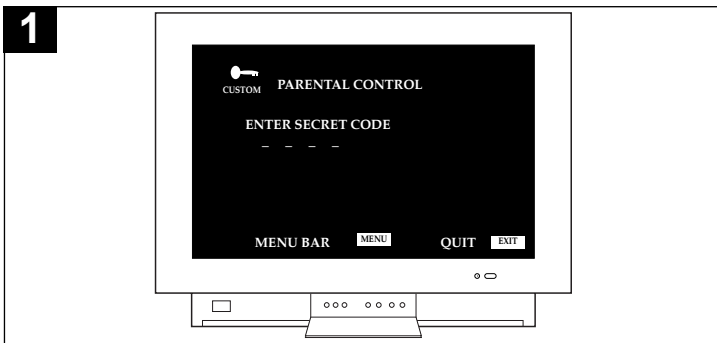

Enter the PARENTAL BLOCK menu screen as described on page 28.

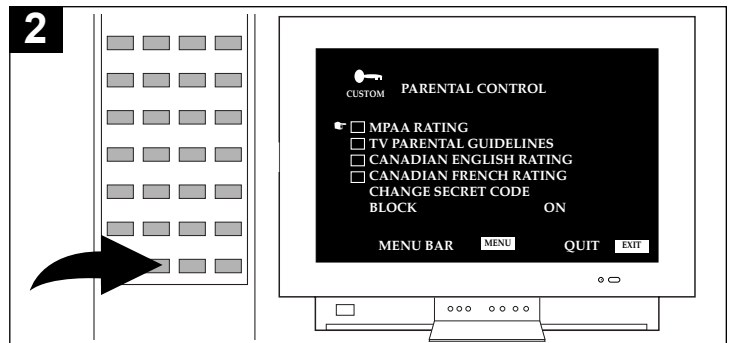

Press the Navigation (▼) button and select MPAA RATING.

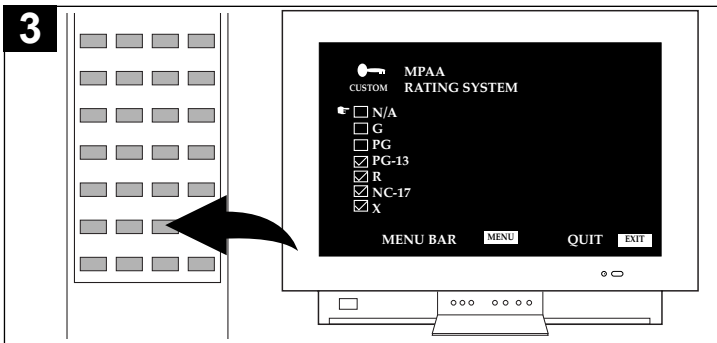

While MPAA RATING is selected, press the Navigation (►) button.

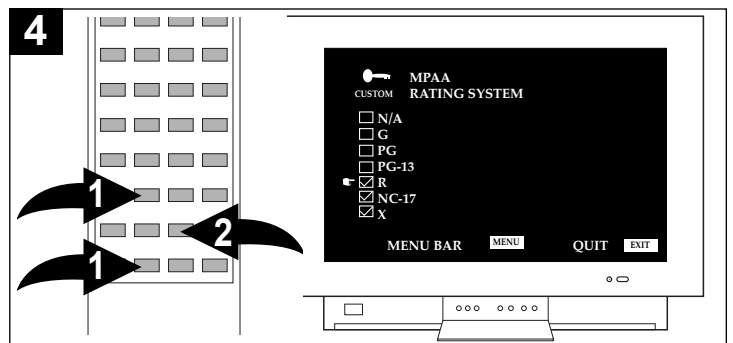

Using the Navigation (▼) or (▲) button ❶, select the desired rating, then press the Navigation (►) button ❷. See below.

- |   |  |
|---|--|
| <b>N/A:</b> Movie rating is not set.                  | <b>R:</b> Under 17 years old, Parental Guidance suggested. |
| <b>G:</b> All ages                                    | <b>NC17:</b> 17 years old and above.                       |
| <b>PG:</b> Parental Guidance, less than 13 years old. | <b>X:</b> Adult only.                                      |

All programs with a higher rating than the one selected will also be blocked. If you do not want to block any, set it to N/A.

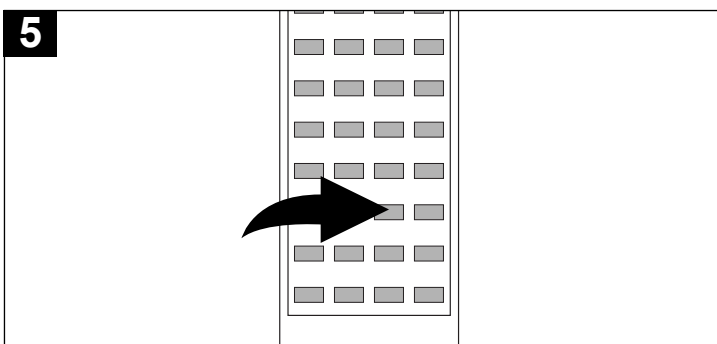

Press the EXIT button to exit.

# SETTING PARENTAL CONTROL (CONTINUED)

## TV RATING SET-UP

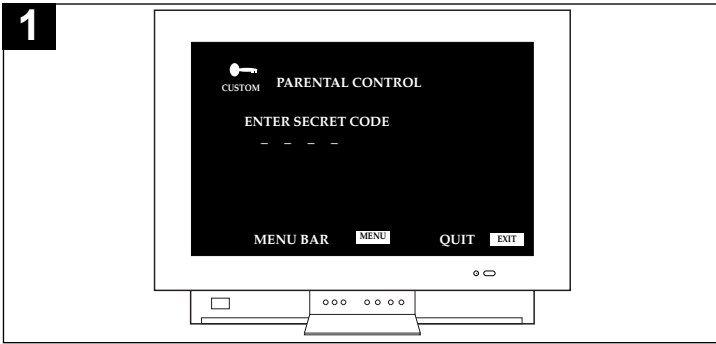

Enter the PARENTAL BLOCK menu screen as described on page 28.

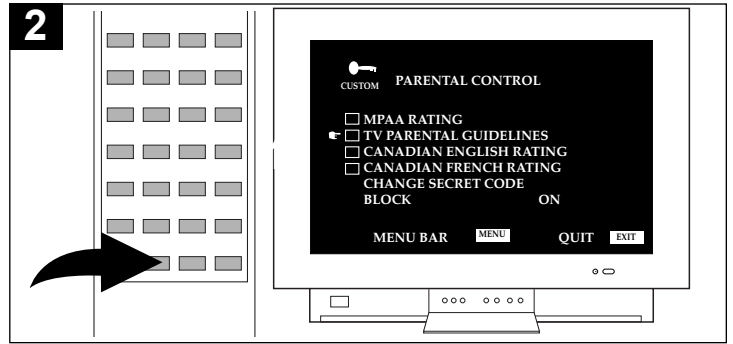

Press the Navigation (▼) button and select TV PARENTAL GUIDELINES.

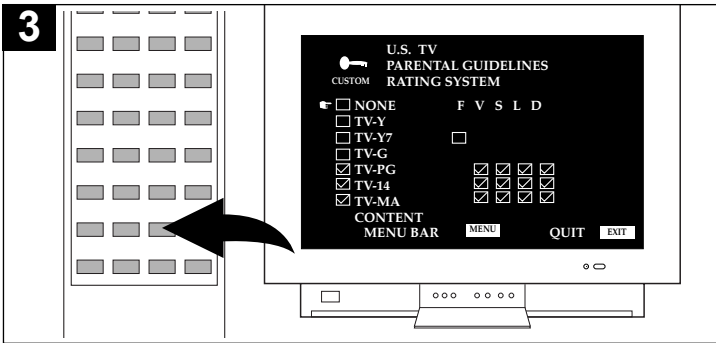

While TV PARENTAL GUIDELINES is selected, press the Navigation (▶) button.

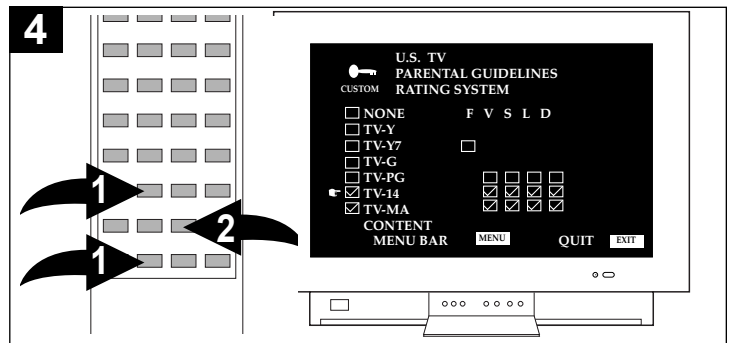

Using the Navigation (▼) or (▲) button ①, select the desired rating, then press the Navigation (▶) button ②. The letters/boxes next to the ratings represent the following:

**FV:** Fantasy Violence      **S:** Sexual Situations  
**D:** Suggestive Dialogue      **V:** Violence  
**L:** Adult Language

All programs with a higher rating than the one selected will also be blocked. If you do not want to block any, set it to NONE.

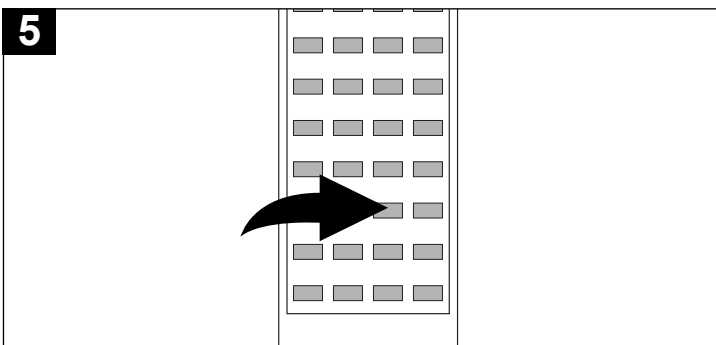

Press the EXIT button to exit.

# SETTING PARENTAL CONTROL (CONTINUED)

## CANADIAN ENGLISH /FRENCH RATING SET-UP

This setting is used to receive data service for the Canadian English/French Language Rating System in accordance with the EAI-744-A Standard.

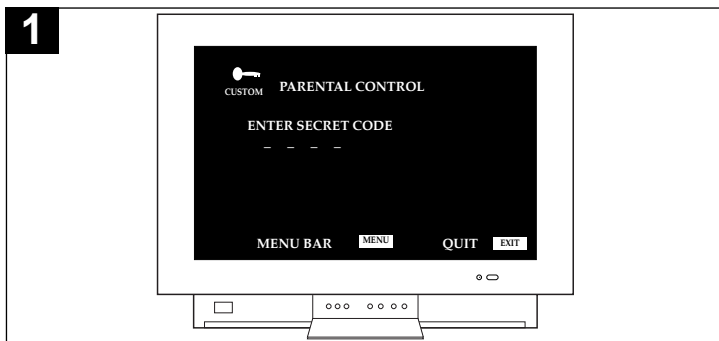

Enter the PARENTAL BLOCK menu screen as described on page 28.

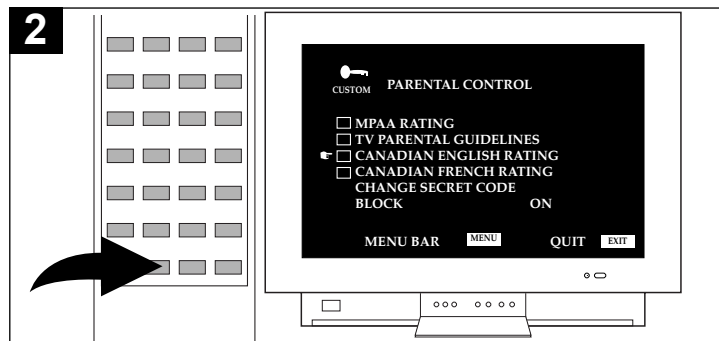

Press the Navigation (▼) button and select CANADIAN ENGLISH RATING or CANADIAN FRENCH RATING.

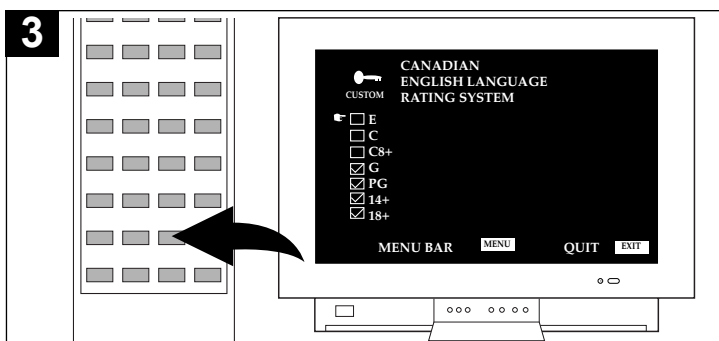

While CANADIAN ENGLISH RATING or CANADIAN FRENCH RATING is selected, press the Navigation (▶) button.

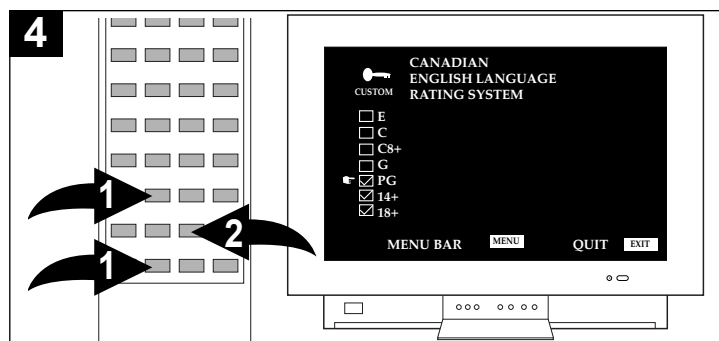

Using the Navigation (▼) or (▲) button ①, select the desired rating, then press the Navigation (▶) button ②. All programs with a higher rating than the one selected will also be blocked.

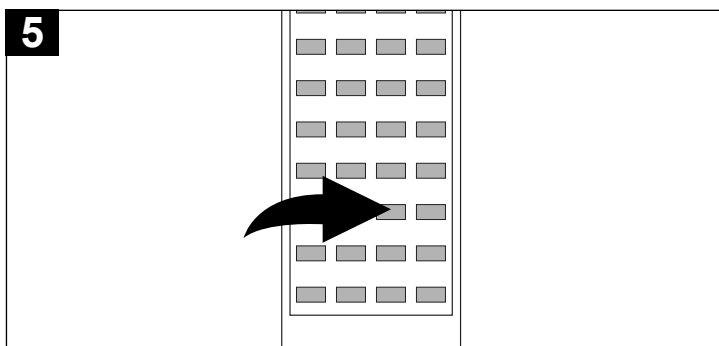

Press the EXIT button to exit.



# SETTING PARENTAL CONTROL (CONTINUED)

## CHANGING THE PASSWORD

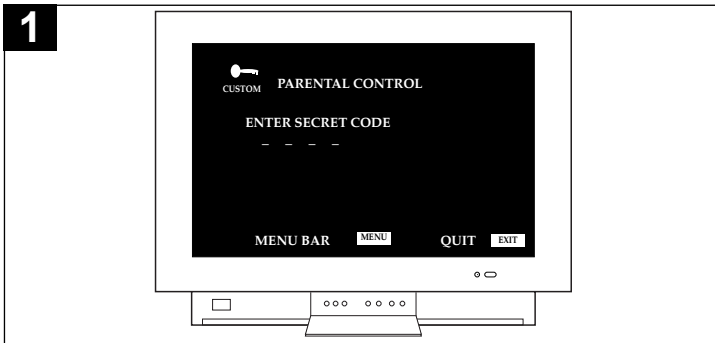

Enter the PARENTAL BLOCK menu screen as described on page 28.

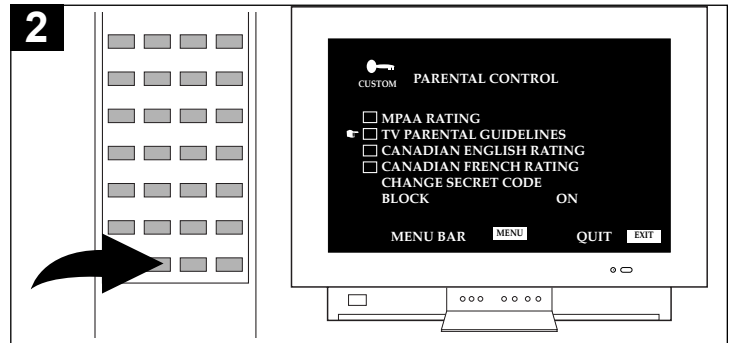

Press the Navigation (▼) button and select CHANGE SECRET CODE. Preset code is set to "0000".

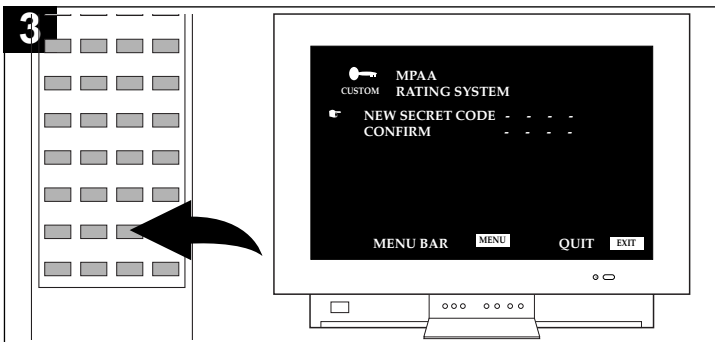

While CHANGE SECRET CODE is selected, press the Navigation (▶) button.

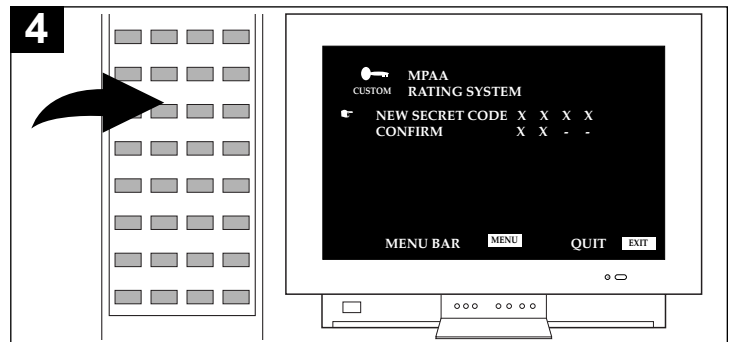

Using the Direct Channel Selection buttons, enter the new secret code, and then confirm the new code again.

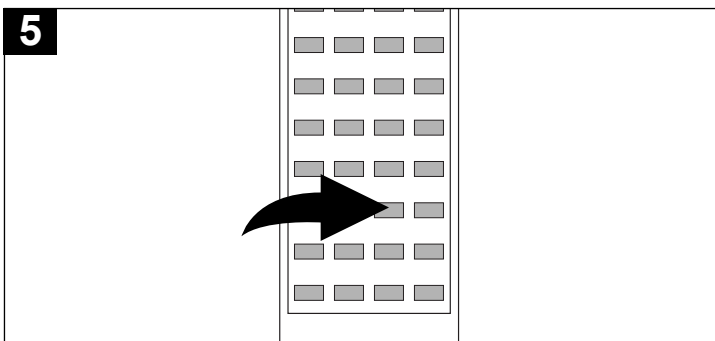

Press the EXIT button to exit.

# SETTING THE ON TIMER

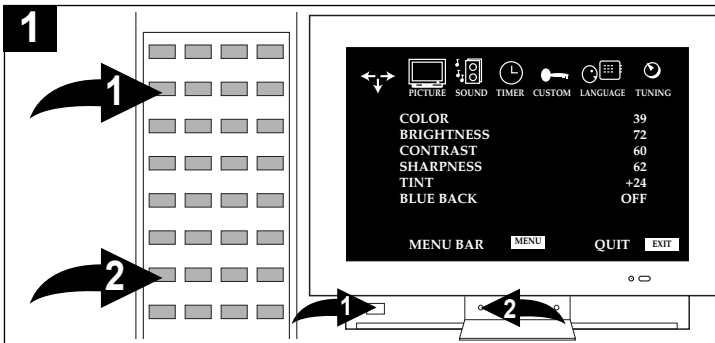

Press the POWER button ❶ to turn on the TV. Press the MENU button ❷; the MENU screen will appear.

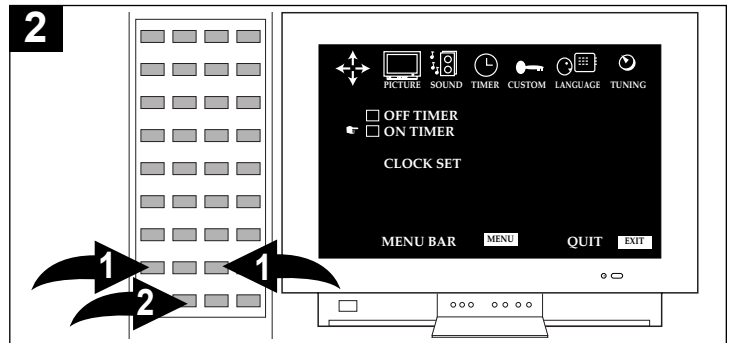

Press the Navigation (◀) or (▶) button ❶ until TIMER is selected, then scroll down using the Navigation (▼) button ❷ and select ON TIMER.

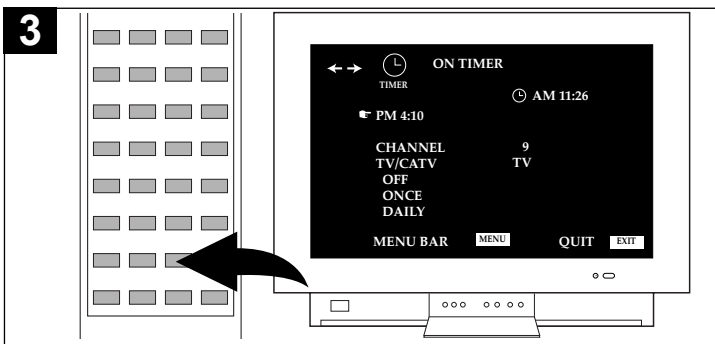

When ON TIMER is in red, press the Navigation (▶) button to select it.

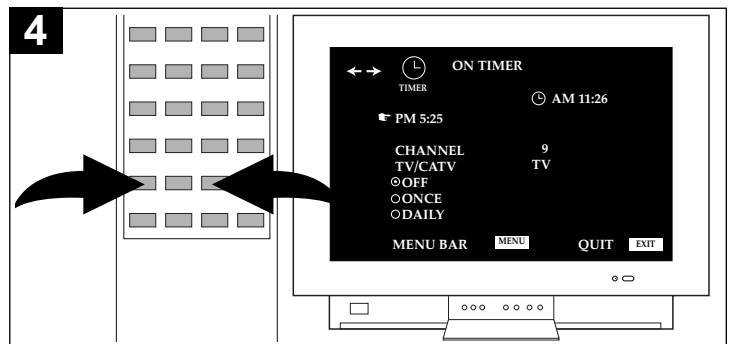

Using the Navigation (◀) and (▶) buttons, set the desired time you would like the TV to turn on (make sure to set the correct AM/PM). Press and hold either button and the time will increase/decrease in 10 minute increments.

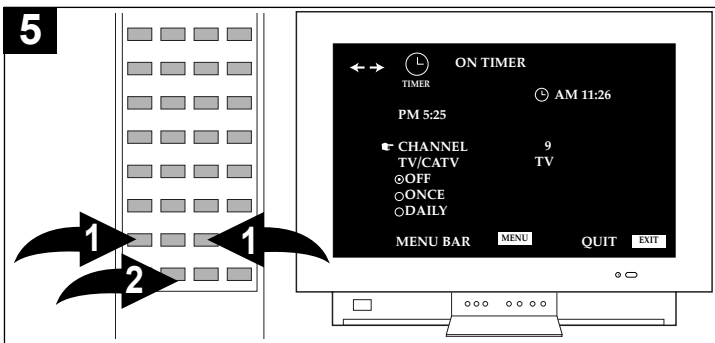

Press the Navigation (▼) button ❷ and then the Navigation (◀) and (▶) buttons ❶ to set the desired channel you would like the TV to turn on to.

Press the Navigation (▼) button ❷ and then the Navigation (◀) and (▶) buttons ❶ to select TV or CATV.

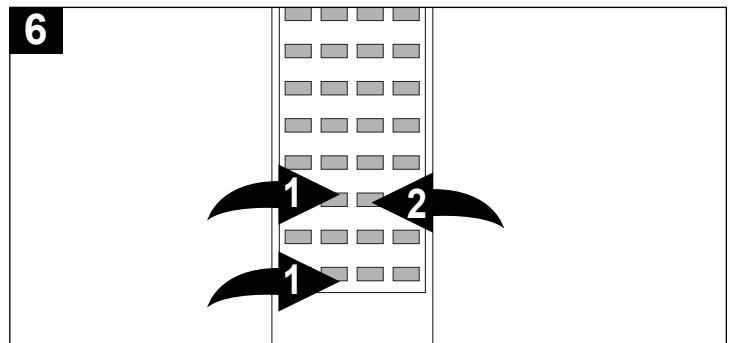

Press the Navigation (▲) or (▼) button ❶ to select between OFF (will turn On Timer off), ONCE (will set the On Timer to turn on once), or DAILY (will set the On Timer to turn on Daily.)

Press the EXIT button ❷ when finished. Press the POWER button ❸ to turn off the unit.

When the On Timer time matches the actual time, the TV will turn on.

## FAQs:

*Does the clock have to be set before using the On and Off Timers?*

Yes, the clock must be set.

## SETTING THE OFF TIMER

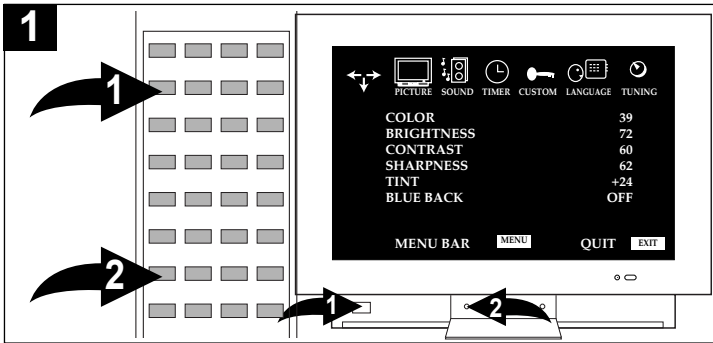

Press the POWER button ❶ to turn on the TV. Press the MENU button ❷; the MENU screen will appear.

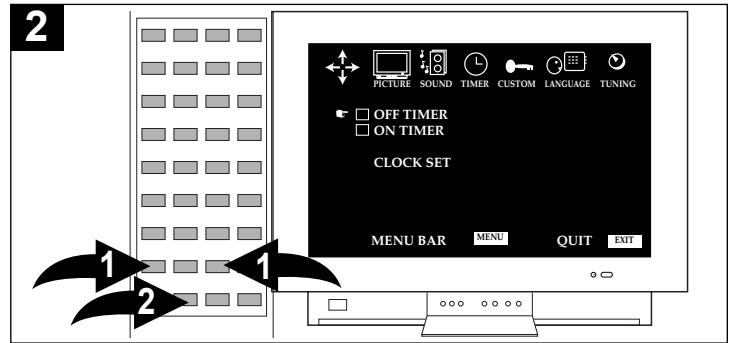

Press the Navigation (◀) or (▶) button ❶ until TIMER is selected, then scroll down using the Navigation (▼) button ❷ and select OFF TIMER.

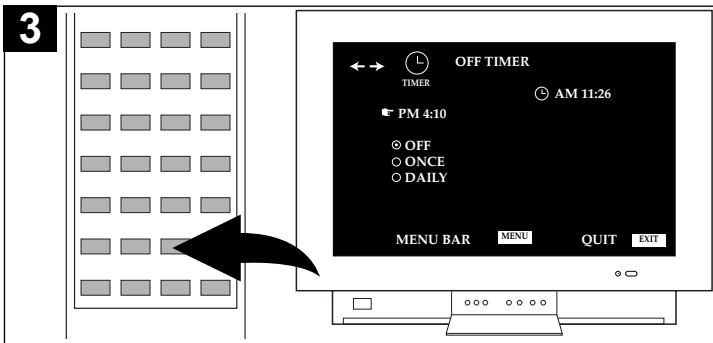

When OFF TIMER is in red, press the Navigation (▶) button to select it.

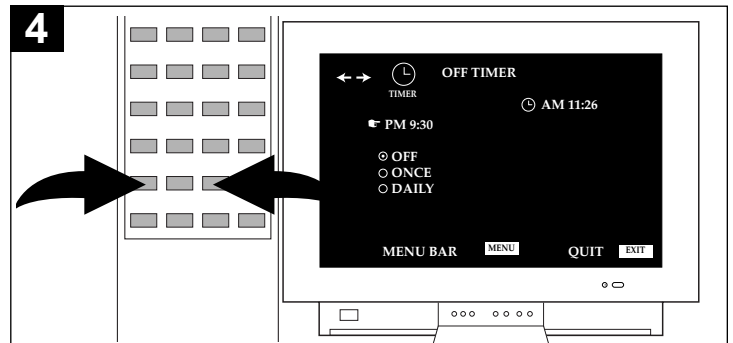

Using the Navigation (◀) and (▶) buttons, set the desired time you would like the TV to turn off (make sure to set the correct AM/PM). Press and hold either button and the time will increase/decrease in 10 minute increments.

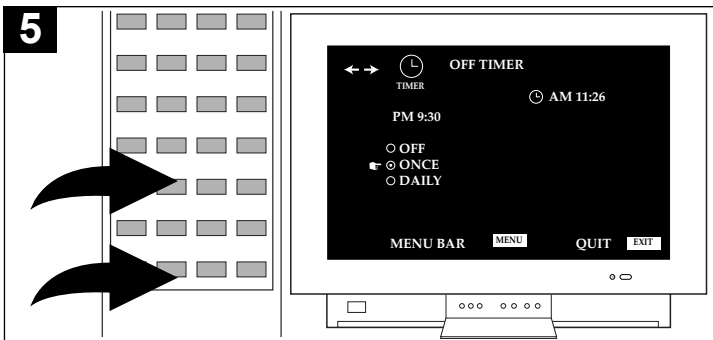

Press the Navigation (▲) or (▼) button to select between OFF (will turn Off Timer off), ONCE (will set the Off Timer to turn off once), or DAILY (will set the Off Timer to turn off Daily.)

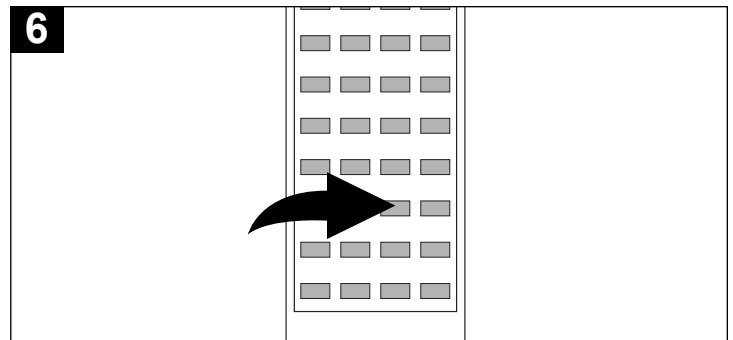

Press the EXIT button when finished. When the Off Timer time matches the actual time, the TV will turn off.

### FAQs:

*Does the clock have to be set before using the On and Off Timers?*

Yes, the clock must be set.

*When I press a button on the remote, the TV does not respond?*

Refer to the FAQ's on page 7. Make sure that you press the TV Function button to use the remote control to operate the TV.

# TROUBLESHOOTING GUIDE

Check the following before requesting service:

SYMPTOM	POSSIBLE CAUSE	POSSIBLE SOLUTION
<b>POWER</b>		
No power.	The AC power cord is not connected.	Connect the AC power cord to the AC outlet.
<b>TV BROADCAST RECEPTION</b>		
Poor or no picture.	TV station experiencing problems.	Try another channel.
	Picture control is not adjusted.	Check picture control adjustments.
	Possible local interference.	Check for source of reception disturbance.
	Antenna/CATV connector is not connected.	Check CATV connection or VHF/UHF antenna.
Picture wobbles or drifts.	TV station experiencing problems.	Try another channel.
	Cable TV channel is scrambled.	A Cable box needs to be used (if desired).
	Possible local interference.	Check for source of reception disturbance.
No CATV reception.	CATV connected or not connected.	Check all CATV connections.
	TV/CATV set to TV.	Set TV/CATV to CATV.
	Cable TV service interrupted.	Contact your Cable TV company.
No reception above ch13.	TV/CATV set to TV.	Set TV/CATV to CATV.
Poor or no sound.	TV station experiencing problems.	Try another channel.
	MUTE button is pressed.	Press MUTE button again.
	Possible local interference.	Check for source of reception disturbance.
	Antenna/CATV connector is not connected.	Check CATV connection or VHF/UHF antenna.
	Volume is set to minimum.	Increase volume.
TV shuts off.	TV station stopped broadcasting.	Tune to a new channel.
	Sleep Timer is set.	Set Sleep Timer to Off.
	Off Timer is set.	Set Off Timer to Off.
Closed Captioning not working.	TV signal is weak.	Check CATV or VHF/UHF antenna connection.
	TV station experiencing problems or program tuned is not closed captioned.	Try another channel.
	Closed Captioning not turned on.	Turn Closed Captioning on.
<b>REMOTE CONTROL</b>		
Remote control does not operate.	The desired Function button (i.e.TV) is not pressed.	Press the desired Function button. See Important note on page 8.
	Distance is too far or too much light in the room.	Operate within 10 feet or reduce the light in the room.
	There is an obstacle in the path of the beam or remote is not aimed at the sensor.	Clear the path of the beam and/or aim the remote at the sensor.
	The batteries are weak or installed incorrectly.	Replace the batteries or install correctly.
	The remote code is not set properly or the TV code was changed by accident.	Set the correct remote code. If the TV code was changed, change it back to "0001".
<b>PARENTAL CONTROL (PC)</b>		
PC protection not working properly.	Parental Control setting is turned off.	Turn Parental Control setting on.
	News or sports event being broadcast.	Parental Control does not work with news or sporting events.
	Ratings not set.	Set ratings as desired.

## RECEPTION DISTURBANCES

Most types of television interference can be remedied by adjusting the height and position of the VHF/UHF antenna. Outdoor antennas are recommended for best results if not using cable or a satellite. The most common types of television interference are shown below. If one of these symptoms appear when the TV is connected to a Cable TV system, the disturbance may be caused by the local cable company broadcast.

### IGNITION:

Black spots or horizontal streaks may appear, picture may flutter or drift. Usually caused by interference from automobile ignition systems, neon lamps, electric drills and other electric appliances.



### GHOSTS:

Ghosts are caused by the television signal following two paths. One is the direct path and the other is reflected from tall buildings, hills or other objects. Changing the direction or position of the antenna may improve the reception.

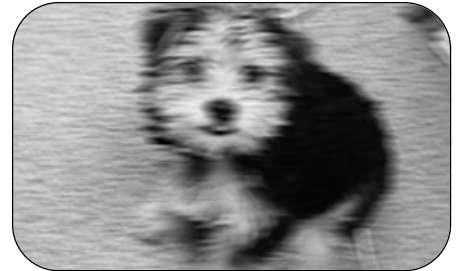

### SNOW:

If your receiver is located in the fringe area of a television station where the signal is weak, your picture may be marred by the appearance of small dots. When the signal is extremely weak, it may be necessary to install an external antenna to improve the picture.



### RADIO FREQUENCY INTERFERENCE:

This interference produces moving ripples or diagonal streaks, and in some cases, causes loss of contrast in the picture.



### PICTURE SIZE VARIATION:

A slight picture size variation is quite normal when you adjust the CONTRAST or BRIGHTNESS setting.

## SPECIFICATIONS

Picture Tube .....	24" True Flat
Tuner Type .....	Quartz PLL Frequency Synthesized
Receiving Channels (VHF) .....	2 ~ 13
Receiving Channels (UHF) .....	14 ~ 69
Receiving Channels (CATV) .....	14 ~ 36 (A)-(W) 37 ~ 59 (AA)-(WW) 60 ~ 85 (AAA)-(ZZZ) 86 ~ 94 (86)-(94) 95 ~ 99 (A-5)-(A-1) 100 ~ 125 ( 100)-(125) 01 (5A)
Antenna Input .....	VHF/UHF in 75 ohms coaxial
Speaker .....	3" x 6" 8 ohms 10 W x 2
Audio Output .....	5W + 5W
Power Source .....	AC 120V 60 Hz
Power Consumption .....	120 Watts
Input/Output	
Video In .....	RCA 1Vp-p 75 ohm
Video Out .....	RCA 1Vp-p 75 ohm
Audio In .....	RCA 300 mV/50 1K ohm
Audio Out .....	RCA 300 mV/50 1K ohm
Unit Dimensions .....	632 x499 x472 mm
Weight .....	34.5 kgs

## CARE AND MAINTENANCE

To prevent fire or shock hazard, disconnect your unit from the AC power source when cleaning. The finish on the receiver may be cleaned with a dust cloth and cared for as other furniture. Use caution when cleaning and wiping the plastic parts. Mild soap and a soft, damp cloth may be used.

**FOR ADDITIONAL SET-UP OR OPERATING ASSISTANCE, PLEASE VISIT OUR WEBSITE AT [WWW.MEMCORPINC.COM](http://WWW.MEMCORPINC.COM) OR CONTACT CUSTOMER SERVICE AT 1-800-919-3647.**

**PLEASE KEEP ALL PACKAGING MATERIAL FOR AT LEAST 90 DAYS IN CASE YOU NEED TO RETURN THIS PRODUCT TO YOUR PLACE OF PURCHASE OR MEMOREX.**

**FOR PARTS AND ACCESSORIES, CONTACT FOX INT'L AT 1-800-321-6993.**

Memcorp, Inc.  
Weston, FL 33331  
Printed in Hong Kong

Visit our website at [www.memcorpinc.com](http://www.memcorpinc.com)

## Free Manuals Download Website

<http://myh66.com>

<http://usermanuals.us>

<http://www.somanuals.com>

<http://www.4manuals.cc>

<http://www.manual-lib.com>

<http://www.404manual.com>

<http://www.luxmanual.com>

<http://aubethermostatmanual.com>

Golf course search by state

<http://golfingnear.com>

Email search by domain

<http://emailbydomain.com>

Auto manuals search

<http://auto.somanuals.com>

TV manuals search

<http://tv.somanuals.com>