

Wynn

UNDERCABINET CD CLOCK RADIO

MODEL: MMG-CR3810

**BEFORE OPERATING THIS PRODUCT,
PLEASE READ THESE INSTRUCTIONS COMPLETELY.**

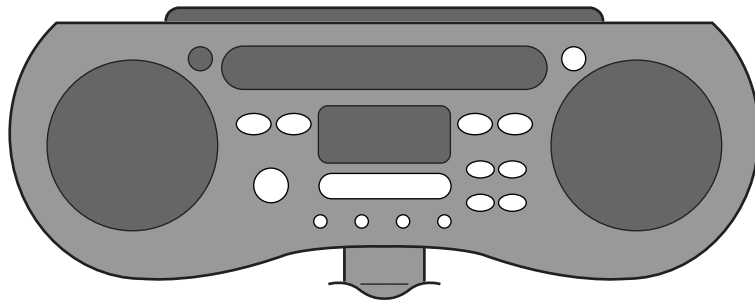

OPERATING INSTRUCTIONS

SAFETY PRECAUTIONS



CAUTION

**RISK OF ELECTRIC SHOCK
DO NOT OPEN**



CAUTION: TO REDUCE THE RISK OF ELECTRIC SHOCK, DO NOT REMOVE COVER (OR BACK). NO USER-SERVICEABLE PARTS INSIDE. REFER SERVICING TO QUALIFIED SERVICE PERSONNEL.

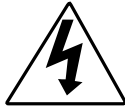

The lightning flash with arrowhead symbol, within an equilateral triangle is intended to alert the user to the presence of uninsulated 'dangerous voltage' within the product's enclosure that may be of sufficient magnitude to constitute a risk of electric shock to persons.



The exclamation point within an equilateral triangle is intended to alert the user to the presence of important operating and maintenance (servicing) instructions in the literature accompanying the appliance.

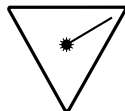

DANGER:

Invisible and hazardous laser radiation when open and interlock failed or defeated. Avoid direct exposure to beam.

FCC WARNING:

This equipment may generate or use radio frequency energy. Changes or modifications to this equipment may cause harmful interference unless the modifications are expressly approved in the instruction manual. The user could lose the authority to operate this equipment if an unauthorized change or modification is made.

LASER SAFETY: This unit employs a laser. Only qualified service personnel should attempt to service this device due to possible eye injury.

CAUTION: USE OF CONTROLS, ADJUSTMENTS OR PERFORMANCE PROCEDURE HEREIN MAY RESULT IN HAZARDOUS RADIATION EXPOSURE.

SURGE PROTECTORS:

It is recommended to use a surge protector for AC connection. Lightning and power surges ARE NOT covered under warranty for this product.

INFORMATION:

This equipment has been tested and found to comply with the limits for a Class B digital device, pursuant to Part 15 of the FCC Rules. These limits are designed to provide reasonable protection against harmful interference in a residential installation. This equipment generates, uses, and can radiate radio frequency energy and, if not installed and used in accordance with instructions, may cause harmful interference to radio communications. However, there is no guarantee that interference will not occur in a particular installation. If this equipment does cause harmful interference to radio or television reception, which can be determined by turning the equipment off and on, the user is encouraged to try to correct the interference by one or more of the following measures:

- Reorient or relocate the receiving antenna.
- Increase the separation between the equipment and receiver.
- Connect the equipment into an outlet on a circuit different from that to which the receiver is connected.
- Consult the dealer or an experienced radio/TV technician for help.

IMPORTANT SAFETY INSTRUCTIONS

Before using the unit, be sure to read all operating instructions carefully. Please note that these are general precautions and may not pertain to your unit. For example, this unit may not have the capability to be connected to an outdoor antenna.

1. READ INSTRUCTIONS

All the safety and operating instructions should be read before the product is operated.

2. RETAIN INSTRUCTIONS

The safety and operating instructions should be retained for future reference.

3. HEED WARNINGS

All warnings on the product and in the operating instructions should be adhered to.

4. FOLLOW INSTRUCTIONS

All operating and use instructions should be followed.

5. CLEANING

Unplug this product from the wall outlet before cleaning. Do not use liquid cleaners or aerosol cleaners. Use a damp cloth for cleaning.

6. ATTACHMENTS

Do not use attachments not recommended by the product's manufacturer as they may cause hazards.

7. WATER AND MOISTURE

Do not use this product near water- for example, near a bathtub, washbowl, kitchen sink, or laundry tub, in a wet basement, or near a swimming pool.

8. ACCESSORIES

Do not place this product on an unstable cart, stand, tripod, bracket, or table. The product may fall, causing serious injury and serious damage to the product. Use only with a cart, stand, tripod, bracket, or table recommended by the manufacturer or sold with the product. Any mounting of the product should follow the manufacturer's instructions, and should use a mounting accessory recommended by the manufacturer.

8A. An appliance and cart combination

should be moved with care. Quick stops, excessive force, and uneven surfaces may cause the appliance and cart combination to overturn.

PORTABLE CART WARNING
(symbol provided by RETAC)

**9. VENTILATION**

Slots and openings in the cabinet and in the back or bottom are provided for ventilation and to ensure reliable operation of the product and to protect it from overheating. These openings must not be blocked or covered. The openings should never be blocked by placing the product on a bed, sofa, rug, or other similar surface. This product should never be placed near or over a radiator or heat source. This product should not be placed in a built-in installation such as a bookcase or rack unless proper ventilation is provided or the manufacturer's instructions have been adhered to.

IMPORTANT SAFETY INSTRUCTIONS (CONTINUED)

10. POWER SOURCES

This product should be operated only from the type of power source indicated on the marking label. If you are not sure of the type of power supply to your home, consult your appliance dealer or local power company. For products intended to operate from battery power, or other sources, refer to the operating instructions.

11. GROUNDING OR POLARIZATION

This product is equipped with a polarized alternating-current line plug (a plug having one blade wider than the other). This plug will fit into the power outlet only one way. This is a safety feature. If you are unable to insert the plug fully into the outlet, try reversing the plug. If the plug should still fail to fit, contact your electrician to replace your obsolete outlet. Do not defeat the safety purpose of the polarized plug.

12. POWER-CORD PROTECTION

Power-supply cords should be routed so that they are not likely to be walked on or pinched by items placed upon or against them, paying particular attention to cords at plugs, convenience receptacles, and the point where they exit from the appliance.

13. LIGHTNING

To protect your product from a lightning storm, or when it is left unattended and unused for long periods of time, unplug it from the wall outlet and disconnect the antenna or cable system. This will prevent damage to the product due to lightning and power-line surges.

14. POWER LINES

An outside antenna system should not be located in the vicinity of overhead power lines or other electric light or power circuits, or where it can fall into such power lines or circuits. When installing an outside antenna system, extreme care should be taken to keep from touching such power lines or circuits as contact with them might be fatal.

15. OVERLOADING

Do not overload wall outlets and extension cords as this can result in a risk of fire or electric shock.

16. OBJECT AND LIQUID ENTRY

Never push objects of any kind into this product through openings as they may touch dangerous voltage points or short out parts that could result in fire or electric shock. Never spill or spray any type of liquid on the product.

17. SERVICING

Do not attempt to service this product yourself as opening or removing covers may expose you to dangerous voltage or other hazards. Refer all servicing to qualified service personnel.

18. REPLACEMENT PARTS

When replacement parts are required, be sure the service technician uses replacement parts specified by the manufacturer or those that have the same characteristics as the original part. Unauthorized substitutions may result in fire, electric shock or other hazards.

19. SAFETY CHECK

Upon completion of any service or repairs to this product, ask the service technician to perform safety checks to determine that the product is in proper operating condition.

20. WALL OR CEILING MOUNTING

The product should be mounted to a wall or ceiling only as recommended by the manufacturer.

21. DAMAGE REQUIRING SERVICE

Unplug the product from the wall outlet and refer servicing to qualified service personnel under the following conditions:

- a. When the power-supply cord or plug is damaged.
- b. If liquid has been spilled, or objects have fallen into the product.
- c. If the product has been exposed to rain or water.
- d. If the product does not operate normally by following the operating instructions. Adjust only those controls that are covered by the operating instructions, as an adjustment of other controls may result in damage and will often require extensive work by a qualified technician to restore the product to its normal operation.
- e. If the product has been dropped or the cabinet has been damaged.
- f. When the product exhibits a distinct change in performance - this indicates a need for service.

22. HEAT

The product should be situated away from heat sources such as radiators, heat registers, stoves, or other products (including amplifiers) that produce heat.

23. NOTE TO CATV SYSTEM INSTALLER

This reminder is provided to call the CATV system installer's attention to Article 820-40 of the NEC that provides guidelines for proper grounding and, in particular, specifies that the cable ground shall be connected to the grounding system of the building, as close to the point of cable entry as practical.

24. NONUSE PERIODS

The power cord of the appliance should be unplugged from the outlet when left unused for a long period of time.

Dear Customer:

Selecting fine audio equipment such as the unit you've just purchased is only the start of your musical enjoyment. Now it's time to consider how you can maximize the fun and excitement your equipment offers. This manufacturer and the Electronic Industries Association's Consumer Electronics Group want you to get the most out of your equipment by playing it at a safe level. One that lets the sound come through loud and clear without annoying blaring or distortion and, most importantly, without affecting your sensitive hearing. Sound can be deceiving. Over time your hearing "comfort level" adapts to higher volumes of sound. So what sounds "normal" can actually be loud and harmful to your hearing. Guard against this by setting your equipment at a safe level BEFORE your hearing adapts.

To establish a safe level:

- Start your volume control at a low setting.
- Slowly increase the sound until you can hear it comfortably and clearly, and without distortion.

Once you have established a comfortable sound level:

- Set the dial and leave it there.

Taking a minute to do this now will help to prevent hearing damage or loss in the future. After all, we want you listening for a lifetime.

We Want You Listening For A Lifetime

Used wisely, your new sound equipment will provide a lifetime of fun and enjoyment. Since hearing damage from loud noise is often undetectable until it is too late, this manufacturer and the Electronic Industries Association's Consumer Electronics Group recommend you avoid prolonged exposure to excessive noise. This list of sound levels is included for your protection.

Decibel

<u>Level</u>	<u>Example</u>
30	Quiet library, soft whispers
40	Living room, refrigerator, bedroom away from traffic
50	Light traffic, normal conversation, quiet office
60	Air conditioner at 20 feet, sewing machine
70	Vacuum cleaner, hair dryer, noisy restaurant
80	Average city traffic, garbage disposals, alarm clock at two feet

THE FOLLOWING NOISES CAN BE DANGEROUS UNDER CONSTANT EXPOSURE:

90	Subway, motorcycle, truck traffic, lawn mower
100	Garbage truck, chain saw, pneumatic drill
120	Rock band concert in front of speakers, thunderclap
140	Gunshot blast, jet engine
180	Rocket launching pad

Information courtesy of the Deafness Research Foundation.



POWER SOURCE

Unravel the AC cord and connect it to a conveniently located AC outlet having 120V and 60Hz only. The Clock Display will blink.

NOTE: The AC plug supplied with the unit is polarized to help minimize the possibility of electric shock. If the AC plug does not fit into a nonpolarized AC outlet, do not file or cut the wide blade. It is the user's responsibility to have an electrician replace the obsolete outlet.

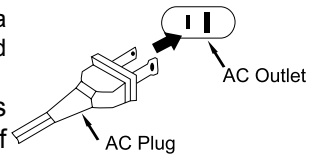

LOCATION OF CONTROLS

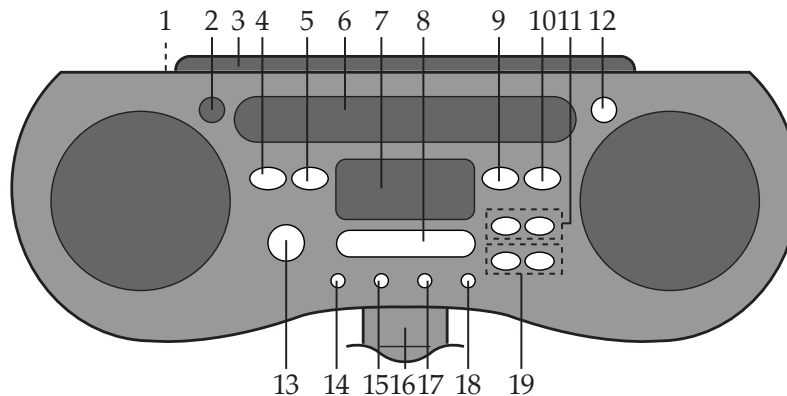

- | | |
|---------------------------------------|-------------------------------|
| 1. AC Cord (Rear of Unit) | 10. STOP (■) Button |
| 2. Remote Sensor | 11. SKIP/TUNING ◀◀/▶▶ Buttons |
| 3. Mounting Screw Holes (Top of Unit) | 12. OPEN/CLOSE Button |
| 4. RADIO/BAND Button | 13. POWER Button |
| 5. CD Button | 14. DISPLAY Button |
| 6. CD Compartment Door | 15. MEMORY/CLOCK SET Button |
| 7. Display | 16. Remote Stand |
| 8. TIMER Button | 17. MEMORY DOWN/RANDOM Button |
| 9. PLAY/PAUSE (▶) Button | 18. MEMORY UP/REPEAT Button |
| | 19. VOLUME +/- Buttons |

LOCATION OF CONTROLS (CONTINUED)

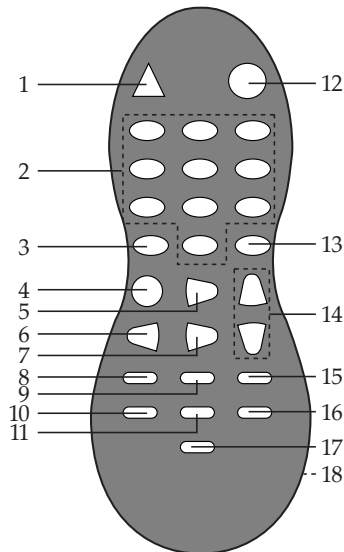

1. OPEN/CLOSE Button
2. Number Buttons
3. OVER Button
4. STOP (■) Button
5. PLAY/PAUSE (▶||) Button
6. SKIP/TUNING ◀◀ Button
7. SKIP/TUNING ▶▶ Button
8. MEM DOWN/ RANDOM Button
9. MEM UP/REPEAT Button
10. TUNER/BAND Button
11. CD Button
12. POWER Button
13. MUTE Button
14. VOLUME +/- Buttons
15. MEM/CLOCK SET Button
16. TIMER Button
17. DISPLAY Button
18. Battery Compartment (Rear)

BATTERY INSTALLATION

BATTERY INSTALLATION

The remote control transmitter is designed to operate with two (2) "AAA" size batteries (not included). To install the batteries, slide the battery compartment cover open on the back of the remote control and insert two (2) "AAA" size batteries observing the polarity (see figure to the right). Replace the battery compartment cover.

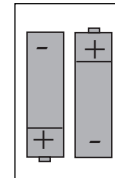

BATTERY PRECAUTIONS

Follow these precautions when using batteries in this device:

1. Use only the size and type of batteries specified.
2. Be sure to follow the correct polarity when installing the batteries as indicated in the battery compartment. Reversed batteries may cause damage to the device.
3. Do not mix different types of batteries together (e.g. Alkaline and Carbon-zinc) or old batteries with fresh ones.
4. If the device is not to be used for a long period of time, remove the batteries to prevent damage or injury from possible battery leakage.
5. Do not try to recharge batteries not intended to be recharged; they can overheat and rupture. (Follow battery manufacturer's directions.)

MOUNTING

This under the cabinet CD clock radio has been designed to be installed underneath a wooden cabinet by using the Mounting Template, four (4) Screws, four (4) Washers and four (4) Spacers (see Figure 1).

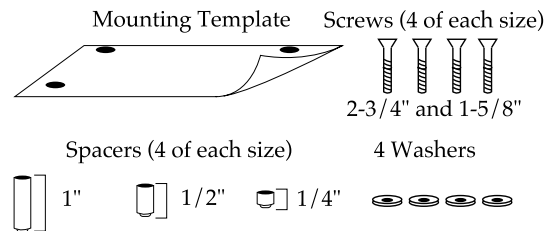

Figure 1

MOUNTING THE UNIT

Locate a desired space for the CD clock radio (it is recommended to mount the unit at the front edge of the cabinet) and follow the instructions below and on the next few pages to mount.

1. Empty the contents of the cabinet where the unit will be mounted. Clean under the cabinet before mounting.

NOTE: For optimal mounting, the screws must go into the unit to a depth of at least 3/8". If the overall length from the bottom of the cabinet shelf to the bottom of the overhang is more than 1-3/4", a wood shim must be used. A shim can be made from a small sheet of plywood, using the template to locate the central lines for drilling 1/4" mounting holes. The shim can be located between the cabinet shelf bottom and spacers. Make sure the shim is at least as thick as the excess over 1-3/4". If a shim is necessary, longer screws are required. Longer screws (type #10-32) are available at most hardware stores.

2. Cut out the template on the line indicated on the template. The template size and screw hole positions are identical to the top of the unit.

3a. IF YOUR CABINET DOES NOT HAVE AN OVERHANG:

Position the template in the desired location underneath the cabinet, flush with the front edge. Then, tape the template in place (see Figure 2), and continue to step 4.

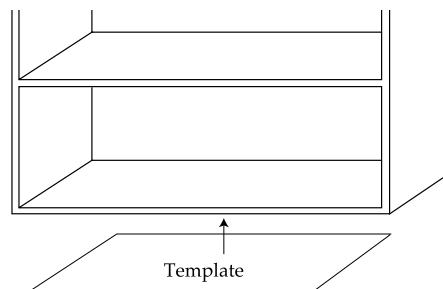

Figure 2

MOUNTING (CONTINUED)

3b. IF YOUR CABINET HAS AN OVERHANG:

Measure the thickness of the overhang (see Figure 3). Fold the front of the template down along the printed guideline that is closest to the thickness of your cabinet. Tape the folded portion to the backside of the overhang, then tape the template underneath the cabinet (see Figure 4).

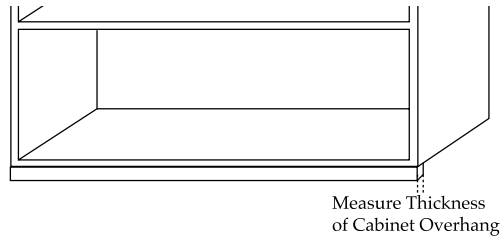

Figure 3

NOTE: If the cabinet has glue blocks or other obstructions, cut out corresponding areas on the template to clear them. Do not cut through the screw holes indicated on the template.

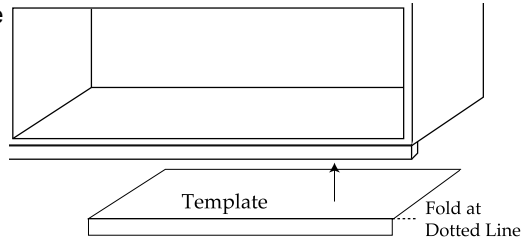

Figure 4

4. Drill 1/4" diameter holes underneath the cabinet using the four points marked on the template.

TIPS:

- On a wooden cabinet, you may want to mark and start the drill holes with a nail or an awl.
 - Make sure to hold the drill very firmly against the cabinet to reduce "walking" of the drill bit from the markers.
 - Use masking tape above the hole locations on the inside of the cabinet to reduce splintering.
 - If installing the unit under a wood cabinet, you may wish to countersink the drilled holes from the inside. This will eliminate the use of washers and allow the screwheads to be flush with the floor of the cabinet. If you cannot countersink the holes, use the supplied washers.
 - Always wear goggles.
 - DO NOT mount above a sink or stove.
5. Remove the template and clean the drill shavings from inside and underneath the cabinet.
 6. **If your cabinet does not have an overhang, skip this step.**
If your cabinet has an overhang, select the spacer or combination of spacers that is equal to or longer than the cabinet overhang (see Figure 5 on the next page).

MOUNTING (CONTINUED)

7. Insert screws from the **INSIDE** of the cabinet. The washers must be used on metal cabinets and wood cabinets if the drilled holes were not countersunk. Position the washers, flat-side down, and insert the screws into the holes.

8. **If your cabinet does not have an overhang, skip this step.**

If your cabinet has an overhang, hold the screwheads down while you push the selected spacers upward onto the screws under the cabinet. Make sure to push up spacers until they are firmly against the cabinet bottom and/or fully nested (if more than one are used).

9. Align the unit under the screws. Hold the unit so its mounting screw holes (on the top of the unit) are against the mounting screws (see Figure 6), then partially tighten the screws.

NOTE: Do not fully tighten until all 4 screws have been started. The top edge of the unit should clear the overhang.

10. Extend the cord towards the AC outlet (see page 5) and secure it by using cord hooks (not supplied) to keep the cord out of the way. For more attractive appearance, place the cord hooks at the back edge of the cabinet, directly over the AC outlet. It is recommended that the line cord be fully extended for best FM reception.

11. Connect the Remote Stand to the bottom of the unit by sliding it towards the rear of the unit.

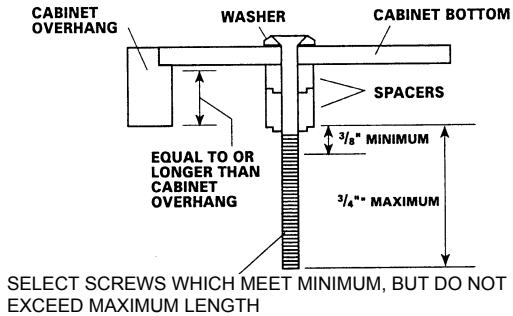

Figure 5

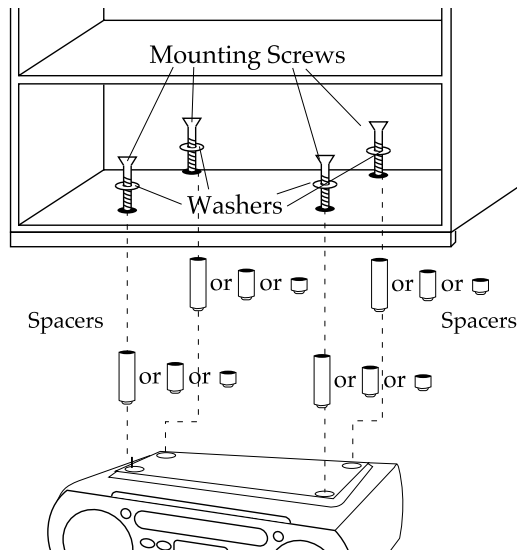
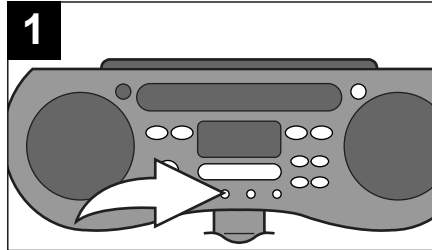

Figure 6

OPERATION

TO SET OR RESET THE ACTUAL TIME



When the unit is off, press the MEMORY/CLOCK SET button.

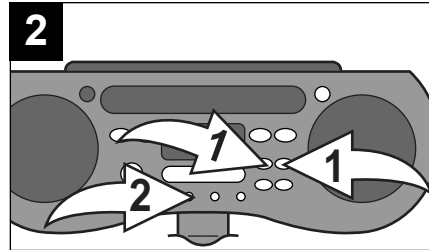

Press the SKIP/TUNING ►►/◄◄ buttons ① to set the hour, then press the MEMORY/CLOCK SET button ②. Press the SKIP/TUNING ►►/◄◄ buttons ① to set the minutes, then press the MEMORY/CLOCK SET button ② again.

TO SET THE COUNTDOWN TIMER

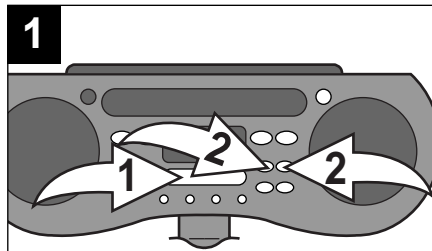

Press and hold the TIMER button ①; the display will show "00:00" and the hour digits will blink. Use the SKIP/TUNING ►►/◄◄ buttons ② to select the amount of hours in the countdown.

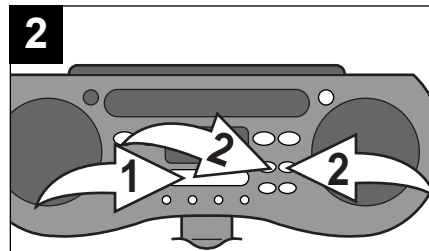

Press the TIMER button ① again and the minute digits will blink. Use the SKIP/TUNING ►►/◄◄ buttons ② to select the amount of minutes in the countdown. Press the TIMER button ① to return to the actual time.

IMPORTANT NOTE ON THE COUNTDOWN TIMER:

The above procedure will set the amount of time that the timer will countdown EVERY TIME THE TIMER IS PRESSED. To activate the countdown timer, or to change the countdown timer, see the following page.

OPERATION (CONTINUED)

TO START THE COUNTDOWN TIMER

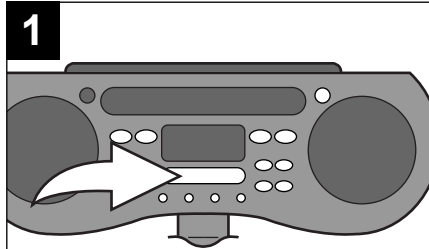

Once the countdown time has been entered (see previous page), press the **TIMER** button and the display will start counting down the preset countdown time.

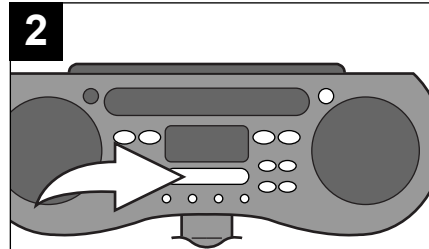

When the countdown timer reaches "00:00:00", the unit will beep. Press the **TIMER** button again to turn off the beeps.

NOTES:

- During the countdown, if you press the **TIMER** button again, the countdown timer will revert back to the original timer.
- If no countdown time has been set as shown on the previous page, and the **TIMER** button is pressed and released, the unit will turn on and beep.
- After the countdown timer has gone off, each subsequent press of the **TIMER** button will set the countdown timer for the time as previously set. To change the countdown timer time to a different time, simply repeat the instructions on the previous page ("TO SET THE COUNTDOWN TIMER").
- When the countdown timer is counting down, press the **DISPLAY** button to cycle from the clock to the timer.

OPERATION (CONTINUED)

TO LISTEN TO THE RADIO

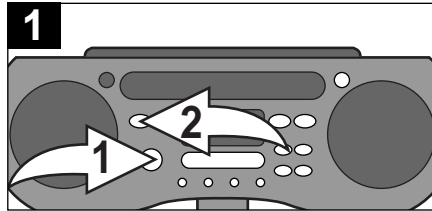

1
Press the POWER button ❶ to turn the unit on. Press the RADIO/BAND button once ❷ to select radio. Repeatedly press to select the desired band (AM, FM).

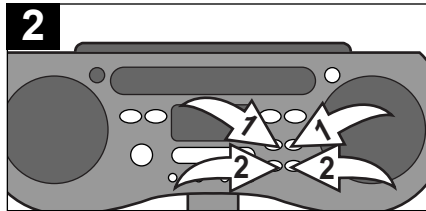

2
Tune a station by pressing the SKIP/TUNING |◀◀ or ▶▶| button ❶. To scan for strong station(s), press and hold the the SKIP/TUNING |◀◀ or ▶▶| button ❶; the unit will then scan and stop on the next strong station. Adjust the volume using the VOLUME +/- buttons ❷.

Antennas

FM: Extend the AC cord for better FM reception.
AM: Turn the unit for better AM reception.

SETTING RADIO PRESETS (UP TO 20 PRESETS)

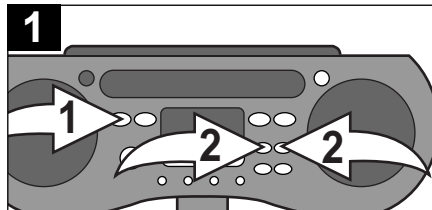

1
Turn the unit on and press the RADIO/BAND button ❶ to select radio and band. Press the SKIP/TUNING |◀◀ or ▶▶| button ❷ to find the desired station.

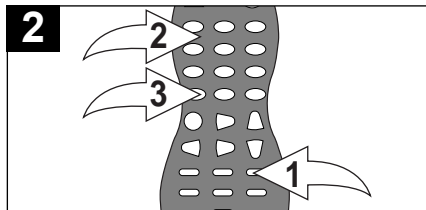

2
Press the MEM/CLOCK SET button ❶ to confirm. Then select the Memory Preset (up to 20) using the Number buttons ❷. Simply press the Number buttons ❷ to directly enter the Memory Preset. For Memory Presets over 9, press the OVER button ❸, followed by the Number buttons ❷ (i.e. to select 12, press the OVER button, followed by "1" then "2").

OPERATION (CONTINUED)

TO RECALL MEMORY PRESETS

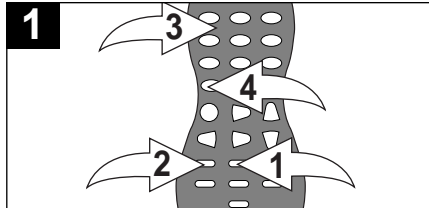

To recall the Memory Presets, simply press the MEMORY UP/REPEAT button ❶ or MEMORY DOWN/RANDOM button ❷, or directly select them using the Number buttons ❸. For Memory Presets over 9, press the OVER button ❹, followed by the Number buttons ❺ (i.e. to select 12, press the OVER button, followed by "1" then "2").

MUTE

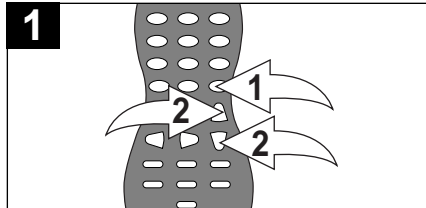

To temporarily mute the sound, press the MUTE button ❶ on the remote, the sound will be muted. Press the MUTE button ❶ again or one of the VOLUME +/- buttons ❷ to restore the sound.

DISPLAY

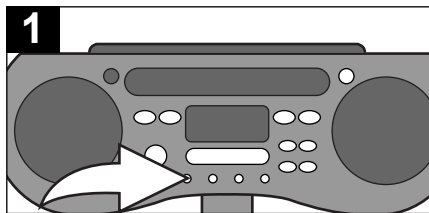

Pressing the DISPLAY button will cycle the display as follows:
 1st press: Clock
 2nd press: Timer
 3rd press: CD or Radio display

TO INSERT A CD

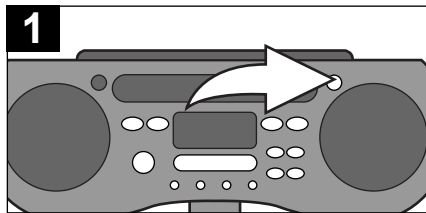

Open the CD compartment door by pressing the OPEN/CLOSE button. Insert a disc, label side up, onto the spindle and close the CD compartment door.

OPERATION (CONTINUED)

TO PLAY A CD

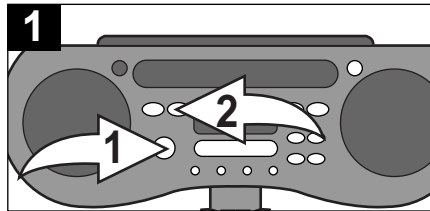

1 Insert a CD as described on the previous page. Press the POWER button **1** to turn the unit on and press the CD button **2**. The total playing time and number of tracks will appear in the display.

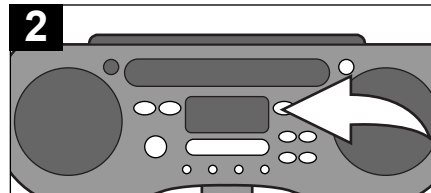

2 Press the PLAY/PAUSE (▶||) button to start playback; the Play indicator will appear. **TO PAUSE PLAYBACK**, press the PLAY/PAUSE (▶||) button again; the display will blink and the Pause indicator will appear. Press again to resume playback.

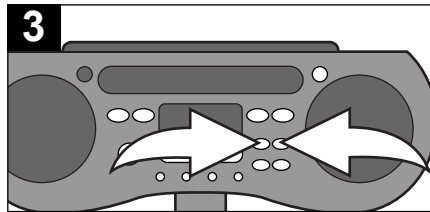

3 To **skip** forward or backward through the tracks on the disc, press the CD SKIP/TUNING ◀◀ or ▶▶ button. To **search** forward or backward through the tracks on the disc, press and hold the SKIP/TUNING ◀◀ or ▶▶ button.

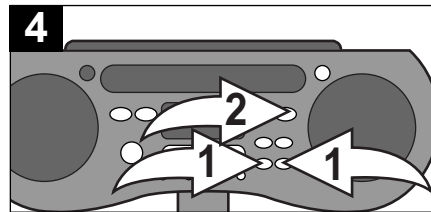

4 Adjust the volume using the VOLUME +/- buttons **1** as desired. When the disc is through playing, it will stop. Press the STOP (■) button **2** to stop the disc before it is finished.

FAQS: *Do I need an adapter to play 3" singles?*
No, simply insert the 3" single into the groove.
What is the maximum time for a CD in this unit?
The maximum time is 74 minutes.

NOTES:

- If a disc is inserted incorrectly, dirty, damaged or not present at all, the display will show "no DISC"
- To remove the CD, press the OPEN/CLOSE button and remove the CD.
- Most buttons are both on the main unit and the remote control.

OPERATION (CONTINUED)

DIRECT TRACK ACCESS

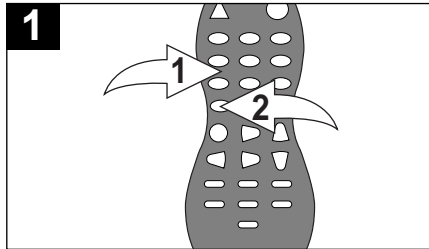

When a CD is playing, simply press the Number buttons **1** to directly select a track. For tracks over 9, press the OVER button **2**, followed by the Number buttons **1** (i.e. to select track 12, press the OVER button, followed by "1" then "2").

TO REPEATEDLY PLAY BACK ONE TRACK

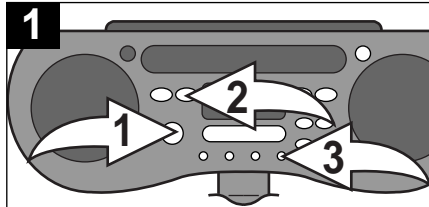

Press the POWER button **1** to turn the unit on and press the CD button **2**. Press the MEMORY UP/REPEAT button **3** twice; Repeat ONE will appear in the display.

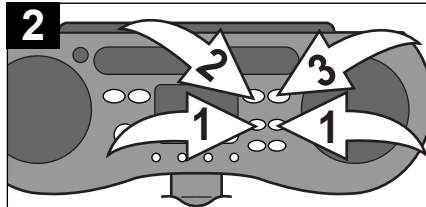

Press the SKIP/TUNING **2** or **3** button **1** to select a track. Press the PLAY/PAUSE **2** button **1** to start playback and the unit will play the same track over and over until the STOP **3** button **1** is pressed.

TO REPEATEDLY PLAY BACK ALL TRACKS ON A CD

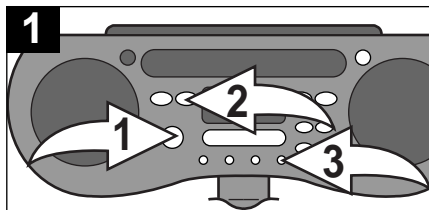

Press the POWER button **1** to turn the unit on and press the CD button **2**. Press the MEMORY UP/REPEAT button **3** once; Repeat ALL will appear in the display.

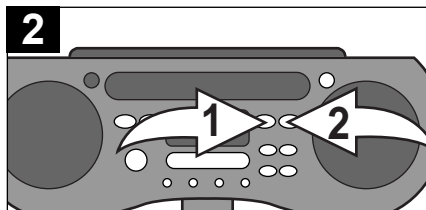

Press the PLAY/PAUSE **1** button **1** to start playback and the unit will then play all the tracks on the CD over and over until the STOP **2** button **2** is pressed.

OPERATION (CONTINUED)

TO RANDOMLY PLAY BACK TRACKS ON A CD

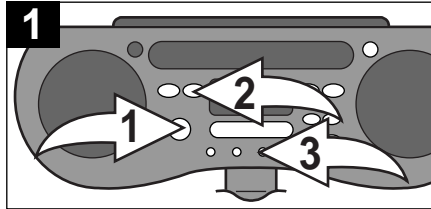

Press the POWER button ❶ to turn the unit on and press the CD button ❷. Press the MEMORY DOWN/RANDOM button ❸; "RANDOM" will appear in the display.

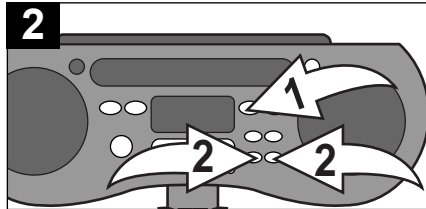

Press the PLAY/PAUSE (▶||) button ❶ to begin playback. The unit will play all the tracks in random order. Adjust the volume using the VOLUME +/- buttons ❷ as desired. When all the tracks have been played, the unit will stop.

TO PROGRAM THE MEMORY (UP TO 30 TRACKS)

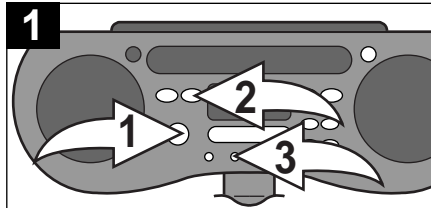

Press the POWER button ❶ to turn the unit on and press the CD button ❷. Press the MEMORY/CLOCK SET button ❸; "P-01" will appear indicating the program number, "00" will appear indicating the track number and "MEMORY" will blink in the display.

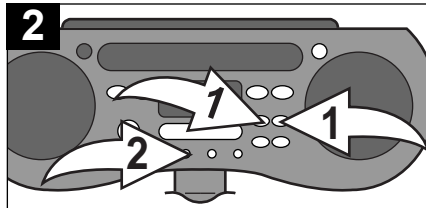

Select the first track to be played back using the SKIP/TUNING |◀◀ or ▶▶ button ❶, then press the MEMORY/CLOCK SET button ❷ again. Repeat this step to program additional tracks up to a maximum of 30 tracks.

Programming continued on the next page.

OPERATION (CONTINUED)

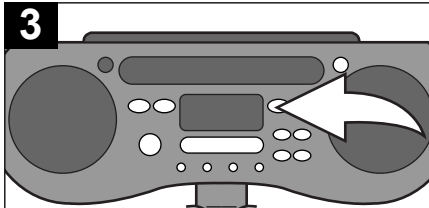

Press the PLAY/PAUSE (▶||) button to begin playback. The unit will play all the tracks in the order you programmed them.

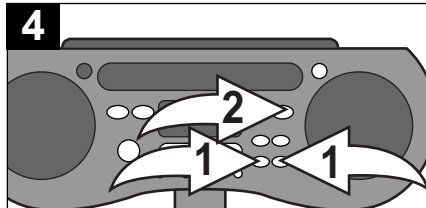

Adjust the volume using the VOLUME +/- buttons ❶ as desired. When the disc is through playing, it will stop. Press the STOP (■) button ❷ to stop the disc before it is finished.

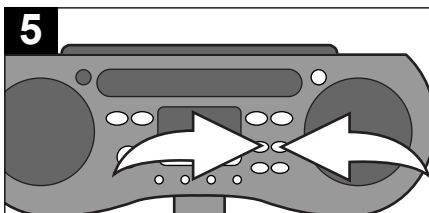

To skip forward or backward through the programs, press the SKIP/TUNING ◀◀ or ▶▶ button. When the disc is through playing, it will stop.

NOTES:

- Press the STOP (■) button to stop the disc before it is finished.
- Programming is the ability to preselect the order in which a series of tracks will be played.
- If you attempt to program more than 30 tracks, "FULL" will appear in the display.

FAQ:

Can I program a track more than once?

Each track may be stored in the program memory as many times as desired (up to 30 tracks).

CARE AND MAINTENANCE

Caring for Compact Discs

- Treat the disc carefully. Handle the compact disc only by its edges. Never allow your fingers to come in contact with the shiny, unprinted side of the disc.
- Do not attach adhesive tape, stickers, etc. to the compact disc label.
- Clean the compact disc periodically with a soft, lint-free, dry cloth. Never use detergents or abrasive cleaners to clean the disc. If necessary, use a CD cleaning kit.
- If a compact disc skips or gets stuck on a section of the compact disc, it is probably dirty or damaged (scratched).
- When cleaning the compact disc, wipe in straight lines from the center of the compact disc to the outer edge of the compact disc. Never wipe in circular motions.

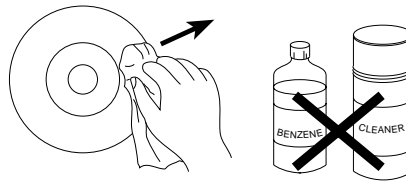
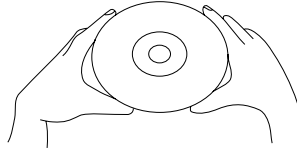

- This unit is designed to play only compact discs bearing the identification logo as shown here. Other discs may not conform to the CD standard and may not play properly.
- Compact Discs should be stored in their cases after each use to avoid damage.
- Do not expose compact discs to direct sunlight, high humidity, high temperatures, or dust, etc. Prolonged exposure or extreme temperatures can warp the disc.
- Do not stick or write anything on either side of the disc. Sharp writing instruments, or the ink may damage the surface.



Cleaning the unit

- To prevent fire or shock hazard, disconnect your unit from the AC power source when cleaning.
- The finish on your unit may be cleaned with a dust cloth and cared for as other furniture. Use caution when cleaning and wiping the plastic parts.
- Mild soap and a damp cloth may be used on the front panel.

TROUBLESHOOTING GUIDE

If you experience a problem with this unit, check the chart below before calling for service.

SYMPTOM	CAUSE	SOLUTION
Unit will not turn on.	AC cord not connected.	Check AC cord connection.
Disc will not play.	CD compartment not closed.	Close CD compartment door.
	Disc inserted incorrectly.	Reinsert disc correctly.
	Dirty or defective disc.	Try another disc.
	Moisture condensation on disc.	Wipe disc with soft cloth.
No sound.	Volume is set to minimum.	Increase volume.
	Defective disc.	Try another disc.
Erratic playback.	Dirty or defective disc.	Clean or replace disc.
Time display blinks.	Clock not set.	Set the clock.
AM or FM, no sound.	Power is not on.	Press the POWER button to turn the unit on.
	Volume is set to minimum.	Increase volume.

FOR ADDITIONAL SET-UP OR OPERATING ASSISTANCE, PLEASE VISIT OUR WEBSITE AT WWW.MEMCORPINC.COM OR CONTACT CUSTOMER SERVICE AT 1-800-919-3647.

PLEASE KEEP ALL PACKAGING MATERIAL FOR AT LEAST 90 DAYS IN CASE YOU NEED TO RETURN THIS PRODUCT TO YOUR PLACE OF PURCHASE OR MEMOREX.

FOR PARTS AND ACCESSORIES, CONTACT FOX INT'L AT 1-800-321-6993.

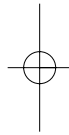
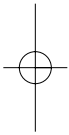

Memcorp, Inc.
Weston, FI
Printed in Hong Kong

Visit our website at www.memcorpinc.com

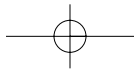

Free Manuals Download Website

<http://myh66.com>

<http://usermanuals.us>

<http://www.somanuals.com>

<http://www.4manuals.cc>

<http://www.manual-lib.com>

<http://www.404manual.com>

<http://www.luxmanual.com>

<http://aubethermostatmanual.com>

Golf course search by state

<http://golfingnear.com>

Email search by domain

<http://emailbydomain.com>

Auto manuals search

<http://auto.somanuals.com>

TV manuals search

<http://tv.somanuals.com>