

# **Memorex**<sup>®</sup>

Is it live or is it Memorex?<sup>™</sup>

## MT3010

### **User's Guide**

---

30" Wide-screen LCD Stereo HDTV\*  
Monitor with Integrated TV Tuner

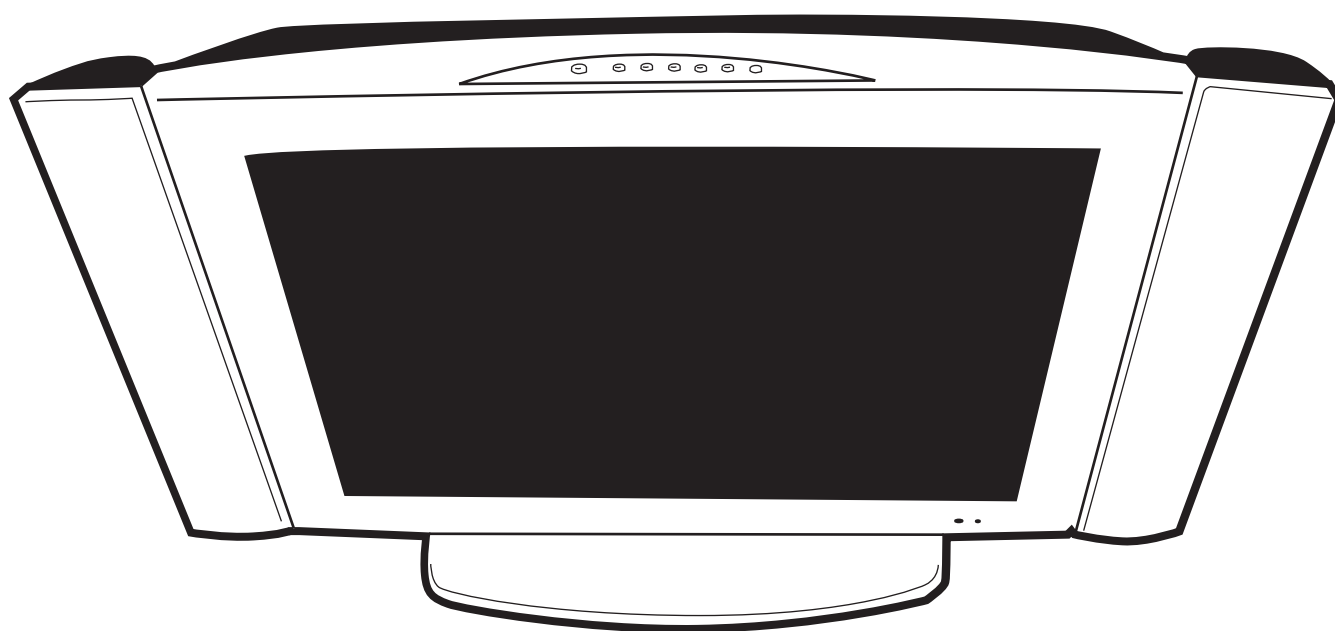

\* High Definition (HDTV) monitors require an optional set-top box to receive true digital high definition broadcasts.

**Before operating this product,  
please read these instructions completely.**

# CONTENTS

<b>Contents</b> .....	1
<b>Important Safety Instructions</b> .....	2
<b>Power Source</b> .....	4
<b>Location of Controls</b> .....	4
• Front .....	4
• Rear Panel .....	5
<b>Remote Control</b> .....	6
• Battery Installation .....	7
• Effective Distance of the Remote Control Transmitter .....	7
<b>Cable (CATV)/Satellite Connections</b> .....	8
<b>Outdoor Antenna Connections</b> .....	9
<b>VCR Connections</b> .....	10
<b>DVD Connections</b> .....	12
<b>Stereo Connection</b> .....	13
<b>HDTV Connection</b> .....	14
<b>Computer Connection</b> .....	14
<b>Wall Mounting the Unit</b> .....	15
<b>Clock Setting</b> .....	17
<b>Setting the AIR/CABLE Option</b> .....	18
<b>Setting Channels into Memory</b> .....	19
<b>Adding and Skipping Channels</b> .....	20
<b>Setting Favorite Channels</b> .....	21
<b>Setting the Sleep Timer</b> .....	22
<b>TV Operation</b> .....	23
• Mute .....	24
• Recall .....	24
• TV/AV/PC .....	24
• MTS .....	24
• Favorite Channel .....	24
• Sleep .....	24
• Display .....	25
• Video Mode .....	25
• Audio Mode .....	25
• Video Mute .....	25
• Channel Lock .....	25
• SRS .....	25
• Wide .....	26
• Audio AI .....	26
• PIP and POP .....	26
• Swap .....	26
• Screen Position .....	26
• Image Source .....	26
<b>Closed Captions</b> .....	27
<b>On-Screen Control Adjustments (Picture)</b> .....	28
<b>On-Screen Control Adjustments (Sound)</b> .....	29
<b>Screen Settings</b> .....	30
<b>Setting V-Chip</b> .....	32
• V-Chip Set-up .....	32
• MPA Rating Set-up .....	33
• TV Rating Set-up .....	34
• Changing the Password .....	35
<b>Setting the On Timer</b> .....	36
<b>Troubleshooting Guide</b> .....	37
<b>Reception Disturbances</b> .....	38
<b>Specifications</b> .....	39
<b>Care and Maintenance</b> .....	40

# IMPORTANT SAFETY INSTRUCTIONS

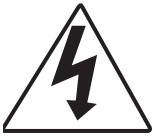

## CAUTION

**RISK OF ELECTRIC SHOCK  
DO NOT OPEN**



The lightning flash with arrowhead symbol within an equilateral triangle is intended to alert the user to the presence of uninsulated dangerous voltage within the product's enclosure that may be of sufficient magnitude to constitute a risk of electric shock to persons.



The exclamation point within an equilateral triangle is intended to alert the user to the presence of important operating and maintenance (servicing) instructions in the literature accompanying the appliance.

**CAUTION:** TO REDUCE THE RISK OF ELECTRIC SHOCK, DO NOT REMOVE COVER (OR BACK). NO USER-SERVICEABLE PARTS INSIDE. REFER SERVICING TO QUALIFIED SERVICE PERSONNEL.

**WARNING:** TO REDUCE THE RISK OF FIRE OR ELECTRIC SHOCK, DO NOT EXPOSE THIS APPLIANCE TO RAIN OR MOISTURE. TO PREVENT ELECTRIC SHOCK, MATCH THE WIDE BLADE OF THE PLUG TO THE WIDE SLOT AND FULLY INSERT.

**Before using the unit, be sure to read all operating instructions carefully. Please note that these are general precautions and may not pertain to your unit. For example, this unit may not have the capability to be connected to an outdoor antenna.**

### 1. READ INSTRUCTIONS

All the safety and operating instructions should be read before the product is operated.

### 2. RETAIN INSTRUCTIONS

The safety and operating instructions should be retained for future reference.

### 3. HEED WARNINGS

All warnings on the product and in the operating instructions should be adhered to.

### 4. FOLLOW INSTRUCTIONS

All operating and use instructions should be followed.

### 5. CLEANING

Unplug this product from the wall outlet before cleaning. Do not use liquid cleaners or aerosol cleaners. Use a damp cloth for cleaning.

### 6. ATTACHMENTS

Do not use attachments not recommended by the product's manufacturer as they may cause hazards.

### 7. WATER AND MOISTURE

Do not use this product near water- for example, near a bathtub, washbowl, kitchen sink, or laundry tub, in a wet basement, or near a swimming pool.

### 8. ACCESSORIES

Do not place this product on an unstable cart, stand, tripod, bracket, or table. The product may fall, causing serious injury and serious damage to the product. Use only with a cart, stand, tripod, bracket, or table recommended by the manufacturer or sold with the product. Any mounting of the product should follow the manufacturer's instructions, and should use a mounting accessory recommended by the manufacturer.

**8A.** An appliance and cart combination should be moved with care. Quick stops, excessive force, and uneven surfaces may cause the appliance and cart combination to overturn.

### 9. VENTILATION

Slots and openings in the cabinet and in the back or bottom are provided for ventilation and to ensure reliable operation of the product and to protect it from overheating. These openings must not be blocked or covered. The openings should never be blocked by placing the product on a bed, sofa, rug, or other similar surface. This product should never be placed near or over a radiator or heat source. This product should not be placed in a built-in installation such as a bookcase or rack unless proper ventilation is provided or the manufacturer's instructions have been adhered to.

### 10. POWER SOURCES

This product should be operated only from the type of power source indicated on the marking label. If you are not sure of the type of power supply to your home, consult your appliance dealer or local power company. For products intended to operate from battery power, or other sources, refer to the operating instructions.

### 11. GROUNDING OR POLARIZATION

This product is equipped with a polarized alternating-current line plug (a plug having one blade wider than the other). This plug will fit into the power outlet only one way. This is a safety feature. If you are unable to insert the plug fully into the outlet, try reversing the plug. If the plug should still fail to fit, contact your electrician to replace your obsolete outlet. Do not defeat the safety purpose of the polarized plug.

### 12. POWER-CORD PROTECTION

Power-supply cords should be routed so that they are not likely to be walked on or pinched by items placed upon or against them, paying particular attention to cords at plugs, convenience receptacles, and the point where they exit from the appliance.

PORTABLE CART WARNING  
(symbol provided by RETAC)



S3126A

## IMPORTANT SAFETY INSTRUCTIONS (CONTINUED)

### 13. LIGHTNING

To protect your product from a lightning storm, or when it is left unattended and unused for long periods of time, unplug it from the wall outlet and disconnect the antenna or cable system. This will prevent damage to the product due to lightning and power-line surges.

### 14. POWER LINES

An outside antenna system should not be located in the vicinity of overhead power lines or other electric light or power circuits, or where it can fall into such power lines or circuits. When installing an outside antenna system, extreme care should be taken to keep from touching such power lines or circuits as contact with them might be fatal.

### 15. OVERLOADING

Do not overload wall outlets and extension cords as this can result in a risk of fire or electric shock.

### 16. OBJECT AND LIQUID ENTRY

Never push objects of any kind into this product through openings as they may touch dangerous voltage points or short out parts that could result in fire or electric shock. Never spill or spray any type of liquid on the product.

### 17. OUTDOOR ANTENNA GROUNDING

If an outside antenna is connected to the product, be sure the antenna system is grounded so as to provide some protection against voltage surges and built-up static charges. Section 810 of the National Electric Code, ANSI/NFPA 70, provides information with respect to proper grounding of the mast and supporting structure, grounding of the lead-in wire to an antenna discharge product, size of grounding conductors, location of antenna discharge product, connection to grounding electrodes, and requirements for grounding electrode.

### 18. SERVICING

Do not attempt to service this product yourself as opening or removing covers may expose you to dangerous voltage or other hazards. Refer all servicing to qualified service personnel.

### 19. REPLACEMENT PARTS

When replacement parts are required, be sure the service technician uses replacement parts specified by the manufacturer or those that have the same characteristics as the original part. Unauthorized substitutions may result in fire, electric shock or other hazards.

### 20. SAFETY CHECK

Upon completion of any service or repairs to this product, ask the service technician to perform safety checks to determine that the product is in proper operating condition.

### 21. WALL OR CEILING MOUNTING

The product should be mounted to a wall or ceiling only as recommended by the manufacturer.

### 22. DAMAGE REQUIRING SERVICE

Unplug the product from the wall outlet and refer servicing to qualified service personnel under the following conditions:

- When the power-supply cord or plug is damaged.
- If liquid has been spilled, or objects have fallen into the product.
- If the product has been exposed to rain or water.
- If the product does not operate normally by following the operating instructions. Adjust only those controls that are covered by the operating instructions, as an adjustment of other controls may result in damage and will often require extensive work by a qualified technician to restore the product to its normal operation.
- If the product has been dropped or the cabinet has been damaged.
- When the product exhibits a distinct change in performance - this indicates a need for service.

### 23. HEAT

The product should be situated away from heat sources such as radiators, heat registers, stoves, or other products (including amplifiers) that produce heat.

### 24. NOTE TO CATV SYSTEM INSTALLER

This reminder is provided to call the CATV system installer's attention to Article 820-40 of the NEC that provides guidelines for proper grounding and, in particular, specifies that the cable ground shall be connected to the grounding system of the building, as close to the point of cable entry as practical.

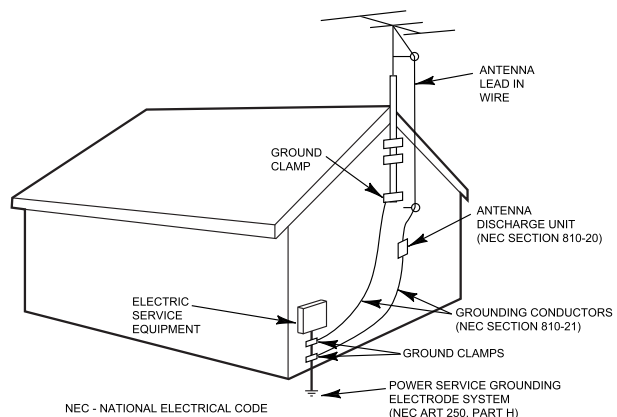

S2898A

EXAMPLE OF ANTENNA GROUNDING AS PER NATIONAL ELECTRICAL CODE

## POWER SOURCE

To operate the unit using AC power, connect the AC Adapter to the AC jack on the rear of the unit, then connect the AC adapter to a wall outlet having 120V AC, 60Hz only.

**NOTE:** If the AC adapter's plug does not fit into a nonpolarized outlet, do not file or cut the wide blade.

**CAUTION:** Use only the AC adapter provided with this unit. Using another AC adapter may damage the unit. When not using AC power, disconnect the AC adapter from the wall outlet by pulling the plug (not the cord). Do not touch the AC adapter with wet hands.

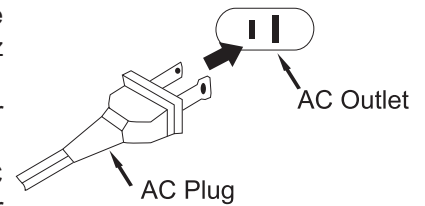

## LOCATION OF CONTROLS

### FRONT

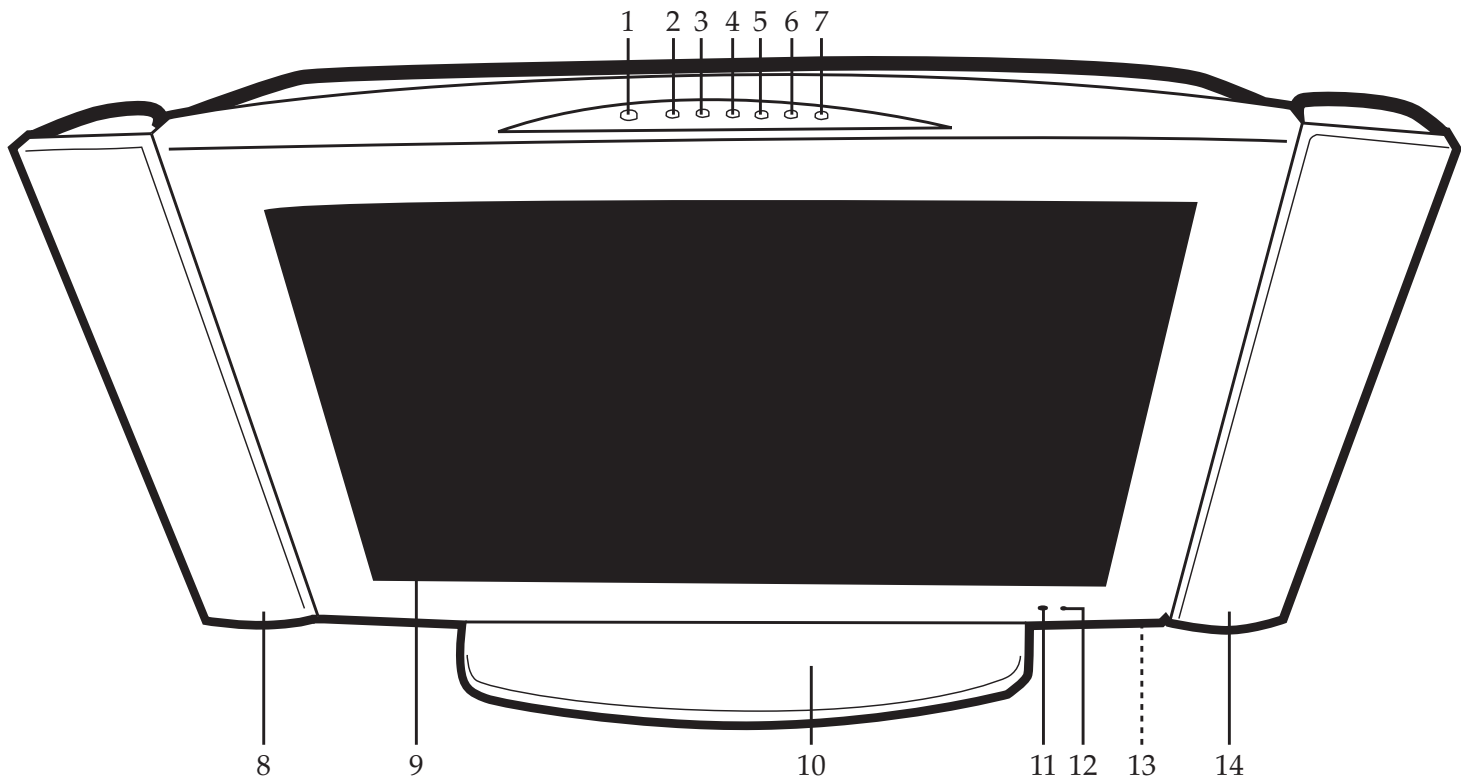

- 1. POWER Button** - Press to turn the TV on; the POWER indicator will light green and picture will appear in approximately five seconds. Press again to turn the TV off; the Power indicator will light red.
- 2. CHANNEL Down Button** - Press to select a lower numbered channel.
- 3. CHANNEL Up Button** - Press to select a higher numbered channel.
- 4. VOLUME Down Button** - Press to lower the volume.
- 5. VOLUME Up Button** - Press to raise the volume.
- 6. MENU Button** - Press to access the On-Screen menu.
- 7. TV/VIDEO/PC Button** - Press to switch between the TV and the video inputs.
- 8. Left Speaker**
- 9. Screen**
- 10. Base Stand**
- 11. REMOTE SENSOR**
- 12. POWER Indicator** - Lights green when the unit is warming up or is on, and lights red when the unit is off.
- 13. AC Jack (Rear of Unit)**
- 14. Right Speaker**

## LOCATION OF CONTROLS (CONTINUED)

### REAR PANEL

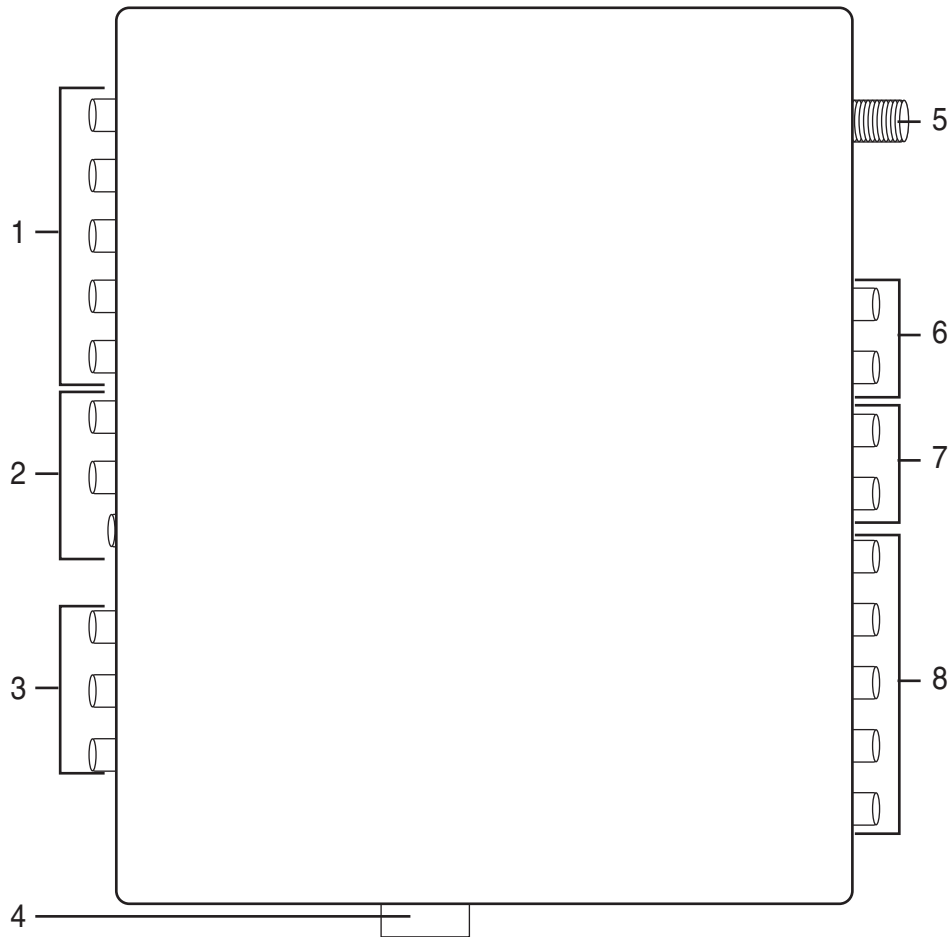

1. **HDTV IN Jacks (R/L/Pr/Pb/Y)**
2. **S IN Jacks (R/L/S)**
3. **AV IN Jacks (R/L/V)**
4. **VGA IN Jack**
5. **UHF/VHF Antenna Jack**
6. **AUDIO OUT Jacks (R/L)**
7. **VGA AUDIO IN Jacks (R/L)**
8. **COMPONENT IN Jacks (R/L/Cr/Cb/Y)**

# REMOTE CONTROL

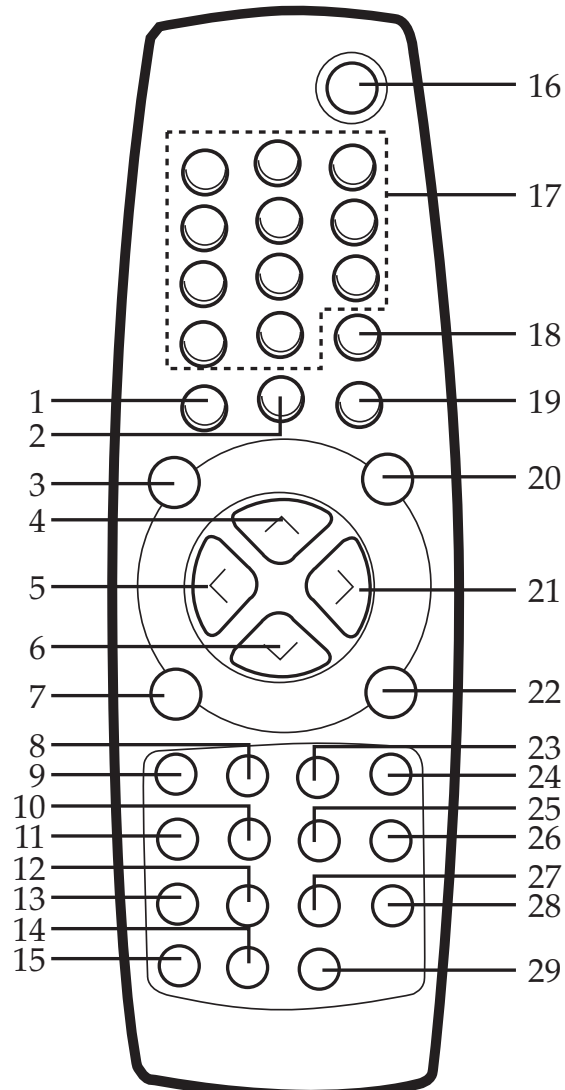

- |                                 |   |
|---------------------------------|---|
| 1. RECALL Button                | 16. POWER Button                        |
| 2. CH LOCK Button               | 17. Direct Channel Selection Buttons    |
| 3. TV/AV/PC Button              | 18. FAVORITE CHANNEL Up Button          |
| 4. CHANNEL Up Button            | 19. FAVORITE CHANNEL Down Button        |
| 5. VOLUME Down Button           | 20. MENU Button                         |
| 6. CHANNEL Down Button          | 21. VOLUME Up Button                    |
| 7. MTS Button                   | 22. MUTE Button                         |
| 8. VIDEO MODE Button            | 23. DISPLAY Button                      |
| 9. WIDE Button                  | 24. VIDEO MUTE Button                   |
| 10. AUDIO MODE Button           | 25. SLEEP TIMER Button                  |
| 11. SRS (Surround Sound) Button | 26. AUDIO AI Button                     |
| 12. IMAGE SOURCE Button         | 27. SWAP Button                         |
| 13. PIP/POP Button              | 28. SCREEN POSITION Button              |
| 14. SET Button                  | 29. CCD (Closed Caption Display) Button |
| 15. V-CHIP Button               |   |

## REMOTE CONTROL (CONTINUED)

### BATTERY INSTALLATION

1

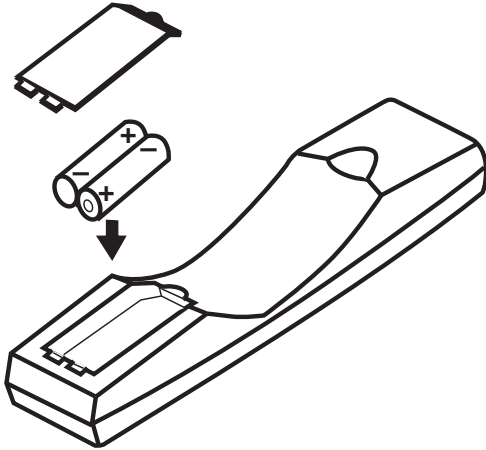

Open the battery compartment cover.

Install two "AAA" batteries, paying attention to the polarity diagram in the battery compartment.

Replace the battery compartment cover.

### BATTERY PRECAUTIONS

Follow these precautions when using batteries in this device:

1. Use only the size and type of batteries specified.
2. Be sure to follow the correct polarity when installing the batteries as indicated in the battery compartment. Reversed batteries may cause damage to the device.
3. Do not mix different types of batteries together (e.g. Alkaline, Rechargeable and Carbon-zinc) or old batteries with fresh ones.
4. If the device is not to be used for a long period of time, remove the batteries to prevent damage or injury from possible battery leakage.
5. Do not try to recharge batteries not intended to be recharged; they can overheat and rupture. (Follow battery manufacturer's directions.)

### EFFECTIVE DISTANCE OF THE REMOTE CONTROL TRANSMITTER

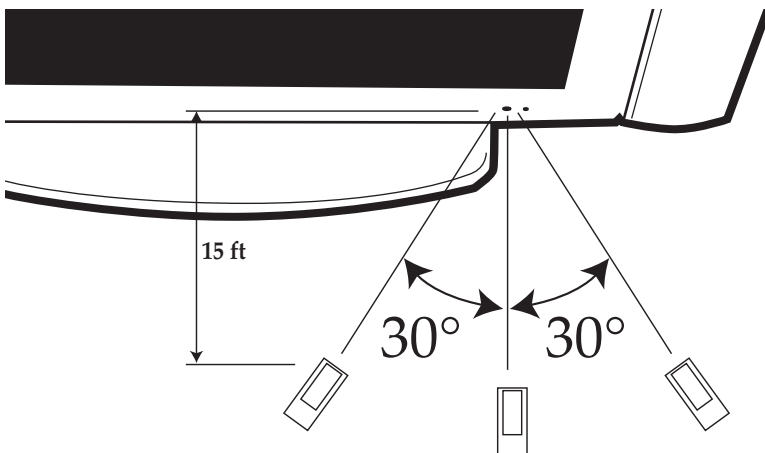

#### NOTES:

- When there is an obstacle between the TV and the transmitter, the transmitter may not operate.
- When direct sunlight, incandescent lamp, fluorescent lamp or any other strong light shines on the REMOTE SENSOR of the TV, the remote operation may be unstable.

#### FAQs:

*Why is the remote control not working properly?*

- The remote control is not aimed at the sensor.
- The remote control is too far away from the remote sensor.
- There is too much light in the room.
- There is an obstacle in the path of the beam.
- The batteries are weak or dead.
- The batteries are inserted incorrectly.
- The TV is not plugged in.
- The proper Function button is not pressed. For example, press the TV button to use the remote to operate the TV.



## CABLE (CATV)/SATELLITE CONNECTIONS

This TV has an extended tuning range and can tune most cable channels without using a Cable TV converter box. Some Cable TV companies offer "premium pay channels" in which the signal is scrambled. Descrambling these signals for normal viewing requires the use of a descrambler device which is generally provided by the cable company.

### FOR SUBSCRIBERS TO BASIC CABLE TV SERVICE

For basic cable tv service not requiring a converter/descrambler box, connect the CATV 75 ohm coaxial cable to the VHF/UHF jack on the rear of the TV.

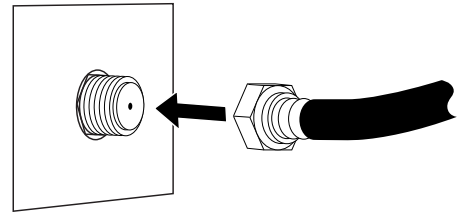

### FOR SUBSCRIBERS TO SCRAMBLED CABLE TV SERVICE OR SATELLITE

If you subscribe to a satellite service or a cable TV service which requires the use of a converter/descrambler box, connect the incoming 75 ohm coaxial cable to the converter/descrambler or satellite box. Using another 75 ohm cable, connect the output of the converter/descrambler or satellite box to the antenna jack on the TV. Follow the connections shown below. Set the TV/VCR to the output channel of the converter/descrambler or satellite box (usually 3 or 4) and use the converter/descrambler or satellite box to select channels.

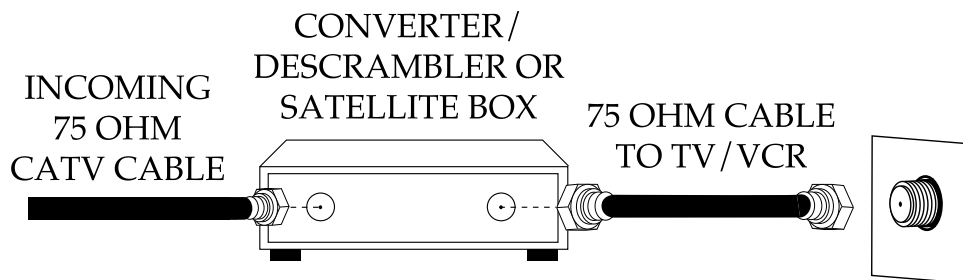

### FOR SUBSCRIBERS TO UNSCRAMBLED BASIC CABLE TV SERVICE WITH SCRAMBLED PREMIUM CHANNELS

If you subscribe to a satellite service or a cable TV service in which basic channels are unscrambled and premium channels require the use of a converter/descrambler box, you may wish to use a signal splitter and an A/B switch box (available from the cable company or an electronic supply store). Follow the connections shown below. With the switch in the "B" position, you can directly tune any unscrambled channels on your TV. With the switch in the "A" position, tune your TV to the output of the converter/descrambler box (usually channel 3 or 4) and use the converter/descrambler box to tune scrambled channels.

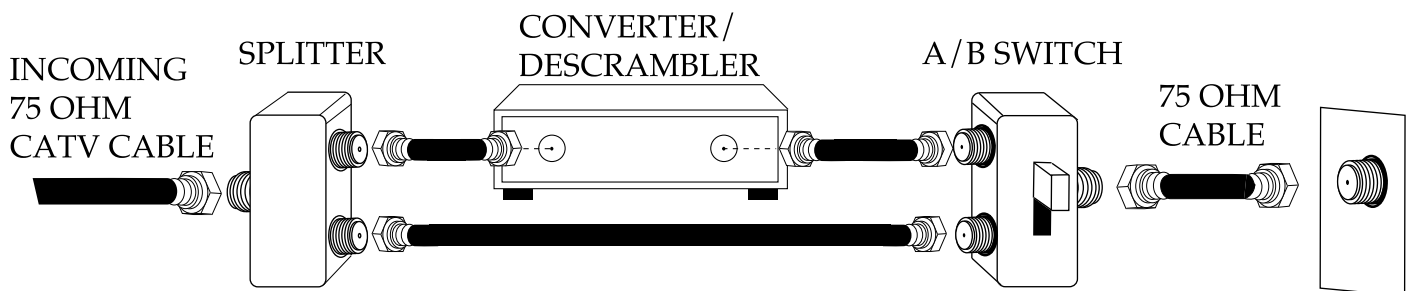

#### FAQS:

*I connected my cable, why can't I get channels above 69?*

Make sure AIR/CABLE is set to CABLE, see page 17. Also, make sure your cable company broadcasts channels in the range you are searching.

*Are the cables included?*

No, the cables are sold separately; visit your local electronics store.

# OUTDOOR ANTENNA CONNECTIONS

## OUTDOOR VHF/UHF ANTENNA CONNECTION (ANTENNA NOT SUPPLIED)

Follow the instructions for the type of antenna system you intend to use.

### Combination VHF/UHF Antenna (Single 75 ohm cable or 300 ohm twin-lead wire)

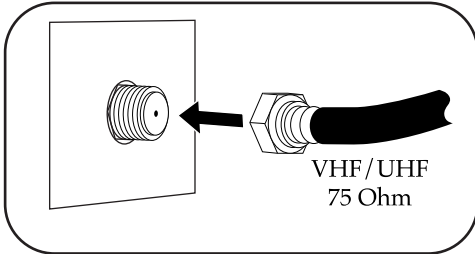

Connect the 75 ohm cable from the combination VHF/UHF antenna to the antenna jack.

**OR**

If your combination antenna has a 300 ohm twin-lead wire, use a 300-75 ohm matching transformer (NOT SUPPLIED).

### Combination VHF/UHF Antenna (Separate VHF and UHF 300 ohm twin-leads)

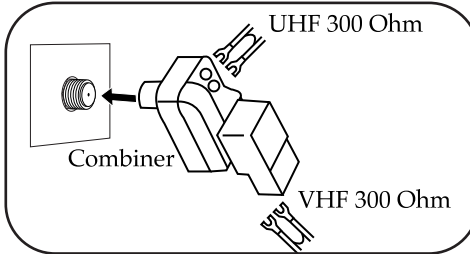

Connect the UHF twin-lead wire to a combiner (NOT SUPPLIED). Connect the VHF twin-lead to a 300-75 ohm matching transformer (NOT SUPPLIED). Attach the transformer to the combiner. Attach the combiner to the antenna jack.

### Separate VHF/UHF Antennas

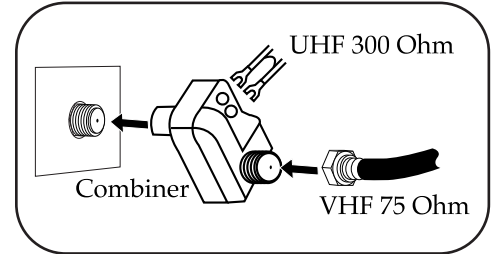

Connect the 75 ohm cable from the VHF antenna and the UHF antenna twin-lead wire to a combiner (NOT SUPPLIED). Attach the combiner to the antenna jack.

**NOTE:** If your VHF antenna has a twin-lead wire use a 300-75 ohm matching transformer, then connect the transformer to the combiner.

## VCR CONNECTIONS

### CONNECTION USING COAXIAL CABLE:

Follow the instructions below to connect a VCR to your television using a 75 ohm coaxial cable. (CABLES NOT INCLUDED.)

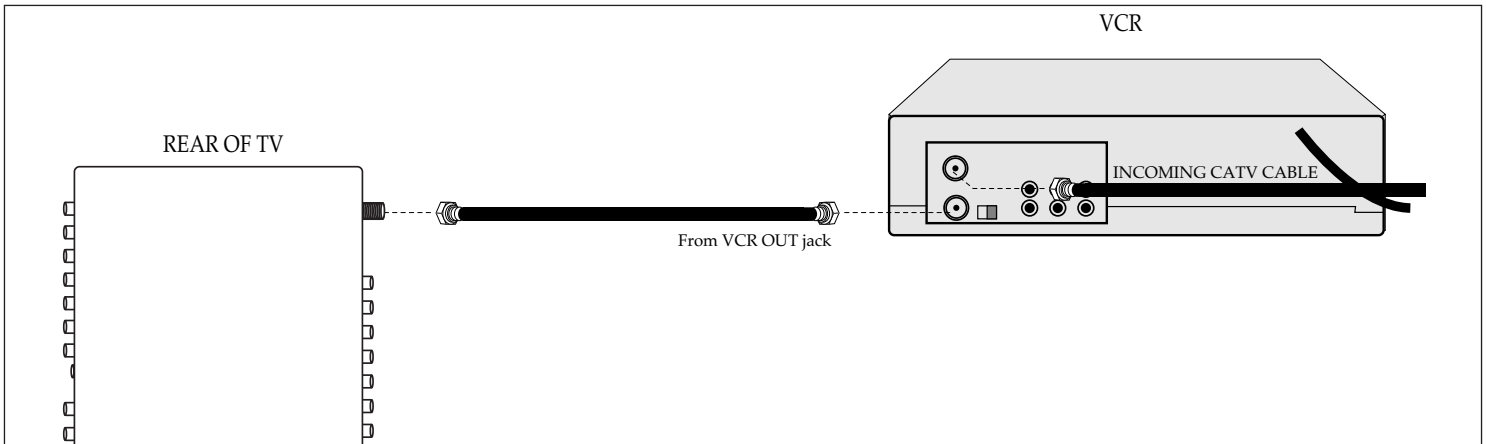

1. Connect the cable, satellite or incoming antenna to the VHF/UHF IN jack on the rear of the VCR.
2. Connect a 75 ohm coaxial cable from the VCR's 75 Ohm OUT jack to the ANT jack on the rear of the TV.
3. Press the TV/VIDEO/PC button until regular TV or CATV appears on the TV screen and press PLAY on the VCR to watch a tape.

### CONNECTION USING AUDIO/VIDEO CABLES:

Follow the instructions below to connect a VCR to your television using Audio/Video cables. (CABLES NOT INCLUDED.)

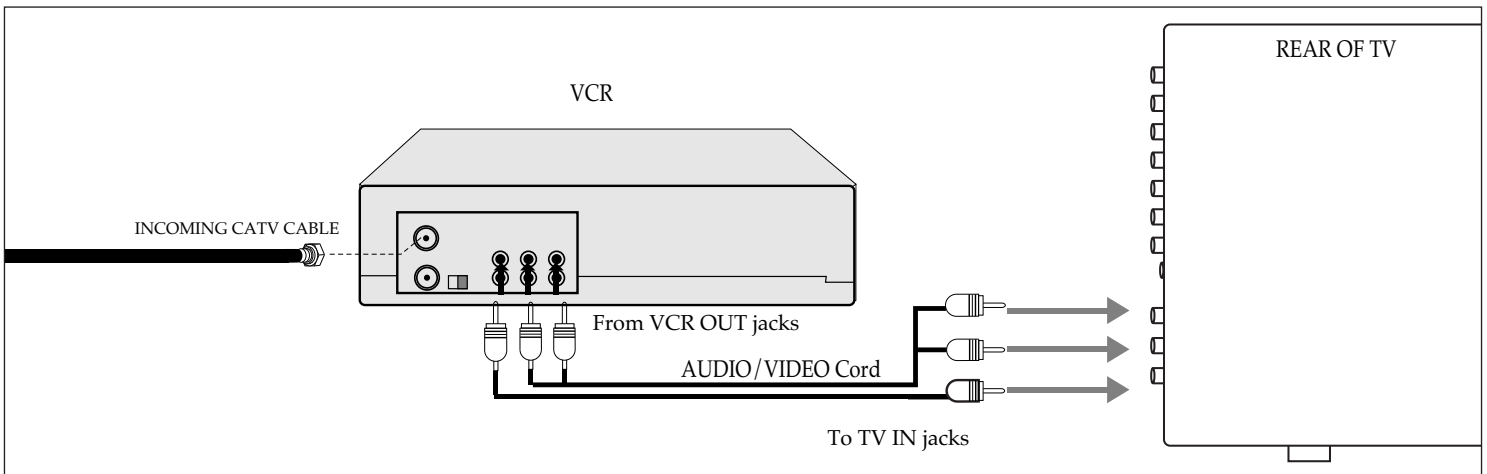

1. Connect the cable, satellite or incoming antenna to the VHF/UHF IN jack on the rear of the VCR.
2. Connect the left and right audio cable from the VCR's Audio OUT jacks to the TV's audio left and right AV IN jacks. Connect the VCR's video OUT jack to the TV's video AV IN jack.
3. Press the TV/VIDEO/PC button until AV appears on the TV screen and press PLAY on the VCR to watch a tape.

### FAQ:

*My VCR has only 1 Audio jack, but this TV has two Audio input jacks, how do I connect it?*  
Simply connect it to the "L (Mono)" Audio input jack, but the sound will be monaural.

## VCR CONNECTIONS (CONTINUED)

### CONNECTION USING S-VIDEO CABLE:

Follow the instructions below to connect an S-VIDEO VCR to your television using an S-video cable. (CABLES NOT INCLUDED.)

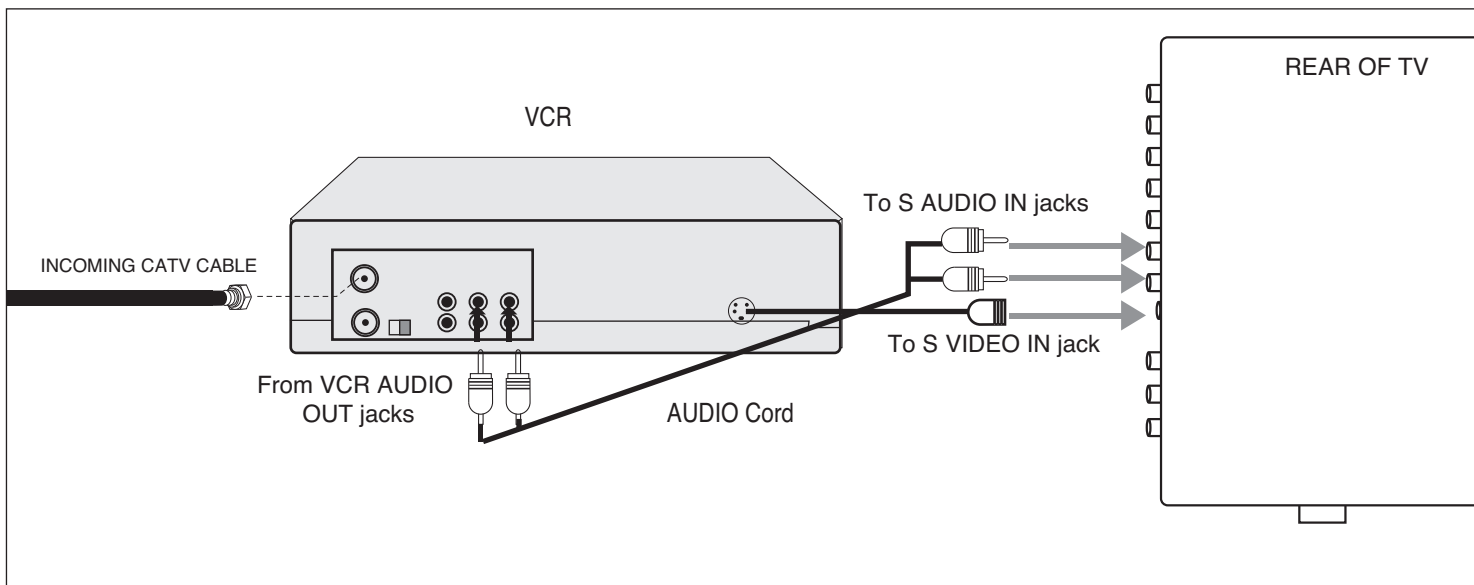

1. Connect the cable, satellite or incoming antenna to the ANT jack on the rear of the VCR.
2. Connect the left and right audio cable from the VCR's Audio OUT jacks to the TV's audio left and right S IN jacks.
3. Connect the VCR's S-VIDEO OUT jack to the TV's S-VIDEO IN jack.
4. Press the TV/VIDEO/PC button until S VIDEO appears on the TV screen and press PLAY on the VCR to watch a tape.

## DVD CONNECTIONS

### CONNECTION USING AUDIO/VIDEO CABLES:

Follow the instructions below to connect a DVD player to your television using Audio/Video cables. (CABLES NOT INCLUDED.)

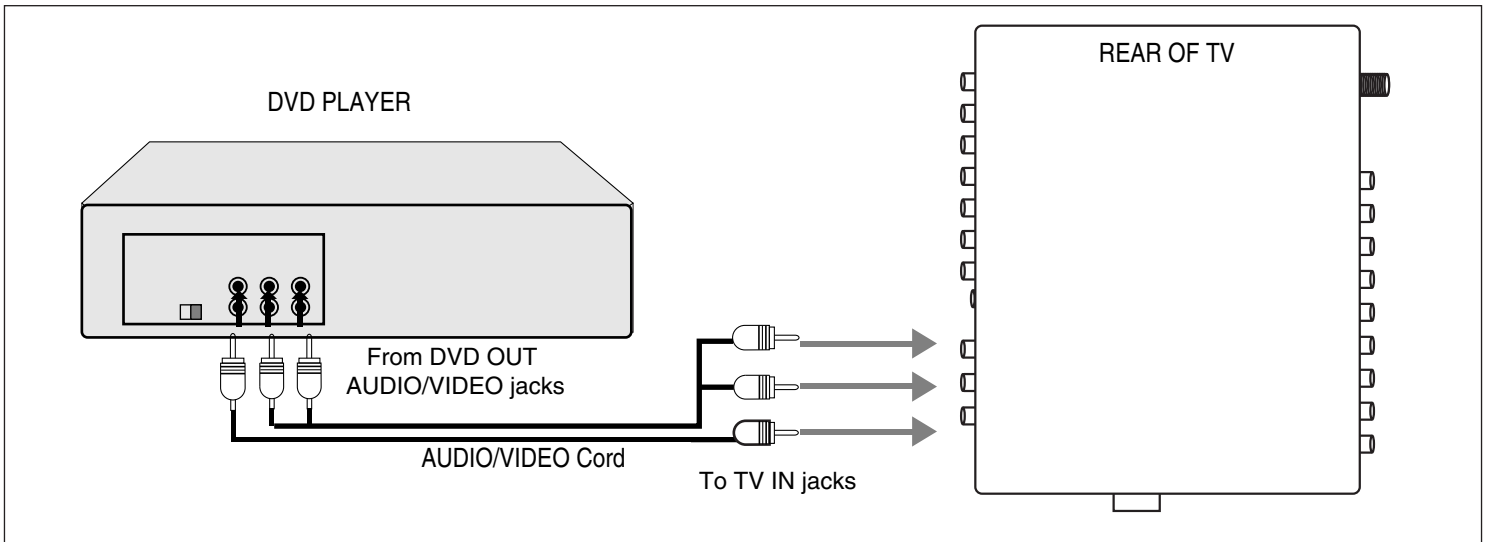

1. Connect the left and right audio cable from the DVD's Audio OUT jacks to the TV's audio left and right AV IN jacks. Connect the DVD's video OUT jack to the TV's video AV IN jack.
2. Press the TV/VIDEO/PC button until AV appears on the TV screen and press PLAY on the DVD to watch a DVD.

### CONNECTION USING S-VIDEO CABLE:

Follow the instructions below to connect a DVD player to your television using the S-Video cable. (CABLES NOT INCLUDED.)

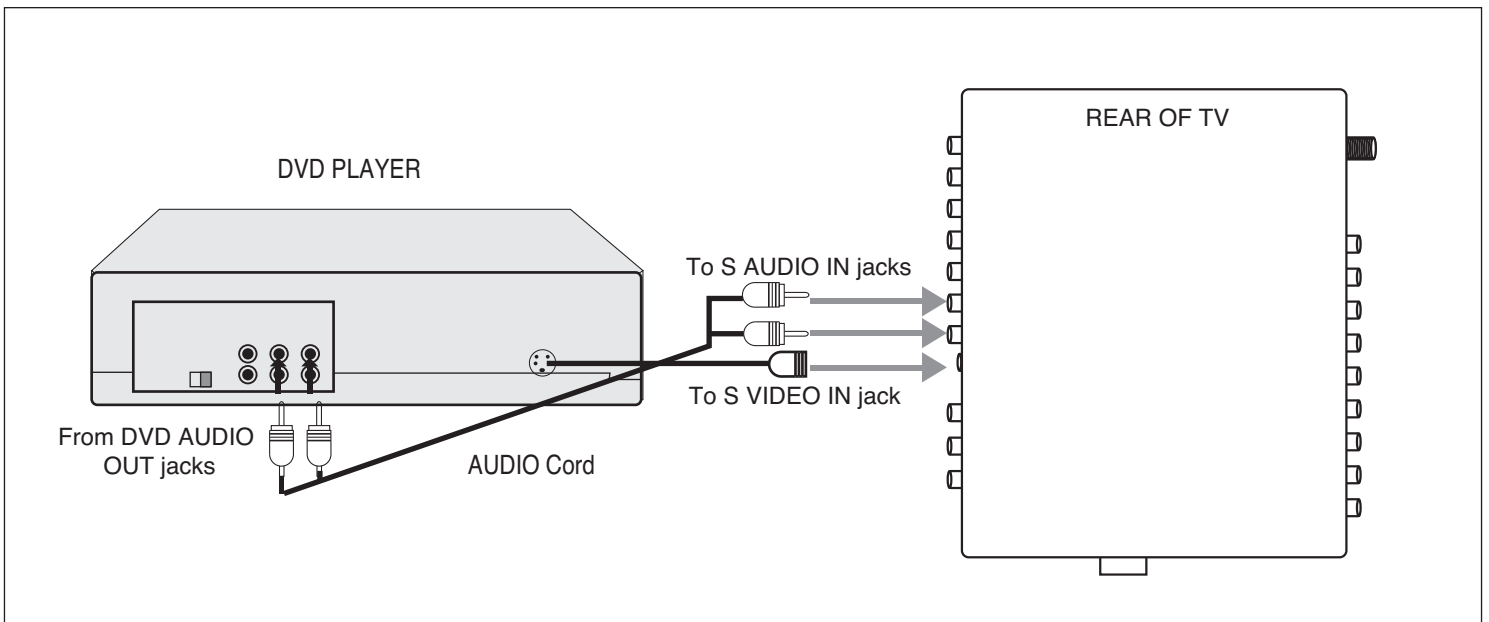

1. Connect the left and right audio cable from the DVD's Audio OUT jacks to the TV's audio left and right S IN jacks.
2. Connect the DVD's S-VIDEO OUT jack to the TV's S-VIDEO IN jack.
3. Press the TV/VIDEO/PC button until S-VIDEO appears on the TV screen and press PLAY on the DVD to watch the DVD.

## DVD CONNECTIONS (CONTINUED)

### CONNECTION USING COMPONENT CABLES:

Follow the instructions below to connect a DVD player to your television using the Cr, Cb, Y jacks. (CABLES NOT

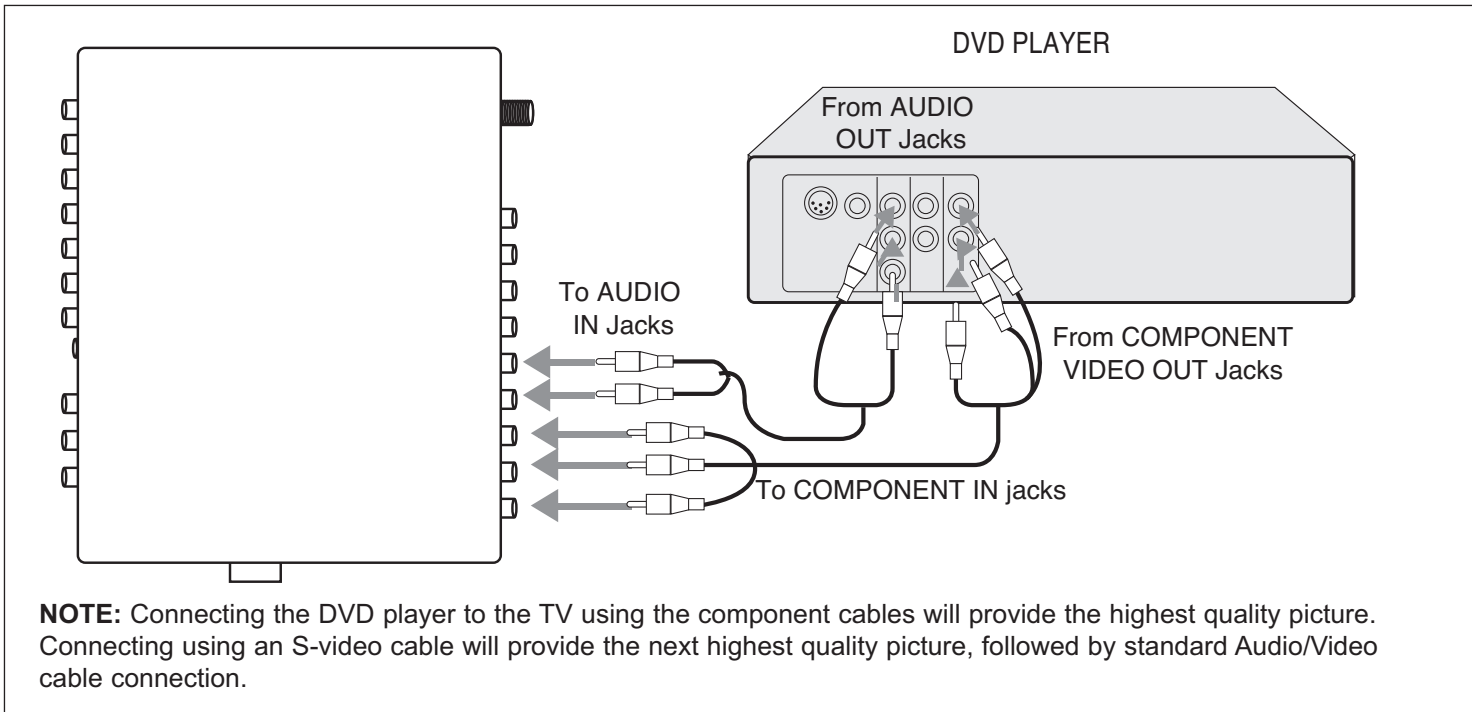

1. Connect the left and right audio cable from the DVD's Audio OUT jacks to the TV's audio left and right AV IN jacks.
2. Connect a video cable from the DVD's Y, Pb, Pr OUT jacks to the TV's AV2 DVD IN (Cr, Cb, Y) jacks.
3. Press the TV/VIDEO/PC button until COMPONENT appears on the TV screen and press PLAY on the DVD to watch a DVD.

## STEREO CONNECTION

Follow the instructions below to connect a stereo system to your television. (CABLES NOT INCLUDED.)

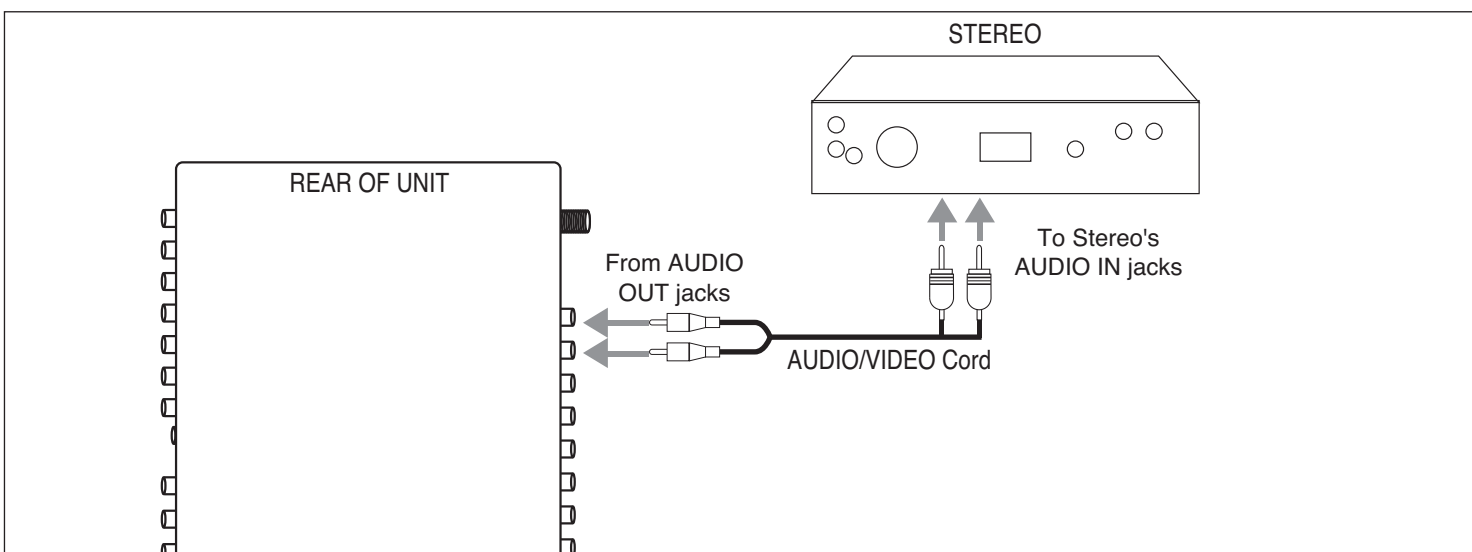

1. Connect the left and right audio cable from the TV's left and right Audio OUT jacks to the stereo system's left and right Audio IN jacks.
2. Refer to the stereo system's owner's manual for instructions.

## HDTV CONNECTION

Follow the instructions below to connect an HDTV set top box to your television. (CABLES NOT INCLUDED.)

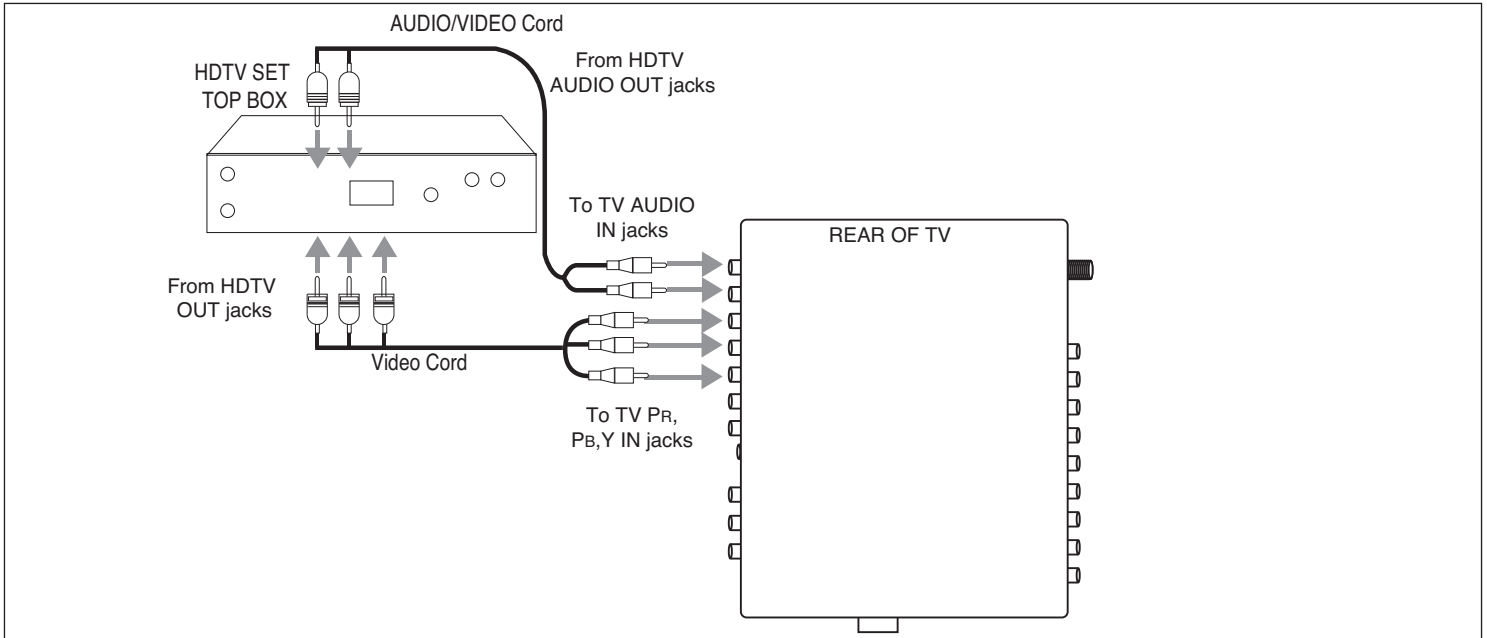

1. Connect the left and right audio cable from the HDTV's Audio OUT jacks to the TV's HDTV left and right Audio IN jacks.
2. Connect a video cable from the Y, Pb, Pr OUT jacks to the TV's HDTV IN jacks.
3. Press the TV/VIDEO/PC button until Y Pb Pr appears on the TV screen.

## COMPUTER CONNECTION

Follow the instructions below to connect a computer to your television/monitor. (CABLES NOT INCLUDED.)

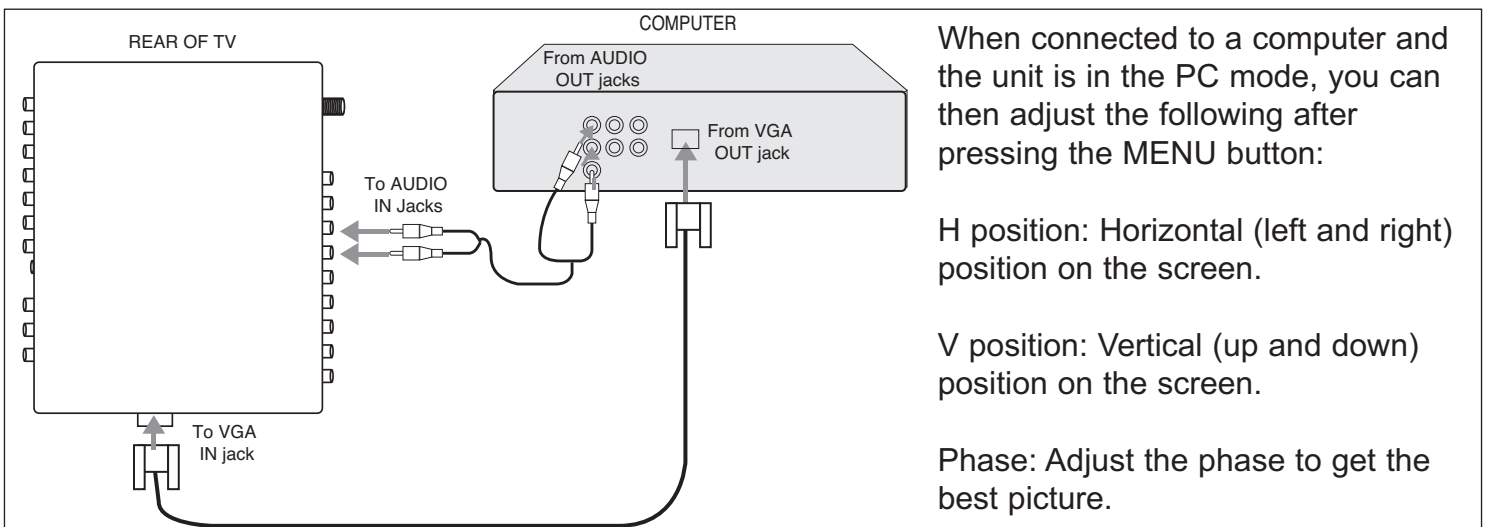

When connected to a computer and the unit is in the PC mode, you can then adjust the following after pressing the MENU button:

H position: Horizontal (left and right) position on the screen.

V position: Vertical (up and down) position on the screen.

Phase: Adjust the phase to get the best picture.

1. Connect the left and right audio cable from the computer's Audio OUT jacks to the TV's left and right VGA AUDIO IN jacks.
2. Connect a VGA cable from the computer's VGA OUT jack to the TV's VGA IN jack.
3. Press the TV/VIDEO/PC button until PC appears on the TV screen.
4. Refer to the computer's owner's manual for instructions.

## WALL MOUNTING THE UNIT

Please follow the instructions and figure below to install the unit using the supplied wall brackets and Hook Assemblies:

1. Before wall mounting the unit, you must remove the base stand as follows:
  - a. Remove the two screws, then remove the base cover as shown in figure 1.
  - b. Remove the eight screws, then remove the base stand as shown in figure 2.

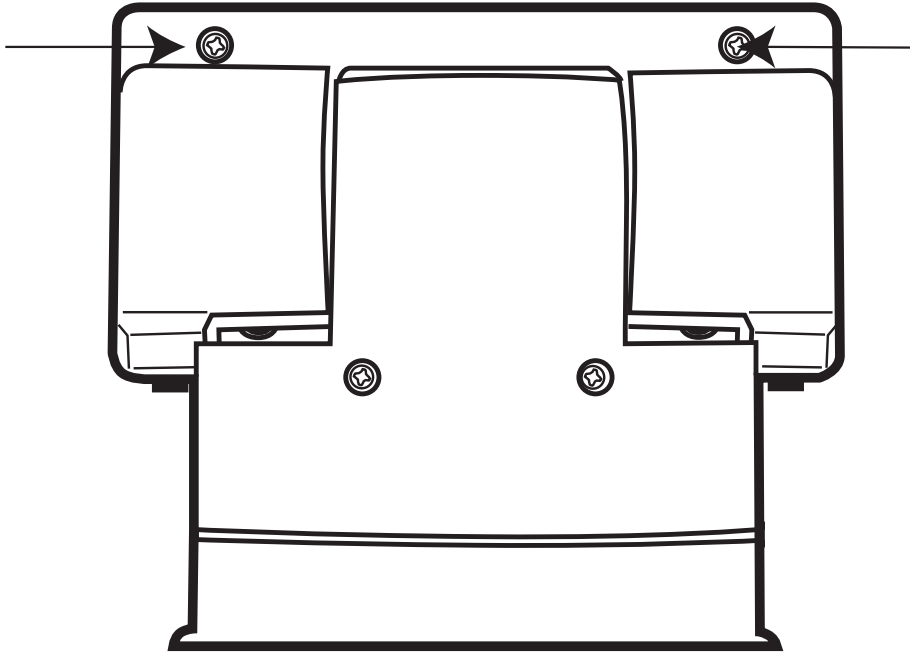

FIGURE 1

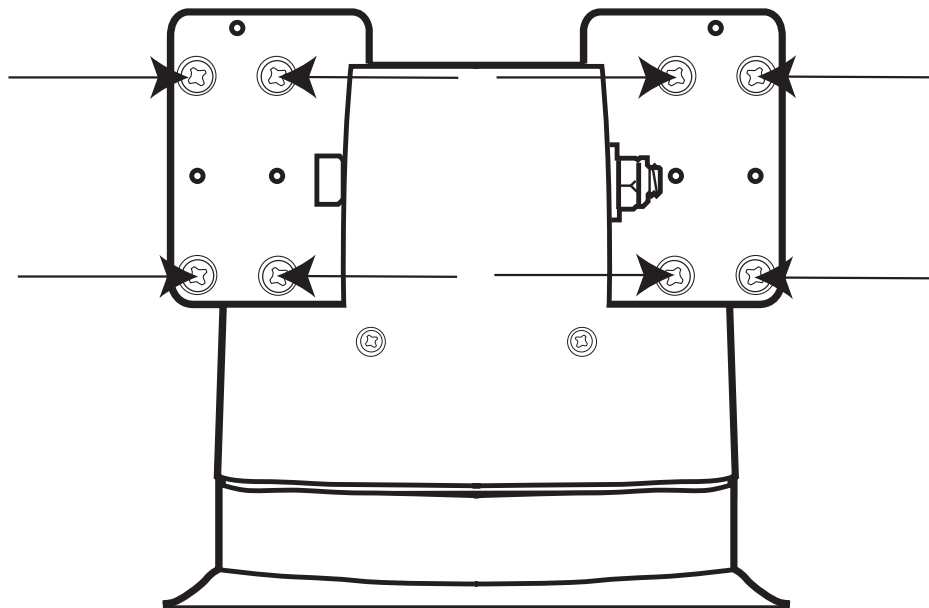

FIGURE 2

CONTINUED ON THE NEXT PAGE



## WALL MOUNTING THE UNIT (CONTINUED)

2. Drill four 5mm holes through the wall for each bracket, or if there is a stud behind the wall where you are putting the bracket, drill four 5mm holes through the wall and into the studs for each bracket. See below figure 3 for lengths.

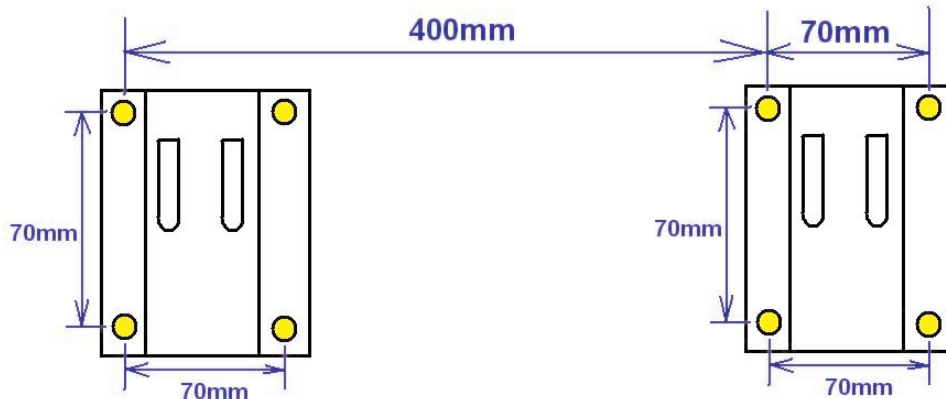

FIGURE 3

3. Secure the Hook Assemblies (A) to the TV by inserting the two screws for each Hook Assembly in the pre-drilled holes in the rear of the set as shown in figure 4.
4. With a helper's assistance, place the Hook Assemblies (A) carefully onto the Brackets (B) and slide down until it is secure.

**CAUTION:** You must make sure the brackets are very securely screwed into the wall and the Hook Assemblies are securely attached to the TV before securing the TV to the wall.

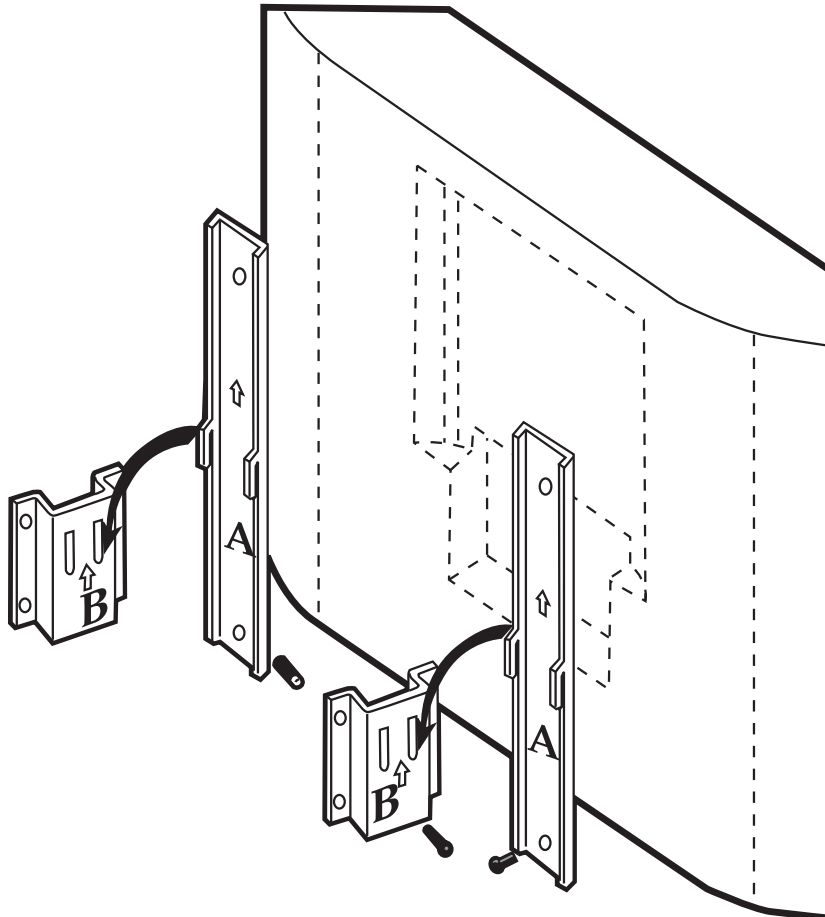
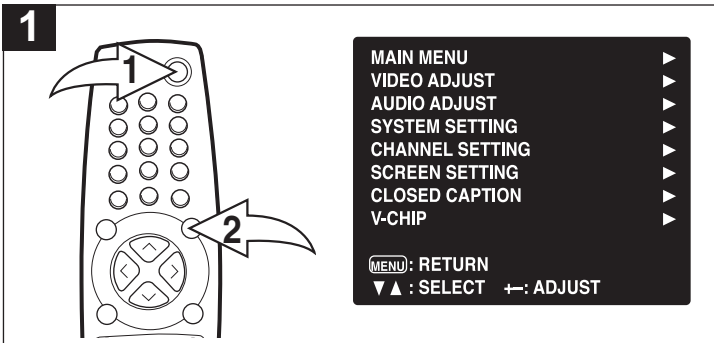
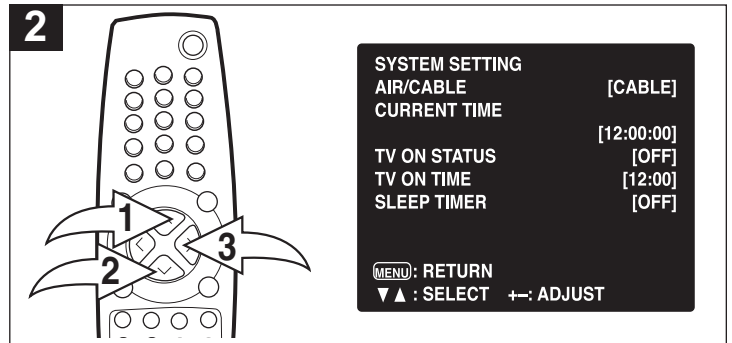

FIGURE 4

# CLOCK SETTING



Press the POWER button ❶ to turn on the TV; the POWER indicator will light green. Press the MENU button ❷; the MENU screen will appear.



Press the CHANNEL UP ❶ or DOWN ❷ button until SYSTEM SETTING is selected, then press the VOLUME UP button ❸ to select it. Press the CHANNEL UP ❶ or DOWN ❷ button until CURRENT TIME is selected.

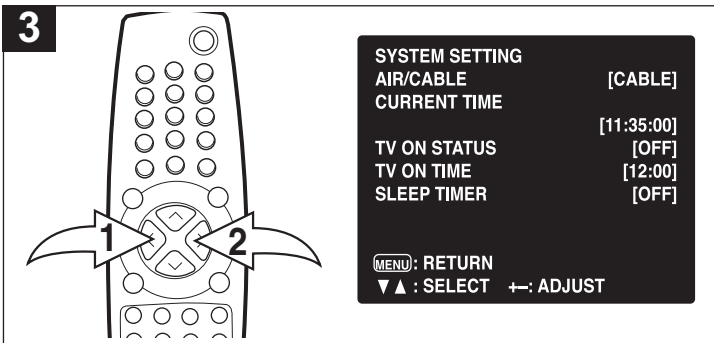

Set the hours using the VOLUME DOWN button ❶ and set the minutes using the VOLUME UP button ❷.

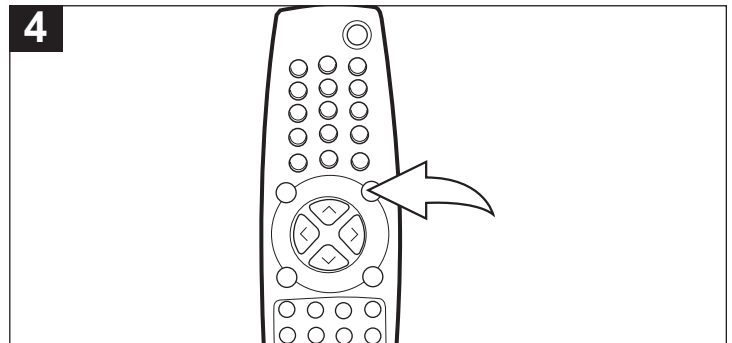

Press the MENU button once when finished to return to the Main menu. Press the MENU button again to exit the Main menu. If no button pressed for 15 seconds, the menu will disappear automatically.

# SETTING THE AIR/CABLE OPTION

Set the AIR/CABLE option as follows:

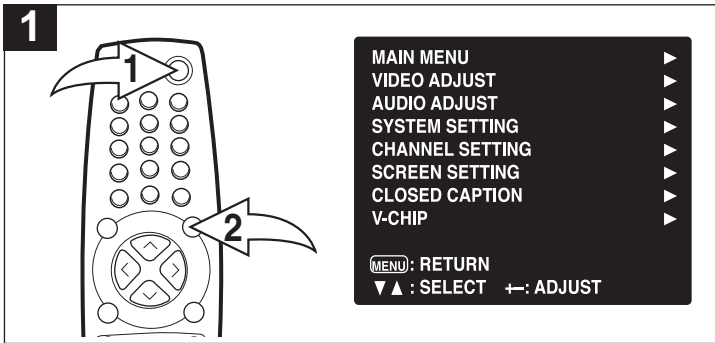

Press the POWER button ❶ to turn on the TV; the POWER indicator will light green. Press the MENU button ❷; the MENU screen will appear.

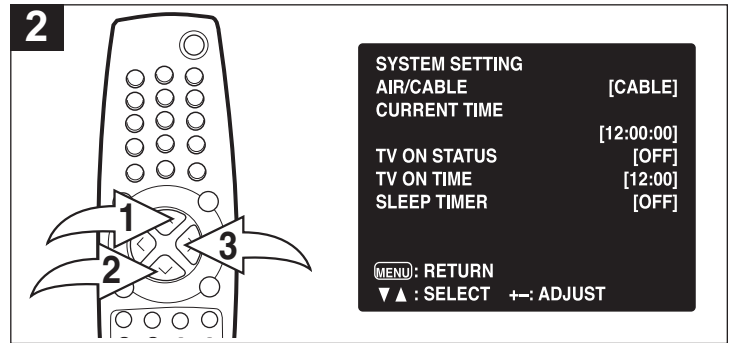

Press the CHANNEL UP ❶ or DOWN ❷ button until SYSTEM SETTING is selected, then press the VOLUME UP button ❸ to select it. Press the CHANNEL UP ❶ or DOWN ❷ button until AIR/CABLE is selected.

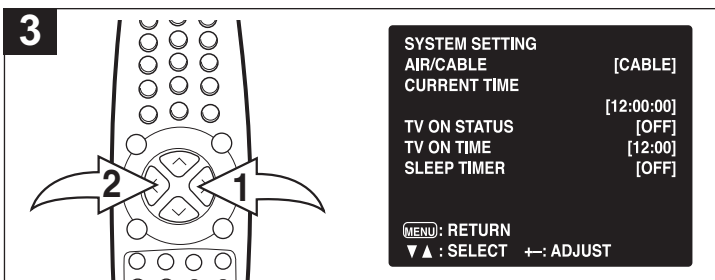

Press the VOLUME UP ❶ or DOWN ❷ button to select between AIR and CABLE.

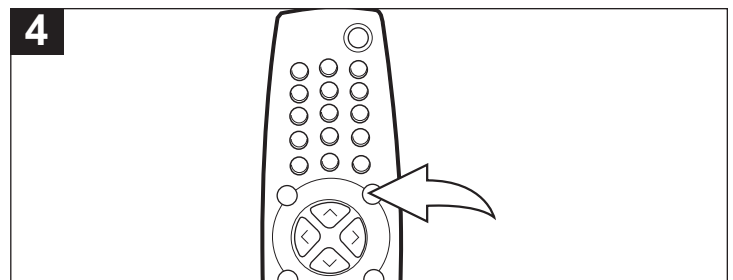

Press the MENU button once when finished to return to the Main menu. Press the MENU button again to exit the Main menu. If no button pressed for 15 seconds, the menu will disappear automatically.

## SETTING THE CHANNELS INTO MEMORY

This TV is equipped with a channel memory feature which allows channels to skip up or down to the next channels set into memory, skipping over unwanted channels. Before selecting channels, they must be programmed into the TV's memory. In addition to normal VHF/UHF channels, this TV can receive up to 113 Cable TV channels.

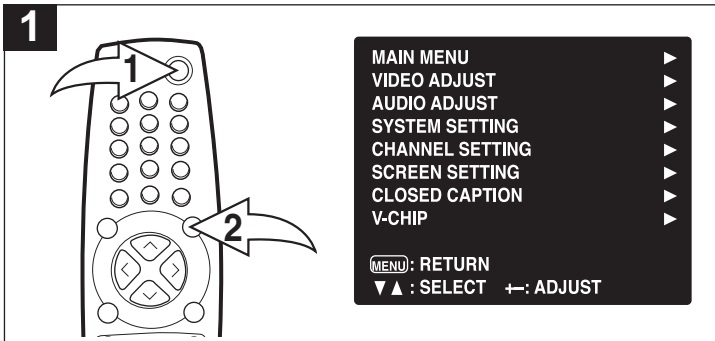

Press the POWER button ❶ to turn on the TV; the POWER indicator will light green. Press the MENU button ❷; the MENU screen will appear

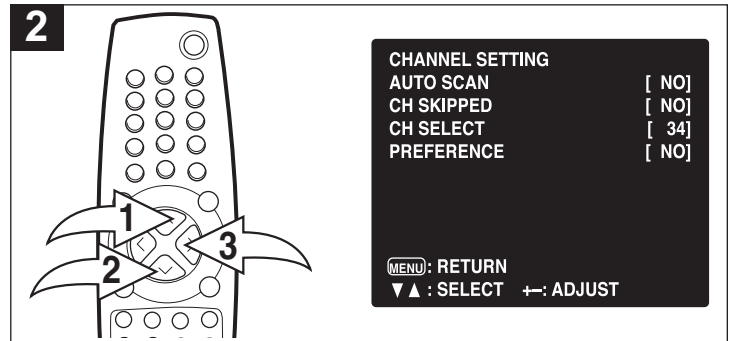

Press the CHANNEL UP ❶ or DOWN ❷ button until CHANNEL SETTING is selected, then press the VOLUME UP button ❸ to select it.

Press the CHANNEL UP ❶ or DOWN ❷ button until AUTO SCAN is selected.

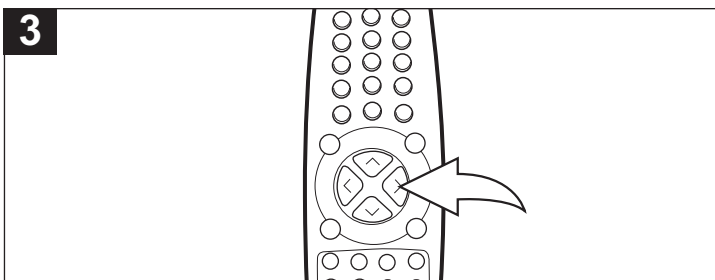

When AUTO MEMORY is selected, press the VOLUME UP button to start the Auto Search. The TV will automatically cycle through all the channels and store active channels into memory. When completed, the TV will be on the first available channel.

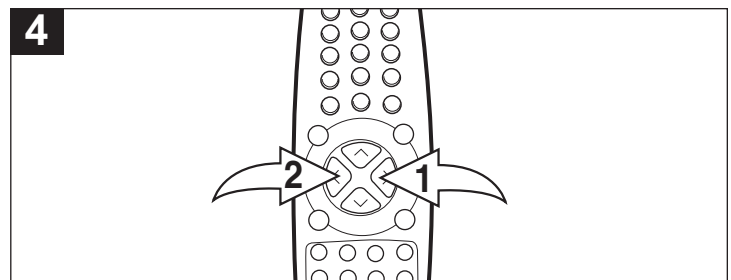

Press the VOLUME UP ❶ or DOWN ❷ button to stop Auto Memory while it is searching (if desired).

### FAQs:

*Why can't I access TUNING?*

You cannot access the TUNING option if you are not in the AIR/CABLE mode, there is no need to.

*How many channels will I actually receive?*

The actual number of channels that can be received depends on how many channels your cable or satellite company, or local area provides. Contact your company to determine the number of channels in your area.

*Do channels need to be set into memory before using the CHANNEL UP or DOWN button?*

Yes, the channels must be programmed into memory.

## ADDING AND SKIPPING CHANNELS

After setting channels into memory, you can add or delete channels as follows:

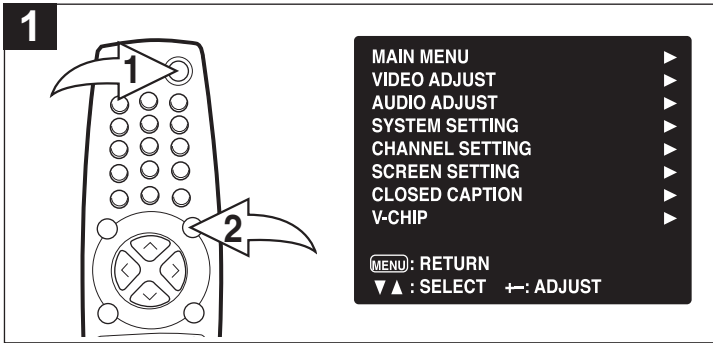

Press the POWER button ❶ to turn on the TV; the POWER indicator will light green. Press the MENU button ❷; the MENU screen will appear

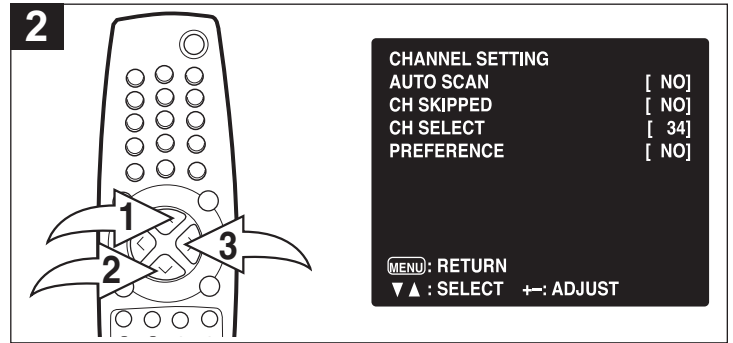

Press the CHANNEL UP ❶ or DOWN ❷ button until CHANNEL SETTING is selected, then press the VOLUME UP button ❸ to select it.  
Press the CHANNEL UP ❶ or DOWN ❷ button until CH SELECT is selected.

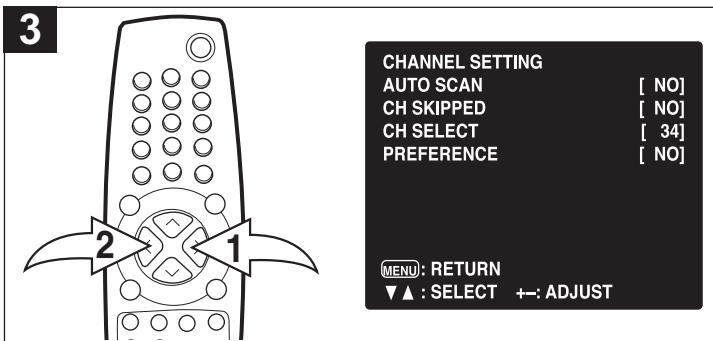

Select a channel to be skipped or added using the VOLUME UP ❶ or DOWN ❷ button.

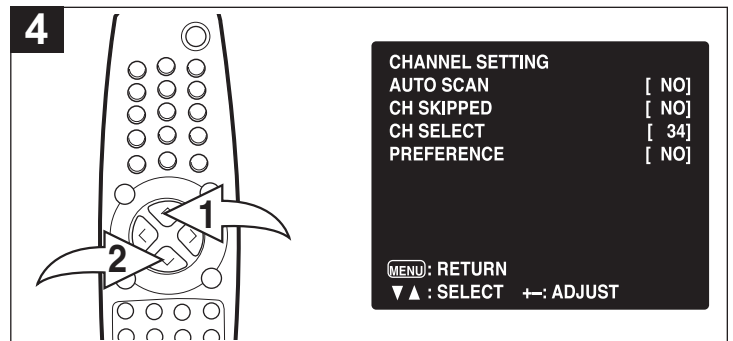

Press the CHANNEL UP ❶ or DOWN ❷ button until CHANNEL SKIPPED is selected.

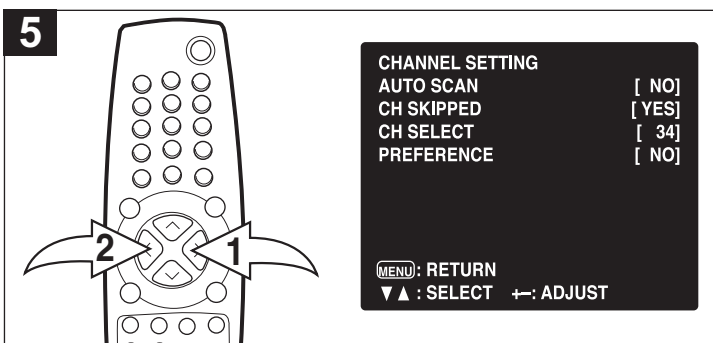

Using the VOLUME UP ❶ or DOWN ❷ button, select YES to skip the channel or NO to keep the channel.

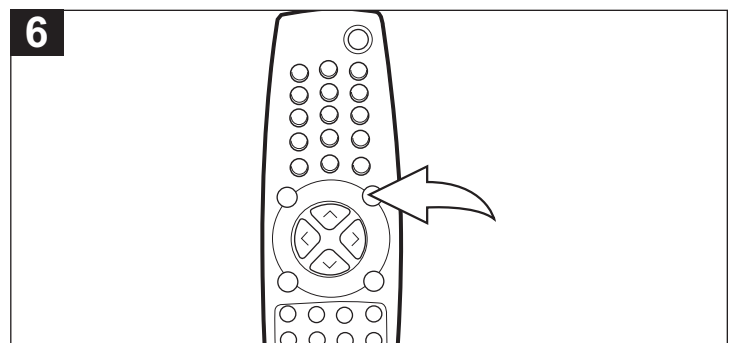

Press the MENU button once when finished to return to the Main menu. Press the MENU button again to exit the Main menu. If no button pressed for 15 seconds, the menu will disappear automatically.

# SETTING FAVORITE CHANNELS

Set up to ten channels into the Favorite Channel Preferences to easily access the channel. Set as follows:

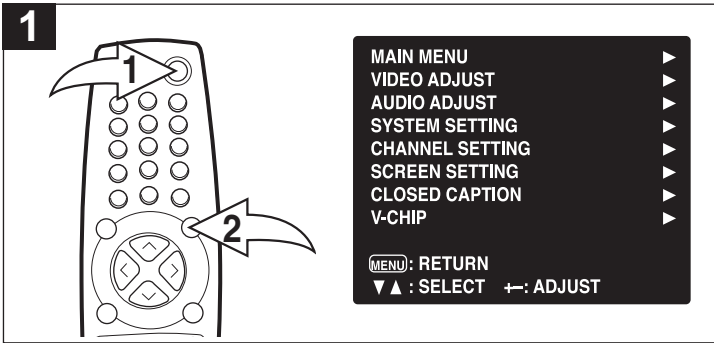

Press the POWER button ❶ to turn on the TV; the POWER indicator will light green. Press the MENU button ❷; the MENU screen will appear

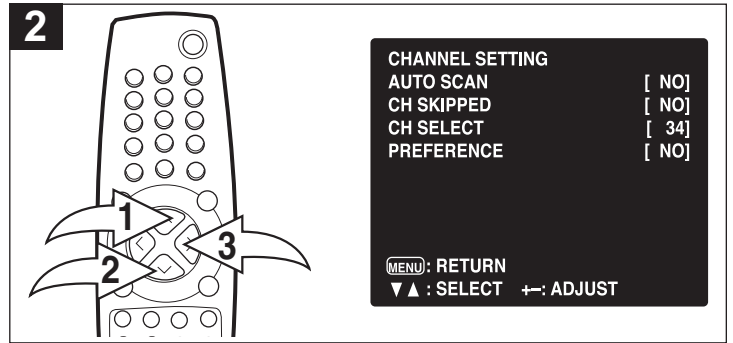

Press the CHANNEL UP ❶ or DOWN ❷ button until CHANNEL SETTING is selected, then press the VOLUME UP button ❸ to select it. Press the CHANNEL UP ❶ or DOWN ❷ button until CH SELECT is selected

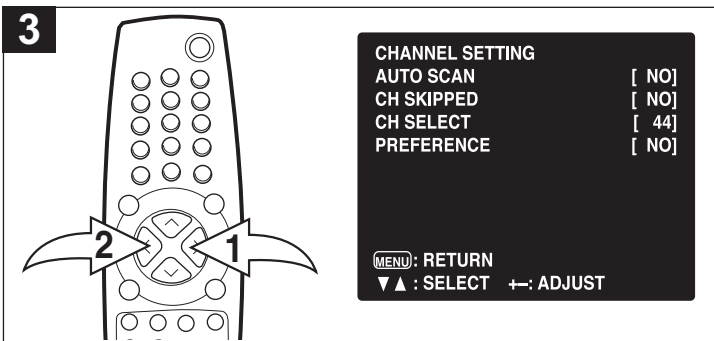

Select a channel to be added to the Favorite Channel Preferences using the VOLUME UP ❶ or DOWN ❷ button.

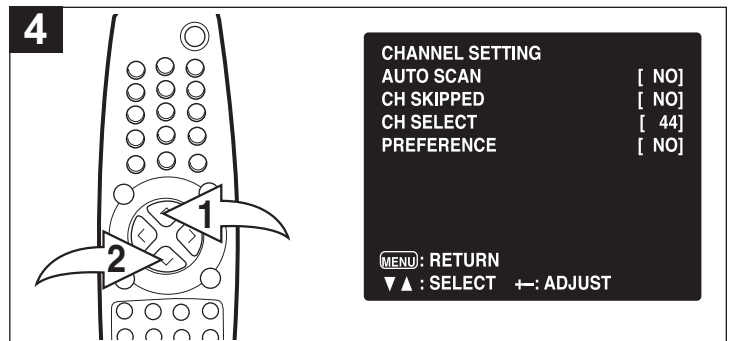

Press the CHANNEL UP ❶ or DOWN ❷ button until PREFERENCES is selected.

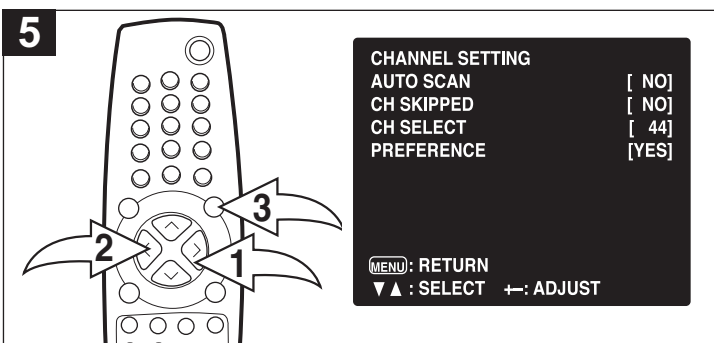

Using the VOLUME UP ❶ or DOWN ❷ button, select YES to add the channel to the preferences or NO to delete or not add the channel to the preferences. You can set up to 10 Favorite Channels. Exit the menu by pressing the MENU button ❸ twice.

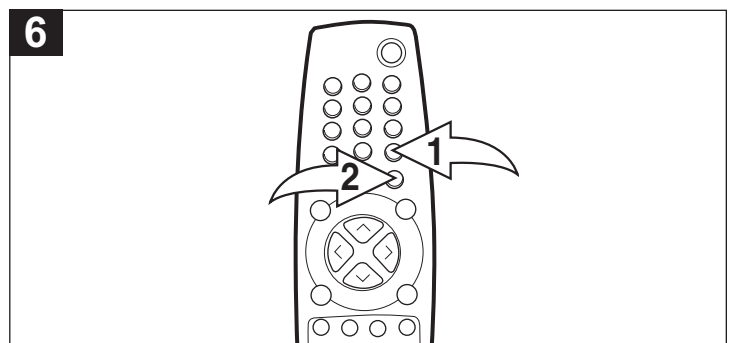

When watching TV, simply press the FAVORITE CHANNEL UP ❶ or DOWN ❷ button to cycle through your favorite channels.

# SETTING THE SLEEP TIMER

To set the TV to turn off after a preset amount of time, follow the steps below:

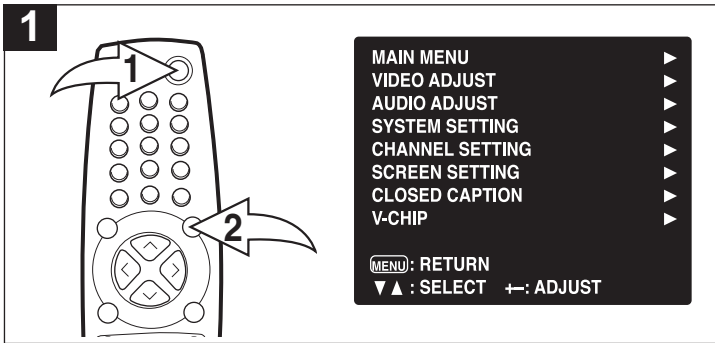

Press the POWER button ❶ to turn on the TV; the POWER indicator will light green. Press the MENU button ❷; the MENU screen will appear

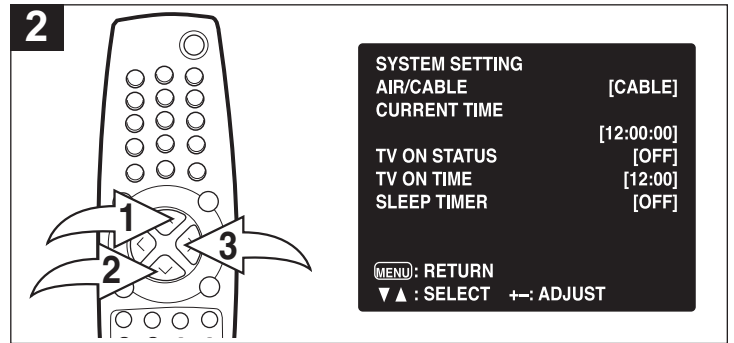

Press the CHANNEL UP ❶ or DOWN ❷ button until SYSTEM SETTING is selected, then press the VOLUME UP button ❸ to select it. Press the CHANNEL UP ❶ or DOWN ❷ button until SLEEP TIMER is selected.

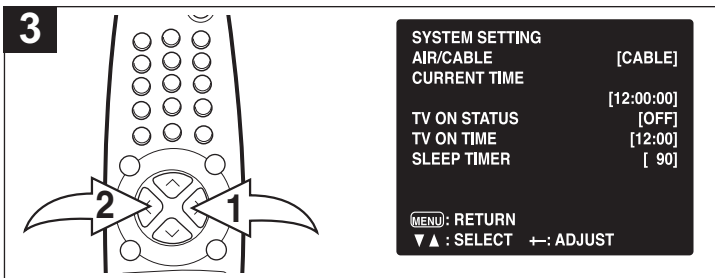

Select the desired sleep time from 10 minutes ("10M") to 90 minutes ("90M") using the VOLUME UP ❶ button.  
**NOTE:** To cancel the sleep function, press the VOLUME DOWN button ❷ to select OFF or use the VOLUME UP button ❶ to select "00M".

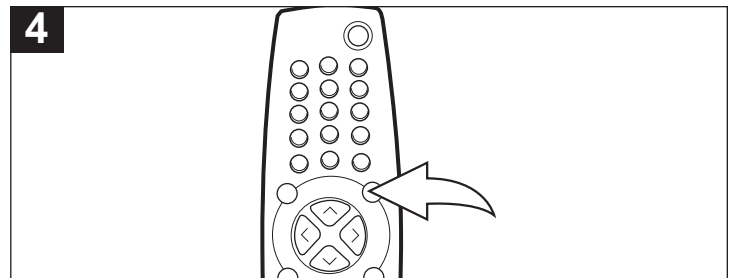

Press the MENU button once when finished to return to the Main menu. Press the MENU button again to exit the Main menu. If no button pressed for 15 seconds, the menu will disappear automatically. The TV will then stay on for the selected time, and then shut off automatically.

## TV OPERATION

1

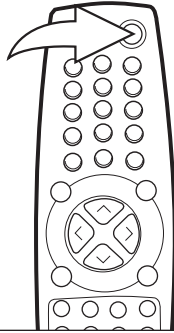

Press the POWER button to turn on the TV; the POWER indicator will light green.

2

### OPTIONS

**AIR:** If using a VHF/UHF antenna.

**CABLE:** If using Cable TV.

Set the AIR/CABLE option as described on page 18.

3

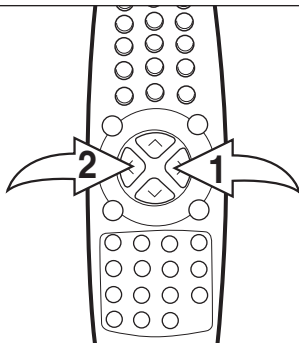

Adjust the volume level by pressing the VOLUME UP ❶ or DOWN ❷ button. The volume level will be indicated on the screen by a green numerical display between 0 and 100 where 0 is the lowest setting and 100 is the loudest.

4

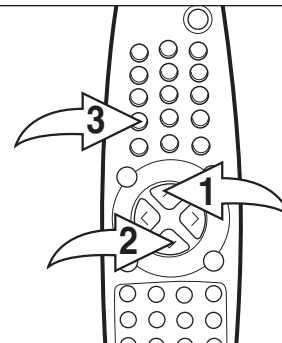

**For proper operation, before selecting channels, they must be set into the TV's program memory, see page 19.** Press and release the CHANNEL UP ❶ or DOWN ❷ button. The TV automatically stops at the next channel set into memory. This will not operate if channels are not set into memory.

### Direct Program Selection buttons (0 - 9, 100+)

Use these buttons to select a channel. The channel number will appear at the top right corner of the screen.

- For Channels 01 through 99, press the two digits in order.
- For Channels 100 through 125, press the 100 button ❸, then the remaining two digits.

### NOTES:

- When TV/CATV is set to TV, only channels up to 69 can be selected. When set to CATV, channels up to 125 can be selected.
- If an invalid channel is selected, the display will revert to the original channel.

### FAQs:

*Why do I only receive 69 channels, when my cable goes much higher?*  
AIR/CABLE option must be set to CABLE when using cable, see page 18.

*Why are some channels scrambled?*  
You must subscribe to these channels through your cable company.



## TV OPERATION (CONTINUED)

### MUTE

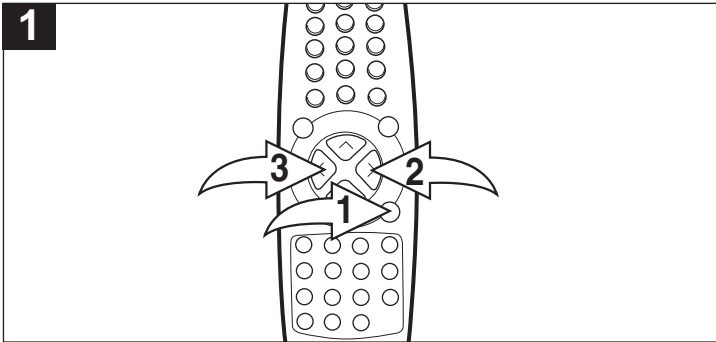

Press the MUTE button ❶ to turn off the sound. The TV's sound will be silenced and "AUDIO MUTE" will appear on the screen for a few seconds. The sound can be turned back on by pressing this button again or one of the VOLUME UP ❷ or DOWN ❸ button.

### RECALL

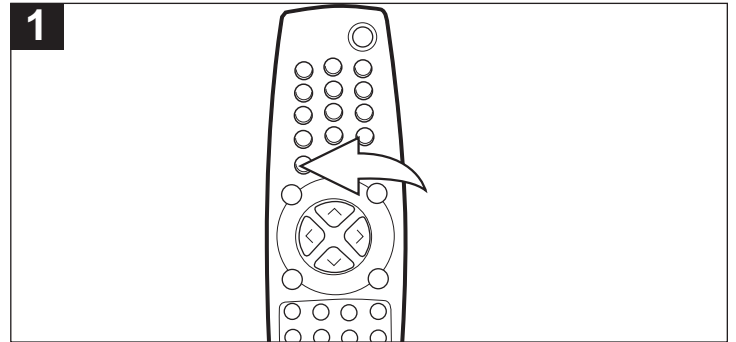

Press the RECALL button to go back to the last channel selected. Press the RECALL button again to return to the channel you were watching.

### TV/AV/PC

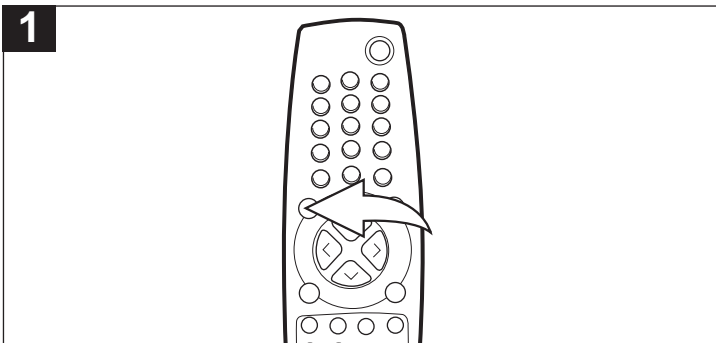

Repeatedly press this button to cycle through the device(s) connected to the INPUT jacks (TV/CATV, AV, S-VIDEO, COMPONENT, YPbPr and PC).

### MTS

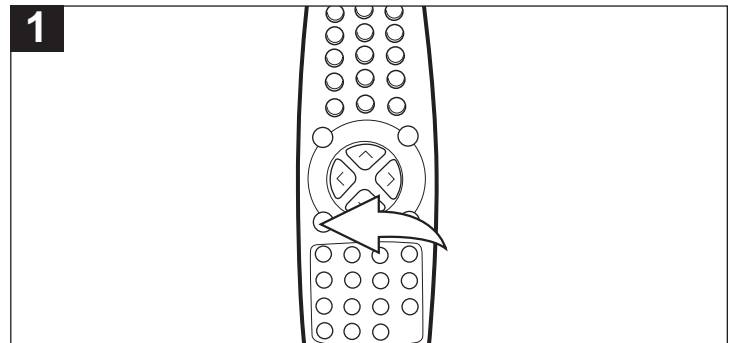

Press to select one of the following sound modes:

**STEREO:** Select for channels that are broadcasting in stereo.

**MONO:** Select for channels broadcasting in mono or if you are having difficulty receiving a stereo signal.

**SAP (Separate Audio Program):** Select to listen to a Separate Audio Program which is usually a foreign language translation.

### FAVORITE CHANNEL

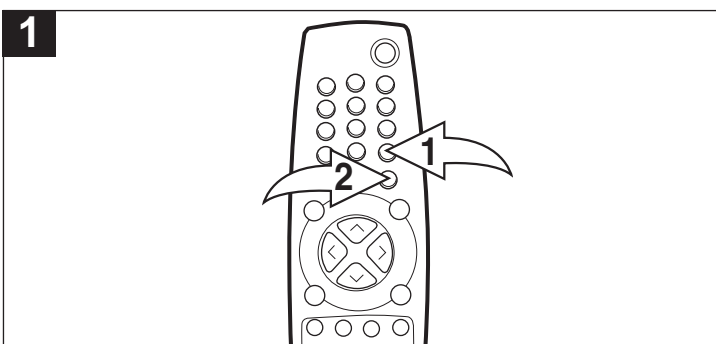

Press the FAVORITE CHANNEL UP ❶ or DOWN ❷ button to cycle through your favorite channels, as set on page 21.

### SLEEP TIMER

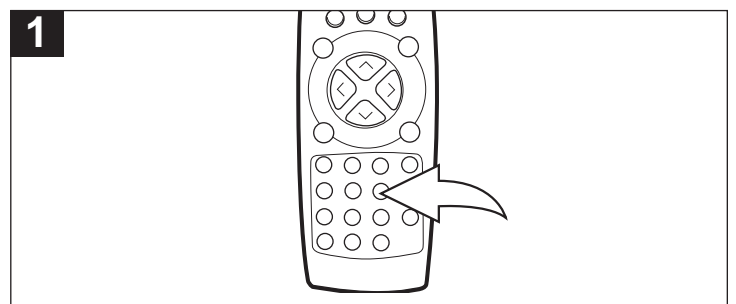

Press repeatedly to set the sleep time between "00" and "90" (each press will increase the time by 10 minutes). When the sleep time is up, the TV will shut off. Select "00" to cancel the sleep function.

## TV OPERATION (CONTINUED)

### DISPLAY

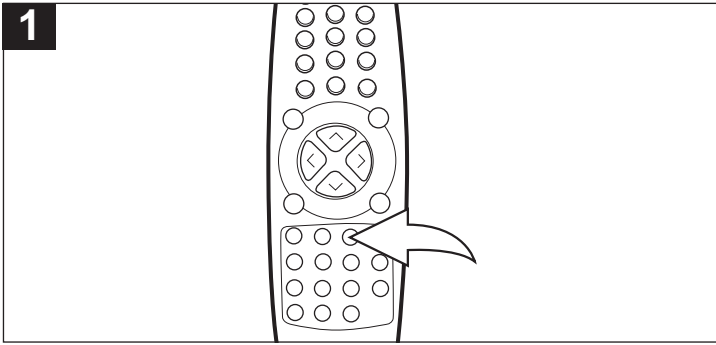

Press the DISPLAY button once to show the time. Press again to show the mode (i.e. S-VIDEO). Press a third time to clear the screen or wait three seconds and the screen will clear automatically.

### VIDEO MODE

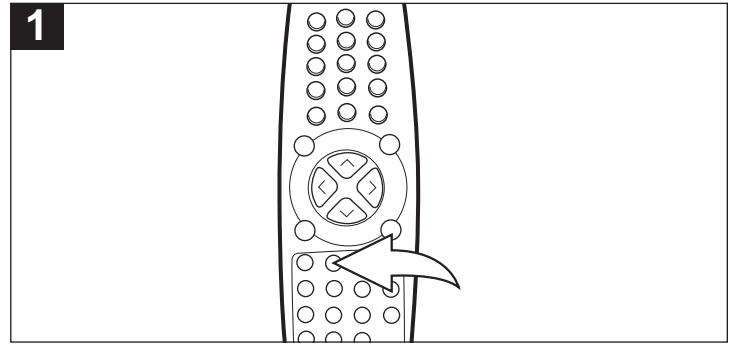

Press to select a mode (PRESET, SOFT or USER) as set on page 28.

**NOTE:** You cannot change the video MODE while using the Y Pb Pr or computer inputs.

### AUDIO MODE

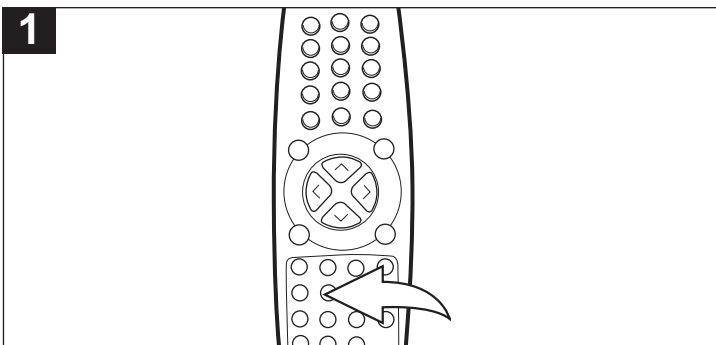

Press to select a mode (PRESET, SOFT or USER) as set on page 29.

**NOTE:** You cannot change the audio MODE while using the Y Pb Pr or computer inputs..

### VIDEO MUTE

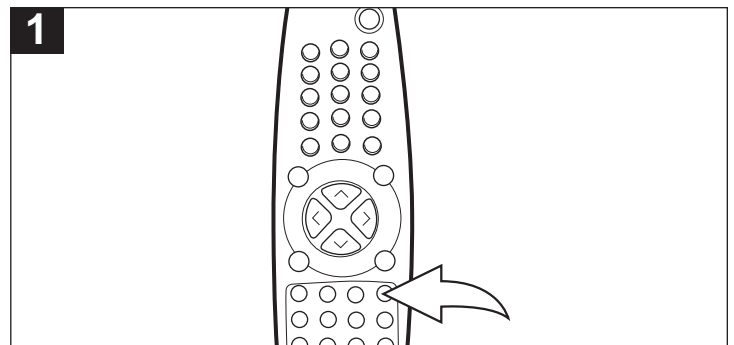

Press and the picture will disappear from the screen, but the sound will still be heard.

### CHANNEL LOCK

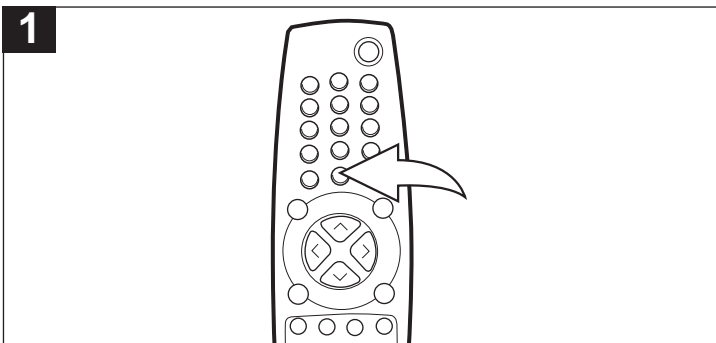

Channel Lock provides instant access to one of your favorite channels at the touch of a button. To set, go to the channel you want to set as the channel lock, then press and hold the CHANNEL LOCK button on the remote until the on-screen display shows "LOCKED"; the channel is now locked in. To access, simply press the CHANNEL LOCK button on the remote and the TV will automatically tune to that channel.

### SRS

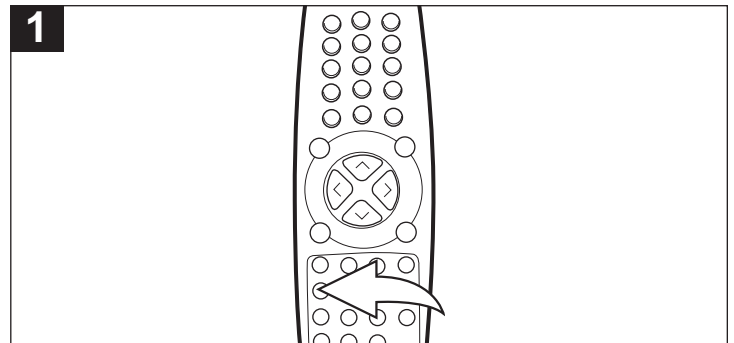

This feature allows the TV's left and right speakers to provide a surround sound effect.

Press to cycle through the surround modes as follows:

SURROUND 1: Simulated stereo

SURROUND 2: Stereo surround

SURROUND 3: Mono surround

SURROUND OFF: To turn off surround sound.

## TV OPERATION (CONTINUED)

### WIDE

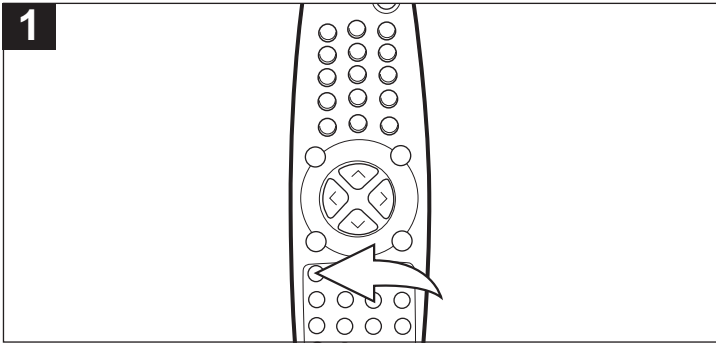

Press the WIDE button to select one of the screen modes:  
FULL: The image will stretch to cover the full screen; use this MODE when viewing wide-screen programming material.  
M1: The image will increase slightly over the standard size  
M2: The image will increase slightly over M1.  
M3: The image will increase slightly over M2.  
M4: The image will increase slightly over M3.  
4:3: The image will be the standard viewing size.

### AUDIO AI

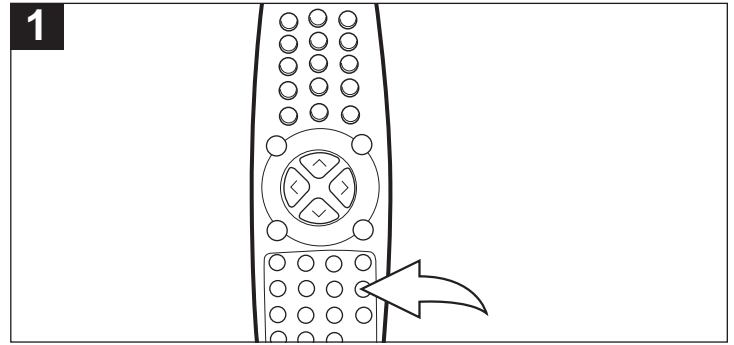

Each broadcasting channel has its own signal conditions and it is inconvenient to adjust the volume every time the channel is changed or when a commercial comes on. Audio AI automatically adjusts the volume of the desired channel by lowering the sound output when the modulation signal is high or by raising the sound output when the modulation signal is low. Press the AUDIO AI button to turn this feature on or off.

### PIP and POP

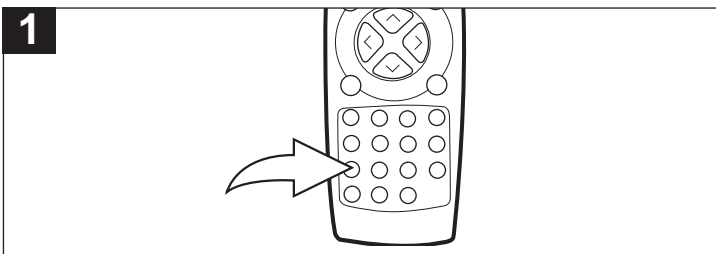

Press the PIP/POP button to turn picture-in-picture on; press a second time to turn picture on picture (split screen) on (this will show a picture next to a picture). Press a third time to turn PIP or POP off.

**NOTE:** One picture will be used for the TV/AV/S-VIDEO/COMPONENT signal and the other picture will be used for the HDTV-YPbPr/PC signal only.

### SWAP

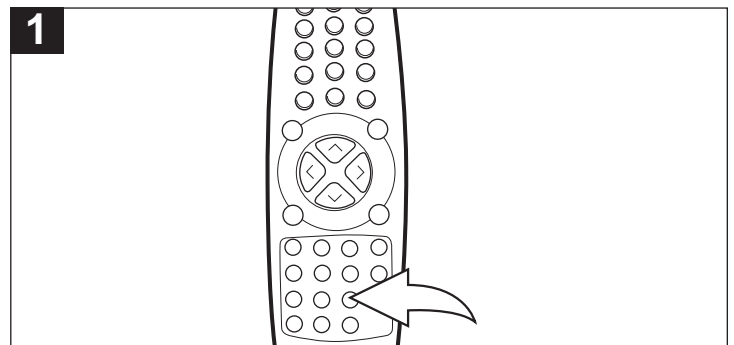

Press the SWAP button to alternate the screens when using PIP or POP. This will also alternate what screen the VOLUME, VIDEO SOURCE, etc buttons control.

### SCREEN POSITION

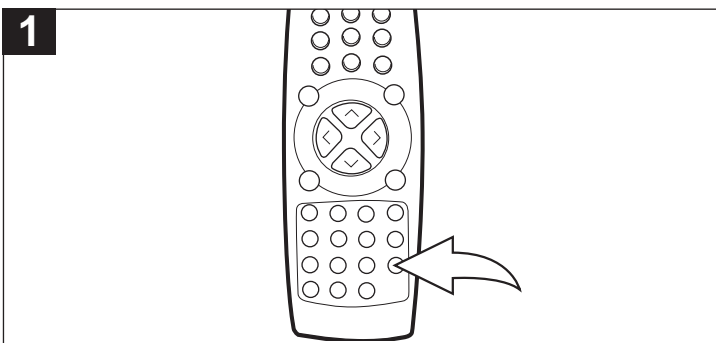

Press this button to select one of the four corners of the screen for the PIP picture.

### IMAGE SOURCE

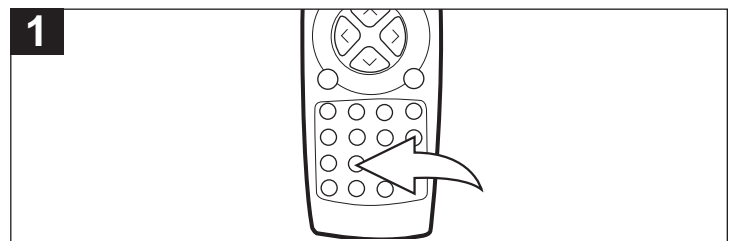

When PIP or POP selection is on, press the IMAGE SOURCE button to change the mode of the picture (the picture with the green color boundary).

**NOTE:** If in the PC or YPbPr mode, you can only change to PC or YPbPr mode. If in the TV, AV, S-VIDEO or COMPONENT mode, you can only change to the TV, AV, S-VIDEO or COMPONENT mode. For example, you cannot change from PC mode to S-VIDEO mode.

# CLOSED CAPTIONS

## WHAT IS CLOSED CAPTIONING?

This television has the capability to decode and display Closed Captioned television programs. Closed Captioning will display text on the screen for hearing impaired viewers or it will translate and display text in another language.

## CLOSED CAPTIONING WITH A VCR

Closed Captioned programs can be recorded and played back on a VCR with the Closed Captioned text intact. The Closed Captioned text will disappear during Cue (Fast Forward Search), Review (Rewind Search) and Pause modes or if the VCR tracking is not adjusted properly.

## TO VIEW CLOSED CAPTIONS

Enter the MENU and select CLOSED CAPTION. Scroll down and select the desired settings:

**MODE:** Select either CC (Captions) or TEXT (Full screen text) or OFF as follows:

**CAPTIONS:** This Closed Caption Mode will display text on the screen in English or another language. Generally, Closed Captions in English are transmitted on Captions 1 and Closed Captions in other languages are transmitted on Captions 2.

**TEXT:** The Text Closed Caption Mode will usually fill the screen with a programming schedule or other information.

**OFF:** Turns closed captions off.

**CHANNEL:** Select between the four closed caption channels.

After selecting a Closed Caption Mode, it will stay in effect until it is changed, even if the channel is changed. If the Captions signal is lost due to a commercial or a break in the signal, the Captions will reappear when the signal is received again. If the channels are changed, the Captions will be delayed approximately 10 seconds.

The Captions will appear in places on the screen where they will least interfere with the picture, usually on the bottom of the screen. News programs will usually show three-line Closed Captions which scroll onto the screen. Most other shows provide two or three lined Captions placed near the character who is speaking so the viewer can follow the dialogue.

Words in italics or underlined describe titles, words in foreign languages or words requiring emphasis. Words that are sung usually appear enclosed by musical notes.

For television programs broadcasting with Closed Captions, look in your TV guide for the Closed Captions symbol (CC).

### NOTES:

- When selecting Closed Captions, the captioning will be delayed approximately 10 seconds.
- Misspellings or unusual characters may occasionally appear during Closed Captioning. This is normal with Closed Captioning, especially with live programs. This is because during live programs, captions are also entered live. These transmissions do not allow time for editing.
- When Captions are being displayed, on-screen displays, such as volume and mute may not be seen or may interfere with Closed Captions.
- Some cable systems and copy protection systems may interfere with the Closed Caption signal.
- If using an indoor antenna or if TV reception is very poor, the Closed Caption decoder may not appear or may appear with strange characters or misspelled words. In this case, adjust the antenna for better reception or use an outdoor antenna.

## CLOSED CAPTIONS

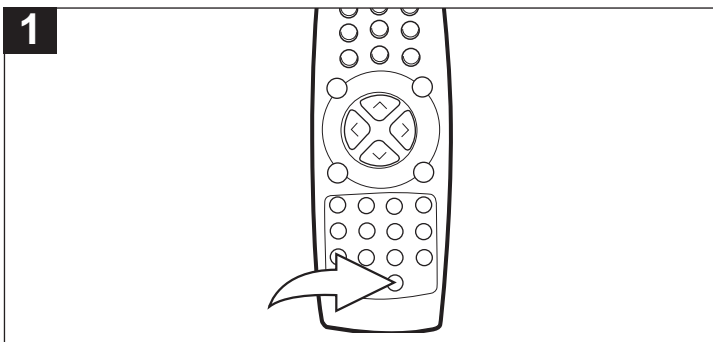

Press the CCD button to enter the CCD MENU and select CLOSED CAPTION. Select the desired settings as described above.

Closed Captioning will display text on the screen for the hearing impaired.

### FAQs:

*When I press the RECALL or MUTE button, the captions do not appear, is this normal?*

Yes, this is normal for this unit. Once the display information disappears, the captions will continue.

*I entered the Captions mode, but no captions are appearing, why?*

If no caption signal is received, no captions will appear, but the television will remain in the Caption mode.

*Why is there a big black box on the screen?*

Because you are in a Captions mode. Turn the captions off, or select a different Captions mode.

## ON-SCREEN CONTROL ADJUSTMENTS (PICTURE)

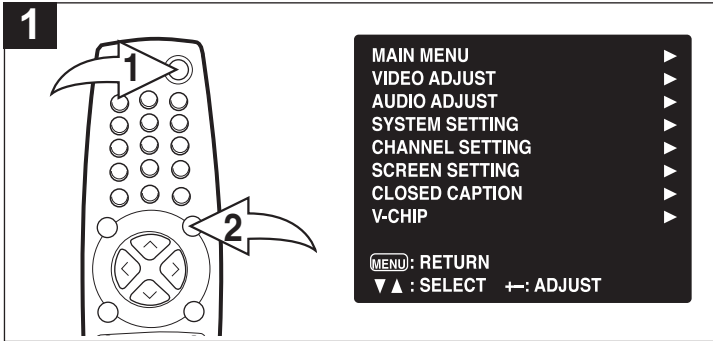

Press the POWER button **1** to turn on the TV; the POWER indicator will light green. Press the MENU button **2**; the MENU screen will appear.

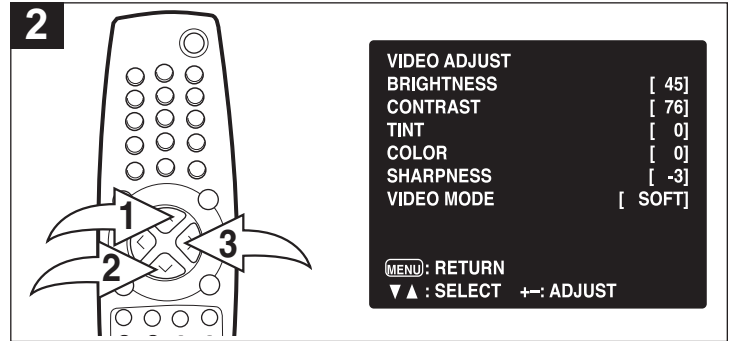

Press the CHANNEL UP **1** or DOWN **2** button until VIDEO ADJUST is selected, then press the VOLUME UP button **3** to select it. Press the CHANNEL UP **1** or DOWN **2** button until VIDEO MODE is selected.

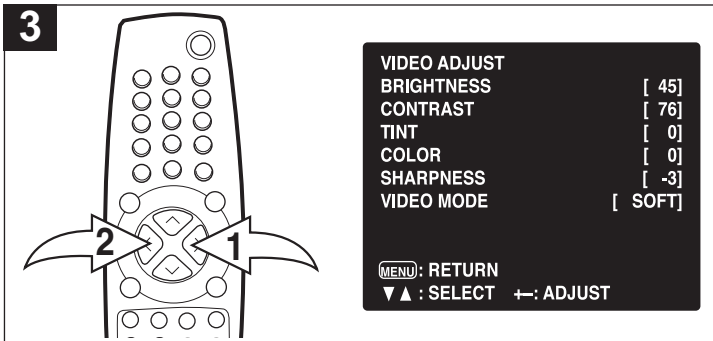

Using the VOLUME UP **1** or DOWN **2** button, select SOFT or PRESET to access the preset settings. Select USER if you want to customize and save your own settings for future use.

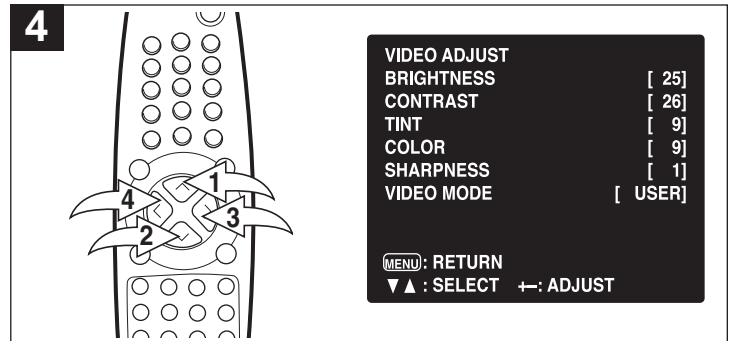

Press the CHANNEL UP **1** or DOWN **2** button until one of the settings (BRIGHTNESS/CONTRAST/TINT/COLOR or SHARPNESS) is selected. Using the VOLUME UP **3** or DOWN **4** button, adjust the desired setting.

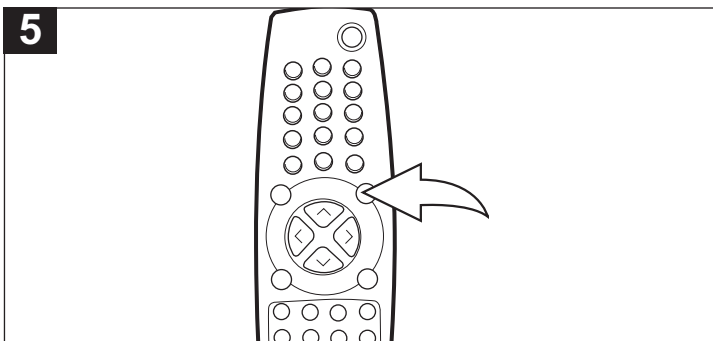

Press the MENU button once when finished to return to the Main menu. Press the MENU button again to exit the Main menu. If no button pressed for 15 seconds, the menu will disappear automatically. The TV will then stay on for the selected time, and then shut off automatically.

## ON-SCREEN CONTROL ADJUSTMENTS (SOUND)

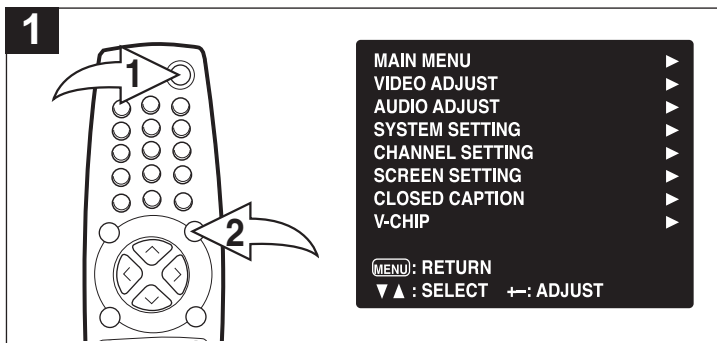

Press the POWER button ① to turn on the TV; the POWER indicator will light green. Press the MENU button ②; the MENU screen will appear.

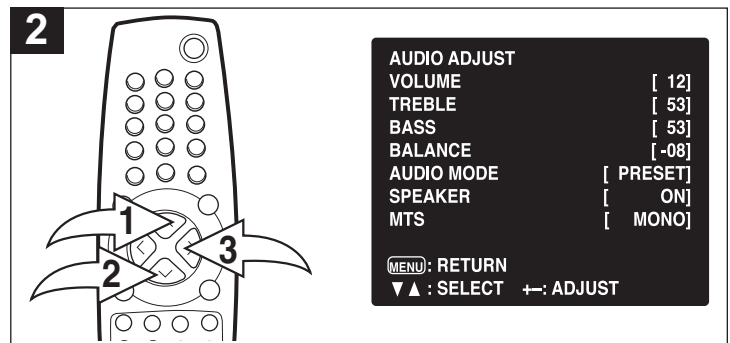

Press the CHANNEL UP ① or DOWN ② button until AUDIO ADJUST is selected, then press the VOLUME UP button ③ to select it. Press the CHANNEL UP ① or DOWN ② button until AUDIO MODE is selected.

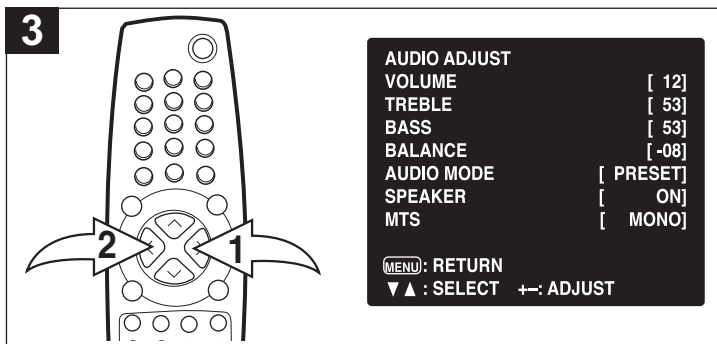

Using the VOLUME UP ① or DOWN ② button, select SOFT or PRESET to access the preset settings. Select USER if you want to customize and save your own settings for future use.

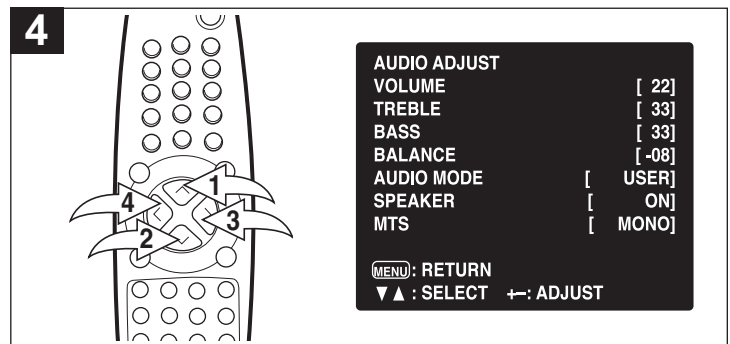

Press the CHANNEL UP ① or DOWN ② button until one of the settings (VOLUME, TREBLE, BASS or BALANCE) is selected. Using the VOLUME UP ③ or DOWN ④ button, adjust the desired setting.

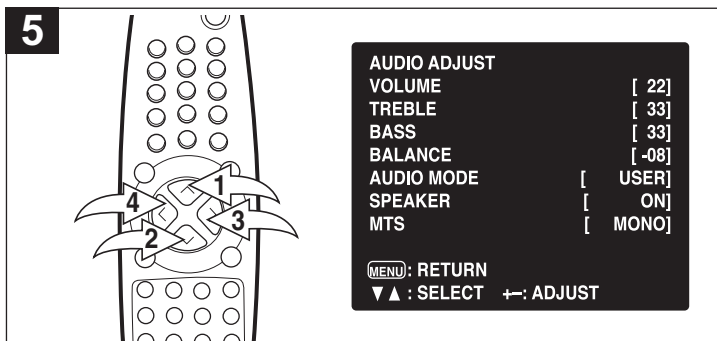

Press the CHANNEL UP ① or DOWN ② button until MTS is selected. Using the VOLUME UP ③ or DOWN ④ button, select the MTS setting (MONO or STEREO).

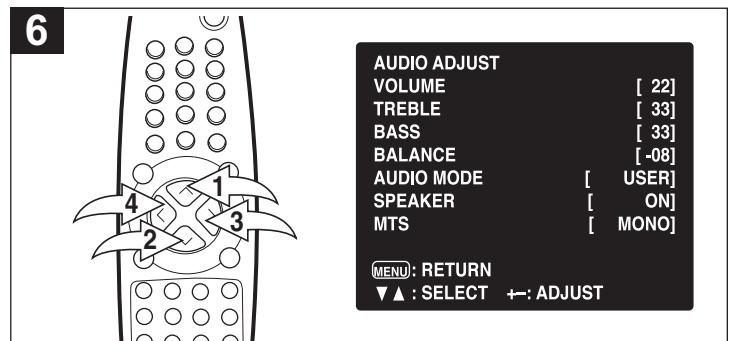

Press the CHANNEL UP ① or DOWN ② button until SPEAKER is selected. Using the VOLUME UP ③ or DOWN ④ button, turn this setting ON or OFF. Turn off if you want to use the external AUDIO OUT jacks on the rear of the set and mute the TV's built-in speakers.

# SCREEN SETTINGS

**1**

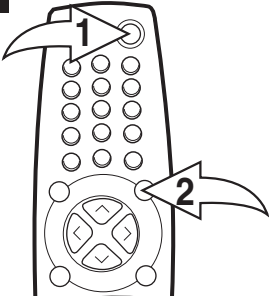

MAIN MENU	▶
VIDEO ADJUST	▶
AUDIO ADJUST	▶
SYSTEM SETTING	▶
CHANNEL SETTING	▶
SCREEN SETTING	▶
CLOSED CAPTION	▶
V-CHIP	▶

MENU: RETURN  
▼▲: SELECT    + -: ADJUST

Press the POWER button ① to turn on the TV; the POWER indicator will light green. Press the MENU button ②; the MENU screen will appear.

**2**

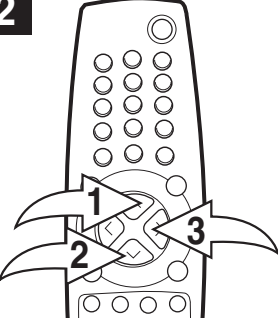

SCREEN SETTING	
PIP	[OFF]
PIP POSITION	[1]
SOURCE	[ PC]
POP	[OFF]
SWAP	[OFF]
SCREEN MODE	[FULL]

MENU: RETURN  
▼▲: SELECT    + -: ADJUST

Press the CHANNEL UP ① or DOWN ② button until SCREEN SETTING is selected, then press the VOLUME UP button ③ to select it. Press the CHANNEL UP ① or DOWN ② button until PIP (picture in picture) is selected.

**3**

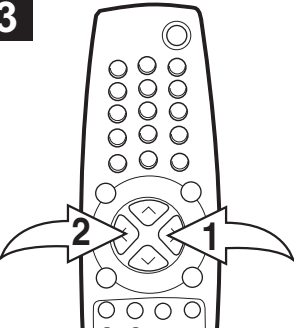

SCREEN SETTING	
PIP	[ON]
PIP POSITION	[1]
SOURCE	[ PC]
POP	[OFF]
SWAP	[OFF]
SCREEN MODE	[FULL]

MENU: RETURN  
▼▲: SELECT    + -: ADJUST

Turn this option ON or OFF using the VOLUME UP ① or DOWN ② button. If set to ON, the TV will show the picture in picture.

**4**

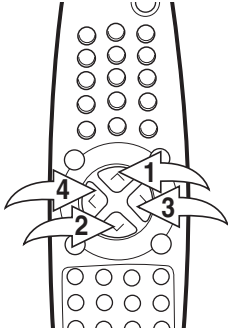

SCREEN SETTING	
PIP	[ON]
PIP POSITION	[1]
SOURCE	[ PC]
POP	[OFF]
SWAP	[OFF]
SCREEN MODE	[FULL]

MENU: RETURN  
▼▲: SELECT    + -: ADJUST

Press the CHANNEL UP ① or DOWN ② button until PIP POSITION (picture in picture position) is selected. Press the VOLUME UP ③ or DOWN ④ button to set the position the PIP will appear on the screen (1 upper left; 2 upper right; 3 lower left; 4 lower right).

**5**

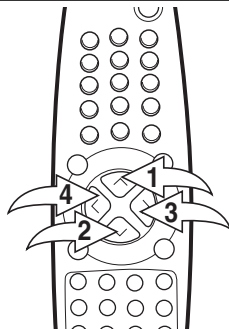

SCREEN SETTING	
PIP	[ON]
PIP POSITION	[1]
SOURCE	[ PC]
POP	[OFF]
SWAP	[OFF]
SCREEN MODE	[FULL]

MENU: RETURN  
▼▲: SELECT    + -: ADJUST

Press the CHANNEL UP ① or DOWN ② button until SOURCE is selected. Press the VOLUME UP ③ or DOWN ④ button to select the source.

**6**

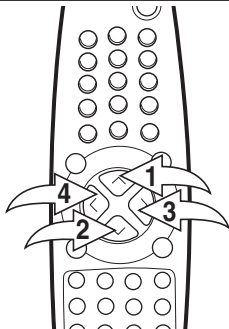

SCREEN SETTING	
PIP	[OFF]
PIP POSITION	[1]
SOURCE	[ PC]
POP	[ON]
SWAP	[OFF]
SCREEN MODE	[FULL]

MENU: RETURN  
▼▲: SELECT    + -: ADJUST

Press the CHANNEL UP ① or DOWN ② button until POP (split screen) is selected. Turn this option ON or OFF using the VOLUME UP ③ or DOWN ④ button. If set to ON, the TV will show two screens next to each other.

CONTINUED ON THE NEXT PAGE

## SCREEN SETTINGS (CONTINUED)

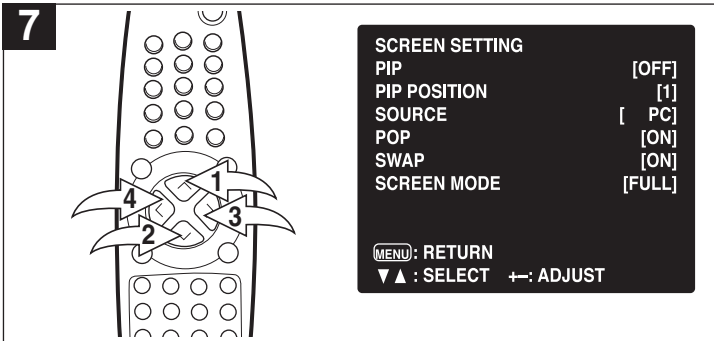

Press the CHANNEL UP **1** or DOWN **2** button until SWAP is selected. Turn this option ON or OFF using the VOLUME UP **3** or DOWN **4** button. If set to ON, the PIP/POP screens will swap.

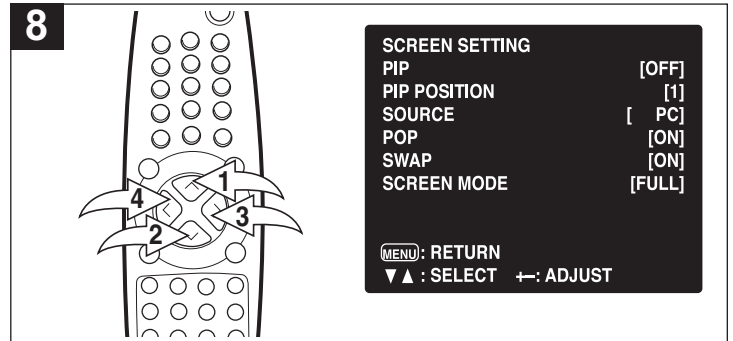

Press the CHANNEL UP **1** or DOWN **2** button until SCREEN MODE is selected. Press the VOLUME UP **3** or DOWN **4** button to select one of the screen modes as follows:

FULL: The image will stretch to cover the full screen; use this MODE when viewing wide-screen programming material.

M1: The image will increase slightly over the standard size.

M2: The image will increase slightly over M1.

M3: The image will increase slightly over M2.

M4: The image will increase slightly over M3.

4:3: The image will be the standard viewing size.

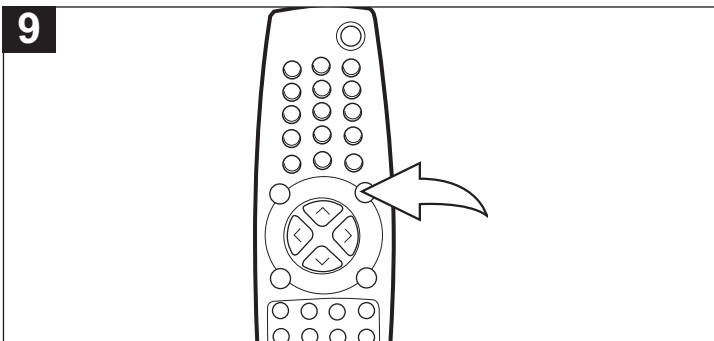

Press the MENU button once when finished to return to the Main menu. Press the MENU button again to exit the Main menu. If no button pressed for 15 seconds, the menu will disappear automatically.

**NOTE:** For the PIP or POP function, one of the pictures must be in the HDTV-YPbPr or PC MODE and the other must be in the TV, AV, S-VIDEO or COMPONENT mode, otherwise the PIP/POP function will not operate.



## SETTING V-CHIP

V-Chip enables parents to prevent their children from watching inappropriate material on TV. V-Chip reads the ratings for programming (except for news, sports, unedited movies on premium cable and Emergency System signals), then denies access to programming if the program's rating meets the limitations you select. In this case, the program will be blocked.

### V-CHIP SET-UP

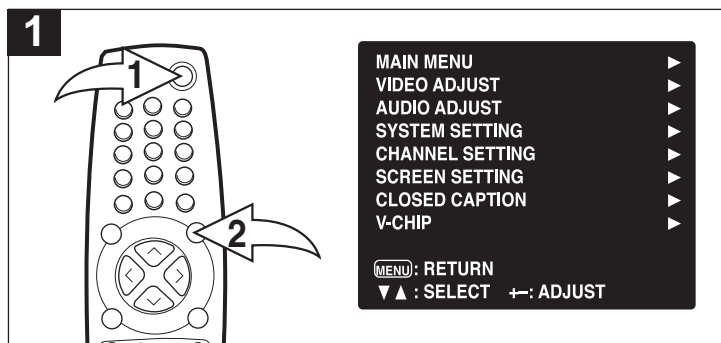

Press the POWER button ❶ to turn on the TV; the POWER indicator will light green. Press the MENU button ❷; the MENU screen will appear.

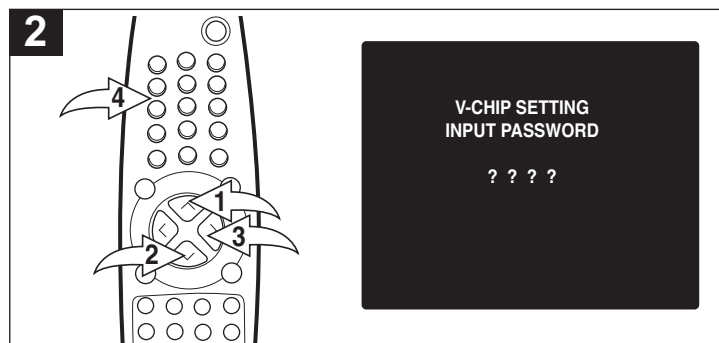

Press the CHANNEL UP ❶ or DOWN ❷ button until V-CHIP is selected, then press the VOLUME UP button ❸ to select it. Using the Direct Channel Selection buttons (0-9) ❹, enter the password ("0000" is the preset password if you have not changed it). This password can be changed to consist of different numbers (i.e. 1467, 3732) after the original password is entered.

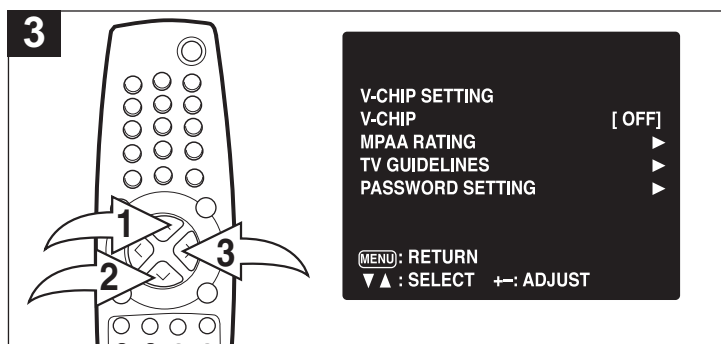

Once in the V-CHIP MENU, press the CHANNEL UP ❶ or DOWN ❷ button until V-CHIP is selected, then press the VOLUME UP button ❸ to turn the V-Chip ON. Then change the settings as per the next two pages.

# SETTING PARENTAL CONTROL (CONTINUED)

## MPAA RATING SET-UP

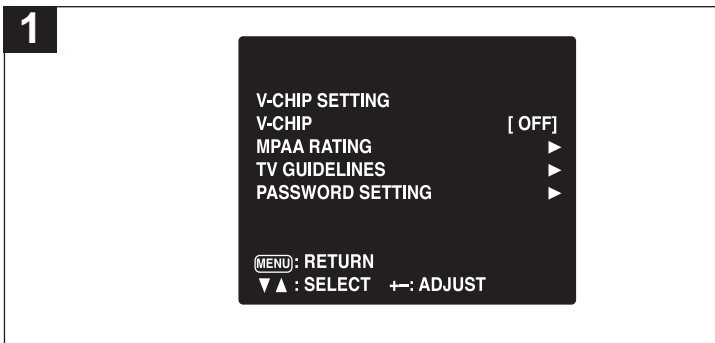

Enter the V-CHIP menu screen as described on page 32.

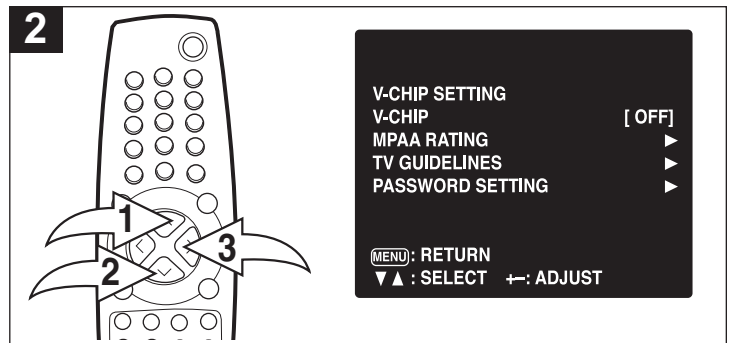

Press the CHANNEL UP **1** or DOWN **2** button until MPAA RATING is selected, then press the VOLUME UP button **3** to select it.

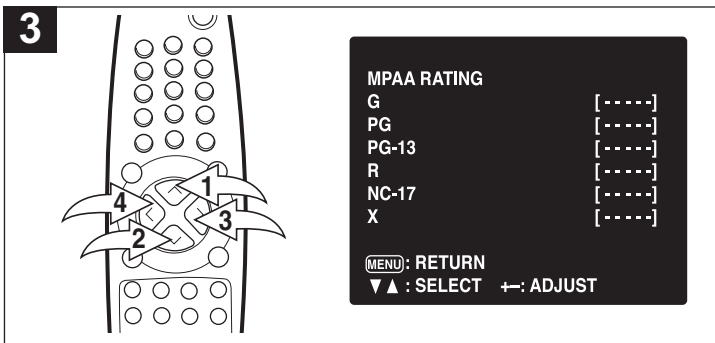

Press the CHANNEL UP **1** or DOWN **2** button to select a rating, then press the the VOLUME UP **3** or DOWN **4** button to block (see below).

- |  |                                      |
|--|--------------------------------------|
| <b>G:</b> All ages.  | <b>NC17:</b> 17 years old and above. |
| <b>PG:</b> Parental Guidance.                              |                                      |
| <b>PG-13:</b> Parental Guidance, less than 13 years old.   | <b>X:</b> Adult only.                |
| <b>R:</b> Under 17 years old, Parental Guidance suggested. |                                      |

All programs with a higher rating than the one selected will also be blocked.

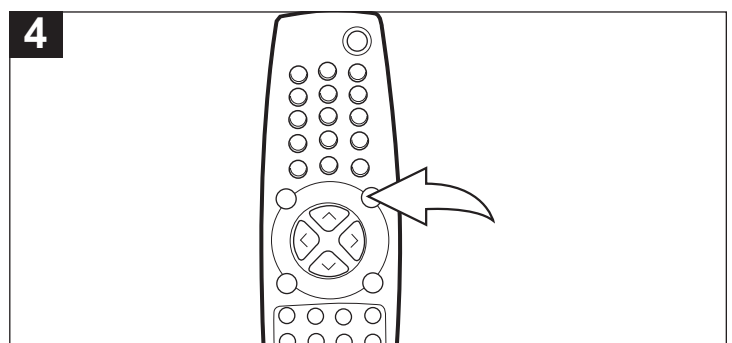

Press the MENU button once when finished to return to the Main menu. Press the MENU button again to exit the Main menu. If no button pressed for 15 seconds, the menu will disappear automatically. The TV will then stay on for the selected time, and then shut off automatically.

# SETTING PARENTAL CONTROL (CONTINUED)

## TV RATING SET-UP

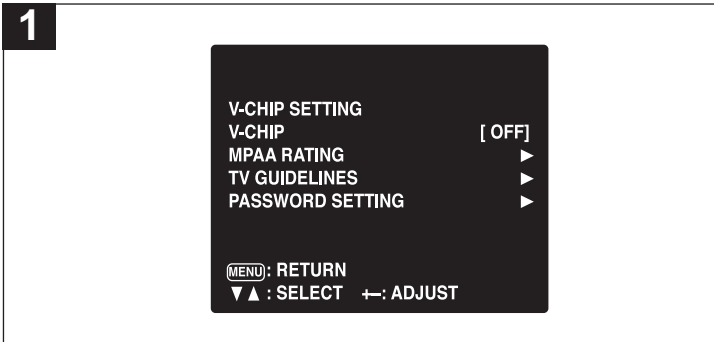

Enter the V-CHIP menu screen as described on page 32.

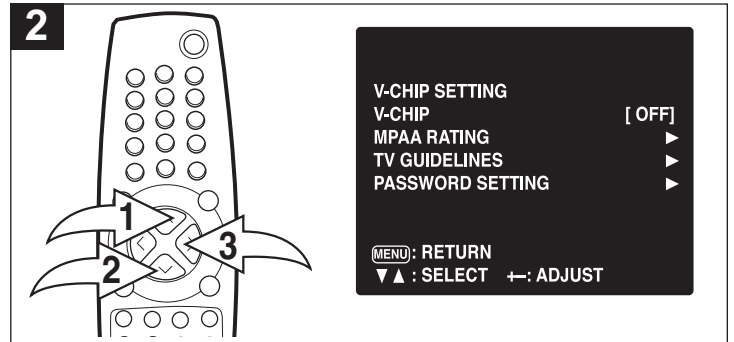

Press the CHANNEL UP **1** or DOWN **2** button until TV GUIDELINES is selected, then press the VOLUME UP button **3** to select it.

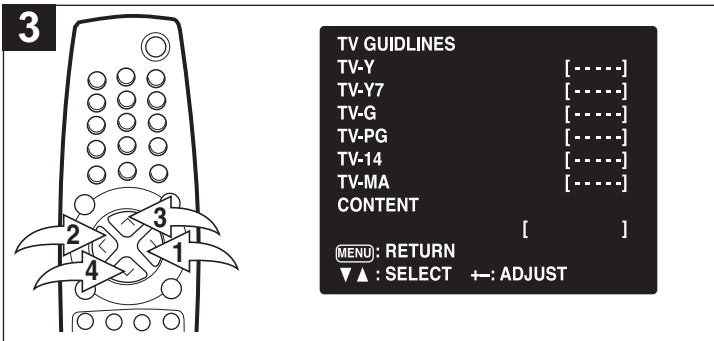

Press the CHANNEL UP **1** or DOWN **2** button to select a rating, then press the the VOLUME UP **3** or DOWN **4** button to block (see below).

<b>FV:</b>	<b>Fantasy Violence</b>	<b>S:</b>	<b>Sexual Situations</b>
<b>D:</b>	<b>Suggestive Dialogue</b>	<b>V:</b>	<b>Violence</b>
<b>L:</b>	<b>Adult Language</b>		

All programs with a higher rating than the one selected will also be blocked.

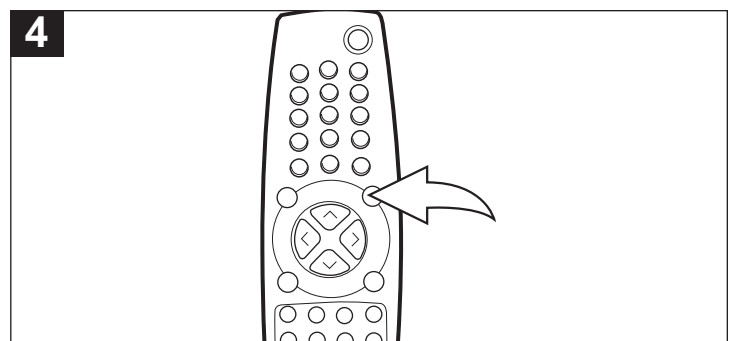

Press the MENU button once when finished to return to the Main menu. Press the MENU button again to exit the Main menu. If no button pressed for 15 seconds, the menu will disappear automatically. The TV will then stay on for the selected time, and then shut off automatically.

# SETTING PARENTAL CONTROL (CONTINUED)

## CHANGING THE PASSWORD

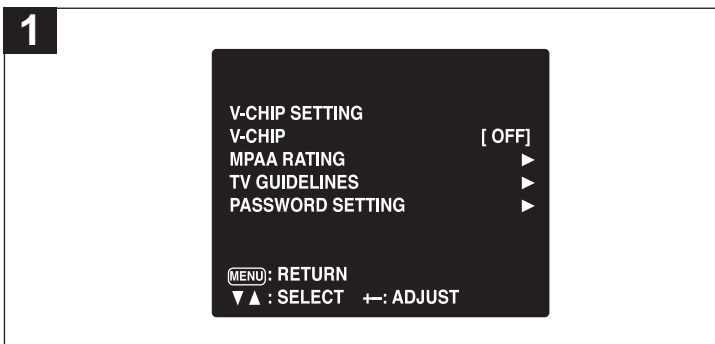

Enter the V-CHIP menu screen as described on page 32.

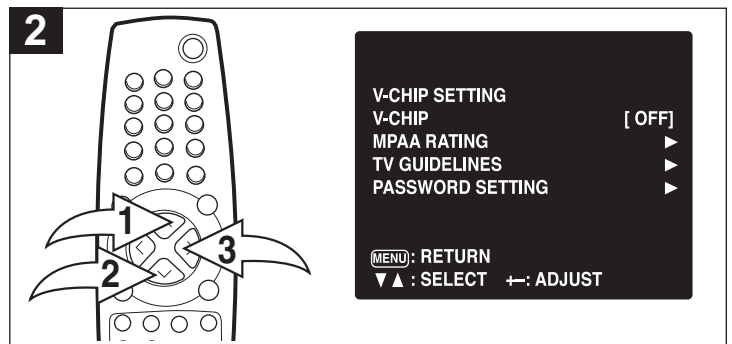

Press the CHANNEL UP **1** or DOWN **2** button until PASSWORD SETTING is selected, then press the VOLUME UP button **3** to select it.

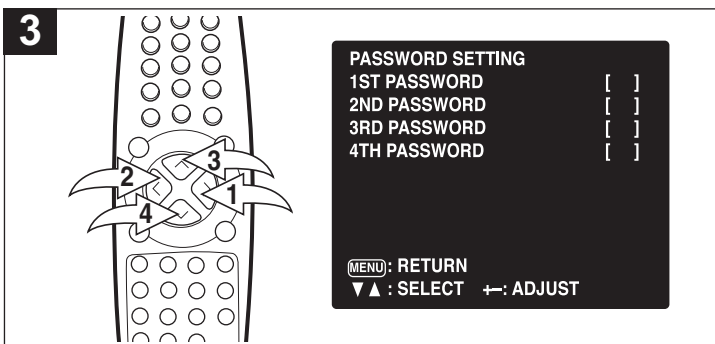

Use the VOLUME UP **1** or DOWN **2** buttons to select the first digit (0-9), then use the CHANNEL UP **3** or DOWN **4** button to select "1ST PASSWORD" to the "4TH PASSWORD".

**NOTE:** For the "1ST PASSWORD" to the "4TH PASSWORD", "1ST PASSWORD" is the left most digit, "2ND PASSWORD" is the second digit, etc.

Please make sure to write down the password in a safe place.

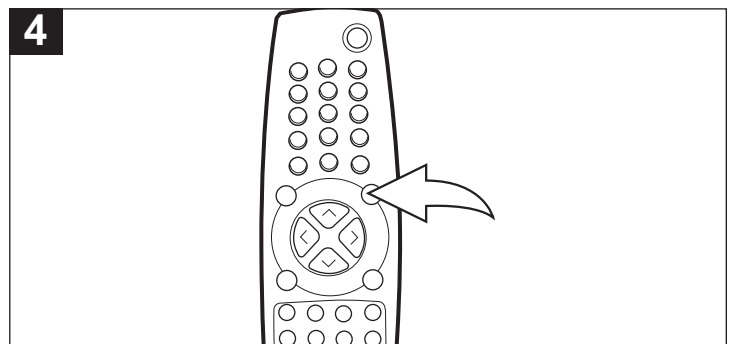

Press the MENU button once when finished to return to the Main menu. Press the MENU button again to exit the Main menu. If no button pressed for 15 seconds, the menu will disappear automatically. The TV will then stay on for the selected time, and then shut off automatically.

# SETTING THE ON TIMER

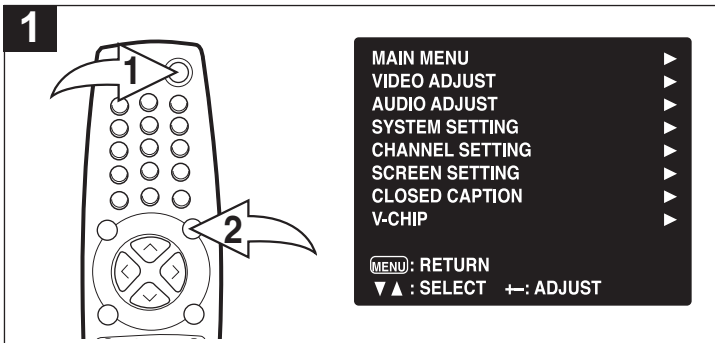

Press the POWER button ❶ to turn on the TV; the POWER indicator will light green. Press the MENU button ❷; the MENU screen will appear.

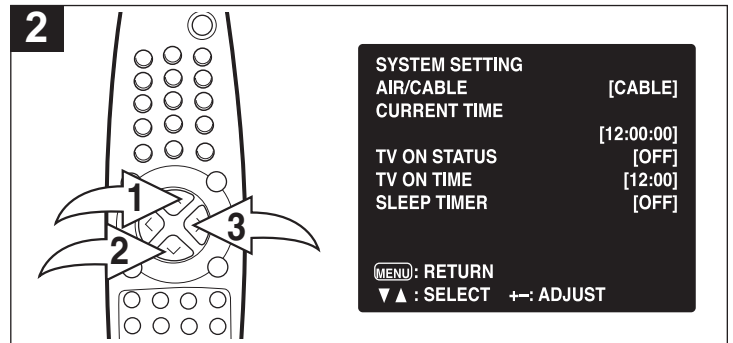

Press the CHANNEL UP ❶ or DOWN ❷ button until SYSTEM SETTING is selected, then press the VOLUME UP button ❸ to select it. Press the CHANNEL UP ❶ or DOWN ❷ button until TV ON STATUS is selected.

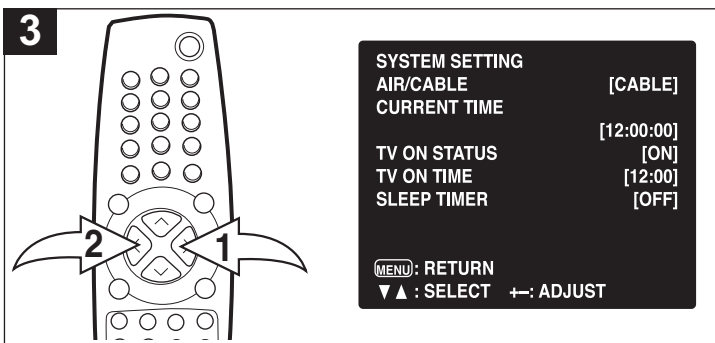

Turn this option ON or OFF using the VOLUME UP ❶ or DOWN ❷ button.

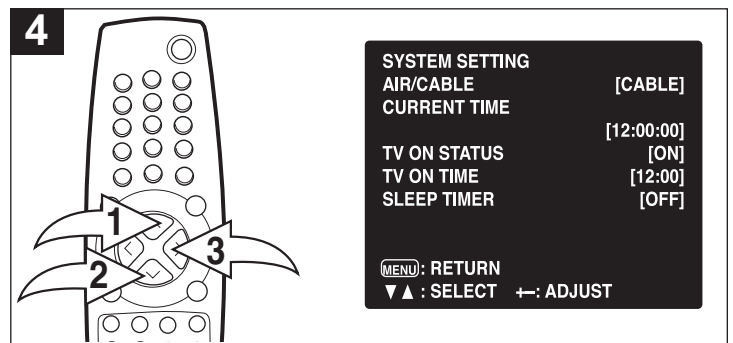

Press the CHANNEL UP ❶ or DOWN ❷ button until TV ON TIME is selected, then press the VOLUME UP button ❸ to select it.

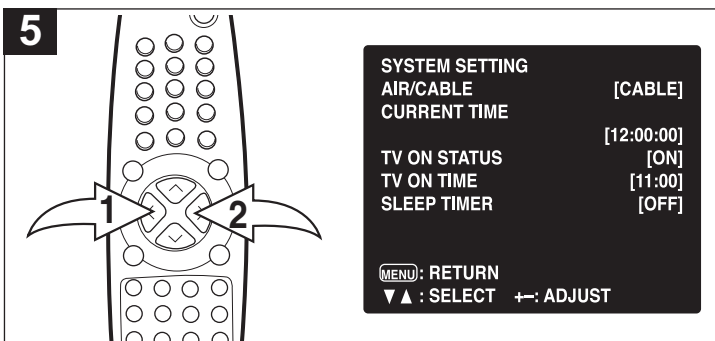

Set the hours using the VOLUME DOWN button ❶ and set the minutes using the VOLUME UP button ❷.

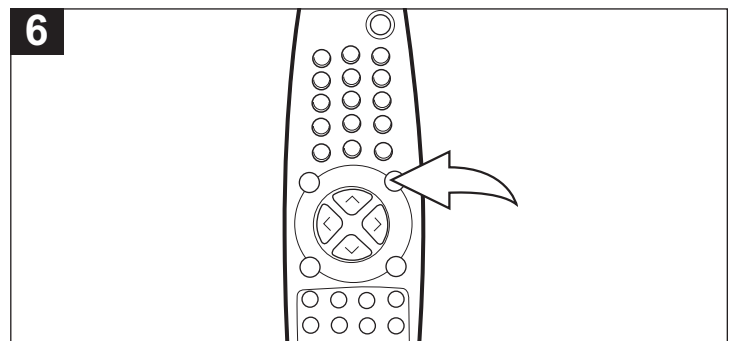

Press the MENU button once when finished to return to the Main menu. Press the MENU button again to exit the Main menu. If no button pressed for 15 seconds, the menu will disappear automatically. The TV will then stay on for the selected time, and then shut off automatically.

## FAQs:

Does the clock have to be set before using the On Timer?  
Yes, the clock must be set.

## TROUBLESHOOTING GUIDE

Check the following before requesting service:

SYMPTOM	POSSIBLE CAUSE	POSSIBLE SOLUTION
<b>POWER</b>		
No power.	The AC power cord is not connected.	Connect the AC power cord to the AC outlet.
<b>TV BROADCAST RECEPTION</b>		
Poor or no picture.	TV station experiencing problems.	Try another channel.
	Picture control is not adjusted.	Check picture control adjustments.
	Possible local interference.	Check for source of reception disturbance.
	Antenna/CATV connector is not connected.	Check CATV connection or VHF/UHF antenna.
Picture wobbles or drifts.	TV station experiencing problems.	Try another channel.
	Cable TV channel is scrambled.	A Cable box needs to be used (if desired).
	Possible local interference.	Check for source of reception disturbance.
No CATV reception.	CATV connected improperly or not connected.	Check all CATV connections.
	AIR/CABLE option set to AIR.	Set AIR/CABLE option to CABLE.
	Cable TV service interrupted.	Contact your Cable TV company.
No reception above ch13.	AIR/CABLE option set to AIR.	Set AIR/CABLE option to CABLE.
Poor or no sound.	TV station experiencing problems.	Try another channel.
	MUTE button is pressed.	Press MUTE button again.
	Possible local interference.	Check for source of reception disturbance.
	Antenna/CATV connector is not connected.	Check CATV connection or VHF/UHF antenna.
	Volume is set to minimum.	Increase volume.
TV shuts off.	TV station stopped broadcasting.	Tune to a new channel.
	Sleep Timer is set.	Set Sleep Timer to Off.
Closed Captioning not working.	TV signal is weak.	Check CATV or VHF/UHF antenna connection.
	TV station experiencing problems or program tuned is not closed captioned.	Try another channel.
	Closed Captioning not turned on.	Turn Closed Captioning on.
<b>REMOTE CONTROL</b>		
Remote control does not operate.	Distance is too far or too much light in the room.	Operate within 15 feet or reduce the light in the room.
	There is an obstacle in the path of the beam or remote is not aimed at the sensor.	Clear the path of the beam and/or aim the remote at the sensor.
	The batteries are weak or installed incorrectly.	Replace the batteries or install correctly.
<b>PARENTAL CONTROL (V-CHIP)</b>		
Parental control protection is not working properly.	V-Chip setting is turned off.	Turn V-Chip setting on.
	News or sports event being broadcast.	Parental Control does not work with news or sporting events.
	Ratings not set.	Set ratings as desired.

## RECEPTION DISTURBANCES

Most types of television interference can be remedied by adjusting the height and position of the VHF/UHF antenna. Outdoor antennas are recommended for best results if not using cable or a satellite. The most common types of television interference are shown below. If one of these symptoms appear when the TV is connected to a Cable TV system, the disturbance may be caused by the local cable company broadcast.

### IGNITION:

Black spots or horizontal streaks may appear, picture may flutter or drift. Usually caused by interference from automobile ignition systems, neon lamps, electric drills and other electric appliances.



### GHOSTS:

Ghosts are caused by the television signal following two paths. One is the direct path and the other is reflected from tall buildings, hills or other objects. Changing the direction or position of the antenna may improve the reception.

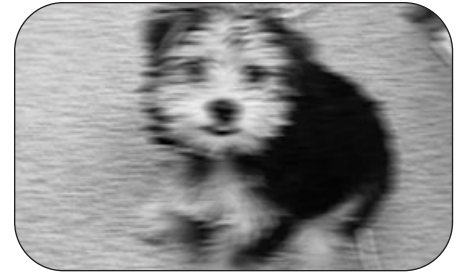

### SNOW:

If your receiver is located in the fringe area of a television station where the signal is weak, your picture may be marred by the appearance of small dots. When the signal is extremely weak, it may be necessary to install an external antenna to improve the picture.



### RADIO FREQUENCY INTERFERENCE:

This interference produces moving ripples or diagonal streaks, and in some cases, causes loss of contrast in the picture.



### PICTURE SIZE VARIATION:

A slight picture size variation is quite normal when you adjust the CONTRAST or BRIGHTNESS setting.

## SPECIFICATIONS

Item	Characteristics	Specifications	
LCD Panel	Type	Super IPS/Super MVA	
	Active Display Area	643.2 (H) * 385.92(V)mm (29.6" diagonal)	
	Pixel Pitch	0.1675mm*0.5025mm*RGB	
	Max.Resolution	WXGA 1280*768	
	Contrast Ratio	500:1(Typical)	
	Brightness	500 cd/m2(Typical)	
	Response Time	25ms	
	Display Color	16.7M colors	
	Viewing Angle	85 <sub>i</sub> (L) / 85 <sub>i</sub> (R) / 85 <sub>i</sub> (U) / 85 <sub>i</sub> (D)	
	Back Light	16 CCFL	
	Lamp Life	50000hrs	
	TV System	Color System	NTSC
		Sound System	M
Stereo System		BTSC	
Channel System		USA	
TV Tuner System		PLL,55.25MHz-801.25MHz	
CATV		PLL,55.25MHz-801.25MHz	
Subtitles		Closed Caption,V-Chip	
TV Performance		3D Motion Adaptive De-interlace, Film Mode Detection, 3D Comb Filter, 3D Noise Reduction Sharpness(DCTI,DLTI),PIP,Duel Picture,Channel Scan,Wide Mode,Favorite Channel, Surround Sound,Audio AI,	
Video System	Video Signal	Y:1Vp-p(with Sync.),C:0.286Vp-p,Impedance:75ohms	
	Video Color System	NTSC,PAL,SECAM	
	YUV Color System	480i,480p,1080i,720p	
Monitor System	VGA signal	RGB 0.7Vp-p signal,Sync.TTL(input) Separate	
	Frequency Range	Horizontal 30KHz to 70KHz,Vertical 50Hz to 85Hz	
	Display Mode	VGA 640*350(70Hz)	
		VGA 640*480(50/60/66/70/72/75/85Hz)	
		VGA 720*350(70Hz)	
		VGA720x400(70Hz)	
		SVGA(56/60/72/75/85HZ)	
		MAC 832X624(75HZ)	
		XGA 1024*768(60/70/75/85Hz)	
		SXGA 1280*1024(60/75Hz)	
MAC 1152*870(75Hz)			



## SPECIFICATIONS (CONTINUED)

Audio System	3D Surround	Yes
	Amplifier	4W(10% THD max.)
	Speaker	10W
Terminals	AV1	RCA for CVBS,Audio R/L
	S	S Din for S-Video,Audio R/L
	COMPONENT(Y Cb Cr)	RCA for YUV and Audio R/L
	HDTV(Y Pb Pr)	RCA for YUV and Audio R/L
	PC Analog Port	D-sub 15pin VGA
	PC Stereo input	RCA,Audio R/L
	Audio Line Out	RCA,Audio R/L
OSD Language		English
Front Control		Power, Menu,Source, Channel Up/Down, Volume UP/Down
Power Supply	Input	AC 120Vrms(60 Hz)
	Max.Power Consumption	140W
	Power Saving	Less than 3W
	Dimensions	Height 22" x Width 39.2" x Depth 10.6"
	Weight	38.6 lbs

## CARE AND MAINTENANCE

To prevent fire or shock hazard, disconnect your unit from the AC power source when cleaning. The finish on the receiver may be cleaned with a dust cloth and cared for as other furniture. Use caution when cleaning and wiping the plastic parts. Mild soap and a soft, damp cloth may be used.

**FOR ADDITIONAL SET-UP OR OPERATING ASSISTANCE, PLEASE VISIT OUR WEBSITE AT**

**[WWW.MEMOREXELECTRONICS.COM](http://WWW.MEMOREXELECTRONICS.COM)**

**OR CONTACT CUSTOMER SERVICE AT 1-800-919-3647.**

**PLEASE KEEP ALL PACKAGING MATERIAL FOR AT LEAST 90 DAYS IN CASE YOU NEED TO RETURN THIS PRODUCT TO YOUR PLACE OF PURCHASE OR MEMOREX.**

**FOR PARTS AND ACCESSORIES, CONTACT FOX INTERNATIONAL AT 1-800-321-6993.**

Memcorp, Inc.  
Weston, FL  
Printed in Taiwan

Visit our website at [www.memorexelectronics.com](http://www.memorexelectronics.com)

## Free Manuals Download Website

<http://myh66.com>

<http://usermanuals.us>

<http://www.somanuals.com>

<http://www.4manuals.cc>

<http://www.manual-lib.com>

<http://www.404manual.com>

<http://www.luxmanual.com>

<http://aubethermostatmanual.com>

Golf course search by state

<http://golfingnear.com>

Email search by domain

<http://emailbydomain.com>

Auto manuals search

<http://auto.somanuals.com>

TV manuals search

<http://tv.somanuals.com>