

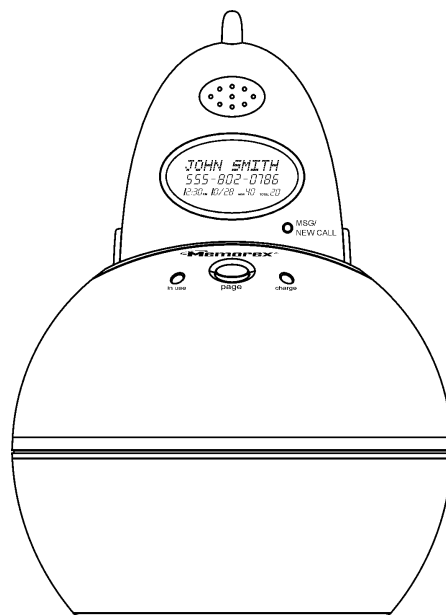

2.4GHz CORDLESS TELEPHONE

MODEL: MSP-PH2400

**BEFORE OPERATING THIS PRODUCT,
PLEASE READ THESE INSTRUCTIONS COMPLETELY.**



OPERATING INSTRUCTIONS

IMPORTANT SAFETY PRECAUTIONS



CAUTION
RISK OF ELECTRIC SHOCK
DO NOT OPEN



CAUTION: TO REDUCE THE RISK OF ELECTRIC SHOCK, DO NOT REMOVE COVER (OR BACK). NO USER-SERVICEABLE PARTS INSIDE. REFER SERVICING TO QUALIFIED SERVICE PERSONNEL.



DANGEROUS VOLTAGE:

Uninsulated Dangerous Voltage, that may be of sufficient magnitude to constitute a risk of electric shock to persons is present within this product's enclosure.



ATTENTION:

The Owner's Manual contains important operating and maintenance instructions.

For your safety, it is necessary to refer to the manual.

INSTALLATION INSTRUCTION PRECAUTIONS:

- Never install telephone wiring during a lightning storm.
- Never install telephone jacks in wet locations unless the jack is specifically designed for wet locations.
- Never touch uninsulated telephone wires or terminals unless the telephone line has been disconnected at the network interface.
- Use caution when installing or modifying telephone lines.

When using your telephone equipment, basic safety precautions must always be followed to reduce the risk of fire, electric shock and injury to persons including the following:

1. Read and understand all instructions.
2. Follow all warnings and instructions marked on this product.
3. Unplug this product from the wall outlet before cleaning. Do not use liquid cleaners or aerosol cleaners. Use a damp cloth for cleaning.
4. Do not use this product near water- for example, near a bathtub, washbowl, kitchen sink, or laundry tub, in a wet basement, or near a swimming pool.

IMPORTANT SAFETY PRECAUTIONS (CONTINUED)

5. Do not place this product on an unstable cart, stand, tripod, bracket, or table. The product may fall, causing serious injury and serious damage to the product.
6. Slots and openings in the cabinet and in the back or bottom are provided for ventilation and to ensure reliable operation of the product and to protect it from overheating. These openings must not be blocked or covered. The openings should never be blocked by placing the product on a bed, sofa, rug, or other similar surface. This product should never be placed near or over a radiator or heat source. This product should not be placed in an enclosed environment unless proper ventilation is provided.
7. Do not allow anything to rest on the power cord. Do not locate this product where the cord will be abused by persons walking on it.
8. Do not overload wall outlets and extension cords as this can result in the risk of fire or electric shock.
9. Never push objects of any kind into this product through openings as they may touch dangerous voltage points or short out parts that could result in fire or electric shock. Never spill or spray any type of liquid on the product.
10. To reduce the risk of electric shock, do not disassemble this product, but take it to a qualified serviceman when some service or repair work is required. Opening or removing covers may expose you to dangerous voltages or other risks. Incorrect re-assembly can cause electric shock when the appliance is subsequently used.
11. Unplug the product from the wall outlet and refer servicing to qualified service personnel under the following conditions:
 - a. When the power-supply cord or plug is damaged or frayed.
 - b. If liquid has been spilled into the product.
 - c. If the product has been exposed to rain or water.
 - d. If the product does not operate normally by following the operating instructions. Adjust only those controls that are covered by the operating instructions, as an adjustment of other controls may result in damage and will often require extensive work by a qualified technician to restore the product to its normal operation.
 - e. If the product has been dropped or the cabinet has been damaged.
 - f. If the product exhibits a distinct change in performance.
12. Avoid using a telephone (other than a cordless type) during an electrical storm. There may be a remote risk of electric shock from lightning.
13. Do not use the telephone to report a gas leak near the leak.

IMPORTANT SAFETY PRECAUTIONS (CONTINUED)

SAVE THESE INSTRUCTIONS

BATTERY PRECAUTIONS

To reduce the risk of fire or injury to persons, read and follow these instructions:

1. Use only the battery pack type provided with the unit.
2. Do not dispose of the battery in a fire, the cell may explode. Check with local codes for possible special disposal instructions.
3. Do not open or mutilate the battery as released electrolyte is corrosive and may cause damage to the eyes or skin. It may be toxic if swallowed.
4. Exercise care in handling the battery in order not to short the battery with conducting material such as rings, bracelets and keys. The battery or conductors may overheat and cause burns.
5. Recharge only the battery provided with or identified for use with this product. The battery may leak corrosive electrolyte or explode if it is not the correct type.
6. Do not attempt to rejuvenate the battery provided with or identified for use with this product by heating them. Sudden release of the battery electrolyte may occur causing burns or irritation to eyes or skin.
7. When inserting the battery into this product, the proper polarity or direction must be observed. Reverse insertion of the batteries can cause charging that may result in leakage or explosion.
8. Do not store this product, or the battery provided with or identified for use with this product, in a high-temperature area. Batteries that are stored in a freezer or refrigerator for the purpose of extending shelf life should be stabilized at room temperature prior to use.
9. Disconnect telephone lines before installing batteries.

FCC and Phone Company Information

Your telephone company is required by the Federal Communications Commission to allow you to connect FCC registered telephones to their lines. The FCC requires you to provide information, if requested by the local telephone company, about the connection of an FCC registered telephone to their lines. They may ask you for the FCC registration number and the ringer equivalence number (REN); both are at the bottom of the base. They may also ask for the Universal Service Order Code (USOC), which is the RJ-11C.

IMPORTANT SAFETY PRECAUTIONS (CONTINUED)

The REN is used to determine the quantity of devices which may be connected to the telephone line. Excessive REN's on the telephone line may result in the devices not ringing in response to an incoming call. In most, but not all areas, the sum of the REN's should not exceed five (5.0). To be certain of the number of devices that may be connected to the line, as determined by the total REN's, contact the telephone company to determine the maximum REN for the calling area.

Should your equipment cause trouble on your line which may harm the telephone network, the telephone company shall, where practical, notify you that temporary discontinuance of service may be required. Where prior notice is not practicable and the circumstances warrant such action, the telephone company may temporarily discontinue service immediately. In case of such temporary discontinuance, the telephone company must: (1) promptly notify you of such temporary discontinuance; (2) afford you the opportunity to correct the situation; (3) inform you of your right to bring a complaint to the Commission pursuant to procedures set forth in of Part 68 of FCC Rules and Regulations.

The telephone company may make changes in its communication facilities, equipment operations or procedures where such action is required in the operation of its business and not consistent with FCC Rules and Regulations. If these changes are expected to affect the use of performance of your telephone equipment, the telephone company must give you adequate notice in writing, to allow you to maintain uninterrupted service.

This equipment cannot be used on telephone company provided coin service. Connection to Party Line Service is subject to state tariffs.

Any changes or modifications not expressly approved by (state party responsible for compliance) can void the user's authority to operate the equipment.

CONTENTS

<p>Important Safety Precautions1</p> <p>Contents.....5</p> <p>Location of Controls6</p> <p>Installation Instructions.....7</p> <p>Installation of the Rechargeable Battery8</p> <p>Charging the Rechargeable Battery..8</p> <p>Set-Up Instructions9</p> <p>Setting the Ringer9</p> <p>Connecting the Headset9</p> <p>Setting the Language10</p> <p>Setting the First Ring Mode.....11</p> <p>Setting the Time12</p> <p>Setting the Area Code.....13</p> <p>Setting the LCD Contrast14</p> <p>Setting the PBX Number15</p> <p>Setting the PBX Mode.....16</p> <p>Setting the Pause Time.....17</p> <p>Setting the MSG (Message) Waiting18</p> <p>Setting the Auto Answer Mode.....19</p> <p>Setting the Private Ring Mode.....20</p> <p>Setting the Unavailable Ring Mode..21</p> <p>Basic Operation.....22</p> <p>Placing a Call22</p> <p>Adjusting the Volume of the Call on the Handset.....22</p> <p>Receiving a Call23</p> <p>Ending a Call.....24</p> <p>Channel Selection24</p>	<p>Using the Redial (DEL/RE-PA) Button.....24</p> <p>Out of Range Warning26</p> <p>MSG Waiting (Voice Mail Messages).....26</p> <p>Using the Base Page Button26</p> <p>Using the Flash Button.....26</p> <p>Tone/Pulse Switch26</p> <p>Using the Tone Button27</p> <p>Call Waiting27</p> <p>Checking the Caller ID Log27</p> <p>Deleting One Name/Number from the Caller ID Log28</p> <p>Deleting Name(s)/Number(s) from the Caller ID Log28</p> <p>Dialing a Number in the Caller ID Display.....29</p> <p>Adding a Directory Entry30</p> <p>Saving Caller ID Information to the Directory.....30</p> <p>Entering a Name Using the Key Buttons31</p> <p>Character Map Chart.....31</p> <p>Dialing a Number from the Directory.....32</p> <p>Preferred Calls (VIP)33</p> <p>Rejecting (Blocking) Calls (REJ) ...33</p> <p>Editing a Directory Entry34</p> <p>Deleting One Name/Number from the Directory.....35</p> <p>Troubleshooting Guide.....36</p> <p>Care and Maintenance37</p>
---	---

LOCATION OF CONTROLS

HANDSET

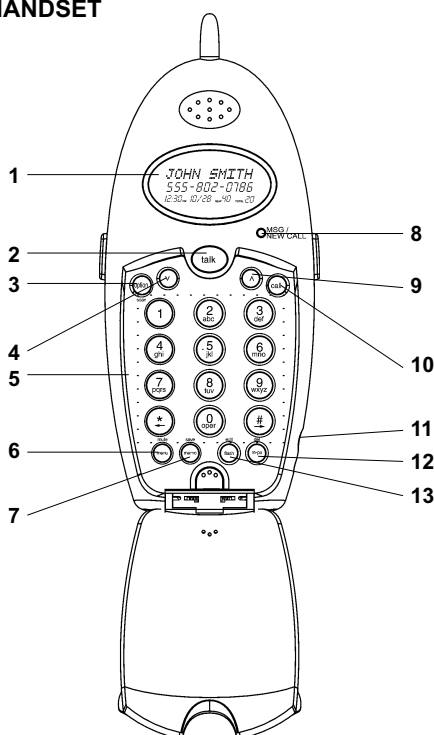

HANDSET:

1. Display
2. TALK Button
3. OPTION/SCAN Button
4. Down Button/Volume Down
5. Key Buttons (0-9, *, #)
6. MENU/MUTE Button
7. MEMO/SAVE Button
8. MSG/NEW CALL Indicator
9. Up Button/Volume Up
10. CALL Button
11. Headset Jack (Side of Unit)
12. DEL/RE-PA (Delete/Redial/ Pause) Button
13. EDIT/FLASH Button

BASE:

14. PAGE Button
15. CHARGE Indicator
16. IN USE Indicator
17. DC Input (Rear of Unit)
18. Telephone Line Jack (Rear of Unit)
19. T/P (Tone/Pulse) Switch (Bottom of Unit)

BASE

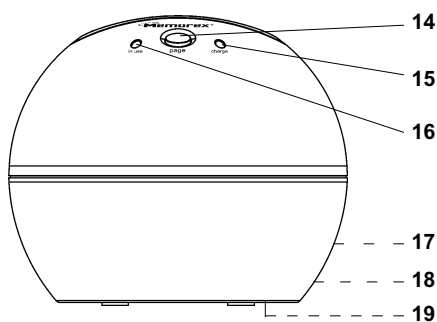

6

INSTALLATION INSTRUCTIONS

1. Carefully unpack and remove your unit from the box.
2. Make sure all the items have been included:
 - Base Unit
 - Handset Unit
 - Rechargeable Ni-Cd Battery Pack
 - AC Adapter
 - Telephone Cord
 - Belt Clip
3. Make sure the Rechargeable Battery is installed or install the Rechargeable Battery as described on the next page.

PLEASE REFER TO THE FOLLOWING DIAGRAM FOR STEPS 4 THROUGH 7:

4. Slide the T/P switch on the bottom of the Base unit to TONE or PULSE to match the service provided on your telephone line. If you are not sure of your service, please contact your telephone company. The factory preset position for this switch is TONE.

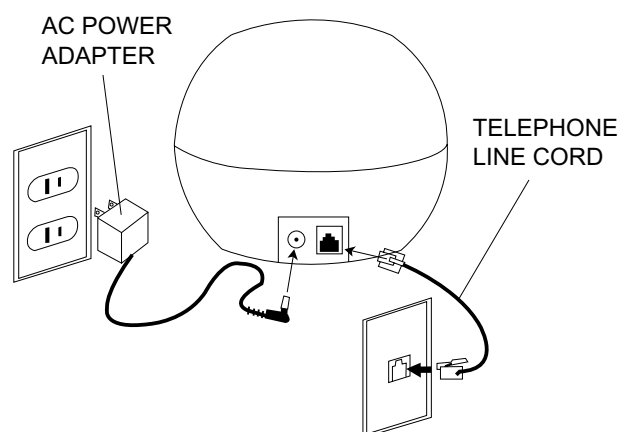

5. Connect the telephone line cord into a modular telephone jack.
6. Insert the small plug at the end of the AC adapter into the DC power jack located at the rear of the base.

NOTE: Use only the AC adapter provided with your unit.

7. Plug the AC adapter into a standard 120V AC wall outlet.

INSTALLATION INSTRUCTIONS (CONTINUED)

Installation of the Rechargeable Battery

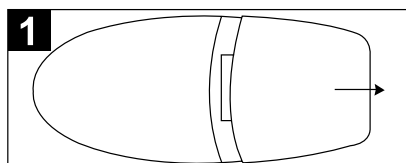

1 Remove the battery cover located on the rear of the handset by sliding it downward.

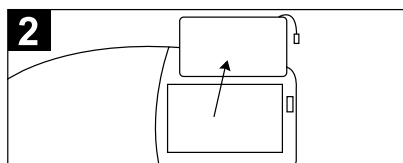

2 If replacing an old battery pack, unplug the battery connector and remove it from the battery compartment.

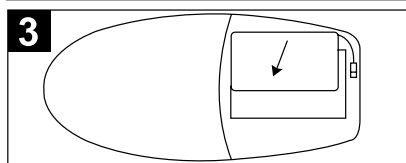

3 Plug the new battery into the rechargeable battery plug and insert the rechargeable battery into the battery compartment.

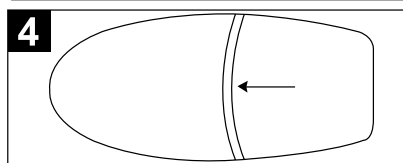

4 Put the battery cover back on by sliding it upward until it clicks in place.

Charging the Rechargeable Battery

It is recommended that the rechargeable battery be fully charged overnight prior to initial use. The handset's rechargeable battery will be charged when it's on the base's charge contacts; the CHARGE indicator will light and a beep will be heard when it is placed in the base.

LOW BATTERY will light in the display when the battery power is low and needs recharging.

NOTES:

- Every few months, or when charging becomes abnormal, clean the contacts of the handset and the base with a standard pencil eraser.
- To maximize battery life, fully discharge the battery every month or two. To do this, simply unplug the telephone line cord and press the TALK button until the battery is discharged.

SET-UP INSTRUCTIONS

SETTING THE RINGER

This will enable you to turn the ringer On or Off.

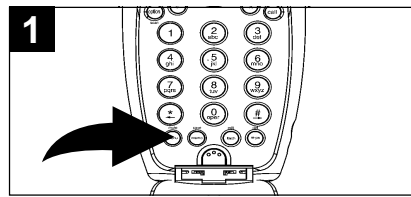

1 While in the Standby mode, press and hold the MENU/MUTE button.

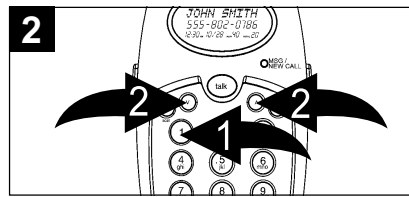

2 Press the Key button 1 ¹, or the Up/Down buttons ² to select the Ringer setting.

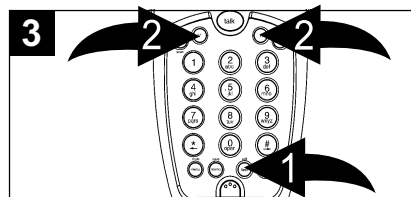

3 Press the EDIT/FLASH button ¹. Press the Up/Down buttons ² to turn this option On or Off.

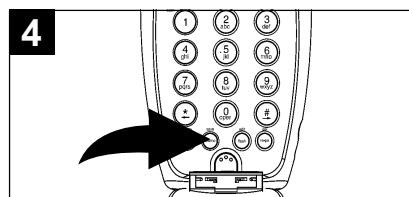

4 Press the MEMO/SAVE button when done; a confirmation tone will be heard.

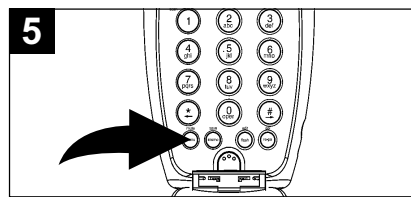

5 Press the MENU/MUTE button to exit the program mode.

CONNECTING THE HEADSET

For hands-free conversation, a headset (Not Included) can be connected to the Headset jack on the side of the unit. The handset receiver and microphone are disabled when a headset is connected. When the headset is connected, press the TALK button to answer or place a call. Refer to the headset manufacturer's manual for more details.

SET-UP INSTRUCTIONS (CONTINUED)

SETTING THE LANGUAGE

Set the language (ENGLISH, SPANISH, FRENCH) as follows:

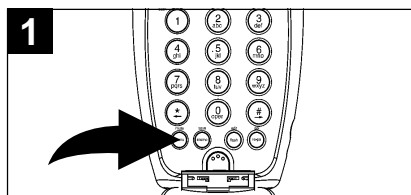

1 While in the Standby mode, press and hold the MENU/MUTE button.

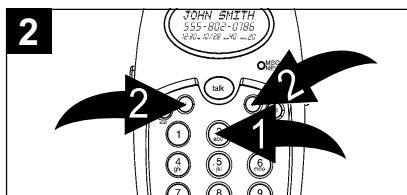

2 Press the Key button 1, or the Up/Down buttons 2 to select the Language setting.

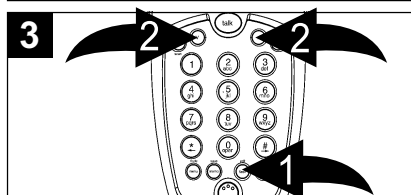

3 Press the EDIT/FLASH button 1. Press the Up/Down buttons 2 to select the desired language (ENGLISH, SPANISH, FRENCH).

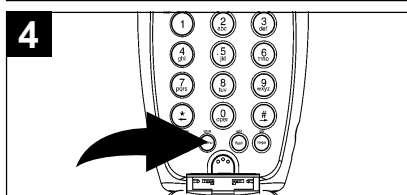

4 Press the MEMO/SAVE button when done; a confirmation tone will be heard.

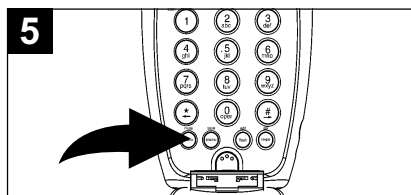

5 Press the MENU/MUTE button to exit the program mode.

SET-UP INSTRUCTIONS (CONTINUED)

SETTING THE FIRST RING MODE

You can set to turn Off the first ring of the telephone until the caller ID information has been displayed.

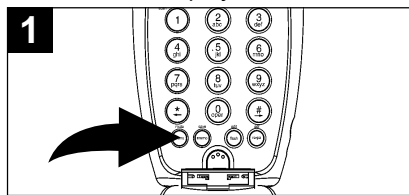

1 While in the Standby mode, press and hold the MENU/MUTE button.

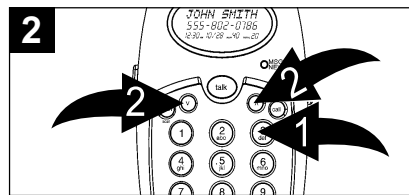

2 Press the Key button 3 **1**, or the Up/Down buttons **2** to select the First Ring mode setting.

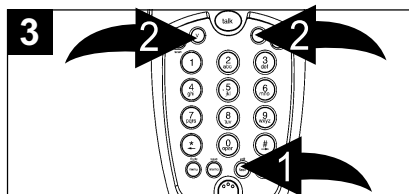

3 Press the EDIT/FLASH button **1**. Press the Up/Down buttons **2** to turn this option On or Off.

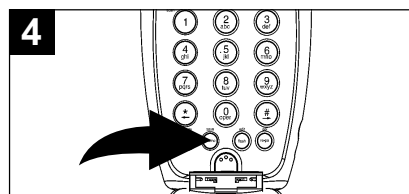

4 Press the MEMO/SAVE button when done; a confirmation tone will be heard.

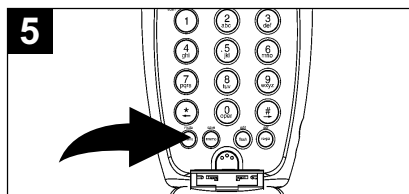

5 Press the MENU/MUTE button to exit the program mode.

SET-UP INSTRUCTIONS (CONTINUED)

SETTING THE TIME

It is necessary to set the internal clock time of the phone to display the time in the Caller ID display when incoming calls are received. **If you subscribe to Caller ID, the time and date are automatically set when the first call is received.** If the time is not automatically set, follow the steps below:

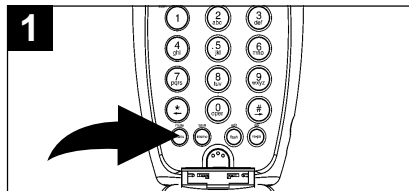

1 While in the Standby mode, press and hold the MENU/MUTE button.

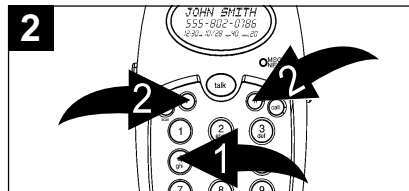

2 Press the Key button 4 **1**, or the Up/Down buttons **2** to select the Time Set setting.

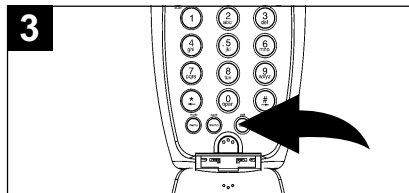

3 Press the EDIT/FLASH button.

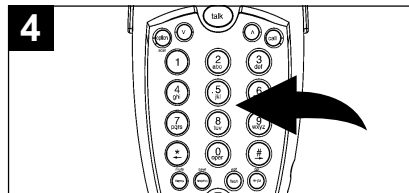

4 Using the Key buttons, enter the month, day, hour, minute and AM/PM (press key button 1 for AM, 2 for PM). The cursor will move automatically after each entry. Enter two digits for each setting, for example, for April, press 0,4.

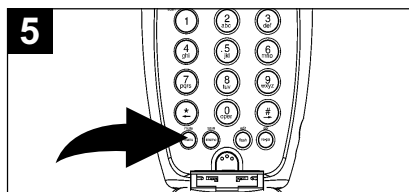

5 Press the MENU/MUTE button to exit the program mode.

SET-UP INSTRUCTIONS (CONTINUED)

SETTING THE AREA CODE

Set the phone to your local area code as described below. If you live in a town with more than one area code, do not enter an area code for this option.

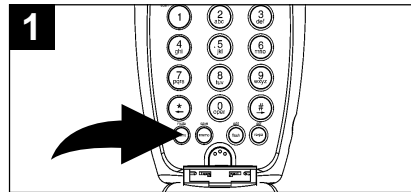

1 While in the Standby mode, press and hold the MENU/MUTE button.

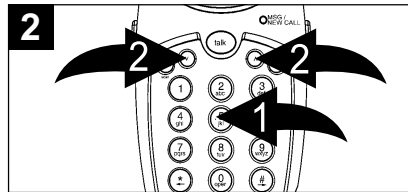

2 Press the Key button 5 **1**, or the Up/Down buttons **2** to select the Area Code setting.

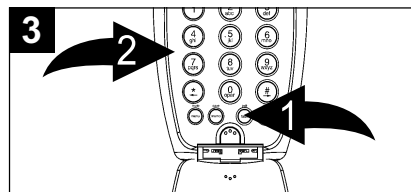

3 Press the EDIT/FLASH button **1**. Press the Key buttons **2** to enter the area code you are in.

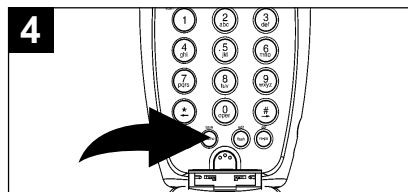

4 Press the MEMO/SAVE button when done; a confirmation tone will be heard.

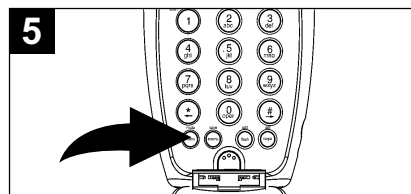

5 Press the MENU/MUTE button to exit the program mode.

SET-UP INSTRUCTIONS (CONTINUED)

SETTING THE LCD CONTRAST

There are three contrast levels for this telephone. Set the level as follows:

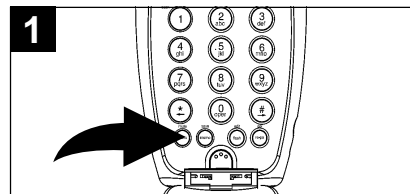

1 While in the Standby mode, press and hold the MENU/MUTE button.

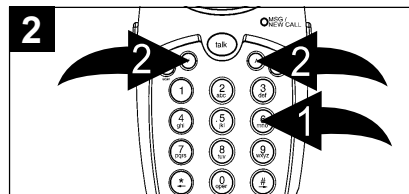

2 Press the Key button 6 ¹, or the Up/Down buttons ² to select the LCD Contrast setting.

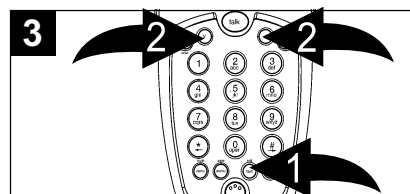

3 Press the EDIT/FLASH button ¹. Press the Up/Down buttons ² to select one of the three contrast levels (3 being the darkest, 1 being the lightest).

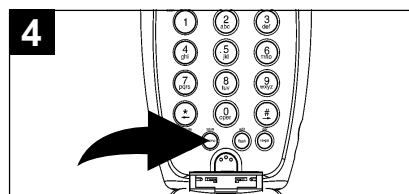

4 Press the MEMO/SAVE button when done; a confirmation tone will be heard.

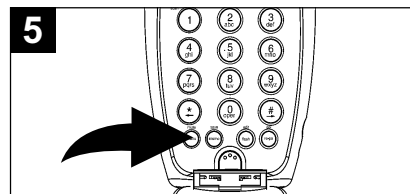

5 Press the MENU/MUTE button to exit the program mode.

SET-UP INSTRUCTIONS (CONTINUED)

SETTING THE PBX NUMBER

This telephone enables you to preset the PBX number (such as 8 or 9), while you are using a switchboard system.

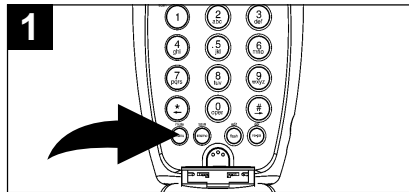

1 While in the Standby mode, press and hold the MENU/MUTE button.

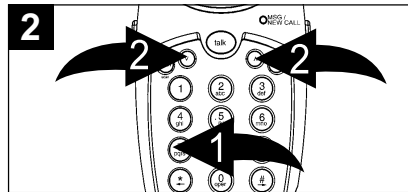

2 Press the Key button 7 ¹, or the Up/Down buttons ² to select the PBX Number setting.

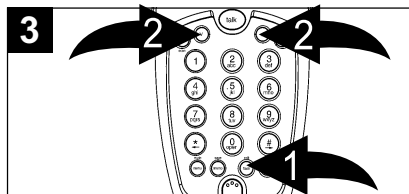

3 Press the EDIT/FLASH button ¹. Press the Up/Down buttons ² to select the PBX number. The PBX number is the number used to "get an outside line".

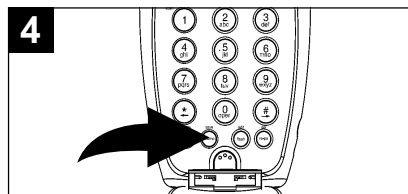

4 Press the MEMO/SAVE button when done; a confirmation tone will be heard.

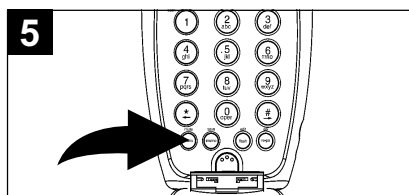

5 Press the MENU/MUTE button to exit the program mode.

SET-UP INSTRUCTIONS (CONTINUED)

SETTING THE PBX MODE

This telephone enables you to turn the PBX system On or Off, depending on the telephone system being used.

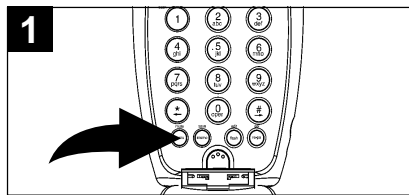

1 While in the Standby mode, press and hold the MENU/MUTE button.

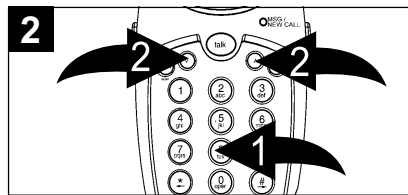

2 Press the Key button 8 ¹, or the Up/Down buttons ² to select the PBX Mode setting.

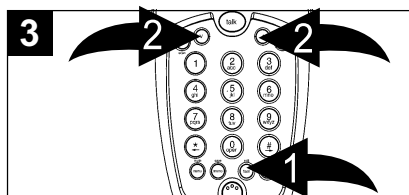

3 Press the EDIT/FLASH button ¹. Press the Up/Down buttons ² to select the desired setting:
PBX MODE OFF: Set for direct line access.
PBX MODE ON: Set if connected to a switchboard system.

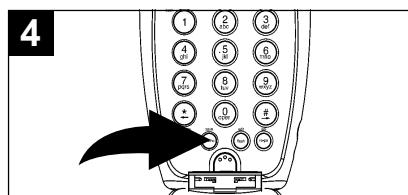

4 Press the MEMO/SAVE button when done; a confirmation tone will be heard.

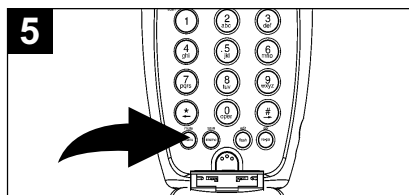

5 Press the MENU/MUTE button to exit the program mode.

SET-UP INSTRUCTIONS (CONTINUED)

SETTING THE PAUSE TIME

This telephone enables you to adjust the pause time when placing a call using a switchboard system or dialing long distance calls .

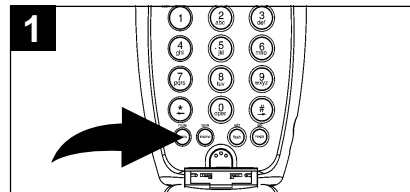

1 While in the Standby mode, press and hold the MENU/MUTE button.

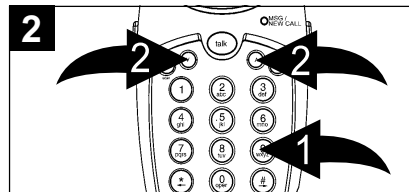

2 Press the Key button 9 ¹, or the Up/Down buttons ² to select the Pause Time setting.

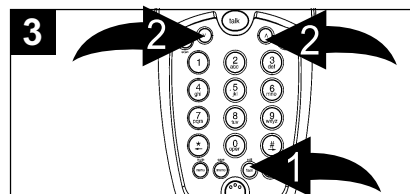

3 Press the EDIT/FLASH button ¹. Press the Up/Down buttons ² to adjust the pause time.

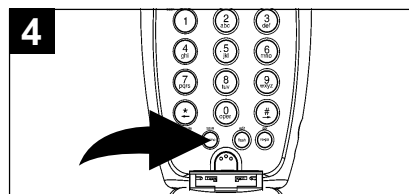

4 Press the MEMO/SAVE button when done; a confirmation tone will be heard.

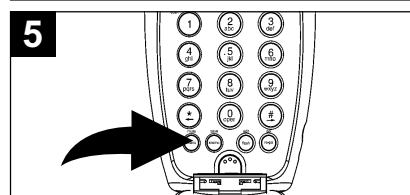

5 Press the MENU/MUTE button to exit the program mode.

SET-UP INSTRUCTIONS (CONTINUED)

SETTING THE MSG (MESSAGE) WAITING

This will enable to you to turn off the Message Waiting Indicator.

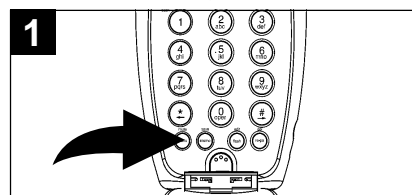

While in the Standby mode, press and hold the MENU/MUTE button.

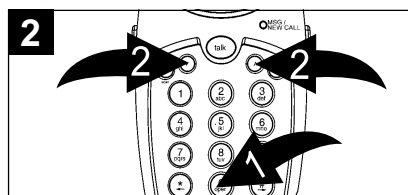

Press the Key button 0 ¹, or the Up/Down buttons ² to select the MSG Waiting setting.

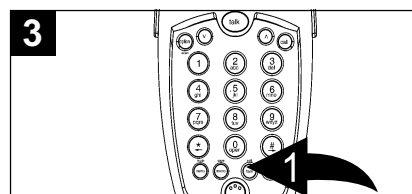

Press the EDIT/FLASH button ¹.

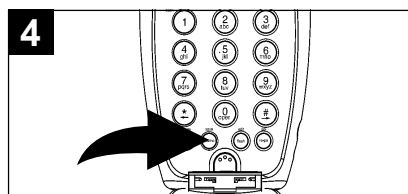

Press the MEMO/SAVE button; the message Waiting Indicator will turn off.

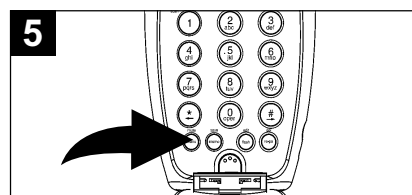

Press the MENU/MUTE button to exit the program mode.

NOTE:

Message Waiting Indicator will automatically turn on if you have subscribed to Voice Mail message service and if you have Visual Message indication from your telephone company.

SET-UP INSTRUCTIONS (CONTINUED)

SETTING THE AUTO ANSWER MODE

This will enable you to turn the auto answer On or Off. In On mode, the telephone will automatically answer an incoming call when the handset is lifted from the base .

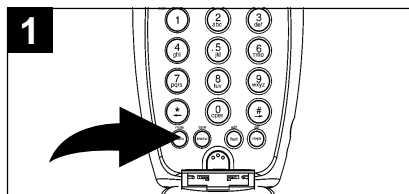

While in the Standby mode, press and hold the MENU/MUTE button.

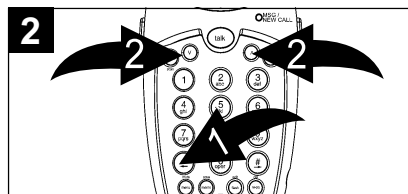

Press the Key button * **1**, or the Up/Down buttons **2** to select the Auto Answer mode setting.

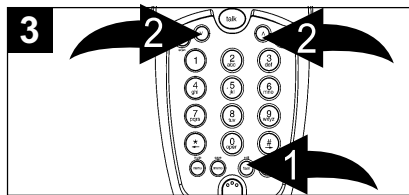

Press the EDIT/FLASH button **1**. Press the Up/Down buttons **2** to turn this option On or Off.

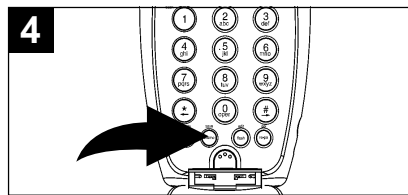

Press the MEMO/SAVE button when done; a confirmation tone will be heard.

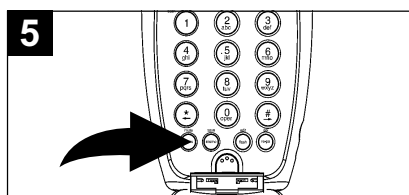

Press the MENU/MUTE button to exit the program mode.

SET-UP INSTRUCTIONS (CONTINUED)

SETTING THE PRIVATE RING MODE

You can set to turn On or Off the ring for all calls with blocked Caller ID.

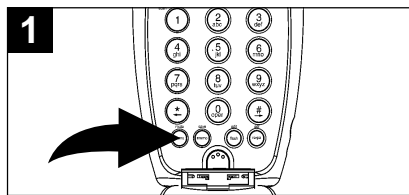

1 While in the Standby mode, press and hold the MENU/MUTE button.

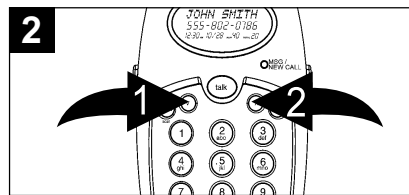

2 Press the Down button twice ①, or the Up/Down buttons ② ① to select the Private Ring mode setting.

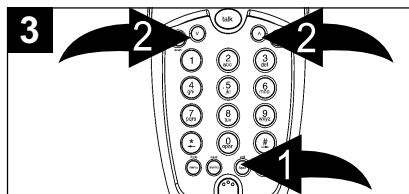

3 Press the EDIT/FLASH button ①. Press the Up/Down buttons ② to turn this option On or Off.

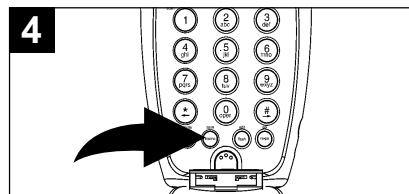

4 Press the MEMO/SAVE button when done; a confirmation tone will be heard.

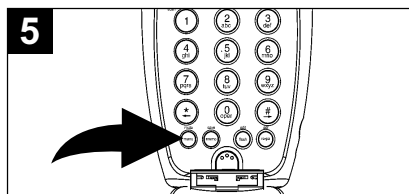

5 Press the MENU/MUTE button to exit the program mode.

SET-UP INSTRUCTIONS (CONTINUED)

SETTING THE UNAVAILABLE RING MODE

You can set to turn On or Off the ring for all calls with unavailable Caller ID information.

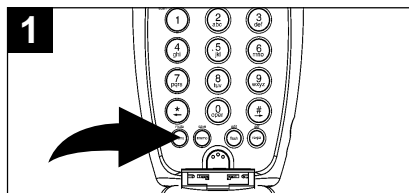

While in the Standby mode, press and hold the MENU/MUTE button.

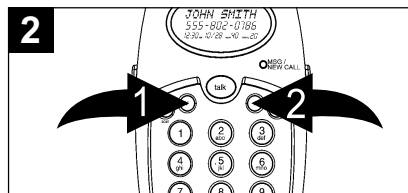

Press the Down button once **1**, or the Up/Down buttons **2 1** to select the Unavailable Ring mode setting.

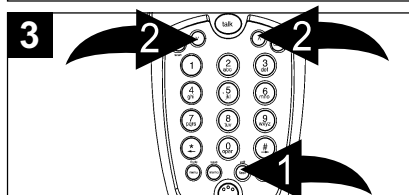

Press the EDIT/FLASH button **1**. Press the Up/Down buttons **2** to turn this option On or Off.

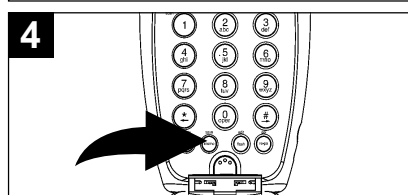

Press the MEMO/SAVE button when done; a confirmation tone will be heard.

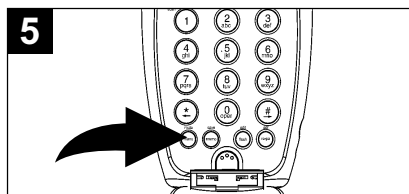

Press the MENU/MUTE button to exit the program mode.

BASIC OPERATION

PLACING A CALL

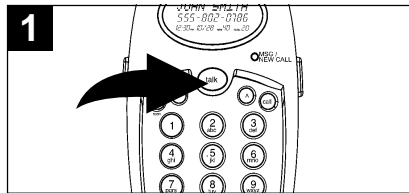

1 After the battery has been fully charged, press the TALK button and listen for a dial tone; the IN USE indicator on the base will light and "TALK" as well as the timer will appear on the display.

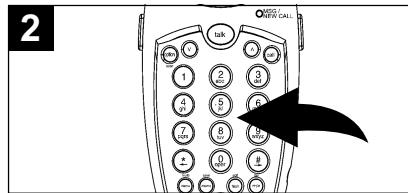

2 Press the Key buttons (0-9) to dial the phone number you wish to call. The display will show the amount of time you have been on the phone.

ADJUSTING THE VOLUME OF THE CALL ON THE HANDSET

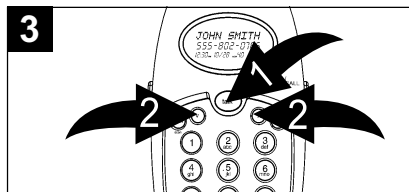

3 Press the TALK button **1**, followed by the Up/Down buttons **2** to either increase or decrease the handset volume. There are three volume levels: NORMAL, MID and HI as indicated on the display.

BASIC OPERATION (CONTINUED)

RECEIVING A CALL

The last 40 incoming calls are saved in the Caller ID log.

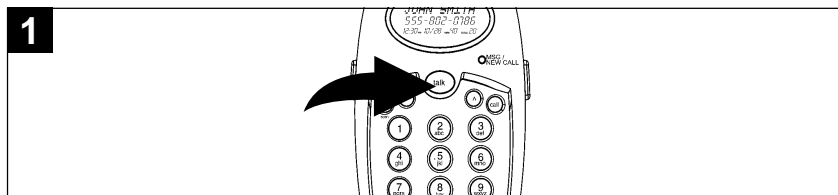

Make sure that the Caller ID service is turned on by your phone company. When you receive a call, the display will show the name of the caller, number, time and date of the call. To answer the call if the handset is out of the base, press the TALK button. If the handset is in the base, simply remove it from the base if the unit is set to auto answer On mode and if it is set to auto answer off mode, press the TALK button. The display will show the amount of time you have been on the phone.

NOTES:

- If a call is received from an area which does not provide caller ID service, the display will show, "UNAVAILABLE".
- If a call is received from a caller that has blocked his/her information, the display will show, "PRIVATE".
- When you receive the first call, the unit will automatically set the time and date.
- Calls picked up on the first ring will not be logged in the Caller ID log.
- Call Waiting calls are shown in the Caller ID log if you subscribe to the extra feature from the phone company that allows this.
- If there are new calls, "NEW" will blink in the display and the MSG/NEW CALL indicator will blink.

BASIC OPERATION (CONTINUED)

ENDING A CALL



To end a call, simply return the handset to the base, or press the TALK button on the handset; the IN USE indicator will turn off on the base and "RING: ON" will appear in the display.

CHANNEL SELECTION



This telephone allows you to select a channel from the 40 frequencies available to transmit signals from the base unit to the handset. If the existing channel becomes noisy or starts having interference while in the Talk mode, press the OPTION/SCAN button on the handset for better reception.

USING THE REDIAL (DEL/RE-PA) BUTTON

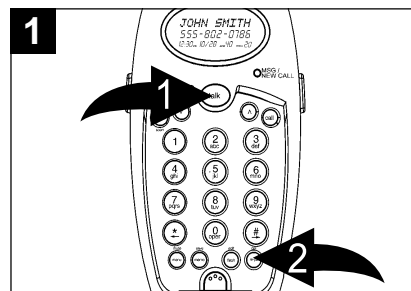

Press the TALK button **1**, followed by the DEL/RE-PA button **2** to automatically redial the last number dialed on this handset.

NOTE: Please note that only the last number you called on this handset can be stored in the Redial memory.



BASIC OPERATION (CONTINUED)

OUT OF RANGE WARNING

The handset and base communicate up to a maximum range. The distance can be affected by the weather, power lines or other cordless telephones.

If you move the handset too far away from the base unit, the handset will beep and the display will show, "OUT RANGE". In this case, move closer to the base unit, otherwise your call will automatically be cut off after 20 seconds.

MSG WAITING (VOICE MAIL MESSAGES)

This indicator will blink when there is a voice message, if you are subscribed to Voice Message service. MSG will also appear in the display. Contact your local phone company for details.

BASIC OPERATION (CONTINUED)

USING THE BASE PAGE BUTTON

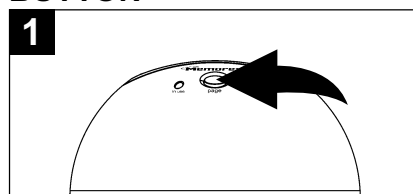

1 Press the PAGE button on the base to locate the handset when not in use; the handset will beep for 20 seconds. Press again to end the paging feature. Press the TALK button on the handset to end paging.

USING THE FLASH BUTTON

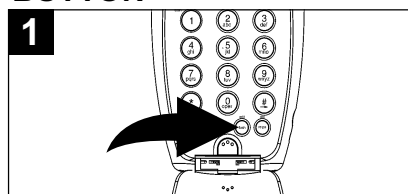

1 Press the EDIT/FLASH button to momentarily hang up. This is useful for custom calling features, such as Call Waiting or Three-Way Calling provided by your local phone company. When using for call waiting, simply press to answer the call waiting call. Press again to reconnect with the original caller.

TONE/PULSE SWITCH

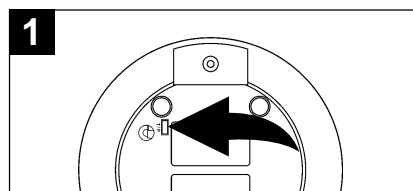

1 Slide the T/P switch to TONE or PULSE to match the service provided on your telephone line. If you are not sure of your service, please contact your telephone company. The factory preset position for this switch is TONE.

BASIC OPERATION (CONTINUED)

USING THE TONE BUTTON CALL WAITING

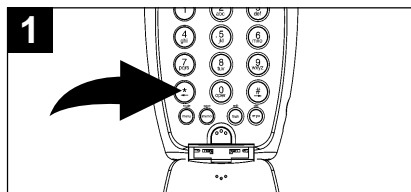

If you are in a Pulse dialing area you may still take advantage of touch-tone services after dialing to respond to touch-tone prompts. To do this, press the * / ← button to temporarily change the dialing mode from Pulse to Tone after dialing in the Pulse mode. This will enable Pulse users to access touch-tone services. It will revert back to Pulse after hanging up.

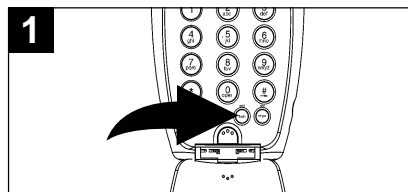

If you subscribe to Call Waiting through your local phone company, and you receive another phone call, the phone will alert you with a beep and the display will show the name and number. Simply press the EDIT/FLASH button to answer the new call. Press the EDIT/FLASH button again to return to the original call. Call Waiting Caller ID also needs to be subscribed to in order to see the new caller's name/number on the display if you are already on the phone.

CHECKING THE CALLER ID LOG

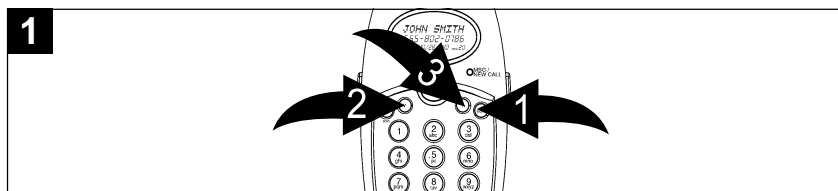

To scroll through the calls, press the CALL button **1** followed by the Down button **2** to view the latest calls, or press the Up button **3** to start from the first call. When there have been new calls, the MSG/NEW CALL indicator will blink. After checking the new messages, the MSG/NEW CALL indicator will turn off.

BASIC OPERATION (CONTINUED)

DELETING ONE NAME/NUMBER FROM THE CALLER ID LOG

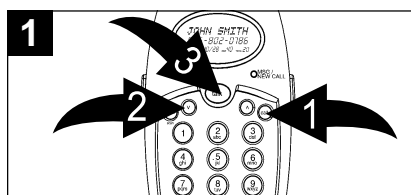

Scroll through the calls to select a number to delete by pressing the CALL button **1** followed by the Down button **2** to view the latest calls, or pressing the Up button **3** to start from the first call.

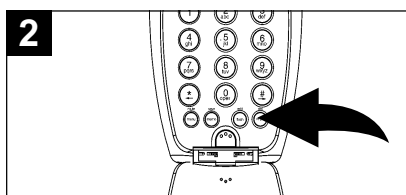

Press the DEL/RE-PA button. The display will show "ERASE ITEM?". Press the DEL/RE-PA button again. The display will show "ERASED" and the name/number will be deleted.

DELETING NAME(S)/NUMBER(S) FROM THE CALLER ID LOG

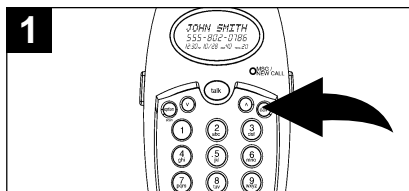

Press the CALL button.

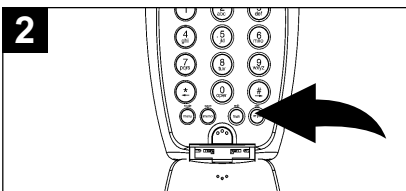

Press and hold the DEL/RE-PA button for two seconds. The display will show "ERASE ALL". Press the DEL/RE-PA button again. The display will show "ERASED" and all the name(s)/number(s) will be deleted.

BASIC OPERATION (CONTINUED)

DIALING A NUMBER IN THE CALLER ID DISPLAY

You can automatically call a number from the caller ID log as follows:

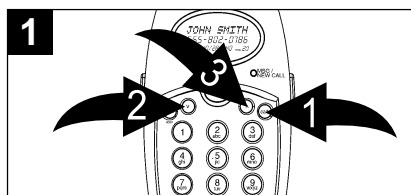

1 Scroll through the calls to select a number to dial by pressing the CALL button 1 followed by the Down button 2 to view the latest calls, or pressing the Up button 3 to start from the first call.



2 Press the OPTION button repeatedly until the desired prefixes appear. If a 1 in the area code is necessary to dial, then press the OPTION button repeatedly until the 1 and the area code appear before the number.

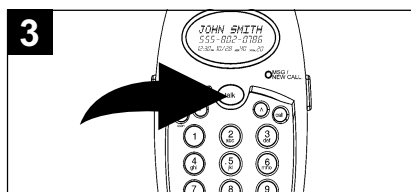

3 Press the TALK button to dial the number.

BASIC OPERATION (CONTINUED)

ADDING A DIRECTORY ENTRY

The directory can store up to 20 name/telephone numbers.

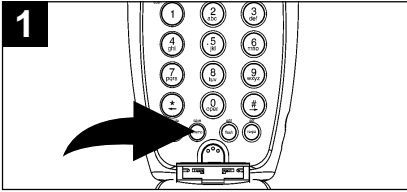
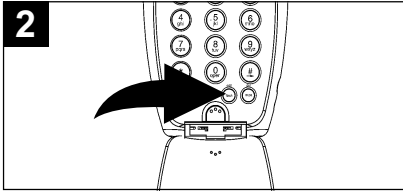
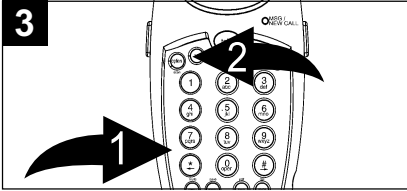
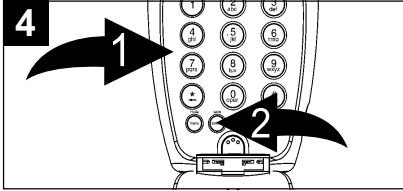
	
Press the MEMO/SAVE button.	Press the EDIT/FLASH button.
	
Using the Key buttons (0-9, *, #) ❶, enter the name as described on page 31, then press the Down button ❷.	Using the Key buttons (0-9, *, #) ❶, enter the telephone number, then press the MEMO/SAVE button ❷. "SAVED" will appear in the display.

SAVING CALLER ID INFORMATION TO THE DIRECTORY

The directory can save the information directly from the caller ID.

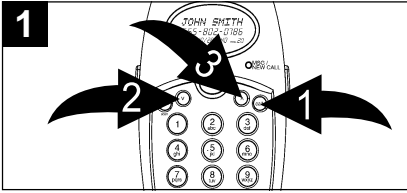
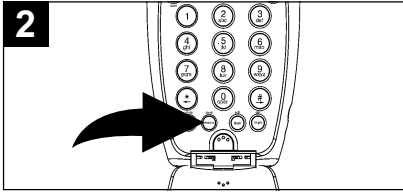
	
Scroll through the calls to select a number by pressing the CALL button ❶ followed by the Down button ❷ to view the latest calls, or pressing the Up button ❸ to start from the first call.	Press the MEMO/SAVE button.

BASIC OPERATION (CONTINUED)

ENTERING A NAME USING THE KEY BUTTONS

When entering names into the directory, you must use the Key buttons (0-9,*,#). To use the buttons to add names, perform the following steps:

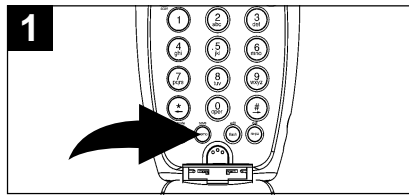

Follow steps one and two on the previous page to program the telephone number.

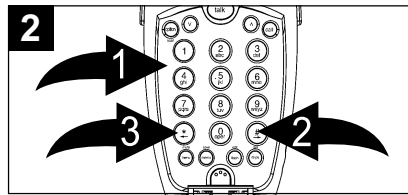

See the chart below and using the Key buttons (0-9,*,#) ❶, enter the name. Press the # button ❷ to move the cursor to the right or the * button ❸ to move the cursor to the left.

CHARACTER MAP CHART

Key	1 press	2 press	3 press	4 press	5 press	6 press	7 press	8 press
1	blank	&	'	()	*	.	1
2	A	B	C	2				
3	D	E	F	3				
4	G	H	I	4				
5	J	K	L	5				
6	M	N	O	6				
7	P	Q	R	S	7			
8	T	U	V	8				
9	W	X	Y	Z	9			
0	0							

BASIC OPERATION (CONTINUED)

DIALING A NUMBER FROM THE DIRECTORY

To select and dial a number from the directory, follow the steps below:

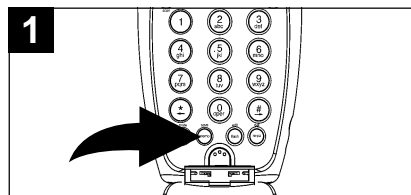

Press the MEMO/SAVE button.

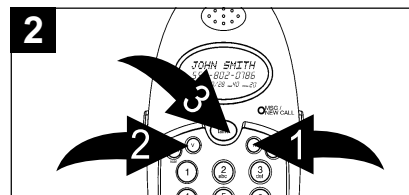

Press the Up **1** or Down **2** button to locate the number you would like to call, then press the TALK button **3**.

BASIC OPERATION (CONTINUED)

PREFERRED CALLS (VIP)

You can assign a VIP, which will generate a special second ring.

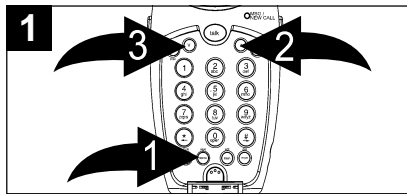

Press the MEMO/SAVE button **1**, followed by the Up **2** or Down **3** button to find the desired name/number.

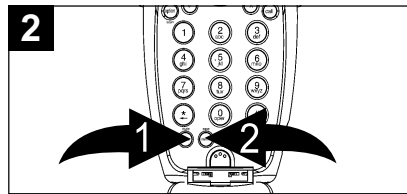

Press the MENU/MUTE button **1**; the display will show the VIP indicator. Press the MEMO/SAVE button **2** to save the VIP call.

REJECTING (BLOCKING) CALLS (REJ)

You can assign a blocked call that will disable the ringer sound from the second ring to any caller in the directory.

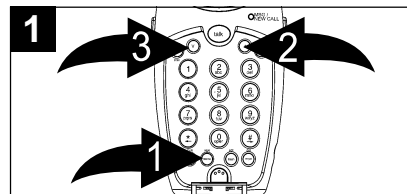

Press the MEMO/SAVE button **1**, followed by the Up **2** or Down **3** button to find the desired name/number.

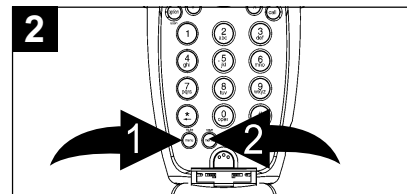

Press the MENU/MUTE button **1** twice; the display will show the REJ indicator. Press the MEMO/SAVE button **2** to save the VIP call.

BASIC OPERATION (CONTINUED)

EDITING A DIRECTORY ENTRY

To select and edit a name/number from the directory, follow the steps below:

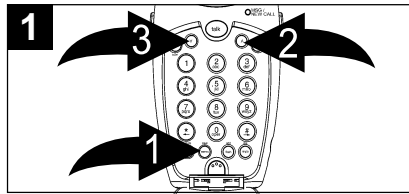

Press the MEMO/SAVE button **1**, followed by the Up **2** or Down **3** button to find the desired name/number.

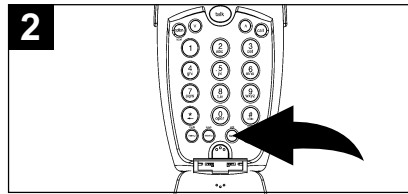

Press the EDIT/FLASH button to edit the name.

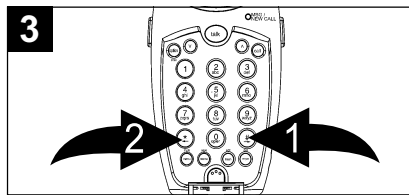

Press the # button **1** to move the cursor to the right or the * button **2** to move the cursor to the left to select a character to edit. To erase, press the DEL/RE-PA button.

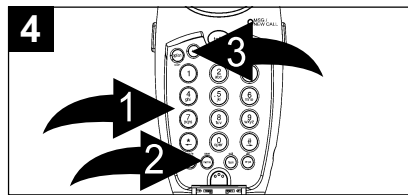

Using the Key buttons (1-9) **1**, edit the desired character(s). Press the Down button **2** and edit the telephone number. Press the MEMO/SAVE button **3** when finished.

BASIC OPERATION (CONTINUED)

DELETING ONE NAME/NUMBER FROM THE DIRECTORY

To delete a name/number from the directory, follow the steps below:

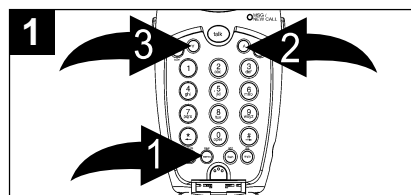

While in the Standby mode, press the MEMO/SAVE button **1**, followed by the Up **2** or Down **3** button to find the desired name/number.

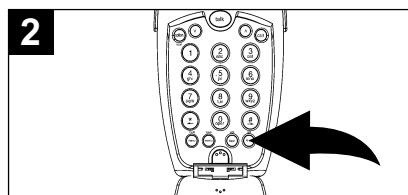

Press the DEL/RE-PA button. The display will show "ERASE ITEM?". Press the DEL/RE-PA button again. The display will show "ERASED" and the name/number will be deleted.

TROUBLESHOOTING GUIDE

SYMPTOM	SOLUTION
No dial tone.	<ul style="list-style-type: none"> • Make sure the telephone line cord is connected properly to the modular wall jack.
No power on the handset.	<ul style="list-style-type: none"> • Make sure the battery pack is properly connected inside the handset. • The handset may need recharging, recharge handset.
Handset does not charge.	<ul style="list-style-type: none"> • Make sure the charging contacts on both the base and handset are in contact during charging. • The charging contacts may be dirty, clean with alcohol-moistened cloth. • The battery may not be good anymore, replace battery.
Range is limited.	<ul style="list-style-type: none"> • Move the base so it is centrally located in your residence or office and make sure the base is not located near an appliance.
Call received flutters or fades.	<ul style="list-style-type: none"> • The handset may need recharging, recharge handset.
Cannot hear ringer.	<ul style="list-style-type: none"> • Ringer volume may be too low, raise ringer volume. • Make sure the telephone line cord is connected properly to the modular wall jack.
Caller ID information does not appear.	<ul style="list-style-type: none"> • You must subscribe to Caller ID service. • You must let the phone ring twice before answering.
Time does not automatically set.	<ul style="list-style-type: none"> • If you subscribe to Caller ID service, the time and date will automatically set during the first call. If you do not subscribe to Caller ID service, you must set manually.



CARE AND MAINTENANCE

1. Clean your phone with a damp (never wet) cloth. Solvent or detergent should never be used.
2. Avoid operating your unit under direct sunlight or in hot, humid or dusty places.
3. Keep your unit away from heating appliances.
4. Every few months, or when charging becomes abnormal, clean the contacts of the handset and the base with a standard pencil eraser.

**FOR ADDITIONAL SET-UP OR OPERATING ASSISTANCE,
PLEASE VISIT OUR WEBSITE AT WWW.MEMCORPINC.COM OR
CONTACT CUSTOMER SERVICE AT 1-800-919-3647.**

**FOR ADDITIONAL CHARGERS AND BATTERIES, CONTACT FOX
INTERNATIONAL AT 1-800-321-6993.**



NOTE:





Memcorp, Inc.
Weston, FL
Printed in China

Visit our website at www.memcorpinc.com

39

09172C-1



MSP-PH2400/09172C(ENGLISH)

40

12/16/01, 12:30 PM

Free Manuals Download Website

<http://myh66.com>

<http://usermanuals.us>

<http://www.somanuals.com>

<http://www.4manuals.cc>

<http://www.manual-lib.com>

<http://www.404manual.com>

<http://www.luxmanual.com>

<http://aubethermostatmanual.com>

Golf course search by state

<http://golfingnear.com>

Email search by domain

<http://emailbydomain.com>

Auto manuals search

<http://auto.somanuals.com>

TV manuals search

<http://tv.somanuals.com>