

# THANK YOU

FOR PURCHASING A MEMOREX PHONE!

**Memorex**

All rights reserved • Printed in China

UCZ201236BA (English)

Download from [www.Somanuals.com](http://www.Somanuals.com). All Manuals Search And Download.



# OWNER'S MANUAL

M P H 6 9 9 5

900 MHz Cordless  
Phone with Digital  
Answering System

Caller ID and  
Call Waiting  
Operation

**Memorex**

# Table of contents

## Getting Started

|   |    |
|---|----|
| Important safety instructions .....         | 3  |
| Important electrical considerations .....   | 5  |
| Introduction .....                          | 7  |
| <b>Read this first</b> .....                | 8  |
| Step 1: Checking the package contents ..... | 9  |
| Step 2: Setting up the base unit .....      | 10 |
| Step 3: Preparing the battery pack .....    | 13 |
| Step 4: Setting Caller ID options .....     | 15 |
| Entering your area code .....               | 16 |

## Basics

|   |    |
|---|----|
| Making calls .....                      | 17 |
| On-hook dialing .....                   | 17 |
| Off-hook dialing .....                  | 18 |
| Redialing .....                         | 19 |
| Receiving calls .....                   | 20 |
| Receiving a call from the handset ..... | 20 |
| Receiving a call from the base .....    | 22 |

## Memory Dial Features

|                      |    |
|----------------------|----|
| Memory Storing ..... | 23 |
| Memory Dialing ..... | 25 |
| Memory Editing ..... | 27 |
| Memory Erasing ..... | 29 |

## Caller ID Features

|  |    |
|--|----|
| Caller ID service .....                            | 30 |
| When the telephone rings .....                     | 31 |
| Viewing the Caller ID message list .....           | 32 |
| Deleting information from the Caller ID list ..... | 33 |
| Calling a party from the Caller ID list .....      | 35 |
| Storing Caller ID messages in Memory dialing ..... | 36 |
| Using "Caller ID with call waiting" service .....  | 37 |

## Using the answering machine

|  |    |
|--|----|
| Setting the clock .....                                    | 38 |
| Recording the greeting .....                               | 39 |
| Changing the greeting .....                                | 39 |
| Turning the answering machine on and off .....             | 40 |
| Setting the number of rings .....                          | 40 |
| Setting the tool saver switch .....                        | 41 |
| Setting maximum recording time for incoming messages ..... | 41 |
| Playing recorded messages .....                            | 42 |
| Deleting recorded messages .....                           | 43 |
| Screening incoming calls .....                             | 43 |
| Leaving a voice memo .....                                 | 44 |
| Recording a phone conversation (2-way REC) .....           | 45 |
| Selecting a PIN code .....                                 | 46 |
| Remote access .....  | 47 |
| Remote room monitor .....                                  | 48 |

## Additional Information

|  |    |
|--|----|
| 3-way conversation .....                 | 49 |
| Changing the digital security code ..... | 50 |
| Mounting the base unit on a wall .....   | 51 |
| Note on power sources .....              | 53 |
| Maintenance .....                        | 53 |
| Troubleshooting .....                    | 54 |
| Specifications .....                     | 56 |
| <b>Memorex limited warranty</b> .....    | 57 |
| <b>I.C. notice</b> .....                 | 58 |
| Index .....                              | 59 |

Getting S

Basic

Memory  
Featur

Caller  
Featur

Using t  
Answer  
Machin

Additio  
Informat

## Index

### 0 - 9

3-way conversation.....49

### A

Answering machine

Changing the greeting .....39

Deleting recorded messages .....43

Leaving voice memo .....44

Playing a recorded messages .....42

Recording a phone conversation ...45

Recording the greeting .....39

Remote access .....47

Remote room monitor .....48

Screening incoming calls .....43

Selecting a PIN code .....46

Setting the clock .....38

Setting the number of rings.....40

Setting the maximum recording time for the incoming message.....41

Setting the tool saver switch.....41

Turning the answering machine on and off.....40

Area code .....16

### B

Base ringer switch.....22

Base speaker volume .....22

Battery pack

Preparing and charging .....13

Replacement and handling .....53

### C

Caller ID service

Calling from the Caller ID list.....35

Deleting the Caller ID list.....33

Storing the data of the

Caller ID list to Memory.....36

Viewing Caller ID message list .....32

Caller ID with Call Waiting .....37

Channel button .....17

Connection .....11

### D

Dialing mode.....12

Digital security code .....8,50

### E, F, G, H, I, J, K, L

Editing a stored name and/or

phone number .....27

Erasing a stored name and/or

phone number .....29

Handset earpiece volume.....21

### M, N

Maintenance .....53

Making calls

Off-hook dialing .....18

On-hook dialing .....17

Redialing .....19

Making calls with memory dialing.....25

Mounting the base unit to a wall .....51

### O, P, Q

Package contents .....9

### R

Receiving calls

Receiving a call from the base.....22

Receiving a call from the handset .20

Handset ringer tone.....21

### S

Setting Caller ID options.....15

Setup

Base unit .....10

Handset.....13

Specifications .....56

Storing phone numbers and names .....23

### T

Troubleshooting .....54

### U, V, W, X, Y, Z

Using "Caller ID with Call Waiting"

service .....37

D. If the product does not operate normally when following the operating instructions. (Adjust only those controls that are covered by the operating instructions. Improper adjustment of other controls may result in damage and will often require extensive repair work by a qualified technician.)

E. If the product has been dropped or the cabinet has been damaged.

F. If the product exhibits a distinct change in performance.

13. Do not use the telephone to report a gas leak in the vicinity of the leak.

## ▼ Additional Battery Safety Precautions

**Caution!** To reduce the risk of fire or injury to persons by the battery, read and follow these instructions:

1. Use only the appropriate type and size battery pack specified in the reference guide.
2. Do not dispose of the battery pack in a fire. The cell may explode.
3. Do not open or mutilate the battery pack. Released electrolyte is corrosive and may cause damage to the eyes or skin. It may be toxic if swallowed.
4. Exercise care in handling the battery in order not to short the battery with conducting materials such as rings, bracelets, and keys. The battery or conductor may overheat and cause burns.
5. Charge the battery pack provided with or identified for use with this product only in accordance with the instructions and limitations specified in the reference guide provided for this product.
6. Observe proper polarity orientation between the battery pack and battery charger.

## ▼ Cordless Telephone Privacy

**Note!** Cordless telephones are radio devices. Communications between the handset and base of your cordless telephone are accomplished by means of radio waves which are broadcast over the open airways. Because of the inherent physical properties of radio waves, your communications can be received by radio receiving devices other than your own cordless telephone unit. Consequently, any communications using your cordless telephone may not be private.

## Memorex limited warranty - Audio/Phones

We at **MEMOREX** believe you will be pleased with your new Product. Please read this Warranty carefully. Memorex warrants this product to be free from manufacturing defects including original parts and workmanship for a period of ninety (90) days from the date of original purchase in, and if used in, the United States.

Should you find your unit is not operating properly during the terms of full coverage of this warranty, ninety (90) days, you should contact your original place of purchase for an exchange with a valid receipt. If necessary, Memorex will provide one of the following options (at Memorex's discretion), providing the manufacturing defect is verified along with the date of purchase.

- Repair service for ninety (90) days from date of original purchase at no charge for labor and parts at their authorized warranty service facility, providing the manufacturing defect is verified along with the date of purchase.
- Replacement of defective unit with either a new, refurbished, or equivalent model at no charge for ninety (90) days from date of original purchase.

This warranty is void if the product is:

- A) Damaged through negligence, abuse, misuse, accident, or acts of God.
- B) Used in commercial applications or rentals.
- C) Modified or repaired by anyone other than Memorex or their expressly authorized representative.
- D) Damage resulting from the improper connection to equipment of other manufacturers.

This warranty does not cover:

- A) Cost incurred in the shipping of the product to and from the Memorex authorized repair facility listed.
- B) Damage or improper operation caused by the failure to follow the operating instructions provided with the product.
- C) Routine adjustments to the product, which can be performed by the customer as outlined in the owner's manual.
- D) Signal reception problems caused by external factors.
- E) Products not purchased in the United States.
- F) Damage to the products used outside the United States.
- G) Damage to audiocassette tapes.
- H) Damage to Compact Discs.

In the event that service is required under this warranty, please contact CUSTOMER SERVICE at 1-800-919-3647 or contact our website at [www.memorex.com](http://www.memorex.com).

**THIS WARRANTY IS NON-TRANSFERABLE AND APPLIES SOLELY TO THE ORIGINAL PURCHASER AND DOES NOT EXTEND TO SUBSEQUENT OWNERS OF THE PRODUCT. ANY APPLICABLE IMPLIED WARRANTIES, INCLUDING THE WARRANTY OF MERCHANTABILITY, ARE LIMITED IN DURATION TO A PERIOD OF THE EXPRESSED WARRANTY AS PROVIDED HEREIN BEGINNING WITH THE DATE OF THE ORIGINAL PURCHASE AT RETAIL AND NO WARRANTIES, WHETHER EXPRESSED OR IMPLIED SHALL APPLY TO THE PRODUCT THEREAFTER. MEMOREX MAKES NO WARRANTY AS TO THE FITNESS OF THE PRODUCT FOR ANY PARTICULAR PURPOSE OR USE.**

**THE EXTENT OF MEMOREX'S LIABILITY UNDER THIS LIMITED WARRANTY IS THE REPAIR OR REPLACEMENT PROVIDED ABOVE AT THE SOLE DISCRETION OF MEMOREX. IN NO EVENT SHALL MEMOREX'S LIABILITY EXCEED THE PURCHASE PRICE PAID BY THE PURCHASER. UNDER NO CIRCUMSTANCES SHALL MEMCORP BE LIABLE FOR ANY LOSS, DIRECT, INDIRECT, INCIDENTAL, FORESEEN UNFORESEEN, SPECIAL, OR CONSEQUENTIAL DAMAGE ARISING OUT OF OR IN CONNECTION WITH THE USE OF THIS PRODUCT.**

**THIS WARRANTY IS VALID ONLY IN THE UNITED STATES. THIS WARRANTY GIVES YOU SPECIFIC LEGAL RIGHTS, HOWEVER, YOU MAY HAVE OTHER RIGHTS WHICH MAY VARY FROM STATE TO STATE. SOME STATES DO NOT ALLOW LIMITATIONS ON IMPLIED WARRANTIES OR EXCLUSION OF CONSEQUENTIAL DAMAGE, THEREFORE THESE RESTRICTIONS MAY NOT APPLY TO YOU.**

©1999, Memorex is a registered trademark of Memorex Telex N.V.

## Radio Interference

Radio interference may occasionally cause buzzing and humming in your cordless handset, or clicking noises in the base. This interference is caused by an external source such as a TV, refrigerator, vacuum cleaner, fluorescent lighting, or electrical storm. Your unit is NOT DEFECTIVE. If these noises continue and are too distracting, please check around your home to see what appliances may be causing the problem. In addition, we recommend that the base not be plugged into a circuit that also powers a major appliance because of the potential for interference. Be certain the antenna is kept in the vertical position.

In the unlikely event that you consistently hear other voices or distracting transmissions on your phone, you may be receiving radio signals from another cordless telephone or other source of interference. If you cannot eliminate this type of interference, you need to change to a different channel.

Finally, it should be noted that some cordless telephones operate at frequencies that may cause interference to nearby TVs and VCRs. To minimize or prevent such interference, the base of the cordless telephone should not be placed near or on top of a TV or VCR. If interference is experienced, moving the cordless telephone farther away from the TV or VCR will often reduce or eliminate the interference.

## More Than One Cordless Telephone

If you want to use more than one cordless telephone in your home, they must operate on different channels. Press the channel key to select a channel that provides the clearest communication.

## Additional information (continued)

| Symptom   | Suggestion   |
|---|--|
| The answering system does not work.   | <ul style="list-style-type: none"> <li>• Make sure the base unit is plugged in.</li> <li>• Make sure the answering system is turned on.</li> <li>• Press <b>RESET</b> after an AC line spike.</li> </ul>         |
| The answering system does not answer calls.                                   | <ul style="list-style-type: none"> <li>• Select <b>REC TIME</b> switch to either the one minute or four minute option.</li> <li>• The memory may be full. Delete some or all of the saved messages.</li> </ul>   |
| Messages are incomplete.  | <ul style="list-style-type: none"> <li>• The incoming messages may be too long. Remind callers to leave a brief message.</li> <li>• The memory may be full. Delete some or all of the saved messages.</li> </ul> |
| After a power failure, the greeting is deleted.                               | <ul style="list-style-type: none"> <li>• Record your personal greeting again. The prerecorded messages should remain.</li> </ul>   |
| No sound on the base unit speaker during call monitoring or message playback. | <ul style="list-style-type: none"> <li>• Adjust the speaker volume on the base unit.</li> </ul>  |

## Read this first

This cordless telephone must be set up before use. Follow these steps;

### Step 1 (page 9)

Unpack the telephone and accessories.

### Step 2 (page 10 to 12)

Next, choose the best location to set up the base unit.



Base unit

### Step 3 (page 13 to 14)

Then, insert the battery pack into the handset. You have to charge the battery pack for more than 12-15 hours before using the phone.



Handset

### Step 4 (page 15 to 16)

Finally, set Caller ID options and store your area code in the memory to use the Caller ID service.

**Note:** Skip the setting of area code if your calling area requires 10 digits dialing.



Handset

### About the digital security code

This cordless telephone uses a digital security code to prevent unauthorized access to your base unit. This security code prevents other cordless handsets from making calls through your base unit.

A random security code will be assigned automatically between your base unit and handset when you charge the battery pack for the first time.

To reset the security code, see page 50.

### Note on power sources

#### Battery replacement and handling

When the operating time becomes short, even after a battery is recharged, please replace the battery.

With normal usage, your battery should last about one year.

Please contact your place of purchase for a replacement battery.

#### Power Failure

During the period that the power is off, you will not be able to make or receive calls with the telephone.

#### RECYCLING NICKEL-CADMIUM BATTERIES

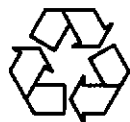

**NICKEL-CADMIUM BATTERIES MUST BE DISPOSED OF PROPERLY.**

**Ni-Cd**

Nickel-cadmium cells are used in the battery pack. Please take your used nickel-cadmium battery packs to a store that recycles nickel-cadmium batteries.

#### Caution

- Use the specified battery pack.
- Do not remove the battery from the handset to charge it.
- Never throw the battery into a fire, disassemble it, or heat it.
- Do not remove or damage the battery casing.

### Maintenance

#### When slightly dirty

Wipe with a soft, dry cloth.

#### When very dirty

Wipe with a soft cloth that has been dampened with diluted, neutral detergent. Dry with a dry cloth.

#### When the charging terminals become dirty

Wipe with a pencil eraser or other contact cleaner.

#### Caution

Do not use paint thinner, benzene, alcohol, or other chemical products. Doing so may discolor the surface of the telephone and damage the finish.

## Step 2

### Setting up the base unit

Do the following steps.

- Choose the best location
- Connect the base unit
- Choose the dialing mode

#### Choose the best location

Before choosing a location for your new phone, read the INSTALLATION CONSIDERATIONS included in the PRECAUTIONS AND IMPORTANT SAFETY INSTRUCTIONS brochure. Here are some important guidelines you should consider:

**Avoid heat sources, such as radiators, air ducts, and sunlight**

**Avoid noise sources such as a window by a street with heavy traffic**

**Avoid television sets and other electronic equipment**

**Avoid microwave oven**

**Avoid excessive moisture, extremely low temperatures, dust, mechanical vibration, or shock**

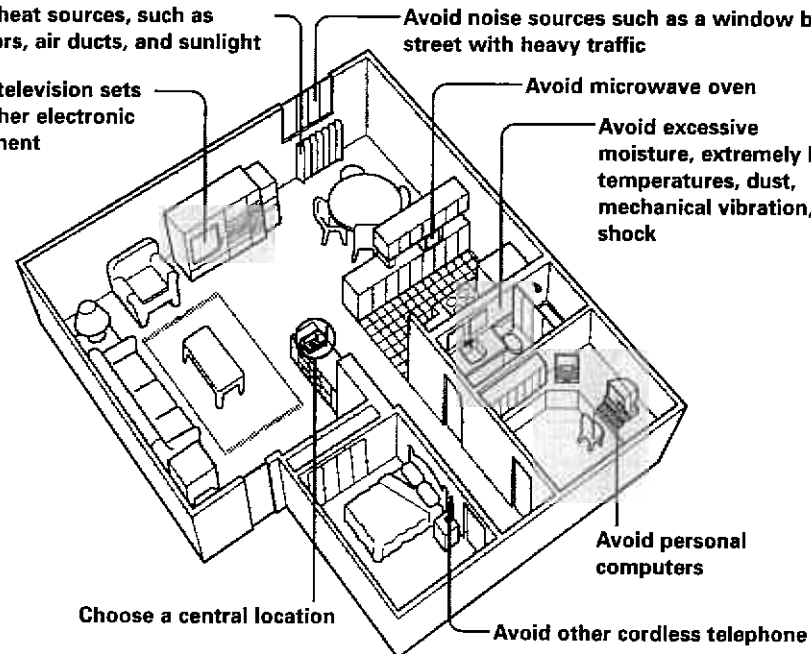

- You should charge your handset for 12-15 hours before using the phone.
- The location should be close to both a phone jack and continuous power outlet which is not switchable.
- Keep the base and handset away from sources of electrical noise such as motors and fluorescent lighting.
- Be sure there is sufficient space to raise the base antenna fully vertical.
- The base can be placed on a desk, tabletop or mounted on a standard wall plate.

### Mounting the base unit on a wall

#### Standard wall plate mounting

This phone can be mounted on any standard telephone wall plate.

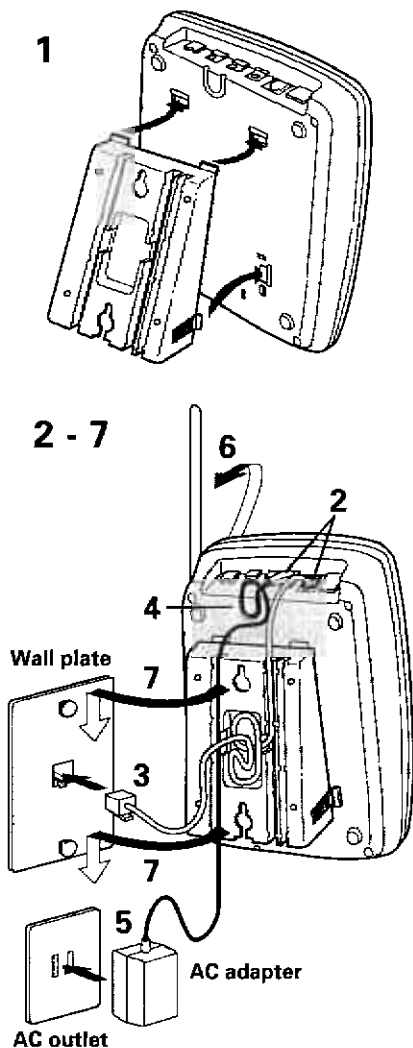

- 1 Snap the wall mount adapter into the notches on the base.

- 2 Plug the telephone line cord to the **TEL LINE** jack and the AC adapter to the **DC IN 9V** jack.

- 3 Plug the telephone line cord into the telephone outlet.

- 4 Wrap the AC adapter cord inside the molded wiring channel. Then wrap the cord around the strain relief notch.

- 5 Plug the AC adapter into a standard 120V AC wall outlet.

**Note** Use only the Uniden AC adapter supplied with this phone.

- 6 Raise the antenna to a vertical position.

- 7 Align the mounting slots on the base with the mounting posts on the wall. Push in and down until the phone is firmly seated.

#### Notes

- Use only the supplied AD-420 AC adapter. Do not use any other AC adapter.
- Place the base unit close to the AC outlet so that you can unplug the AC adapter easily.

#### Polarity of the plug



#### Tips

- If your telephone outlet isn't modular, contact your telephone company for assistance.

#### Modular



### Choose the dialing mode

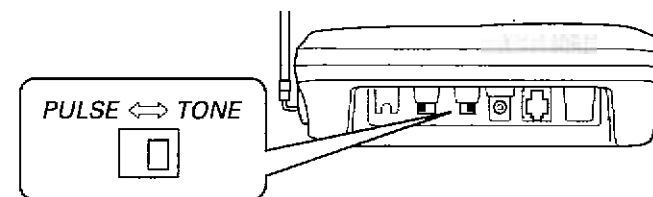

Depending on your dialing system, set the PULSE-TONE switch as follows:

| If your dialing system is | Set the switch to |
|---------------------------|-------------------|
| Tone                      | TONE              |
| Pulse                     | PULSE             |

#### If you aren't sure of your dialing system

Make a trial call with the PULSE-TONE switch set to TONE. If the call connects, leave the switch as is; otherwise, set to PULSE.

## Additional information

### 3-way conversation

The MPH 6995 permits 3-way conversations between the handset, base, and outside line.

#### When speaking on the handset

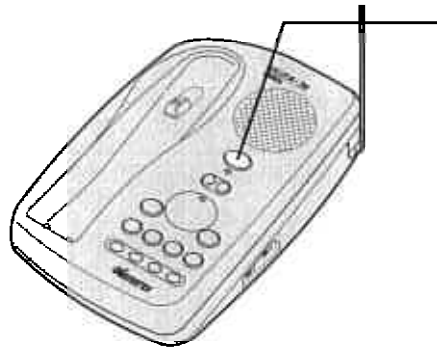

- 1 Press **SPEAKER** on the base to join the 3-way conversation.
- 2 Press **SPEAKER** on the base to hang up. The handset will still be connected to the outside call.



#### When speaking on the base

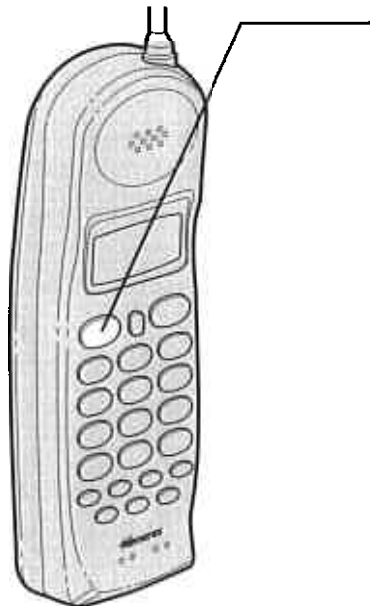

- 1 Press **TALK** on the handset to join the 3-way conversation.
- 2 Press **TALK** on the handset to hang up.

#### Note

- Pressing **SPEAKER** on the base while dialing with the handset sets the 3-way conversation mode dialing is not affected.

## Step 3 (continued)

### Battery use time (per charge)

From fully charged

- Seven hours continuous use.
- Fourteen days when the handset is in the standby mode.

### When the battery charge becomes low

When the voltage of battery pack is very low and needs to be charged, the phone eliminates functions to save power. If the phone is not in use, "Low Battery" flashes and none of the keys will operate. If the phone is in use, "Low Battery" flashes and the handset beeps. Complete your conversation as quickly as possible and return the handset to the base unit for charging.

Low Battery

#### Notes

- Even when the battery pack is not being used, it will gradually discharge over a long period. For optimum performance, be sure to return the handset to the base unit after a telephone call for charging the battery.
- The built-in memory backup can hold numbers and names stored in the memory for up to 2 minutes, while you replace the battery pack.
- Rechargeable batteries have a memory effect that reduces standby and talk time. To avoid this memory effect, on a monthly basis, use the phone until the "Low Battery" indication appears. Then charge the battery for 12-15 hours.

### Cleaning the battery contacts

To maintain a good charge, it is important to clean all battery contacts on the handset and base unit about once a month. Use a pencil eraser or other contact cleaner.

**Do not use any liquids or solvents.**



### Remote access

You can operate your answering system from a remote location using any touch-phone telephone. Use this function to check for recorded messages, to play or delete messages, even to record a new outgoing message, and to monitor sounds in the room.

- 1 Call your telephone number.
- 2 During the greeting playback, press **#** followed by your PIN code. Refer to page 46 for instructions on how to select a PIN code.
- 3 The answering system announces the time and day stamp followed by the number of messages stored in memory. Message playback automatically begins.
- 4 You may continue to listen to your messages, or you may select a command from the following chart:

| Function              | Press                  |
|-----------------------|------------------------|
| Repeat a Message      | <b>#</b> then <b>1</b> |
| Playing your Messages | <b>#</b> then <b>2</b> |
| Skipping a Message    | <b>#</b> then <b>3</b> |
| Deleting a Message    | <b>#</b> then <b>4</b> |
| Stop Message Playback | <b>#</b> then <b>5</b> |
| Answering System On   | <b>#</b> then <b>6</b> |
| Memo Record/Stop      | <b>#</b> then <b>7</b> |
| Greeting Record/Stop  | <b>#</b> then <b>8</b> |
| Answering System Off  | <b>#</b> then <b>9</b> |
| Remote Room Monitor   | <b>#</b> then <b>*</b> |

- 5 After all of your messages have played, you will hear intermittent beeps indicating that the system is in the command waiting mode. You may enter another command at this time from the chart above.
- 6 When you are finished, hang up to exit the system. The answering system automatically returns to standby.

#### Notes

- You must enter a command within 15 seconds of entering command waiting mode or the answering system automatically hangs up and returns to standby.
- The system will only play back messages for four minutes and then it returns to command waiting mode. To continue playing your messages, press **#** then **2** again within 15 seconds.

### Entering your area code

**Note** Skip this step if your calling area requires 10 digits dialing.

When you use this phone for the first time, or move to an area that has a different area code, you must enter your area code. This is necessary because the phone must distinguish local or long distance calls to properly dial calls from the Caller ID message list. (See page 35.)



- 1 When the phone is in the standby mode, press and hold **(CALLER ID)** for 2 seconds until the Caller ID setting screen appears.

```
1 Auto Talk:Off
2 CIDCW      :On
3 Area Code:
```

- 2 Press **(▲)** or **(▼)** to select "Area Code".

```
1 Auto Talk:Off
2 CIDCW      :On
3 Area Code:
```

- 3 Press **(SELECT)**.

```
1 Auto Talk:Off
2 CIDCW      :On
3 Area Code:7
```

- 4 Use the dial buttons (**(0)** to **(9)**) to enter the 3-digit area code.

- 5 Press **(SELECT)**.  
A beep sounds and the displayed area code is entered.

- 6 Press **(CALLER ID)** to complete the setting. Or return the handset to the base unit to complete the setting mode and set the handset to the standby mode.

#### Note

When the area code has already been stored in memory, the stored area code will be displayed. To change it, use the dial buttons to enter the new area code.

```
1 Auto Talk:Off
2 CIDCW      :On
3 Area Code:81
```

To complete the setting, press **(CALLER ID)** or return the handset to the base unit.

### Recording a phone conversation (2-way REC)

You can record a telephone conversation that is already in progress. The conversation is stored and played back like an incoming message.

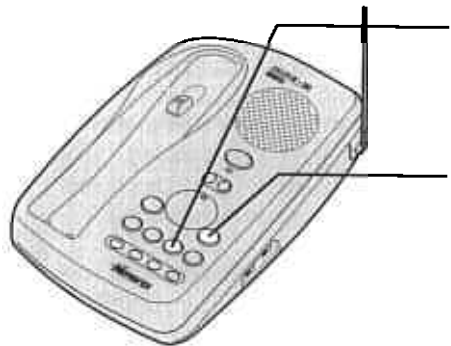



- 1** During the conversation, press and hold **MEMO** on the base unit approximately 1 second. Recording starts automatically.
- 2** To stop recording, return the handset to the base and press **MEMO** or **PLAY/STOP** on the base unit.

#### Notes

- The recorded conversation must be at least 10 seconds long, or it will be automatically deleted.
- The telephone beeps intermittently to alert the parties that the conversation is being recorded.
- You cannot use 2-way REC when you using the speakerphone.

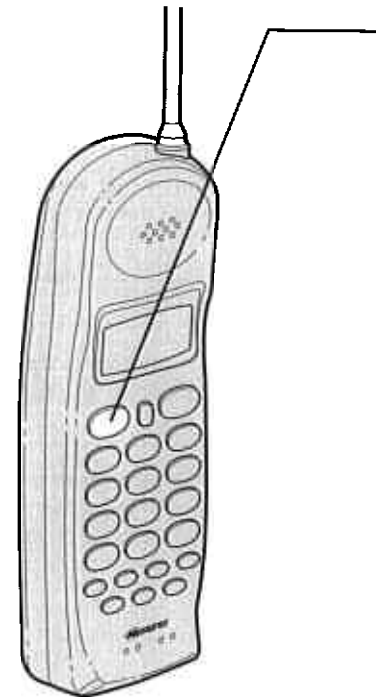
### Off-hook dialing

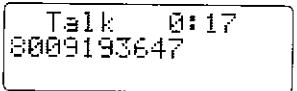
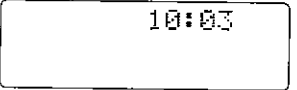

- 1** Press **TALK**. "Talk" appears flashing on the display.  

- 2** Dial the phone number. After about 5 seconds, the call-time display appears.  
**Example:** Enter 800-919-3647  

- 3** Press **TALK** or place the handset in the base to end the telephone call. The call-time will be displayed for about 5 seconds. The phone returns to standby.  

- Returning the handset to the base also ends the phone call and set the handset returns to the standby mode (i.e., AutoStandby).

### Deleting recorded messages

To delete individual messages, press **DELETE** during playback, immediately after, or before the next message begins. You will hear a confirmation tone when the deletion is completed.

To delete all messages, first, make sure all new messages are played. Then press and hold **DELETE** at the base until you hear a long beep.

#### Notes

- If there are messages that you have not listened to when you are deleting all messages, you will hear several short beeps and the messages will not be deleted. This is to protect you from accidentally erasing messages you have not yet listened to.
- To maintain maximum available record time, it is a good idea to delete the old messages.

### Screening incoming calls

You can screen calls using the base unit.

- 1 After the answering machine starts, the base speaker lets you hear the caller as the machine records the message.
- 2 To answer the call immediately, follow the directions below. The answering machine will disconnect automatically.

#### AT THE HANDSET

##### Auto Talk on:

**When the handset is on the base unit:** Simply pick up the handset

**When the handset is away from the base unit:** Press **TALK**

##### Auto Talk off:

**When the handset is on the base:** Pick up the handset and press **TALK**

#### AT THE BASE

Press **SPEAKER**

#### Note

If the message portion was 2 seconds or less, it will not be retained as a message.

### Receiving a call from the handset

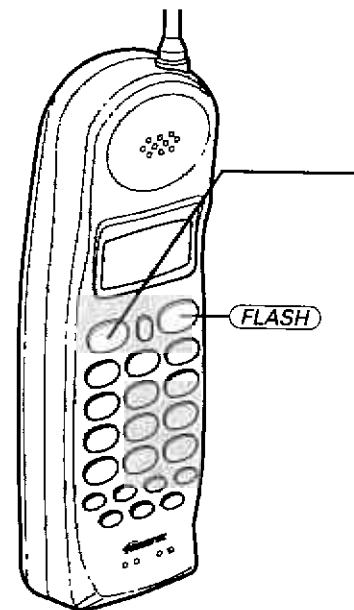

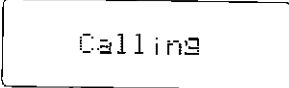
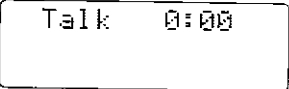
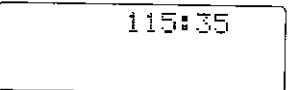
- 1 Phone rings.  

- 2 Press **TALK**, the call-time display starts. Talk with the caller.  

- 3 Press **TALK** or place the handset on the base when the telephone call is finished. The call time will be displayed for about 5 seconds.  

#### Auto Talk when ringing

When the Auto Talk setting is on and there is an incoming call, simply lift the handset from the base unit to answer the phone. (See page 15.)

#### Any key when ringing

When the Auto Talk setting is on, press any handset key to answer the phone. (See page 15.)

#### Any key when paging

To cancel paging, press any key on the handset keys while the handset is beeping.

**Call Waiting Caller ID reception — Note:** You must subscribe to Call Waiting Caller ID service from your local phone company to use this feature.

When a call is received during a telephone call already in progress, the handset enters call waiting mode and Caller ID data displays.

Press **FLASH** to switch to the new call. (See page 37.)

### Setting the toll saver switch

The ring time/toll saver switch sets your answering system to answer after two or four rings.



In the **TS** (toll saver) position, if you have new messages, the answering system answers after two rings. If there are no new messages, the system answers after four rings. This way, when you call long distance to check your messages, and have no messages, you can hang up after the second ring to save a charge.

### Setting maximum recording time for incoming messages

You can select the maximum recording time by sliding the **REC TIME** switch on the base unit to one of the following positions:

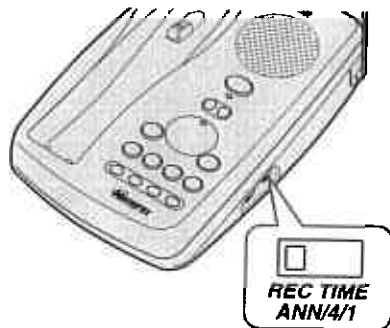

- 1** : 1 minute
- 4** : 4 minutes
- ANN** : Announce only

#### Note

If you set the switch to **ANN**, a prerecorded greeting plays, and no message will be accepted.

### Receiving a call from the base

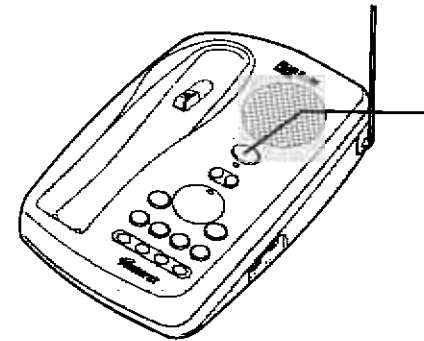

- 1** The base rings. The **CHARGE/IN USE** LED on the base flashes.
- 2** Press **SPEAKER** and speak.
- 3** When you finish the call, press **SPEAKER** to hang up.

#### Base ringer switch

To turn off the ringer, set the ringer switch on the back of the base to off position. This switch turns the handset ringer on or off.

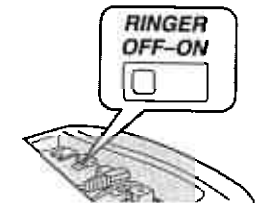

#### Base speaker volume

To control the speaker volume of the base, adjust the **VOLUME ▲** and **VOLUME ▼** button as desired.

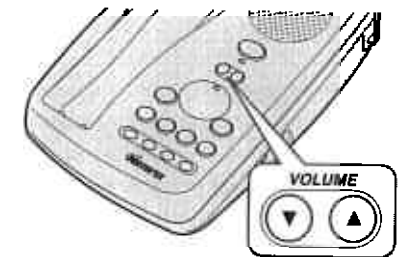

### Recording the greeting

You can record a personalized greeting or use the prerecorded message.

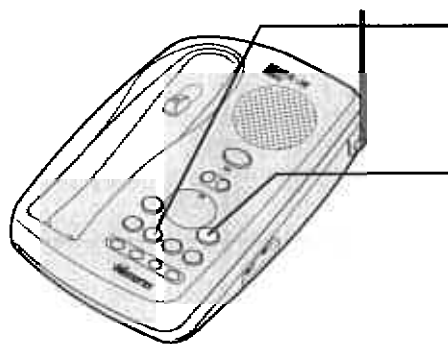

- 1 Press and hold **OGM** on the base until you hear the long beep. Then, begin speaking over the microphone.
- 2 When you finish speaking, press **OGM** or **PLAY/STOP**. The greeting you just recorded will automatically be played back.

The base microphone is located under the phone. Position yourself approximately 10 inches away from the base and speak clearly.

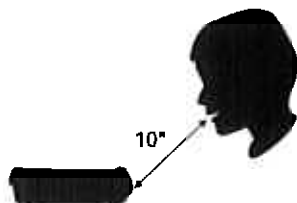

### Changing the greeting

You can change from the pre-recorded greeting to your own recorded greeting or vice versa.

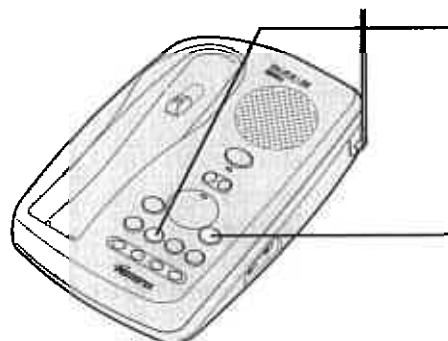

- 1 Press **OGM** on the base unit. You will hear the currently selected greeting.
- 2 Press **OGM** while the unit is playing the greeting.
- 3 Wait until the entire greeting is played back, or press **PLAY/STOP**. Now, the greeting is changed.

- 4 Use the **▲**, **▼**, **#/▶**, **\*/TONE/◀**, or **DELETE** keys to enter the name. The name cannot exceed 16 characters.
  - Use the **▲** and **▼** key to scroll through the characters.
  - Use the **#/▶** and **\*/TONE/◀** to move the cursor to the desired position.
  - Use the **DELETE** key to delete characters as needed.

- 5 Press **SELECT**. "Store Number" is displayed. The cursor flashes indicating that the display is ready for the number to be entered.

```
Store Number
|
```

- 6 Use the keypad, or **REDIAL/PAUSE** key to enter the phone number. The phone number can be up to 16 digits.
  - Use the **REDIAL/PAUSE** key to enter pause in the dialing sequence. The display shows a "P".

```
Store Number
8009193647
```

**Note** The pause feature is useful for long distance calling, credit card dialing, or sequences that require a pause between digits.

- Use the **DELETE** key to delete digits needed.

- 7 Press **SELECT**. The handset beeps and displays the confirmation screen. Memory storage is complete.

```
Memory 7 Stored
```

For example if you store a name and number into memory location number 7, the display shows "Memory 7 Stored".

After about 2 seconds, "Memory Store" is displayed.

```
Memory Store
7▶<Memory 7>
8
```

## Using "Caller ID with call waiting" service

"Caller ID" and "Call waiting" are separate services. CIDCW (Caller ID on Call Waiting) performs the same as regular Caller ID on a call waiting number. You must subscribe to the "Caller ID with call waiting (CIDCW)" service from your telephone company before you can use the following features.

The "Call waiting" service can also be used independently. Please contact your telephone company for details.

When a new incoming call arrives during your current telephone call, the phone number appears. (The name of the new caller is displayed, depending upon the telephone service.)



- 1 When a new incoming call arrives during your current telephone call, the phone number and the name of the caller is displayed.

Talk 10:30  
MEMCORP  
800-919-3647

- 2 Press **FLASH**. You will be able to talk with the person that has just called. The person with whom you were talking will be put on hold.

- 3 To return to the first caller, press **FLASH** again.

## Display a Programmed Number

Press **MEM**, then use the **#/▶** and **\*/TONE/◀** keys to toggle between the names and the numbers display.

| Program name  | Program number |
|---------------|----------------|
| 1 MEMCORP     | 1 8009193647   |
| 2 JOHN DOE    | 2 5452330      |
| 3 MOM AND DAD | 3 8175551212   |

**Note** When the stored phone number has 15 or more digits, the first 13 digits of the phone number and "→" are displayed. Press **#/▶** to see extra digits and **\*/TONE/◀** to return.

## Off-hook dialing



- 1 Press **TALK**. 'Talk' flashes on the display.

Talk

- 2 Press **MEM**.

Talk 0:00

- 3 Press the number keypad to select the memory location of the desired phone number. The selected phone number is displayed. Then the number is dialed.

Talk 0:35  
0123456789012

**Note** Memory location 0 follows memory location 9.

## Calling a party from the Caller ID list

You can place a call from the Caller ID list. The MPH 6995 stores up to 30 messages.

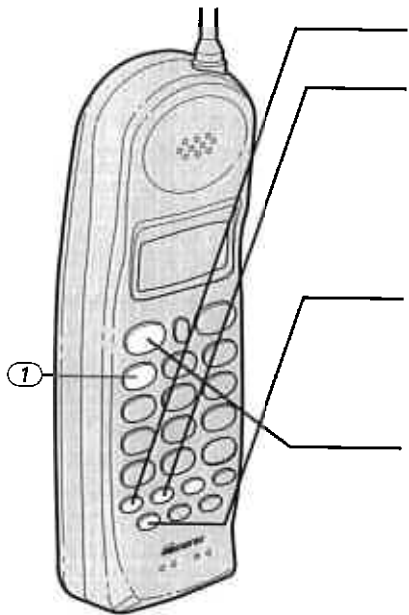

- 1 Press **CALLER ID**.
- 2 Press **▲** or **▼** to select the phone number that you want to dial. (See page 38.)

```
5/17 12:30PM 03
MEMCORP
800-919-3647
```

- 3 Press **SELECT**.

```
MEMCORP
8009193647#
```

- 4 Press **TALK**.

```
Talk-
8009193647
```

The displayed phone number dials automatically.

### Long Distance calls

Pressing **1** while the incoming call information is displayed (in step 1) will place a "1" in front of the number for long distance calling. Press **1** again to remove the "1".

#### Notes

- When a long distance call has been set, "1" appears in the display.
- You cannot make a call from the Caller ID list, if your MPH 6995 is connected to private branch exchange (PBX).
- When the cursor is displayed at the end of the phone number (as in step 2), if you cannot edit the phone number. (See page 28.) Caller ID messages can not be changed from the Caller ID list. You must first store messages in memory. (See page 36.)

- 7 Use the number keypad, **REDIAL/PAUSE**, or **DELETE** key to edit the phone number. The phone number cannot exceed 16 digits. (See page 24.) When the phone number will not be edited, skip this step.

- 8 Press **SELECT**.  
The handset beeps and displays the confirmation screen. The memory storage is complete. For example if you store a name and number into memory location number 1, the display shows "Memory 1 stored".

```
Memory 1 Stored
```

After about 2 seconds, "Memory Store" is displayed.

```
Memory Store
1 MEMCORP
2 JOHN DOE
```

- 9 Press **MEM** to exit edit mode.

### Display a Programmed Number

Use the **#/▶** and **\*/TONE/◀** keys to toggle between the names and the numbers display.

| Program name |    | Program number |
|--------------|----|----------------|
| Memory Store | ↔▶ | Memory Store   |
| 1 MEMCORP    |    | 1 8009193647   |
| 2 JOHN DOE   | ◀↔ | 2 5452930      |

### Deleting information from the Caller ID list

The MPH 6995 stores up to 30 Caller ID messages. If more new calls are received, messages stored in the list are deleted beginning with the oldest message in the list. Data can also be deleted manually.

#### Deleting a Caller ID message

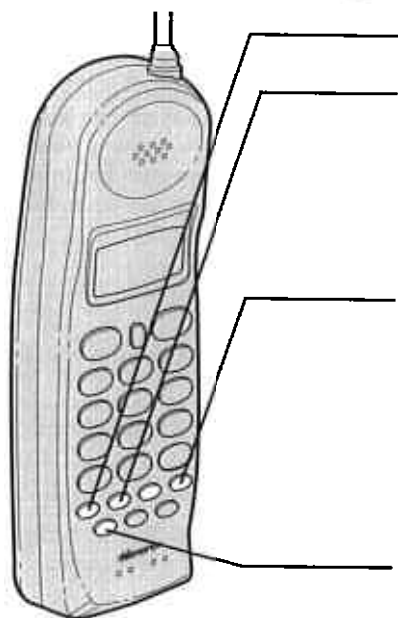

- 1 Press **CALLER ID**.
- 2 Press **▲** or **▼** to select the message that you would like to delete. (See page 32.)
 

5/17 12:30PM 03  
 MEMCORP  
 800-919-3647
- 3 Press **DELETE**, while the summary screen is displayed.
 

Delete Message ?  
 ▶ Yes  
 No
- 4 Press **▲** or **▼** to select "Yes" or "No".
- 5 Press **SELECT** or **DELETE**.
 

**When the pointer is at "Yes":**  
A beep tone sounds and the next Caller ID message displayed.

**When the pointer is at "No":**  
The display returns to the Caller ID display.

#### Notes

- While using the "Delete Message ?" screen, if no key is pressed for more than 20 seconds, an error tone sounds and the telephone returns to standby.
- If you get an incoming call, the deleting operation canceled and the telephone returns to standby so you can answer the call.

- 8 After 2 seconds the display returns to the "Memory Store" screen. You may select another number to delete (return to step 4).
- 9 Press **MEM** to return to standby.

Memory Store  
 1▶ MEMCORP  
 2 MOM AND DAD

### Caller ID service

**You must subscribe to the Caller ID service from your telephone company to use this feature.**

When the telephone rings, the Caller ID feature allows you to view the caller's name and phone number on the display before you answer the phone. The handset displays the phone number of the incoming call, the name, time, and call counts. Additionally, you can dial the displayed number, and store the information for memory dialing.



## When the telephone rings

- When phone rings, the **CHARGE/IN USE** LED blinks. On the second ring, the display shows the caller's phone number, along with the date and time. The incoming call information is stored. If the Caller ID service includes the caller's name, it appears on the display (up to 15 letters).

The date and time received and call count  
 Caller's name  
 Caller's phone number

```
5/11 12:30PM 01
MEMCORP
800-919-3647
```

Here are some typical displays;

When the phone number and name data are received

```
5/11 12:30PM 01
MEMCORP
800-919-3647
```

When a private name is received

```
5/11 12:30PM 01
Private Name
800-911-3647
```

When an unknown name is received

```
5/11 12:30PM 01
Unknown Name
800-919-3647
```

When a private number is received

```
5/11 12:30PM 01
MEMCORP
Private Number
```

When an unknown number is received

```
5/11 12:30PM 01
MEMCORP
Unknown Number
```

When invalid data is received

```
Incomplete Data
```

- When the telephone is answered, the display changes to "Talk".

### Notes

- If you answer a call before the Caller ID message is received (Example: before the second ring), the Caller ID message will not appear.
- When the call is received via a telephone company that does not offer Caller ID service, the caller's phone number and name do not appear. (This includes international calls.)
- When the call is via a private branch exchange (PBX), the caller's phone number and name may not appear.
- Data errors appear as ". . .".

```
5/11 12:30PM 01
MEMCORP
800-919-3647
```

## Viewing the Caller ID Message list

The Caller ID list stores information for up to 30 incoming calls - even unanswered calls.

- Note** If a call comes in via a telephone system that does not offer Caller ID service, no information is stored.

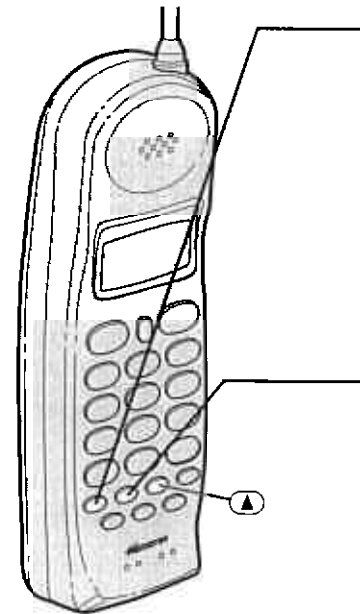

- Press **CALLER ID**. The summary screen appears. When there are new messages you have received, "New" and the number of calls are displayed. The summary screen shows how many new calls are stored, along with the total of new and old calls stored in the list.

```
New :01
Total:02
```

- Press **▼** to display the latest caller ID message.

```
5/11 12:30PM 03
MEMCORP
800-919-3647
```

- Press **▼** to see the next message. Or press **▲** to see previous message.

- Press **CALLER ID** to return to standby.

### Long Distance call settings and cancellation

Pressing **1** while the incoming call information is displayed (in step 2) will set or cancel a long distance call. The prefix "1-" will be displayed at the beginning of the phone number when a long distance call is set.

Pressing **1** will cancel the long distance call setting.

```
5/17 12:30PM 03
MEMCORP
1-800-919-3647
```

### Notes

- "End" appears when you have reviewed all messages in the Caller ID list.
- Each message can be up to 16 characters for the phone number and the name.

## Erasing a stored name and/or phone number



- 1** Press and hold **(MEM)** for 2 seconds. The display shows the memory screen and any saved name/number.

```
Memory Store
1▶MEMCORP
2 JOHN DOE
```

- 2** Press the **(▲)** or **(▼)** keys or number keypad to select the memory location you would like to edit.

```
Memory Store
1 MEMCORP
2▶JOHN DOE
```

- 3** Press **(SELECT)**. The following screen appears with the memory location number that you have selected in the display.

For example if you selected memory location number 2 as the location in the selected.

```
▶Edit Memory 2
Delete Memory 2
Go Back
```

- 4** Press **(▼)** to move the cursor down to "Delete Memory" command line.

```
Edit Memory 2
▶Delete Memory 2
Go Back
```

- 5** Press **(SELECT)**. The following confirmation screen appears.

```
Delete Memory 2?
Yes
▶No
```

- 6** Press **(▲)** to move the cursor to "Yes".

- 7** Press **(SELECT)** or **(DELETED)**. There is a confirmation tone and memory is deleted. The following screen appears.

For example if memory location number 2 is selected for deletion, the following display appears as the confirmation screen.

```
Memory 2 Deleted
```

## Deleting all Caller ID name/numbers

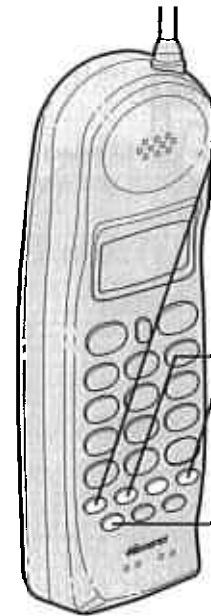

- 1** Press **(CALLER ID)**.

```
New :01
Total:02
```

- 2** Press **(DELETED)**, while the summary screen is displayed.

```
Delete All ?
Yes
▶No
```

- 3** Press **(▲)** or **(▼)** to select "Yes" or "No".

- 4** Press **(SELECT)** or **(DELETED)**.

**When the pointer is at "Yes":**  
A beep tone sounds and all stored Caller ID messages are deleted.

```
Total:00
```

**When the pointer is at "No":**  
The display returns to the summary screen.

```
New :01
Total:02
```

### Notes

- While using the "Delete All ?" screen, if no key is pressed for more than 20 seconds, an error tone sounds and the telephone returns to standby.
- If you get an incoming call, the deleting operation is canceled and the telephone returns to standby so you can answer the call.

## Editing a stored name and/or phone number

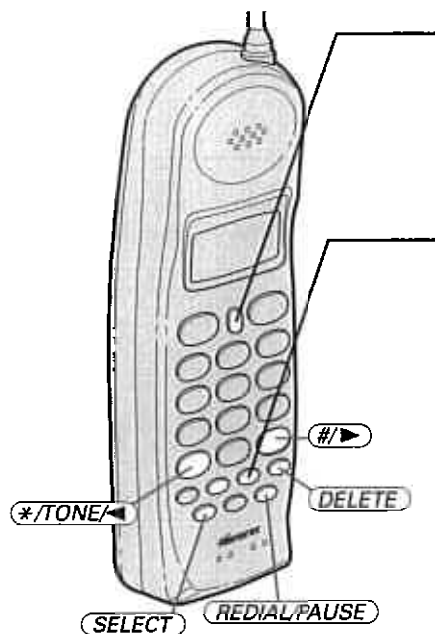

**1** Press and hold **(MEM)** for 2 seconds. The display shows the memory screen and any saved name/number.

```
Memory Store
1 MEMCORP
2 JOHN DOE
```

**2** Press the **(▲)** or **(▼)** keys or number keypad to select the memory location you would like to edit.

```
Memory Store
1 MEMCORP
2 JOHN DOE
```

**3** Press **(SELECT)**. The following screen appears with the memory location number that you have selected in the display.

For example, if you selected memory location number 1, the display shows memory 1 selected.

```
Edit Memory 1
Delete Memory 1
Go Back
```

**4** Press the **(▲)** or **(▼)** key to select 'Edit Memory', then press **(SELECT)**. The following screen appears. The cursor flashes indicating that the display is ready for the name to be edited. When a name has not been stored, the cursor appears at the beginning of the second line.

```
Store Name
MEMCORP
```

**5** Press **(▲)**, **(▼)**, **(# / >)**, **(\* / TONE / <)**, or **(DELETE)** to edit the name. (See page 24.) To edit only the phone number, skip this step.

**6** Press **(SELECT)**. The following screen appears. The cursor flashes indicating that the display is ready for the number to be edited.

```
Store Number
800919364
```

## Storing Caller ID messages in Memory

Messages shown in the Caller ID list can be stored for memory dialing. Using the incoming call information (i.e., Caller ID list), the phone number of the party on the Caller ID list can be stored in memory dialing.

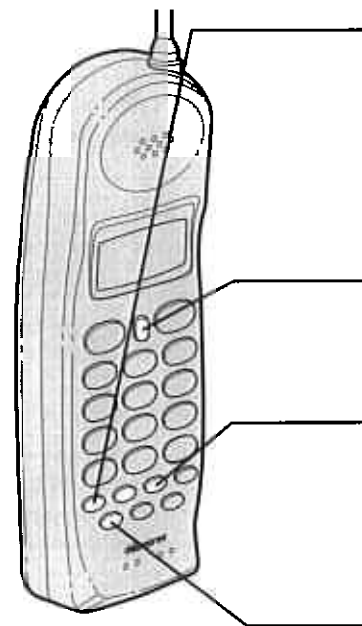

**1** Press **(CALLER ID)**.

**2** Display the phone number to be stored from the Caller ID list. (See page 28.)

```
5/17 12:30PM 03
MEMCORP
800-919-3647
```

**3** Press **(MEM)**.

```
Select Location
1 MEMCORP
2 JONE DOE
```

**4** Press **(▲)** or **(▼)** to select the memory location where you wish to store the name and number from caller ID. Press the dial buttons (**(0)** to **(9)**) and select the number (01 to 20).

**5** Press **(SELECT)**. A beep tone will sound. The number is stored in memory, and the display returns to the Caller ID list.

```
5/17 12:30PM 03
MEMCORP
800-919-3647
```

### Notes

- If a message has already been stored in the selected memory numbers location, a verification screen is displayed. Press **(▲)** to select "Yes". Press **(SELECT)** to overwrite. The display returns to the Caller ID list.
- You can not store a Caller ID message if no phone number appears in the message.
- If no key is pressed for more than 20 seconds, an error tone sounds and the telephone returns to the standby mode.
- If there is an incoming call or page, memory storage is cancelled and the telephone is set to the incoming call or page. If you get an incoming call, memory storage is canceled.

```
Replace Memory ?
Yes
No
```

## Memory dialing

### Making calls with memory dialing

#### On-hook dialing

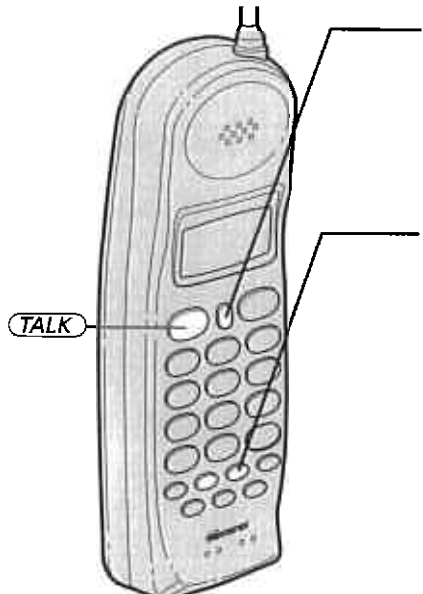

**1** Press **MEM**.  
The handset displays your programmed memory locations.

```
1 MEMCORP
2 JOHN DOE
3 MOM AND DAD
```

**2** Press the **▲** and **▼** keys to select the memory location you would like to dial.  
For example if the **▼** key is pressed once, the cursor move down to the next memory location number.

```
2 JOHN DOE
3 MOM AND DAD
4
```

Or press the number keypad to select the memory location you would like to dial.  
For example if you pressed 5 on the keypad, the display shows memory location number 5 with the cursor in that line.

```
5 MEMCORP
6 <Memory 6>
7
```

**3** Press **TALK**, "Talk" momentarily flashes on the display and the volume setting is appeared, then the displayed number is dialed.

```
Talk-
0123456789012
```

#### Notes

- To cancel memory selection, press **MEM** during selecting a memory location. The handset returns to standby.
- Whenever you are using a menu screen, you must press a key within 20 seconds or the phone will return to standby.

## Using the answering machine

### Setting the clock

The answering machine's clock starts when the AC adapter cord is plugged in.

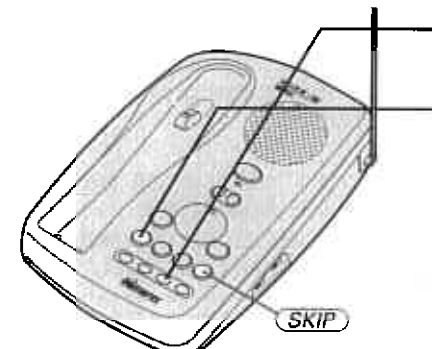

**1** Press **CLOCK** until you hear the long beep.

**2** First set the day by pressing **REPEAT** or **SKIP**.  
When the number appears on the LED display, press **CLOCK**.  
The unit announces the day currently selected.

**3** Next set the hour by pressing **REPEAT** or **SKIP**.  
When the correct numbers appear in the LED display, press **CLOCK**.

**4** Then set the Minute by pressing **REPEAT** or **SKIP**.  
When the correct numbers appear in the LED display, press **CLOCK**.

**5** Lastly, set AM/PM by pressing **REPEAT** or **SKIP**.  
The LED display will show A (AM) and P (PM) in turn. At the correct one, press **CLOCK**.  
You will hear a long beep.  
Then you will hear the new day and time.

#### Notes

- You can hear the current time set by pressing **CLOCK**.
- If a call comes in during clock setting, start over after the call.
- In case of power interruption, the clock stops. You must reprogram the time once power is restored.
- If you begin to set the clock, and you pause for more than two minutes, the unit returns to standby.

## Memory storing

You can store up to 10 phone numbers in the dial memory.

### Storing phone numbers and names

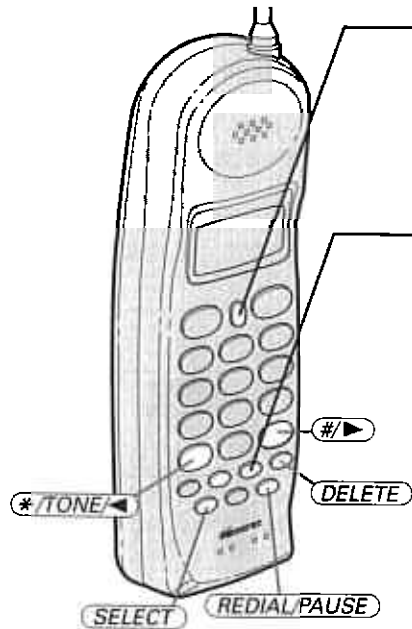

- 1 Press and hold **MEM** for 2 seconds until "Memory Store" is displayed.

```
Memory Store
1
2
```

- 2 Press **▲** or **▼** to scroll to the memory number where you would like to store the number.

```
Memory Store
7
8
```

Or press the keypad ( **0** to **9** ) to select the memory location where you would like to store the number.

- 3 Press **SELECT**.  
When an empty memory location is selected, "Store Name" is displayed. The cursor flashes indicating that the display is ready for the name to be entered.

If this screen appears, the memory location is full. You must edit the location. (See page 27.)

```
Store Name
```

```
Edit Memory 1
Delete Memory 1
Go Back
```

#### Note

Whenever you are using a menu screen, you must press a key within 20 seconds or the phone will return to standby. If you return the handset in the cradle the phone will return to standby too.

## Using the answering machine (continued)

### Turning the answering machine on and off

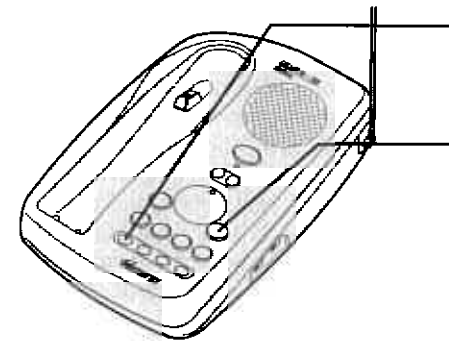

- 1 Press **ANSWER** to change the status from on to off. The LED display indicates the change.
- 2 When the unit is turned on, it initializes by playing the greeting. If you want to stop playing, press **PLAY/STOP**.

### Setting the number of rings

Choose one of three settings by sliding the **RING TIME** switch on the base unit to one of the following positions:

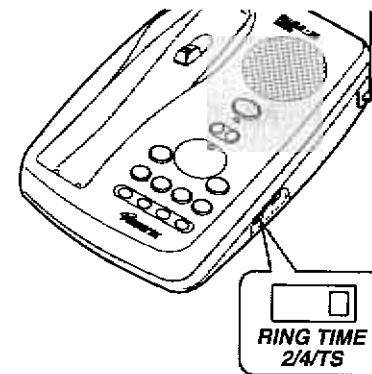

Check the LED display to see if the answering machine is on or off. If the LED display is on, the unit is on and ready to take messages. If the LED display is off, it will not take messages.

- 2 : 2 times
- 4 : 4 times

## Receiving calls (continued)

### Handset ringer tone

In the standby mode, press **▲** or **▼**.  
Each time **▲** or **▼** is pressed, the ringer tone setting changes and the selected ringer tone sounds for 2 seconds.

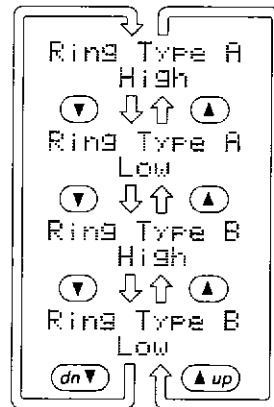

### Handset earpiece volume

Pressing **▲** or **▼** during a telephone call will change the earpiece volume of the handset. This setting will remain in effect after the telephone call has ended.

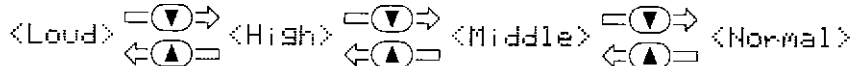

When you press **▲** in Loud mode or press **▼** in Normal mode, an error sound beeps.

## Using the answering machine (continued)

### Playing recorded messages

You can listen to message at the base unit.

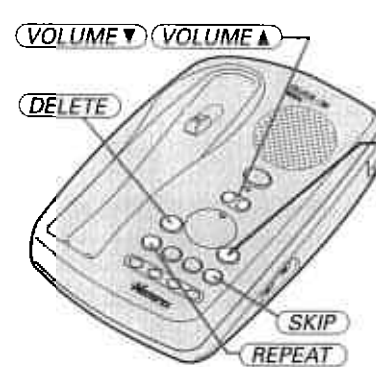

- 1 The number on the display blinks to indicate that there are new messages received.
- 2 Press **PLAY/STOP** to hear the messages. They will be played in the order they were received.

**To stop playback**, press **PLAY/STOP** any time.

**To repeat the message**, press **REPEAT**. To repeat the previous message, press **REPEAT** within 2 seconds after the current message has started. If you press after 2 seconds, the current message is repeated from the beginning.

**To go backward and repeat a message you choose**, press and hold **REPEAT** until your desired message number appears on the display.

**To skip to the next message**, press **SKIP**.

**To go forward**, press and hold **SKIP** until your desired message number appears on the display.

**To adjust the speaker volume**, press **VOLUME ▲** / **VOLUME ▼**.  
The volume level is displayed by a figure from 1 to 10.

### Redialing

The redial key redials the last number dialed. The redialed number can be up to 32 digits long.

#### On-hook redialing

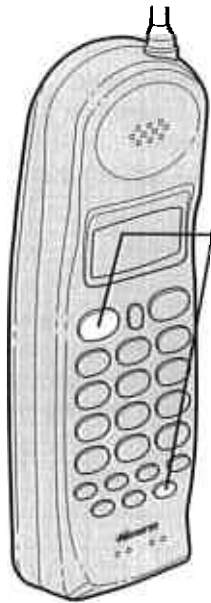

- 1 Press **REDIAL/PAUSE**. The phone number that was last dialed appears on the display.
- 2 Press **TALK**. "Talk" appears flashing on the display.
- 4 Then the phone number is dialed. After about 5 seconds, the call-time display appears.
- 5 Press **TALK** or place the handset on the base to end the telephone call. The call-time will be displayed for about 5 seconds.

#### Note

If the recently dialed number exceeds 32 digits, only the first 32 digits are retained for redialing.

#### Off-hook redialing

- 1 Press **TALK**. "Talk" appears flashing on the display.
- 2 Press **REDIAL/PAUSE**.
- 3 Press **TALK** or place the handset on the base to end the telephone call. The call-time will be displayed for about 5 seconds.

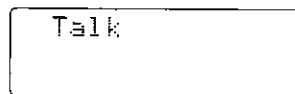

### Leaving a voice memo

You can record a memo by using the base unit, as a reminder to yourself or as a message for someone else in the household. A memo is stored and played back like any other incoming message, and the LED display will light to indicate that a message has been received.

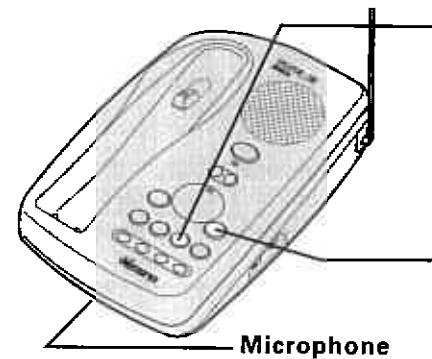

- 1 Press and hold **MEMO** for approximately 1 second.
- 2 After a long beep, turn to the microphone and begin speaking. Be sure to keep within 10 inches off the microphone while recording.
- 3 When you have finished the memo, press **MEMO** again, or press **PLAY/STOP**.

#### Note

If a call comes in during the memo recording, the unit will stop recording automatically and the ringer will sound. You will need to start over after the call. The memo must be at least 2 seconds long.

## On-hook dialing

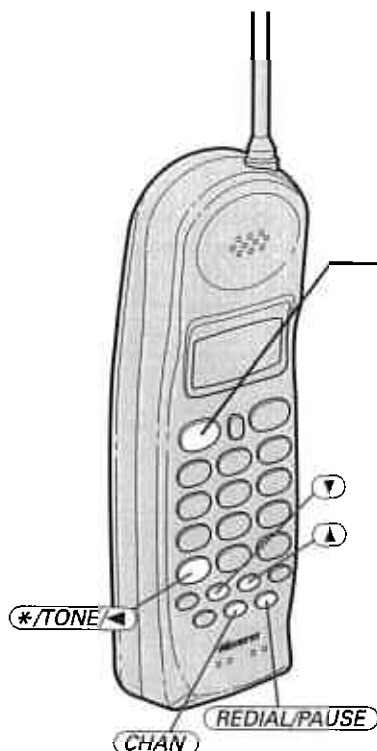

- 1 Dial the phone number.  
(Phone numbers can be up to 32 digits.)  
**Example:** Enter 800-919-3647  

8009193647
- 2 Press **TALK**. "Talk" flashes on the display.  

-Talk-  
8009193647
- 3 The number is dialed. After about 5 seconds, the call-time display appears.  

Talk 0:00  
8009193647
- 4 Press **TALK** or place the handset on the base to end the telephone call. The call-time will be displayed for about 5 seconds.  

5:15

### Other Operations

| To  | Do this  |
|---|--|
| To improve reception  | Press <b>CHAN</b> .  |
| To adjust the earpiece volume                                       | Press <b>▲</b> or <b>▼</b> .   |
| To temporarily switch to tone dial (base must be set to pulse mode) | Press <b>*/TONE</b> . The following numbers dialed will be sent as tone dialing. |
| To enter a pause within the numbers dialed                          | Press <b>REDIAL/PAUSE</b> .  |

### Notes

- If there is no key entry for more than 20 seconds, on-hook dialing is cancelled and the telephone returns to the standby mode.
- The phone number can be edited before pressing **TALK**.

## Selecting a PIN code

To play your messages from a remote location, you will need to enter a two-digit Personal Identification Number (PIN) code (00-99). To select a PIN, perform the following steps:

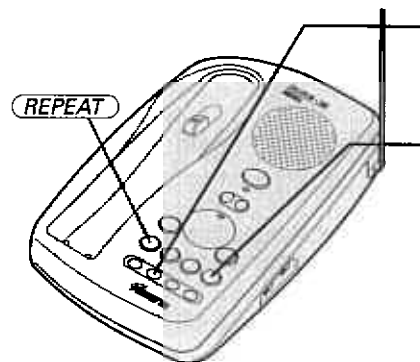

- 1 On the base, press and hold **PIN**. A beep sounds, and the LED displays **00**.
- 2 To set the first number, press **SKIP** or **REPEAT** to scroll from **0** to **9**. When the desired number appears in the display, press **PIN**.
- 3 To set the second number, press **SKIP** or **REPEAT** to scroll from **0** to **9**. When the desired number appears in the display, press **PIN**.

### Note

If you don't select a PIN code within two minutes, the system returns to standby.



## Setting Caller ID options

There are three Caller ID options, Auto Talk, CIDCW (Caller ID with Call Waiting), and Area Code.

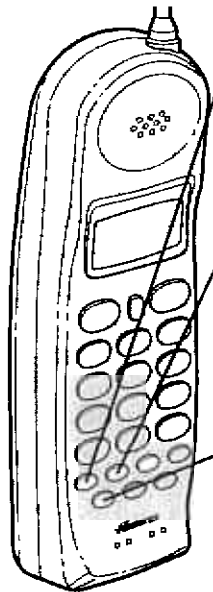

- 1** In the standby mode, hold down **CALLER ID** for 2 seconds until the Caller ID setting appears.

```
1▶Auto Talk:Off
2 CIDCW :On
3 Area Code:
```

- 2** Press **▲** or **▼** to move the cursor to the item that is to be set.

**Example:** To select CIDCW

```
1 Auto Talk:Off
2▶CIDCW :On
3 Area Code:
```

- 3** For Auto Talk and CIDCW press **SELECT** to toggle between on and off.  
For the Area Code setting please see page 16.

- 4** To complete the settings, press **CALLER ID**, then the handset returns to standby mode.

## Remote room monitor

You can call your answering system from any touch-tone phone and monitor sounds in the room where your base unit is installed.

- 1** Call your telephone number.
- 2** During the outgoing message playback, press **#** followed by your PIN code.
- 3** The answering system begins announcing the time and day stamp.
- 4** Press **#** then **\*** while the system announces the time and day stamp.

You hear sounds in the room where your phone is installed. After 15 seconds, the answering system returns to the command waiting mode.

- 5** Press **#** then **\*** to monitor the room for another 15 seconds. Or select another remote function. Or hang up to exit the system. The answering system automatically returns to standby.

## Step 3

### Preparing the battery pack

Charge the battery pack for more than 12-15 hours before connecting the phone line.

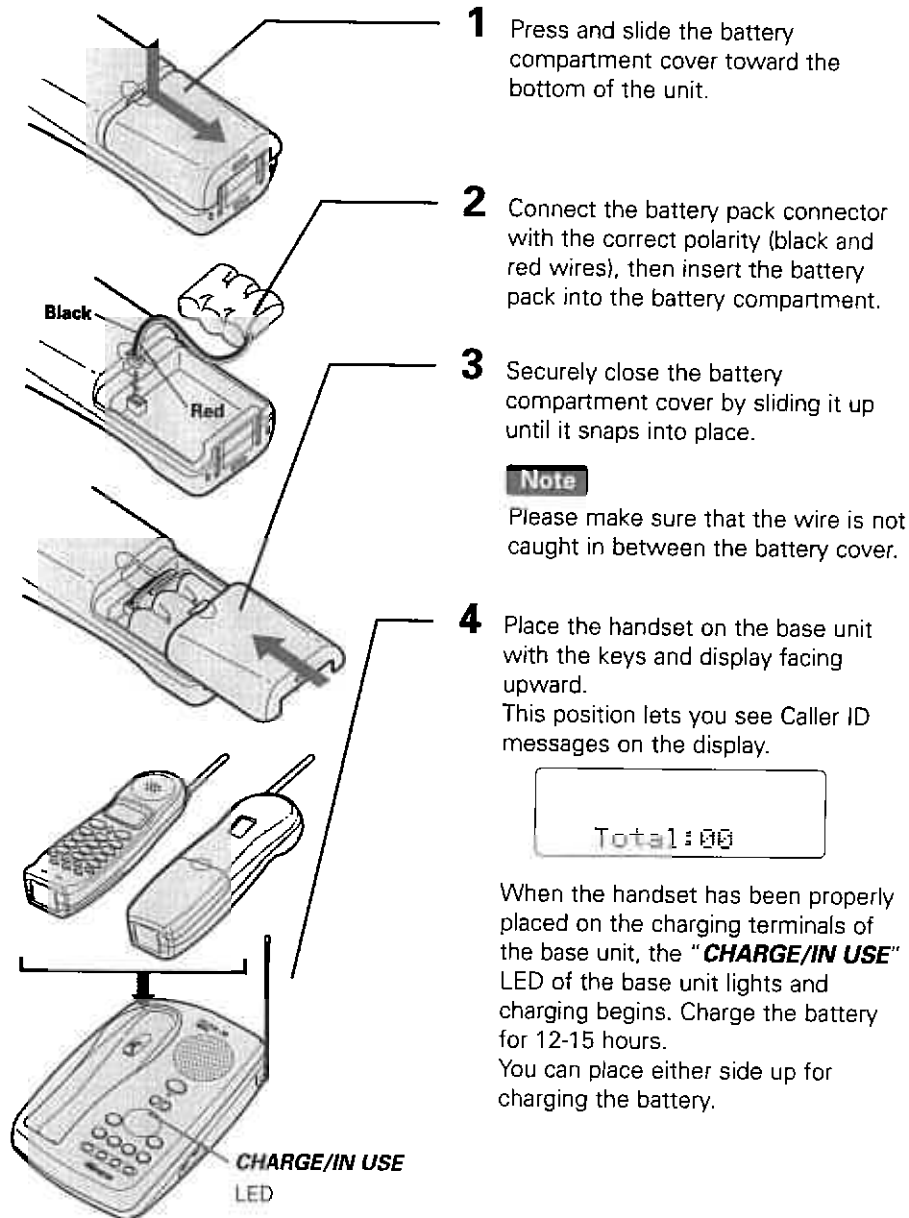

## Additional information (continued)

### Changing the digital security code

The digital security code is an identification code used to connect the handset and the base unit. Normally, setting the code is not necessary. The first time you charge your handset, the security code is automatically set. (See page 8.)

In the rare situation that you suspect another cordless telephone is using the same security code, you can change the code.

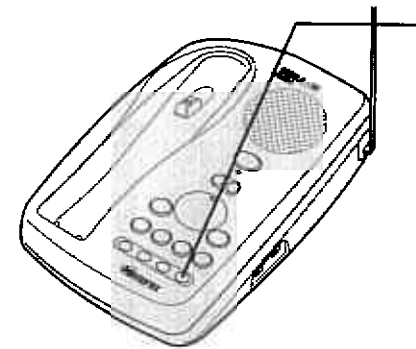

- 1** Place the handset on the base unit. Press **PAGE/FIND**. The handset beeps.
- 2** Remove the handset from the base unit.
- 3** Place the handset on the base unit. Leave the handset on the base for at least 3 seconds. A new random security code is set.

#### Note

If the handset battery pack is completely discharged or the battery pack removed, the digital security code will be lost. If this happens, a new security code is set automatically at the next time the battery pack is charged.

## Step 2 (continued)

### Connect the base unit

If you want to install the base unit on the wall, see page 51.

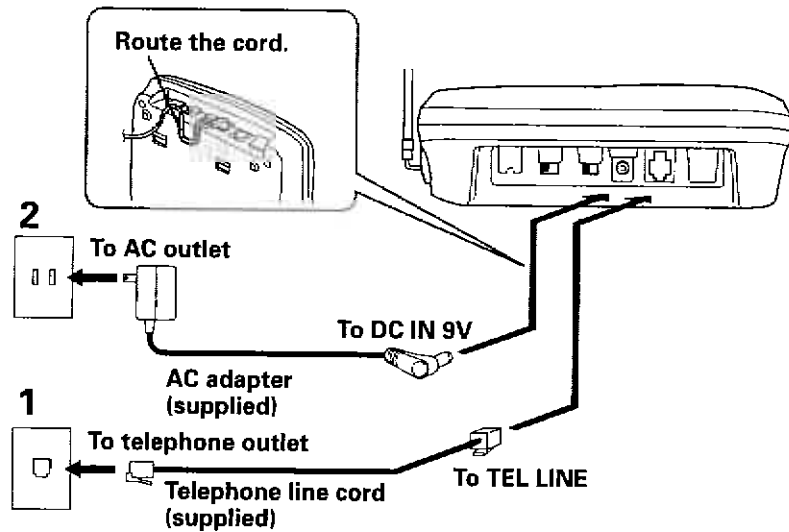

- 1 Connect the telephone line cord to the **TEL LINE** jack and to a telephone outlet.

**Note** Until the handset battery is fully charged, you can only answer incoming calls at the base unit.

- 2 Connect the AC adapter to the **DC IN 9V** jack and to a standard 120V AC wall outlet.
- 3 Set the base unit on a desk or table-top and place the handset on the base unit. Then raise the antenna to a vertical position.

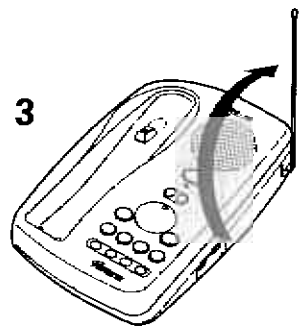

#### Note

Place the power cord so it does not create a trip hazard, or where it could become chafed and create a fire or electrical hazard.

## Additional information (continued)

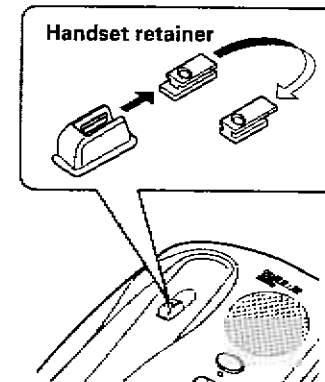

- 8 On the base unit, pull the handset retainer out of the slot. Rotate it clockwise 180 degrees.
- 9 Flip the retainer from front to back. Slide it back into the slot so that the lip of the retainer is up and the oval is down. The retainer holds the handset in place.

### Direct wall plate mounting

If you don't have a standard wall plate, you can mount your phone directly to the wall. Before doing this, consider the following:

- Avoid electrical cables, pipes, or other items behind the mounting location. That could cause a hazard when inserting screws into the wall.
- Try to mount your phone within 10 - 15 feet of a working phone jack to avoid excessive cord lengths.
- Make sure the wall material is capable of supporting the weight of the base and handset.

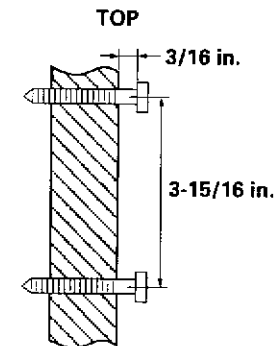

- 1 Insert two mounting screws into the wall (with their appropriate anchoring device), 3-15/16 inches apart. Allow about 3/16 of an inch between the wall and screwheads for mounting the phone.
- 2 Refer to steps 1 through 9 on page 51 and 52 to mount the telephone.

## Step 1

### Checking the package contents

Make sure you have received the following items in the package.



• Base unit



• Handset

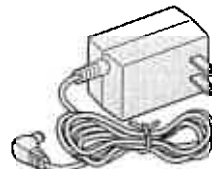

• AC adapter (AD-420)

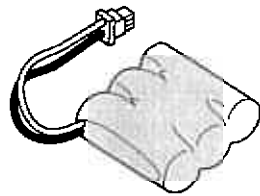

• Rechargeable battery pack (BT-905)  
(Located inside handset)

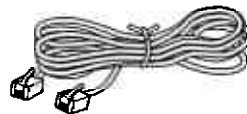

• Telephone line cord



• Wall mount adapter

• This Owner's Manual

## Additional information (continued)

### Troubleshooting

If your phone is not performing to your expectations, please try these simple steps first.

| Symptom   | Suggestion   |
|---|--|
| The <b>CHARGE/IN USE</b> LED won't come on when the handset is placed in the base unit. | <ul style="list-style-type: none"> <li>• Make sure the AC adapter is plugged into the base unit and wall outlet.</li> <li>• Make sure the handset is properly seated in the base unit.</li> <li>• Make sure the charging contacts on the handset and base unit are clean.</li> </ul>   |
| The audio sounds weak and/or scratchy.  | <ul style="list-style-type: none"> <li>• Make sure that the base unit antenna is in a vertical position.</li> <li>• Move the handset and/or base unit to a different location away from metal objects or appliances and try again.</li> <li>• Press <b>CHAN</b> to help eliminate background noise.</li> <li>• Make sure that you are not too far from the base.</li> </ul>    |
| Can't make or receive calls   | <ul style="list-style-type: none"> <li>• Check both ends of the base unit telephone line cord.</li> <li>• Make sure the AC adapter is plugged into the base unit and wall outlet.</li> <li>• Disconnect the AC adapter for a few minutes, then reconnect it.</li> <li>• Reset the digital security code (See page 50).</li> <li>• Make sure <b>TALK</b> is pressed.</li> </ul> |
| The handset doesn't ring or receive a page.   | <ul style="list-style-type: none"> <li>• The battery pack may be weak. Charge the battery on the base unit for 12-15 hours.</li> <li>• The handset may be too far away from the base unit.</li> <li>• Place the base unit away from appliances or metal objects.</li> <li>• Reset the digital security code (See page 50).</li> </ul>  |
| The Caller ID disappears.   | <ul style="list-style-type: none"> <li>• The handset was picked up before the second ring.</li> <li>• The call was placed through a switch board.</li> </ul>   |
| The Caller ID does not display.   | <ul style="list-style-type: none"> <li>• Call your local telephone company to verify your Caller ID service is current.</li> </ul>   |

## Introduction

Thank you for choosing the Memorex® MPH 6995 cordless telephone. This phone is designed to exacting standards that provide reliability, long life and outstanding performance.

**Note:** Some illustrations in this manual may differ from the actual unit for explanation purposes.

## Features

- 900 MHz Technology
- 3-line Backlit Display
- Face Up/Face Down Charging
- 32 Digit Redial
- Page/Find
- Handset Earpiece and Ringer Volume Control
- 15 minutes Record Memory
- Conversation Record and Voice Memo
- Call Waiting Caller ID
- 30 Number Caller ID Memory
- 10 Memory Dial Locations
- Pulse / Tone Dialing
- 7 Hour Talk Time
- Remote Message Retrieval
- Prerecorded Greetings Option
- Hearing Aid Compatible

The MPH 6995 features include **AutoTalk** and **AutoStandby**. **AutoTalk** allows you to answer a call by just removing the handset from the base so you don't have to waste time pushing buttons. **AutoStandby** allows you to hang up by simply returning the handset to the base.

The **UltraClear Plus** true compander circuitry virtually eliminates background noise. This innovative technology, together with 40 different channels, provides you with the best possible reception during all your conversations.

To protect you against misbilled calls which might result from your phone being activated by other equipment, the MPH 6995 has **Random Code™** digital security which automatically selects one of over 65,000 digital security codes for the handset and base. Also, the **AutoSecure™** feature electronically locks your phone when the handset is on the base.

To get the most from your phone, please read this reference guide thoroughly. Also, be sure to complete and mail the product registration form.

Memorex® is a registered trademark of the Memorex Telex N.V.

AutoTalk, AutoStandby, Random Code, and Auto Secure are proprietary trademarks of Uniden America Corporation.

## Additional information (continued)

## Specifications

### General

The MPH 6995 complies with FCC Parts 15 and 68.

Frequency control: PLL  
Modulation: FM  
Operating temperature: -10°C to +50°C (+14°F to +122°F)

### Base unit

RX frequency: 902.052 MHz to 904.002 MHz (40 channel)  
TX frequency: 925.997 MHz to 927.947 MHz (40 channel)  
Power requirements: 9V 350 mA (from AC adapter)  
Size: 7-23/64 in. (W) x 8-55/64 in. (D) x 2-1/4 in. (H)  
(187 mm (W) x 225 mm (D) x 57 mm (H))  
Weight: Approx. 21.2 oz. (Approx. 600 g)

### Handset

RX frequency: 925.997 MHz to 927.947 MHz (40 channel)  
TX frequency: 902.052 MHz to 904.002 MHz (40 channel)  
Power requirements: Rechargeable Nickel-Cadmium battery pack  
Size (without antenna): 3-11/32 in. (W) x 2-23/64 in. (D) x 9-9/16 in. (H)  
(85 mm (W) x 60 mm (D) x 243 mm (H))  
Weight: Approx. 9.8 oz. (277.4 g) (including battery)  
Battery: BT-905  
Capacity: 600 mA, 3.6V  
Talk mode: 7 hours TYP  
Standby mode: 14 days TYP

Specifications, features, and availability of optional accessories are all subject to change without prior notice.

## IMPORTANT ELECTRICAL CONSIDERATIONS

Unplug all electrical appliances when you know an electrical storm is approaching. Lightning can pass through your household wiring and damage any device connected to it. This phone is no exception.

**WARNING** Please do not attempt to unplug any appliance during an electrical storm.

### The FCC Wants You To Know

Changes or modifications to this product not expressly approved by the manufacturer, or operation of this product in any way other than as detailed by the reference guide, could void your authority to operate this product. The equipment cannot be used on public coin phone service provided by the telephone company. Connection to party line service is subject to state tariffs. (Contact the state public utility commission, public service commission or corporation commission for information.)

### Range

Your new phone is designed to achieve the maximum possible range by transmitting and receiving according to the highest specifications set forth by the FCC. We have rated this phone to operate at a maximum distance with the qualification that the range depends upon the environment in which the telephone is used. Many factors limit range, and it would be impossible to include all the variables in our rating. The Maximum Range rating of this phone is meant to be used as a means of comparison against other range claims.

### Telephone Line Problems

The FCC has granted the telephone company the right to disconnect service in the event that your phone causes problems on the telephone line. Also, the telephone company may make changes in facilities and services which may affect the operation of your unit. However, your telephone company must give adequate notice in writing prior to such actions to allow you time for making necessary arrangements to continue uninterrupted service.

If you are having trouble with your telephone service, you must first disconnect your phone to determine if it is the cause of your problem. If you determine that it is the cause, you must leave it disconnected until the trouble has been corrected.

## I.C. notice

**Notice:** The Industry Canada label identifies certified equipment. This certification means that the equipment meets certain telecommunications network protective, operational and safety requirements as prescribed in the appropriate Terminal Equipment Technical Requirements document(s). The Department does not guarantee the equipment will operate to the user's satisfaction.

Before installing this equipment, users should ensure that it is permissible to be connected to the facilities of the local telecommunications company. The equipment must also be installed using an acceptable method of connection. The customer should be aware that compliance with the above conditions may not prevent degradation of service in some situations.

Repairs to certified equipment should be coordinated by a representative designated by the supplier.

Any repairs or alterations made by the users of this equipment, or equipment malfunctions, may give the telecommunications company cause to request the user to disconnect the equipment.

Users should ensure for their own protection that the electrical ground connections of the power utility, telephone lines and internal metallic water pipe system, if present, are connected together.

This precaution may be particularly important in rural areas.

**Caution:** Users should not attempt to make such connections themselves, but should contact the appropriate electric inspection authority, or electrician, as appropriate."

**Notice:** The **Ringer Equivalence Number** (REN) assigned to each terminal device provides an indication of the maximum number of terminals allowed to be connected to a telephone interface.

The termination on an interface may consist of any combination of devices subject only to the requirement that the sum of the Ringer Equivalence Numbers of all the devices does not exceed 5.

### IMPORTANT INSTRUCTION TO USERS

Your model (MPH 6995) has been approved by the Industry Canada.

**Note:** Operation is subject to the following two conditions: (1) this device may not cause interference, and (2) this device must accept any interference, including interference that may cause undesired operation of the device.

Privacy of communications may not be ensured when using this telephone.

## IMPORTANT SAFETY INSTRUCTIONS

When using your telephone equipment, these basic safety precautions should always be followed to reduce the risk of fire, electrical shock, and injury to persons:

1. Read and understand all instructions.
2. Follow all warnings and instructions marked on the product.
3. Unplug this product from the wall outlet before cleaning. Use a dry cloth for cleaning without liquid or aerosol cleaners.
4. Do not use this product near water; for example, near a bath tub, wash bowl, kitchen sink or laundry tub, in a wet basement, or near a swimming pool.
5. Do not place this product on an unstable cart, stand, or table. The telephone may fall, causing serious damage to the unit.
6. Slots and openings in the cabinet and the back or bottom are provided for ventilation. To protect the product from overheating, these openings must not be blocked or covered. This product should never be placed near or over a radiator or heat register. This product should not be placed in a built-in installation unless proper ventilation is provided.
7. This product should be operated only from the type of power source indicated on the marking label. If you are not sure of the type of power supply to your home, consult your dealer or local power company.
8. Do not allow anything to rest on the power cord. Do not locate this product where the cord will be damaged by persons walking on it.
9. Do not overload wall outlets and extension cords, as this can result in the risk of fire or electrical shock.
10. Never push objects of any kind into this product through cabinet slots, as they may touch dangerous voltage points or short out parts that could result in a risk of fire or electric shock. Never spill liquid of any kind on the product.
11. To reduce the risk of electric shock, do not disassemble this product. Take it to qualified service personnel when service or repair work is required. Opening or removing covers may expose you to dangerous voltages or other risks. Incorrect reassembly can cause electric shock when the appliance is subsequently used.
12. Unplug this product from the wall outlet and refer servicing to qualified service personnel under the following conditions:
  - A. When the power supply cord is damaged or frayed.
  - B. If liquid has been spilled into the product.
  - C. If the product has been exposed to rain or water.

# Controls and functions

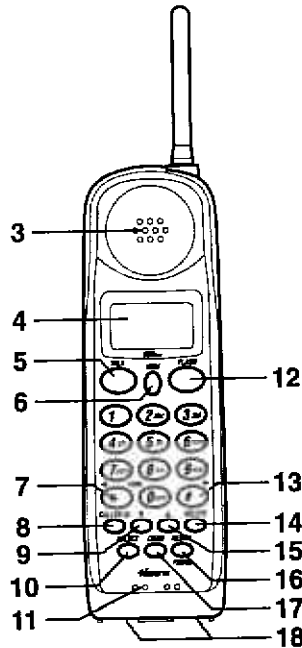
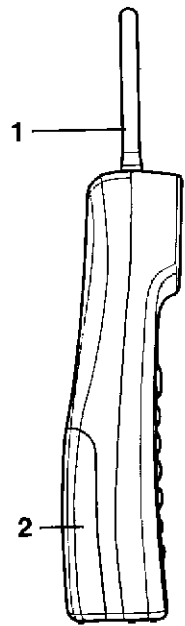

- 1. Handset antenna
- 2. Handset battery compartment
- 3. Handset earpiece
- 4. LCD display
- 5. Talk key
- 6. Memory key
- 7. Tone/Backspace key
- 8. Caller ID key
- 9. Volume/Cursor down key
- 10. Select key
- 11. Handset microphone
- 12. Flash key
- 13. Cursor forward key
- 14. Delete key
- 15. Volume/Cursor up key
- 16. Redial/Pause key
- 17. Channel key
- 18. Battery charge contact

- 19. Base microphone
- 20. Speaker key
- 21. Handset clip storage
- 22. Speaker LED
- 23. Volume down key
- 24. Charge/In use LED
- 25. Message counter display
- 26. Delete key
- 27. Outgoing message key
- 28. Repeat key
- 29. Base contact
- 30. Answer on/off key
- 31. Pin code key
- 32. Clock key
- 33. Page/Find key
- 34. Base speaker
- 35. Base antenna
- 36. Volume up key
- 37. Play/Stop key
- 38. Skip key
- 39. Memo key
- 40. Record time switch
- 41. Ring time switch
- 42. Reset switch
- 43. Ringer on-off switch
- 44. Pulse-Tone switch
- 45. DC power input
- 46. Phone jack

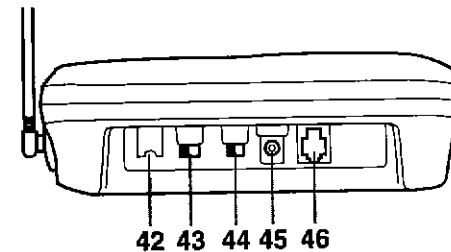
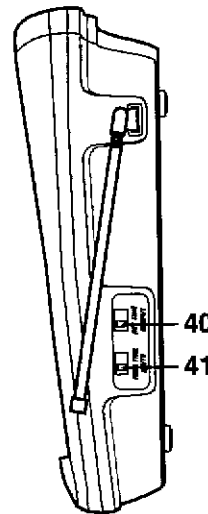
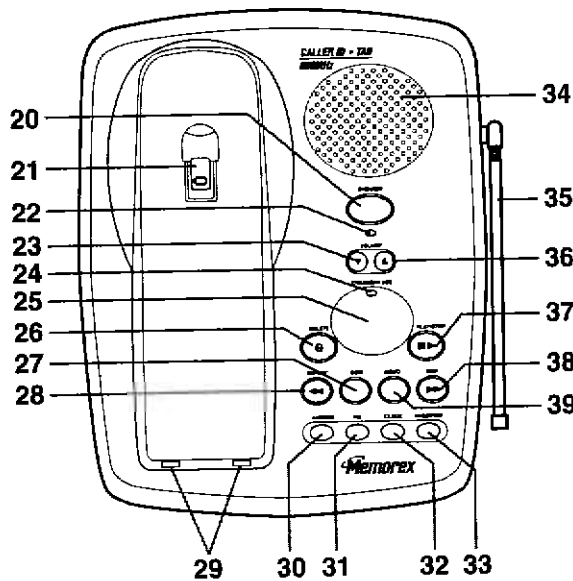
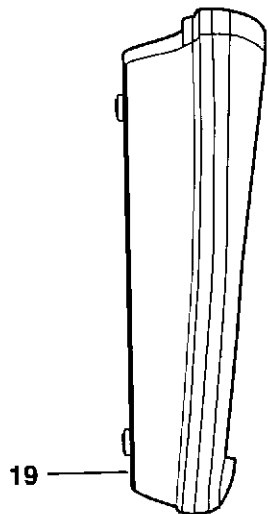



## Free Manuals Download Website

<http://myh66.com>

<http://usermanuals.us>

<http://www.somanuals.com>

<http://www.4manuals.cc>

<http://www.manual-lib.com>

<http://www.404manual.com>

<http://www.luxmanual.com>

<http://aubethermostatmanual.com>

Golf course search by state

<http://golfingnear.com>

Email search by domain

<http://emailbydomain.com>

Auto manuals search

<http://auto.somanuals.com>

TV manuals search

<http://tv.somanuals.com>