



Is it live or is it Memorex?TM

MVD4543 Suffix A

User's Guide

DVD/CD/VCD/MP3/PHOTO CD
Player and Video Cassette Recorder

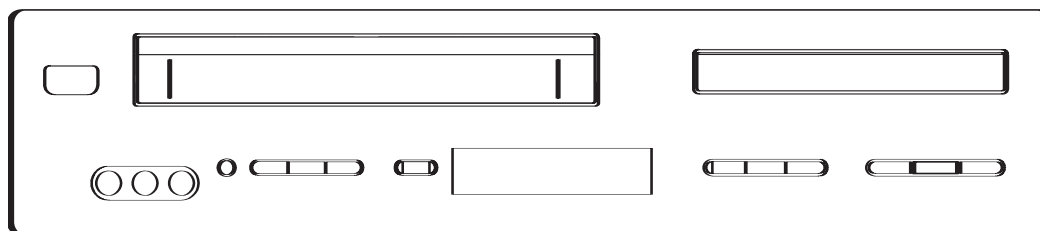

**Before operating this product,
please read these instructions completely.**

CONTENTS

Contents	1	• Tape Speed and Max. Recording Time	33
Important Safety Instructions	2	• Start/Stop Playback.	34
Precautions	5	• To Select the External Input.....	34
Power Source	6	• Counter Reset.....	34
Location of Controls	6	• Rewind/Fast Forward in Stop/Play Modes	35
• Display	6	• Pause/Step	35
• Front.....	7	• To View Another Program While Recording	36
• Rear	7	• Display	36
• Remote	8	• MTS/Audio	36
Remote Control	9	• Recording a TV Program/External A/V Input...37	
• Battery Installation	9	• Overlapping Timer Recordings	37
• Effective Distance of the Remote Control Transmitter	9	• To Stop Recording Temporarily/ To Stop Recording	38
Connection to Output DVD	10	• One-Touch Recording (OTR).....	38
• Connecting the Unit to a TV Using the Audio/Video Output Jacks	10	• Recording From DVD to a Cassette.....	39
• Connecting the Unit to a TV Using the S-Video Output Jack	10	Basic Operation	40
• Connecting the Unit to a TV Using the Y, Pb/Cb, Pr/Cr Jacks	11	• MTS/Audio	40
• Progressive (Y, PB, PR) Video OUT	11	• Display	40
• 525 Line Digital Progressive-Scan Component Video Output	11	DVD Basic Operation	41
• Connecting the Unit to a Home Theater System.....	12	• Playback of a DVD.....	41
Connections	13	• Skip	42
• Connecting the Unit to a TV Using the Audio/Video Output Jacks	13	• Search.....	42
• Connecting the Unit to a TV Using the RF Input/Output Jacks	13	• Slow/F	42
• Outdoor VHF/UHF Antenna Connection.....	14	• Pause/Step	42
CATV/Satellite Connections	14	• Title/Chapter Search	43
Connecting an External Unit to this Player (Using the Rear A/V Jacks)	15	• Title/Chapter/Time Search	43
Connecting an External Unit to this Player (Using the Front A/V Jacks)	15	• Repeat Playback.....	43
About Discs	16	• A-B Repeat Playback.....	43
DVD Setup Menu	18	• DVD Menu	44
• General Setup Menu.....	19	• Title Menu	44
• Speaker Setup Menu	20	• Subtitle Menu	44
• Dolby Digital Setup Menu	20	• Zoom.....	44
• Preference Menu	21	• Angle.....	44
• TVG (TV Guardian®) Password.....	21	MP3 Basic Operation	45
• TV Guardian® Feature.....	22	• Playback of a MP3.....	45
VCR Setup Menu	24	• Selecting Folders/Tracks using the SKIP Buttons.....	46
• Date and Time	24	• Selecting Folders/Tracks using the Number Buttons	46
• Timer Programming	25	• Forward/Reverse Search	46
• To Clear the Timer Program	26	• Repeat Play	46
• Channel Menu.....	27	• MP3 FAQs.....	46
• Language	28	CD/VCD Basic Operation	47
• Go To Zero Search	29	• Playback of a CD/VCD	47
• Counter Search.....	29	• Selecting Tracks/Files using the Number Buttons	47
• Index Search +/-	30	• Selecting Tracks/Files using the SKIP Buttons.....	47
• Index Number Search.....	31	• Forward/Reverse Search	48
• VCR Options.....	32	• Repeat One/All Play	48
VCR Operation	33	• Repeat A-B Play (VCD Only)	48
• Loading/Unloading	33	• PBC (VCD Only)	49
• To Prevent Accidental Erasure.....	33	PICTURE CD Basic Operation	50
		Troubleshooting Guide (DVD)	51
		Troubleshooting Guide (VCR)	53
		Care and Maintenance	54
		Video Head Clogging/Cleaning	55
		Specifications	56

IMPORTANT SAFETY INSTRUCTIONS



CAUTION

**RISK OF ELECTRIC SHOCK
DO NOT OPEN**



The lightning flash with arrowhead symbol within an equilateral triangle is intended to alert the user to the presence of uninsulated dangerous voltage within the product's enclosure that may be of sufficient magnitude to constitute a risk of electric shock to persons.



The exclamation point within an equilateral triangle is intended to alert the user to the presence of important operating and maintenance (servicing) instructions in the literature accompanying the appliance.

CAUTION: TO REDUCE THE RISK OF ELECTRIC SHOCK, DO NOT REMOVE COVER (OR BACK). NO USER-SERVICEABLE PARTS INSIDE. REFER SERVICING TO QUALIFIED SERVICE PERSONNEL.

This Caution Marking is located at the bottom enclosure of the unit.



The symbol for class II
(Double Insulation)

FCC NOTICE:

This equipment has been tested and found to comply with the limits for a Class B digital device, pursuant to part 15 of the FCC Rules. These limits are designed to provide reasonable protection against harmful interference in a residential installation. This equipment generates, uses and can radiate radio frequency energy and, if not installed and used in accordance with the instructions, may cause harmful interference to radio communications.

However, there is no guarantee that interference will not occur in a particular installation. If this equipment does cause harmful interference to radio or television reception, which can be determined by turning the equipment off and on, the user is encouraged to try to correct the interference by one or more of the following measures:

- Reorient or relocate the receiving antenna.
- Increase the separation between the equipment and receiver.
- Connect the equipment into an outlet on a circuit different from that to which the receiver is connected.
- Consult the dealer or an experienced radio/TV technician for help.

FCC CAUTION:

To assure continued compliance, follow the attached installation instructions and use only shielded cables when connecting to other devices. Also, any changes or modifications not expressly approved by the party responsible for compliance could void the user's authority to operate the equipment.

This Class B digital apparatus complies with Canadian ICES-003.

Cet appareil numérique de la classe B est conforme à la norme NMB-003 du Canada.

CAUTION:

THIS DIGITAL VIDEO DISC PLAYER EMPLOYS A LASER SYSTEM.

TO ENSURE PROPER USE OF THIS PRODUCT, PLEASE READ THIS OWNER'S MANUAL CAREFULLY AND RETAIN FOR FUTURE REFERENCE. SHOULD THE UNIT REQUIRE MAINTENANCE, CONTACT AN AUTHORIZED SERVICE LOCATION (SEE SERVICE PROCEDURE).

USE OF CONTROLS, ADJUSTMENTS OR THE PERFORMANCE OF PROCEDURES OTHER THAN THOSE SPECIFIED HEREIN MAY RESULT IN HAZARDOUS RADIATION EXPOSURE.

TO PREVENT DIRECT EXPOSURE TO LASER BEAM, DO NOT TRY TO OPEN THE ENCLOSURE. VISIBLE LASER RADIATION MAY BE PRESENT WHEN THE ENCLOSURE IS OPENED. DO NOT STARE INTO BEAM.

WARNING:

TO REDUCE THE RISK OF FIRE OR ELECTRIC SHOCK, DO NOT EXPOSE THIS PRODUCT TO RAIN OR MOISTURE.

WARNING:

TO REDUCE THE RISK OF FIRE OR ELECTRIC SHOCK, AND ANNOYING INTERFERENCE, USE THE RECOMMENDED ACCESSORIES ONLY.

SURGE PROTECTORS:

It is recommended to use a surge protector for AC connection. Lightning and power surges ARE NOT covered under warranty for this product.

ATTENTION:

POUR ÉVITER LES CHOC ÉLECTRIQUES, INTRODUIRE LA LAME LA PLUS LARGE DE LA FICHE DANS LA BORNE CORRESPONDANTE DE LA PRISES ET POUSSER JUSQU'AU FOND.

Manufactured under license from Dolby Laboratories.
"Dolby" and the double-D symbol are trademarks of Dolby Laboratories.

IMPORTANT SAFETY INSTRUCTIONS (CONTINUED)

IMPORTANT:

PLEASE KEEP ALL PACKAGING MATERIAL FOR AT LEAST 90 DAYS IN CASE YOU NEED TO RETURN THIS PRODUCT TO YOUR PLACE OF PURCHASE OR TO MEMOREX.

Before using the unit, be sure to read all operating instructions carefully. Please note that these are general precautions and may not pertain to your unit. For example, this unit may not have the capability to be connected to an outdoor antenna.

1. READ INSTRUCTIONS

All the safety and operating instructions should be read before the product is operated.

2. RETAIN INSTRUCTIONS

The safety and operating instructions should be retained for future reference.

3. HEED WARNINGS

All warnings on the product and in the operating instructions should be adhered to.

4. FOLLOW INSTRUCTIONS

All operating and use instructions should be followed.

5. CLEANING

Unplug this product from the wall outlet before cleaning. Do not use liquid cleaners or aerosol cleaners. Use a dry cloth for cleaning.

6. ATTACHMENTS

Do not use attachments not recommended by the product's manufacturer as they may cause hazards.

7. WATER AND MOISTURE

Do not use this product near water—for example: near a bathtub, washbowl, kitchen sink or laundry tub; in a wet basement; or near a swimming pool.

8. ACCESSORIES

Do not place this product on an unstable cart, stand, tripod, bracket or table. The product may fall, causing serious injury and serious damage to the product. Use only with a cart, stand, tripod, bracket or table recommended by the manufacturer or sold with the product. Any mounting of the product should follow the manufacturer's instructions, and should use a mounting accessory recommended by the manufacturer.

8A. An appliance and cart combination should be moved with care. Quick stops, excessive force and uneven surfaces may cause the appliance and cart combination to overturn.

9. VENTILATION

Slots and openings in the cabinet and in the back or bottom are provided for ventilation, to ensure reliable operation of the product and to protect it from overheating. These openings must not be blocked or covered. The openings should never be blocked by placing the product on a bed, sofa, rug or other similar surface. This product should never be placed near or over a radiator or heat source. This product should not be placed in a built-in installation such as a bookcase or rack unless proper ventilation is provided or the manufacturer's instructions have been adhered to.

10. POWER SOURCES

This product should be operated only from the type of power source indicated on the marking label. If you are not sure of the type of power supply to your home, consult your appliance dealer or local power company. For products intended to operate from battery power, or other sources, refer to the operating instructions.

11. GROUNDING OR POLARIZATION

This product is equipped with a polarized alternating-current line plug (a plug having one blade wider than the other). This plug will fit into the power outlet only one way. This is a safety feature. If you are unable to insert the plug fully into the outlet, try reversing the plug. If the plug should still fail to fit, contact your electrician to replace your obsolete outlet. Do not defeat the safety purpose of the polarized plug.

12. POWER-CORD PROTECTION

Power-supply cords should be routed so that they are not likely to be walked on or pinched by items placed upon or against them, paying particular attention to cords at plugs, convenience receptacles, and the point where they exit from the appliance.

13. LIGHTNING

To protect your product from a lightning storm, or when it is left unattended and unused for long periods of time, unplug it from the wall outlet and disconnect the antenna or cable system. This will prevent damage to the product due to lightning and power-line surges.

14. POWER LINES

An outside antenna system should not be located in the vicinity of overhead power lines or other electric light or power circuits, or where it can fall into such power lines or circuits. When installing an outside antenna system, extreme care

PORTABLE CART WARNING
(symbol provided by RETAC)



S3126A

IMPORTANT SAFETY INSTRUCTIONS (CONTINUED)

should be taken to keep from touching such power lines or circuits as contact with them might be fatal.

15. OVERLOADING

Do not overload wall outlets and extension cords as this can result in a risk of fire or electric shock.

16. OBJECT AND LIQUID ENTRY

Never push objects of any kind into this product through openings as they may touch dangerous voltage points or short out parts that could result in fire or electric shock. Never spill or spray any type of liquid on the product.

17. OUTDOOR ANTENNA GROUNDING

If an outside antenna is connected to the product, be sure the antenna system is grounded so as to provide some protection against voltage surges and built-up static charges. Section 810 of the National Electric Code, ANSI/NFPA 70, provides information with respect to proper grounding of the mast and supporting structure, grounding of the lead-in wire to an antenna discharge product, size of grounding conductors, location of antenna discharge product, connection to grounding electrodes and requirements for grounding electrodes.

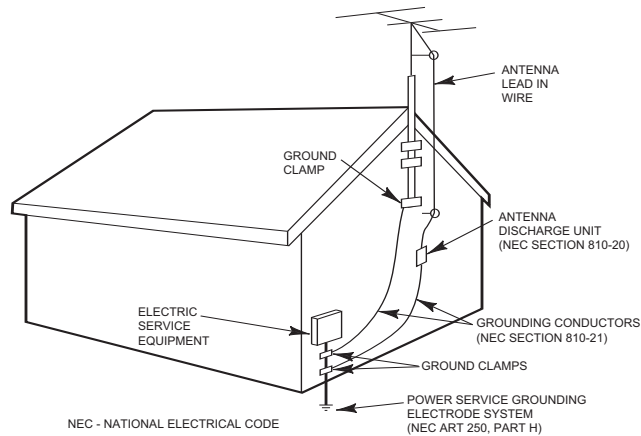

EXAMPLE OF ANTENNA GROUNDING AS PER NATIONAL ELECTRICAL CODE

18. SERVICING

Do not attempt to service this product yourself as opening or removing covers may expose you to dangerous voltage or other hazards. Refer all servicing to qualified service personnel.

19. REPLACEMENT PARTS

When replacement parts are required, be sure the service technician uses replacement parts specified by the manufacturer or those that have the same characteristics as the original part. Unauthorized substitutions may result in fire, electric shock or other hazards.

20. SAFETY CHECK

Upon completion of any service or repairs to this product, ask the service technician to perform safety checks to determine that the product is in proper operating condition.

21. WALL OR CEILING MOUNTING

The product should be mounted to a wall or ceiling only as recommended by the manufacturer.

22. DAMAGE REQUIRING SERVICE

Unplug the product from the wall outlet and refer servicing to qualified service personnel under the following conditions:

- When the power-supply cord or plug is damaged.
- If liquid has been spilled or objects have fallen into the product.
- If the product has been exposed to rain or water.
- If the product does not operate normally by following the operating instructions. Adjust only those controls that are covered by the operating instructions, as an adjustment of other controls may result in damage and will often require extensive work by a qualified technician to restore the product to its normal operation.
- If the product has been dropped or the cabinet has been damaged.
- When the product exhibits a distinct change in performance—this indicates a need for service.

23. HEAT

The product should be situated away from heat sources such as radiators, heat registers, stoves or other products (including amplifiers) that produce heat.

24. NOTE TO CATV SYSTEM INSTALLER

This reminder is provided to call the CATV system installer's attention to Article 820-40 of the NEC that provides guidelines for proper grounding and, in particular, specifies that the cable ground shall be connected to the grounding system of the building, as close to the point of cable entry as practical.

PRECAUTIONS

NOTES ON HANDLING:

- When shipping the player, always use the original shipping carton and packing materials. For maximum protection, repack the unit as it was originally packed at the factory.
- Do not use volatile liquids, such as insect spray, near the player. Do not leave rubber or plastic products in contact with the player for a long time. They will leave marks on the finish.
- The top and rear panels of the player may become warm after a long period of use. This is normal and not a malfunction.
- When the player is not in use, be sure to remove the disc and turn off the power.
- If you do not use the player for a long period, the unit may not function properly in the future. Turn on and use the player occasionally.
- Do not insert fingers or any other objects into the cassette-loading slot. Do not spray cleaner or wax directly on the VCR or use forced air to remove dust.
- Avoid places subject to strong vibration. Use in a horizontal (flat) position only.
- When you finish operating the unit, always unload the cassette and turn off the power.
- To protect the player during a lightning storm, unplug the AC power cord from the wall outlet. Do not touch the antenna leads.

NOTES ON LOCATING THE UNIT:

- When you place this player near a TV or radio, the playback picture may become poor and the sound may be distorted. In this case, move the player away from the TV or radio.

NOTES ON CLEANING:

Use a soft, dry cloth for cleaning.

- For stubborn dirt, soak the cloth in a weak detergent solution, wring well and wipe. Use a dry cloth to wipe it dry. Do not use any type of solvent, such as thinner and benzene, as they may damage the surface of the player.
- If you use a chemical-saturated cloth to clean the unit, follow that product's instructions.

Warning: Cleaning and adjustment of lenses and/or other components of playback mechanism should be performed by a qualified service technician.

TO OBTAIN A CLEAR PICTURE:

DVD: The DVD player is a high technology, precision device. If the optical pick-up lens and disc drive parts are dirty or worn down, the picture quality becomes poor. To obtain a clear picture, we recommend regular inspection and maintenance (cleaning or parts replacement) every 1,000 hours of use depending on the operating environment. For details, contact your nearest dealer.

VCR: See page 55 for video head cleaning instructions.

NOTES ON MOISTURE CONDENSATION:

Moisture condensation damages the player. Please read the following carefully.

- Moisture condensation occurs, for example, when you pour a cold drink into a glass on a warm day. Drops of water form on the outside of the glass. In the same way, moisture may condense on the optical pick-up lens inside this unit, one of the most crucial internal parts of the player.

Moisture condensation occurs during the following cases:

- When you bring the player directly from a cold place to a warm place.
- When you use the player in a room where you just turned on the heater, or a place where the cold wind from the air conditioner directly hits the unit.
- In summer, when you use the player in a hot and humid place just after you moved the unit from an air conditioned room.
- When you use the player in a humid place.

Do not use the player when moisture condensation may occur.

- If you use the player in such a situation, it may damage discs and internal parts. Remove the disc, connect the power cord of the player to the wall outlet, turn on the player and leave it "ON" for two or three hours. After two or three hours, the player will have warmed up and evaporated any moisture. Keep the player connected to the wall outlet and moisture condensation will seldom occur.

POWER SOURCE

Insert the AC plug (with the 2 blades) into a conveniently located AC outlet having 120V, 60Hz.

NOTE: The AC plug supplied with the unit is polarized to help minimize the possibility of electric shock. If the AC plug does not fit into a nonpolarized AC outlet, do not file or cut the wide blade. It is the user's responsibility to have an electrician replace the obsolete outlet.

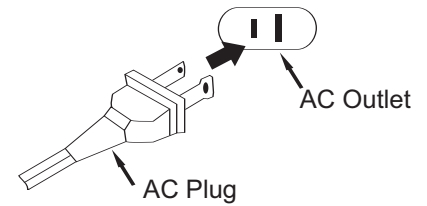

LOCATION OF CONTROLS

DISPLAY

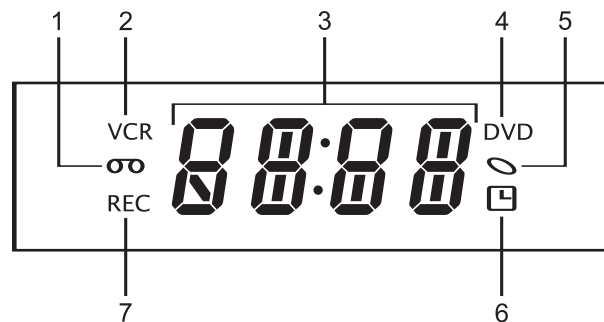

1. **Video Cassette Tape Indicator**—When a video cassette tape is inserted, the indicator will light.
2. **VCR Mode Indicator**
3. **Status/Time Display**
4. **DVD Mode Indicator**
5. **Disc Indicator**—When a disc is inserted into the disc tray, after loading the disc, the indicator will light.
6. **Timer Indicator**
7. **REC Indicator**

LOCATION OF CONTROLS (CONTINUED)

FRONT

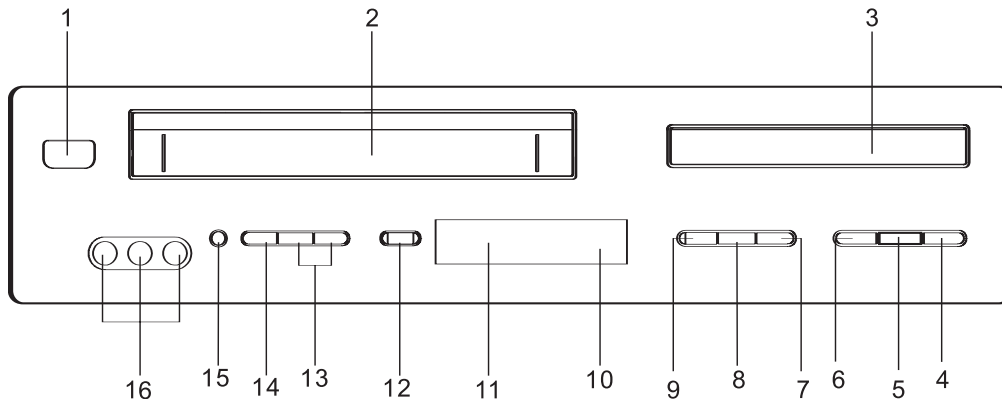

- | | |
|---|--|
| <ol style="list-style-type: none"> 1. POWER (STANDBY/ON) Button 2. Cassette Compartment 3. Disc Tray 4. Disc Skip Up $\blacktriangleright\blackparallel$/Tape Fast Forward Button 5. PLAY/PAUSE ($\blacktriangleright\parallel$) Button 6. Disc Skip Down $\blacktriangleleft\blackparallel$/Tape Rewind Button 7. STOP \blacksquare Button 8. Disc Tray Open/Close Button 9. DVD/VCR Button | <ol style="list-style-type: none"> 10. Remote Sensor 11. Display 12. RECORD Button 13. CHANNEL Up/Down Buttons 14. TV/VCR Button 15. EJECT Button (VCR) 16. Video IN, Audio L & R Input Jacks (For Video 2) |
|---|--|

REAR

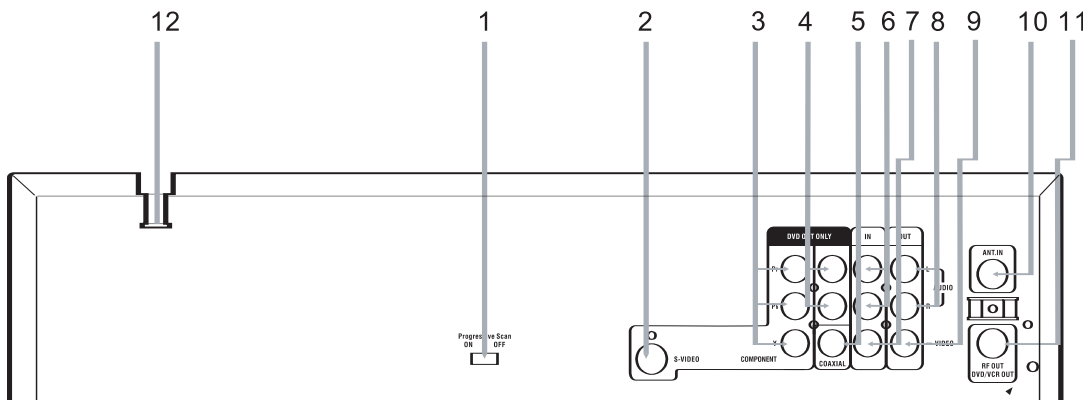

- | | |
|--|---|
| <ol style="list-style-type: none"> 1. Progressive Scan On/Off Switch (DVD ONLY) 2. S-Video Out Jack (DVD ONLY) 3. Component Video Out Jacks (Y, Pb/Cb, Pr/Cr) (DVD ONLY) 4. DVD Audio L & R Out Jacks (DVD ONLY) 5. Coaxial Digital Out Jack (DVD ONLY) | <ol style="list-style-type: none"> 6. Audio L & R In Jacks (For Video 1) 7. Video In Jack (For Video 1) 8. Audio L & R Out Jacks 9. Video Out Jack 10. Antenna In 11. RF Out 12. AC Power Cord |
|--|---|

LOCATION OF CONTROLS (CONTINUED)

REMOTE

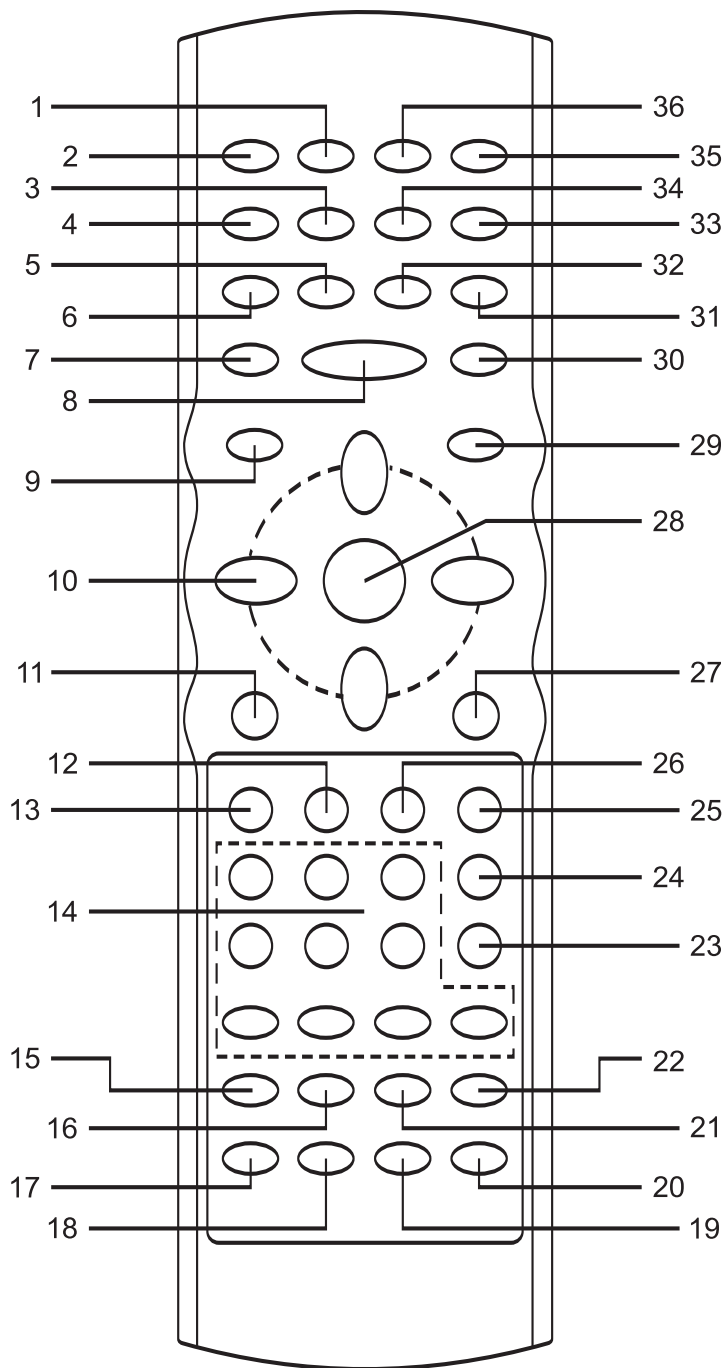

1. TVG (TV Guardian®) Button
2. POWER Button
3. TITLE Button
4. SUBTITLE Button
5. ZOOM Button
6. STEP Button
7. REC Button (VCR)
8. PLAY/PAUSE (▶||) Button
9. VCR Button
10. NAVIGATION Buttons (◀/▶/▲/▼) *
11. SETUP Button
12. SKIP ►► Button
13. SKIP ◀◀ Button
14. NUMBER Buttons
15. SP/SLP Button (VCR)
16. AV1/AV2 Button
17. ANGLE Button
18. REPEAT Button
19. REPEAT A-B Button
20. DISPLAY Button
21. TV/VCR Button
22. COUNTER RESET/CLEAR (To Clear VCR Timer Recording Program) Button
23. 100 Button
24. PROGRAM Button (VCR)
25. FORWARD SEARCH ►► Button
26. REVERSE SEARCH ◀◀ Button
27. DVD MENU Button
28. OK Button
29. DVD Button
30. STOP ■ Button
31. SLOW/F Button
32. MTS/AUDIO Button
33. PBC Button
34. RETURN Button (DVD)
35. OPEN/CLOSE Button (DVD), EJECT Button (VCR)
36. SEARCH Button

* The NAVIGATION ▲/▼ buttons are also used as Channel Up/Down buttons when in VCR or TV mode.

REMOTE CONTROL

BATTERY INSTALLATION

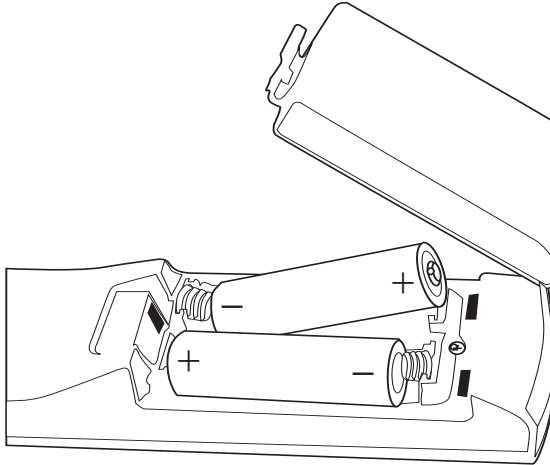

1. Open the Battery Compartment cover by pushing in on the tab and lifting it out.
2. Install two (2) "AA" batteries (not included), paying attention to the polarity diagram in the Battery Compartment.
3. Replace the Battery Compartment cover.

BATTERY PRECAUTIONS

Follow these precautions when using batteries in this device:

1. Use only the size and type of batteries specified.
2. Be sure to follow the correct polarity when installing the batteries as indicated in the Battery Compartment. Reversed batteries may cause damage to the device.
3. Do not mix different types of batteries together (e.g. Alkaline, Rechargeable and Carbon-zinc) or old batteries with fresh ones.
4. If the device is not to be used for a long period of time, remove the batteries to prevent damage or injury from possible battery leakage.
5. Do not try to recharge batteries not intended to be recharged; they can overheat and rupture. (Follow battery manufacturer's directions.)

EFFECTIVE DISTANCE OF THE REMOTE CONTROL TRANSMITTER

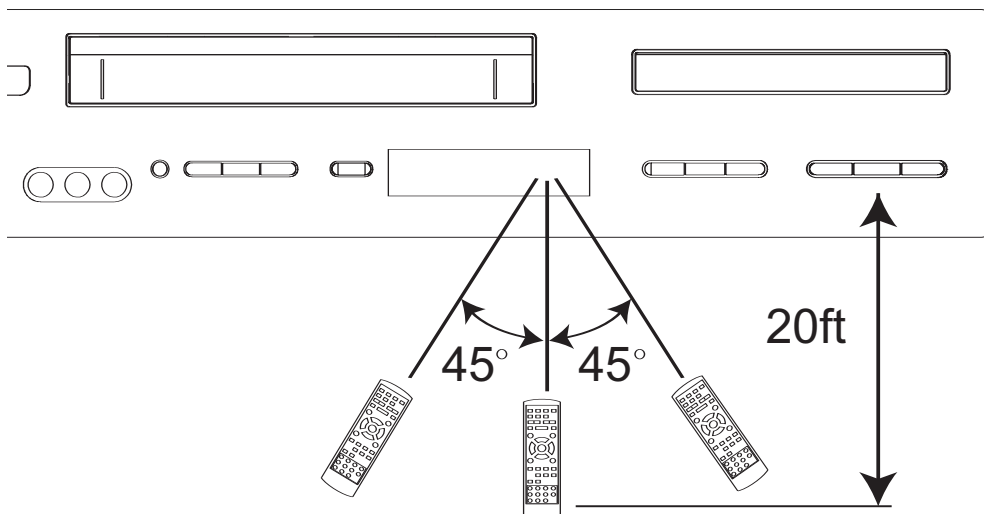

NOTES:

- When there is an obstacle between the unit and the transmitter, the transmitter may not operate.
- When direct sunlight, an incandescent lamp, fluorescent lamp or any other strong light shines on the REMOTE SENSOR of the unit, the remote operation may be unstable.

CONNECTION TO OUTPUT DVD

CONNECTING THE UNIT TO A TV USING THE AUDIO/VIDEO OUTPUT JACKS (FOR DVD AND VCR)

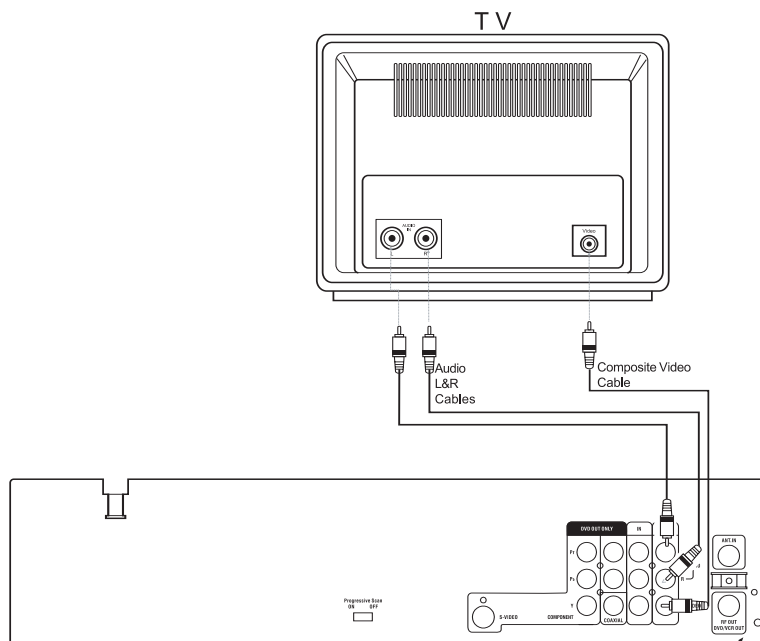

CONNECTING THE UNIT TO A TV USING THE S-VIDEO OUTPUT JACK (FOR DVD ONLY)

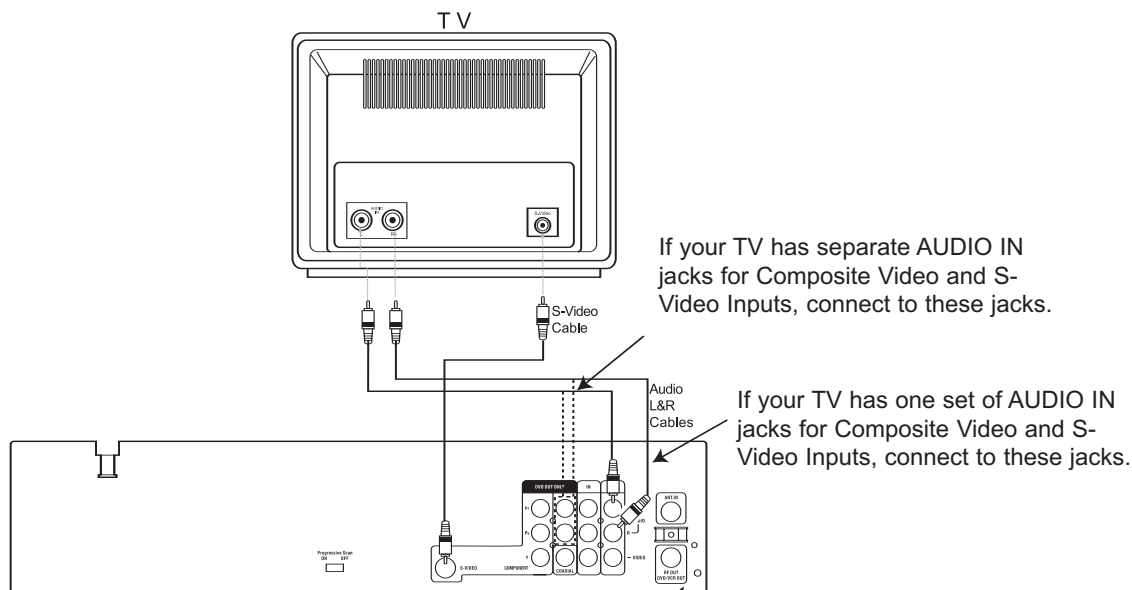

NOTES:

- If your TV has a Component input, connect the player with the Component cable as described on the following page for best results.
- Set the TV's TV/VIDEO button or switch to the VIDEO setting.
- When connecting, refer to the owner's manual of the TV, as well as this manual.
- When connecting, make sure the power is off and both units are unplugged before making any connections.
- If your TV only has one audio input, the use of a "Y" connector may be necessary. Visit your local electronics supply store.
- Set the VIDEO OUT Option (on the GENERAL Menu Page) to S-VIDEO if using the S-Video Out jack.
- The connections on this page can only be used for DVD Playback, not for VCR playback.
- If using a TV with a blue screen option, turn the option off on the TV for best results.
- Connect a cable, etc. signal as described on pages 13 and 14 to use the tuner capabilities of this unit.
- The S-VIDEO output jack connection can only be used for DVD playback, not for VCR or TV mode.

CONNECTION TO OUTPUT DVD (CONTINUED)

CONNECTING THE UNIT TO A TV USING THE Y, Pb/Cb, Pr/Cr JACKS

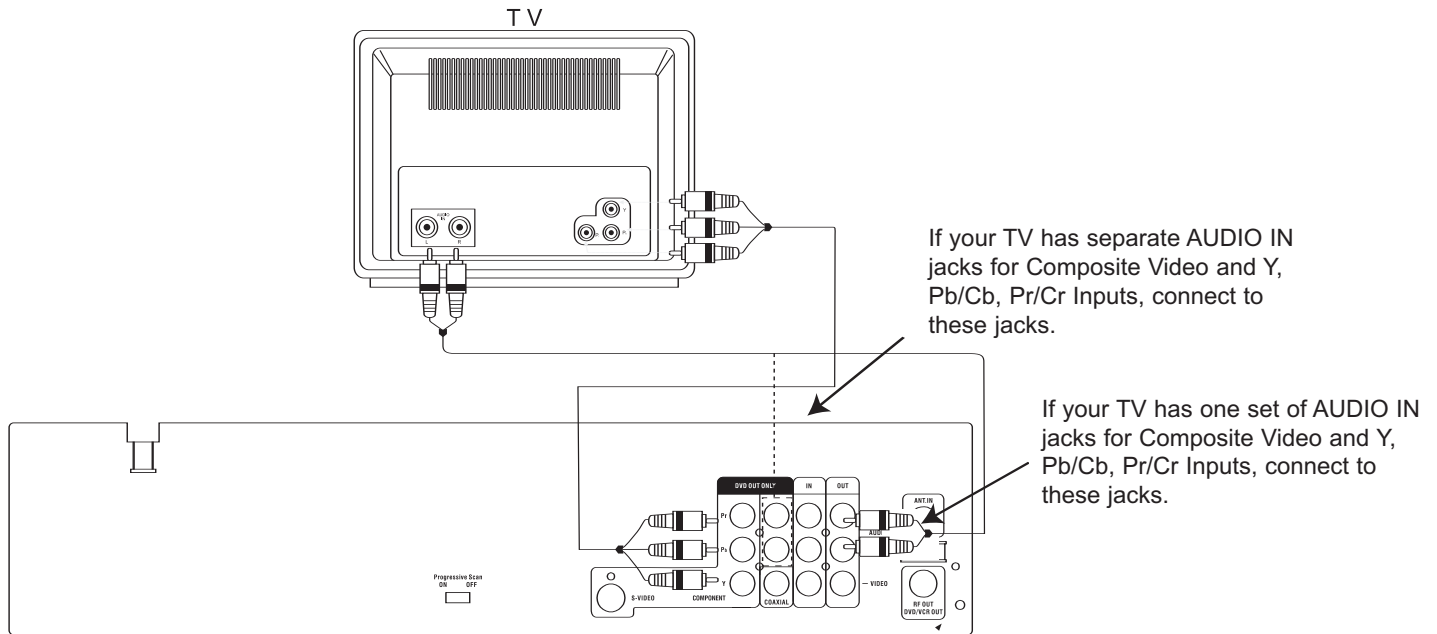

NOTES FOR CONNECTING:

- Set the VIDEO OUT Option (on the GENERAL Menu Page) to YUV if using the Component Video Out jack.
- Your TV must have Y, Pb, Pr or Y, Cb, Cr Input jacks.
- Set the TV's TV/VIDEO button or switch to the VIDEO setting.
- When connecting, refer to the owner's manual of the TV, as well as this manual.
- When connecting, make sure the power is off and both units are unplugged before making any connections.
- Component Y, Pb/Cb, Pr/Cr Jacks can only be used for DVD Playback, not for VCR or TV mode.
- If using a TV with a blue screen option, turn the option off, on the TV for best results.

PROGRESSIVE (Y, Pb, Pr) VIDEO OUT:

Use these jacks to connect to a TV with progressive video input jacks, then set the PROGRESSIVE SCAN switch to ON. Progressive Scan is a video scanning system that displays all lines in a frame in one pass, as opposed to the traditional system, interlaced scan. This connection provides optimum quality. To ensure maximum picture quality, use three video-grade cables for connections. Note that it is essential to match the color-coded connectors with a compatible TV.

525 LINE DIGITAL PROGRESSIVE-SCAN COMPONENT VIDEO OUTPUT

Compared to standard interlaced video, Progressive Scan effectively doubles the amount of video information fed to your TV or monitor. The result is a stable, flicker-free image. (Check your TV/monitor for compatibility with this feature.) For the very highest picture quality, try watching a movie on DVD-Video on a Progressive-Scan compatible TV.

NOTES:

- If you connect a TV that is not compatible with a Progressive Scan signal and set the PROGRESSIVE SCAN switch to ON, you will not be able to see any picture at all or "PSCAN" will appear on the screen. Slide the PROGRESSIVE SCAN switch to the OFF position to turn the progressive scan function off.
- CONSUMERS SHOULD NOTE THAT NOT ALL HIGH DEFINITION TELEVISION SETS ARE FULLY COMPATIBLE WITH THIS PRODUCT AND MAY CAUSE ARTIFACTS TO BE DISPLAYED IN THE PICTURE. IN CASE OF 525 PROGRESSIVE SCAN PICTURE PROBLEMS, IT IS RECOMMENDED THAT THE USER SET THE PROGRESSIVE SCAN SWITCH TO OFF.
- To turn off the Progressive Scan function, turn off the unit as described above and switch the Progressive Scan switch OFF. The Progressive Scan function will turn off whenever you turn on the player and TV.

CONNECTION TO OUTPUT DVD (CONTINUED)

CONNECTING THE UNIT TO A HOME THEATER SYSTEM

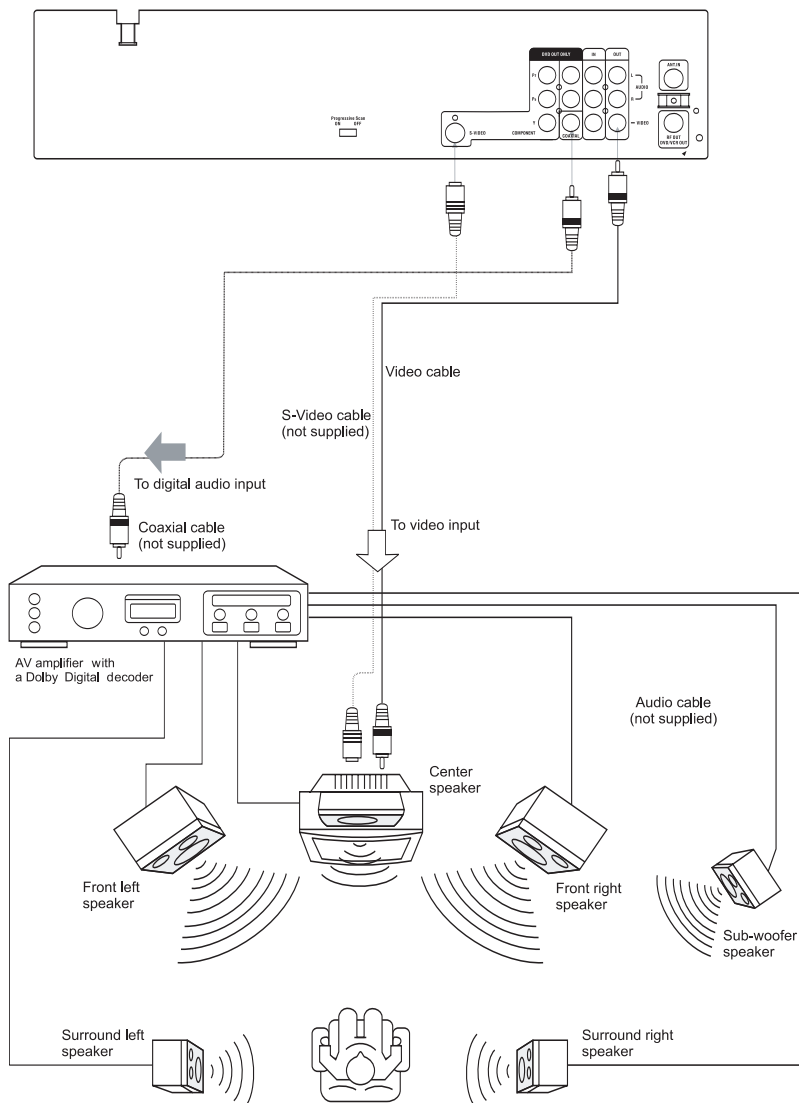

Place the subwoofer, front, rear and center speakers in locations as shown/described here. After correctly positioning the speakers, perform the Tone Test on the AV Amplifier and adjust the volume controls until the desired sound is achieved. For best results, sit in the viewing position and have someone adjust the volumes for you; this will enable you to set the optimal levels.

NOTE:

- The rear speakers can also be located on the side wall facing the viewing position and each other. Make sure the viewing position is located between the two speakers in this case. Experiment to find the optimal position.

NOTES FOR CONNECTING TO A HOME THEATER SYSTEM:

- If your TV has a Component input, connect the unit with the component cable for best results, otherwise use the S-Video or Video OUT jack on the unit.
- Set the TV's TV/VIDEO button or switch to the VIDEO setting.
- When connecting the unit, refer to the owner's manuals for the TV and the audio system, as well as this manual.
- When connecting, make sure the power is off and all units are unplugged before making any connections.
- If using a TV with a blue screen option, turn the option off, on the TV for best results.
- If you place the unit near a tuner, the radio broadcast sound might be distorted. In this case, move the unit away from the tuner.
- The Digital Audio Output can only be used for DVD playback, not for VCR or TV mode.

CONNECTIONS

CONNECTING THE UNIT TO A TV USING THE AUDIO/VIDEO OUTPUT JACKS

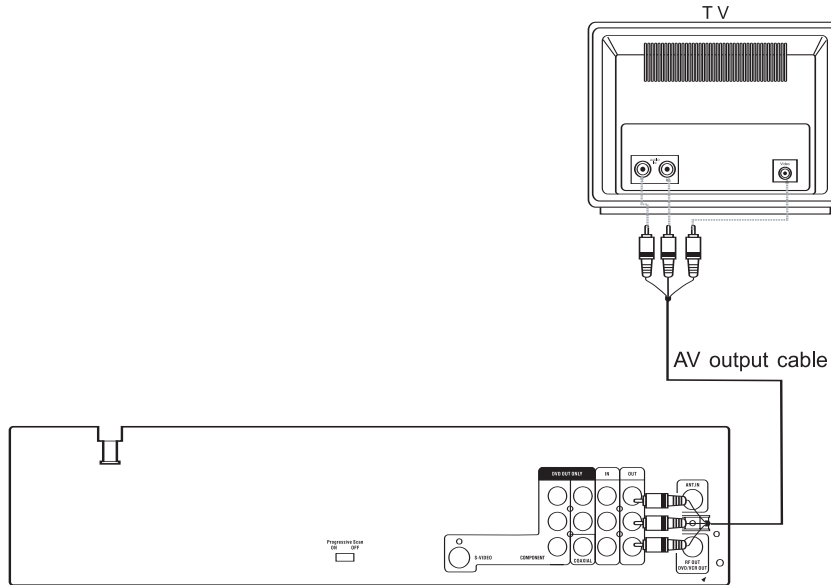

NOTES:

- Set the TV's TV/VIDEO button or switch to the VIDEO setting when connecting using the A/V jacks.
- When connecting, refer to the owner's manual of the TV, as well as this manual.
- When connecting, make sure the power is off and both units are unplugged before making any connections.
- If your TV only has one audio input, the use of a "Y" connector may be necessary. Visit your local electronics supply store.
- If using a TV with a blue screen option, turn the option off, on the TV for best results.

CONNECTING THE UNIT TO A TV USING THE RF INPUT/OUTPUT JACKS (See the following page for specific antenna connections)

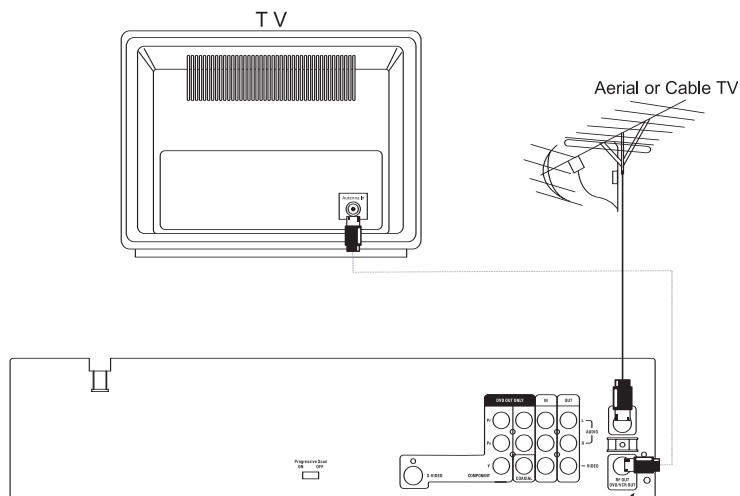

NOTES:

- The signal will be sent to the TV regardless if the unit is on or off.
- You can use the VCR's tuner to change channels, or you can use your TV's tuner.
- When connecting, refer to the owner's manual of the TV, as well as this manual.
- When connecting, make sure the power is off and both units are unplugged before making any connections.
- Connect a cable, etc. signal as described above to use the tuner capabilities of this unit.
- The VCR/DVD output will be on CH 3 or CH 4 if you are using the RF Output, please refer to page 32 for setting the output channel; then, use the TV selector to select CH 3 or CH 4 for the VCR/DVD Output.

CONNECTIONS (CONTINUED)

OUTDOOR VHF/UHF ANTENNA CONNECTION

Follow the instructions for the type of antenna system you intend to use. If using Cable TV (CATV), see bottom of page.

Combination VHF/UHF Antenna (Single 75 ohm cable or 300 ohm twin-lead wire)

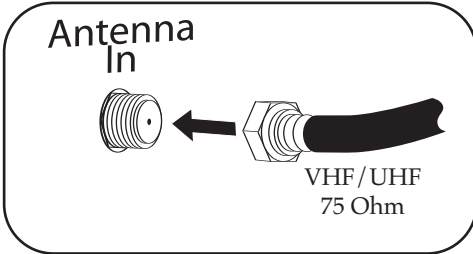

Connect the 75 ohm cable from combination VHF/UHF antenna to the antenna jack.

OR

If your combination antenna has a 300 ohm twin-lead wire, use a 300-75 ohm matching transformer (NOT SUPPLIED).

Combination VHF/UHF Antenna (Separate VHF and UHF 300 ohm twin-leads)

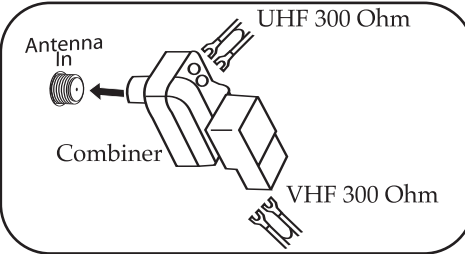

Connect the UHF twin-lead wire to a combiner (NOT SUPPLIED). Connect the VHF twin-lead to a 300-75 ohm matching transformer (NOT SUPPLIED). Attach the transformer to the combiner. Attach the combiner to the antenna jack.

Separate VHF/UHF Antennas

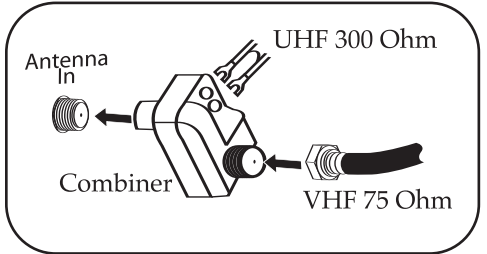

Connect the 75 ohm cable from the VHF antenna and the UHF antenna twin-lead wire to a combiner (NOT SUPPLIED). Attach the combiner to the antenna jack.

NOTE: If your VHF antenna has a twin-lead wire use a 300-75 ohm matching transformer, then connect the transformer to the combiner.

CABLE (CATV)/SATELLITE CONNECTIONS

This unit has an extended tuning range and can tune most cable channels without using a Cable TV converter box. Some Cable TV companies offer "premium pay channels" in which the signal is scrambled. Descrambling these signals for normal viewing requires the use of a descrambler device which is generally provided by the cable company.

FOR SUBSCRIBERS TO BASIC CABLE TV SERVICE

For basic cable service not requiring a converter/descrambler box, connect the CATV 75 ohm coaxial cable to the VHF/UHF jack on the rear of the unit.

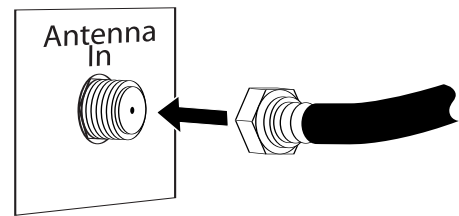

FOR SUBSCRIBERS TO SCRAMBLED CABLE TV SERVICE OR SATELLITE

If you subscribe to a satellite service or a cable TV service which requires the use of a converter/descrambler box, connect the incoming 75 ohm coaxial cable to the converter/descrambler box. Using another 75 ohm cable, connect the output of the converter/descrambler or satellite box to the antenna jack on the unit. Follow the connections shown below. Set the unit to the output channel of the converter/descrambler or satellite box (usually 3 or 4) and use the converter/descrambler or satellite box to select channels.

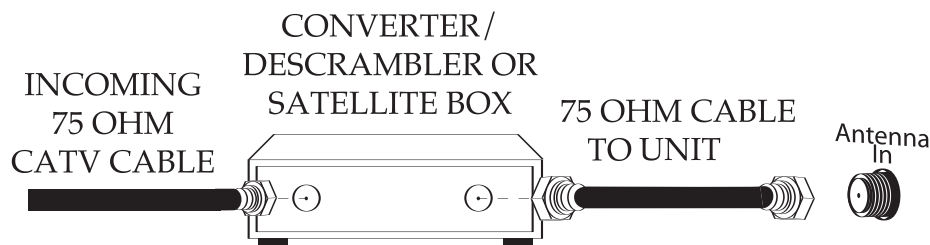

ABOUT DISCS

The region number for this player is:
See the following page for information regarding region numbers.



PLAYABLE DISCS:

The following discs can be played back on this player:



MP3

When playing an MP3, the selected file will appear in the display and will list the folders/tracks.

MP3 is the abbreviation of "MPEG1 Audio Layer 3". MPEG Audio is a format that compresses the audio portion only.

IMPORTANT NOTES:

Due to many variables, including recording condition, type of disc, writing software, etc., this unit does not guarantee playback of all MP3 discs.

DISC TYPES:

DVD

Data on most DVDs is divided into sections called "titles" and then into subsections called "chapters", each of which is given a title or chapter number. Some features of this player will not operate with some DVD discs as they are preset. If a function you selected does not run as desired, refer to the manual accompanying the DVD disc.

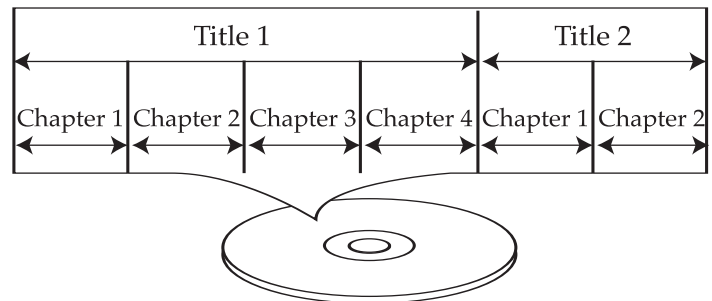

AUDIO CD

Data on an audio CD is divided into sections called "tracks", each of which is given a track number.

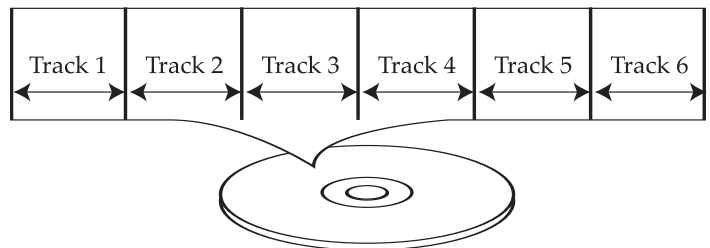

KODAK PICTURE CD

Data on a Kodak picture CD is usually not divided into separate folders, they should appear in the root directory.

IMPORTANT:

It is important that you read the manual that accompanies the DVD disc, as there are features that are on the player that cannot be used with certain DVDs. There are also extra features on the DVD disc that are different for each DVD disc, so they are not explained in this owner's manual.

This player conforms to the NTSC and PAL color systems. However, if you are in the USA, leave this setting on NTSC. If incorrectly set to PAL, the TV picture will roll vertically. In this case, simply turn the unit off, and then back on.

ABOUT DISCS (CONTINUED)

Notes on Copyright:

It is forbidden by law to copy, broadcast, show, broadcast on cable, play in public and rent copyrighted material without permission. DVD video discs are copy protected, and any recordings made from these discs will be distorted. This product incorporates copyright protection technology that is protected by method claims of certain U.S. patents and other intellectual property rights owned by Macrovision Corporation and other rights owners. Use of this copyright protection technology must be authorized by Macrovision Corporation, and is intended for home and other limited viewing uses only, unless otherwise authorized by Macrovision Corporation. Reverse engineering or disassembly is prohibited.

Region Management Information:

This player is designed and manufactured to respond to the Region Management Information that is recorded on a DVD disc. If the Region number described on the DVD disc does not correspond to the Region number of this player, this player cannot play that disc. You may not be able to play back some DVD video discs on this player if they were purchased from outside your geographic area or made for business purposes. When you try to play back an unauthorized disc, "Wrong Region" appears on the TV screen.

DVD SETUP MENU

The SETUP MENU lets you customize the DVD section by allowing you to select various language preferences, turn captions and screen saver on and off, adjust what type of television screen you have and more.

While in the DVD mode (DVD button pressed first), enter the SETUP MENU by pressing the SETUP button ❶. Use the Navigation (◀, ▶, ▲, ▼) buttons ❷ to navigate through the menus/screens and press the OK button ❸ to select the highlighted option.

To Exit the SETUP MENU, press the SETUP button ❶.

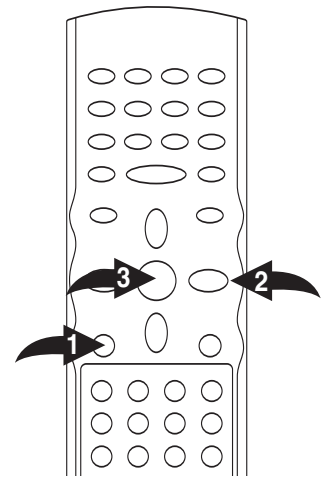

NOTE: All of the Setup screens below are for the DVD mode only.

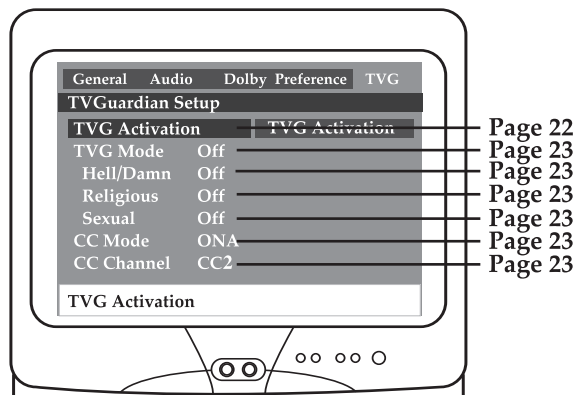
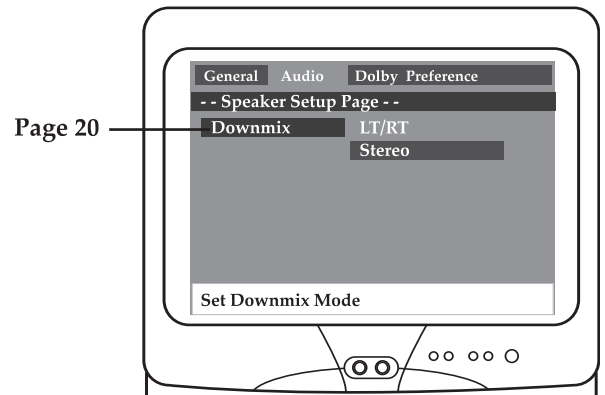
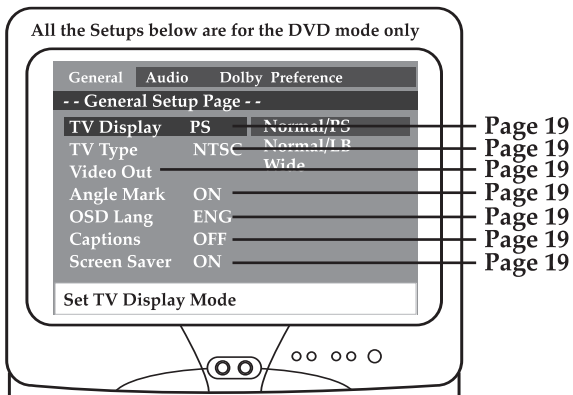
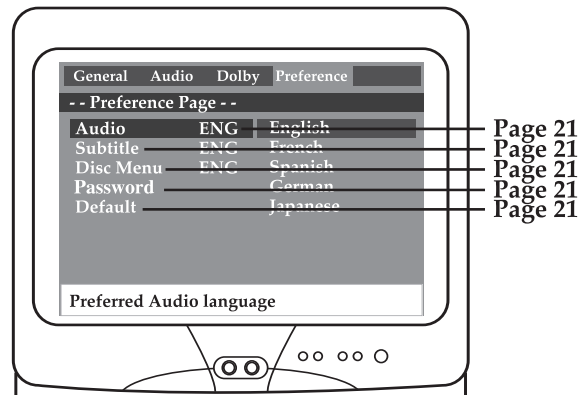
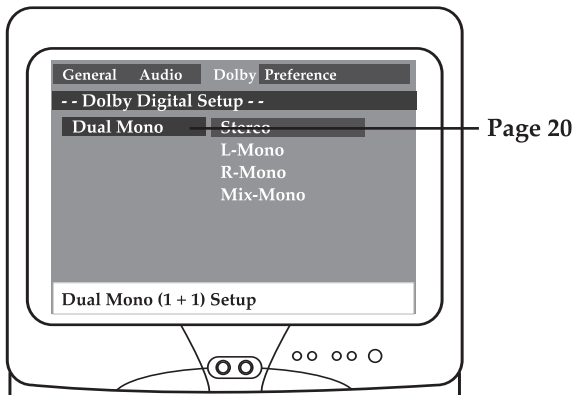

DVD SETUP MENU (CONTINUED)

GENERAL SETUP MENU:

Select General and then select the desired option using the Navigation (◀, ▶, ▲, ▼) buttons to navigate through the menus/screens and press the OK button to select.

TV DISPLAY

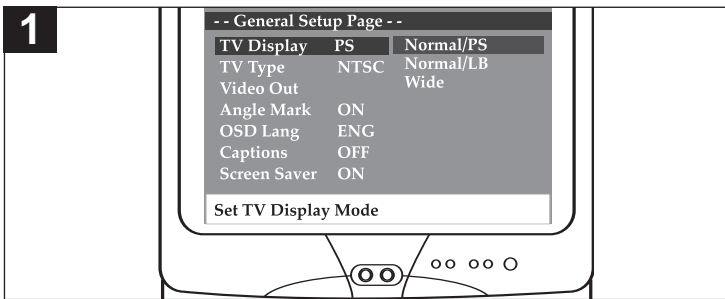

NORMAL/PS: Pan Scan. Select when the unit is connected to a conventional TV. Video material formatted in the Pan Scan style is played back in that style (the left and right edges are cut off).

NORMAL/LB: Letter Box. Select when the unit is connected to a normal TV. Wide-screen images are shown on the screen with a black band at the top or bottom.

WIDE: Select when the unit is connected to a wide-screen TV.

TV TYPE

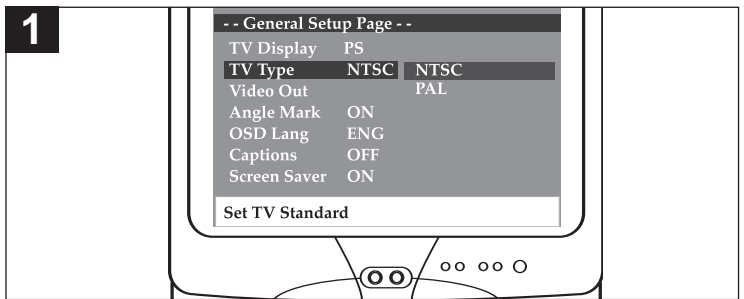

NTSC: Select when using a NTSC TV.

PAL: Select when using a PAL TV.

IMPORTANT: In the USA, the standard is NTSC.

VIDEO OUT (Color Video Connector Type)

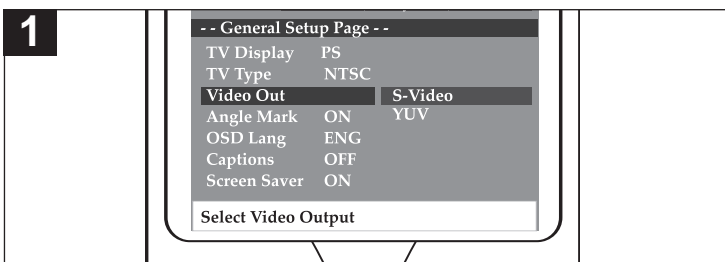

Select the color video type to fit your connector type:

S-VIDEO: Select when using S-Video OUT.

YUV: Select when using Component Video OUT.

This setting is not affected when connecting with other connections.

ANGLE MARK

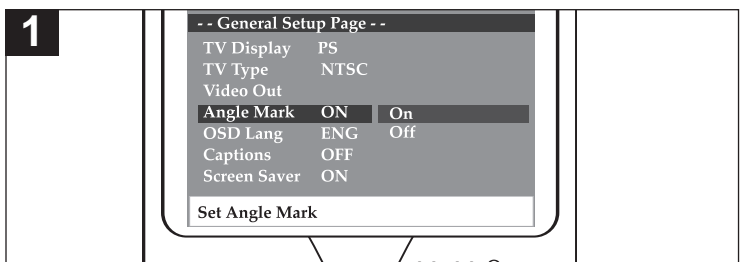

Select ON to turn the anglemarks on and OFF to turn them off.

Anglemarks are not available on all DVDs.

OSD LANGUAGE

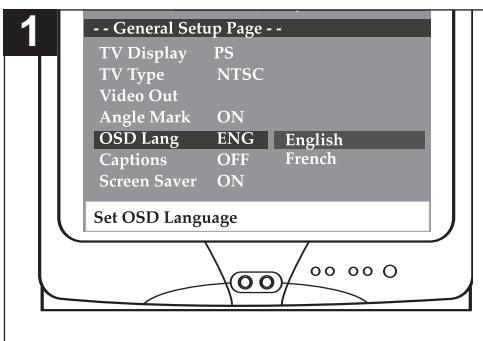

Select the desired language (ENGLISH, FRENCH) for the On-Screen display to display text. Note that the DVD must have the language included in order to display it.

CAPTIONS

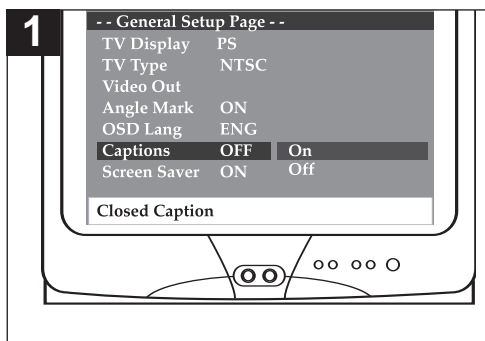

When this option is set to ON, closed captions will appear on the screen for the hearing impaired (if originally recorded on the DVD). When this option is OFF, the closed captions will not appear.

SCREEN SAVER

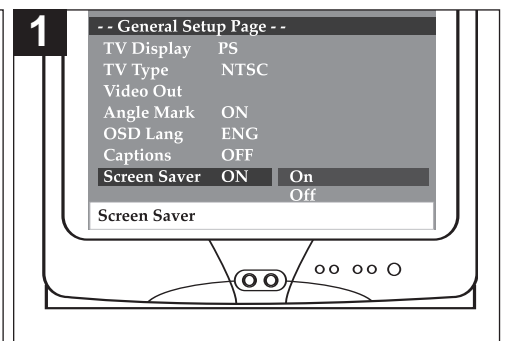

When this option is set to ON, the screen saver will come on when the unit stops or the image is paused for approximately 1.5 minutes.

When this option is OFF, the screen saver will not come on.

DVD SETUP MENU (CONTINUED)

SPEAKER SETUP MENU:

Select Audio and then select the desired option using the Navigation (◀, ▶, ▲, ▼) buttons to navigate through the menus/screens and press the OK button to select.

DOWNMIX

Sets the Audio Output mode.

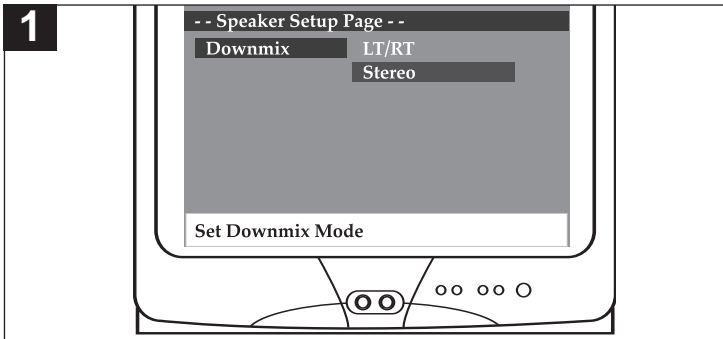

LT/RT: Select to hear the sound in theatrical downmix mode.

STEREO: Select to hear the sound in Stereo downmix mode.

DOLBY DIGITAL SETUP MENU:

Select Dolby and then select the desired option using the Navigation (◀, ▶, ▲, ▼) buttons to navigate through the menus/screens and press the OK button to select.

DUAL MONO

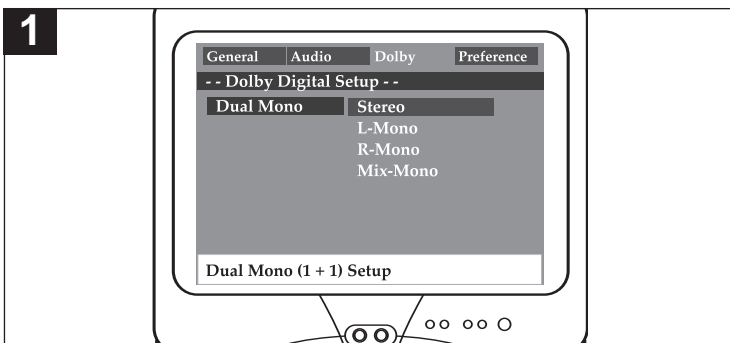

STEREO: Select this to set the Dolby Digital output to Stereo mode.

L-MONO: Select this to set the Dolby Digital output to left mono mode, meaning it will reproduce the left mono signal to the Left and Right channels.

R-MONO: Select this to set the Dolby Digital output to right mono mode, meaning it will reproduce the right mono signal to the Left and Right channels.

MIX-MONO: Select this to reproduce both channels mixed together.

DVD SETUP MENU (CONTINUED)

PREFERENCE MENU (this menu cannot be accessed if a disc is inserted):

Select Preference and then select the desired option using the Navigation (◀, ▶, ▲, ▼) buttons to navigate through the menus/screens and press the OK button to select.

AUDIO

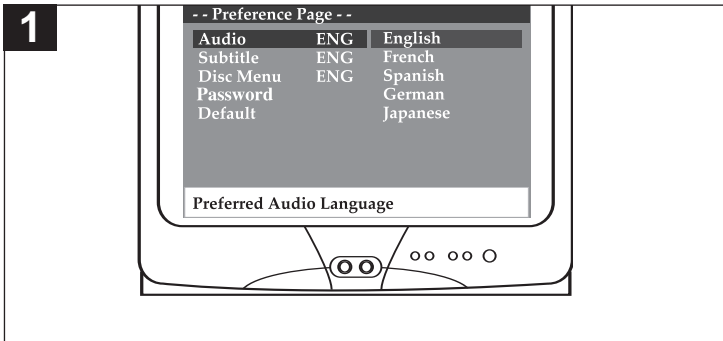

Select the language the DVD will be played back in (ENGLISH, FRENCH, SPANISH, GERMAN, JAPANESE). The DVD must be recorded in the selected language, otherwise the default language of the DVD will be played.

SUBTITLE

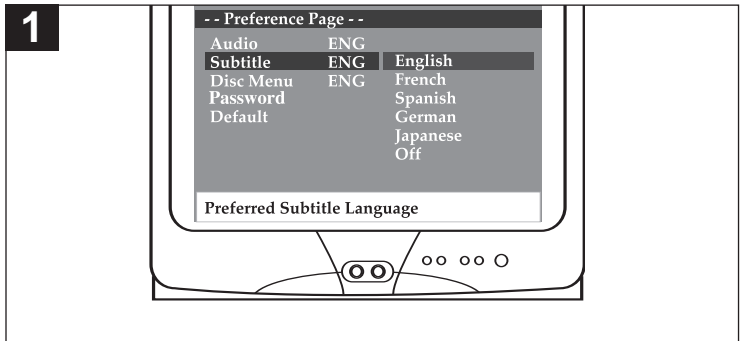

Select the language the Subtitle (OSD) will be in (ENGLISH, FRENCH, SPANISH, GERMAN, JAPANESE, OFF). The DVD must be recorded in the selected language, otherwise the default language of the DVD will be shown.

DISC MENU

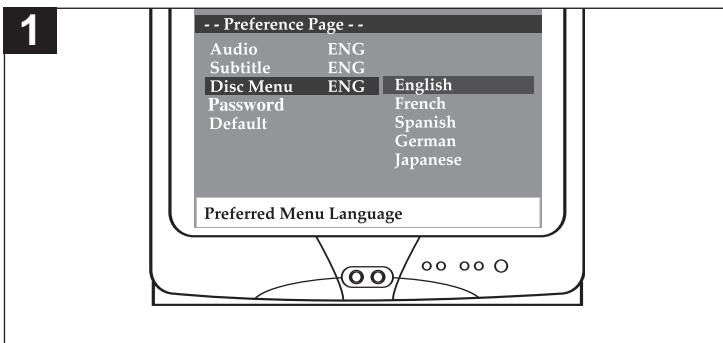

Select the language the DISC MENU will be in (ENGLISH, FRENCH, SPANISH, GERMAN, JAPANESE). The DVD's DISC MENU must be made in the selected language, otherwise the default language of the DVD will be shown.

DEFAULT

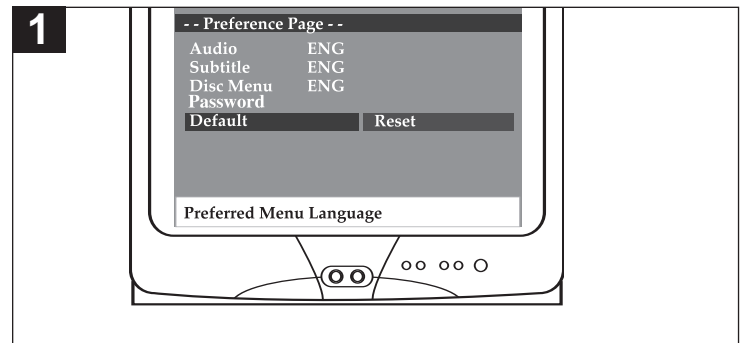

Select this option to reset all preferences to their original factory settings.

TVG® PASSWORD: Select this option to change the TVG® password. You must know the old password in order to change it. If you have forgotten the password, call customer service at the number listed on the Warranty.

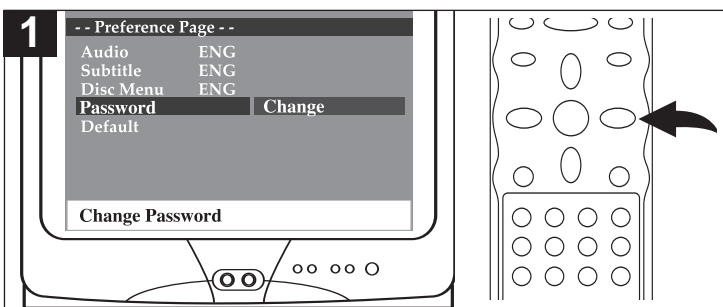

At the PREFERENCE MENU, use the Navigation (▲, ▼) buttons to select Password. Press the Navigation (▶) button to select Change.

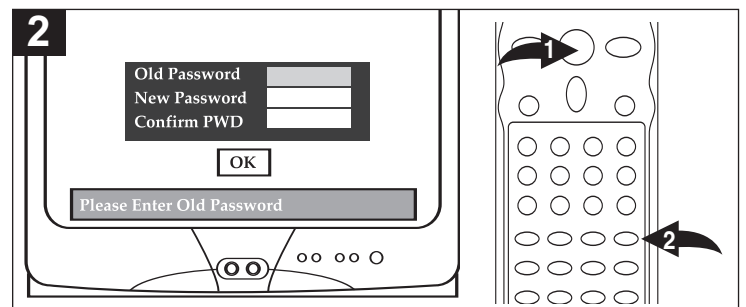

Press the OK button ❶ to change the password. Input your old password (the default password is 1234), then the new password and then confirm the new password using the Number buttons ❷, then press the OK button ❶ again. The desired new password will then be set; be sure to write it down for future reference.

DVD SETUP MENU (CONTINUED)

TVG (TV GUARDIAN)



TVGuardian® Feature

This product supports TVGuardian® Foul Language Filtering Technology, offering your family the very best control of objectionable language in your home.

HOW IT WORKS

TVGuardian® (TVG®) filters out objectionable language. When objectionable words or phrases are detected, TVG® mutes the audio and displays more appropriate “profanity-free” phrases. TVG® technology also offers various levels of filtering and is easily adjustable with simple on-screen menus.

NOTE: TVG® is available when viewing movies on DVD only (not on video cassette).

TO ACTIVATE THE TVGuardian® FEATURE

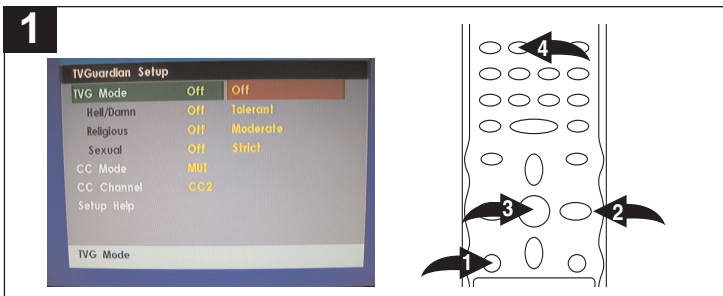

Press the SETUP button ❶ to enter the Setup Menu. Scroll to TVG using the Navigation (◀, ▶) buttons ❷, then press the OK button ❸.

NOTE: You can also enter the TVG menu by pressing the TVG button ❹.

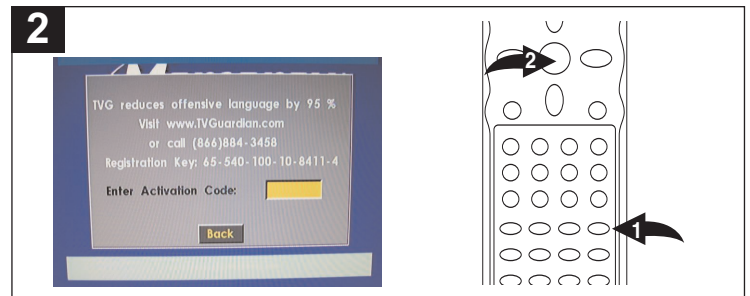

The Activation screen will appear and the Registration key will be shown on the screen; you will need the Registration key to activate the TVGuardian® feature.

To activate the TVG® feature, you must first purchase the service either by visiting www.TVGuardian.com OR by calling **1-866-884-3458**.

NOTE: To activate the TVG® feature, an activation fee is required. Phone-in activation also incurs an additional service fee.

Once you have obtained your Activation code, use the Number buttons ❶ to enter where prompted. Once activated, you may use TVGuardian® for the life of your unit. Then, the TVG® Password menu will appear. Input your old password then press the OK button ❷ again to enter the TVG® Setup menu.

DVD SETUP MENU (CONTINUED)

TVGuardian® Setup Menu

TVG® Modes

Off.....No filtering
 Tolerant ..Filters only the most offensive foul language
 ModerateIncreased standards for language filtering
 Strict.....Filters out all common offensive language

Word Subset Filtering

In addition to the main TVG® modes listed above, you can turn certain word subsets on or off according to your preferences.

Damn and HellFilters out variations of “Damn”/“Hell”
 ReligiousFilters out references to deities
 (To watch religious programming, turn this word subset off.)
 SexualFilters sexually explicit language

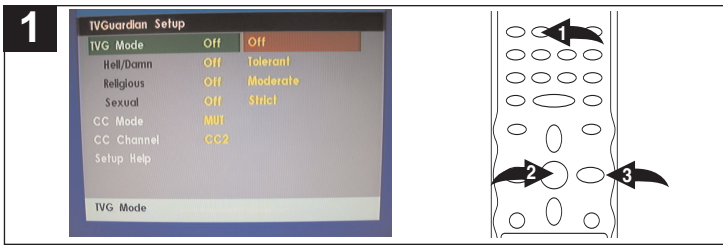

Activate the TVG® function and enter the menu as described on the previous page. Press the TVG button ❶, then press the OK button ❷. The TVG® Password menu will appear. Input your password then press the OK button ❷ again to enter the TVG® Setup menu. (Please refer to pg. 21 for the TVG® password.) Select TVG MODE using the Navigation (▲,▼) buttons ❸, then press the Navigation (▶) button ❹ to enter the mode selection. Press the Navigation (▲,▼) buttons ❸ to select between the four modes described above (Off, Tolerant, Moderate, Strict), then press the OK button ❷ to confirm.

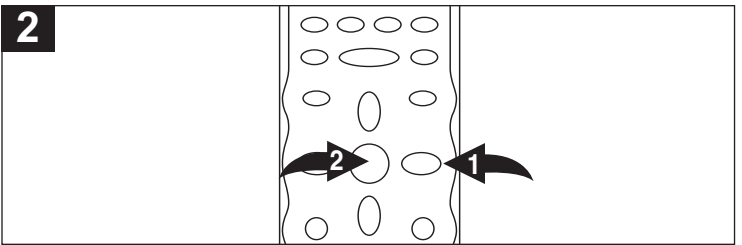

If you have selected any TVG mode except Off, you can then use the Navigation (▲,▼) buttons ❶ to select HELL/DAMN, RELIGIOUS and/or SEXUAL. Press the Navigation (▶) button ❷ to enter the mode selection. Press the Navigation (▲,▼) buttons ❶ to select between Filtered and Off (select Filtered to filter the word subset), then press the OK button ❷ to confirm.

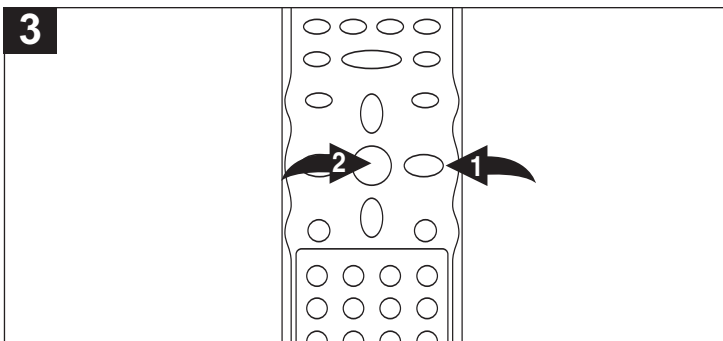

Press the Navigation (▲,▼) buttons ❶ to select CC Mode. Press the Navigation (▶) button ❷ to enter the mode selection. Press the Navigation (▲,▼) buttons ❶ to select between Off (captions never displayed), On Mute (default setting, captions displayed when offensive language is filtered) or On Always (captions always displayed). Press the OK button ❷ to confirm.

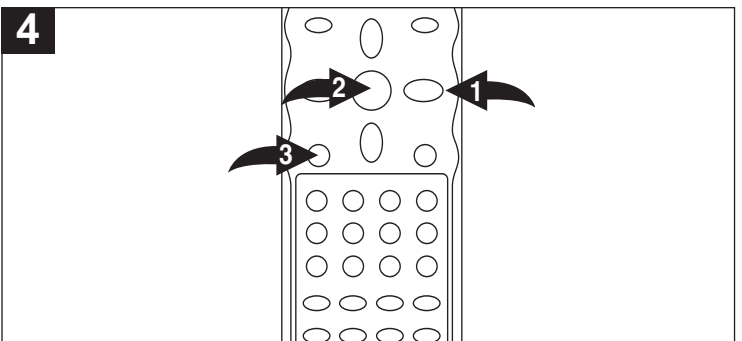

Press the Navigation (▲,▼) buttons ❶ to select CC Channel. Press the Navigation (▶) button ❷ to enter the channel selection. Press the Navigation (▲,▼) buttons ❶ to select between CC1 and CC2 as desired. Press the OK button ❷ to confirm. To exit the Setup menu, press the SETUP button ❸ until the Setup menu disappears from the screen.

NOTES:

- To use the TVG® captioning feature while watching a DVD, your TV must be capable of displaying Closed Captions (CC). Set your TV CC to “CC2” or “C2” and this unit to “CC2”.
- TVG® filters 95% of foul language in closed captioned words; TVG® does not filter out scenes or do “voice-overs”. Errors in the CC can cause TVG® to miss words/phrases. TVG® works on media that includes CC information. You can verify whether a DVD supports CC by looking for the CC logo on the back cover of the DVD case.
- Replaced CC phrases are available through the TV’s CC Decoder. If your TV doesn’t have a CC Decoder, replaced phrases may not be available. In this case, TVG® will just mute the filtered language.

VCR SETUP MENU

The SETUP MENU lets you customize the VCR section by allowing you to set various options, such as clock, program, channels and more.

While in the VCR mode (VCR button pressed first) enter the SETUP MENU by pressing the SETUP button ❶. Use the Navigation (◀, ▶, ▲, ▼) buttons ❷ to navigate through the menus/screens and press the OK button ❸ to select the highlighted option.

To Exit the SETUP MENU, press the SETUP button ❶.

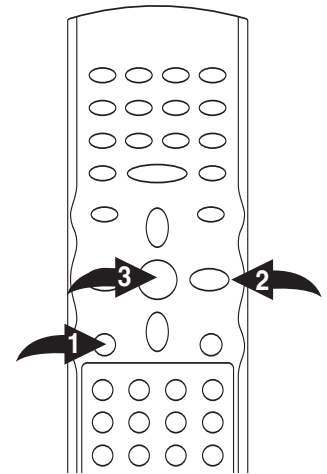

TO SET THE DATE AND TIME

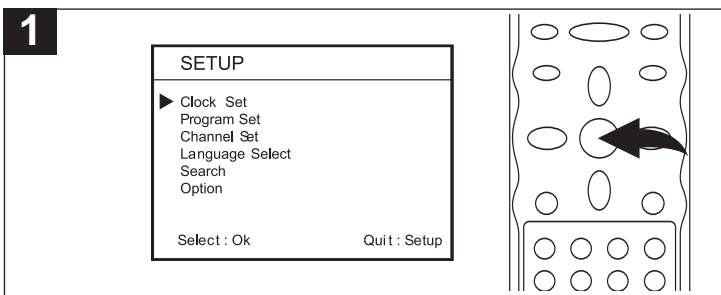

Enter the VCR mode and the Setup screen as described above; the Setup menu will appear. Press the OK button to select Clock Set; the Clock Set menu will appear.

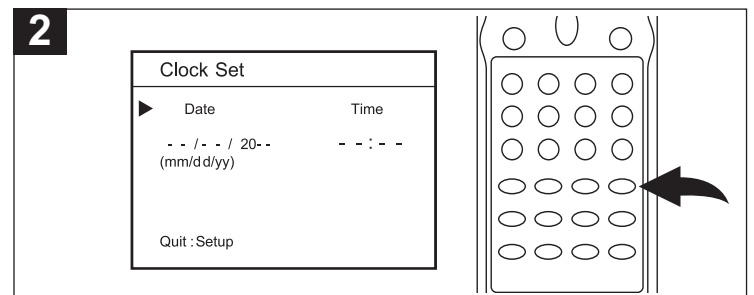

Enter two digits for the month, two digits for the day and two digits for the year using the Number buttons. As each number is pressed, the cursor will move to the right. When finished, the hour digits will blink.

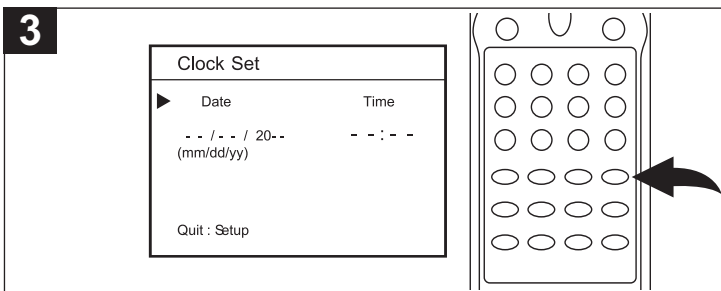

Enter two digits for the hour and two digits for the minute using the Number buttons. As each number is pressed, the cursor will move to the right. When finished, the AM/PM setting will blink.

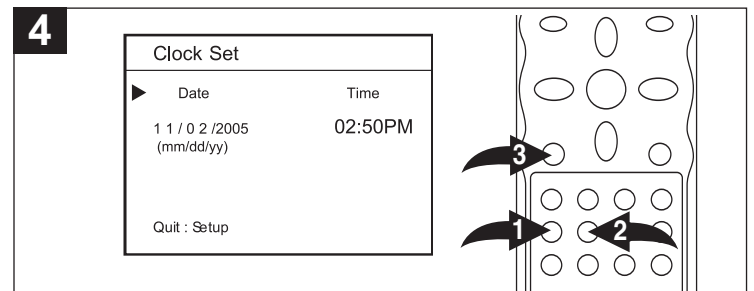

Press the Number 1 button ❶ for AM or the Number 2 button ❷ for PM. When finished setting the time, press the SETUP button ❸ to exit.

NOTE: You can also use the Navigation (▲, ▼) buttons to select between AM and PM.

NOTE:

You can change the Date and Time setting while in the Clock Set menu by using the Navigation (◀, ▶) button to select and then using the Number buttons or Navigation (▲, ▼) button to change.

VCR SETUP MENU (CONTINUED)

TO SET THE TIMER PROGRAMMING

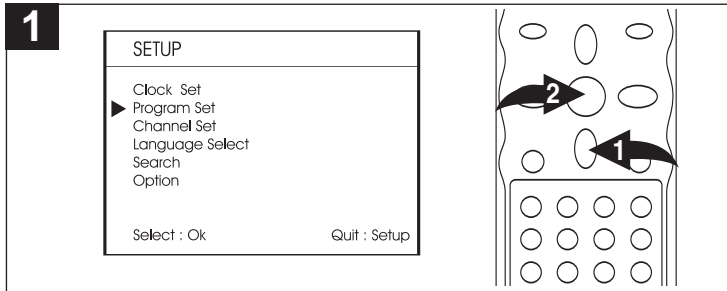

Enter the VCR mode and the Setup screen as described on page 24; the Setup menu will appear. Scroll to Program Set using the Navigation (▼) button ❶. Press the OK button ❷ to select it; the Program menu will appear.

NOTE: While in VCR mode, you can directly press the PROGRAM button (VCR) to enter the Program menu.

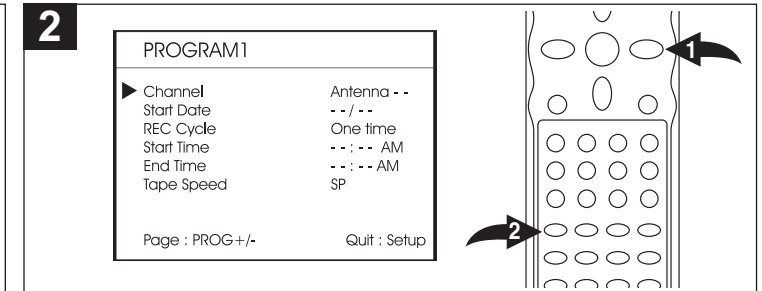

Press the Navigation (▼) button ❶ to cycle through the source options (Antenna, Video 2, Video 1 or Cable), then press the Navigation (▶) button ❶. If you selected VIDEO 1 or 2, go to the next step. If you selected ANTENNA or CABLE, enter a channel number to timer record using the Number buttons ❷; the Start Date digits will blink.

NOTE: For CABLE, to enter a channel number over "99", press the 100 button first, then enter the second and third digits of the channel number; i.e., for Channel 105, press the 100 button, then press the "0" and "5" Number buttons.

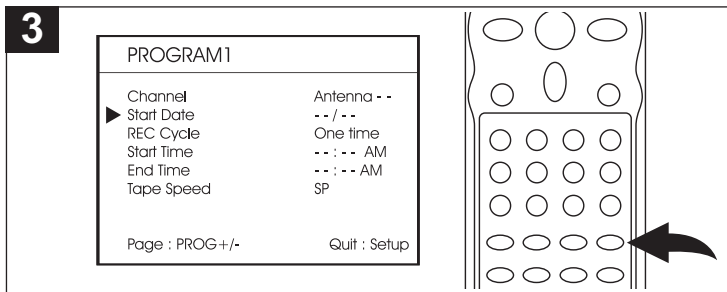

Enter two digits for the month and two digits for the day using the Number buttons. As each number is pressed, the cursor will move to the right. When finished, the REC CYCLE option will blink.

NOTE: After the date has been set, the day of the week (i.e. Saturday) will appear next to it.

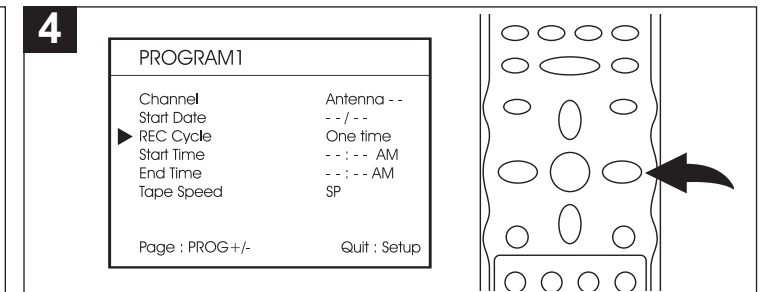

Press the Navigation (▼) button to cycle through the Record cycle options (One Time, Daily, Weekdays or Weekly), then press the Navigation (▶) button; the Start Time hour digits will blink.

One Time—record the set program once only.

Daily—record the program everyday according to the start and end times.

Weekdays—record the program from Monday to Friday.

Weekly—record the program once a week.

CONTINUED ON THE NEXT PAGE

VCR SETUP MENU (CONTINUED)

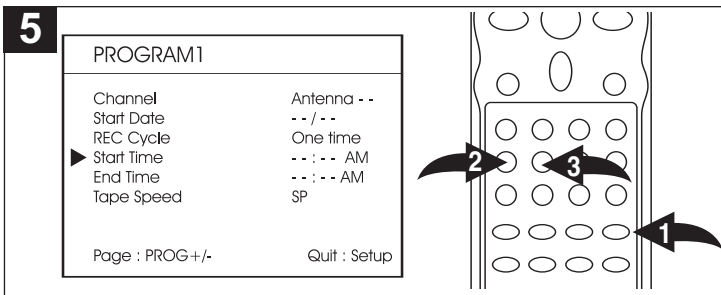

Enter two digits for the start hour and two digits for the start minute using the Number buttons ①. As each number is pressed, the cursor will move to the right. When finished, the AM/PM setting will blink. Press the Number 1 button ② for AM or the Number 2 button ③ for PM; the End Time hour digits will blink.

NOTE: You can also use the Navigation (▲, ▼) buttons followed by the Navigation (▶) button to select between AM and PM.

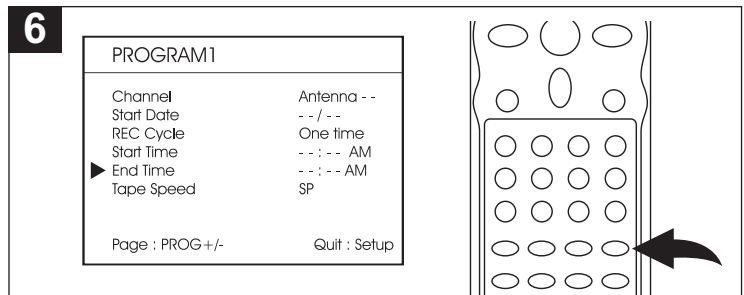

Enter two digits for the end hour and two digits for the end minute using the Number buttons. As each number is pressed, the cursor will move to the right; the Tape Speed option will blink.

NOTE: The AM/PM setting will automatically be set.

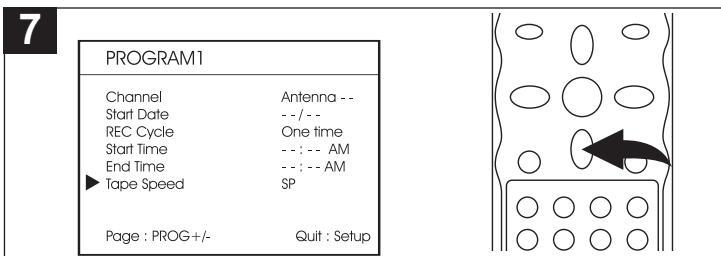

Press the Navigation (▼) button to cycle through the Tape Speeds (SP {Slow Play} or SLP {Super Long Play}).

NOTES:

- You can change a setting while in the Time mode by using the Navigation (◀, ▶) button to select and then the Number buttons to change.
- You can set up to 8 programs for Timer recording.
- After you have stored the programs, if the program is overlapping (the recording time on the programs set overlap), the PROGRAM OVERLAP menu will appear on the screen temporarily and Overlap Programs will flash on screen. In this case, you should clear one program (see below).

TO CLEAR THE TIMER PROGRAM

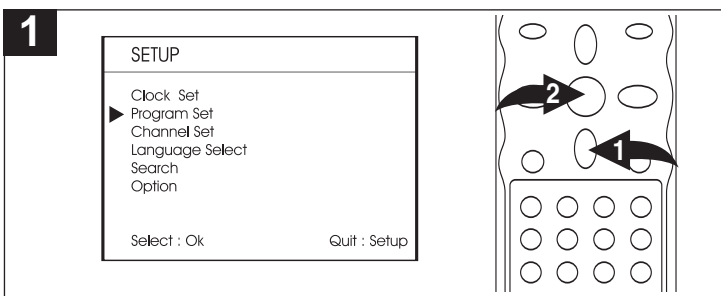

Enter the VCR mode and the Setup screen as described on page 24; the Setup menu will appear. Scroll to Program Set using the Navigation (▼) button ①. Press the OK button ② to select it; the Program menu will appear.

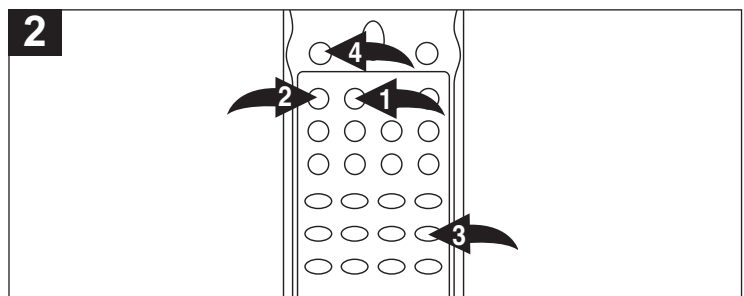

Select the program you want to clear using the Skip ▶▶ ① or ◀◀ ② button. Then press the COUNTER RESET/CLEAR button ③ to clear the program. When finished, press the SETUP button ④ twice to exit the VCR setup menu.

VCR SETUP MENU (CONTINUED)

SETTING THE CHANNEL MENU

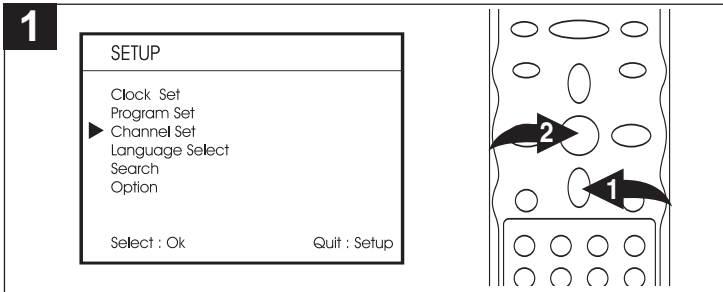

Enter the VCR mode and the Setup screen as described on page 24; the Setup menu will appear. Scroll to Channel Set using the Navigation (▼) button ❶. Press the OK button ❷ to select it; the Channel menu will appear.

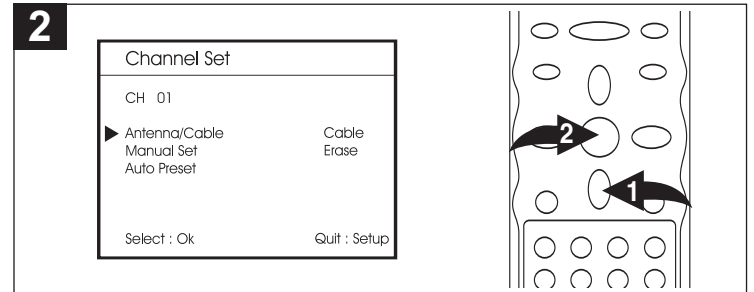

Press the Navigation (▼) button ❶ to select the "Antenna/Cable" input option and press the OK button ❷ repeatedly to select "Antenna" or "Cable".

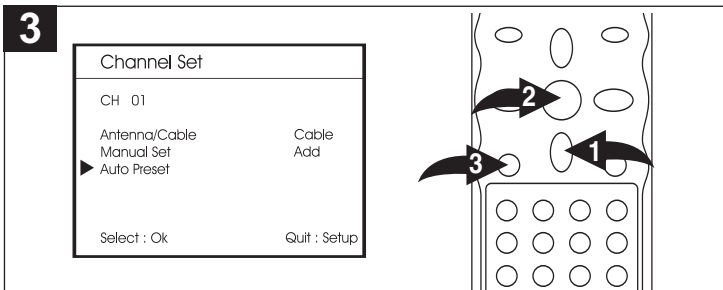

TO AUTO PRESET CHANNELS: To automatically program all strong stations in, scroll to Auto Preset using the Navigation (▼) button ❶. Press the OK button ❷ to select it; the unit will start memorizing channels. ("Please Wait" will appear on the screen.)

NOTE: To cancel searching, press the SETUP button ❸.

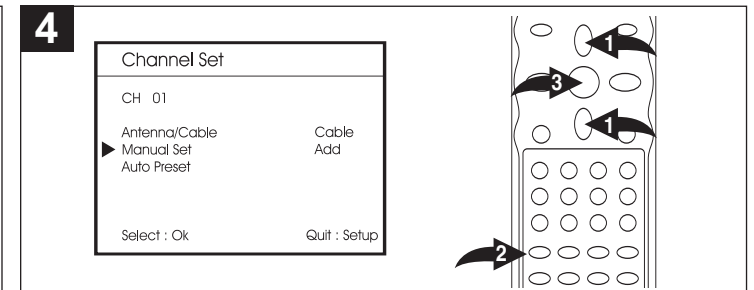

Press the Navigation (▼) button ❶ to select the Manual Set option. Press the Number buttons ❷ to enter the channel number which you want to Add or Erase. Press the OK button ❸ repeatedly to select "Add" or "Erase".

Add—channels that are added can be accessed using the Navigation/Channel Up/Down (▲, ▼) buttons ❶.

Erase—channels that are erased cannot be accessed using the Navigation/Channel Up/Down (▲, ▼) buttons ❶.

NOTE: For CABLE, to enter a channel number over "99", press the 100 button first, then enter the second and third digits of the channel number; i.e., for Channel 105, press the 100 button, then press the "0" and "5" Number buttons.

VCR SETUP MENU (CONTINUED)

SETTING THE LANGUAGE

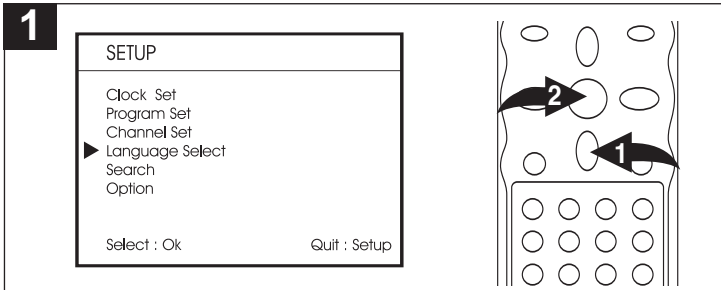

Enter the VCR mode and the Setup screen as described on page 24; the Setup menu will appear. Scroll to Language Select using the Navigation (▼) button ❶. Press the OK button ❷ to select it; the Language Select menu will appear.

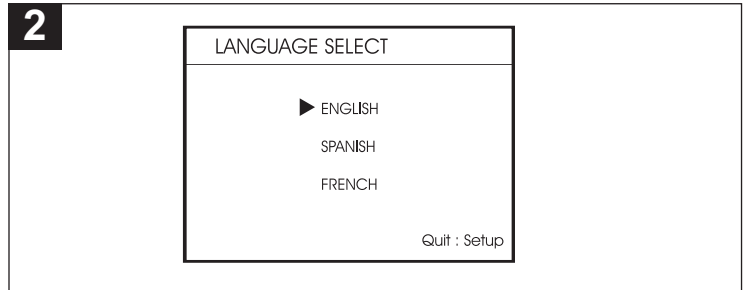

Press the Navigation (▼) button to select the desired language the On-Screen Display will be in (English, Spanish or French).

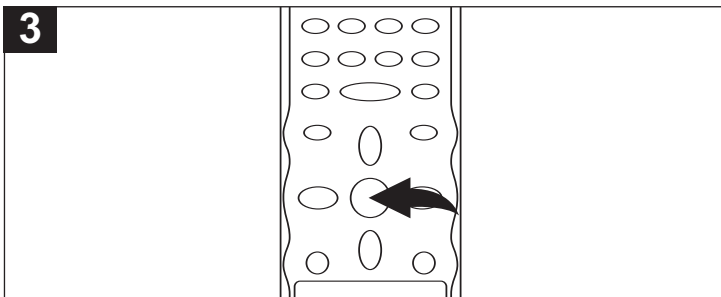

When finished, press the OK button and the language will be set.

NOTE: To exit the menu, press the SETUP button twice.

VCR SETUP MENU (CONTINUED)

SETTING THE GO TO ZERO SEARCH

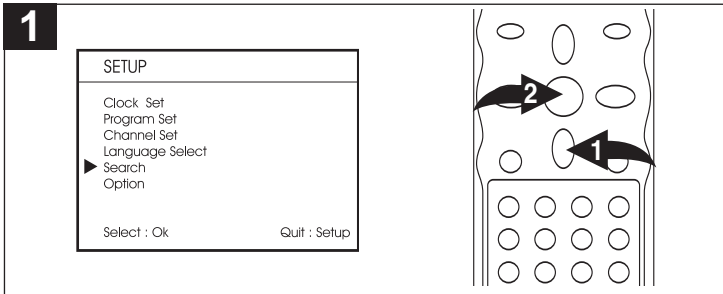

With a prerecorded video cassette tape inserted, enter the VCR mode and the Setup screen as described on page 24; the Setup menu will appear. Scroll to Search using the Navigation (▼) button ❶. Press the OK button ❷ to select it; the Search will appear.

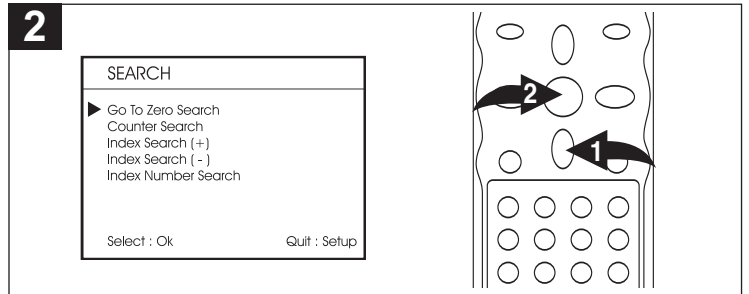

Press the Navigation (▼) button ❶ to select Go To Zero Search, then press the OK button ❷; the VCR will then search until the counter reads "0:00:00". When it reaches "0:00:00", playback will start automatically.

SETTING THE COUNTER SEARCH

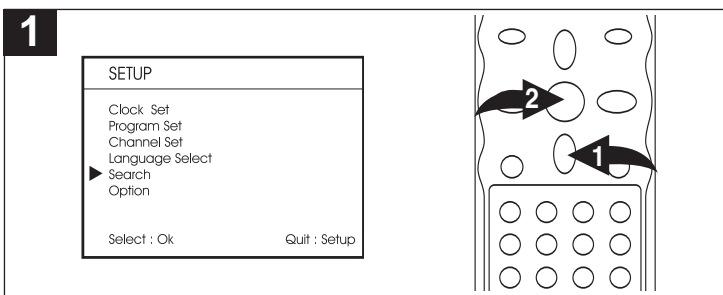

With a prerecorded video cassette tape inserted, enter the VCR mode and the Setup screen as described on page 24; the Setup menu will appear. Scroll to Search using the Navigation (▼) button ❶. Press the OK button ❷ to select it; the Search will appear.

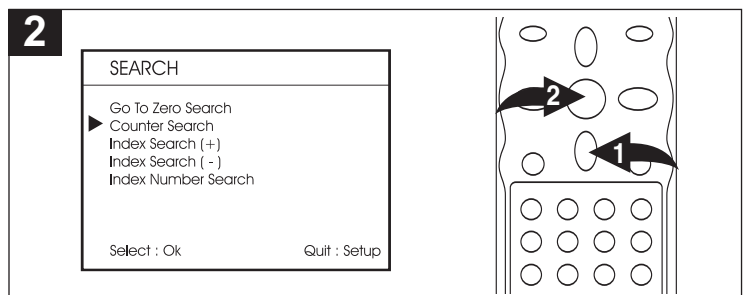

Press the Navigation (▼) button ❶ to select Counter Search, then press the OK button ❷; the Counter Search menu will appear.

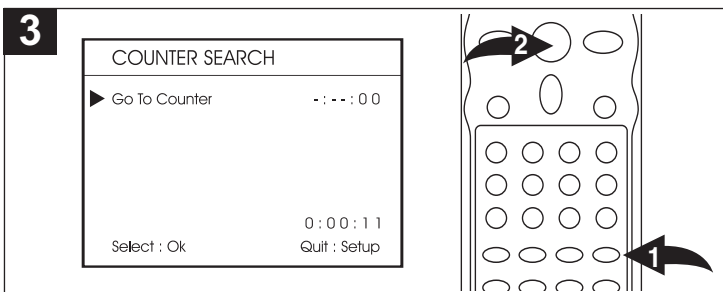

Enter the desired counter number to go to using the Number buttons ❶. (Enter the hour for the first digit, then enter the minute for the second and third digit; i.e., to search and playback starting from 1 hour and 10 minutes, enter "1","1","0".) Then press the OK button ❷; the VCR will then search and start playback when the counter position is reached.

NOTE: When searching, press the STOP ■ button to cancel the searching.

VCR SETUP MENU (CONTINUED)

INDEX SEARCH +

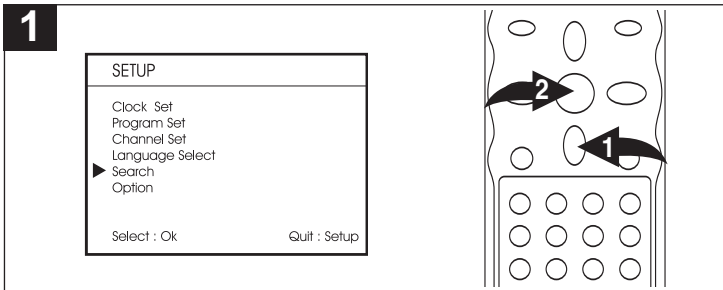

With a prerecorded video cassette tape inserted, enter the VCR mode and the Setup screen as described on page 24; the Setup menu will appear. Scroll to Search using the Navigation (▼) button ❶. Press the OK button ❷ to select it; the Search will appear.

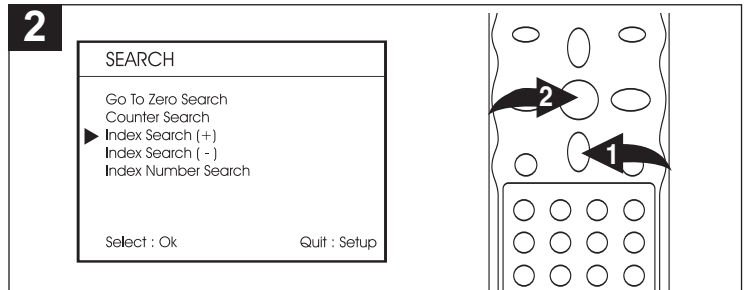

Press the Navigation (▼) button ❶ to select Index Search +, then press the OK button ❷; the unit will then fast forward to the next index point and then play from that point.

INDEX SEARCH -

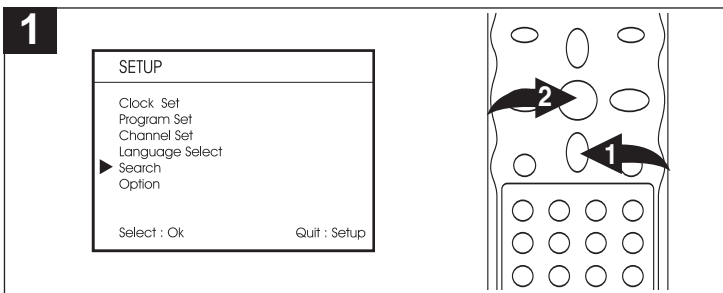

With a prerecorded video cassette tape inserted, enter the VCR mode and the Setup screen as described on page 24; the Setup menu will appear. Scroll to Search using the Navigation (▼) button ❶. Press the OK button ❷ to select it; the Search will appear.

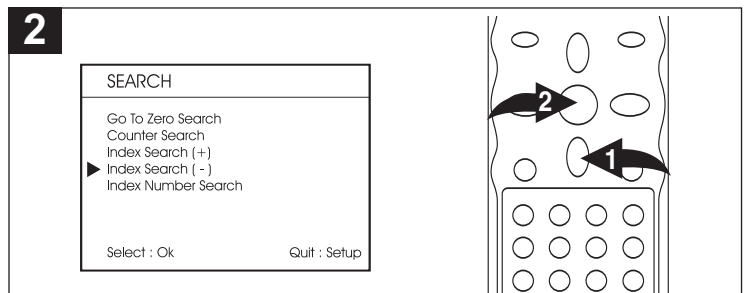

Press the Navigation (▼) button ❶ to select Index Search -, then press the OK button ❷; the unit will then rewind to the index point and then play from that point.

NOTE: When searching, press the STOP ■ button to cancel the searching.

VCR SETUP MENU (CONTINUED)

INDEX NUMBER SEARCH

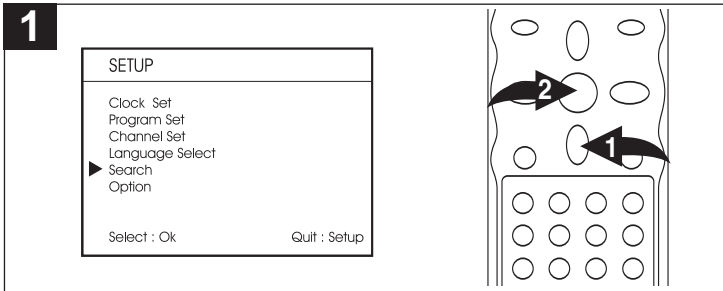

With a prerecorded video cassette tape inserted, enter the VCR mode and the Setup screen as described on page 24; the Setup menu will appear. Scroll to Search using the Navigation (▼) button ❶. Press the OK button ❷ to select it; the Search menu will appear.

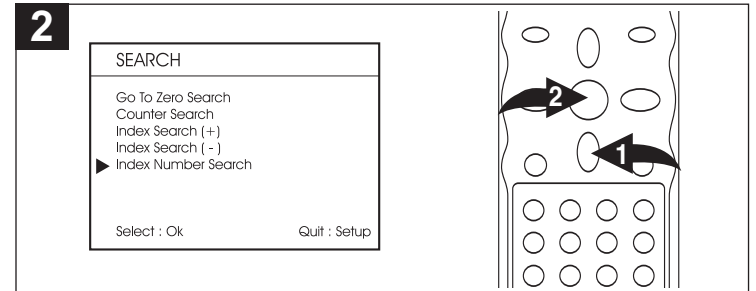

Press the Navigation (▼) button ❶ to select Index Number Search, then press the OK button ❷; the Index Number Search menu will appear.

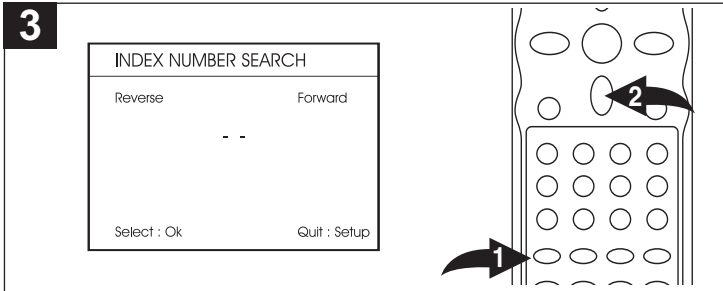

Select a desired Index Number (two digits) to go to using the Number buttons ❶, then press the Navigation (▲) button ❷.

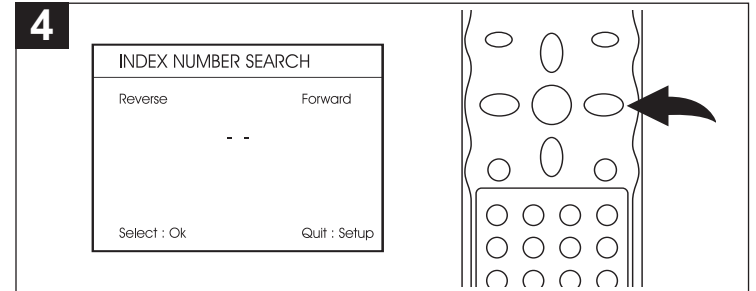

Select the direction (Reverse or Forward) using the Navigation (◀) or (▶) button; the unit will then rewind or fast forward to the desired Index Number and start playing from that point.

NOTES:

- For index number search function, if the tape has 10 index points and you are playing from the 3rd index point or the playback is stopped after the 3rd point, if you input "04" for the index number and "Forward" for the direction, the unit will search and start playing from the 7th index point. Also, if you input "06" for the index number and "Reverse" for the direction, then the unit will search and start playing from the 2nd index point.
- If the index number entered is larger than the index points the tape has, it will search to the end/beginning of the tape then stop.
- When searching, press the STOP ■ button to cancel the searching.

VCR SETUP MENU (CONTINUED)

SETTING THE VCR OPTIONS

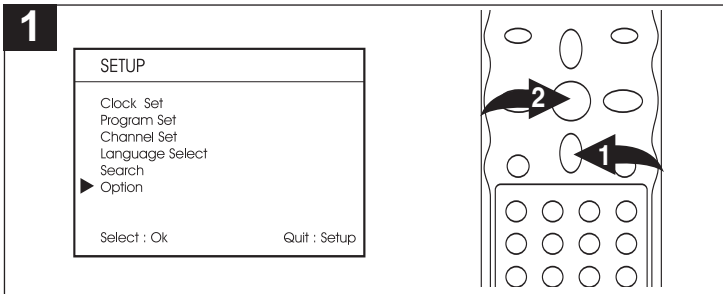

Enter the VCR mode and the Setup screen as described on page 24; the Setup menu will appear. Scroll to OPTION using the Navigation (▼) button ❶. Press the OK button ❷ to select it; the Option menu will appear.

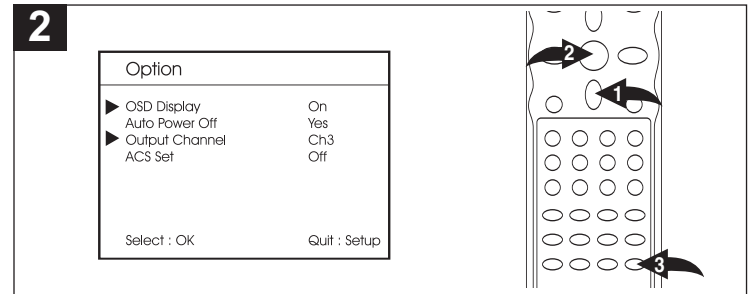

Press the Navigation (▼) button ❶ to select OSD Display. Press the OK button ❷ to turn the OSD On or Off. If OSD is turned On, you can press the DISPLAY button ❸ twice when in the VCR mode and the OSD will always appear on the screen.

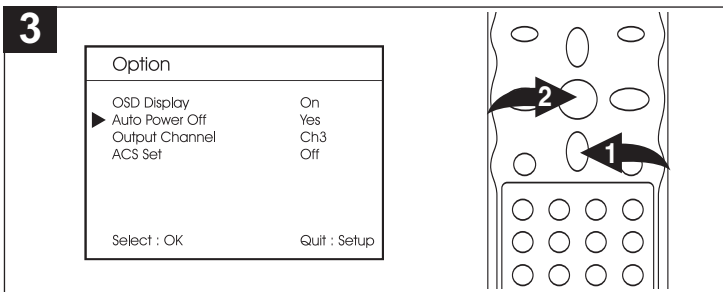

Press the Navigation (▼) button ❶ to select Auto Power Off. Press the OK button ❷ to turn the Auto Power Off option On (Yes) or Off (No). When set to ON (Yes), while in VCR or DVD mode, the unit will automatically turn off after 30 minutes when both the VCR and DVD are not being used.

NOTE: There is no Auto Power Off function for the TV mode.

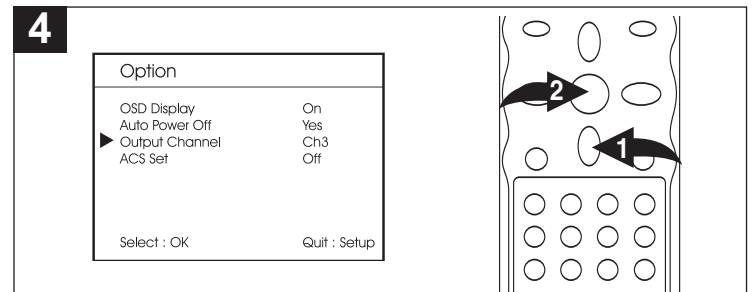

Press the Navigation (▼) button ❶ to select Output Channel. Press the OK button ❷ to set the output channel to 3 or 4.

This setting is for the TV channel of the VCR output when using the RF output to the TV.

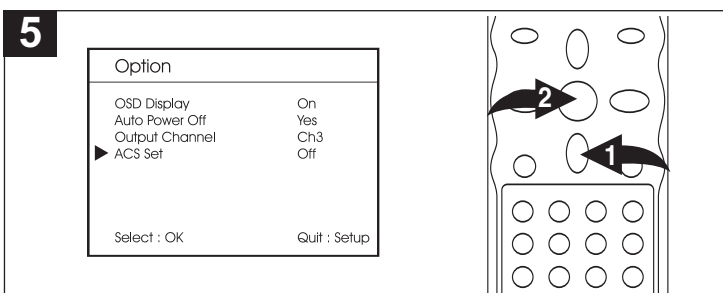

Press the Navigation (▼) button ❶ to select ACS Set. Press the OK button ❷ to turn the ACS SET option On or Off. When you turn the ACS (Auto Clock Setting) function ON, each time when you turn the unit off to Standby mode, the Auto Clock function will automatically set the built-in clock (Month, Day, Year and Time) if the VCR is connected to an Antenna or Cable system. The Auto clock needs several minutes to set itself.

NOTE:

- If you use a cable box and you want the auto clock adjustment to be performed, the cable box must be left on.

VCR OPERATION

LOADING

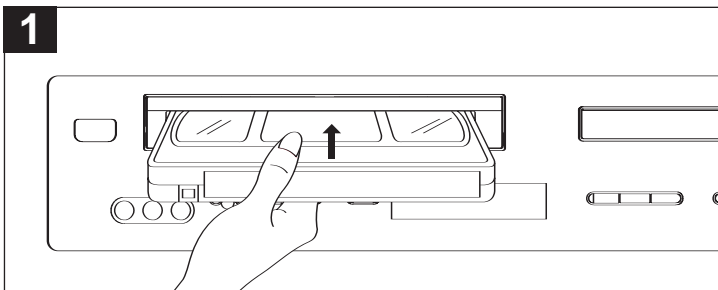

Push the center of the tape until it is automatically retracted into the VCR.

AUTOMATIC POWER ON

The VCR will turn on automatically.

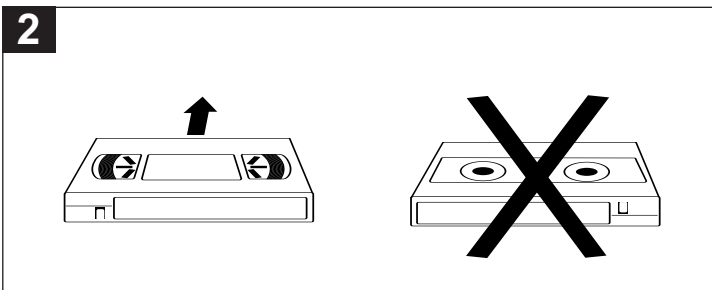

AUTOMATIC PLAY

When loading a cassette tape without the erase prevention tab intact, playback will start immediately. An inverted video cassette cannot be inserted.

If the unit is in DVD mode, press the DVD/VCR button (on the main unit) or VCR Button (on the remote) to change the unit to VCR mode, then press the PLAY/PAUSE ►|| button to start tape playback.

UNLOADING

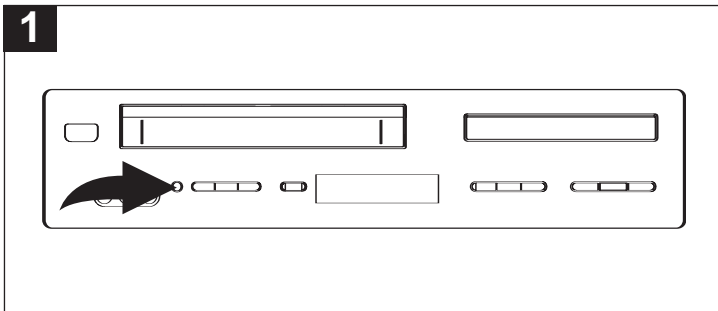

To unload a video cassette, press the EJECT button on the unit or press the OPEN/CLOSE/EJECT button on the remote control; the tape will stop and it will eject out.

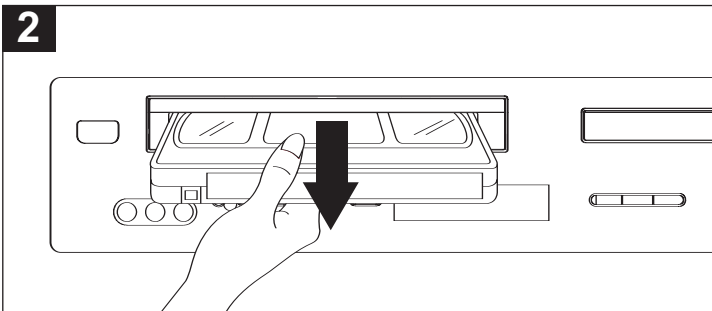

Pull the cassette out.

The EJECT button can be pressed even when the power is off and the tape will be ejected. Always eject the tape when not in use.

TO PREVENT ACCIDENTAL ERASURE

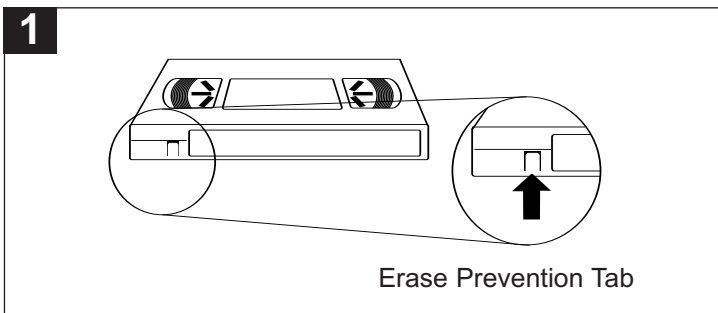

After recording, break off the erase prevention tab if you do not wish to record over the tape.

TO RECORD AGAIN

Cover the hole with vinyl tape.

Be careful the tape does not extend past the edges of the video cassette housing.

TAPE SPEED AND MAXIMUM RECORDING TIME

Tape Speed	Cassette		
	T-60	T-120	T-180
SP	1 hour	2 hours	3 hours
SLP	2 hours	4 hours	6 hours

Press the SP/SLP button to select the recording speed. Speed selection is automatic during playback. The "SP" mode is recommended for recording music programs.

VCR OPERATION (CONTINUED)

TO START PLAYBACK

If the unit is in DVD mode, press the DVD/VCR button (on the main unit) or VCR Button (on the remote) to change the unit to VCR mode.

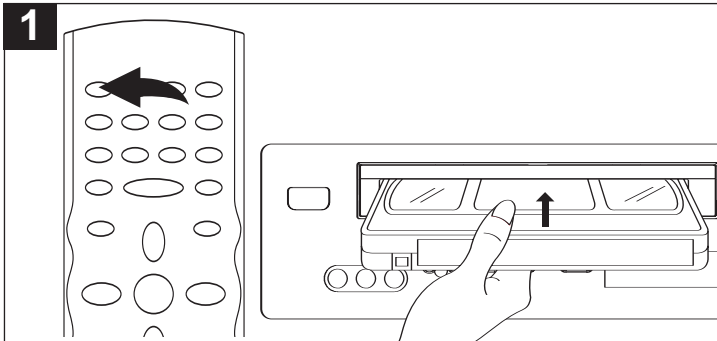

Press the POWER button to turn on the unit and load a prerecorded tape. (When loading a tape with the Erase Prevention Tab intact, playback will begin automatically.)

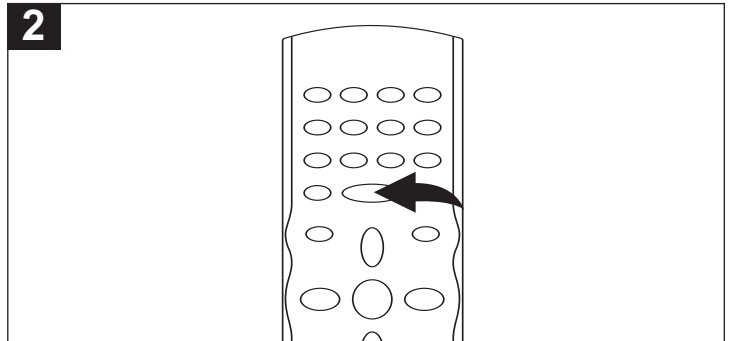

If playback does not begin automatically, press the PLAY/PAUSE ►|| button to begin playback. The unit will automatically adjust the tracking to obtain the best possible picture.

TO STOP PLAYBACK

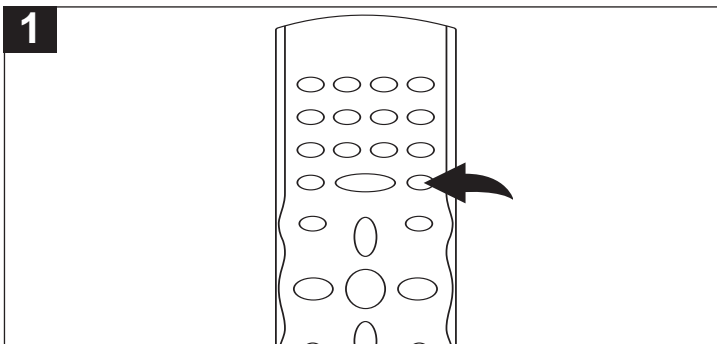

Press the STOP ■ button, the tape will stop, but remain fully loaded and ready to play.

NOTE: If you are in VCR mode, when playback reaches the end of the tape, it will stop. Then the tape will be rewound automatically to the beginning and the unit will turn off (to the Standby mode) automatically.

TO SELECT THE EXTERNAL INPUT

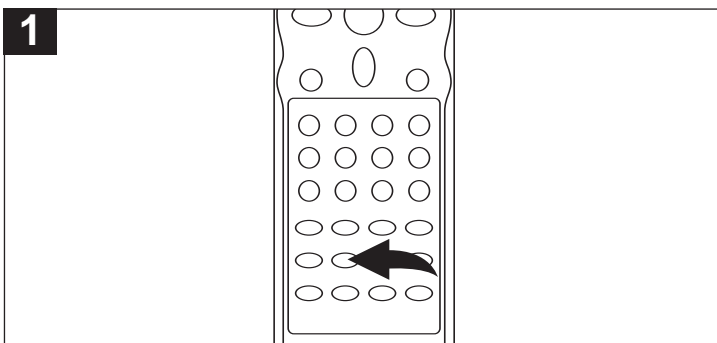

Press the AV1/AV2 button to cycle between the inputs (AV1 (rear A/V jacks), AV2 (from A/V jacks) or the Antenna/Cable TV).

COUNTER RESET

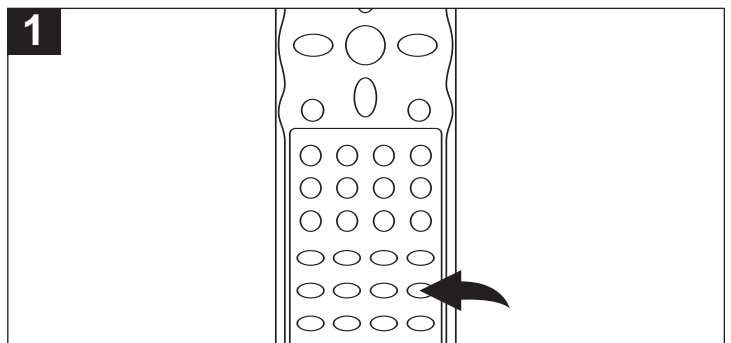

During playing of a cassette tape, press the COUNTER RESET/CLEAR button once to reset the counter to 0:00:00.

VCR OPERATION (CONTINUED)

TO REWIND THE TAPE RAPIDLY

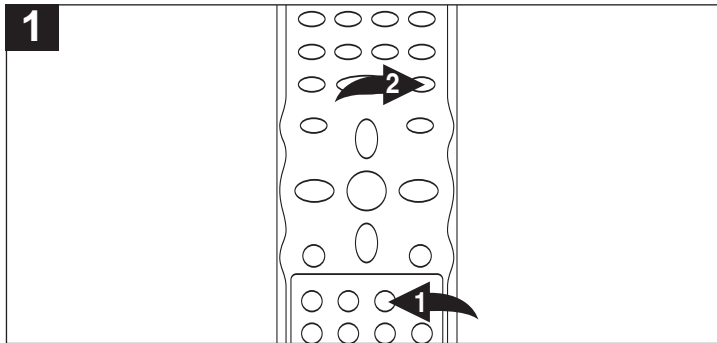

Press the Reverse Search ◀◀ (Rewind) button ❶ while in the Stop mode; "REW" will appear in the display. Press the STOP ■ button ❷ when done. When it reaches the beginning of the tape, it will stop.

TO FAST FORWARD THE TAPE RAPIDLY

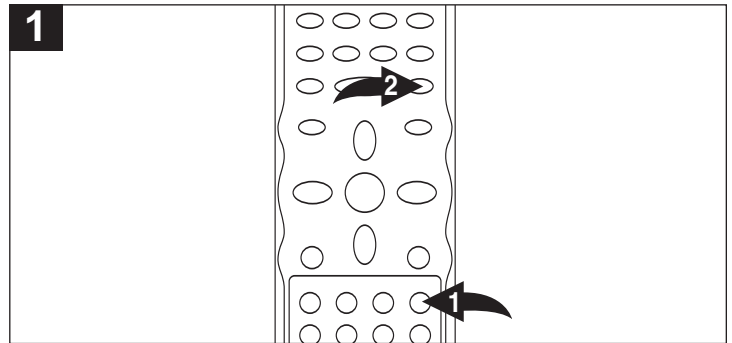

Press the Forward Search ▶▶ (Fast Forward) button ❶ while in the Stop mode; "FF" will appear in the display. Press the STOP ■ button ❷ when done. When it reaches the end of the tape, it will stop.

TO VISUALLY SEARCH BACKWARD

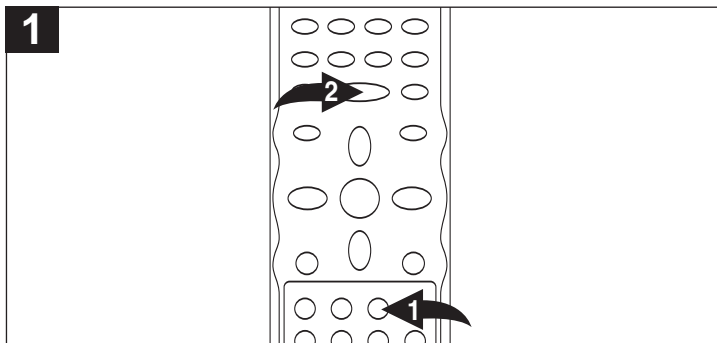

Press the Reverse Search ◀◀ (Rewind) button ❶ while in the Play mode to visually search backward with x3 speed for SP mode (x9 speed for SLP mode). Press again to visually search backward with x5 speed for SP mode (x15 speed for SLP mode). Press the PLAY/PAUSE ▶|| button ❷ to resume normal playback.

TO VISUALLY SEARCH FORWARD

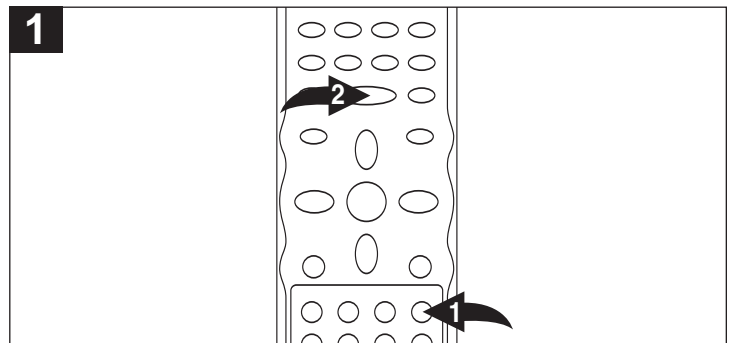

Press the Forward Search ▶▶ (Fast Forward) button ❶ while in the Play mode to visually search forward with x3 speed for SP mode (x9 speed for SLP mode). Press again to visually search forward with x5 speed for SP mode (x15 speed for SLP mode). Press the PLAY/PAUSE ▶|| button ❷ to resume normal playback.

PAUSE/STEP

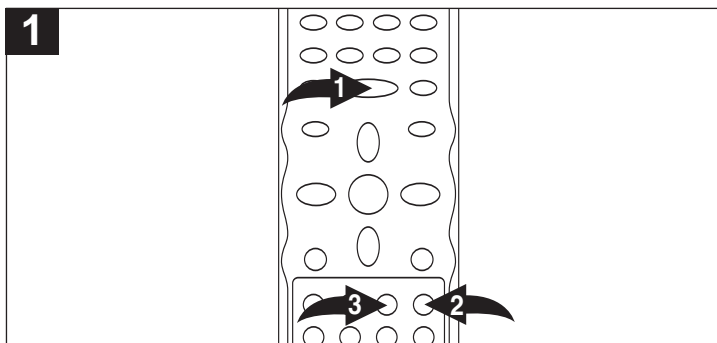

Press the PLAY/PAUSE ▶|| button ❶ while in the Play mode to pause the picture. Press the Forward Search ▶▶ (Fast Forward) button ❷ or Reverse Search ◀◀ (Rewind) button ❸ to play the tape in forward or reverse slow motion. Press the PLAY/PAUSE ▶|| ❶ to resume playback.

NOTES:

- Best results during speed search and still playback can be obtained with video cassettes recorded in the "SP" mode.
- The audio output is muted during Speed Search and Still.
- A few noise bars will appear on the TV screen during Speed Search and Still.
- To prevent damage to the tape, Still mode is automatically changed to the Stop mode after 5 minutes.

VCR OPERATION (CONTINUED)

TO VIEW ANOTHER PROGRAM WHILE RECORDING

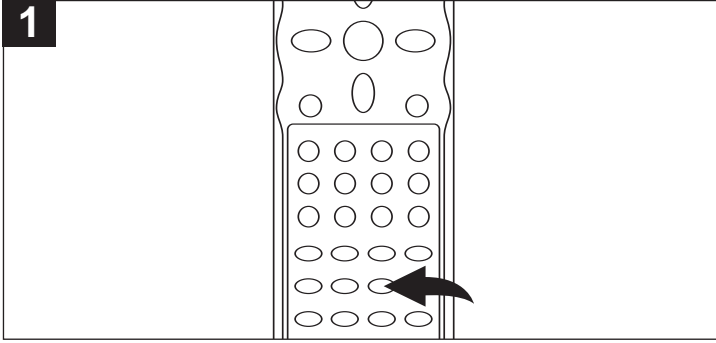

If this VCR/DVD Combo is connected to a TV through the antenna socket, when the unit is turned on, the combo will block the antenna signal and send the modulated signal to the TV so you can watch the VCR but cannot receive other signals from antenna. If you are recording a TV program and wish to watch another channels, you need to switch to TV mode by pressing TV/VCR button. In TV mode, the "VCR" will go off but recording will continue; then you can watch for the TV channel and select the desired channel using the TV's channel selector.

DISPLAY

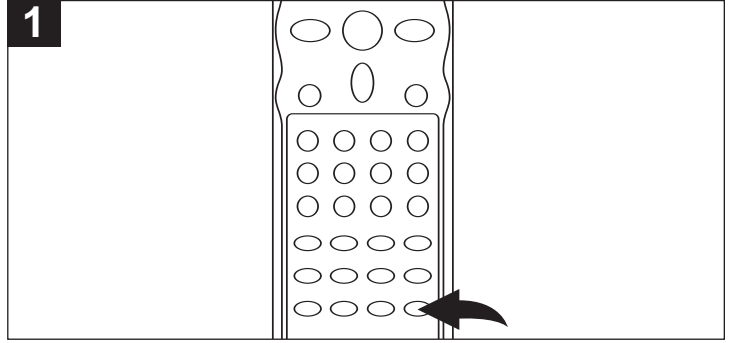

If you set the OSD Display to OFF (see page 32, Setting the VCR Option): While in the VCR mode, press the DISPLAY button to view the VCR mode, counter, speed, Audio Setting/Channel/Video Source, current day and time. After 5 seconds, the display will disappear on the screen.

If you set the OSD Display to ON: While in the VCR mode, press the DISPLAY button to view the VCR mode, counter, speed, Audio Setting/Channel/Video Source, current day and time. After 5 seconds, the display will disappear on the screen. Within 5 seconds, press the DISPLAY button twice to view the VCR mode, counter and Audio Setting/TV Channel/Video source, the display will continuously appear on the screen until you press the DISPLAY button again.

NOTE: The Display function is only available during playback, recording or while in the VCR Stop mode.

MTS/AUDIO

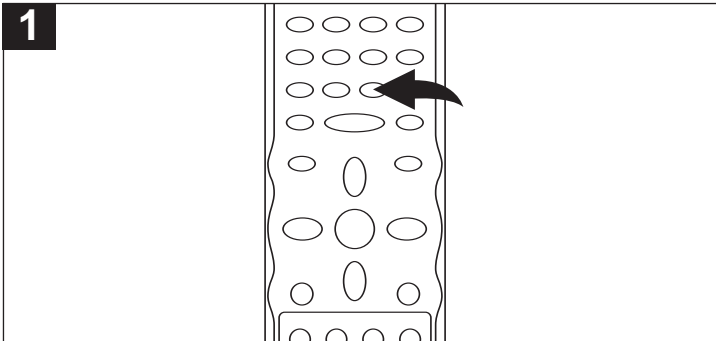

While playing a cassette, press the MTS/AUDIO button to select the desired audio output (HiFi L+R, HiFi L, HiFi R or Linear).

VCR OPERATION (CONTINUED)

RECORDING A TV PROGRAM/EXTERNAL AV INPUT

If the unit is in DVD mode, press the DVD/VCR button (on the main unit) or VCR Button (on the remote) to change the unit to VCR mode.

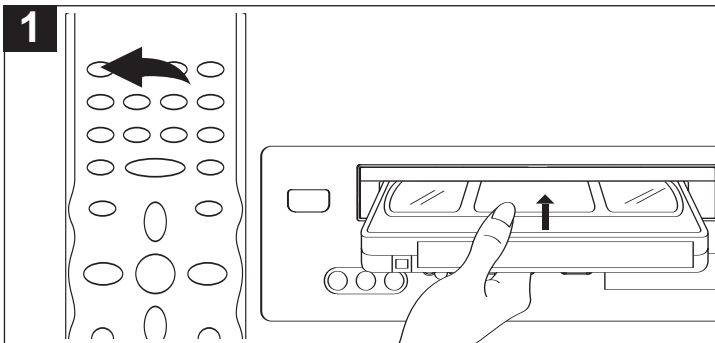

Press the POWER button to turn on the unit and load a tape with the Erase Prevention Tab intact.

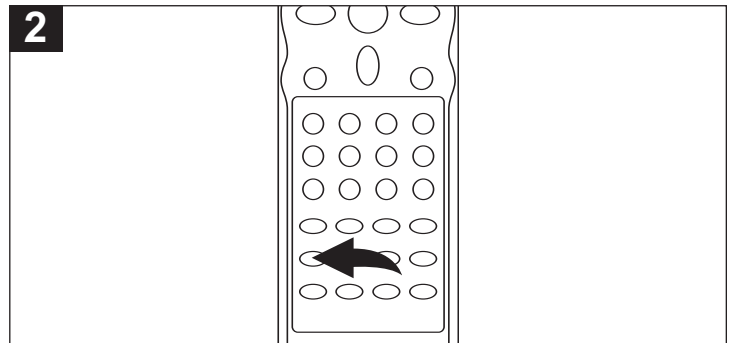

Press the SP/SLP button to select the desired tape speed. See page 33 for more information on tape usage.

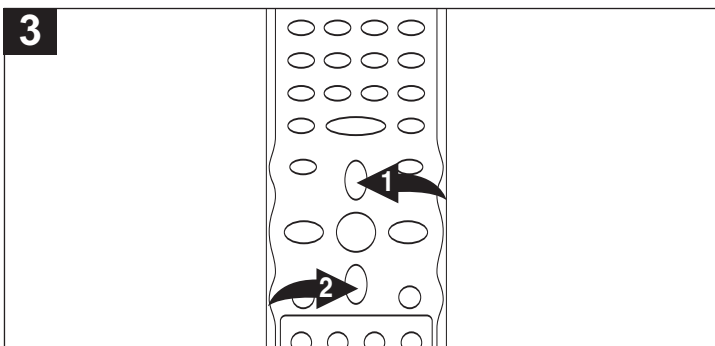

Press the CHANNEL Up (▲) ❶ or Down (▼) ❷ button to select a channel to be recorded.

Press and hold the CHANNEL Up (▲) ❶ or Down (▼) ❷ button to change channels more rapidly.

NOTE: For Recording from the front or rear A/V inputs (VIDEO1 or Video 2), press the AV1/AV2 button repeatedly to select Video 1 or Video 2.

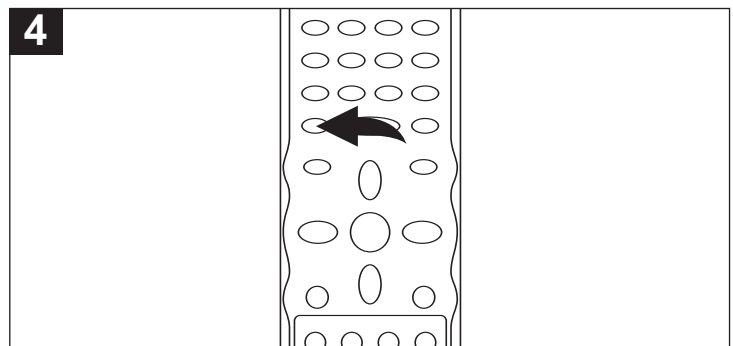

Press the REC button to begin recording; the REC indicator will light in the display and on the screen.

OVERLAPPING TIMER RECORDINGS

Do not overlap programs as portions of the conflicting programs will be lost.

The first recording time has priority over the next recording time as shown in the diagram.

For the detailed setting of the Timer Program, please refer to pages 25 and 26.

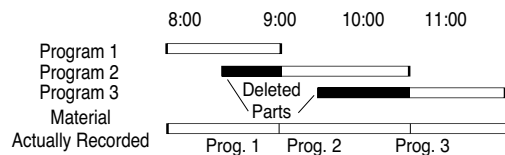

NOTES:

- The TV/VCR channel cannot be changed during recording.
- If the Erase Prevention Tab is removed, the tape will eject when the REC button is pressed.
- Press the COUNTER RESET/CLEAR button during recording to reset the counter to "0:00:00".
- If you want to view another TV channel/station during recording, see page 36 (TO VIEW ANOTHER PROGRAM WHILE RECORDING).
- When the end of the tape is reached during recording, it will stop recording automatically and the tape will be ejected.

VCR OPERATION (CONTINUED)

TO STOP RECORDING TEMPORARILY

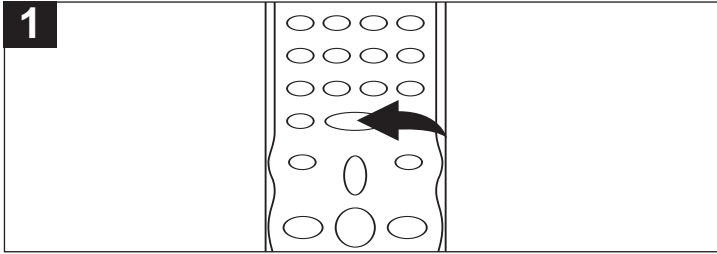

Press the PLAY/PAUSE ►|| button to avoid recording unwanted material. Press the PLAY/PAUSE ►|| button again to continue recording. The Pause mode will be released after 5 minutes to prevent damage to the tape, the unit will then be in the Stop mode.

TO STOP RECORDING

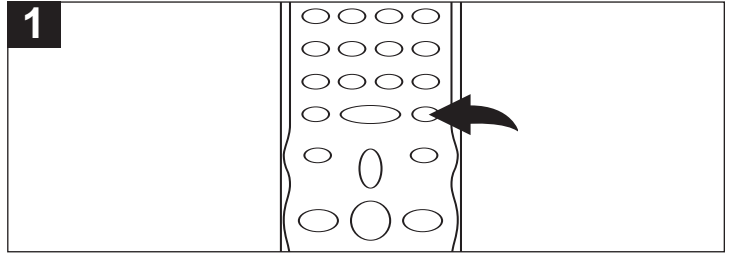

To stop recording, press the STOP ■ button.

ONE-TOUCH RECORDING

OTR is a simple and convenient way to make a timed recording without programming the Timer.

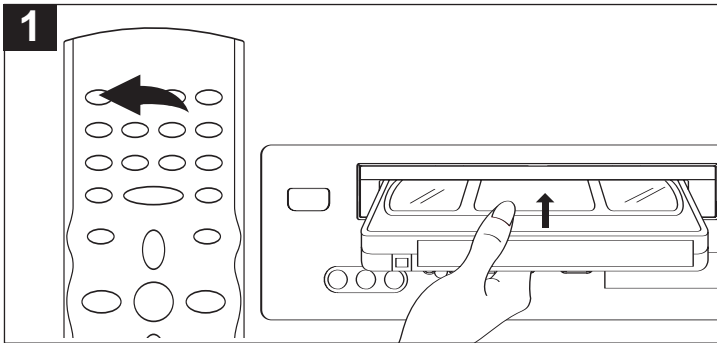

Press the POWER button to turn on the unit and load a tape with the Erase Prevention Tab intact.

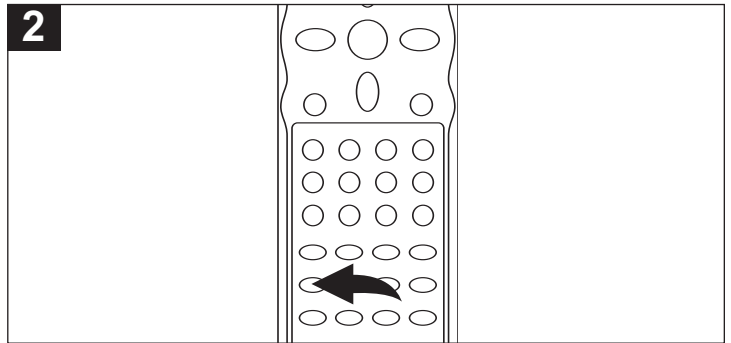

Press the SP/SLP button to select the desired tape speed. See page 33 for more information on tape usage.

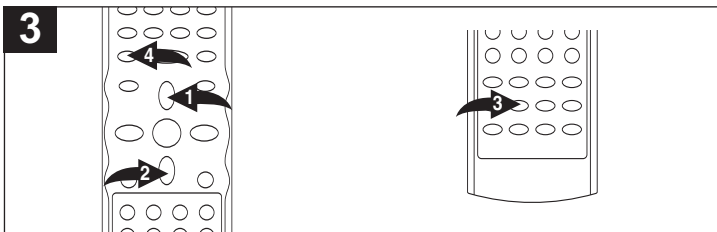

Press the CHANNEL Up (▲) ❶ or Down (▼) ❷ button to select a channel to be recorded. To record from the front or rear A/V inputs (VIDEO1 or Video 2), press the AV1/AV2 button ❸ repeatedly to select Video 1 or Video 2. Press the REC button ❹ once to start recording. Press it again to activate OTR (One-Touch Recording); "OTR 0:30" will appear on the screen and the unit will record for 30 minutes and then it will stop and turn off to the Standby mode.

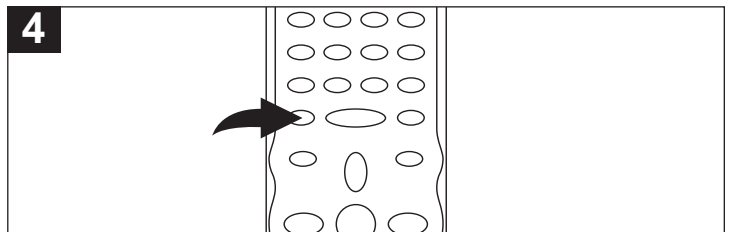

Within a few seconds, press the REC button to increase the recording time by 30 minutes. Each additional press of the REC button will increase recording time by 30 minutes, up to a maximum of eight hours. To stop and cancel OTR, press and hold the REC button until Stop appears on the display.

NOTES:

- If the tape's available recording time is shorter than the OTR time that you set, when the end of the tape is reached, the recording will stop and the tape will be ejected and the unit will turn off to the standby mode automatically.
- If you want to view for another TV channel/station during recording, see page 36 (TO VIEW ANOTHER PROGRAM WHILE RECORDING).
- The TV/VCR channel cannot be changed during recording.
- If the Erase Prevention Tab is removed, the tape will eject when the REC button is pressed.

VCR OPERATION (CONTINUED)

RECORDING FROM A DVD TO A CASSETTE

IMPORTANT: Many commercial DVDs have copyright protection that will not enable them to be recorded. In this case, you will not be able to copy it.

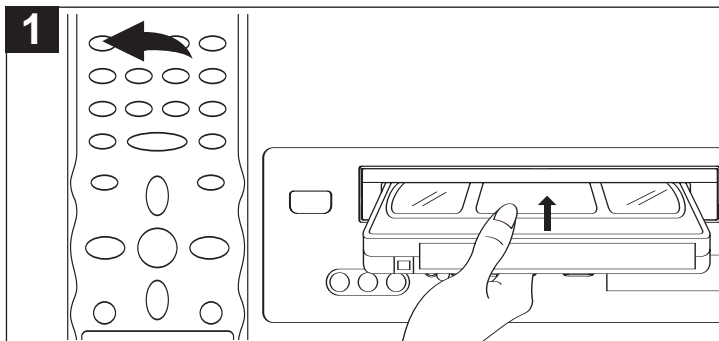

Press the **POWER** button to turn on the unit and load a tape with the Erase Prevention Tab intact.

NOTE: Press the DVD/VCR button (on the main unit) or VCR Button (on the remote) to change the unit to VCR mode if the unit is in the DVD mode.

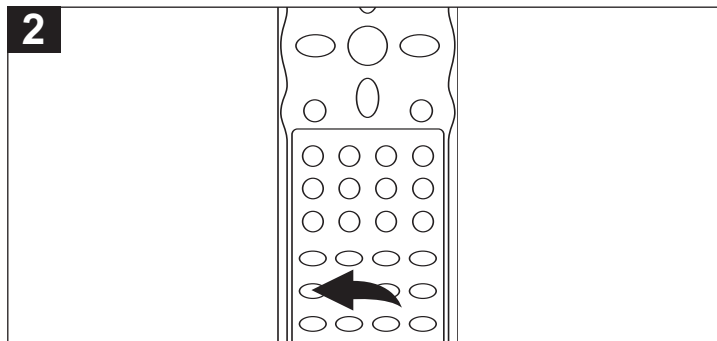

Press the **SP/SLP** button to select the desired tape speed. See page 33 for more information on tape usage.

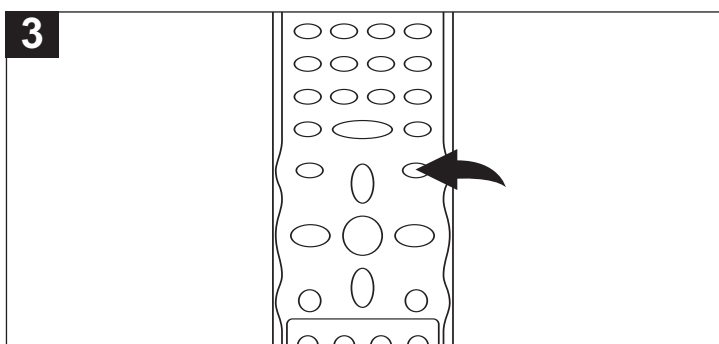

Press the **DVD** button to select the DVD.

NOTE: Press the DVD/VCR button (on the main unit) or DVD Button (on the remote) to change the unit to DVD mode if the unit is in the VCR mode.

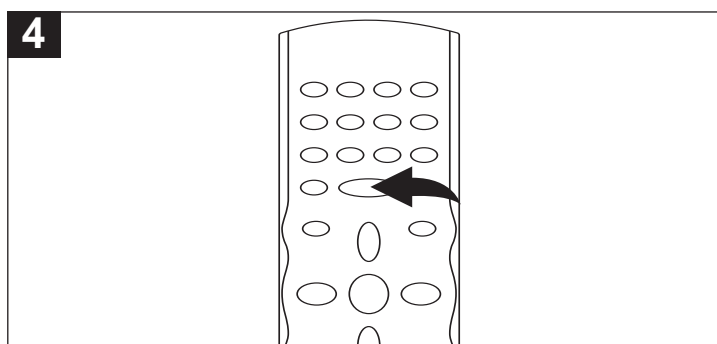

Press the **PLAY/PAUSE** ►|| button to start DVD playback.

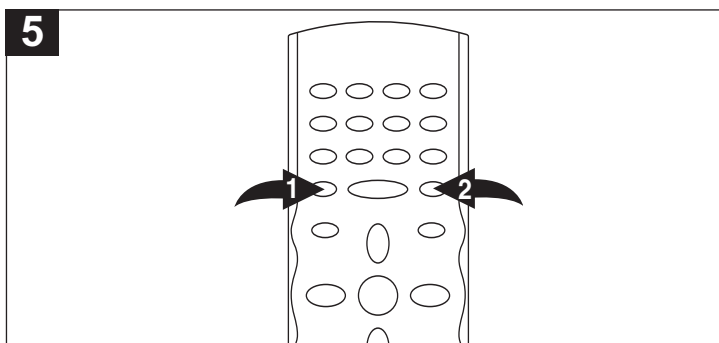

When you want to start recording, press the **REC** button ❶; REC will appear in the display. To stop recording, press the **STOP** ❷ button, the unit will stop recording and the DVD playback will stop.

DVD BASIC OPERATION (GENERAL)

IMPORTANT:

When “” appears while pressing a button, this means that the corresponding function cannot be performed either on the disc inserted, or in the selected mode.

MTS/AUDIO

While playing a disc, you can cycle between the audio modes as follows:

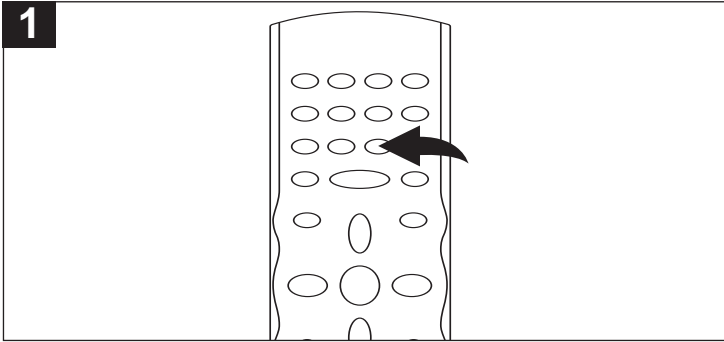

DVD Disc: Press the MTS/Audio button to cycle through the audio modes. The audio modes vary depending on the disc inserted.

VCD Disc: Press the MTS/AUDIO button to cycle through the audio modes including MONO LEFT, MONO RIGHT, MIX-MONO and STEREO.

“” will appear if the disc does not support audio mode changing.

DISPLAY

Each press of the DISPLAY button will display the elapsed time and remaining time of a playing disc. Each press of the DISPLAY button will cycle through, depending on the playback mode as follows:

	DVD	VCD
1st press	Title Elapsed Time	Track Elapsed Time
2nd press	Title Remaining Time	Track Remaining Time
3rd press	Chapter Elapsed Time	Total Elapsed Time
4th press	Chapter Remaining Time	Total Remaining Time
5th press	Off	Off

CD/MP3: Press the DISPLAY button to select between the Track Elapsed Time and Track Remaining Time.

NOTE: For VCD, if the PBC is on, the Total Elapsed Time and Total Remaining Time will not be available.

DVD BASIC OPERATION

IMPORTANT NOTES:

- “” will appear on the TV screen during operation if you try to access a function that is not available on the disc.
- Some discs may take a few seconds to load.
- If a disc is inserted incorrectly, is dirty and/or damaged, or is not present at all, “NO DISC” will appear in the display.
- Always hold the disc without touching either of its surfaces. When inserting a disc, position it with the printed title side facing up, align it with the guides and place it in its proper position.
- It is important that you read the manual that accompanies the DVD disc as there are features that are on this player that cannot be used with certain DVDs. There are also extra features that are different for each DVD disc, so they are not explained in this owner’s manual.

PLAYBACK OF A DVD

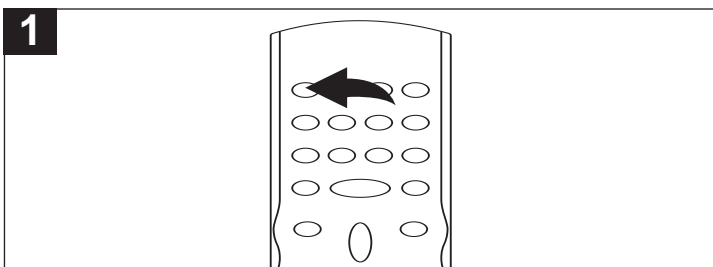

Press the POWER button to turn on the unit.

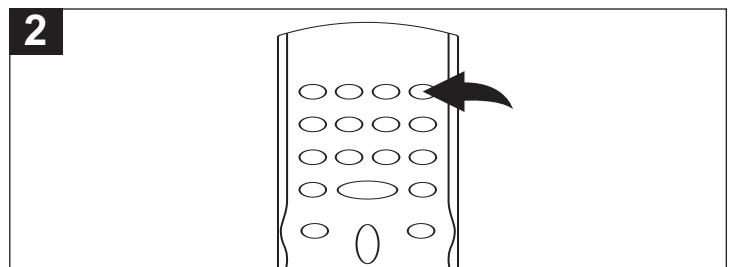

While in the DVD mode (DVD button pressed first), press the OPEN/CLOSE button to open the disc tray, “OPEN” will appear on the screen. Insert a disc with the label side facing up on the disc tray. Press the OPEN/CLOSE button to close the disc tray. “CLOSE” will appear on the screen.

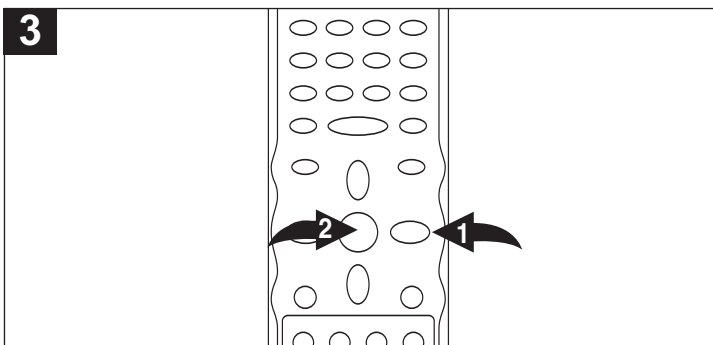

After loading, “DVD VIDEO” will appear on the screen and the menu screen of the DVD should appear. Use the Navigation (◀, ▶, ▲, ▼) buttons ① to select the desired option and the OK button ② to select it.

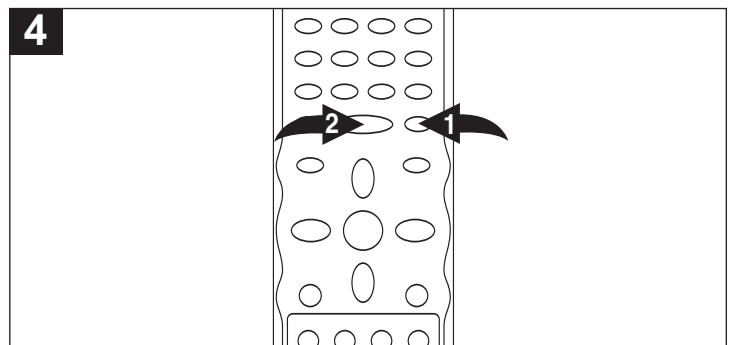

To stop playback, press the Stop (■) button ①; “PRESS PLAY KEY TO CONTINUE” will appear on the TV screen. Because the unit will remember where you stopped, simply press the PLAY/PAUSE ▶|| button ② to resume playback where you left off (resuming playback). If the Stop (■) button ① is pressed twice, the unit will stop completely.

NOTES:

- If a MENU appears on the TV screen, press the Navigation (◀, ▶, ▲, ▼) buttons to select the desired option/item, then press the OK button. Please make sure to refer to the disc’s jacket or case for additional information.
- Resuming playback may not work on all discs.

DVD BASIC OPERATION (CONTINUED)

SKIP

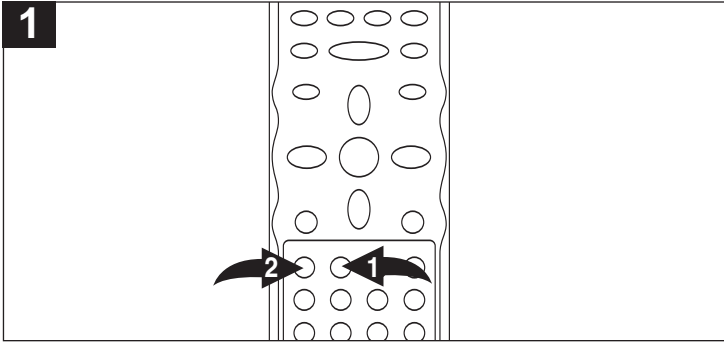

Press the NEXT ►► button ❶ to advance the DVD to the beginning of the next chapter.

Press the PREVIOUS ◄◄ button ❷ to move the DVD to the beginning of the previous chapter.

SEARCH

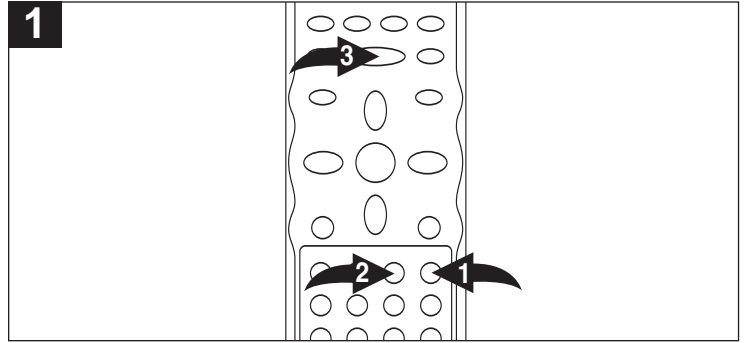

During playback, press either the Forward ►► ❶ or Reverse ◄◄ ❷ Search button to move the DVD forward or backward at double (x2) speed to locate a specific section. Repeatedly press these buttons and the speed will increase to x4, x8, x16 and resume normal playback. You can also resume normal playback by pressing the PLAY/PAUSE (►||) button ❸.

SLOW/F

Use this feature to move the DVD in slow motion.

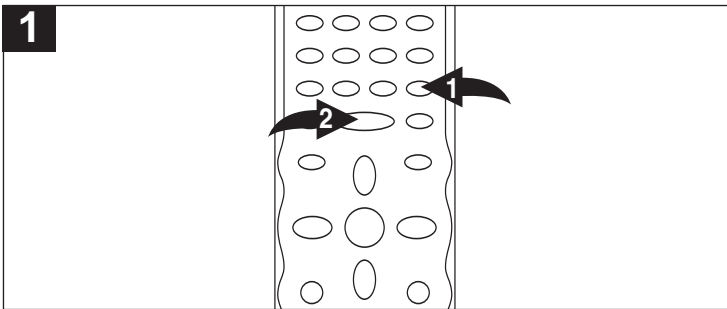

During playback, press the SLOW/F button ❶ to move the DVD forward in slow motion speeds of 1/2, 1/4, 1/8, 1/16 and resume normal playback. The sound will be muted.

You can also resume normal playback by pressing the PLAY /PAUSE (►||) button ❷.

PAUSE AND STEP

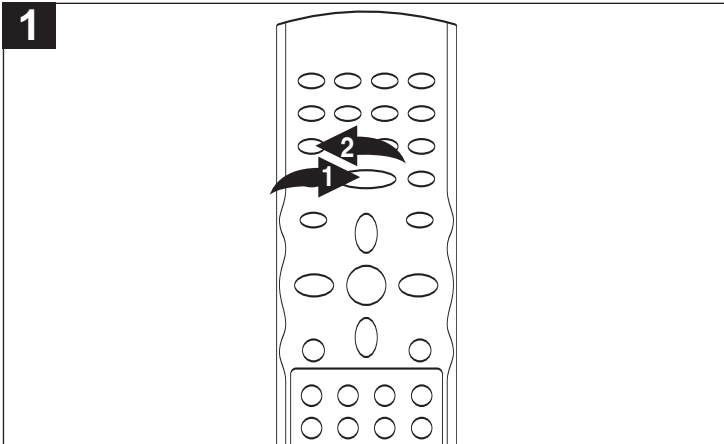

Press the PLAY/PAUSE (►||) button ❶ to pause the picture.

Repeatedly press the STEP button ❷ to play the DVD one frame at a time.

Press the PLAY/PAUSE (►||) button ❶ to resume normal playback.

If the Screen Saver option (page 19) is set to ON, the screen saver will appear in approximately one minute.

DVD BASIC OPERATION (CONTINUED)

TITLE/CHAPTER SEARCH

Use this feature to directly go to a specific title and/or chapter.

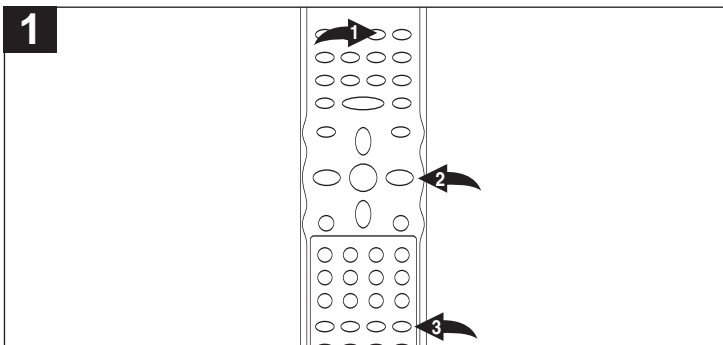

Press the SEARCH button ❶ once. Press the Navigation (◀, ▶) buttons ❷ to select the Title ("TT"), then use the Number buttons ❸ to select the desired title number (i.e. for number 5, press "0", "5"). Playback will start immediately.

OR

Press the Navigation (◀, ▶) buttons ❷ to select the Chapter ("CH"), then use the Number buttons ❸ to select the desired chapter number (i.e. for number 2, press "0", "2"). Playback will start immediately.

TITLE/CHAPTER/TIME SEARCH

Use this feature to directly go to a specific title and/or time.

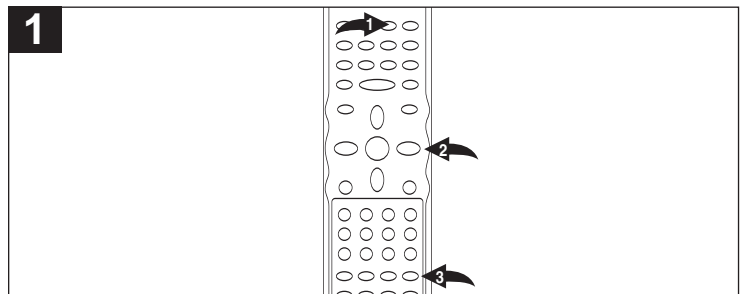

Press the SEARCH button ❶ twice. Press the Navigation (◀, ▶) buttons ❷ to select the Title ("TT"), then use the Number buttons ❸ to select the desired title number (i.e. for number 5, press "0", "5"). Playback will start immediately. **OR**

Press the Navigation (◀, ▶) buttons ❷ to select the Title Time ("T"), then use the Number buttons ❸ to select the desired Title Time (Hour/Minutes/Seconds); playback will start immediately.

Press the SEARCH button ❶ a third time. Press the Navigation (◀, ▶) buttons ❷ to select the chapter, then use the Number buttons ❸ to select the desired chapter number (i.e. for number 5, press "0", "5"). Playback will start immediately. **OR**

Press the Navigation (◀, ▶) buttons ❷ to select the Chapter Time ("T"), then use the Number buttons ❸ to select the desired title time (Hour/Minutes/Seconds); playback will start immediately."

REPEAT PLAYBACK

While playing back a DVD, this unit can repeatedly play back a chapter or title.

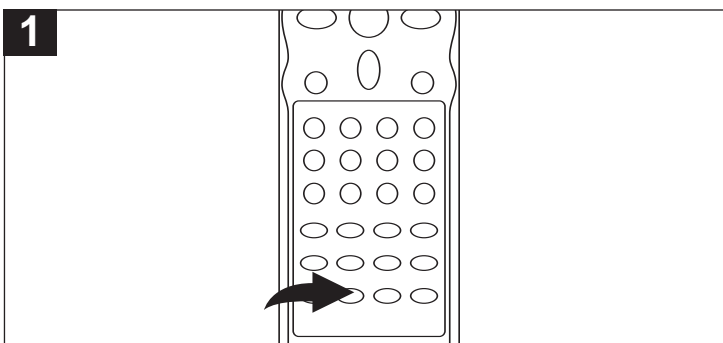

While in the Playback mode, press the REPEAT button once; "⌂ CHAPTER" will appear on the TV screen for a few seconds and the currently playing Chapter will repeat continuously.

While in the Playback mode, press the REPEAT button a second time; "⌂ TITLE" will appear on the TV screen for a few seconds and the currently playing Title will repeat continuously. Press the REPEAT button once more to cancel Repeat mode; "OFF" will appear on the TV screen for three seconds then disappear.

A-B REPEAT PLAYBACK

While playing back a DVD, this unit can repeatedly play back a specific section.

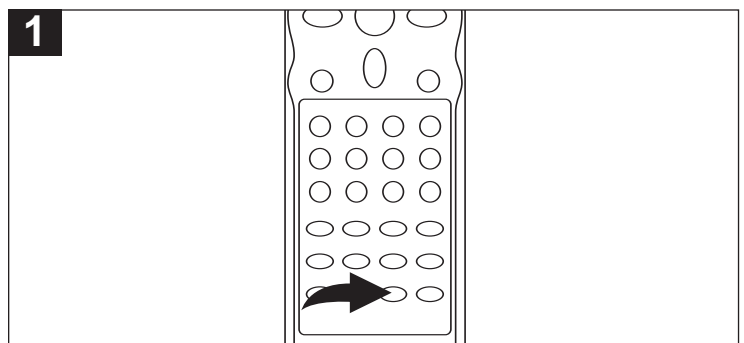

While in the Playback mode, press the Repeat A-B button to define where you want the section to start. Press the Repeat A-B button again to define where you would like the section to end, the unit will then play the selected area continuously. Press the Repeat A-B button again to cancel A-B Repeat mode.

NOTE:

- If you enter a time that exceeds the time limit of the DVD, then "⊘" will appear, and you must try again.
- Repeat may not work properly with some discs.

DVD BASIC OPERATION (CONTINUED)

DVD MENU

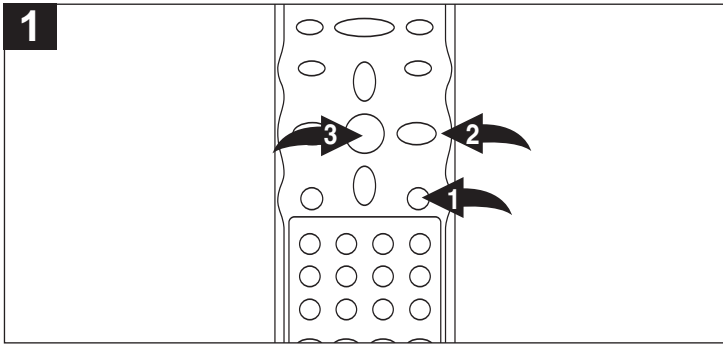

Press the DVD MENU button **1**, and the Main Menu of the disc will appear. Use the Navigation (**◀**, **▶**, **▲**, **▼**) buttons **2** to select the desired option, and then press the OK button **3**. This is not available on all discs.

TITLE MENU

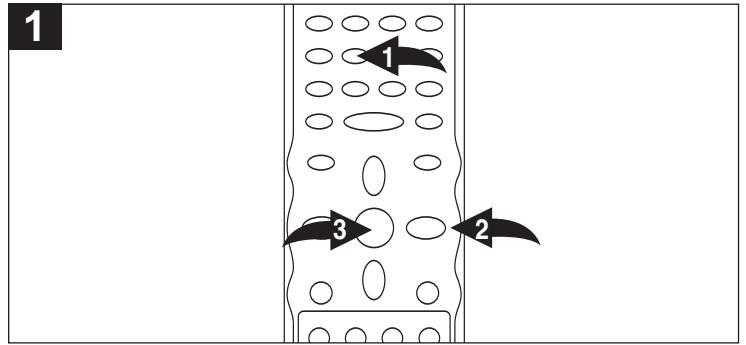

Press the TITLE button **1**, and the Title Menu of the disc will appear. Use the Navigation (**◀**, **▶**, **▲**, **▼**) buttons **2** to select the desired option, and then press the OK button **3**. This is not available on all discs.

SUBTITLE MENU

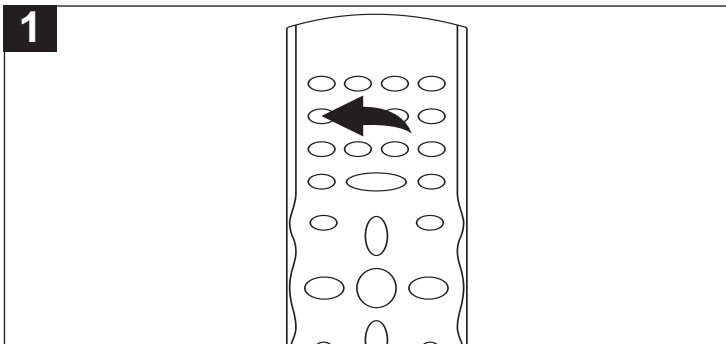

Press the SUBTITLE MENU button repeatedly to select a subtitle language, and to turn the subtitle menu on/off. This feature is not available on all discs.

ZOOM

The image on the screen can be magnified as follows:

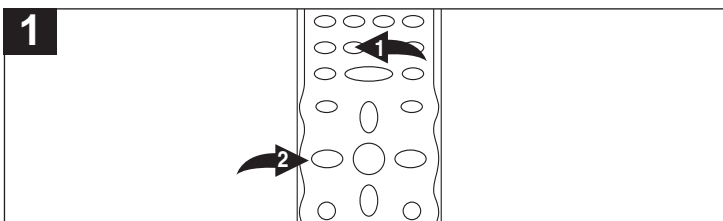

Press the ZOOM button **1** once during Normal, Slow or Still playback modes, and the unit will zoom x2. Press once or twice more and the unit will zoom x3/x4. Use the Navigation (**◀**, **▶**, **▲**, **▼**) buttons **2** to move the image on the TV screen. Press the ZOOM button **1** once more to cancel the zoom function. This is not available on all discs.

ANGLE

Some discs may contain scenes which have been shot simultaneously from a number of different camera angles. This feature only works on discs with more than one camera angle. The jacket will be marked with "◻" icon.

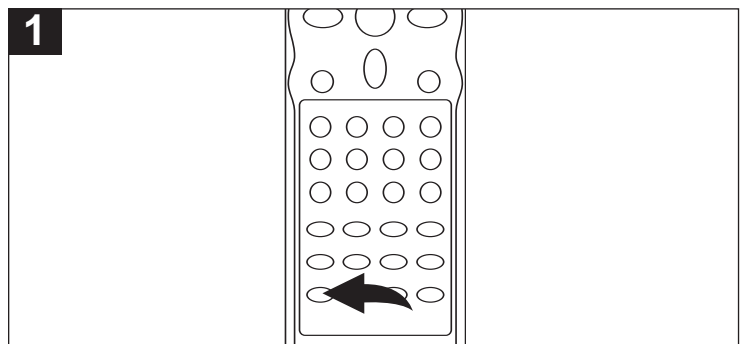

While in the Playback mode, press the ANGLE button; the total number of angles will appear on the screen. Repeatedly press the ANGLE button to select the desired angle; the angle will change in one to two seconds. This is not available on all discs.

MP3 BASIC OPERATION

PLAYBACK OF AN MP3 DISC

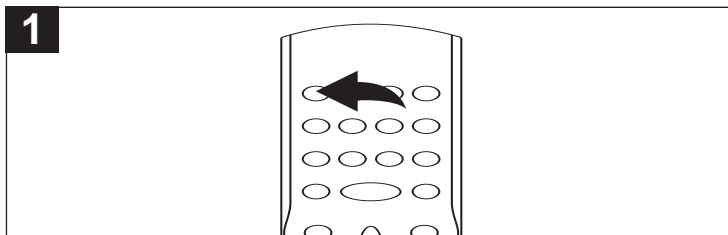

Press the POWER button to turn on the unit.

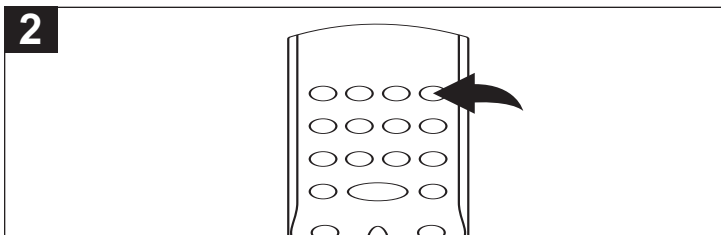

While in the DVD mode (DVD button pressed first), press the OPEN/CLOSE button to open the disc tray, "OPEN" will appear on the screen. Insert an MP3 disc with the label side facing up on the disc tray. Press the OPEN/CLOSE button to close the disc tray. "CLOSE" will appear on the screen and the display.

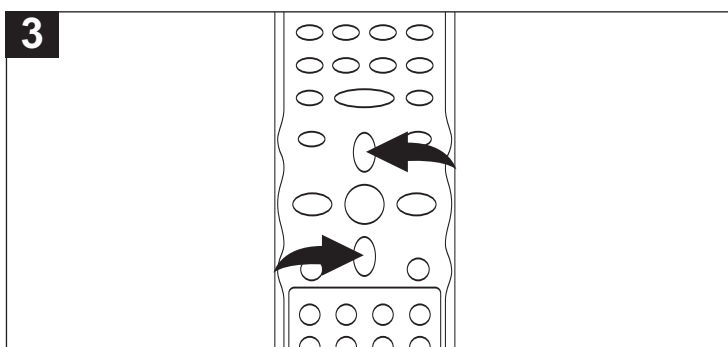

After loading, the FOLDER/TRACK menu will appear on the TV screen. Press the NAVIGATION (▲, ▼) buttons to select the desired folder/file.

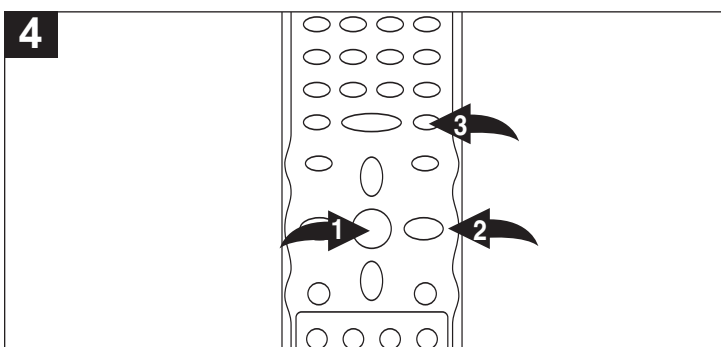

Press the OK button ❶ to confirm. If there are no folders on the disc, playback will begin immediately. If there are folders, then press the Navigation (▲, ▼) buttons ❷ to select the desired folder, then press the OK button ❶. Press the Navigation (▲, ▼) buttons ❷ to select the desired track, then press the OK button ❶ to play the track. Press the STOP (■) button ❸ to stop playback. To return to select another folder, while in the Stop mode, repeatedly press the Navigation (◀) button ❷. The FOLDER/TRACK menu will appear again on the TV screen.

MP3 BASIC OPERATION (CONTINUED)

SELECTING FOLDERS/TRACKS USING THE (▶▶) OR (◀◀) BUTTON

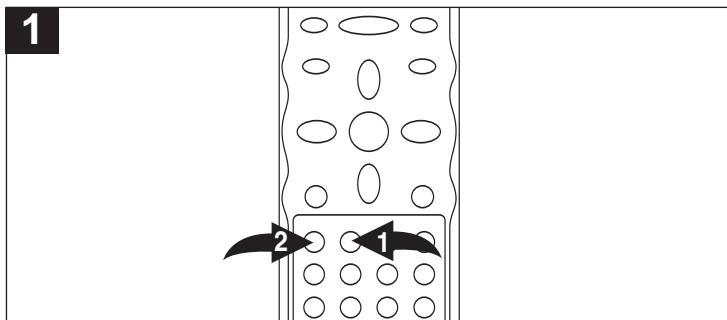

During playback, simply press the NEXT ▶▶ ❶ or PREVIOUS ◀◀ ❷ button to select a track to be played.

SELECTING FOLDERS/TRACKS USING THE NUMBER BUTTONS

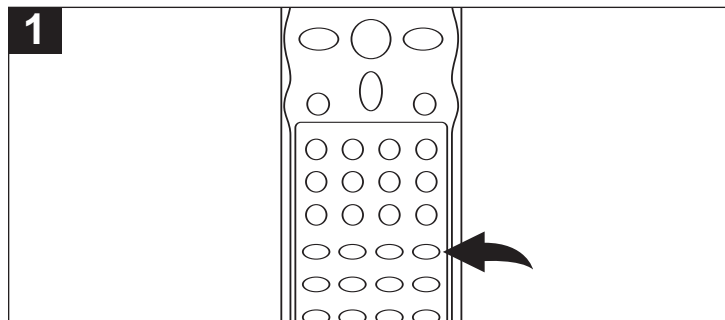

During playback, press the Number buttons corresponding to the track numbers to select your desired track, and the unit will playback the desired track automatically. Enter a 3 digit number for the track number, i.e. to playback the second track, enter "002".

FORWARD ▶▶/REVERSE ◀◀

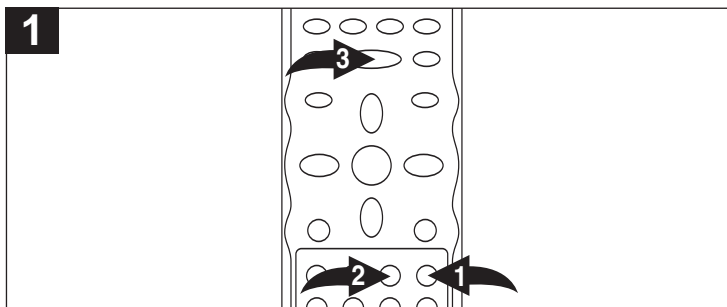

Each press of the Forward ▶▶ ❶ or Reverse ◀◀ ❷ Search button will increase the search as follows:

- 1st press: x 2
- 2nd press: x 4
- 3rd press: x 8
- 4th press: x 16
- 5th press: Resume Normal Playback

Press the PLAY/PAUSE (▶||) button ❸ to resume normal playback.

REPEAT PLAY

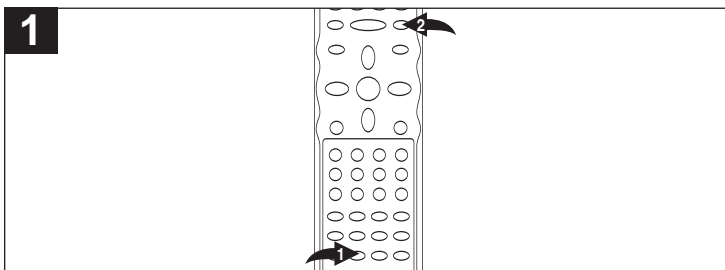

To Repeat play a track/file, simply select the track/file as described previously, then press the REPEAT button ❶ once; "◁ TRACK" will appear on the TV screen and the unit will repeat the selected track/file continuously until the STOP ■ button ❷ is pressed. Press the REPEAT button ❶ a second time; "◁ ALL" will appear on the TV screen and the unit will repeat the tracks/files inside the folder until the STOP ■ button ❷ is pressed. If there are no folders on the disc, it will repeat all the tracks/files on the disc. To cancel Repeat play, press the REPEAT button ❶ until the Off indicator appears on the TV screen.

MP3 FAQs (Frequently Asked Questions) Please read before playing an MP3 CD.

What is an MP3 file?

An MP3 file is a computer format that makes a usually large music file into a smaller one which is more convenient to download and share.

Can I record my own MP3 CDs?

Yes, but you need a CD recorder, which is available from your local computer store.

Where can I find MP3 files?

MP3 files are available on the Internet.

Can this unit read regular music CDs?

Yes, it can. However, you cannot mix MP3s and WAV files on the same CD. If you do this, the unit will play only the MP3 files.

Can I use the MP3 extension for non-audio data files?

No, this may result in serious malfunction and harmful noise interference.

Can I mix MP3 files with other file types on the CDR?

Yes, but the unit will ignore those files and read only the MP3 files on the CDR.

Does this unit support subdirectories (subfolders)?

Yes, it can read MP3 files from subfolders.

CD/VCD BASIC OPERATION

PLAYBACK OF A CD/VCD

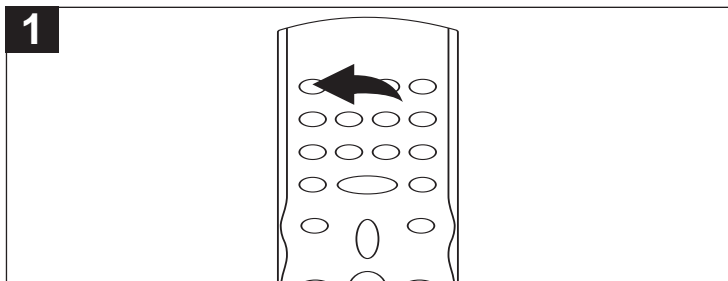

Press the POWER button to turn on the unit.

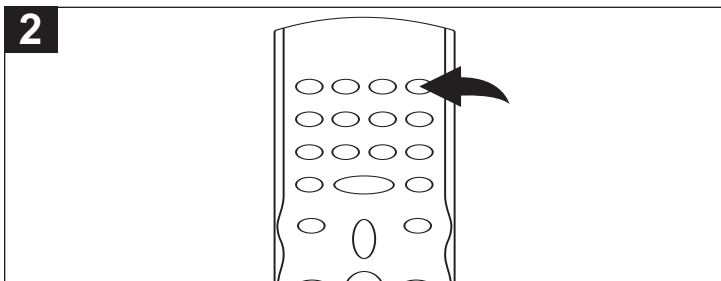

While in the DVD mode (DVD button pressed first), press the OPEN/CLOSE button to open the disc tray, "OPEN" will appear on the screen. Insert a disc with the label side facing up on the disc tray.

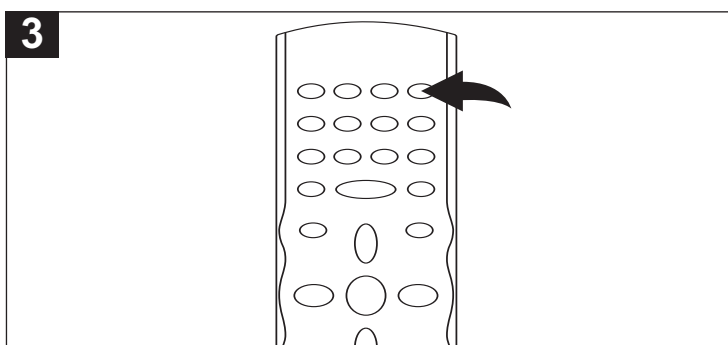

Press the OPEN/CLOSE button to close the disc tray. "CLOSE" will appear on the screen. After loading, playback will start automatically.

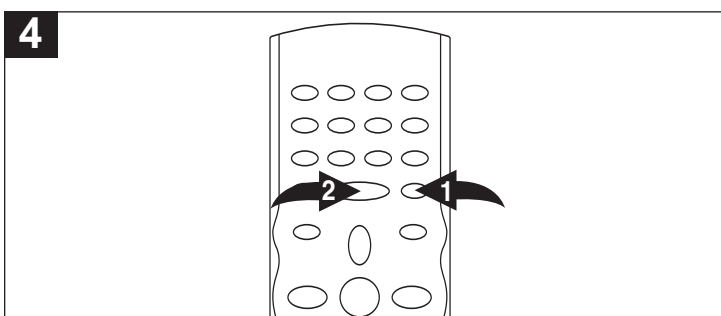

To stop playback, press the Stop (■) button ❶. Press the PLAY/PAUSE (▶||) button ❷ to resume playback. When playing a CD, the unit will resume playback at the beginning of the track.

SELECTING TRACKS/FILES USING THE NUMBER BUTTONS

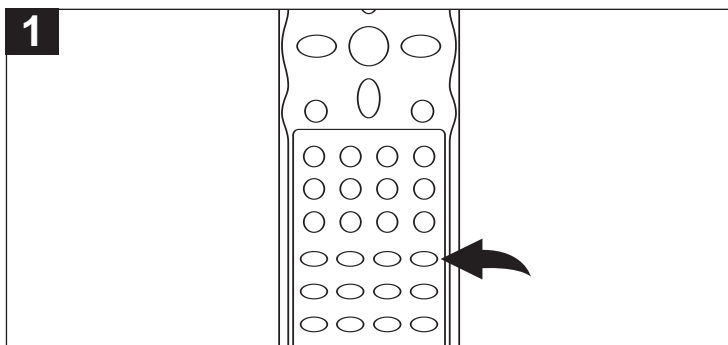

Press the Number buttons corresponding to the track number you would like to play, and the unit will playback the desired track automatically.

For a CD, enter a 3 digit number for the track number; i.e., to playback the second track, enter "002".

SELECTING TRACKS/FILES USING THE (▶) OR (◀) BUTTON

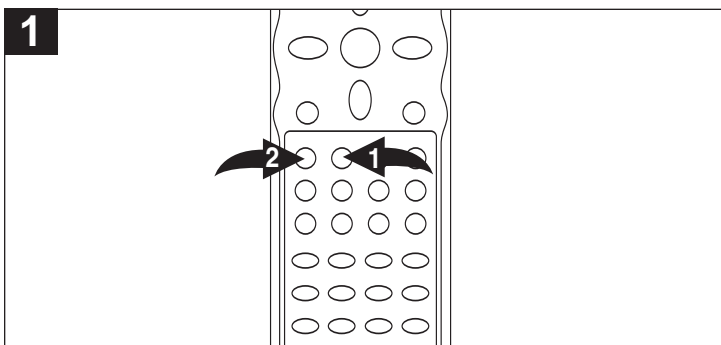

During playback, simply press the NEXT ▶▶ ❶ or PREVIOUS ◀◀ ❷ button to select a track to be played.

CD/VCD BASIC OPERATION (CONTINUED)

FORWARD ►► / REVERSE ◀◀

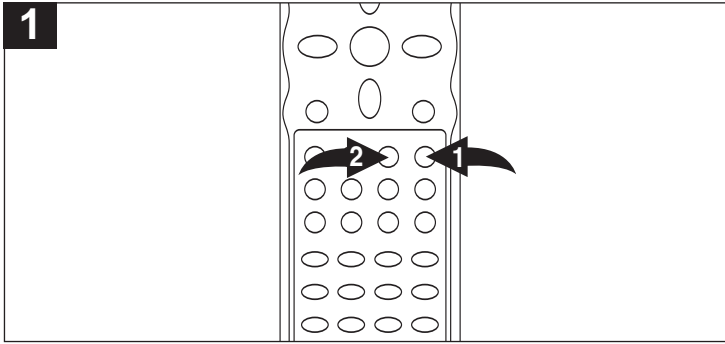

Each press of the Forward ►► ❶ or Reverse ◀◀ ❷ Search button will increase the search as follows:

1st press:	x 2
2nd press:	x 4
3rd press:	x 8
4th press:	x 16
5th press:	Resume Normal Playback

REPEAT ONE/ALL PLAY

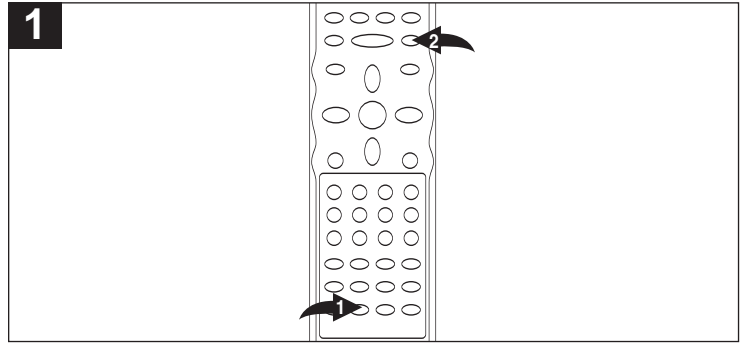

To Repeat play a track, simply select the track as described on the previous page, then press the REPEAT button ❶ once; "◁ TRACK" will appear on the TV screen and the unit will repeat the selected track continuously until the STOP (■) button ❷ is pressed.

To Repeat play all tracks on a CD, press the REPEAT button ❶ a second time; "◁ ALL" will appear on the TV screen and the unit will repeat the CD continuously until the STOP (■) button ❷ is pressed.

To cancel Repeat play, press the REPEAT button ❶; "OFF" will appear on the TV screen.

IMPORTANT NOTE ON VCD REPEAT PLAYBACK:
PBC must be Off to use Repeat playback with VCDs.

REPEAT A-B PLAY (VCD ONLY)

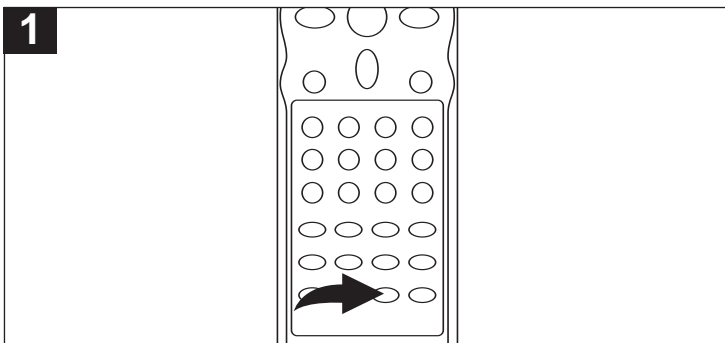

While playing back a VCD, this unit can repeatedly play back a specific section.

While in the Playback mode, press the Repeat A-B button to define where you want the section to start. Press the Repeat A-B button again to define where you would like the section to end, the unit will then play the selected area continuously.

Press the Repeat A-B button again to cancel Repeat A-B mode.

PBC (VCD ONLY)

When playing a VCD with PBC function, you can enjoy simple interactive software on your TV.

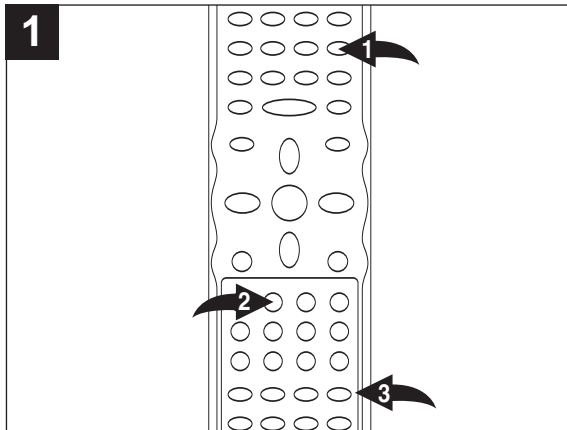

The PBC Function will activate automatically if the VCD has this function. To turn off the PBC, press the PBC button ❶ once.

Press the NEXT ► button ❷ to go to the Track Selection Menu. Some VCDs may not have this menu.

Press the Number buttons ❸ to select the desired track to play.

Follow the instructions supplied with the disc as the operating procedure may differ according to the VCD.

PICTURE CD BASIC OPERATION

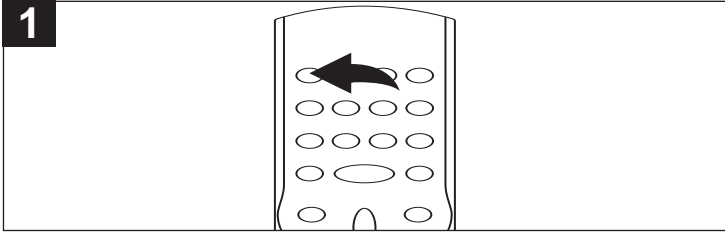

Press the POWER button to turn on the unit.

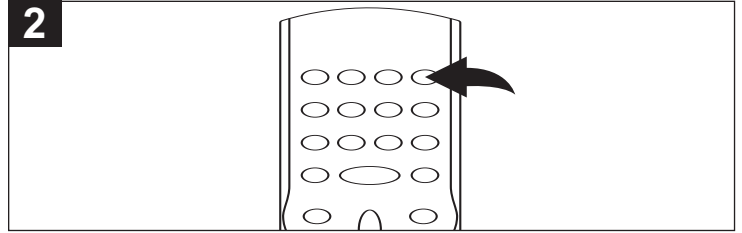

While in the DVD mode (DVD button pressed first), press the OPEN/CLOSE button to open the disc tray, "OPEN" will appear on the screen. Insert a picture disc with the label side facing up on the disc tray.

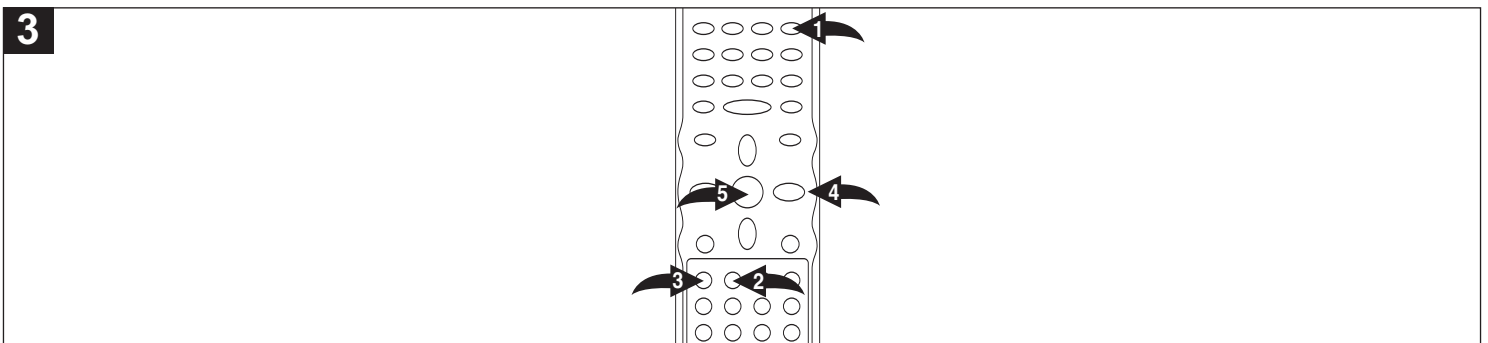

Press the OPEN/CLOSE button ❶ to close the disc tray. "LOADING" will appear on the TV screen. After loading, playback will start automatically. Press the NEXT (⏭) ❷ or PREVIOUS (⏮) button ❸ to skip through the pictures. The unit will playback all the pictures on the disc then the menu will appear on the TV screen. Press the Navigation (▲, ▼) buttons ❹ to select the desired picture and press the OK button ❺ to playback the desired picture again. If the screen saver option is set to on, the screen saver will turn on in about one minute when the menu appears on the TV screen.

TO STOP PICTURE CD FUNCTION: To stop playback of the picture CD, press the STOP (■) button.

TROUBLESHOOTING GUIDE (DVD SIDE)

Check the following before requesting service:

SYMPTOM	POSSIBLE CAUSE	POSSIBLE SOLUTION
GENERAL		
No power.	AC cord unplugged.	Plug in the AC cord to an AC outlet.
Power on, but unit not functioning properly.	Condensation has formed.	Unplug the unit and wait about one to two hours to allow the player to dry.
	Wrong type of disc inserted.	This unit cannot play discs, other than DVD, VCD, MP3 or standard/picture CDs.
	Unit needs to be reset.	Press the POWER button to turn the unit off, then unplug the power cord. Wait one minute and then plug the unit back in.
	The disc is dirty or inserted incorrectly.	Clean disc and insert label side-up.
	Some features and functions are not available on all discs.	This is normal; try another function.
No picture.	The equipment is not connected properly.	Connect the equipment according to the instructions in this manual.
	The INPUT of the TV is not set to receive the DVD signal output.	Select the appropriate video input mode, usually VIDEO or AV.
	The video cables are not securely connected.	Connect the video cables securely.
	Progressive Scan switch is set to ON.	Set switch to OFF, see bottom of next page.
	The connected TV's power is off.	Turn the TV on.
No sound.	The equipment is not connected properly.	Connect the equipment according to the instructions in this manual.
	The equipment connected with the audio cable is not set to receive the DVD signal input.	Select the appropriate audio input mode.
	The audio cables are not securely connected.	Connect the audio cables securely.
	The connected receiver's power is off.	Turn the audio receiver on.
Playback picture rolls.	Unit needs to be reset to NTSC.	Turn unit off and then back on to auto set it.
The playback picture is poor.	The disc is dirty.	Clean the disc.
The Search feature is not working.	Some discs have sections that do not allow searching.	This is normal on some discs.
The picture is not fitting properly.	Wrong menu option is selected in the SETUP MENU.	Select the correct TV type (PS, LB, WIDE) which matches the TV you are using.
The remote control is not working.	The batteries are weak or dead.	Install fresh batteries.
	The batteries are not installed properly.	Install batteries according to the diagram.
	The remote is not aimed at the sensor.	Aim the remote at the sensor.
	Distance is too far or there is too much light in the room.	Operate within 20ft, or reduce the light in the room.
	There is an obstacle in the path of the beam.	Move the obstacle.
The PREFERENCES menu cannot be accessed (it is dimmed) in the SETUP MENU.	There is a disc in the disc tray.	Remove the disc from the disc tray, as there cannot be any disc inserted when setting the preferences.

TROUBLESHOOTING GUIDE (DVD SIDE) (CONTINUED)

SYMPTOM	POSSIBLE CAUSE	POSSIBLE SOLUTION
DVD		
The unit does not start playback.	DVD not inserted, or inserted upside-down.	Insert DVD correctly.
	A non-playback disc is inserted.	Make sure to insert a DVD; "DVD VIDEO" will appear in the display.
	The disc is not placed in the guide.	Place the disc on the disc tray correctly inside the guide.
	The disc is dirty.	Clean the disc.
Some functions do not operate as stated.	Some features and functions are not available on all discs.	This is normal; try another function.
Selected language is not being shown in the subtitles, or spoken.	If the audio or subtitle language does not appear on the disc, then the initial setting will not be seen/heard.	This is normal; try another disc.
Subtitles are not working properly.	Subtitles appear only when the discs contain them.	This is normal; try another disc.
	Subtitles not turned on.	Turn the subtitles on.
Angle cannot be changed.	Angles may not be recorded on the disc (see disc jacket/case), or they may only be recorded on certain scenes.	Try another disc, or wait for a scene which allows a different camera angle.
VCD (VIDEO CD)		
No menu playback.	The VCD inserted does not have the playback control.	Try another VCD.
PROGRESSIVE SCAN		
No picture.	If you connect a TV that is not compatible with a progressive scan signal and set the PROGRESSIVE SCAN switch to ON, you will not be able to see any picture.	Slide the PROGRESSIVE SCAN switch to the OFF position if your set is not compatible, the picture should reappear.

TROUBLESHOOTING GUIDE (VCR SIDE)

Check the following before requesting service.

SYMPTOM	POSSIBLE CAUSE	POSSIBLE SOLUTION
POWER		
No power.	The AC power cord is not connected.	Connect the AC power cord to the AC outlet.
Although the power is on, the VCR does not operate.	Cassette is not inserted.	Insert a video cassette.
	Moisture has condensed on the heads.	Unplug and allow an hour or two to dry out.
RECORDING		
TV recording does not work.	The video cassette's erase prevention tab is broken off.	Place a piece of vinyl tape over the hole.
One-Touch recording does not work.	The video cassette's erase prevention tab is broken off.	Place a piece of vinyl tape over the hole.
Timer recording does not work.	The time is not set correctly.	Reset the present time.
	The unit was not turned off or changed to DVD mode after programming.	Turn the unit off or change to DVD mode after programming; the Timer indicator will appear in the display.
	The unit was not turned off after programming.	Turn the unit off after programming.
INDEX mark was not registered.	INDEX mark was recorded at the beginning of the video cassette.	Let the tape run for a couple of seconds before you begin recording.
The tape ejects after pressing the REC button.	The video cassette's erase prevention tab is broken off.	Place a piece of vinyl tape over the hole.
PLAYBACK		
Noise bars appear on the screen.	Video heads are dirty.	Have the video heads cleaned.
	The tape is worn or damaged.	Try another tape.
Cannot locate INDEX marks.	Tape is worn or damaged.	Try another tape.
Counter does not count up or down.	The tape is blank.	Insert a prerecorded tape.

**FOR ADDITIONAL SET-UP OR OPERATING ASSISTANCE, PLEASE VISIT OUR WEBSITE AT
WWW.MEMOREXELECTRONICS.COM OR CONTACT CUSTOMER SERVICE AT
(954) 660-7100**

PLEASE KEEP ALL PACKAGING MATERIAL FOR AT LEAST 90 DAYS IN CASE YOU NEED TO RETURN THIS PRODUCT TO YOUR PLACE OF PURCHASE OR MEMOREX.

FOR PARTS AND ACCESSORIES, CONTACT FOX INTERNATIONAL AT 1-800-321-6993.

CARE AND MAINTENANCE

Caring for Discs

- Treat the disc carefully. Handle the disc only by its edges. Never allow your fingers to come in contact with the shiny, unprinted side of the disc.

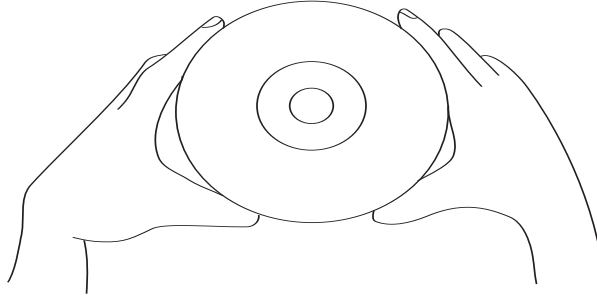

- Do not attach adhesive tape, stickers, etc. to the disc label.
- Clean the disc periodically with a soft, lint-free, dry cloth. Never use detergents or abrasive cleaners to clean the disc. If necessary, use a CD cleaning kit.
- If a disc skips or gets stuck on a section of the disc, it is probably dirty or damaged (scratched).
- When cleaning the disc, wipe in straight lines from the center of the disc to the outer edge of the disc. Never wipe in circular motions.

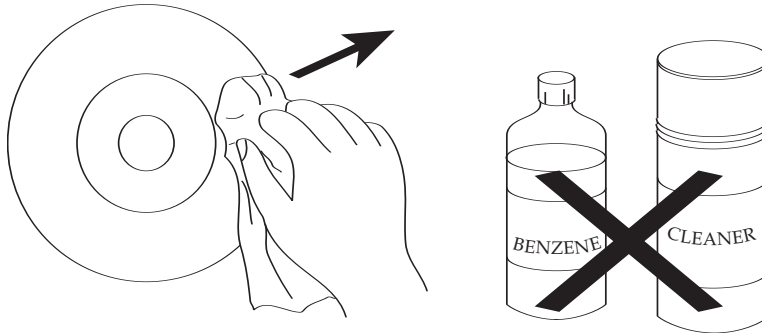

- Discs should be stored in their cases after each use to avoid damage.
- Do not expose discs to direct sunlight, high humidity, high temperatures or dust, etc. Prolonged exposure or extreme temperatures can warp the disc.
- Do not stick or write anything on either side of the disc. Sharp writing instruments, or the ink, may damage the surface.

Cleaning the Unit

- To prevent fire or shock hazard, disconnect your unit from the AC power source when cleaning.
- The finish on your unit may be cleaned with a dust cloth and cared for as other furniture. Use caution when cleaning and wiping the plastic parts.
- Mild soap and a damp cloth may be used on the front panel.

VIDEO HEAD CLOGGING/CLEANING

VIDEO HEAD CLOGGING

The video heads are the means by which the VCR reads pictures from the tape during playback. In the unlikely event that the heads become dirty enough to be clogged, no picture will be played back. This can easily be determined if, during playback of a known good tape, there is good sound, but no picture (picture is extremely snowy). If this is the case, have the video cassette recorder checked by qualified service personnel.



Good Picture



Snowy Picture

VIDEO HEAD CLEANING

This VCR has a built-in head cleaning system that cleans the heads whenever a tape is inserted or ejected. However, cleaning still may be necessary when the playback picture becomes unclear. The heads can get dirty when playing poor quality or damaged tapes. If the heads require cleaning, use a equivalent high quality chemical non-abrasive (wet) head cleaning tape or have them cleaned professionally. If playing a head cleaning tape in the VCR once does not improve the picture, play it several times before requesting service.

- DO NOT ATTEMPT TO CLEAN THE VIDEO HEADS OR SERVICE THE UNIT BY REMOVING THE TOP COVER.
- Video heads may eventually wear out and should be replaced when they fail to produce clear pictures.
- To help prevent video head clogging, use only good quality Video Cassette Tapes. Disregard worn out tapes.

SPECIFICATIONS

Power Requirements	AC120V, 60Hz
Power Consumption.....	25W
Weight.....	10 Lbs
Dimensions	17 (W) x 10.5 (D) x 4 (H) inches
Weight and dimensions are approximate.	
Signal System	NTSC/PAL
Operating Temperature	41° to 95° F
Operating Humidity Range	5% to 90% (no condensation)

Discs Played:

DVD-VIDEO Disc

- 12cm single-sided, single layer
- 12cm single-sided, dual layer
- 12cm double-sided, single layer
- 8cm single-sided, single layer
- 8cm single-sided, dual layer
- 8cm double-sided, single layer

COMPACT DISC (VIDEO CD)

- 12cm disc
- 8cm disc

Video Output Level	1Vp-p
Audio Output Level.....	2 Vrms (1 KHz, 0dB)

Audio Signal Output Characteristics:

Frequency Responses:

DVD (Linear Audio)	20Hz-20KHz (48KHz/96KHz sampling)
CD Audio	20Hz-20KHz
S/N Ratio.....	70dB
Wow and Flutter.....	Below Measurable Level

Pickup:

- Wavelength.....655nm
- Laser Power

VCR

Video System	4 rotary heads helical scanning system
Video Signal.....	NTSC color
Cassette Tape	Video Cassette Tape
Audio Track.....	1 track
Tape Speed.....	SP/SLP
F.F/Rewinding Time	Approx. 2 minutes (T-120 tape)

Specifications are subject to change without notice.

Memcorp, Inc.
Weston, FL
Printed in Hong Kong

Visit our website at www.memorexelectronics.com

Free Manuals Download Website

<http://myh66.com>

<http://usermanuals.us>

<http://www.somanuals.com>

<http://www.4manuals.cc>

<http://www.manual-lib.com>

<http://www.404manual.com>

<http://www.luxmanual.com>

<http://aubethermostatmanual.com>

Golf course search by state

<http://golfingnear.com>

Email search by domain

<http://emailbydomain.com>

Auto manuals search

<http://auto.somanuals.com>

TV manuals search

<http://tv.somanuals.com>