



Is it live or is it Memorex?<sup>TM</sup>

# MVDP1101

## User's Guide

10" TFT DISPLAY PORTABLE DVD PLAYER  
WITH REMOTE CONTROL

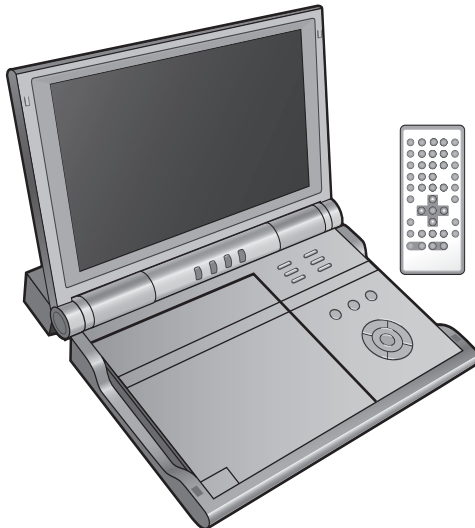

**Before operating this product,  
please read these instructions completely.**

# TABLE OF CONTENTS

<b>Contents</b> .....	1	• Chapter/Time Search.....	30
<b>Important Safety Instructions</b> .....	2	• Repeat Playback .....	31
<b>Precautions</b> .....	5	• Repeat A-B Playback.....	31
<b>Power Sources</b> .....	7	• Audio Menu .....	32
<b>Location of Controls</b> .....	9	• Subtitle Menu.....	32
• Main Unit .....	9	• DVD Menu.....	32
• Side .....	10	• Title Menu .....	32
• Remote .....	10	• Zoom In .....	33
<b>Remote Control</b> .....	11	• Angle .....	33
• Battery Installation .....	11	• Resume .....	33
• Effective Distance of the Remote Control Transmitter.....	11	• Random .....	33
<b>Connection</b> .....	12	• Programmed Playback .....	34
• Connecting the Unit to a TV Using the A/V Cable.....	12	<b>CD Operation</b> .....	35
• Connecting the Unit to a TV Using the Component Cable .....	13	• Playback of a CD.....	35
• Progressive (Y, PB, PR) Video Out .....	14	• Pause.....	35
• 525 Line Digital Progressive-Scan Component Video Output .....	14	• Random Playback .....	36
• Connecting the Unit to a Home Theater System (Audio Jack) .....	15	• Skip .....	36
• Connecting the Unit to a Home Theater System (Coaxial Jack) .....	16	• Search .....	36
<b>About Discs</b> .....	17	• Selecting Tracks Using the Number Buttons.....	37
<b>Setup Menu</b> .....	19	• Repeat Playback .....	37
• General Setup Menu .....	20	• Repeat A-B Playback.....	37
• Audio Setup Menu .....	21	<b>Picture CD Operation</b> .....	38
• Dolby Setup Menu .....	22	<b>Troubleshooting Guide</b> .....	39
• Video Setup Menu .....	23	<b>Care and Maintenance</b> .....	41
• Preference Setup Menu.....	24	<b>Specifications</b> .....	42
<b>Basic Operation</b> .....	25		
• Mute .....	25		
• P/N (PAL/NTSC) Button .....	25		
• Headphone Jack(s) .....	25		
• Mode Button .....	25		
• Screen Menu Button .....	25		
• Display Button .....	26		
• I/P (Interlace/Progressive Scan) Button .....	26		
<b>DVD Operation</b> .....	27		
• Playback of a DVD .....	27		
• Skip .....	29		
• Search .....	29		
• Slow Motion.....	29		
• Pause/Step .....	29		
• Title/Chapter Search .....	30		
• Title/Time Search.....	30		

# IMPORTANT SAFETY INSTRUCTIONS

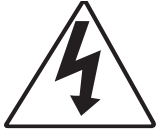

## CAUTION

**RISK OF ELECTRIC SHOCK  
DO NOT OPEN**



CAUTION: TO REDUCE THE RISK OF ELECTRIC SHOCK, DO NOT REMOVE COVER (OR BACK). NO USER-SERVICEABLE PARTS INSIDE. REFER SERVICING TO QUALIFIED SERVICE PERSONNEL.



### **DANGEROUS VOLTAGE:**

The lightning flash with arrowhead symbol within an equilateral triangle is intended to alert the user to the presence of uninsulated dangerous voltage within the product's enclosure that may be of sufficient magnitude to constitute a risk of electric shock to persons.



### **ATTENTION:**

The exclamation point within an equilateral triangle is intended to alert the user to the presence of important operating and maintenance (servicing) instructions in the literature accompanying the appliance.

### **CAUTION:**

THIS DIGITAL VIDEO DISC PLAYER EMPLOYS A LASER SYSTEM.

TO ENSURE PROPER USE OF THIS PRODUCT, PLEASE READ THIS OWNER'S MANUAL CAREFULLY AND RETAIN FOR FUTURE REFERENCE. SHOULD THE UNIT REQUIRE MAINTENANCE, CONTACT AN AUTHORIZED SERVICE LOCATION-SEE SERVICE PROCEDURE.

USE OF CONTROLS, ADJUSTMENTS OR THE PERFORMANCE OF PROCEDURES OTHER THAN THOSE SPECIFIED HEREIN MAY RESULT IN HAZARDOUS RADIATION EXPOSURE.

TO PREVENT DIRECT EXPOSURE TO LASER BEAM, DO NOT TRY TO OPEN THE ENCLOSURE. VISIBLE LASER RADIATION MAY BE PRESENT WHEN THE ENCLOSURE IS OPENED. DO NOT STARE INTO BEAM.

### **WARNING:**

TO REDUCE THE RISK OF FIRE OR ELECTRIC SHOCK, DO NOT EXPOSE THIS PRODUCT TO RAIN OR MOISTURE.

### **WARNING:**

TO REDUCE THE RISK OF FIRE OR ELECTRIC SHOCK, AND ANNOYING INTERFERENCE, USE THE RECOMMENDED ACCESSORIES ONLY.

# IMPORTANT SAFETY INSTRUCTIONS

**SURGE PROTECTORS:**

It is recommended to use a surge protector for AC connection. Lightning and power surges ARE NOT covered under warranty for this product.

**LASER WARNING:**

This unit employs a laser. Only qualified service personnel should attempt to service this device due to possible eye injury.

**FCC NOTICE:**

This equipment has been tested and found to comply with the limits for a Class B digital device, pursuant to part 15 of the FCC Rules. These limits are designed to provide reasonable protection against harmful interference in a residential installation. This equipment generates, uses and can radiate radio frequency energy and, if not installed and used in accordance with the instructions, may cause harmful interference to radio communications.

However, there is no guarantee that interference will not occur in a particular installation. If this equipment does cause harmful interference to radio or television reception, which can be determined by turning the equipment off and on, the user is encouraged to try to correct the interference by one or more of the following measures:

- Reorient or relocate the receiving antenna.
- Increase the separation between the equipment and receiver.
- Connect the equipment into an outlet on a circuit different from that to which the receiver is connected.
- Consult the dealer or an experienced radio/TV technician for help.

Modifications not authorized by the manufacturer may void user's authority to operate this device.

**FCC CAUTION:**

To assure continued compliance, follow the attached installation instructions and use only shielded cables when connecting to other devices. Also, any changes or modifications not expressly approved by the party responsible for compliance could void the user's authority to operate the equipment.

**ATTENTION:**

POUR ÉVITER LES CHOC ÉLECTRIQUES, INTRODUIRE LA LAME LA PLUS LARGE DE LA FICHE DANS LA BORNE CORRESPONDANTE DE LA PRISES ET POUSSER JUSQU'AU FOND.

This Class B digital apparatus complies with Canadian ICES-003.

Cet appareil numérique de la classe B est conforme à la norme NMB-003 du Canada.

# IMPORTANT SAFETY INSTRUCTIONS

## Dear Customer:

Selecting fine audio equipment such as the unit you've just purchased is only the start of your musical enjoyment. Now it's time to consider how you can maximize the fun and excitement your equipment offers. This manufacturer and the Electronic Industries Association's Consumer Electronics Group want you to get the most out of your equipment by playing it at a safe level. One that lets the sound come through loud and clear without annoying blaring or distortion and, most importantly, without affecting your sensitive hearing. Sound can be deceiving. Over time your hearing "comfort level" adapts to higher volumes of sound. So what sounds "normal" can actually be loud and harmful to your hearing. Guard against this by setting your equipment at a safe level BEFORE your hearing adapts.

## To establish a safe level:

- Start your volume control at a low setting.
- Slowly increase the sound until you can hear it comfortably and clearly, and without distortion.

## Once you have established a comfortable sound level:

- Set the dial and leave it there.

Taking a minute to do this now will help to prevent hearing damage or loss in the future. After all, we want you listening for a lifetime.

## We Want You Listening For A Lifetime

Used wisely, your new sound equipment will provide a lifetime of fun and enjoyment. Since hearing damage from loud noise is often undetectable until it is too late, this manufacturer and the Electronic Industries Association's Consumer Electronics Group recommend you avoid prolonged exposure to excessive noise. This list of sound levels is included for your protection.

## Decibel

<u>Level</u>	<u>Example</u>
30	Quiet library, soft whispers
40	Living room, refrigerator, bedroom away from traffic
50	Light traffic, normal conversation, quiet office
60	Air conditioner at 20 feet, sewing machine
70	Vacuum cleaner, hair dryer, noisy restaurant
80	Average city traffic, garbage disposals, alarm clock at two feet

## THE FOLLOWING NOISES CAN BE DANGEROUS UNDER CONSTANT EXPOSURE:

90	Subway, motorcycle, truck traffic, lawn mower
100	Garbage truck, chain saw, pneumatic drill
120	Rock band concert in front of speakers, thunderclap
140	Gunshot blast, jet engine
180	Rocket launching pad

Information courtesy of the Deafness Research Foundation.



# PRECAUTIONS

## NOTES ON HANDLING:

- When shipping the DVD player, always use the original shipping carton and packing materials. For maximum protection, repack the unit as it was originally packed at the factory.
- Do not use volatile liquids, such as insect spray, near the DVD player. Do not leave rubber or plastic products in contact with the DVD player for a long time. They will leave marks on the finish.
- The top and rear panels of the DVD player may become warm after a long period of use. This is normal and not a malfunction.
- When the DVD player is not in use, be sure to remove the disc and turn off the power.
- If you do not use the DVD player for a long period, the unit may not function properly in the future. Turn on and use the DVD player occasionally.

## NOTES ON LOCATING THE DVD PLAYER:

- When you place this DVD player near a TV, radio or VCR, the playback picture may become poor and the sound may be distorted. In this case, move the DVD player away from the TV, radio or VCR.

## NOTES ON CLEANING:

### Use a soft, dry cloth for cleaning.

- For stubborn dirt, soak the cloth in a weak detergent solution, wring well and wipe. Use a dry cloth to wipe it dry. Do not use any type of solvent, such as thinner or benzene, as they may damage the surface of the DVD player.
- If you use a chemical-saturated cloth to clean the unit, follow that product's instructions.

**Warning:** Cleaning and adjustment of lenses and/or other components of playback mechanism should be performed by a qualified service technician.

## CAUTION:

To reduce the risk of injury, only charge with supplied rechargeable Battery Pack; other types of batteries may burst causing personal injury or damage.

## PRECAUTIONS (CONTINUED)

### **TO OBTAIN A CLEAR PICTURE:**

The DVD player is a high technology, precision device. If the optical pick-up lens and disc drive parts are dirty or worn down, the picture quality becomes poor. To obtain a clear picture, we recommend regular inspection and maintenance (cleaning or parts replacement) every 1,000 hours of use depending on the operating environment. For details, contact your nearest dealer.

### **NOTES ON MOISTURE CONDENSATION:**

**Moisture condensation damages the DVD player. Please read the following carefully.**

- Moisture condensation occurs, for example, when you pour a cold drink into a glass on a warm day. Drops of water form on the outside of the glass. In the same way, moisture may condense on the optical pick-up lens inside this unit, one of the most crucial internal parts of the DVD player.

**Moisture condensation occurs during the following cases:**

- When you bring the DVD player directly from a cold place to a warm place.
- When you use the DVD player in a room where you just turned on the heater, or a place where the cold wind from the air conditioner directly hits the unit.
- In summer, when you use the DVD player in a hot and humid place just after you moved the unit from an air conditioned room.
- When you use the DVD player in a humid place.

**Do not use the DVD player when moisture condensation may occur.**

- If you use the DVD player in such a situation, it may damage discs and internal parts. Remove the disc, insert the small end of the AC adapter into the DC IN jack on the side of the unit and insert the other end into a conveniently located AC outlet having 120 AC, 60 Hz, turn on the DVD player and leave it "ON" for two or three hours. After two or three hours, the DVD player will have warmed up and evaporated any moisture. Keep the DVD player connected to the wall outlet and moisture condensation will seldom occur.

# POWER SOURCES

## AC CONNECTION

Insert the small end of the AC adapter into the jack on the side of the unit. Insert the other end (with the 2 blades) into a conveniently located AC outlet having 120V AC, 60Hz. **DO NOT** insert into the DC IN CHARGE jack.

**AC ADAPTER SPECIFICATIONS:** DC 9V 

### NOTES:

- To disconnect the AC adapter, remove it from the DC IN jack on the side of the unit as well as from the AC outlet.
- Use the enclosed AC adapter for this product only.

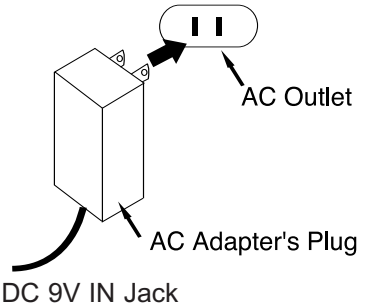

## BATTERY PACK INSERTION/REMOVAL

Follow the instructions below to insert or remove the Battery Pack.

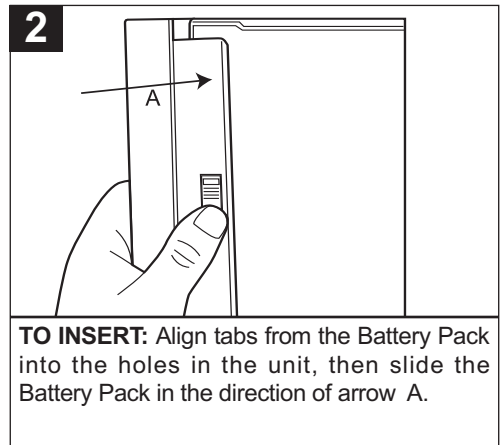
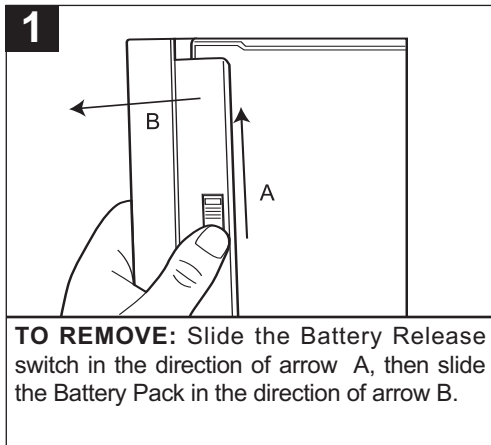



### CHARGING THE BATTERY PACK

“Low Battery” will appear on the screen when the battery is low and needs recharging. The battery can be charged while attached or not attached to the unit as follows:

#### WITH THE BATTERY ATTACHED TO THE UNIT:

With the Battery Pack attached, insert the small end of the AC adapter into the DC IN CHARGE jack on the side of the Battery Pack or the DC IN jack on the side of the unit. Insert the other end (with the 2 blades) into a conveniently-located AC outlet having 120V AC, 60Hz. The CHARGE indicator will light red as the battery is charging and green when charging has completed. Disconnect the AC adapter plugs when charging has finished.

#### WITH THE BATTERY NOT ATTACHED TO THE UNIT:

You can also charge the Battery Pack when it is not attached to the unit by inserting the small end of the AC adapter into the DC IN CHARGE jack on the side of the Battery Pack. Insert the other end (with the 2 blades) into a conveniently-located AC outlet having 120V AC, 60Hz. The CHARGE indicator will light red as the battery is charging and green when charging has completed. Disconnect the AC adapter plugs when charging has finished.

#### NOTE:

- Fully charge the Battery Pack for 12 hours before using it for the first time. After the initial charge, it should take approximately six to seven hours to charge.
- A fully-charged Battery Pack can operate for about 2.5 hours.

# LOCATION OF CONTROLS

## MAIN UNIT

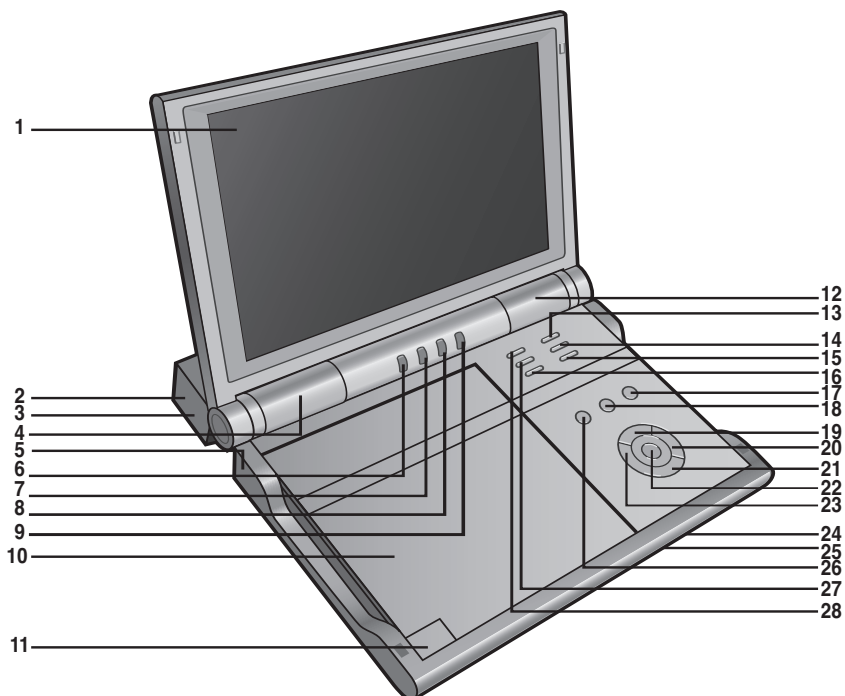

- |   |  |
|---|--|
| 1. Display  | 14. REPEAT Button                      |
| 2. DC IN CHARGE Jack 9V $\ominus \oplus$ (Side of the Rechargeable Battery) | 15. MENU Button                        |
| 3. CHARGE Indicator (Side of the Rechargeable Battery)                      | 16. SETUP Button                       |
| 4. Left Speaker   | 17. Pause (  ) Button                  |
| 5. DC IN Jack 9V $\ominus \oplus$ (Side of the Main Unit)                   | 18. Stop (■) Button                    |
| 6. SCREEN MENU Button   | 19. Navigation (▲)/Skip ⏮ Button       |
| 7. - Button (for Screen Menu Adjustment)                                    | 20. Navigation (▶)/Search ▶▶▶ Button   |
| 8. + Button (for Screen Menu Adjustment)                                    | 21. Navigation (▼)/Skip ⏭ Button       |
| 9. MODE Button  | 22. ENTER/PLAY (▶) Button              |
| 10. Disc Compartment  | 23. Navigation (◀)/Search ◀◀◀ Button   |
| 11. OPEN Button   | 24. Power Indicator                    |
| 12. Right Speaker   | 25. Remote Sensor                      |
| 13. ZOOM Button   | 26. POWER Button                       |
|   | 27. DISPLAY Button                     |
|   | 28. I/P (Interlace/Progressive) Button |

# LOCATION OF CONTROLS (CONTINUED)

## SIDE

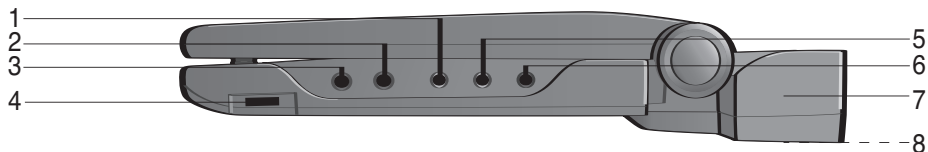

- |   |  |
|---|--|
| <ol style="list-style-type: none"> <li>1. AUDIO OUT Jack</li> <li>2. PHONE (Headphones) 2 Jack</li> <li>3. PHONE (Headphones) 1 Jack</li> <li>4. VOLUME Control</li> <li>5. VIDEO/COAXIAL OUT Jack</li> </ol> | <ol style="list-style-type: none"> <li>6. COMPONENT OUT (Y/Pb/Pr) Jack</li> <li>7. Battery Pack</li> <li>8. Battery Release Switch<br/>(Bottom of the Battery Pack)</li> </ol> |
|---|--|

## REMOTE

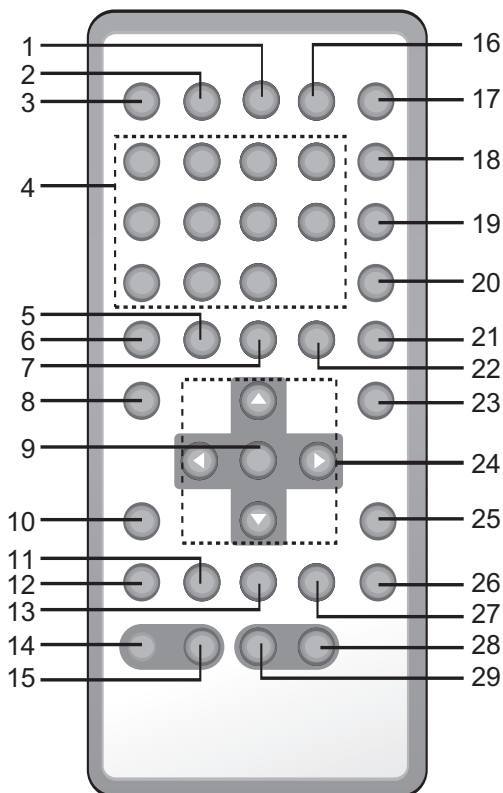

1. RETURN Button
2. MENU Button
3. POWER Button
4. 0-9/10+ Number Buttons
5. PROGRAM Button
6. GOTO Button
7. TITLE Button
8. AUDIO Button
9. PLAY/ENTER Button
10. SETUP Button
11. STEP Button
12. SLOW Button
13. PAUSE Button
14. Skip (⏮) Button
15. Skip (⏭) Button
16. DISPLAY Button
17. MUTE Button
18. REPEAT (1-All) Button
19. REPEAT A-B Button
20. P/N (PAL/NTSC) Button
21. ANGLE Button
22. SUB-T Button
23. ZOOM Button
24. Navigation (◀, ▶, ▲, ▼) Buttons
25. RESUME Button
26. SHUFFLE Button
27. Stop (■) Button
28. Search ▶▶ Button
29. Search ◀◀ Button

# REMOTE CONTROL

## BATTERY INSTALLATION

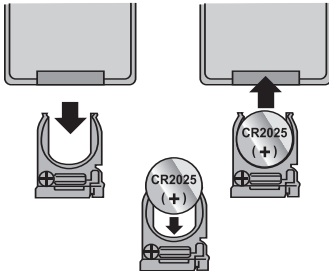

1. Remove the Battery Compartment by pressing in on the tab and then sliding the compartment out.
2. Install a CR2025 battery, paying attention to the polarity diagram in the battery compartment (positive side up).
3. Replace the Battery Compartment.

### BATTERY PRECAUTIONS

Follow these precautions when using a battery in this device:

1. Use only the size and type of battery specified.
2. Be sure to follow the correct polarity when installing the battery as indicated next to the battery compartment. A reversed battery may cause damage to the device.
3. If the device is not to be used for a long period of time, remove the battery to prevent damage or injury from possible battery leakage.
4. Do not try to recharge a battery not intended to be recharged; it can overheat and rupture. (Follow battery manufacturer's directions.)

## EFFECTIVE DISTANCE OF THE REMOTE CONTROL TRANSMITTER

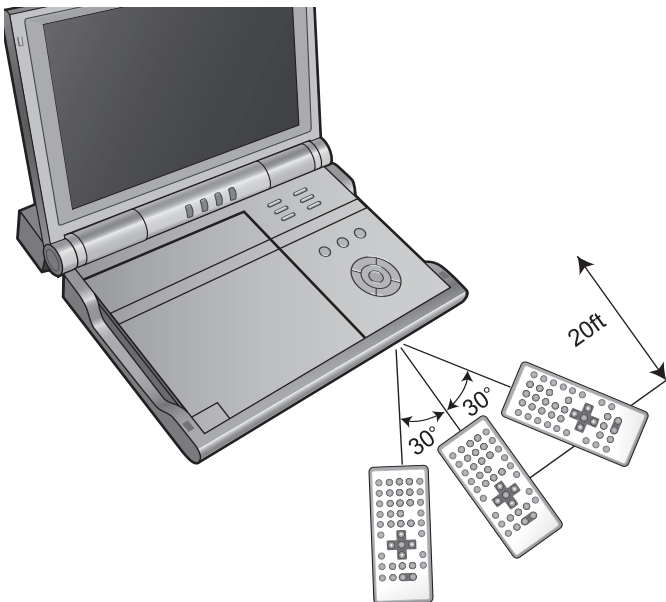

### NOTES:

- When there is an obstacle between the DVD and the transmitter, the transmitter may not operate.
- When direct sunlight, an incandescent lamp, fluorescent lamp or any other strong light shines on the Remote Sensor of the DVD, the remote operation may be unstable.

# CONNECTION

## CONNECTING THE UNIT TO A TV USING THE A/V CABLE (INCLUDED)

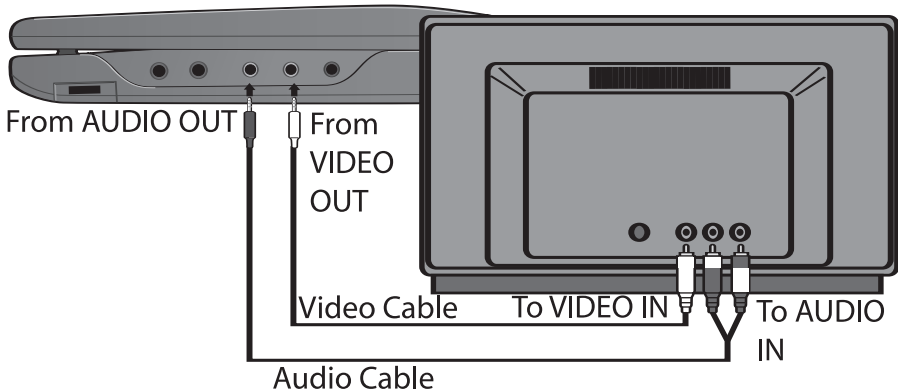

### NOTES FOR CONNECTING TO A TV:

- If your TV has Component (Y, Pb, Pr) inputs, connect the unit with them for best results.
- Set the TV's TV/VIDEO button or switch to the VIDEO setting.
- When connecting the unit, refer to the owner's manual of the TV, as well as this manual.
- When connecting the unit to the TV, make sure the power is off and both units are unplugged before making any connections.
- Connect the unit to your TV directly. If you connect the unit through a VCR, the playback picture will be distorted because DVD video discs are copy protected.

## CONNECTION (CONTINUED)

### CONNECTING THE UNIT TO A TV USING THE COMPONENT CABLE (INCLUDED)

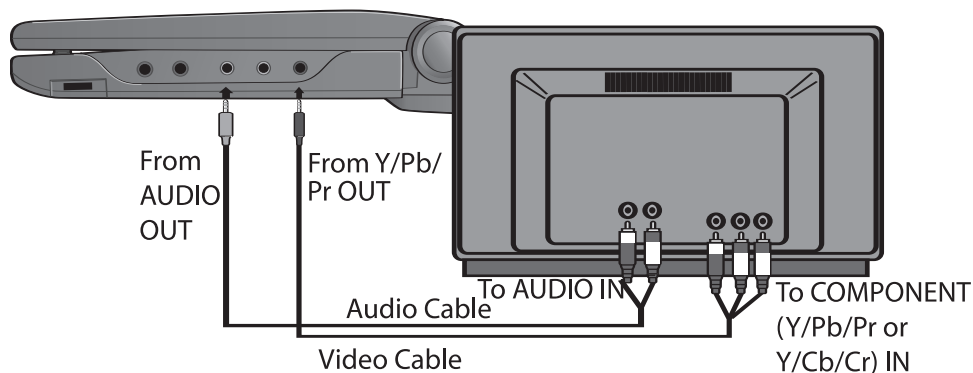

#### NOTES FOR CONNECTING TO A TV:

- TV must have Component (Y/PB/PR or Y/CB/CR) Input jacks.
- Set the TV's TV/VIDEO button or switch to the VIDEO setting.
- When connecting the unit, refer to the owner's manual of the TV, as well as this manual.
- When connecting the unit to the TV, make sure the power is off and both units are unplugged before making any connections.
- Connect the unit to your TV directly. If you connect the unit through a VCR, the playback picture will be distorted because DVD video discs are copy protected.
- When using the Component Output, you should set the Component Output to YUV in the VIDEO SETUP menu. Otherwise, the picture on the TV screen will be incorrectly or not colored. See page 23 to set the Component Output to YUV.
- When the Component Output is set to YUV, the main unit's screen display will turn off automatically. To observe the pictures on the unit's display screen again, turn off the unit and then turn the unit on again, the Component Output will reset to TV.

### PROGRESSIVE (Y, P<sub>B</sub>, P<sub>R</sub>) VIDEO OUT:

Use these jacks to connect to a TV with progressive video input jacks, press the I/P (Interlace/Progressive) button to select PROGRESSIVE SCAN. (**NOTE:** If you press the I/P button again, the TV mode setting will change back to INTERLACE. Also, the Component Output will change back to TV mode and you will be able to observe the pictures on the unit's display screen again.)

Progressive scan is a video scanning system that displays all lines in a frame in one pass, as opposed to the traditional system, interlaced scan. This connection provides optimum quality. To ensure maximum picture quality, use three video-grade cables for connections. Note that it is essential to match the color-coded connectors with a compatible TV.

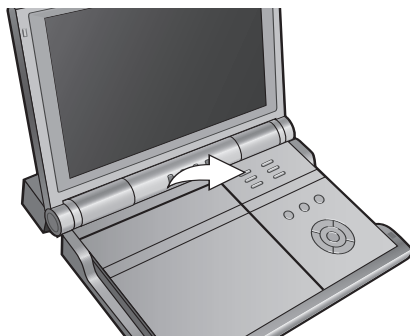

### 525 LINE DIGITAL PROGRESSIVE-SCAN COMPONENT VIDEO OUTPUT

Compared to standard interlaced video, progressive scan effectively doubles the amount of video information fed to your TV or monitor. The result is a stable, flicker-free image. (Check your TV/monitor for compatibility with this feature.)

For the very highest picture quality, try watching a movie on DVD-Video on a progressive-scan compatible TV.

#### NOTES:

- If you connect a TV that is not compatible with a progressive scan signal, press the I/P button to select Interlace, and set the Component Output to YUV in the VIDEO SETUP menu. See page 23 to set the Component Output to YUV.
- CONSUMERS SHOULD NOTE THAT NOT ALL HIGH DEFINITION TELEVISION SETS ARE FULLY COMPATIBLE WITH THIS PRODUCT AND MAY CAUSE ARTIFACTS TO BE DISPLAYED IN THE PICTURE. IN CASE OF 525 PROGRESSIVE SCAN PICTURE PROBLEMS, IT IS RECOMMENDED THAT THE USER NOT USE PROGRESSIVE SCAN.

# CONNECTION (CONTINUED)

## CONNECTING THE DVD TO A HOME THEATER SYSTEM (AUDIO JACK)

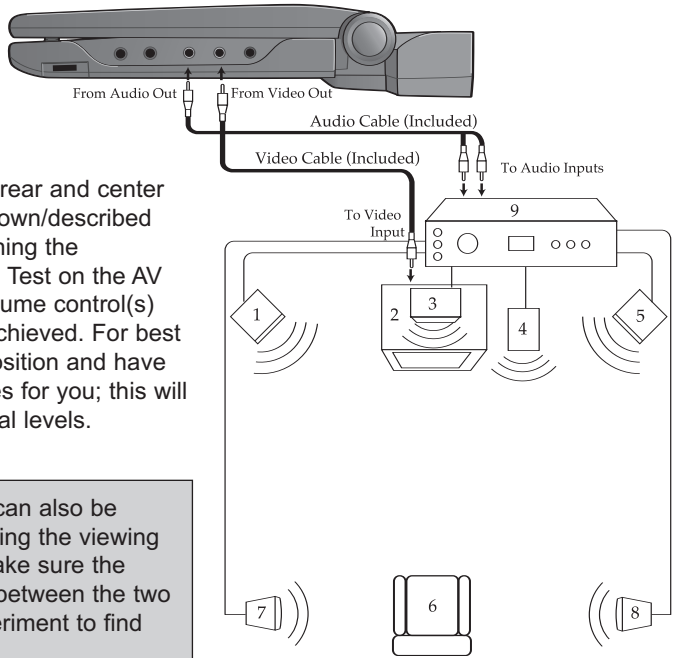

Place the subwoofer, front, rear and center speakers in locations as shown/described here. After correctly positioning the speakers, perform the Tone Test on the AV Amplifier and adjust the Volume control(s) until the desired sound is achieved. For best results, sit in the viewing position and have someone adjust the volumes for you; this will enable you to set the optimal levels.

**NOTE:** The rear speakers can also be located on the side wall facing the viewing position and each other. Make sure the viewing position is located between the two speakers in this case. Experiment to find optimal position.

1. **Front Left Speaker**
2. **Television**
3. **Center Speaker**—can be located on top or below the television.
4. **Sub-woofer**—can be located anywhere in the room.
5. **Front Right Speaker**
6. **Viewing/Listening Position**—The best listening position is obtained by positioning the chair, sofa, etc. in the middle of all the speakers.
7. **Rear Left Speaker**
8. **Rear Right Speaker**
9. **AV Amplifier w/Dolby Digital Decoder**

### NOTES FOR CONNECTING TO A TV:

- Set the TV's TV/VIDEO button or switch to the VIDEO setting.
- When connecting the unit, refer to the owner's manuals for the TV and the audio system, as well as this manual.
- When connecting, make sure the power is off and all units are unplugged before making any connections.
- Connect the unit to your TV directly. If you connect the unit through a VCR, the playback picture will be distorted because DVD video discs are copy protected.



# CONNECTION (CONTINUED)

## CONNECTING THE DVD TO A HOME THEATER SYSTEM (COAXIAL JACK)

Place the subwoofer, front, rear and center speakers in locations as shown/described here. After correctly positioning the speakers, perform the Tone Test on the AV Amplifier and adjust the Volume control(s) until the desired sound is achieved. For best results, sit in the viewing position and have someone adjust the volumes for you; this will enable you to set the optimal levels.

**NOTE:** The rear speakers can also be located on the side wall facing the viewing position and each other. Make sure the viewing position is located between the two speakers in this case. Experiment to find optimal position.

1. **Front Left Speaker**
2. **Television**
3. **Center Speaker**—can be located on top or below the television.
4. **Sub-woofer**—can be located anywhere in the room.
5. **Front Right Speaker**

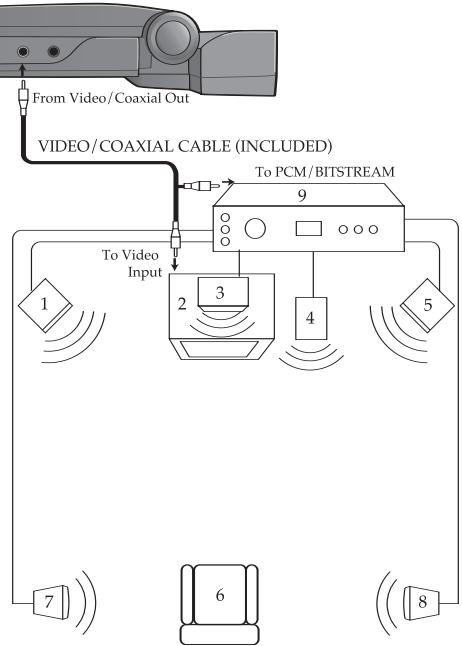

6. **Viewing/Listening Position**—The best listening position is obtained by positioning the chair, sofa, etc. in the middle of all the speakers.
7. **Rear Left Speaker**
8. **Rear Right Speaker**
9. **AV Amplifier w/Dolby Digital Decoder**

### NOTES FOR CONNECTING TO A TV:

- Set the TV's TV/VIDEO button or switch to the VIDEO setting.
- When connecting the unit, refer to the owner's manuals for the TV and the audio system, as well as this manual.
- When connecting, make sure the power is off and all units are unplugged before making any connections.
- Connect the unit to your TV directly. If you connect the unit through a VCR, the playback picture will be distorted because DVD video discs are copy protected.
- Set the SPDIF option to PCM, see page 20.

# ABOUT DISCS

The region number for this DVD Player is:  
See the following page for information regarding region numbers.



## PLAYABLE DISCS:

The following discs can be played back on this DVD player:



## DISC TYPES:

### DVD

Data on most DVDs is divided into sections called “titles” and then into subsections called “chapters”, each of which is given a title or chapter number. Some features of this DVD player will not operate with some DVD discs as they are preset. If a function you selected does not run as desired, refer to the manual accompanying the DVD disc.

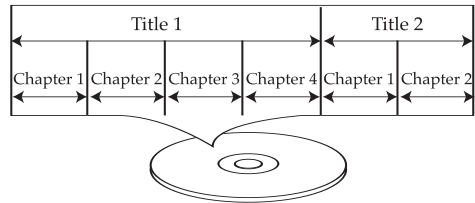

### AUDIO CD

Data on an audio CD is divided into sections called “tracks”, each of which is given a track number.

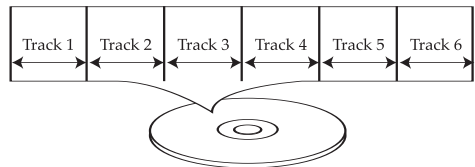

## IMPORTANT:

It is important that you read the manual that accompanies the DVD disc, as there are features that are on the DVD player that cannot be used with certain DVDs. There are also extra features on the DVD disc that are different for each DVD disc, so they are not explained in this owner’s manual.

## ABOUT DISCS (CONTINUED)

### **Notes on Copyright:**

It is forbidden by law to copy, broadcast, show, broadcast on cable, play in public and rent copyrighted material without permission. DVD video discs are copy protected, and any recordings made from these discs will be distorted. This product incorporates copyright protection technology that is protected by method claims of certain U.S. patents and other intellectual property rights owned by Macrovision Corporation and other rights owners. Use of this copyright protection technology must be authorized by Macrovision Corporation, and is intended for home and other limited viewing uses only, unless otherwise authorized by Macrovision Corporation. Reverse engineering or disassembly is prohibited.

### **Region Management Information:**

This DVD Player is designed and manufactured to respond to the Region Management Information that is recorded on a DVD disc. If the Region number described on the DVD disc does not correspond to the Region number of this DVD player, this DVD player cannot play that disc. You may not be able to play back some DVD video discs on this player if they were purchased from outside your geographic area or made for business purposes. When you try to play back an unauthorized disc, "Wrong Region" appears on the TV screen.

# SETUP MENU

The Setup menu lets you customize the DVD player by allowing you to select various language preferences, turn screen saver on and off, adjust what type of television screen you have and more.

Use the following instructions to navigate and change the options as described on the upcoming pages.

1. While in the Stop mode, press the SETUP button ❶ to enter the Setup menu.
2. Select one of the Setup icons at the top of the screen using the Navigation (◀, ▶) buttons ❷, then press the PLAY/ENTER button ❸ to select it.
3. Use the Navigation (▲, ▼) buttons ❷ to select one of the Setup options, then press the PLAY/ENTER button ❸ to select it.
4. Use the Navigation (▲, ▼) buttons ❷ to change the desired setting, then press the PLAY/ENTER button ❸ to make the change.
5. Exit by pressing the SETUP button ❶ again. To return to the previous menu, simply press the Navigation (◀) button ❷.

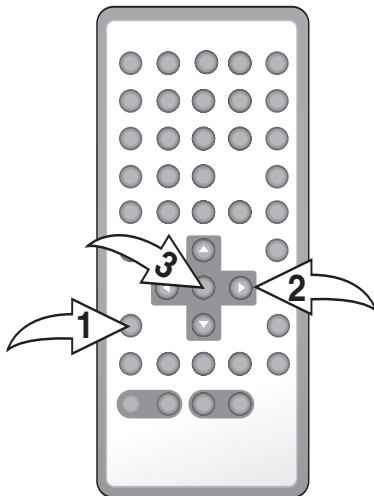

## NOTE:

- To turn on the unit, press the POWER button on the remote or press the POWER button on the main unit. To turn off the unit, press the POWER button on the remote or press and hold the POWER button on the main unit for two seconds.
- You can also press the RETURN button (on the remote) to exit the Setup menu.

# SETUP MENU (CONTINUED)

## GENERAL SETUP MENU:

Press the SETUP button to enter the menu, select GENERAL SETUP using the Navigation (◀,▶) buttons, then press the PLAY/ENTER button to select it. Select/change the Setup option as described on page 19.

## TV DISPLAY

1

General	Audio	Dolby	Video	Preference
-- General Setup Page --				
TV Display		Normal/PS		
Angle Mark		Normal/LB		
OSD Lang		Wide		
Spdif Output				
Captions				
Screen Saver				
Set TV Display Mode				

**NORMAL/PS:** Pan Scan. Select when the unit is connected to a conventional TV. Video material formatted in the Pan Scan style is played back in that style (the left and right edges are cut off).

**NORMAL/LB:** Letter Box. Select when the unit is connected to a normal TV. Wide-screen images are shown on the screen with a black band at the top or bottom.

**WIDE:** Select when the unit is connected to a wide-screen TV.

## ANGLE MARK

1

General	Audio	Dolby	Video	Preference
-- General Setup Page --				
TV Display				
Angle Mark		On		
OSD Lang		Off		
Spdif Output				
Captions				
Screen Saver				
Set Angle Mark				

Select ON to turn the anglemarks on and OFF to turn them off.

## OSD LANGUAGE

1

General	Audio	Dolby	Video	Preference
-- General Setup Page --				
TV Display				
Angle Mark				
OSD Lang		English		
Spdif Output		Spanish		
Captions		French		
Screen Saver				
Set Osd Language				

Select the desired language (ENGLISH, SPANISH, FRENCH) for the On-Screen display to display text. Note that the DVD must have the language included in order to display it.

## SPDIF OUTPUT

1

General	Audio	Dolby	Video	Preference
-- General Setup Page --				
TV Display				
Angle Mark				
OSD Lang				
Spdif Output		Off		
Captions		Raw		
Screen Saver		Pcm		
Setup Spdif				

**OFF:** An analog surround sound format is output through the side connectors for two channel audio out or 5.1 channel audio out.

**RAW or PCM:** These surround sound formats are output to a Dolby Digital decoder through the COAXIAL OUT jack.

# SETUP MENU (CONTINUED)

## CAPTIONS

1

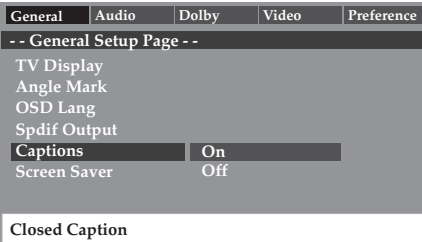

When this option is set to ON, Closed Captions will appear on the screen for the hearing impaired (if originally recorded on the DVD). When this option is OFF, the Closed Captions will not appear.

## SCREEN SAVER

1

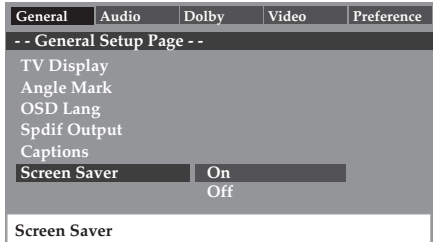

When this option is set to ON, the screen saver will come on when the unit stops or the image is paused for approximately 3.5 minutes.

When this option is OFF, the screen saver will not come on.

## AUDIO SETUP MENU:

Press the SETUP button to enter the menu, select AUDIO SETUP using the Navigation (◀, ▶) buttons, then press the PLAY/ENTER button to select it. Select/change the Setup option as described on page 19.

## DOWNMIX

1

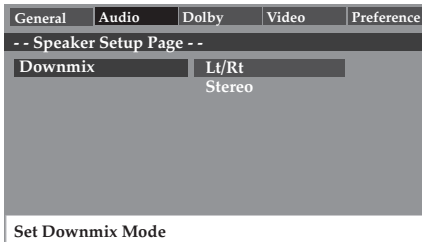

**LT/RT:** Select to hear the sound in theatrical downmix mode.

**STEREO:** Select to hear the sound in Stereo downmix mode.

# SETUP MENU (CONTINUED)

## DOLBY SETUP MENU:

Press the SETUP button to enter the menu, select DOLBY SETUP using the Navigation (◀, ▶) buttons, then press the PLAY/ENTER button to select it. Select/change the Setup option as described on page 19.

## DUAL MONO

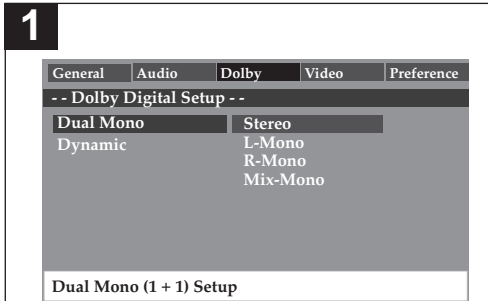

**STEREO:** Select this to set the Dolby Digital output to Stereo mode.

**L-MONO:** Select this to set the Dolby Digital output to left mono mode, meaning it will reproduce the left mono signal to the Left and Right channels.

**R-MONO:** Select this to set the Dolby Digital output to right mono mode, meaning it will reproduce the right mono signal to the Left and Right channels.

**MIX-MONO:** Select this to reproduce both channels mixed together.

## DYNAMIC

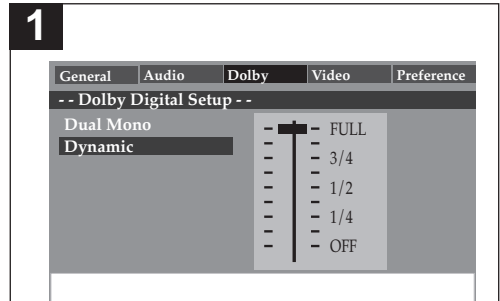

Use to slider to set the Dynamic Range. Set to OFF to turn Dynamic Range Off.

# SETUP MENU (CONTINUED)

## VIDEO SETUP MENU:

Press the SETUP button to enter the menu, select VIDEO SETUP using the Navigation (◀, ▶) buttons, then press the PLAY/ENTER button to select it. Select/change the Setup option as described on page 19.

## COMPONENT

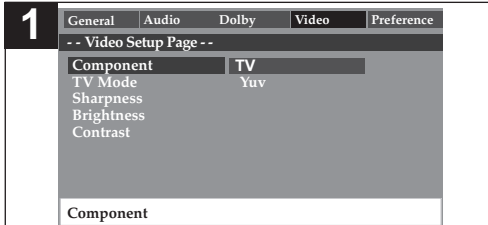

**TV:** Select to see the image on the built-in screen. (You can connect to an external TV to see the image using the Video cable.)

**YUV:** Select for Component (Y/Pb/Pr or Y/Cb/CR) Output. (You will need to connect to an external TV to see the image using the Component cable.)

**NOTE:** When you select YUV, the built-in screen will turn off automatically and you can see the image on the external TV using the Component cable. To see the image on the built-in screen again, turn off the unit and then turn on again, the Component Output will reset to TV.

### TV MODE

The TV Mode setting is for Component Output only. Once you have set Component Out to YUV, you can select the TV Mode setting:

**P-Scan:** Select for Progressive Scan Component Video Output.

**Interface:** If you connect a TV (using the Component Cable) that is not compatible with a progressive scan signal, select Interlace for the Component Video Output.

## SHARPNESS

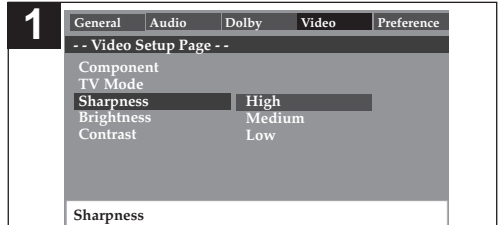

Adjust for the desired sharpness (HIGH, MEDIUM, LOW).

## BRIGHTNESS

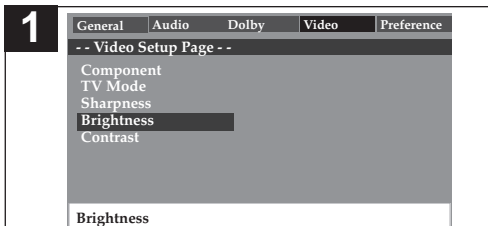

Press the PLAY/ENTER button to select BRIGHTNESS. Use the Navigation (◀, ▶) buttons to adjust (sharpen or soften) the picture, then press the PLAY/ENTER button again.

## CONTRAST

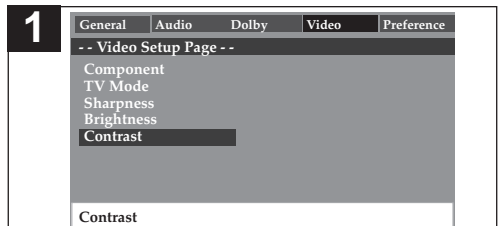

Press the PLAY/ENTER button to select CONTRAST. Use the Navigation (◀, ▶) buttons to adjust (increase or decrease) the contrast, then press the PLAY/ENTER button again.



# SETUP MENU (CONTINUED)

## PREFERENCE SETUP MENU:

Without a disc inserted, press the SETUP button to enter the menu, select PREFERENCE SETUP using the Navigation (◀,▶) buttons, then press the PLAY/ENTER button to select it. Select/change the Setup option as described on page 19.

## AUDIO

1

General	Audio	Dolby	Video	Preference
-- Preference Page --				
Audio	English			
Subtitle	German			
Disc Menu	French			
Default	Spanish			
	Chinese			
	Japanese			
	Korean			
	Russian			
Preferred Audio Language				

Select the language the DVD will be played back in (ENGLISH, GERMAN, FRENCH, SPANISH, CHINESE, JAPANESE, KOREAN, RUSSIAN, THAI or OTHERS). The DVD must be recorded in the selected language, otherwise the default language of the DVD will be played.

## SUBTITLE

1

General	Audio	Dolby	Video	Preference
-- Preference Page --				
Audio	English			
Subtitle	German			
Disc Menu	French			
Default	Spanish			
	Chinese			
	Japanese			
	Korean			
	Russian			
Preferred Subtitle Language				

Select the language the Subtitle (OSD) will be in (ENGLISH, GERMAN, FRENCH, SPANISH, CHINESE, JAPANESE, KOREAN, RUSSIAN, THAI, OFF or OTHERS). The DVD must be recorded in the selected language, otherwise the default language of the DVD will be shown. Select OFF to select without any language showing on the TV screen.

## DISC MENU

1

General	Audio	Dolby	Video	Preference
-- Preference Page --				
Audio	English			
Subtitle	German			
Disc Menu	French			
Default	Spanish			
	Chinese			
	Japanese			
	Korean			
	Russian			
Preferred Menu Language				

Select the language the DISC MENU will be in (ENGLISH, GERMAN, FRENCH, SPANISH, CHINESE, JAPANESE, KOREAN, RUSSIAN, THAI or OTHERS). The DVD's DISC MENU must be made in the selected language, otherwise the default language of the DVD will be shown.

## DEFAULT

1

General	Audio	Dolby	Video	Preference
-- Preference Page --				
Audio				
Subtitle				
Disc Menu				
Default	Reset			
Load Factory Setting				

Select this option to reset all the preferences to their original factory settings. This is useful to reset the NTSC System.

# BASIC OPERATION

## IMPORTANT:

When “⊘” appears while pressing a button, this means that the corresponding function cannot be performed either on the disc inserted, or in the selected mode.

### MUTE BUTTON

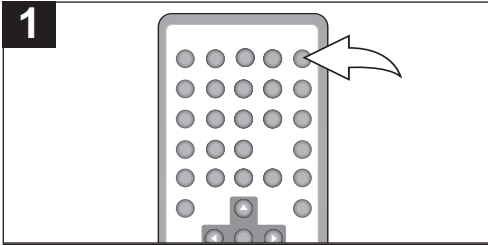

Press the MUTE button once to mute the sound; “MUTE” will appear on the screen. Press the MUTE button again to restore the sound; “MUTE OFF” will appear temporarily on the screen.

### P/N BUTTON

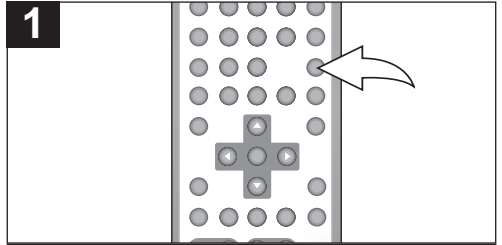

Press the P/N button to switch back and forth between NTSC and PAL. In the USA, the standard is NTSC.

### HEADPHONE JACK(S)

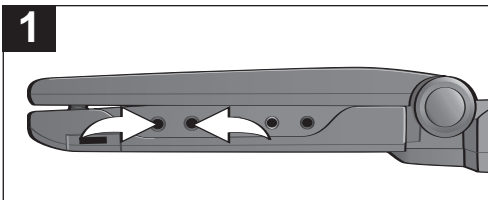

For private listening, plug headphones into one or both of the Headphone jacks. The speakers will be disconnected when headphone(s) are connected.

### MODE BUTTON

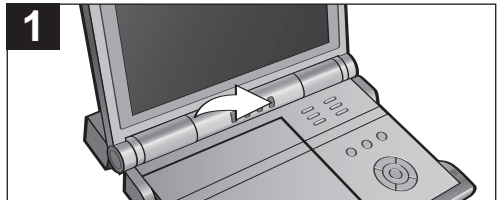

Press to cycle between standard 4:3 size (TV) and full screen (will fill the LCD screen).

**NOTE:** The MODE button is just for adjusting the built-in screen's display only, not for the Video Output.

### SCREEN MENU BUTTON

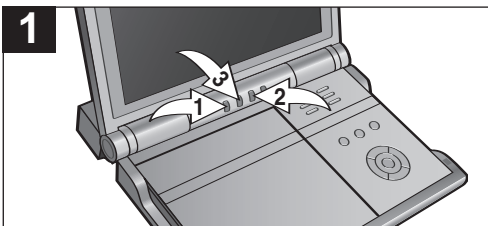

Press the SCREEN MENU button ❶ to access the on-screen picture display menu. Repeatedly press the SCREEN MENU button ❶ to cycle through Brightness and Color, then use the + ❷ and - ❸ buttons to adjust. When finished, press the SCREEN MENU button ❶ repeatedly until the on-screen picture display menu disappears to exit. **NOTE:** If the SCREEN MENU, + or - button is not pressed, after 20 seconds, the on-screen picture display menu will disappear from the screen.

# BASIC OPERATION (CONTINUED)

## DISPLAY BUTTON

1

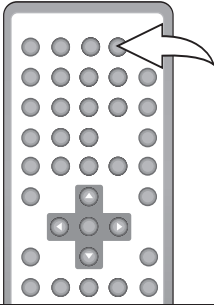

While playing a DVD, press the DISPLAY button to cycle as follows:

- 1st press: Title elapsed time
- 2nd press: Title remaining time
- 3rd press: Chapter elapsed time
- 4th press: Chapter remaining time
- 5th press: Display off

2

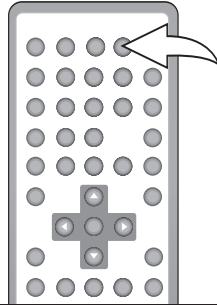

While playing a CD, press the DISPLAY button to cycle between single elapsed time and single remaining time.

## I/P (INTERLACE/PROGRESSIVE) BUTTON

1

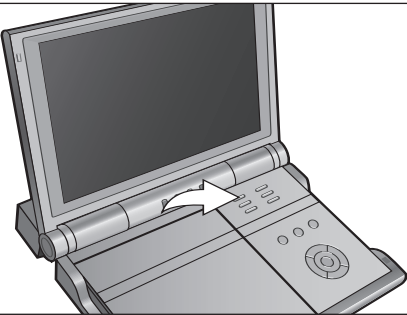

Press this button repeatedly to select between Interlace or P-Scan (Progressive Scan).

**Interlace:** To see the image through the built-in screen or through an external TV using the Video Cable.

**P-Scan (Progressive Scan):** The built-in screen will turn off and you can only see the image through an external TV (the TV must be compatible with Progressive Scan signal) using the Component Cable.

**NOTE:** For the Component Output connection, if your TV is not compatible with the progressive scan signal, set the Component setting to YUV and set the TV Mode setting to Interlace as described on page 23.

# DVD OPERATION

## IMPORTANT NOTES:

- After plugging in, the unit will be in the Power Off mode. Press the Power button on the main unit to turn on the unit. You can also press the POWER button on the remote to turn on the unit.
- “” will appear on the screen during operation if you try to access a function that is not available on the disc.
- Some discs may take a few seconds to load.
- If a disc is inserted incorrectly, dirty, damaged, or is not present at all, “NO DISC” will appear in the display.
- Always hold the disc without touching either of its surfaces. When inserting a disc, position it with the printed title side facing up, align it with the guides and place it in its proper position.
- It is important that you read the manual that accompanies the DVD disc as there are features that are on this DVD player that cannot be used with certain DVDs. There are also extra features that are different for each DVD disc, so they are not explained in this owner’s manual.
- If the unit is in the Stop mode, Pause mode or if there is no disc in the disc tray, the screen saver will appear on the screen after 3.5 minutes. After the screen saver appears on screen for 3.5 minutes, the unit will turn off automatically.

## PLAYBACK OF A DVD

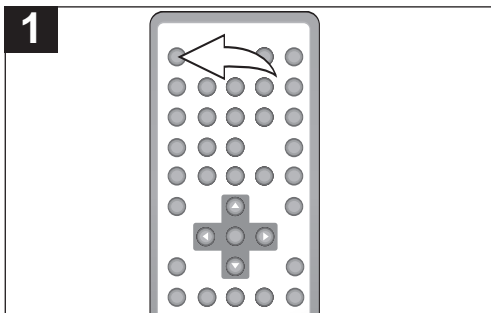

Press the **POWER** button on the remote to turn on the unit.

### NOTE:

You can also press the **POWER** button on the main unit to turn on the unit.

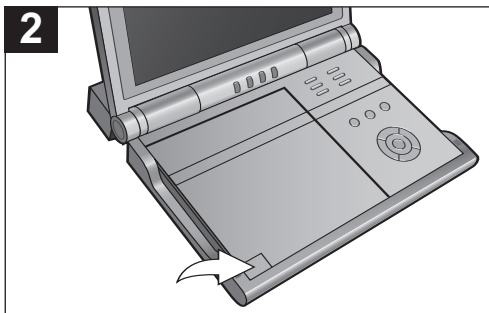

Press the **OPEN** button to open the disc tray, “**OPEN**” will appear on the screen. Insert a disc with the label side facing up on the disc tray.

**CONTINUED ON THE NEXT PAGE**

## DVD OPERATION (CONTINUED)

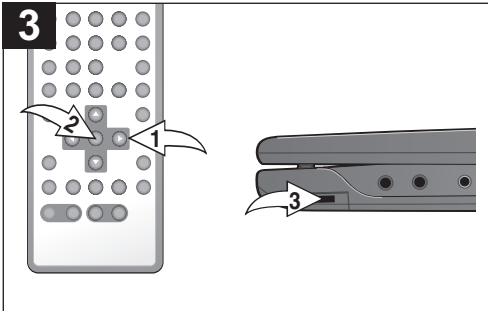

Close the disc tray. After loading, the menu screen of the DVD should appear. Use the Navigation (◀, ▶, ▲, ▼) buttons ❶ to select the desired option and press the PLAY/ENTER button ❷ to select it. Adjust the VOLUME control ❸ as desired.

### NOTE:

If the menu screen does not appear, press the MENU button to access it.

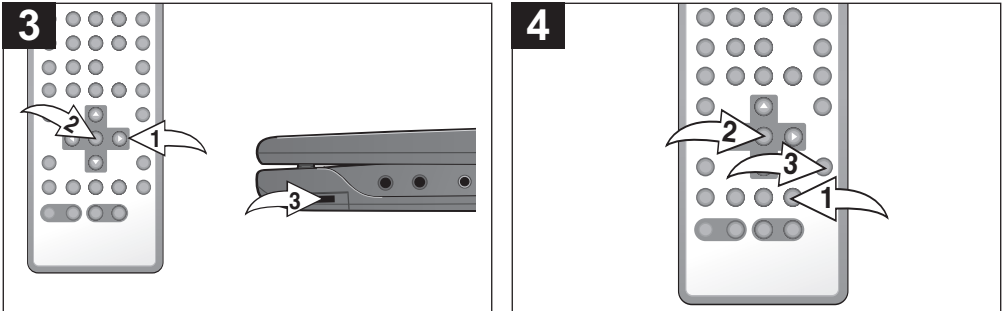

To stop playback, press the Stop (■) button ❶; “PRESS PLAY KEY TO CONTINUE” will appear on the screen. Because the unit will remember where you stopped, simply press the PLAY/ENTER button ❷ or the RESUME button ❸ to resume playback where you left off (resuming playback).

If the Stop (■) button ❶ is pressed twice, the screen shows “(■)” and the unit will stop completely.

### NOTES:

- If a MENU appears on the TV screen, press the Navigation (◀, ▶, ▲, ▼) buttons to select the desired option/item, then press the PLAY/ENTER button. Please make sure to refer to the disc's jacket or case for additional information.
- Resuming playback may not work on all discs.

# DVD OPERATION (CONTINUED)

## SKIP

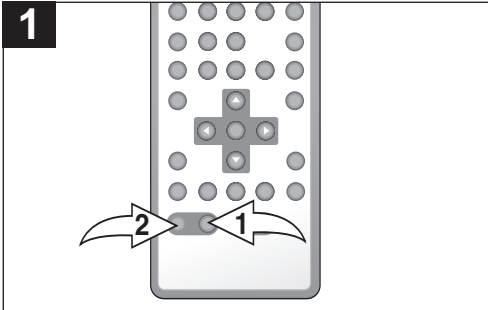

Press the Skip (▶▶) button ❶ to advance the DVD to the beginning of the next chapter.

Press the Skip (◀◀) button ❷ to move the DVD to the beginning of the current or previous chapters.

## SEARCH

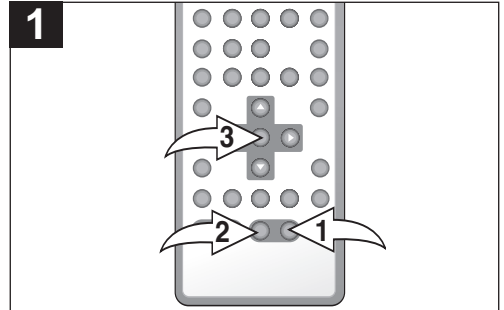

During playback, press either the Search ▶▶ button ❶ or Search ◀◀ button ❷ to move the DVD forward or backward at double (x2) speed to locate a specific section. Repeatedly press these buttons and the speed will increase to x4, x8, x16 and resume normal playback.

The DVD will move forward or backward at high speed until the PLAY/ENTER button ❸ is pressed again; normal playback will resume at that point.

## SLOW MOTION

Use this feature to move the DVD in slow motion.

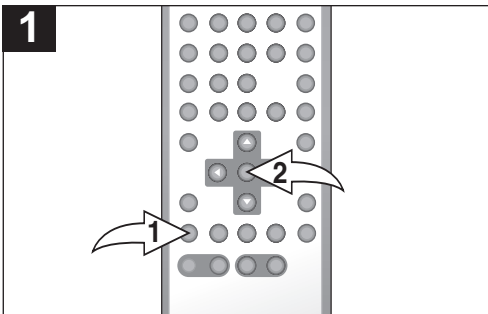

During playback, press the SLOW button ❶ to move the DVD forward in slow motion speeds of 1/2, 1/4, 1/8, 1/16 and resume normal playback. The sound will be muted. You can also resume normal playback by pressing the PLAY/ENTER button ❷.

## PAUSE/STEP

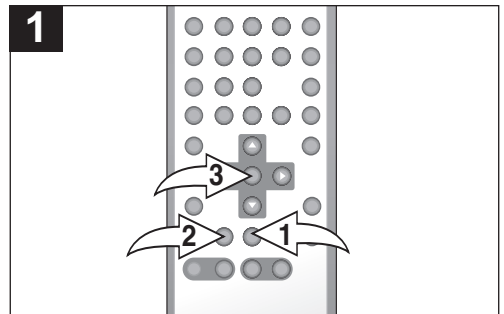

Press the PAUSE button ❶ once to pause the picture.

Repeatedly press the STEP button ❷ to play the DVD one frame at a time.

Press the PLAY/ENTER button ❸ to resume normal playback.

# DVD OPERATION (CONTINUED)

## TITLE/CHAPTER SEARCH

Use this feature to directly go to a specific title and/or chapter.

## TITLE/TIME SEARCH

Use this feature to directly go to a specific title and/or time.

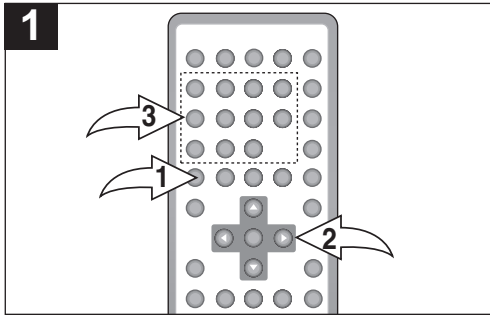

Press the GOTO button ❶ once.  
Press the Navigation (◀, ▶) buttons ❷ to select TITLE, then use the Number buttons ❸ to select the desired title number. Playback will start immediately.

OR

Press the Navigation (◀, ▶) buttons ❷ to select CHAPTER, then use the Number buttons ❸ to select the desired chapter number. Playback will start immediately.

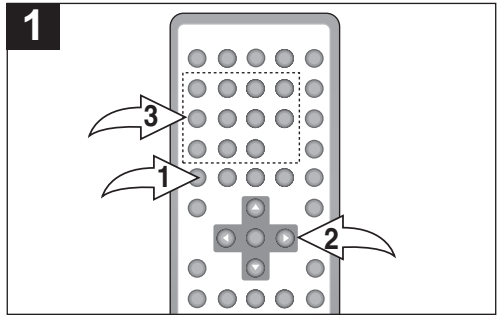

Press the GOTO button ❶ twice.  
Press the Navigation (◀, ▶) buttons ❷ to select TITLE, then use the Number buttons ❸ to select the desired title number. Playback will start immediately.

OR

Press the Navigation (◀, ▶) buttons ❷ to select TIME, then use the Number buttons ❸ to select the desired time (Hour/Minutes/Seconds). Playback will start immediately.

## CHAPTER/TIME SEARCH

Use this feature to directly go to a specific chapter and/or time.

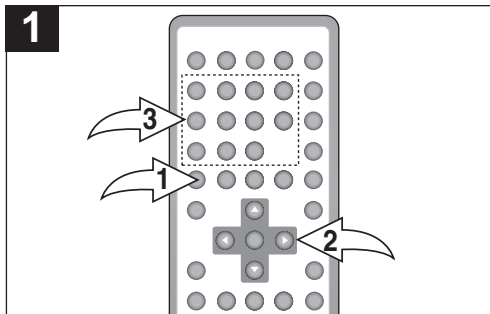

Press the GOTO button ❶ three times.  
Press the Navigation (◀, ▶) buttons ❷ to select CHAPTER, then use the Number buttons ❸ to select the desired chapter number. Playback will start immediately.

OR

Press the Navigation (◀, ▶) buttons ❷ to select TIME, then use the Number buttons ❸ to select the desired time (Hour/Minutes/Seconds). Playback will start immediately.

### NOTE:

To enter the TITLE/CHAPTER number, for numbers 10-19, press the +10 button once for the first digit and then enter the second digit using the Number (0-9) buttons; for 20-29, press the +10 button twice for the first digit and then enter the second digit using the Number (0-9) buttons, etc.

## DVD OPERATION (CONTINUED)

### REPEAT PLAYBACK

While playing back a DVD, this unit can repeatedly playback a chapter or title.

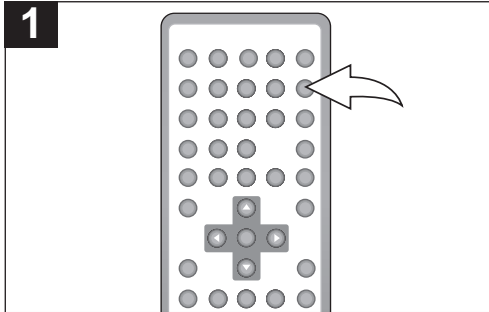

While in the Playback mode, press the REPEAT (1-All) button once; "⌂ CHAPTER" will appear on the screen and the currently playing Chapter will repeat continuously. Press the REPEAT (1-All) button a second time; "⌂ TITLE" will appear on the screen and the currently playing Title will repeat continuously.

Press the REPEAT (1-All) button a third time; "⌂ ALL" will appear on the screen and all chapters/titles will play continuously. Press the REPEAT button once more to cancel Repeat mode.

### A-B REPEAT PLAYBACK

While playing back a DVD, this unit can repeatedly playback a specific section.

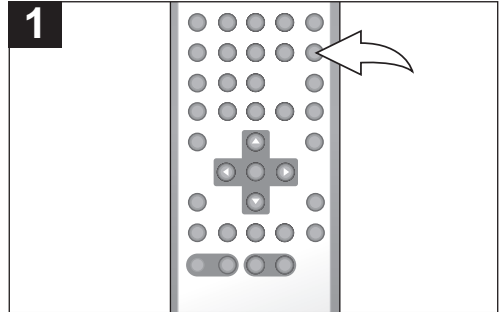

While in the Playback mode, press the Repeat A-B button to define where you want the section to start. Press the Repeat A-B button again to define where you would like the section to end, the unit will then play the selected area continuously. Press the Repeat A-B button again to cancel Repeat A-B mode.

#### NOTE:

- Repeat may not work properly with some discs.



# DVD OPERATION (CONTINUED)

## AUDIO MENU

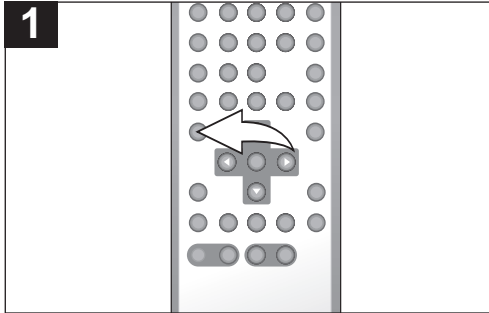

Press the AUDIO button repeatedly to change the audio language. This feature is not available on all discs.

## SUBTITLE MENU

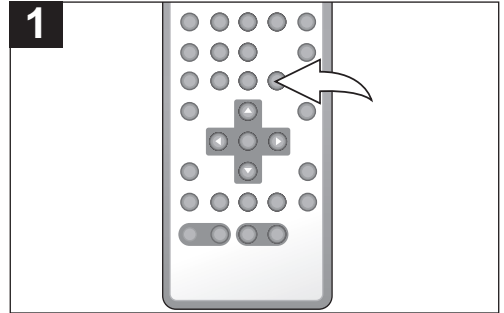

Press the SUB-T button repeatedly to select a subtitle language, and to turn the subtitle menu on/off. This feature is not available on all discs.

## DVD MENU

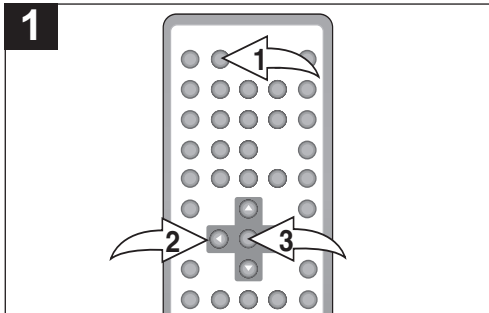

Press the MENU button ①, and the Main Menu of the disc will appear. Use the Navigation (◀, ▶, ▲, ▼) buttons ② to select the desired option, and then press the PLAY/ENTER button ③. This is not available on all discs.

## TITLE MENU

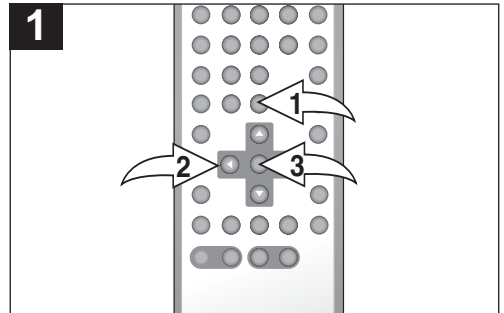

Press the TITLE MENU button ①, and the Title Menu of the disc will appear. Use the Navigation (◀, ▶, ▲, ▼) buttons ② to select the desired option, and then press the PLAY/ENTER button ③. This is not available on all discs.

# DVD OPERATION (CONTINUED)

## ZOOM IN

The image on the screen can be magnified as follows:

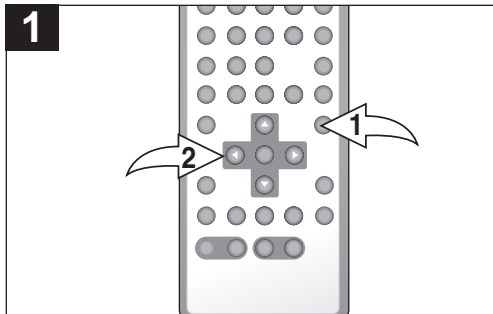

Press the ZOOM button ❶ once during Normal, Slow or Still playback modes, and the unit will zoom x2. Press once or twice more and the unit will zoom x3/x4. Press yet again to resume normal view. Use the Navigation (◀, ▶, ▲, ▼) buttons ❷ to move the image on the TV screen. This is not available on all discs.

## ANGLE

Some discs may contain scenes which have been shot simultaneously from a number of different camera angles. This feature only works on discs with more than one camera angle. The jacket will be marked with “”.

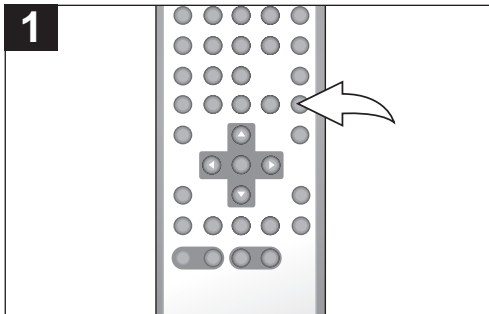

Press the ANGLE button repeatedly to select an alternate angle. This feature is not available on all discs.

## RESUME

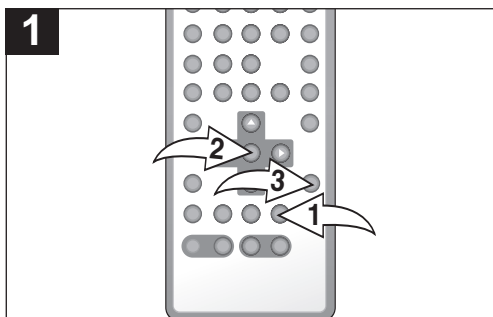

During playback, press the STOP button ❶; “PRESS PLAY KEY TO CONTINUE” will appear on the screen, simply press the PLAY/ENTER button ❷ or the RESUME button ❸ to resume playback where you left off (resuming playback).

## RANDOM

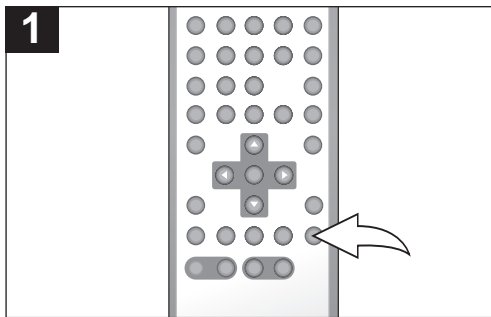

During playback, press the SHUFFLE button once “SHUFFLE” will appear on screen. All the chapters on the disc will be played randomly. To cancel Random playback, press the SHUFFLE button again, “SHUFFLE” will disappear on screen.

## DVD OPERATION (CONTINUED)

### PROGRAMMED PLAYBACK

The DVD player in this unit has a 20 chapter programmable memory that allows you to program up to 20 chapters on any disc for playback in any desired order. You may program 20 different chapters or you may also program certain chapters to play more than once. To perform Programmed Playback, proceed as follows:

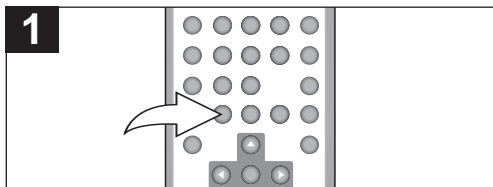

1 During playback of a DVD disc, press the PROGRAM button; the Program menu will appear on the TV screen.

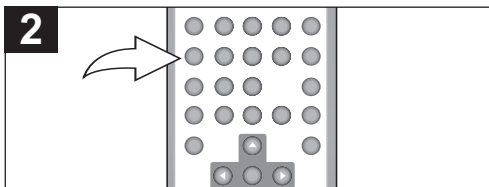

2 Select the first title and chapter to be played back using the Number buttons to input two numbers for each program track, one for the title and one for the chapter. After inputting the two numbers, the cursor will jump to the next program.

**NOTE:** For numbers 10-19, press the +10 button once for the first digit and then enter the second digit using the Number (0-9) buttons; for 20-29, press the +10 button twice for the first digit and then enter the second digit using the Number (0-9) buttons, etc.

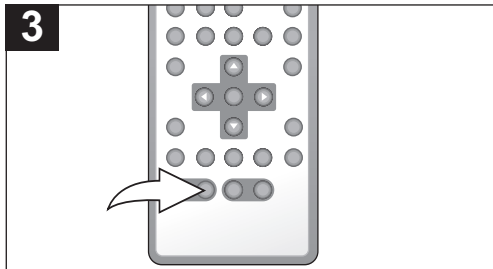

3 Repeat step 2 until all desired chapters have been programmed (up to 20).

If you would like to program more than 10 chapters, press the SKIP button to go to the next screen.

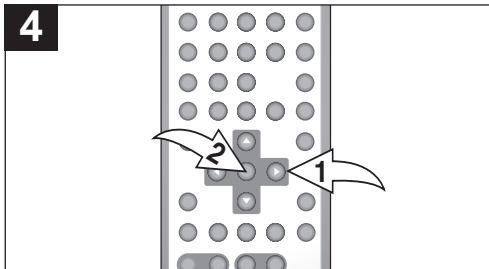

4 Use the Navigation (◀, ▶, ▲, ▼) button 1 to select "Start" at the bottom of the Program menu; then press the PLAY/ENTER button 2 to begin Programmed playback. Playback will begin on the first chapter that you programmed and the player will continue to play all of the chapters that you programmed in the order in which you programmed them.

### TO CANCEL AND STOP THE PROGRAM FUNCTION:

Press the STOP (■) button twice.

# CD OPERATION

## PLAYBACK OF A CD

1

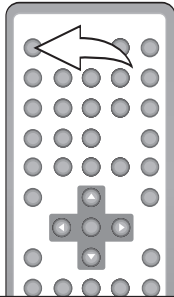

Press the POWER button on the remote to turn on the unit.

**NOTE:** You can also press the POWER button on the main unit to turn on the unit.

2

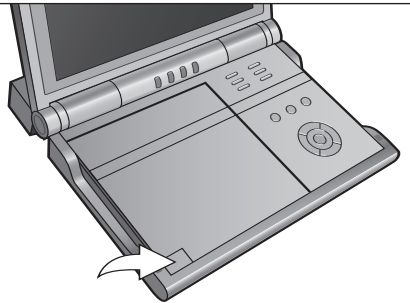

Press the OPEN button to open the disc tray, "OPEN" will appear on the screen. Insert a disc with the label side facing up on the disc tray.

3

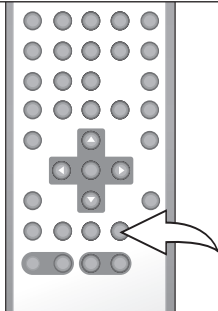

Close the disc tray. After loading, playback will start automatically. To stop playback, press the Stop (■) button.

## PAUSE

1

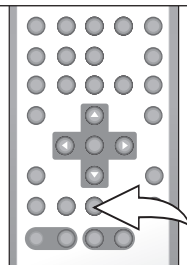

Press the PAUSE button to pause playback; the Pause indicator will appear on the screen. Press again to resume playback; the Pause indicator will turn into the Play indicator again.

# CD OPERATION (CONTINUED)

## RANDOM PLAYBACK

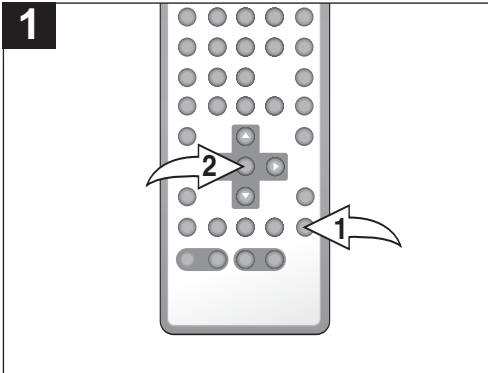

While in the Stop mode, press the SHUFFLE button ❶ once, "SHUFFLE" will appear on the screen; press the PLAY/ENTER button ❷ and the unit will randomly playback all the tracks on the CD. To cancel Random, press the SHUFFLE button ❶ until "FOLDER" appears on the screen.

## SKIP

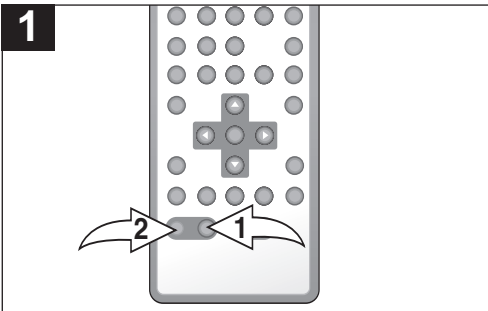

Press the Skip (▶▶) button ❶ to advance to the beginning of the next file.

Press the Skip (◀◀) button ❷ to move to the beginning of the previous file.

## SEARCH

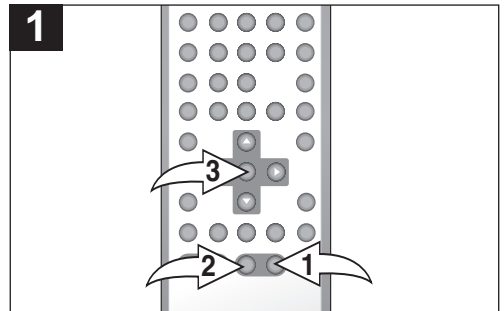

During playback, press either the Search ▶▶ button ❶ or Search ◀◀ button ❷ to move the disc forward or backward at double (x2) speed to locate a specific section. Repeatedly press these buttons and the speed will increase to x4, x8, x16 and resume normal playback.

The disc will move forward or backward at high speed until the PLAY/ENTER button ❸ is pressed again; normal playback will resume at that point.

## SELECTING TRACKS USING THE NUMBER BUTTONS

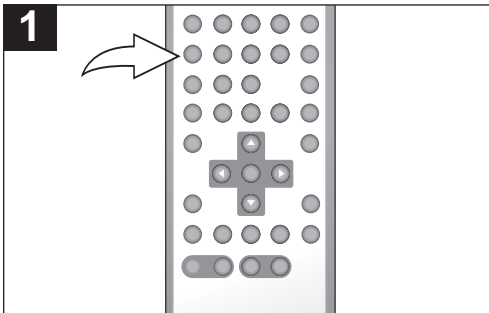

During playback, press the Number buttons corresponding to the track number to select your desired track, and the unit will playback the desired track automatically.

**NOTE:** Enter a three-digit number to select a track, i.e. for the first track, press "0", "0" and then "1" or for the tenth track, press "0", "1", "0", etc.

## REPEAT PLAYBACK

While playing back a disc, this unit can repeatedly playback one or all track(s) on a disc.

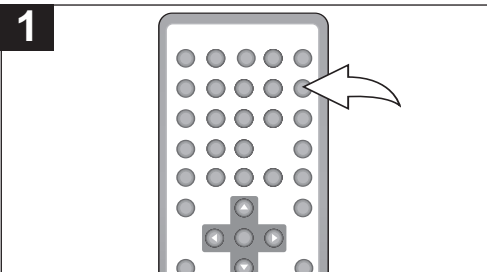

While in the Playback mode, press the REPEAT (1-All) button once; "REPEAT ONE" will appear on the screen and the currently playing track will repeat continuously.

Press the REPEAT (1-All) button a second time; "REPEAT FOLDER" will appear on the screen and all of the tracks on the disc will play continuously.

Press the REPEAT (1-All) button once more to cancel Repeat mode; "FOLDER" will appear on the screen.

## A-B REPEAT PLAYBACK

While playing back a disc, this unit can repeatedly play back a specific section.

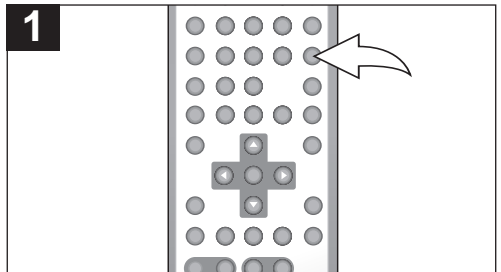

While in the Playback mode, press the Repeat A-B button to define where you want the section to start. Press the Repeat A-B button again to define where you would like the section to end, the unit will then play the selected area continuously.

Press the Repeat A-B button again to cancel Repeat A-B mode.

# PICTURE CD OPERATION

1

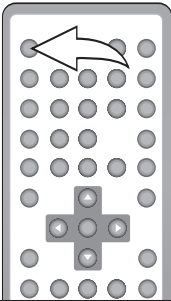

Press the POWER button to turn on the unit.

2

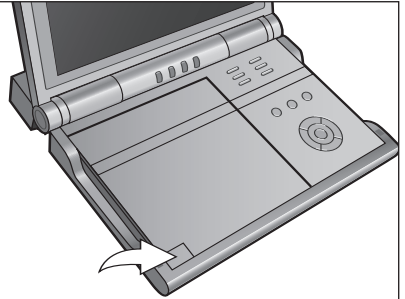

Press the OPEN button to open the disc tray, "OPEN" will appear on the screen. Insert a disc with the label side facing up on the disc tray. Close the disc tray.

3

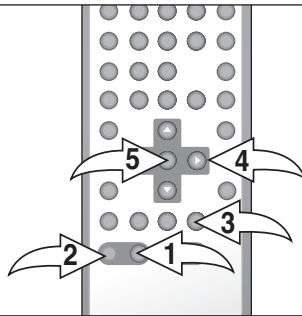

After loading a picture CD, the pictures will automatically show as a slideshow on the screen. (If playback does not start automatically, press the PLAY/ENTER button ⑤ to start playback.) Press the Skip (▶▶) ① or (◀◀) ② button to select the previous or next picture. After the slideshow is done, it will stop. Press the Stop (■) button ③ to stop the slideshow before it is finished; then the Picture menu will appear. Press the Navigation (▲, ▼) button ④ to select the desired picture then press the PLAY/ENTER button ⑤ to view it.

# TROUBLESHOOTING GUIDE

Check the following before requesting service:

SYMPTOM	POSSIBLE CAUSE	POSSIBLE SOLUTION
<b>GENERAL</b>		
No power.	Battery pack is empty.	Recharge battery pack.
Power on, but unit not functioning properly.	Condensation has formed.	Unplug the unit and wait about one to two hours to allow the player to dry.
	Wrong type of disc inserted.	This unit cannot play discs, other than DVD, standard CDs or picture CDs.
	Unit needs to be reset.	Press the POWER button, then unplug the power cord. Wait one minute and then plug the unit back in.
	The disc is dirty or inserted incorrectly.	Clean disc and insert label side-up.
	Some features and functions are not available on all discs.	This is normal; try another function.
No picture.	The equipment is not connected properly.	Connect the equipment according to the instructions in this manual.
	The INPUT of the TV is not set to receive the DVD signal output.	Select the appropriate video input mode, usually VIDEO or AV.
	The video cables are not securely connected.	Connect the video cables securely.
No sound.	The equipment is not connected properly.	Connect the equipment according to the instructions in this manual.
	The equipment connected with the audio cable is not set to receive the DVD signal input.	Select the appropriate audio input mode.
	The audio cables are not securely connected.	Connect the audio cables securely.
	The connected receiver's power is off.	Turn the audio receiver on.
Playback picture rolls.	Unit needs to be reset to NTSC.	Press P/N button.
The playback picture is poor.	The disc is dirty.	Clean the disc.
The Search feature is not working.	Some discs have sections that do not allow searching.	This is normal on some discs.
The picture is not fitting properly.	Wrong menu option is selected in the Setup menu.	Select the correct TV type (PS, LB, WIDE) which matches the TV you are using.
The remote control is not working.	The battery is weak or dead.	Install a fresh battery.
	The battery is not installed properly.	Install battery according to the diagram.
	The remote is not aimed at the sensor.	Aim the remote at the sensor.
	Distance is too far or there is too much light in the room.	Operate within 20ft, or reduce the light in the room.
	There is an obstacle in the path of the beam.	Move obstacle.



## TROUBLESHOOTING GUIDE (CONTINUED)

SYMPTOM	POSSIBLE CAUSE	POSSIBLE SOLUTION
<b>DVD</b>		
The unit does not start playback.	DVD not inserted, or inserted upside-down.	Insert DVD correctly.
	A non-playback disc is inserted.	Make sure to insert a DVD; "DVD VIDEO" will appear in the display.
	The disc is not placed in the guide.	Place the disc on the disc tray correctly inside the guide.
	The disc is dirty.	Clean the disc.
Some functions do not operate as stated.	Some features and functions are not available on all discs.	This is normal; try another function.
Selected language is not being shown in the subtitles, or spoken.	If the audio or subtitle language does not appear on the disc, then the initial setting will not be seen/heard.	This is normal; try another disc.
Subtitles are not working properly.	Subtitles appear only when the discs contain them.	This is normal; try another disc.
	Subtitles not turned on.	Turn the subtitles on.
Angle cannot be changed.	Angles may not be recorded on the disc (see disc jacket/case), or they may only be recorded on certain scenes.	Try another disc, or wait for a scene which allows a different camera angle.

**FOR ADDITIONAL SET-UP OR OPERATING ASSISTANCE, PLEASE VISIT OUR WEBSITE AT [WWW.MEMOREXELECTRONICS.COM](http://WWW.MEMOREXELECTRONICS.COM) OR CONTACT CUSTOMER SERVICE AT  
**(954) 660-7100****

**PLEASE KEEP ALL PACKAGING MATERIAL FOR AT LEAST 90 DAYS IN CASE YOU NEED TO RETURN THIS PRODUCT TO YOUR PLACE OF PURCHASE OR MEMOREX.**

**FOR PARTS AND ACCESSORIES, CONTACT FOX INTERNATIONAL AT 1-800-321-6993.**

# CARE AND MAINTENANCE

## Caring for Discs

- Treat the disc carefully. Handle the disc only by its edges. Never allow your fingers to come in contact with the shiny, unprinted side of the disc.
- Do not attach adhesive tape, stickers, etc. to the disc label.
- Clean the disc periodically with a soft, lint-free, dry cloth. Never use detergents or abrasive cleaners to clean the disc. If necessary, use a CD cleaning kit.
- If a disc skips or gets stuck on a section of the disc, it is probably dirty or damaged (scratched).
- When cleaning the disc, wipe in straight lines from the center of the disc to the outer edge of the disc. Never wipe in circular motions.
- Discs should be stored in their cases after each use to avoid damage.
- Do not expose discs to direct sunlight, high humidity, high temperatures or dust, etc. Prolonged exposure or extreme temperatures can warp the disc.
- Do not stick or write anything on either side of the disc. Sharp writing instruments, or the ink, may damage the surface.

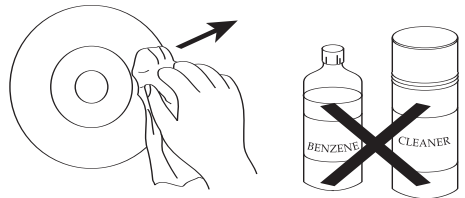
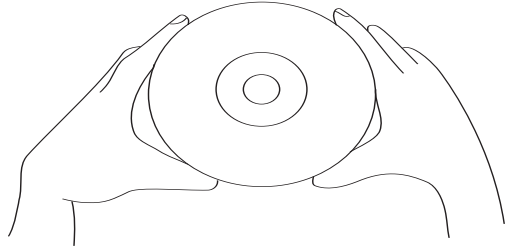

## Cleaning the Unit

- To prevent fire or shock hazard, disconnect your unit from the AC power source when cleaning.
- The finish on your unit may be cleaned with a dust cloth and cared for as other furniture. Use caution when cleaning and wiping the plastic parts.
- Mild soap and a damp cloth may be used on the front panel.

# SPECIFICATIONS

Power Requirements .....	DC IN 9V (Center Positive ⊖⊕)
Battery Pack.....	Lithium-Polymer Rechargeable Battery DC 7.4V 4000mAh
Weight .....	2.7 Lbs
Dimensions.....(Main unit without Battery Pack)	10.3 (L) x 7.25 (W) x 1.4 (Thickness) inches
Operating Temperature .....	41° to 95°F
Operating Humidity Range .....	5% to 90% (no condensation)
Accessories	AC Adapter, Rechargeable Battery Pack, Remote Control, Remote Battery, Carrying Bag, Audio Cable, Audio(Coaxial)/Video Cable, Component Cable

Discs Played:

## DVD-VIDEO Disc

- 12cm single-sided, single layer
- 12cm single-sided, dual layer
- 12cm double-sided, single layer
- 8cm single-sided, single layer
- 8cm single-sided, dual layer
- 8cm double-sided, single layer

## COMPACT DISC

- 12cm disc
- 8cm disc

Video Output Level.....0.8-1.2Vp-p

Audio Output Level.....1.0-2.0Vrms (1KHz, 0dB)

## Audio Signal Output Characteristics:

Frequency Responses:

DVD (Linear Audio) .....20Hz-20KHz (48KHz/96KHz sampling)

CD Audio.....20Hz-20KHz

S/N Ratio.....70dB

Wow and Flutter.....Below Measurable Level

## Pickup:

Wavelength.....655nm

Laser Power.....Class 1

Specifications are subject to change without notice.

Memcorp, Inc.  
Weston, FL  
Printed in Hong Kong

Visit our website at [www.memorexelectronics.com](http://www.memorexelectronics.com)

## Free Manuals Download Website

<http://myh66.com>

<http://usermanuals.us>

<http://www.somanuals.com>

<http://www.4manuals.cc>

<http://www.manual-lib.com>

<http://www.404manual.com>

<http://www.luxmanual.com>

<http://aubethermostatmanual.com>

Golf course search by state

<http://golfingnear.com>

Email search by domain

<http://emailbydomain.com>

Auto manuals search

<http://auto.somanuals.com>

TV manuals search

<http://tv.somanuals.com>