



OWNER'S MANUAL
MANUEL D'INSTRUCTIONS

Memorex®

**20" MTS STEREO COLOR TELEVISION
TÉLÉVISEUR COULEUR, STÉRÉO ET
MTS DE 20 POUCES**

MT1120A

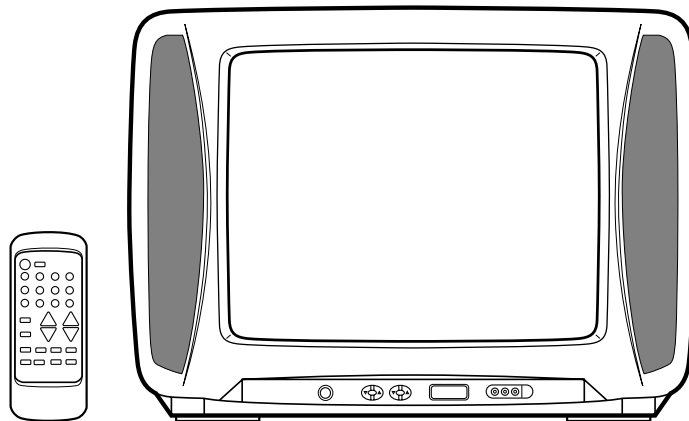

**ATTENTION
ATTENTION**

For your protection in the event of theft or loss of this product, please fill in the information listed below which is for your own personal records.
Pour votre protection en cas de vol ou de perte de l'appareil, veuillez inscrire ci-dessous les renseignements demandés.

Date of Purchase : _____
Date d'achat : _____
Serial No. : _____
Numéro de série : _____
Place of Purchase : _____
Lieu d'achat : _____

**TV/CATV MODE SELECTION
SÉLECTION DU MODE TV/CATV**

When shipped from the factory, the TV/CATV menu option is set to the "CATV" (Cable Television) mode. If not using CATV, set this menu option to "TV" mode.

Lorsque l'appareil sort de l'usine, l'option du menu TV/CATV est en mode "CATV" (câblodistribution).

Si vous n'utilisez pas la câblodistribution, choisissez l'option "TV".



Before operating the unit, please read this manual thoroughly.
Avant de mettre cet appareil en marche, veuillez lire attentivement ce manuel.





	CAUTION RISK OF ELECTRIC SHOCK DO NOT OPEN	
CAUTION: TO REDUCE THE RISK OF ELECTRIC SHOCK, DO NOT REMOVE COVER (OR BACK). NO USER-SERVICEABLE PARTS INSIDE. REFER SERVICING TO QUALIFIED SERVICE PERSONNEL.		



The lightning flash with arrowhead symbol, within an equilateral triangle is intended to alert the user to the presence of uninsulated dangerous voltage within the product's enclosure that may be of sufficient to constitute a risk of electric shock to persons.



The exclamation point within an equilateral triangle is intended to alert the user to the presence of important operating and maintenance (servicing) instructions in the literature accompanying the appliance.

CAUTION: Changes or modifications not expressly approved by the party responsible for compliance with the FCC Rules could void the user's authority to operate this equipment.

WARNING: TO PREVENT FIRE OR SHOCK HAZARD, DO NOT EXPOSE THIS APPLIANCE TO RAIN OR MOISTURE.

CAUTION: TO PREVENT ELECTRIC SHOCK DO NOT USE THIS POLARIZED PLUG WITH AN EXTENSION CORD, RECEPTACLE OR OTHER OUTLET UNLESS THE BLADES CAN BE FULLY INSERTED TO PREVENT BLADE EXPOSURE.

IMPORTANT SAFEGUARDS

1. READ INSTRUCTIONS

All the safety and operating instructions should be read before the unit is operated.

2. RETAIN INSTRUCTIONS

The safety and operating instructions should be retained for future reference.

3. HEED WARNINGS

All warnings on the unit and in the operating instructions should be adhered to.

4. FOLLOW INSTRUCTIONS

All operating and use instructions should be followed.

5. CLEANING

Unplug this unit from the wall outlet before cleaning. Do not use liquid cleaners or aerosol cleaners. Use a damp cloth for cleaning.

6. ATTACHMENTS

Do not use attachments not recommended by the unit's manufacturer as they may cause hazards.

7. WATER AND MOISTURE

Do not use this unit near water. For example, near a bathtub, washbowl, kitchen sink, or laundry tub, in a wet basement, or near a swimming pool.

8. ACCESSORIES

Do not place this unit on an unstable cart, stand, tripod, bracket, or table. The unit may fall, causing serious injury, and serious damage to the unit. Use only with a cart, stand, tripod, bracket, or table recommended by the manufacturer.

- 8A.** An appliance and cart combination should be moved with care. Quick stops, excessive force, and uneven surfaces may cause the appliance and cart combination to overturn.

PORTABLE CART WARNING
(symbol provided by RETAC)



S3126A

9. VENTILATION

Slots and openings in the cabinet and in the back or bottom are provided for ventilation, to ensure reliable operation of the unit and to protect it from overheating. These openings must not be blocked or covered. The openings should never be blocked by placing the unit on a bed, sofa, rug, or other similar surface. This unit should never be placed near or over a radiator or heat source. This unit should not be placed in a built-in installation, such as a bookcase, or rack unless proper ventilation is provided or the manufacturer's instructions have been adhered to.

10. POWER SOURCE

This unit should be operated only from the type of power source indicated on the rating plate. If you are not sure of the type of power supply to your home, consult your appliance dealer or local power company. For units intended to operate from battery power, or other sources, refer to the operating instructions.

11. GROUNDING OR POLARIZATION

This unit is equipped with a polarized alternating current line plug (a plug having one blade wider than the other). This plug will fit into the power outlet only one way. This is a safety feature. If you are unable to insert the plug fully into the outlet, try reversing the plug. If the plug should still fail to fit, contact your electrician to replace your obsolete outlet. Do not defeat the safety purpose of the polarized plug. If your unit is equipped with a 3-wire grounding-type plug, a plug having a third (grounding) pin, this plug will only fit into a grounding-type power outlet. This too, is a safety feature. If you are unable to insert the plug into the outlet, contact your electrician to replace your obsolete outlet. Do not defeat the safety purpose of the grounding-type plug.

12. POWERCORD PROTECTION

Power-supply cords should be routed so that they are not likely to be walked on or pinched by items placed upon or against them, paying particular attention to cords at plugs, convenience receptacles, and the point where they exit from the appliance.





13. LIGHTNING

To protect your unit during a lightning storm, or when it is left unattended and unused for long periods of time, unplug it from the wall outlet and disconnect the antenna or cable system. This will prevent damage to the unit due to lightning and power line surges.

14. POWER LINES

An outside antenna system should not be located in the vicinity of overhead power lines, or other electric light or power circuits, or where it can fall into such power lines or circuits. When installing an outside antenna system, extreme care should be taken to keep from touching such power lines or circuits as contact with them might be fatal.

15. OVERLOADING

Do not overload wall outlets and extension cords as this can result in a risk of fire or electric shock.

16. OBJECT AND LIQUID ENTRY

Do not push objects through any openings in this unit as they may touch dangerous voltage points or short out parts that could result in fire or electric shock. Never spill or spray any type of liquid into the unit.

17. OUTDOOR ANTENNA GROUNDING

If an outside antenna or cable system is connected to the unit, be sure the antenna or cable system is grounded so as to provide some protection against voltage surges and built-up static charges. Section 810 of the National Electrical Code, ANSI/NFPA 70, provides information with respect to proper grounding of the mast and supporting structure, grounding of the lead-in wire to an antenna discharge unit, size of grounding conductors, location of antenna discharge unit, connection to grounding electrodes, and requirements for the grounding electrode.

18. SERVICING

Do not attempt to service this unit yourself as opening or removing covers may expose you to dangerous voltage or other hazards. Refer all servicing to qualified service personnel.

19. DAMAGE REQUIRING SERVICE

Unplug this unit from the wall outlet and refer servicing to qualified service personnel under the following conditions:

- a. When the power-supply cord or plug is damaged.
- b. If liquid has been spilled, or objects have fallen into the unit.
- c. If the unit has been exposed to rain or water.
- d. If the unit does not operate normally by following the operating instructions. Adjust only those controls that are covered by the operating instructions, as an improper adjustment of other controls may result in damage and will often require extensive work by a qualified technician to restore the unit to its normal operation.
- e. If the unit has been dropped or the cabinet has been damaged.
- f. When the unit exhibits a distinct change in performance, this indicates a need for service.

20. REPLACEMENT PARTS

When replacement parts are required, be sure the service technician uses replacement parts specified by the manufacturer or those that have the same characteristics as the original part.

Unauthorized substitutions may result in fire, electric shock or other hazards.

21. SAFETY CHECK

Upon completion of any service or repairs to this unit, ask the service technician to perform safety checks to determine that the unit is in proper operating condition.

22. WALL OR CEILING MOUNTING

The product should be mounted to a wall or ceiling only as recommended by the manufacturer.

23. HEAT

The product should be situated away from heat sources such as radiators, heat registers, stoves, or other products (including amplifiers) that produce heat.

24. NOTE TO CATV SYSTEM INSTALLER

This reminder is provided to call the CATV system installer's attention to Article 820-40 of the NEC that provides guidelines for proper grounding and, in particular, specifies that the cable ground shall be connected to the grounding system of the building, as close to the point of cable entry as practical.

EXAMPLE OF ANTENNA GROUNDING AS PER NATIONAL ELECTRICAL CODE

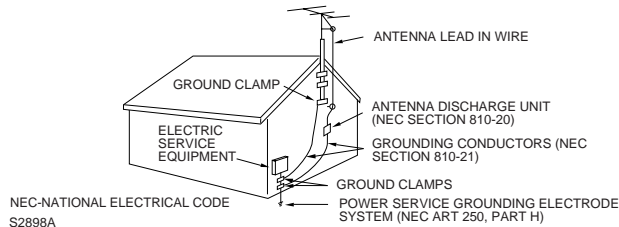



FEATURES

- **181 Channel Tuner** - The tuning system is capable of receiving all 68 VHF/UHF standard broadcast channels that are available in your area. When operating on a cable system, it can tune to the standard VHF channel frequencies plus up to 113 cable channel frequencies. The actual number of channels received depends upon channel reception in your area or your cable system.
- **On-Screen 3 Language Display** - Consists of channel, sleep timer, volume level, muting, text/caption indicators and picture control adjustments. These can be displayed in English, Spanish or French.
- **Sleep Timer** - Operable from the remote control, this TV can be programmed up to 120 minutes to turn off automatically.
- **Memory Back Up** - This system prevents loss of memorized channel selections in case a power interruption to the TV should occur.
- **V-Chip** - The V-Chip function can rate a TV program or movie content. It allows you to set a restriction level.
- **Picture Control Adjustments** - The On-Screen display allows precise remote control adjustment of BRIGHTNESS, COLOR, CONTRAST, SHARPNESS and TINT.
- **Closed Captioned Decoder** - Displays text captions or 1/2 of full screen text on the screen for hearing impaired viewers.
- **Stereo/SAP Reception** - This TV designed to receive stereo and separate audio program (SAP) broadcasts where available.

LOCATION OF CONTROLS

FRONT

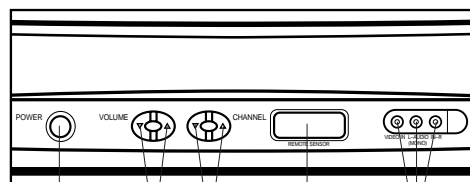
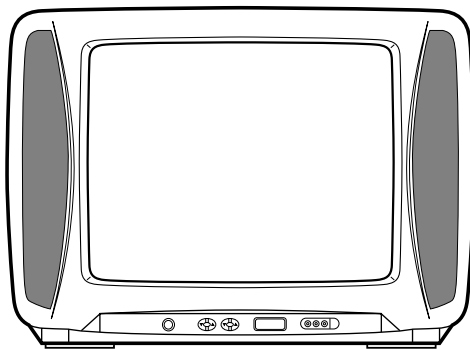

1

2

3

4

5

BACK

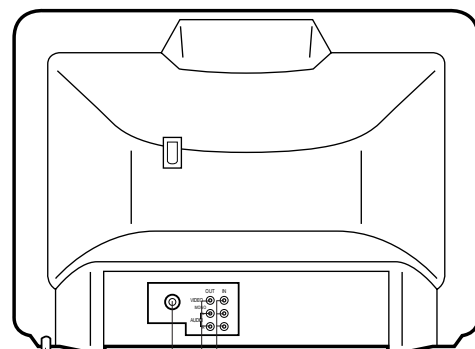

6

7

8

9

1. **POWER Button** - Press to turn the TV on or off.
2. **VOLUME ▲ / ▼ Buttons** - Press to raise or lower the volume of the sound.
3. **CHANNEL ▲ / ▼ Buttons** - Press to select a higher or lower numbered channel set into memory.
4. **Remote Sensor** - Signals from the Remote Control unit are received here.
5. **AUDIO (L / R) / VIDEO IN Jacks** - Audio and video signal cables from an external source can be connected here.

6. **AC Power Cord** - Plug into an outlet having 120V, 60 Hz AC power only.
7. **VHF/UHF IN (ANT) Jack** - Connect a VHF/UHF antenna or CATV cable to this jack.
8. **AUDIO (L / R) / VIDEO OUT Jacks** - Used to output audio and video signals to a TV, amplifier or VCR.
9. **AUDIO (L / R) / VIDEO IN Jacks** - Audio and video signal cables from an external source can be connected here.





REMOTE CONTROL

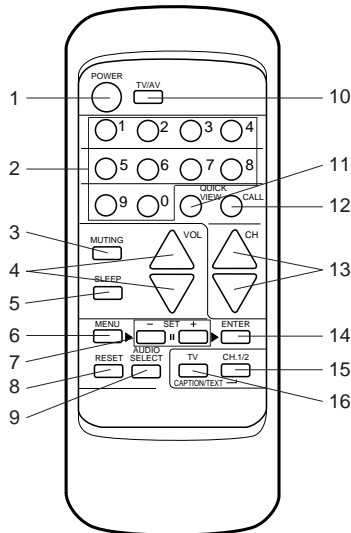

1. **POWER Button** - Press to turn the TV on. Press again to turn the TV off.
2. **Direct Channel Selection Buttons (0-9)** - Allows direct access to any channel.
3. **MUTING Button** - To turn off the sound, press this button once. The TV will be silenced and the symbol "MUTING" will appear on the screen. The muting feature can be released by pressing the MUTING button again or one of the VOL ▲ or ▼ button.
4. **VOL (VOLUME) ▲ / ▼ Buttons** - Press the ▲ button to increase, or the ▼ button to decrease the volume level.

5. **SLEEP Button** - To set the TV to turn off after a preset amount of time, press the SLEEP button on the remote control. The clock will count down 10 minutes each time the button is pressed in the order of 120, 110, 100, 20, 10, 0. After the sleep time is programmed, the display will disappear then reappear momentarily every ten minutes to remind you the sleep timer function is operating. To confirm the sleep time setting, press the SLEEP button once and the remaining time will be momentarily displayed. To cancel sleep time, press the SLEEP button repeatedly until the display turns to 0.
6. **MENU Button** - Press to display the On-Screen menu function.
7. **SET + / - Buttons** - Press to select the desired setting during On-Screen operations.
8. **RESET Button** - Press to reset the On-Screen picture adjustments to their factory preset positions. Press to reset a password in the V-CHIP Password setting mode.
9. **AUDIO SELECT Button** - Switches sound between mono and stereo, and SAP when receiving broadcasts in stereo or SAP.
10. **TV/AV Button** - Switches between TV and external inputs.
11. **QUICK VIEW Button** - This button allows you to go back to the previous channel selected by just pressing the QUICK VIEW button. Press this button again to return to the channel you were watching.
12. **CALL Button** - When you press this button, the channel number tuned will appear on the upper right corner of the screen. Press the button again to remove display from the screen.
13. **CH (CHANNEL) ▲ / ▼ Buttons** - Press the ▲ button to change to a higher numbered channel set into memory. Press the ▼ button to change to a lower numbered channel set into memory.
14. **ENTER Button** - Press to enter or select information for On-Screen operations.
15. **CH.1/2 Button** - Switches between Channel 1 and Channel 2 in the Closed Caption mode.
16. **TV/CAPTION/TEXT Button** - Press this button to switch between normal TV and the two Closed Caption modes (captions and 1/2 of full screen text). Closed Captioning will display text on screen for hearing impaired viewers.

Before using the remote control, batteries must first be installed into it.

HOW TO INSTALL BATTERIES

1. Open the battery compartment cover.

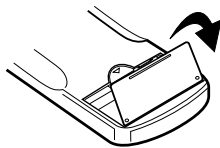

2. Install two "AAA" batteries.

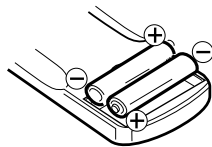

3. Replace the battery compartment cover.

Use two "AAA" size batteries. The batteries may last approximately one year depending on how much the remote control is used. For best performance, it is recommended that batteries should be replaced on a yearly basis, or when the remote operation becomes erratic. Do not mix old and new batteries or different types.

BATTERY PRECAUTIONS

These precautions should be followed when using batteries in this device:

- Use only the size and type of batteries specified.
- Be sure to follow the correct polarity when installing the batteries as indicated in the battery compartment. Reversed batteries may cause damage to the device.
- Do not mix different types of batteries together (e.g. Alkaline and Carbon-zinc) or old batteries with fresh ones.
- If the device is not to be used for a long period of time, remove the batteries to prevent damage or injury from possible battery leakage.
- Do not try to recharge batteries not intended to be re-charged; they can overheat and rupture. (Follow battery manufacturer's directions.)





ANTENNA/CATV CONNECTIONS

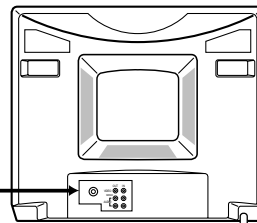
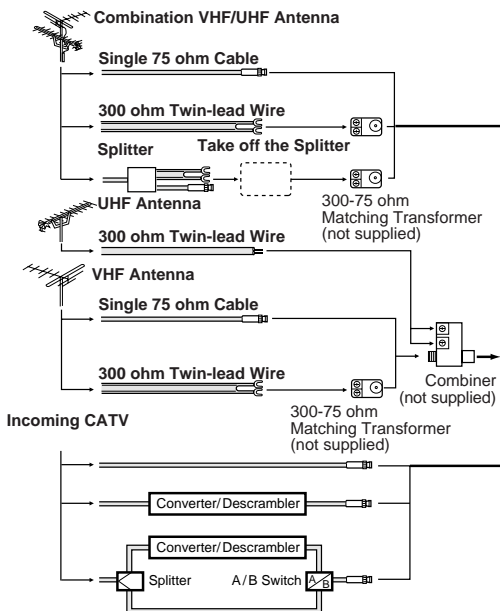

This television has an extended tuning range and can tune most cable channels without using a cable company supplied converter box. Some cable companies offer "premium pay channels" in which the signal is scrambled. Descrambling these signals for normal viewing requires the use of a descrambler device which is generally provided by the cable company.

Separate VHF/UHF Antennas

Connect the 75 ohm Cable from the VHF antenna and the UHF antenna Twin-lead to a combiner (not supplied). Attach the Combiner to the Antenna Jack.

NOTE: If your VHF antenna has a Twin-lead Wire, use the 300-75 ohm Matching Transformer (not supplied), then connect the Transformer to the Combiner.

For Subscribers to Basic Cable TV Service

For basic cable service not requiring a Converter/Descrambler box, connect the CATV 75 ohm Coaxial Cable directly to the Antenna Jack on the back of the television.

For Subscribers to Scrambled Cable TV Service

If you subscribe to a cable service which requires the use of a Converter/Descrambler box, connect the incoming cable to the Converter/Descrambler box and connect the output of the box to the Antenna Jack on the back of the television. Follow the connections shown left. Set the television to the output of the Converter/Descrambler box (usually channel 3 or 4) and use the Converter/Descrambler box to select channels.

For Subscribers to Unscrambled Basic Cable with Scrambled Premium Channels

If you subscribe to a cable service in which basic cable channels are unscrambled and premium channels require the use of a Converter/Descrambler box, you may wish to use a two-set signal splitter (sometimes called a "two-set coupler") and an A/B Switch box from the cable installer or an electronics supply store. Follow the connections shown left. With the switch in the "B" position, you can directly tune any unscrambled channels on your TV. With the switch in the "A" position, tune your TV to the output of the Converter/Descrambler box (usually channel 3 or 4) and use the box to tune scrambled channels.

Combination VHF/UHF Antenna (Single 75 ohm Cable or 300 ohm Twin-lead Wire)

Connect the 75 ohm cable from a combination VHF/UHF antenna to the Antenna Jack. If your combination antenna has a 300 ohm Twin-lead Wire, use the 300-75 ohm Matching Transformer (not supplied).

Combination VHF/UHF Antenna (Separate VHF and UHF 300 ohm Twin-leads)

Connect the UHF Twin-lead Wire to a Combiner (not supplied). Connect the VHF Twin-lead to the 300-75 ohm Matching Transformer (not supplied). Attach the Transformer to the Combiner. Attach the Combiner to the Antenna Jack.

AUDIO/VIDEO JACK CONNECTIONS

The exact arrangement you use to interconnect various video and audio components to the TV is dependent on the model and features of each component. Check the Owner's Manual provided with each component for the location of video and audio inputs and outputs.

The connection diagrams in the following are offered as suggestions. You may need to modify them to accommodate your particular assortment of components. The diagrams are intended to show component video and audio interconnections only.

Press the TV/AV selector button to select the AV mode to use the TV as a monitor. Operate your VCR as usual.

TV/AV SELECTION

If you connect the TV to VCR, camcorder or TV game, you can select by pressing the TV/AV button.

Press the TV/AV button repeatedly to select the desired mode. "AUX1" or "AUX2" will display on the screen for 4 seconds.

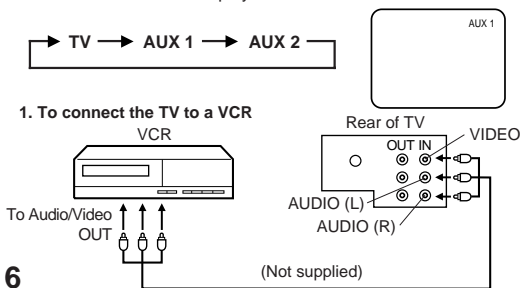

1. To connect the TV to a VCR

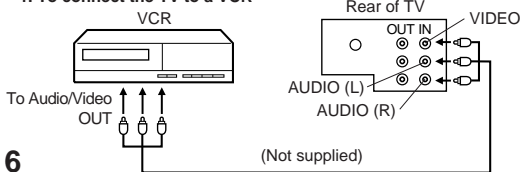

2. To connect the TV to a TV Game

The TV can also be used as a display device for many video games. However, due to the wide variety of different types of signal generated by these devices and subsequent hook-up variations required, they have not all been included in the suggested connection diagrams. You'll need to consult each component's Owner's Manual for additional information.

3. To connect the TV to the camcorder

To playback from the camcorder, connect the camcorder to the TV as shown.

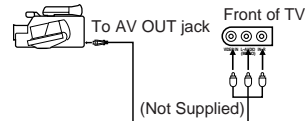



SETTING LANGUAGE

This TV can display the channel number, on screen displays and picture adjustments on the screen in English, Spanish or French.

On-screen language selection (step 3) will automatically appear on the screen when you press the MENU button initially. Select language to use the other menu options.

- 1 Press the MENU button.

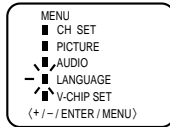

- 2 Press the SET + or – button to select the LANGUAGE mode, then press the ENTER button.

- 3 Press the SET + or – button until the "▶" indicator points to the desired language: English (ENGLISH), Spanish (ESPAÑOL) or French (FRANCAIS), then press the ENTER button.

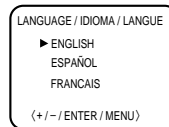

ENGLISH

- 4 Press the MENU button again.

NOTE:

If Spanish or French is chosen, the Closed Caption indicators will be in the selected language, but the Closed Caption text will not be affected by the language selection.

TV OPERATION

- 1 To turn on the TV, press the POWER button.

- 2 The VOLUME can be adjusted to a desired level by pressing the VOL (VOLUME) ▲ or ▼ button.

The sound level will be indicated on the TV screen by green bars and a number. As the sound level increases, so do the number of bars and the number on the screen. The same is true for decreasing the level.

- 3 Set the TV/CATV menu option to the appropriate position. When shipped from the factory, this menu option is in the CATV setting. See "TO MEMORIZE CHANNELS".

TV - VHF/UHF channels
CATV - CABLE TV channels

- 4 **CH (CHANNEL) ▲ and ▼ buttons**
Press and release the CH (CHANNEL) ▲ or ▼ button. The channel automatically stops at the next channel set into memory. Press and hold the button down to change channels more quickly.

For proper operation, before selecting channels, they should be set into the TV's memory. See "TO MEMORIZE CHANNELS".

Direct Channel Selection buttons (0-9)

Press these buttons to select a channel. The channel number will appear on the upper right corner of the TV screen. If an invalid channel number is selected, the display will revert to the original channel.

TV Mode Direct Channel Selection

When the TV/CATV menu option is in the TV position, all channels can be instantly selected by using two buttons. (For example, to select channel 2, press "0", then "2". If you press only "2", channel selection will be delayed for a few seconds). For channels 10 and above, press the 2 digits in order.

CATV Mode Direct Channel Selection

When the TV/CATV menu option is in the CATV position, channels can be selected as follows:

CH. 1-9	Press "0" twice, then 1-9 as needed. Example, to select channel 2, press "002".
CH. 10-19	Press "0", then remaining 2 digits. Example, to select channel 13, press "013".
CH. 20-99	Press the 2 digits in order. Example, to select channel 36, press "36".
CH. 100-125	Press the 3 digits in order. Example, to select channel 120, press "120".

NOTE: If the station being viewed stops broadcasting, the TV will automatically shut off after 15 minutes.





TO MEMORIZE CHANNELS

This TV is equipped with a channel memory feature which allows channels to skip up or down to the next channel set into memory, skipping over unwanted channels. Before selecting channels, they must be programmed into the TV's memory. In addition to normal VHF and UHF channels, this TV can receive up to 113 Cable TV channels. To use this TV with an antenna, set the TV/CATV menu option to the TV setting. When shipped from the factory, this menu option is in the CATV setting.

TV/CATV SELECTION

- 1 Press the MENU button.
- 2 Press the SET + or – button until the indicator next to "CH SET" begins to flash, then press the ENTER button.
- 3 Press the SET + or – button until the indicator next to "TV/CATV" begins to flash.
- 4 Press the ENTER button to select the TV or CATV mode. The arrow indicates the selected mode.
- 5 Press the MENU button twice to return to normal TV viewing.

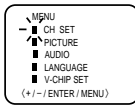

The chart below is typical of many cable system channel allocations.

CATV CHART

Number on this TV	Corresponding CATV channel	14	15	16	17	18	19	20	21	22
23	24	25	26	27	28	29	30	31	32	33
J	K	L	M	N	O	P	Q	R	S	T
41	42	43	44	45	46	47	48	49	50	51
EE	FF	GG	HH	II	JJ	KK	LL	MM	NN	OO
59	60	61	62	63	64	65	66	67	68	69
VV	AA	BB	CC	DD	EE	FF	GG	HH	II	JJ
77	78	79	80	81	82	83	84	85	86	87
RR	SS	TT	UU	VV	WW	XX	YY	ZZ	88	89
95	96	97	98	99	100	101	102	103	104	105
A-5	A-4	A-3	A-2	A-1	100	101	102	103	104	105
113	114	115	116	117	118	119	120	121	122	123
113	114	115	116	117	118	119	120	121	122	123

NOTE: Contact your cable company to determine the type of cable system used in your area.

AUTOMATIC CHANNEL MEMORY

- 1 Press the MENU button.
- 2 Press the SET + or – button until the indicator next to "CH SET" begins to flash, then press the ENTER button.
- 3 Press the SET + or – button until the indicator next to "AUTO CH MEMORY" begins to flash, then press the ENTER button. The TV will begin memorizing all the channels available in your area.
- 4 Press the MENU button twice to return to normal TV viewing.

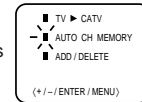
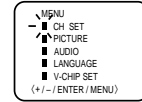

TO ADD/DELETE CHANNELS

- 1 Press the MENU button.
- 2 Press the SET + or – button until the indicator next to "CH SET" begins to flash, then press the ENTER button.
- 3 Press the SET + or – button until the indicator next to "ADD/DELETE" begins to flash, then press the ENTER button.

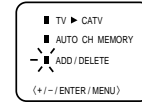
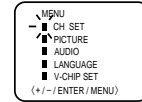

- 4 Select the desired channels to be memorized or deleted using the Direct Channel Selection buttons (10 keys, 0-9), the CH ▲ or ▼ button or the SET + or – button.
- 5 Press the ENTER button to select ADD or DELETE. If an unmemorized channel was selected (step 4), the channel indication will be red. Press the ENTER button if you wish to ADD the unmemorized channel. The channel indicator will change from red to green when a channel is added and the channel will be memorized. If a memorized channel was selected (step 4), the channel indication will be green.

Press the ENTER button if you wish to DELETE the channel from memory. The channel indicator will change from green to red when a channel is deleted. Repeat Steps 4 and 5 for each channel to be added or deleted.

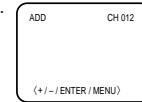

- 6 Press the MENU button three times after adding or deleting all of the desired channels, to return to normal TV viewing.



SETTING V-CHIP

This TV is fitted with a V-CHIP controller which provides you with channel viewing access controls and restrictions. This function is to prevent your children from watching violence or sexual scenes that may be harmful.

- 1 Press the MENU button and press the SET + or - button to select the V-CHIP SET option, then press the ENTER button.
- 2 Enter your password using the Direct channel selection buttons.
In the event of entering incorrect password press the RESET button. Then press the ENTER button.
- 3 Enter the same password for confirmation, then press the ENTER button.
- 4 Press the SET + or - button to select the V-CHIP option.
Press the ENTER button to select the ON.
- 5 Press the SET + or - button to select the TV RATING or MOVIE RATING option. Press the ENTER button.
- 6 Press the SET + or - button to select the desired rating for the applicable video or TV channel. Press the ENTER button.
- 7 Press the MENU button twice to return to normal TV viewing.

TV RATING

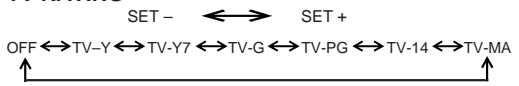

TV-Y : all children	TV-PG : parental guidance
TV-Y7 : 7 years old and above	TV-14 : 14 years old and above
TV-G : childrens program	TV-MA : 17 years old and above

When you select TV-Y7, TV-PG, TV-14 or TV-MA, press the CALL button to show the contained rating. Press the SET + or - button to select the desired item you want. Press the ENTER button to select the OFF.

MOVIE RATING

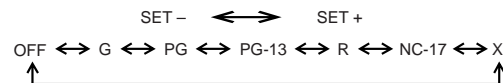

G : all ages	R : under 17 years old
PG : parental guidance	parental guidance suggested
PG-13 : parental guidance less than 13 years old	NC-17 : 17 years old and above
	X : adult only

NOTES:

- The V-Chip function is activated only on programs and tapes that have the rating signal.
- Once you block a program using the V-Chip function, the blocked program cannot be watched based on the content of the show. When the program starts, the "ENTER PASSWORD" will appear on the screen. When you want to release the V-Chip temporarily, enter the password.
If you change the channel or turn off and on the TV while releasing the V-Chip temporarily, the V-Chip setting will be resumed.
- When you watch the TV from the cable box or the VCR with the RF Modulator, then you release the V-Chip temporarily, the V-Chip setting will not be resumed until you turn off the TV. The TV channel is not used in this case.
- When changing the channel with the cable box or the VCR, approximately 10 seconds will pass until the program appears.

CLOSED CAPTION

WHAT IS CLOSED CAPTIONING?

This television has the capability to decode and display Closed Captioned television programs. Closed Captioning will display text on the screen for hearing impaired viewers or it will translate and display text in another language.

TO VIEW CLOSED CAPTIONS

Press the TV/CAP/TEXT button on the remote control to switch between normal TV and the two Closed Caption Modes (Captions and 1/2 of Full Screen Text).

Captions: This Closed Caption Mode will display text on the screen in English or another language (depending on the setting of the Closed Captions CH. 1/2 button). Generally, Closed Captions in English are transmitted on Captions Channel 1 and Closed Captions in other languages are transmitted on Captions Channel 2.

Text: The Text Closed Caption Mode will usually fill 1/2 of full screen with a programming schedule or other information. After selecting a Closed Caption Mode, it will stay in effect until it is changed, even if the channel is changed. If the Captions signal is lost due to a commercial or a break in the signal, the Captions will reappear when the signal is received again. If the channels are changed, the Captions will be delayed approximately 10 seconds.

The Captions will appear in places on the screen where they will least interfere with the picture, usually on the bottom of the screen. News programs will usually show three-line Closed Captions which scroll onto the screen. Most other shows provide two or three lined Captions placed near the character who is speaking so the viewer can follow the dialogue. Words in italics or underlined describe titles, words in foreign languages or words requiring emphasis. Words that are sung usually appear enclosed by musical notes. For television programs broadcasting with Closed Captions, look in your TV guide for the Closed Captions symbol (CC).

- When activating the Closed Captioned Decoder, there will be a short delay before the Closed Captioned text appears on the screen.
- Closed Captioned text is only displayed in locations where it is available.
- If no caption signal is received, no captions will appear, but the television will remain in the Caption Mode.
- Misspellings or unusual characters may occasionally appear during Closed Captioning. This is normal with Closed Captioning, especially with live programs. This is because during live programs, captions are also entered live. These transmissions do not allow time for editing.
- When Captions are being displayed, on-screen displays, such as volume and mute may not be seen or may interfere with Closed Captions.
- Some cable systems and copy protection systems may interfere with the Closed Captioned signal.
- If using an indoor antenna or if TV reception is very poor, the Closed Caption Decoder may not appear or may appear with strange characters or misspelled words. In this case, adjust the antenna for better reception or use an outdoor antenna.





STEREO AND SEPARATE AUDIO PROGRAM (SAP)

The TV is equipped with a feature known as Multi-channel TV Sound or MTS. MTS broadcasts greatly enhance TV viewing by bringing you programs with high fidelity stereo sound. MTS also provides an extra channel called the Separate Audio Program or SAP which broadcasters can use to transmit a second language for bilingual transmission or for other purposes.

LISTENING TO STEREO SOUND

When the TV is turned on or a channel selection is made, make certain the STEREO is appeared on the screen. This means that "Stereo" broadcasting is available. You can enjoy stereo sound from the left and right speakers.

- When the "Mono" broadcasting is received, no indication is displayed.
- If the broadcast signal is not strong enough or clear stereo sound is not available, press the AUDIO SELECT button to change to mono sound. The noise should be eliminated. Press it again to return to the stereo sound.

LISTENING TO SAP (SEPARATE AUDIO PROGRAM)

When the TV is turned on or a channel selection is made, make certain the SAP is appeared on the screen. This means that the "Separate Audio Program" broadcasting is available.

TO SELECT DESIRED SOUND

Press the AUDIO SELECT button to select the desired sound.

MONO+SAP BROADCASTING

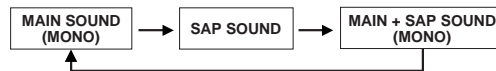

STEREO+SAP BROADCASTING

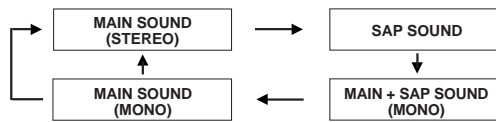

SOUND ADJUSTMENTS

Sound controls are factory preset but you can adjust them individually as follows:

To display sound adjustments on the screen, press the MENU button. Press the SET + or - button to select the AUDIO option, then press the ENTER button.

BASS

Press the ENTER button until "BASS" appears on the screen, then press the SET + or - button to adjust the bass sound.

TREBLE

Press the ENTER button until "TREBLE" appears on the screen, then press the SET + or - button to adjust the treble sound.

BALANCE

Press the ENTER button until "BALANCE" appears on the screen, then press the SET + or - button to obtain an equal sound level from both speakers.

RESET

Pressing the RESET button while making sound adjustments will return all adjustments to the factory preset levels.

NOTE: The on-screen display will disappear 6 seconds after finishing an adjustment or by pressing the CALL button. The settings can only be adjusted when they are displayed on the TV screen.

ADJUSTING PICTURE

You can adjust the settings for color, sharpness, contrast, brightness and tint.

- 1 Press the MENU button.
- 2 Press the SET + or - button until the indicator next to "PICTURE" begins to flash, then press the ENTER button.
- 3 Press the ENTER button repeatedly to select the item you want to adjust.

BRIGHTNESS → CONTRAST → COLOR → TINT → SHARPNESS
↑

- 4 Press the SET + or - button to adjust the setting.

	+	-
BRIGHTNESS	increase brightness	decrease brightness
CONTRAST	increase contrast	decrease contrast
COLOR	be brilliant color	be pale color
TINT	be greenish color	be reddish color
SHARPNESS	makes picture clearer	makes picture softer

TO RETURN TO INITIAL SETTING

Press the RESET button while the picture adjusting mode appears on-screen.



TROUBLESHOOTING GUIDE

Before requesting service, please refer to the following chart for the symptom and possible solution.

SYMPTOMS	POSSIBLE SOLUTIONS
TV does not operate	<ul style="list-style-type: none"> • Make sure the power cord is plugged in. • Try another AC outlet. • Power is off, check fuse or circuit breaker. • Unplug unit for an hour, then plug it back in.
Poor sound or No sound	<ul style="list-style-type: none"> • Station or CATV experiencing problems, tune to another station. • Check sound adjustments (Volume and Muting). • Check for sources of possible interference.
Poor picture or No picture	<ul style="list-style-type: none"> • Station or CATV experiencing problems, tune to another station. • Check antenna or CATV connections, reorient antenna. • Check for sources of possible interference. • Check picture control adjustments.
Poor reception on some channels	<ul style="list-style-type: none"> • Station or CATV experiencing problems, tune to another station. • Station signal is weak, reorient antenna to receive weaker station. • Check for sources of possible interference.
Poor color or no color	<ul style="list-style-type: none"> • Station or CATV experiencing problems, tune to another station. • Make sure channels are set into memory. • Check picture control adjustments. • Check antenna or CATV connections, reorient antenna. • Check for sources of possible interference.
Picture wobbles or drifts	<ul style="list-style-type: none"> • Station or CATV experiencing problems, tune to another station. • Make sure channels are set into memory. • CATV company is scrambling signal. • Check antenna orientation.

SYMPTOMS	POSSIBLE SOLUTIONS
No CATV reception	<ul style="list-style-type: none"> • Check all CATV connections. • Set TV/CATV menu option to the CATV mode. • Station or CATV system problems, try another station.
Horizontal or diagonal bars on screen	<ul style="list-style-type: none"> • Check antenna connections, reorient antenna. • Check for sources of possible interference.
No reception above channel 13	<ul style="list-style-type: none"> • Make sure TV/CATV menu option is in the appropriate mode. • If using antenna, check UHF antenna connections.
No Remote operation	<ul style="list-style-type: none"> • Batteries are weak, dead or inserted incorrectly. • Remote is out of range, move closer to TV within 15 feet. • Make sure Remote is aimed at sensor. • Confirm there are no obstructions between the Remote and the TV. • Make sure the power cord is plugged in.
TV shuts off	<ul style="list-style-type: none"> • No broadcast on station tuned. • Sleep Timer is set. • Power interrupted.
Closed - Caption is not activated.	<ul style="list-style-type: none"> • TV station experiencing problems or program tuned is not closed captioned. Try another channel. • Check CATV connection or VHF/UHF antenna, reposition or rotate antenna. • Press TV/CAPTION/TEXT button to turn on the closed caption decoder.
Display is not shown in your language.	<ul style="list-style-type: none"> • Select proper language in the menu options.

ENGLISH

SPECIFICATIONS

AC Power Input: 120 V, 60 Hz
 AC Power Consumption: 95W
 Chassis Construction: IC Solid state
 Picture Tube: 20" (measured diagonally)
 Audio Power Output Rating: 2.5 + 2.5 W
 Speaker: 6-1/3" x 2-1/4" Full Range, 32 ohm x 2
 Tuner Type: 181 Channel, Quartz PLL Frequency Synthesized
 Remote Control: 2 x AAA batteries (not included)

Receiving Channels:
 VHF 2-13
 UHF 14-69
 CATV 01-97 (5A)-(A-3)
 98-99 (A-2)-(A-1)
 14-22 (A)-(I)
 23-36 (J)-(W)
 37-65 (AA)-(FFF)
 66-125 (GGG)-(125)
 Antenna Input Impedance: 75 ohm (VHF/UHF/CATV)
 Coaxial Input
 Dimensions: 23-5/8" (W) x 17-9/16" (H) x 18-7/8" (D)
 Weight: 46.3 lbs

ACCESSORY: Remote Control





LIMITED WARRANTY

Memcorp Canada, warrants this product to be free from manufacturing defects in material and workmanship under normal use and conditions for a designated period from date of original purchase in Canada as follows: (Unless otherwise specified)

WARRANTY:

- COLOUR TV's BELOW 25":
2 Years Parts, 90 Days Labour,
4 Years Picture Tube
- COLOUR TV's 25" and above:
1 Year Parts, Labour,
4 Years Picture Tube
- ALL TV/VCR AND TV/VCR COMBINATION:
1 Year Parts (6 Months Video Heads),
90 Days Labour, 4 Years Picture Tube
- ALL VCR's AND VCP's:
1 Year Parts (6 Months Video Heads),
90 Days Labour

Should service be necessary under this warranty for any reason due to manufacturing defect during the warranty period, Memcorp Canada will repair or replace (at its discretion) the defective merchandise at no charge.

THIS UNIT CAN BE REPAIRED ONLY AT THE MEMCOPR CANADA SERVICE CENTERS OR AT THE AUTHORIZED SERVICE DEPOTS (THE ADDRESS OF THE NEAREST DEPOT IS AVAILABLE BY CALLING 905-940-0560).

NOTE: This warranty is void if the product is:

- (a) Damaged through negligence, misuse, abuse, or accident.
- (b) Used in a commercial application or rentals.
- (c) Modified or repaired by anyone other than Memcorp Canada Service Centers or the authorized Service Depots.
- (d) Damage caused by improper connection to other equipment.
- (e) If the original proof of purchase cannot be supplied.

NOTE: This warranty does not cover:

- (a) Damage to the tape or tape cartridge (if applicable).
- (b) Cleaning of video heads (if applicable).
- (c) Damage occurred or costs incurred in the shipping of the product to Memcorp Canada Service Centers or the authorized Service Depots.
- (d) Ordinary adjustments to the product which can be performed by customer as outlined in the owner's manual.
- (e) Signal reception problems caused by external antenna, cable systems or interference.
- (f) Incompatibility due to the change in TV/CATV broadcast systems after the product was sold.

THIS WARRANTY IS NON-TRANSFERABLE AND APPLIES ONLY TO THE ORIGINAL PURCHASER AND DOES NOT EXTEND TO SUBSEQUENT OWNERS OF THE PRODUCT. ANY APPLICABLE IMPLIED WARRANTIES, INCLUDING THE WARRANTY OF MERCHANTABILITY, ARE LIMITED IN DURATION TO A PERIOD OF THE EXPRESSED WARRANTY AS PROVIDED HEREIN BEGINNING WITH THE DATE OF ORIGINAL PURCHASE AT RETAIL AND NO WARRANTIES, WHETHER EXPRESSED OR IMPLIED, SHALL APPLY TO THIS PRODUCT THEREAFTER.

UNDER NO CIRCUMSTANCES SHALL MEMCOPR CANADA BE LIABLE FOR ANY LOSS, DIRECT, INDIRECT, INCIDENTAL, SPECIAL, OR CONSEQUENTIAL DAMAGE ARISING OUT OF, OR IN CONNECTION WITH THE USE OF THIS PRODUCT.

THIS WARRANTY IS VALID ONLY FOR PRODUCTS SOLD AND DISTRIBUTED THROUGH MEMCOPR CANADA (AND ITS DEALER NETWORKS).

MEMCOPR CANADA
106 FERRIER ST.
MARKHAM, ONTARIO L3R2Z5
(905) 940-0560

Free Manuals Download Website

<http://myh66.com>

<http://usermanuals.us>

<http://www.somanuals.com>

<http://www.4manuals.cc>

<http://www.manual-lib.com>

<http://www.404manual.com>

<http://www.luxmanual.com>

<http://aubethermostatmanual.com>

Golf course search by state

<http://golfingnear.com>

Email search by domain

<http://emailbydomain.com>

Auto manuals search

<http://auto.somanuals.com>

TV manuals search

<http://tv.somanuals.com>