

Memorex®

Is it live or is it Memorex?™

MD6441

User's Guide

*PERSONAL AM/FM STEREO COMPACT
DISC PLAYER WITH 45 SECOND
DIGITAL ANTI-SHOCK PROTECTION*

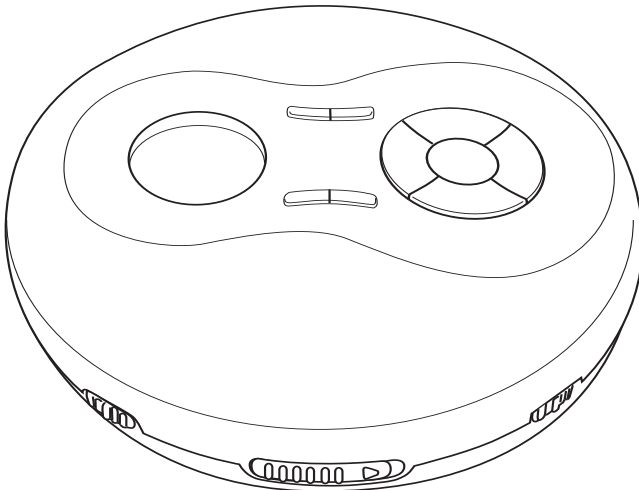

**Before operating this product,
please read these instructions completely.**

SAFETY PRECAUTIONS



CAUTION
RISK OF ELECTRIC SHOCK
DO NOT OPEN



CAUTION: TO REDUCE THE RISK OF ELECTRIC SHOCK, DO NOT REMOVE COVER (OR BACK). NO USER-SERVICEABLE PARTS INSIDE. REFER SERVICING TO QUALIFIED SERVICE PERSONNEL.



DANGEROUS VOLTAGE:

The lightning flash with arrowhead symbol within an equilateral triangle is intended to alert the user to the presence of uninsulated dangerous voltage within the product's enclosure that may be of sufficient magnitude to constitute a risk of electric shock to persons.



ATTENTION:

The exclamation point within an equilateral triangle is intended to alert the user to the presence of important operating and maintenance (servicing) instructions in the literature accompanying the appliance.

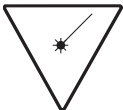

DANGER:

This product utilizes a Class 1 laser to read Compact Discs. This laser Compact Disc Player is equipped with safety switches to avoid exposure when the CD door is open and the safety interlocks are defeated. Invisible and hazardous laser radiation when open and interlock failed or defeated. Avoid direct exposure to beam. Please do not attempt to defeat or bypass the safety switches.

FCC WARNING:

This equipment may generate or use radio frequency energy. Changes or modifications to this equipment may cause harmful interference unless the modifications are expressly approved in the instruction manual. The user could lose the authority to operate this equipment if an unauthorized change or modification is made.

SURGE PROTECTORS:

It is recommended to use a surge protector for AC connection. Lightning and power surges ARE NOT covered under warranty for this product.

SAFETY PRECAUTIONS (CONTINUED)

INFORMATION:

This equipment has been tested and found to comply with the limits for a Class B digital device, pursuant to Part 15 of the FCC Rules. These limits are designed to provide reasonable protection against harmful interference in a residential installation. This equipment generates, uses and can radiate radio frequency energy and, if not installed and used in accordance with the instructions, may cause harmful interference to radio communications. However, there is no guarantee that interference will not occur in a particular installation. If this equipment does cause harmful interference to radio or television reception, which can be determined by turning the equipment off and on, the user is encouraged to try to correct the interference by one or more of the following measures:

- Reorient or relocate the receiving antenna.
- Increase the separation between the equipment and receiver.
- Connect the equipment into an outlet on a circuit different from that to which the receiver is connected.
- Consult the dealer or an experienced radio/TV technician for help.

- Do not open the CD compartment while the CD is rotating.
- Always keep the CD compartment closed when not in use.
- Keep all foreign objects out of the CD compartment.
- Place the unit on a stable surface.
- Avoid installing the unit in locations described below:
 - Places exposed to direct sunlight or close to heat radiating appliances such as electric heaters.
 - On top of other stereo equipment that radiates too much heat.
 - Places lacking ventilation or dusty places.
 - Places subject to constant vibration.
 - Humid or moist places.

Dear Customer:

Selecting fine audio equipment such as the unit you've just purchased is only the start of your musical enjoyment. Now it's time to consider how you can maximize the fun and excitement your equipment offers. This manufacturer and the Electronic Industries Association's Consumer Electronics Group want you to get the most out of your equipment by playing it at a safe level. One that lets the sound come through loud and clear without annoying blaring or distortion and, most importantly, without affecting your sensitive hearing. Sound can be deceiving. Over time your hearing "comfort level" adapts to higher volumes of sound. So what sounds "normal" can actually be loud and harmful to your hearing. Guard against this by setting your equipment at a safe level BEFORE your hearing adapts.

To establish a safe level:

- Start your volume control at a low setting.
- Slowly increase the sound until you can hear it comfortably and clearly, and without distortion.

Once you have established a comfortable sound level:

- Set the dial and leave it there.

Taking a minute to do this now will help to prevent hearing damage or loss in the future. After all, we want you listening for a lifetime.

We Want You Listening For A Lifetime

Used wisely, your new sound equipment will provide a lifetime of fun and enjoyment. Since hearing damage from loud noise is often undetectable until it is too late, this manufacturer and the Electronic Industries Association's Consumer Electronics Group recommend you avoid prolonged exposure to excessive noise. This list of sound levels is included for your protection.

Decibel

<u>Level</u>	<u>Example</u>
30	Quiet library, soft whispers
40	Living room, refrigerator, bedroom away from traffic
50	Light traffic, normal conversation, quiet office
60	Air conditioner at 20 feet, sewing machine
70	Vacuum cleaner, hair dryer, noisy restaurant
80	Average city traffic, garbage disposals, alarm clock at two feet

THE FOLLOWING NOISES CAN BE DANGEROUS UNDER CONSTANT EXPOSURE:

90	Subway, motorcycle, truck traffic, lawn mower
100	Garbage truck, chain saw, pneumatic drill
120	Rock band concert in front of speakers, thunderclap
140	Gunshot blast, jet engine
180	Rocket launching pad



Information courtesy of the Deafness Research Foundation.

LOCATION OF CONTROLS

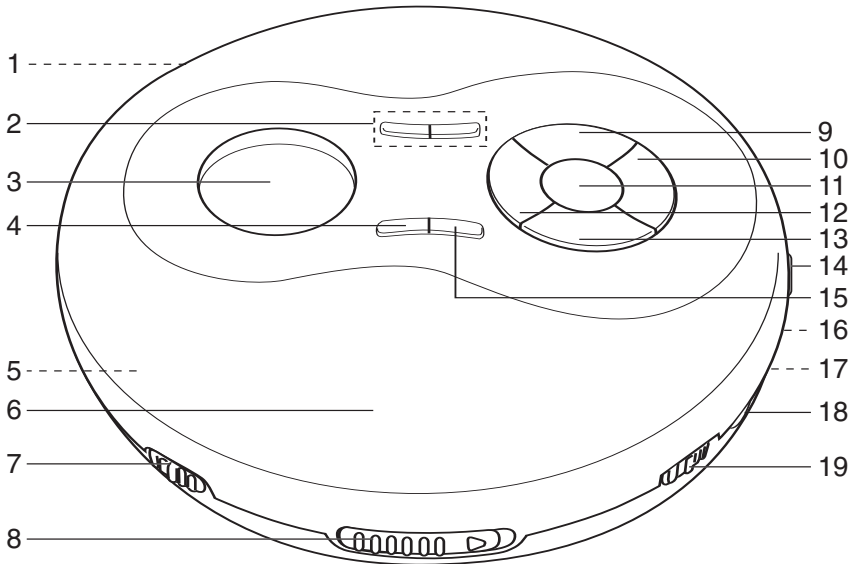

1. DC 4.5V Jack (Rear of Unit)



2. PRESET Down/Up Buttons

3. Display

4. PROG (Program) Button

5. Battery Compartment (Under CD Compartment)

6. CD Compartment

7. FUNCTION (CD/RADIO) Switch

8. CD OPEN Switch

9. MODE Button

10. Skip/Search/Tuning >>> Button

11. PLAY/PAUSE (>>||)/POWER ON Button

12. Skip/Search/Tuning <<< Button

13. STOP (■)/POWER OFF Button

14. HOLD (ON/OFF) Switch

15. ESP/BAND Button

16. LINE OUT Jack (Side of Unit)

17. PHONES (Headphones) Jack (Side of Unit)

18. VOLUME Control

19. DBBS (Bass Boost) Switch

POWER SOURCES

This CD player requires either two (2) “AA” cell batteries (not included) or an AC adapter (not included).

BATTERY INSTALLATION

The battery indicator () will appear in the CD display when the batteries need replacing.

1. Open the CD compartment, then open the battery compartment door by pressing in on the tab and then lifting it. **To prevent the possibility of losing the cover, it cannot be removed.**
2. Insert two (2) “AA” cell batteries (not included) according to the polarity diagram inside the battery compartment. Alkaline batteries are recommended for the longest playing time.

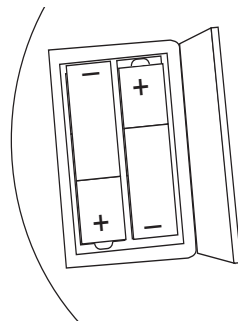

BATTERY PRECAUTIONS

Follow these precautions when using batteries in this device:

1. Use only the size and type of batteries specified.
2. Be sure to follow the correct polarity when installing the batteries as indicated next to the battery compartment. Reversed batteries may cause damage to the device.
3. Do not mix different types of batteries together (e.g. Alkaline, Carbon-zinc and rechargeable) or old batteries with fresh ones.
4. If the device is not to be used for a long period of time, remove the batteries to prevent damage or injury from possible battery leakage.
5. Do not try to recharge batteries not intended to be recharged; they can overheat and rupture. (Follow battery manufacturer's directions.)

AC OPERATION

To operate the unit using AC power, connect an AC adapter (not included) to an AC outlet having 120V, 60Hz AC only. Plug the small end into the DC 4.5V jack on the rear of the unit and connect the other end into the AC outlet. The batteries are automatically disconnected when the AC adapter is used.

CAUTION: When not using AC power, disconnect the AC adapter from the wall outlet by pulling the plug (not the cord). Do not touch the AC adapter with wet hands. Fully insert the plug without exposing any part of the blade.

DC4.5V 

OPERATION

BASS BOOST

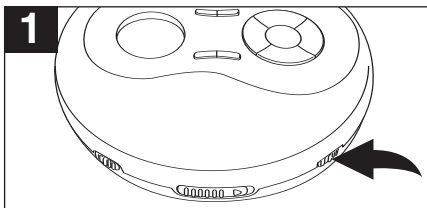

To emphasize the bass, slide the DBBS switch to the ON position. For normal bass, slide the DBBS switch to the OFF position.

TURNING POWER ON/OFF

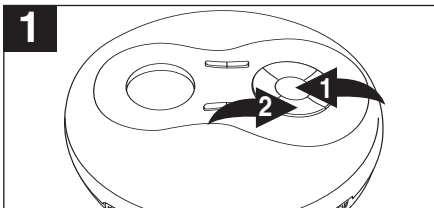

To turn the unit on, press the PLAY/PAUSE (▶||)/POWER ON button ❶.

To turn the unit off, Press the STOP (■)/POWER OFF button ❷ while in the Stop mode.

HOLD



Slide to the ON position to disable the buttons; "Hold" will briefly appear in the display. When pressing the buttons on the CD compartment lid, "Hold" will briefly appear in the display. Slide to the OFF position to enable the buttons. For the HOLD function, only the buttons on the CD compartment lid will be disabled, not the other controls/switches.

AUTO POWER OFF

When the unit is stopped (Standby mode) for approximately one minute, the power will automatically turn off.

Radio Sound Through a Home Audio System

By using a home audio connection cable (not included), superb radio sound can be heard through your home audio system. Before making any connections, turn off the power to all equipment.

Plug a connection cable (not included) between the LINE OUT jack on the rear of the CD player and the amplifier's AUX or CD input jack. (Do not connect it to the amplifier's PHONO jack.)

NOTE: If the radio interferes with TV reception, move the unit away from the TV or turn off the power to this unit.

RADIO OPERATION

TO LISTEN TO THE RADIO

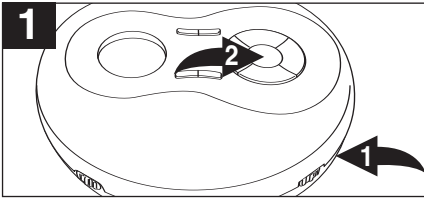

Set the VOLUME control ❶ to minimum and plug the headphones into the PHONES jack. Press the PLAY/PAUSE (▶||) / POWER ON button ❷ to turn the unit on.

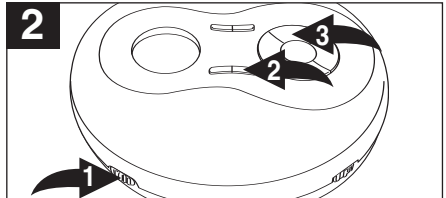

Slide the FUNCTION switch ❶ to the RADIO position. Press the ESP/BAND button ❷ to select a band (AM or FM). If listening to FM, press the MODE button ❸ to turn FM Stereo ON or OFF.

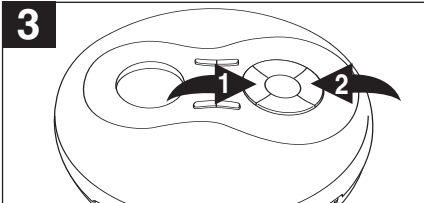

Press and release the Skip/Search/Tuning ◀ ❶ or ▶ ❷ button to tune a station. Press and hold the Skip/Search/Tuning ◀ ❶ or ▶ ❷ button for Auto Scan (see below).

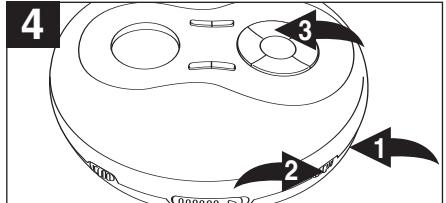

Adjust the VOLUME control ❶ and DBBS switch ❷ as desired. If FM STEREO reception is weak/noisy, press the MODE button ❸ to turn off Stereo, in this case the reception will be monaural.

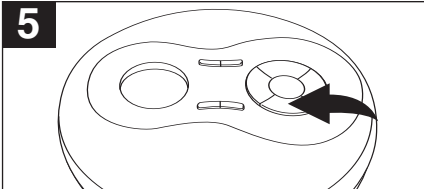

To turn the radio off, press the STOP (■) / POWER OFF button.

ANTENNAS

AM—This unit has a built-in ferrite bar antenna, which provides adequate reception in most areas. If reception is weak, turn the unit to improve reception.

FM—The headphones act as an antenna for FM. Extend the headphone wire for best FM reception.

AUTO SCAN

Press and hold the Skip/Search/Tuning ◀ or ▶ button for approximately one second and the unit will automatically search for the next available station.

RADIO OPERATION (CONTINUED)

TO SET AND RECEIVE A STATION INTO MEMORY

You can set up to 10 AM and 10 FM stations into memory as follows:

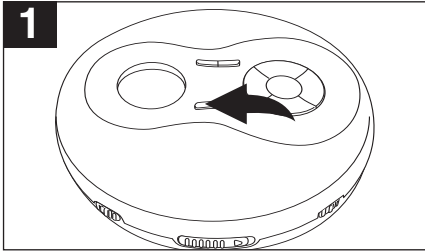

Tune a desired station as described in the previous section. Press the PROG button; the PROG indicator will blink and preset number will appear in the display.

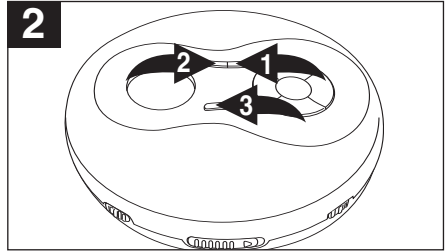

While the PROG indicator is blinking, select the desired preset using the PRESET UP ❶ or DOWN ❷ button, then press the PROG button ❸ to set the memory.

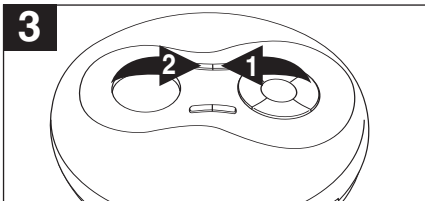

To recall a preset station, simply press the PRESET UP ❶ or DOWN ❷ button to select the desired preset.

CD OPERATION

TO PLAY A CD (Standard, CD-R and CD-RW)

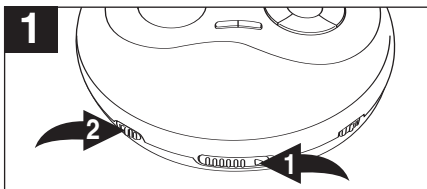

Open the CD compartment lid by sliding the CD OPEN switch ❶ to the right. Gently press a disc, label side up, onto the spindle until it locks in place. Close the CD compartment lid. Insert headphones into the PHONES jack. Slide the FUNCTION switch ❷ to the CD position.

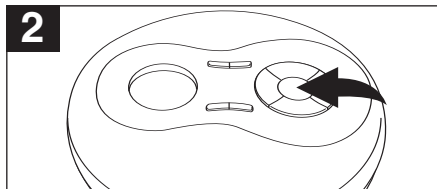

Press the PLAY/PAUSE (▶||)/POWER ON button to start playback. **To pause PLAYBACK**, press the PLAY/PAUSE (▶||)/POWER ON button again, the elapsed time will blink. Press once again to resume playback.

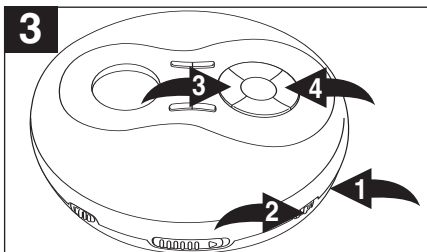

Adjust the VOLUME control ❶ and DBBS switch ❷ as desired. To **skip** forward or backward through the tracks on the disc, press the SKIP/SEARCH ◀❸ or ▶❹ button. To **search** forward or backward through the tracks on the disc, press and hold the SKIP/SEARCH ◀❸ or ▶❹ button.

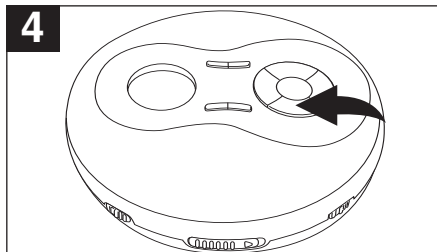

When the disc is through playing, it will stop. Press the STOP (■)/POWER OFF button to stop the disc before it is finished; the total number of tracks will appear. Press the STOP (■)/POWER OFF button again while in the stop mode to turn the unit off or wait approximately 60 seconds and the unit will automatically turn off.

CD OPERATION (CONTINUED)

NOTES:

- This unit is capable of playing standard CDs or 3" singles; no adapter is required.
- If a disc is inserted incorrectly, dirty, damaged or not present at all, the display will show "no disc".
- As each track is played, the track number and elapsed time are shown in the display.
- To remove the disc, open the CD compartment, hold the edge of the CD and gently press the center pivot and lift the CD.
- The maximum play time for a CD in this unit is 74 minutes.
- "OPEN" will appear in the display when the CD door is open.

45 SECONDS ANTI-SHOCK SYSTEM

This CD player has a built-in Anti-Shock System that cuts down on CD skipping. Follow the steps below to activate and understand the Anti-Shock System.

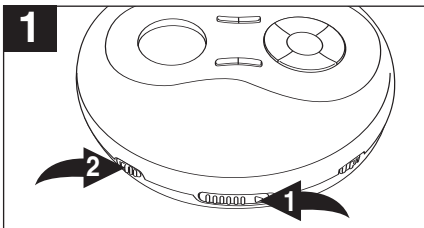

Open the CD compartment lid by sliding the CD OPEN switch ❶ to the right. Gently press a disc, label side up, onto the spindle until it locks in place. Close the CD compartment lid. Insert headphones into the PHONES jack. Slide the FUNCTION switch ❷ to the CD position.

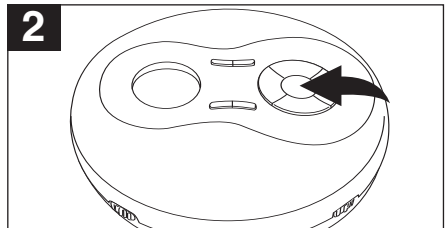

With a CD inserted, press the PLAY/PAUSE (▶||)/POWER ON button to turn the unit on. The Anti-Shock System will start automatically. Within a few seconds, the Anti-Shock indicators (dots below "ESP") will fill to indicate music signals are stored in memory.

CONTINUED ON THE NEXT PAGE

CD OPERATION (CONTINUED)

3



When the memory is full, the fifth dot (at the right side of the display) will blink and the disc rotation speed will drop to save power consumption.

4

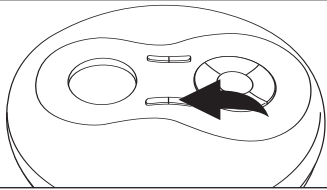

To turn the Anti-Shock System off, press the ESP/BAND button. To turn the Anti-Shock System on, press the ESP/BAND button again.

NOTES:

- When the CD player is used in a stable location, turn the Anti-Shock System off by pressing the ESP/BAND button. When the Anti-Shock System is Off, battery consumption is less.
- The Anti-Shock System provides for continuous sound output when unit is subject to vibration, but it will not correct errors, such as a defective or dirty CD.
- If all the dots disappear and the CD player is subject to immediate vibration, the unit may skip.
- If the CD player is subject to vibration during playback, the dots will disappear one by one. During the vibration, the music should continue to play the signals stored in the memory until the CD player can read the music data properly from the disc. At this time, the indicator will probably show fewer dots indicating the music signals stored in memory are low.

CD OPERATION (CONTINUED)

TO REPEATEDLY PLAY BACK ONE TRACK

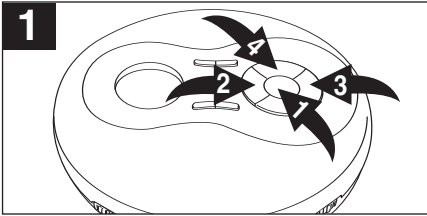

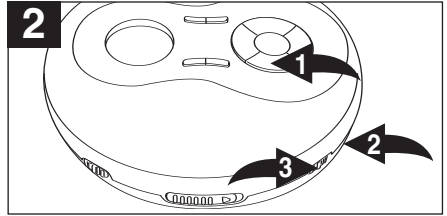

With a CD inserted, press the PLAY/PAUSE (▶||)/POWER ON button ❶ to turn the unit on, then select a track using the Skip/Search ◀◀ ❷ or ▶▶ ❸ button. Press the MODE button ❹ once; the Repeat 1 indicator  will appear in the display.

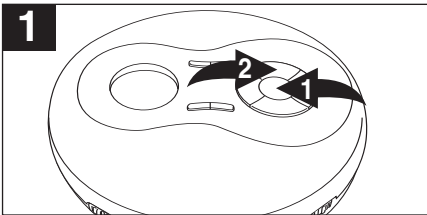

The unit will then play the same track over and over until the STOP (■)/POWER OFF button ❶ is pressed. Adjust the VOLUME control ❷ and DBBS switch ❸ as desired.

TO REPEATEDLY PLAY BACK ALL TRACKS



With a CD inserted, press the PLAY/PAUSE (▶||)/POWER ON button ❶ to turn the unit on. Press the MODE button ❷ twice; the Repeat All indicator  will appear in the display.

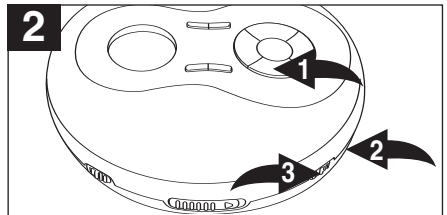

The unit will then play all the tracks on the CD over and over until the STOP (■)/POWER OFF button ❶ is pressed. Adjust the VOLUME control ❷ and DBBS switch ❸ as desired.

TO CANCEL OR STOP REPEAT PLAYBACK

- **TO STOP REPEAT PLAYBACK**, press the STOP (■)/POWER OFF button once.
- **TO CANCEL REPEAT PLAYBACK**, press the MODE button four times if in Repeat 1 mode, or three times if in Repeat All mode. The unit will continue normal playback.

CD OPERATION (CONTINUED)

INTRO PLAY

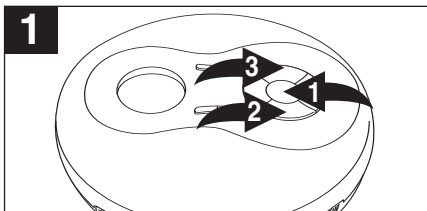

With a CD inserted, press the PLAY/PAUSE (▶||)/POWER ON button ❶ to turn the unit on and press the STOP (■)/POWER OFF button ❷ to stop auto playback. Press the MODE button ❸ three times; the INTRO indicator will blink in the display.

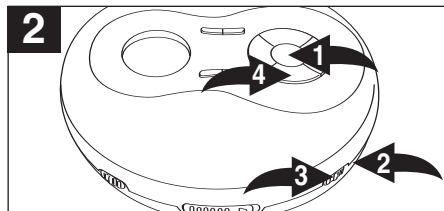

Press the PLAY/PAUSE (▶||)/POWER ON button ❶ to begin playback. The unit will play the first 10 seconds of each track. Adjust the VOLUME control ❷ and DBBS switch ❹ as desired. Press the STOP (■)/POWER OFF button ❷ to stop Intro playback.

TO CANCEL Intro Play, press the Mode button twice.

TO RANDOMLY PLAY BACK A CD

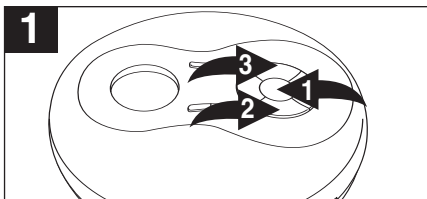

With a CD inserted, press the PLAY/PAUSE (▶||)/POWER ON button ❶ to turn the unit on and press the STOP (■)/POWER OFF button ❷ to stop auto playback. Press the MODE button ❸ four times; the RANDOM indicator will blink in the display.

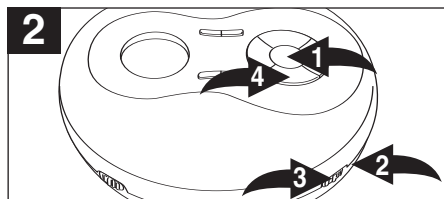

Press the PLAY/PAUSE (▶||)/POWER ON button ❶ to begin playback. The unit will play all the tracks in random order. Adjust the VOLUME control ❷ and DBBS switch ❹ as desired. When all the tracks have been played, the unit will stop. Press the STOP (■)/POWER OFF button ❷ to stop Random playback.

TO CANCEL Random Play, press the MODE button once.

CD OPERATION (CONTINUED)

TO PROGRAM THE MEMORY (UP TO 24 TRACKS)

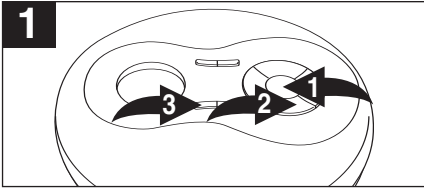

With a CD inserted, press the PLAY/PAUSE (▶||)/POWER ON button ❶ to turn the unit on and press the STOP (■)/POWER OFF button ❷ to stop auto playback. Press the PROG button ❸; the Track (00), program number (P-01) and PROG indicator will appear in the CD display.

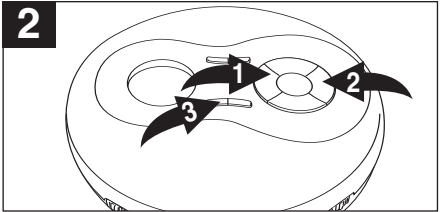

Select the first track to be played back using the Skip/Search ◀❶ or ▶❷ button, then press the PROG button ❸ again. Repeat this step to program additional tracks up to a maximum of 24 tracks.

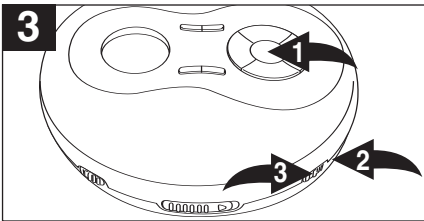

Press the PLAY/PAUSE (▶||)/POWER ON button ❶ to begin Programmed playback and adjust the VOLUME control ❷ and DBBS switch ❸ as desired.

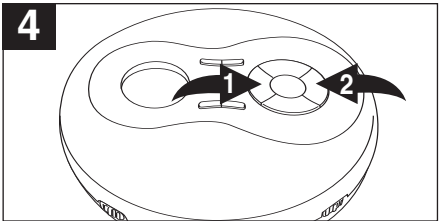

To skip forward or backward through the programs, press the Skip/Search ◀❶ or ▶❷ button. When the disc is through playing, it will stop.

NOTES:

- Press the STOP (■)/POWER OFF button to stop the disc before it is finished.
- As each program is played, the track number is shown in the display.
- To clear the memorized program, while in the stop mode, press the PROG button followed by the STOP (■)/POWER OFF button.
- Programming is the ability to preselect the order in which a series of tracks will be played.
- Each track may be stored in the program memory as many times as desired (up to 24 tracks).
- If the unit is off or the CD compartment is opened, the memorized program will be erased.

CARE AND MAINTENANCE

Caring for Compact Discs

- Treat the compact disc carefully. Handle the compact disc only by its edges. Never allow your fingers to come in contact with the shiny, unprinted side of the compact disc.
- Do not attach adhesive tape, stickers, etc. to the compact disc label.
- Clean the compact disc periodically with a soft, lint-free, dry cloth. Never use detergents or abrasive cleaners to clean the compact disc. If necessary, use a CD cleaning kit.
- If a compact disc skips or gets stuck on a section of the disc, it is probably dirty or damaged (scratched).
- When cleaning the compact disc, wipe in straight lines from the center of the compact disc to the outer edge of the compact disc. Never wipe in circular motions.

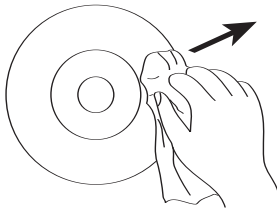
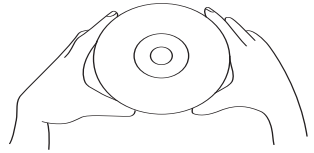

- This unit is designed to play only compact discs bearing the identification logo as shown here. Other compact discs may not conform to the CD standard and may not play properly.
- Compact discs should be stored in their cases after each use to avoid damage.
- Do not expose compact discs to direct sunlight, high humidity, high temperatures or dust, etc. Prolonged exposure or extreme temperatures can warp the compact disc.
- Do not stick or write anything on either side of the compact disc. Sharp writing instruments, or the ink, may damage the surface.



Cleaning the Unit

- To prevent fire or shock hazard, disconnect your unit from the AC power source when cleaning.
- The finish on your unit may be cleaned with a dust cloth and cared for as other furniture. Use caution when cleaning and wiping the plastic parts.
- Mild soap and a damp cloth may be used on the front panel.

TROUBLESHOOTING GUIDE

If you experience a problem with this unit, check the chart below before calling for service.

SYMPTOM	CAUSE	SOLUTION
Unit will not turn on.	Batteries inserted incorrectly.	Insert batteries correctly.
	Weak or dead batteries.	Replace batteries.
	AC adapter not connected.	Check AC adapter connection.
Disc will not play.	CD compartment not closed.	Close CD compartment.
	Disc inserted incorrectly.	Reinsert disc correctly.
	Dirty or defective disc.	Try another disc.
	Moisture condensation on disc.	Wipe disc with soft cloth.
Erratic CD playback.	Dirty or defective disc.	Clean or replace disc.
No sound from headphones.	Headphone plug not inserted correctly.	Reinsert headphone plug correctly.
	VOLUME control set to minimum.	Increase volume.
	Defective disc.	Try another disc.
ESP not working.	ESP is not activated.	Press the ESP/BAND button.
Noise or sound distorted on radio.	Station not tuned properly for AM or FM.	Retune AM or FM broadcast station.
	FM: Headphone wire not extended.	Extend Headphone wire.
	AM: Unit is not positioned correctly.	Rotate unit until best reception is obtained.
FM STEREO indicator does not light.	Poor FM signal.	Retune station.
	MODE button not set to Stereo.	Press MODE button to turn Stereo on.
No sound.	FUNCTION switch is not in the desired position.	Set FUNCTION switch to the desired position.

SPECIFICATIONS

Power requirements.....	2 x LR6 "AA" alkaline battery DC in 4.5V adapter (center positive)
Frequency Range (FM)	87.5 ~ 108 MHz
Frequency Range (AM)	530 ~ 1720 KHz
D/A conversion	1-bit DAC eight times oversampling
Frequency response	20~20,000Hz (+1,-3 dB)
Anti-shock.	45 second buffer
Output level.	Line output: 0.6 Vms (47K ohms) Headphones: 16mW (32 ohms)

FOR ADDITIONAL SET-UP OR OPERATING ASSISTANCE, PLEASE VISIT OUR WEBSITE AT

WWW.MEMOREXELECTRONICS.COM

OR CONTACT CUSTOMER SERVICE AT (954) 660-7100.

PLEASE KEEP ALL PACKAGING MATERIAL FOR AT LEAST 90 DAYS IN CASE YOU NEED TO RETURN THIS PRODUCT TO YOUR PLACE OF PURCHASE OR MEMOREX.

FOR PARTS AND ACCESSORIES, CONTACT FOX INTERNATIONAL AT 1-800-321-6993.

Memcorp, Inc.
Weston, FL
Printed in Hong Kong

Visit our website at www.memorexelectronics.com

Free Manuals Download Website

<http://myh66.com>

<http://usermanuals.us>

<http://www.somanuals.com>

<http://www.4manuals.cc>

<http://www.manual-lib.com>

<http://www.404manual.com>

<http://www.luxmanual.com>

<http://aubethermostatmanual.com>

Golf course search by state

<http://golfingnear.com>

Email search by domain

<http://emailbydomain.com>

Auto manuals search

<http://auto.somanuals.com>

TV manuals search

<http://tv.somanuals.com>