

1

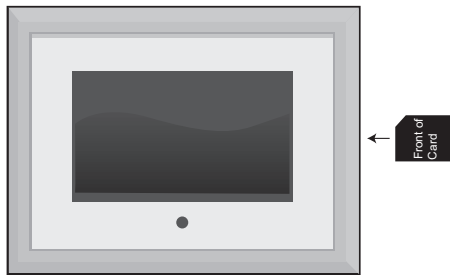

Insert external memory card into the Card Slot located at the right side of the unit.

Introduzca la tarjeta de memoria externa en la ranura para tarjeta ubicada en la parte derecha de la unidad.

Insérez la carte mémoire externe dans l'emplacement pour carte sur le côté droit de l'appareil.

2

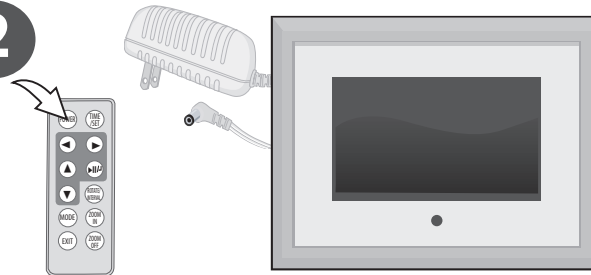

Plug frame in and press the press the POWER button on the remote control to turn the unit on.

Enchufe el portarretratos digital y oprima el botón de ENCENDIDO (POWER) en el control remoto para encender la unidad.

Branchez le cadre et appuyez sur la touche d'alimentation (POWER) de la télécommande pour allumer l'appareil.

3



The photo slideshow will start automatically, enjoy your photos!

La presentación en diapositivas de las fotos se iniciará automáticamente, ¡disfrute de sus fotos!

La présentation commence automatiquement. Appréciez vos photos!

Accessories



Digital Frame & Front Window Frame

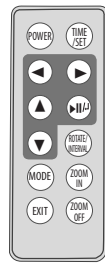

Remote

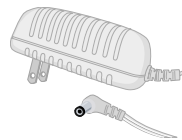

AC Adapter



Face Plates x 4

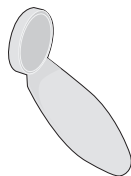

Stand



Warranty

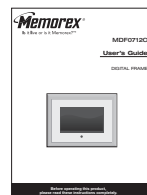

Owner's Manual

Location of Controls

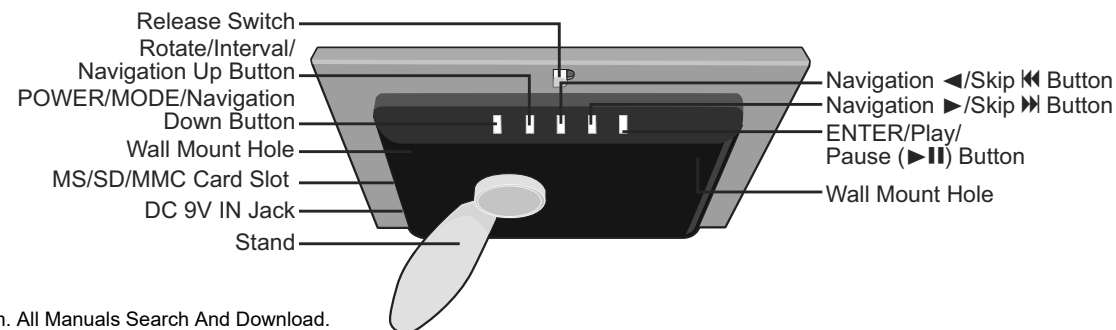
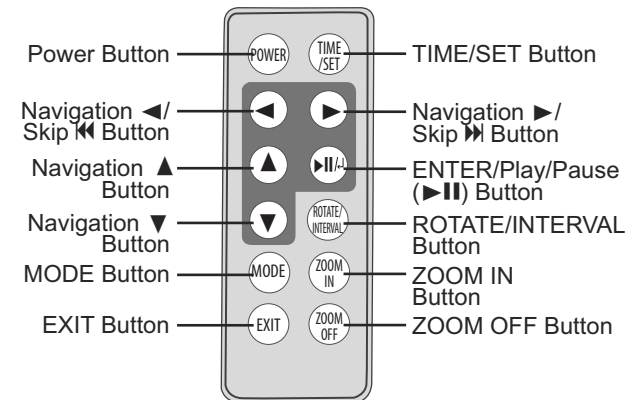

Free Manuals Download Website

<http://myh66.com>

<http://usermanuals.us>

<http://www.somanuals.com>

<http://www.4manuals.cc>

<http://www.manual-lib.com>

<http://www.404manual.com>

<http://www.luxmanual.com>

<http://aubethermostatmanual.com>

Golf course search by state

<http://golfingnear.com>

Email search by domain

<http://emailbydomain.com>

Auto manuals search

<http://auto.somanuals.com>

TV manuals search

<http://tv.somanuals.com>