

# **Memorex<sup>®</sup>**

## ***PORTABLE CD PLAYER WITH AM/FM STEREO RADIO***

### ***MODEL: MP3838***

**BEFORE OPERATING THIS PRODUCT, PLEASE READ THESE  
INSTRUCTIONS COMPLETELY.**



## **OPERATING INSTRUCTIONS**

Thank you for purchasing the Memorex audio system.

The serial number of your unit can be found on a label on the bottom of the cabinet. We suggest that you record the serial number in the space provided below in case this information is ever needed at a future date.

**PLEASE KEEP ALL PACKAGING MATERIAL FOR AT LEAST 90 DAYS IN CASE YOU NEED TO RETURN THIS PRODUCT TO YOUR PLACE OF PURCHASE OR MEMOREX.**

Model Number: MP3838

Serial Number: \_\_\_\_\_

	<b>CAUTION</b> <b>RISK OF ELECTRIC SHOCK</b> <b>DO NOT OPEN</b>	
<b>CAUTION:</b> TO REDUCE THE RISK OF ELECTRIC SHOCK, DO NOT REMOVE COVER (OR BACK). NO USER-SERVICEABLE PARTS INSIDE. REFER SERVICING TO QUALIFIED SERVICE PERSONNEL.		

**LASER SAFETY:** This unit employs a laser. Only qualified service personnel should attempt to service this device due to possible eye injury.

**CAUTION:** USE OF CONTROLS, ADJUSTMENTS OR PERFORMANCE PROCEDURE HEREIN MAY RESULT IN HAZARDOUS RADIATION EXPOSURE.



**DANGEROUS VOLTAGE:**

The lightning flash with arrowhead symbol, within an equilateral triangle is intended to alert the user to the presence of uninsulated dangerous voltage within the product's enclosure that may be of sufficient magnitude to constitute a risk of electric shock to persons.



**ATTENTION:**

The exclamation point within an equilateral triangle is intended to alert the user to the presence of important operating and maintenance (servicing) instructions in the literature accompanying the appliance.

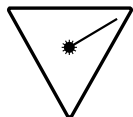

**DANGER:**

Invisible and hazardous laser radiation when open and interlock failed or defeated. Avoid direct exposure to beam.

**INFORMATION:**

This equipment has been tested and found to comply with the limits for a Class B digital device, pursuant to Part 15 of the FCC Rules. These limits are designed to provide reasonable protection against harmful interference in a residential installation. This equipment generates, uses, and can radiate radio frequency energy and, if not installed and used in accordance with the instructions, may cause harmful interference to radio communications. However, there is no guarantee that interference will not occur in a particular installation. If this equipment does cause harmful interference to radio or television reception, which can be determined by turning the equipment off and on, the user is encouraged to try to correct the interference by one or more of the following measures:

- Reorient or relocate the receiving antenna.
- Increase the separation between the equipment and receiver.
- Connect the equipment into an outlet on a circuit different from that to which the receiver is connected.
- Consult the dealer or an experienced radio/TV technician for help.

**FCC WARNING:**

This equipment may generate or use radio frequency energy. Changes or modifications to this equipment may cause harmful interference unless the modifications are expressly approved in the instruction manual. The user could lose the authority to operate this equipment if an unauthorized change or modification is made.

**SURGE PROTECTORS:**

It is recommended to use a surge protector for AC connection. Lightning and power surges ARE NOT covered under warranty for this product.

# SAFETY INSTRUCTIONS

Before using the unit, be sure to read all operating instructions carefully. Please note that these are general precautions and may not pertain to your unit. For example, this unit may not have the capability to be connected to an outdoor antenna.

## 1. READ INSTRUCTIONS

All the safety and operating instructions should be read before the product is operated.

## 2. RETAIN INSTRUCTIONS

The safety and operating instructions should be retained for future reference.

## 3. HEED WARNINGS

All warnings on the product and in the operating instructions should be adhered to.

## 4. FOLLOW INSTRUCTIONS

All operating and use instructions should be followed.

## 5. CLEANING

Unplug this product from the wall outlet before cleaning. Do not use liquid cleaners or aerosol cleaners. Use a damp cloth for cleaning.

## 6. ATTACHMENTS

Do not use attachments not recommended by the product's manufacturer as they may cause hazards.

## 7. WATER AND MOISTURE

Do not use this product near water- for example, near a bathtub, washbowl, kitchen sink, or laundry tub, in a wet basement, or near a swimming pool.

## 8. ACCESSORIES

Do not place this product on an unstable cart, stand, tripod, bracket, or table. The product may fall, causing serious injury and serious damage to the product. Use only with a cart, stand, tripod, bracket, or table recommended by the manufacturer or sold with the product. Any mounting of the product should follow the manufacturer's instructions, and should use a mounting accessory recommended by the manufacturer.

- 8A. An appliance and cart combination should be moved with care. Quick stops, excessive force, and uneven surfaces may cause the appliance and cart combination to overturn.

PORTABLE CART WARNING  
(symbol provided by RETAC)



## 9. VENTILATION

Slots and openings in the cabinet and in the back or bottom are provided for ventilation and to ensure reliable operation of the product and to protect it from overheating. These openings must not be blocked or covered. The openings should never be blocked by placing the product on a bed, sofa, rug, or other similar surface. This product should never be placed near or over a radiator or heat source. This product should not be placed in a built-in installation such as a bookcase or rack unless proper ventilation is provided or the manufacturer's instructions have been adhered to.

## 10. POWER SOURCES

This product should be operated only from the type of power source indicated on the marking label. If you are not sure of the type of power supply to your home, consult your appliance dealer or local power company. For products intended to operate from battery power, or other sources, refer to the operating instructions.

## 11. GROUNDING OR POLARIZATION

This product is equipped with a polarized alternating-current line plug (a plug having one blade wider than the other). This plug will fit into the power outlet only one way. This is a safety feature. If you are unable to insert the plug fully into the outlet, try reversing the plug. If the plug should still fail to fit, contact your electrician to replace your obsolete outlet. Do not defeat the safety purpose of the polarized plug.

## 12. POWER-CORD PROTECTION

Power-supply cords should be routed so that they are not likely to be walked on or pinched by items placed upon or against them, paying particular attention to cords at plugs, convenience receptacles, and the point where they exit from the appliance.

## 13. LIGHTNING

To protect your product from a lightning storm, or when it is left unattended and unused for long periods of time, unplug it from the wall outlet and disconnect the antenna or cable system. This will prevent damage to the product due to lightning and power-line surges.

## 14. POWER LINES

An outside antenna system should not be located in the vicinity of overhead power lines or other electric light or power circuits, or where it can fall into such power lines or circuits. When installing an outside antenna system, extreme care should be taken to keep from touching such power lines or circuits as contact with them might be fatal.

## 15. OVERLOADING

Do not overload wall outlets and extension cords as this can result in a risk of fire or electric shock.

## 16. OBJECT AND LIQUID ENTRY

Never push objects of any kind into this product through openings as they may touch dangerous voltage points or short out parts that could result in fire or electric shock. Never spill or spray any type of liquid on the product.

## 17. OUTDOOR ANTENNA GROUNDING

If an outside antenna is connected to the product, be sure the antenna system is grounded so as to provide some protection against voltage surges and built-up static charges. Section 810 of the National Electric Code, ANSI/NFPA 70, provides information with respect to proper grounding of the mast and supporting structure, grounding of the lead-in wire to an antenna discharge product, size of grounding conductors, location of antenna discharge product, connection to grounding electrodes, and requirements for grounding electrode.

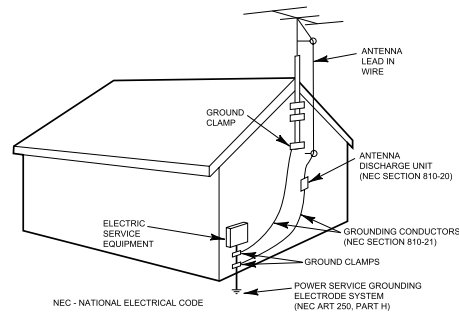

EXAMPLE OF ANTENNA GROUNDING AS PER NATIONAL ELECTRICAL CODE

## 18. SERVICING

Do not attempt to service this product yourself as opening or removing covers may expose you to dangerous voltage or other hazards. Refer all servicing to qualified service personnel.

## 19. REPLACEMENT PARTS

When replacement parts are required, be sure the service technician uses replacement parts specified by the manufacturer or those that have the same characteristics as the original part. Unauthorized substitutions may result in fire, electric shock or other hazards.

## 20. SAFETY CHECK

Upon completion of any service or repairs to this product, ask the service technician to perform safety checks to determine that the product is in proper operating condition.

## 21. WALL OR CEILING MOUNTING

The product should be mounted to a wall or ceiling only as recommended by the manufacturer.

## 22. DAMAGE REQUIRING SERVICE

Unplug the product from the wall outlet and refer servicing to qualified service personnel under the following conditions:

- When the power-supply cord or plug is damaged.
- If liquid has been spilled, or objects have fallen into the product.
- If the product has been exposed to rain or water.
- If the product does not operate normally by following the operating instructions. Adjust only those controls that are covered by the operating instructions, as an adjustment of other controls may result in damage and will often require extensive work by a qualified technician to restore the product to its normal operation.
- If the product has been dropped or the cabinet has been damaged.
- When the product exhibits a distinct change in performance - this indicates a need for service.

## 23. HEAT

The product should be situated away from heat sources such as radiators, heat registers, stoves, or other products (including amplifiers) that produce heat.

## 24. NOTE TO CATV SYSTEM INSTALLER

This reminder is provided to call the CATV system installer's attention to Article 820-40 of the NEC that provides guidelines for proper grounding and, in particular, specifies that the cable ground shall be connected to the grounding system of the building, as close to the point of cable entry as practical.

## PREPARATION FOR USE

### Unpacking and Setup

- Carefully remove the unit from the display carton and remove all packing material from the unit itself.
- The detachable AC power cord is packed in the carton separately from the unit. Make sure that the AC power cord is not accidentally discarded with the carton or packing material.
- Press the OPEN/CLOSE area to open the CD compartment door. There is a white card in the CD compartment which is intended to prevent the CD pickup from moving during shipment of the product. Remove this card from the CD compartment before use.

### Power Sources

This portable audio system is designed to operate on either 110-120V AC 60Hz house current DC or by using eight (8) 'C' batteries, not included. Attempting to operate this unit from any other power source may cause damage to the unit, which is not covered by your warranty.

### AC Operation

Unwind the AC cord and extend it to its full length. Insert the small end of the AC cord into the AC socket on the rear of the unit. Insert the other end of the AC cord into any convenient 110-120V 60Hz household outlet.

Please note that this unit is equipped with a polarized AC plug which has one blade wider than the other. This is a safety feature to reduce the likelihood of electric shock. This polarized AC plug will only fit in a polarized AC outlet. If you find that you cannot insert this plug into your outlet, you may have an obsolete non-polarized outlet. Please do not try to defeat this safety feature by using a non-polarized adapter or by filing the wider blade to make it fit into your outlet. If this plug does not fit into your outlet, you should contact a qualified licensed electrician to replace your obsolete outlet.

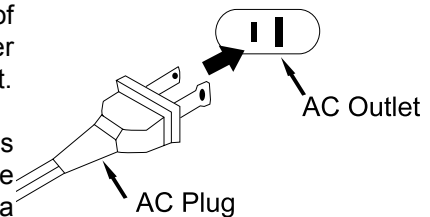

### Battery Installation

To use this unit with battery power, remove the battery compartment on the bottom of the unit by sliding it towards the rear of the unit and lifting the battery door off. Insert eight (8) 'C' size batteries following the diagram in the compartment.

**NOTE:** The AC power cord must be disconnected from the AC socket on the rear of the unit in order for the unit to operate on battery power.

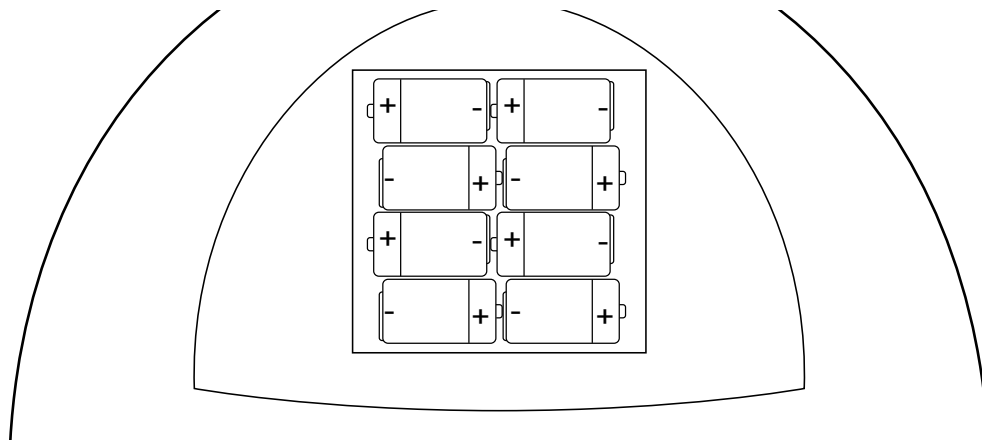

## LOCATION OF CONTROLS

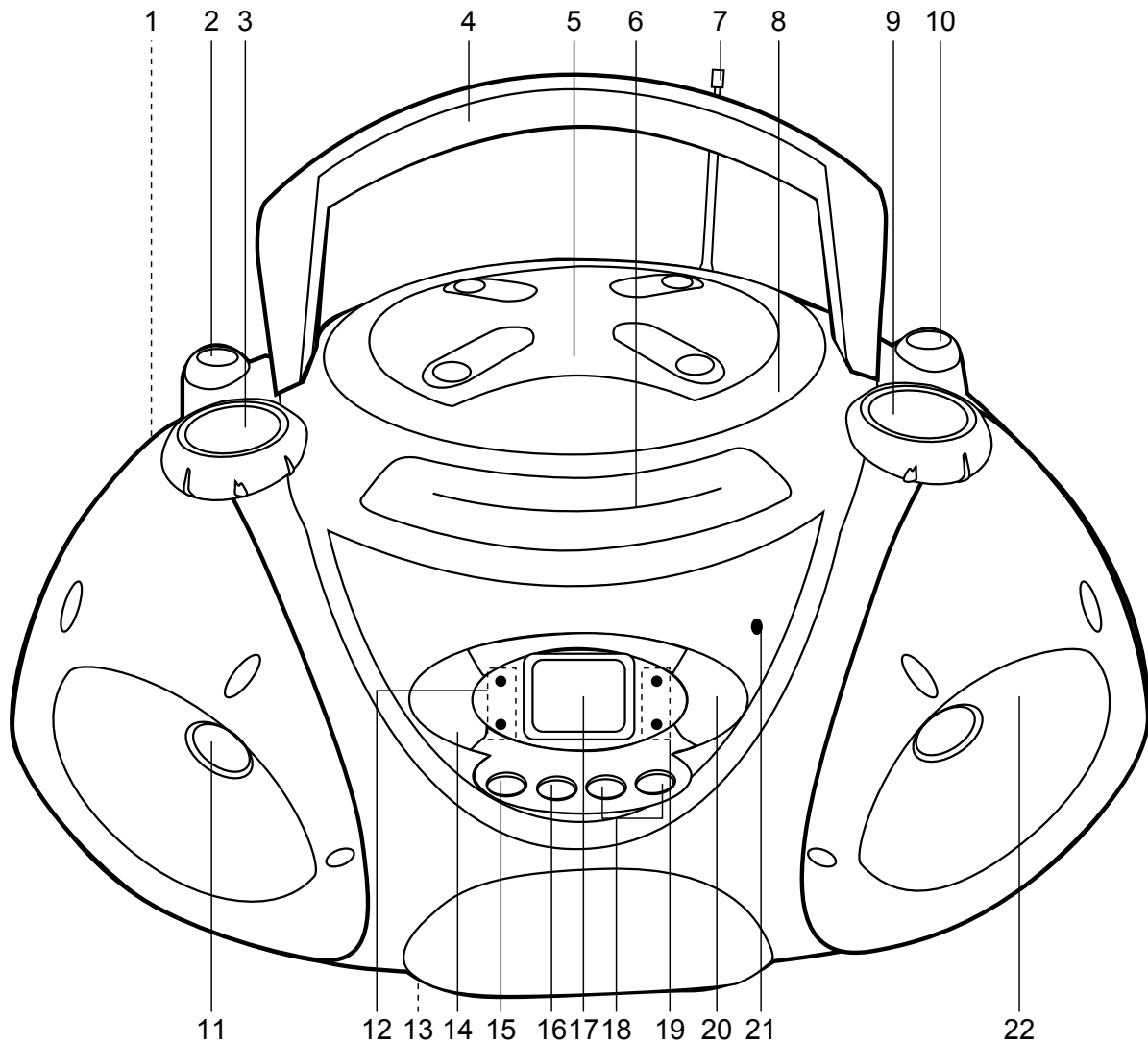

- |                                 |  |
|---------------------------------|--|
| 1. AC Power Jack (Rear of Unit) | 12. POWER and PROG Indicators            |
| 2. Function Control             | 13. Battery Compartment (Bottom of Unit) |
| 3. VOLUME Control               | 14. STOP (■) Button                      |
| 4. Carrying Handle              | 15. PROGRAM Button                       |
| 5. CD Compartment               | 16. REPEAT Button                        |
| 6. AM/FM Dial Scale and Pointer | 17. Display                              |
| 7. FM Rod Antenna               | 18. SKIP/Search – ◀◀ /+ ▶▶ Button        |
| 8. CD Door OPEN/CLOSE Area      | 19. PLAY/PAUSE and REPEAT Indicators     |
| 9. TUNING Control               | 20. PLAY/PAUSE (▶/  ) Button             |
| 10. BAND Control                | 21. FM STEREO Indicator                  |
| 11. Speaker                     | 22. Speaker                              |

## RADIO OPERATION

### TO PLAY THE RADIO

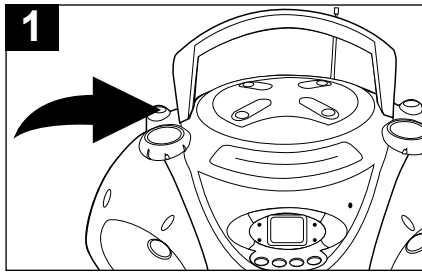

1  
Rotate the Function control to the RADIO position.

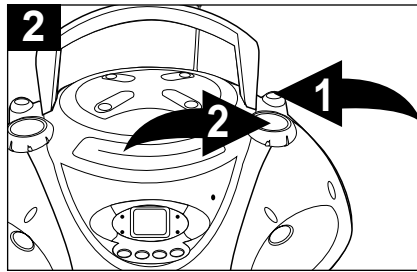

2  
Rotate the BAND control ❶ to select AM or FM. Rotate the TUNING control ❷ to select a station.

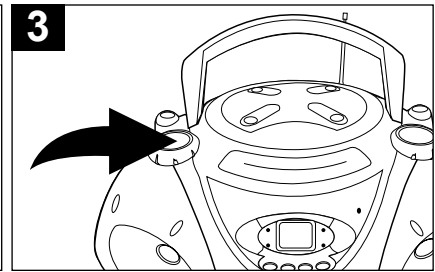

3  
Adjust the VOLUME control as desired.

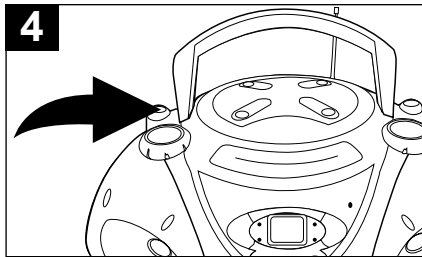

4  
When you have finished listening, rotate the FUNCTION control to the OFF position.

#### FM STEREO

When the BAND switch is set to the FM position and a strong FM stereo station is broadcasting, the FM STEREO indicator will light.

#### ANTENNAS

**AM** – This unit has a built-in ferrite rod antenna, which provides adequate reception in most areas. If reception is weak, turn the unit to improve reception.

**FM** – The FM Rod Antenna is for FM reception only. If reception is weak, adjust the length and the angle of the antenna.

## COMPACT DISC (CD) OPERATION

### TO INSERT A CD

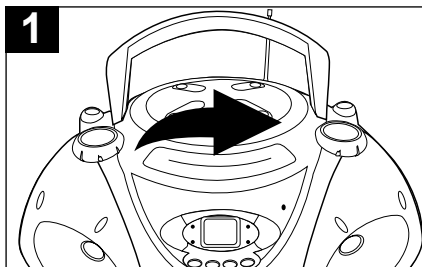

1  
Open the CD compartment lid by pressing the OPEN/CLOSE area. Place a CD on the center spindle, with the printed label side facing up. Close the CD compartment door.

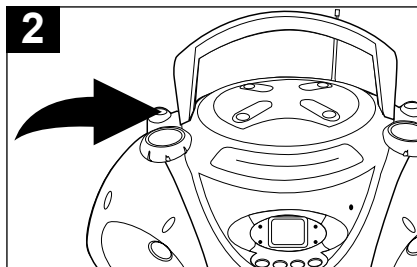

2  
Rotate the Function control to the CD position.

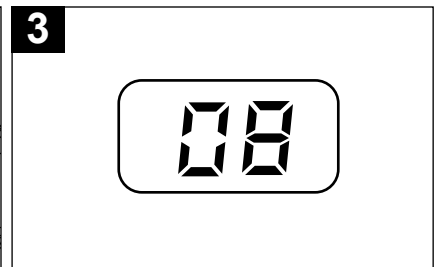

3  
The total number of tracks will be displayed and the CD player will stop.

## COMPACT DISC (CD) OPERATION (CONTINUED)

### TO PLAY A CD (STANDARD CD, CD-R AND CD-RW CAN BE USED)

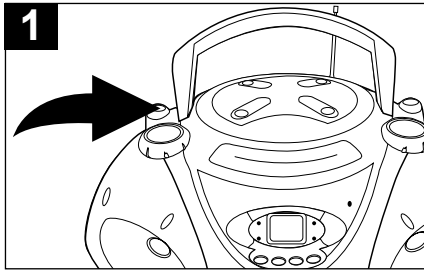

**1** Rotate the Function control to the CD position. Insert a CD as described in the TO INSERT A CD section on page 5.

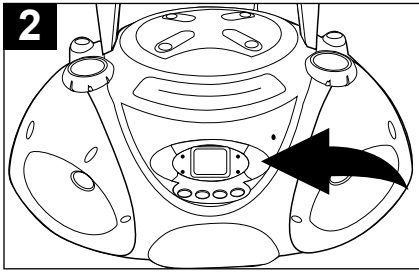

**2** To play a disc from the beginning, press the PLAY/PAUSE (▶/||) button. Press the PLAY/PAUSE (▶/||) button again to pause playback; the track indicator will blink.

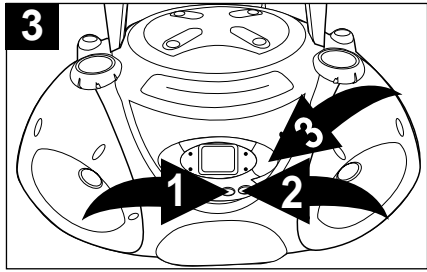

**3** To start from a specific track, locate the track using the SKIP/Search – ◀◀ ❶ or + ▶▶ ❷ button and press the PLAY/PAUSE (▶/||) button ❸.

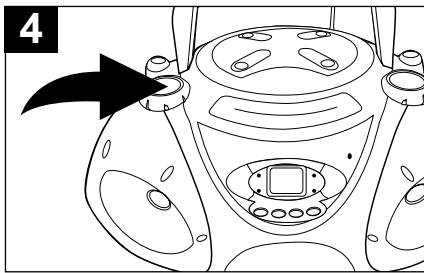

**4** Adjust the VOLUME control as desired.

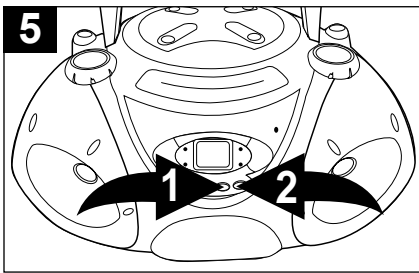

**5** To skip forward or backward through the tracks on the disc, press the SKIP/Search – ◀◀ ❶ or + ▶▶ ❷ button.

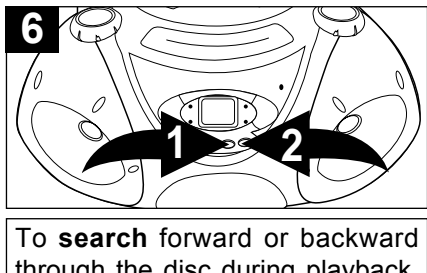

**6** To search forward or backward through the disc during playback, press and hold the SKIP/Search – ◀◀ ❶ or + ▶▶ ❷ button, a chattering noise will be heard. Stop pressing the button to return to normal playback.

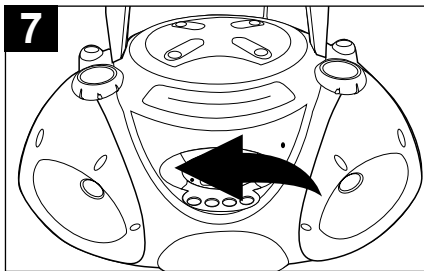

**7** When the disc is through playing, it will stop rotating. Press the STOP (■) button to stop the disc before it is finished.

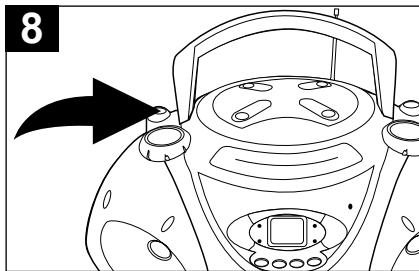

**8** When you have finished listening, rotate the Function control to the OFF position.

#### FAQS:

*Do I need an adapter to play 3" singles?*  
No, simply insert the 3" single into the groove.

*What is the maximum time for a CD in this unit?*

The maximum time is 74 minutes.

*What type of CDs can I play?*  
CD, CD-Rs and CD-RWs can be used.

#### NOTES:

- If a disc is inserted incorrectly, dirty, damaged or not present at all, it will not play.
- As each track is played, the track number is shown in the display.
- To prevent damage to the disc, never open the CD door while the disc is rotating. Wait for the disc to stop before opening the CD door. Never touch the lens when the CD compartment door is open.
- DO NOT use the carrying handle when playing a CD. The CD should only be used on a steady surface.

## COMPACT DISC (CD) OPERATION (CONTINUED)

### TO REPEATEDLY PLAY BACK ONE TRACK

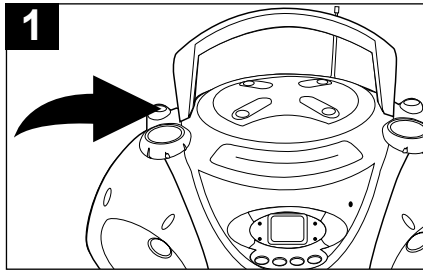

1 Rotate the Function control to the CD position. Insert a CD as described in the TO INSERT A CD section on page 5.

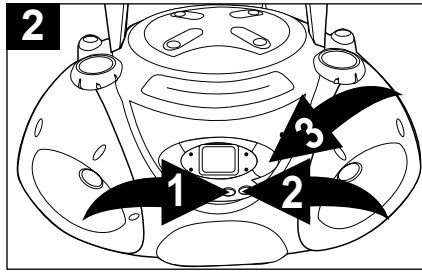

2 Select a track using the SKIP/Search – ◀▶ ① or + ▶▶ ② button and press the PLAY/PAUSE (▶/||) button ③.

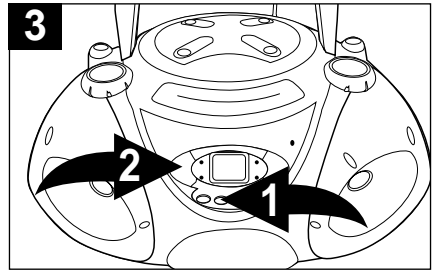

3 Press the REPEAT button ① once, the REPEAT indicator will blink and the unit will play the selected track over and over until the STOP (■) button ② is pressed.

### TO REPEATEDLY PLAY BACK ALL TRACKS

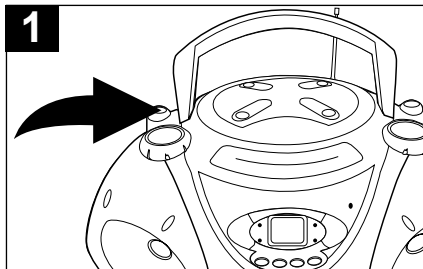

1 Rotate the Function control to the CD position. Insert a CD as described in the TO INSERT A CD section on page 5.

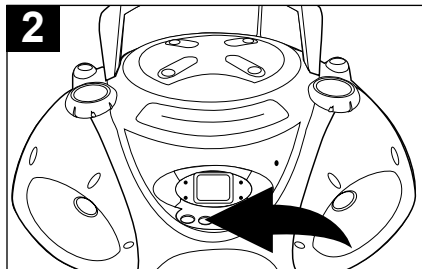

2 Press the REPEAT button twice, the REPEAT indicator will light.

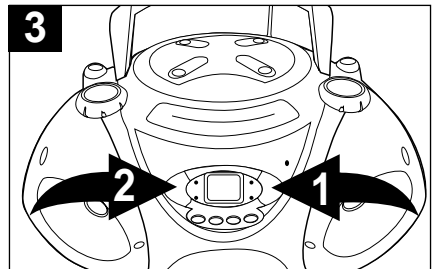

3 Press the PLAY/PAUSE (▶/||) button ① to begin playback and the unit will play the entire disc over and over until the STOP (■) button ② is pressed.

#### NOTE:

To stop and cancel Repeat playback, press the STOP (■) button.



## COMPACT DISC (CD) OPERATION (CONTINUED)

### TO PROGRAM THE MEMORY (UP TO 32 TRACKS)

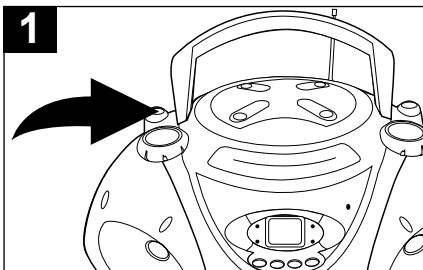

**1** Rotate the Function control to the CD position. Insert a CD as described in the TO INSERT A CD section on page 5.

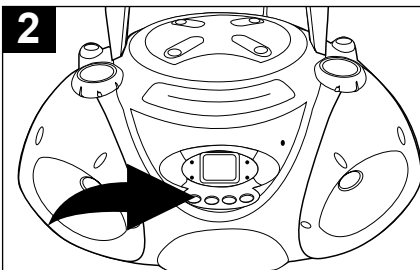

**2** Press the PROGRAM button; "01" will appear in the display and the PROG indicator will blink.

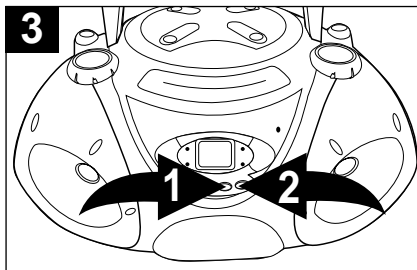

**3** Use the SKIP/Search - or + button to select the first track to be programmed.

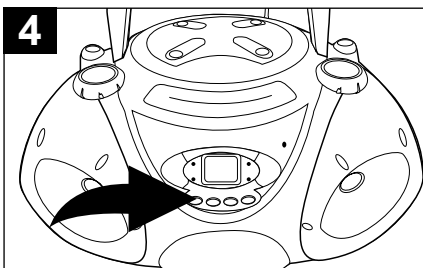

**4** Press the PROGRAM button again; the selected track has now been programmed and counted as program 1.

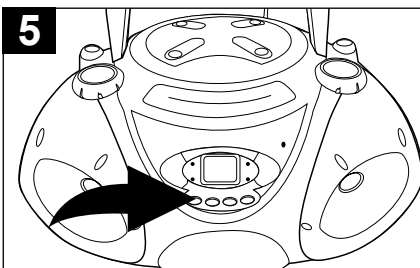

**5** Repeat steps 3 and 4 to program the other desired tracks in sequence (up to 32 tracks).

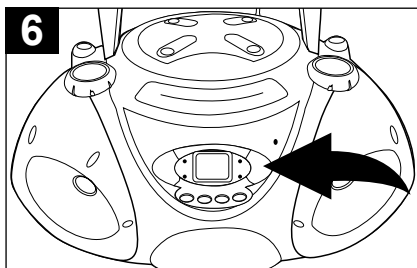

**6** Press the PLAY/PAUSE () button to begin playback; the PROG indicator will light and the tracks will play in the order programmed.

#### NOTES:

- Programming is the ability to preselect the order in which a series of tracks will be played.
- Each track may be stored in the program memory as many times as desired (up to 32 tracks).
- As each track is played, its track number will be displayed. You can move forward or backward through the programmed tracks with the SKIP/Search + or - button.
- The CD player will stop after all programmed tracks have been played or the STOP () button is pressed. If the STOP () button was pressed, the programmed tracks will remain in memory. Simply press the PROGRAM button and then the PLAY/PAUSE () button to continue Program playback.
- To cancel Program playback, press the PROGRAM button to enter the Program mode and then press the STOP () button, or open the CD door.

## CARE AND MAINTENANCE

### Caring for Compact Discs

- Treat the disc carefully. Handle the disc only by its edges. Never allow your fingers to come in contact with the shiny, unprinted side of the compact disc.
- Do not attach adhesive tape, stickers, etc. to the compact disc label.
- Clean the compact disc periodically with a soft, lint-free, dry cloth. Never use detergents or abrasive cleaners to clean the compact disc. If necessary, use a CD cleaning kit.
- If a compact disc skips or gets stuck on a section of the compact disc, it is probably dirty or damaged (scratched).
- When cleaning the compact disc, wipe in straight lines from the center of the compact disc to the outer edge of the compact disc. Never wipe in circular motions.

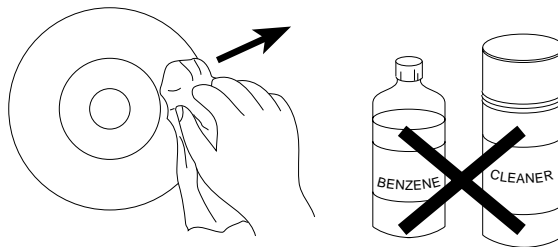
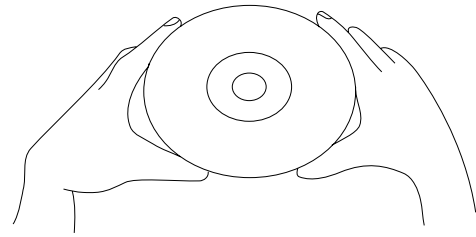

- This unit is designed to play only compact discs bearing the identification logo as shown here.
- Compact Discs should be stored in their cases after each use to avoid damage.
- Do not expose compact discs to direct sunlight, high humidity, high temperatures, or dust, etc. Prolonged exposure or extreme temperatures can warp the disc.
- Do not stick or write anything on either side of the disc. Sharp writing instruments, or the ink may damage the surface.



### Cleaning the unit

- To prevent fire or shock hazard, disconnect your unit from the AC power source when cleaning.
- The finish on your unit may be cleaned with a dust cloth and cared for as other furniture. Use caution when cleaning and wiping the plastic parts.
- Mild soap and a damp cloth may be used on the front panel.

## TROUBLESHOOTING GUIDE

Should this unit exhibit a problem, check the following before seeking service.

Symptom	Possible Cause	Solution
<b>Radio</b>		
Noise or sound distorted on radio broadcasts.	Station not tuned properly for AM or FM.	Retune the AM or FM broadcast station.
	FM: Telescopic antenna is not properly adjusted.	Reorient FM telescopic antenna.
	AM: Unit is not positioned correctly.	Rotate unit until best reception is obtained.
AM or FM, no sound.	Function control not set to RADIO.	Set Function control to RADIO.
	Volume at minimum.	Increase volume.
<b>Compact Disc Player</b>		
CD Player will not play.	Function control not set to CD.	Set Function control to CD.
	CD is not installed or installed upside-down.	Insert CD with label side up.
CD skips while playing.	Disc is dirty or scratched.	Wipe disc with cloth or use another disc.
<b>General</b>		
No sound.	Power cord disconnected.	Connect power cord.
	No batteries, or weak, dead or inserted incorrectly.	Insert fresh batteries correctly.

**FOR ADDITIONAL SET-UP OR OPERATING ASSISTANCE, PLEASE VISIT OUR WEBSITE AT [WWW.MEMOREXELECTRONICS.COM](http://WWW.MEMOREXELECTRONICS.COM) OR CONTACT CUSTOMER SERVICE AT 1-800-919-3647**

**PLEASE KEEP ALL PACKAGING MATERIAL FOR AT LEAST 90 DAYS IN CASE YOU NEED TO RETURN THIS PRODUCT TO YOUR PLACE OF PURCHASE OR MEMOREX.**

**FOR PARTS AND ACCESSORIES, CONTACT FOX INTERNATIONAL AT 1-800-321-6993.**

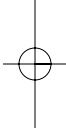
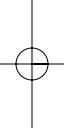
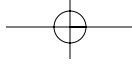

Memcorp, Inc.  
Weston, FL  
Printed in Hong Kong

Visit our website at [www.memorexelectronics.com](http://www.memorexelectronics.com)



## Free Manuals Download Website

<http://myh66.com>

<http://usermanuals.us>

<http://www.somanuals.com>

<http://www.4manuals.cc>

<http://www.manual-lib.com>

<http://www.404manual.com>

<http://www.luxmanual.com>

<http://aubethermostatmanual.com>

Golf course search by state

<http://golfingnear.com>

Email search by domain

<http://emailbydomain.com>

Auto manuals search

<http://auto.somanuals.com>

TV manuals search

<http://tv.somanuals.com>