

Memorex[®]

**PORTABLE CD PLAYER
AM/FM STEREO RADIO WITH
CASSETTE RECORDER**

MODEL: MP 3130

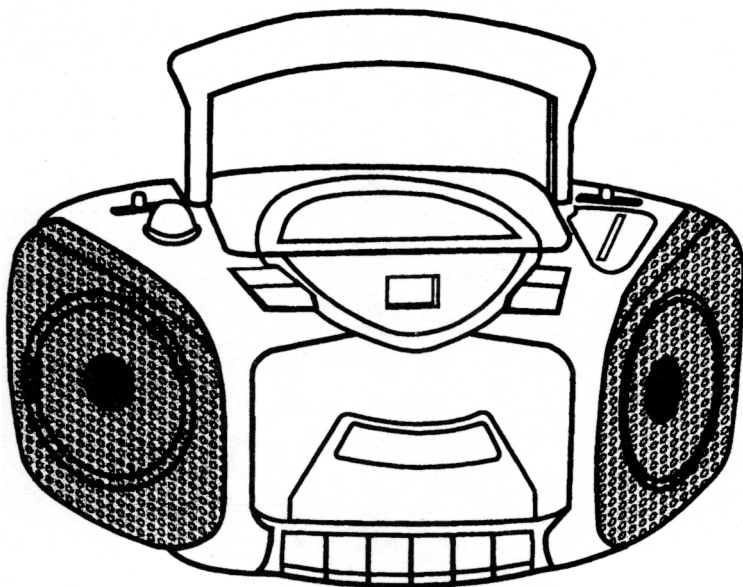



BEFORE OPERATION THIS PRODUCT,
PLEASE READ THESE INSTRUCTIONS COMPLETELY

Dear Customer,

Please read this manual thoroughly before operating the unit so that you will be informed of all the features and control operations. Also keep these instructions handy for future reference.

**WARNING : TO REDUCE THE RISK OF FIRE OR ELECTRIC SHOCK.
DO NOT EXPOSE THE APPLIANCE TO RAIN OR MOISTURE.**

	CAUTION RISK OF ELECTRIC SHOCK DO NOT OPEN	
CAUTION: TO REDUCE THE RISK OF ELECTRIC SHOCK, DO NOT REMOVE COVER (OR BACK). NO USER- SERVICEABLE PARTS INSIDE. REFER SERVICING TO QUALIFIED SERVICE PERSONNEL.		

CAUTION: Any changes or modifications in construction of this device which are not expressly approved by the party responsible for compliance could void the user's authority to operate the equipment.

DANGER: INVISIBLE LASER RADIATION WHEN OPEN AND INTERLOCK FAILED OR DEFEATED. AVOID DIRECT EXPOSURE TO BEAM.

CAUTION: HAZARDOUS LASER RADIATION WHEN OPEN AND INTERLOCK DEFEATED.

Explanation of Graphic Symbols:



The lightning flash with arrowhead symbol within an equilateral triangle is intended to alert the user to the presence of uninsulated "dangerous voltage" within the product's enclosure that may be of sufficient magnitude to constitute a risk of electric shock to persons.



The exclamation point within an equilateral triangle, is intended to alert the user to the presence of important operating and maintenance (servicing) instructions in the literature accompanying the appliance.



Caution
FOR COMPACT DISC UNIT ONLY
Invisible laser radiation when open and interlock failed or defeated. Avoid direct exposure to laser beam

LASER SAFETY:
This unit employs a laser. Only qualified service personnel should attempt to service this device due to possible eye injury.
CAUTION:
USE OF CONTROLS, ADJUSTMENTS OR PERFORMANCE PROCEDURE HEREIN MAY RESULT IN HAZARDOUS RADIATION EXPOSURE.

SAFETY INSTRUCTIONS

Before using the unit, be sure to read all operating Instructions carefully. Please note that these are general precautions and may not pertain to your unit. For example, this unit may not have the capability to be connected to an outdoor antenna.

1. READ INSTRUCTIONS

All the safety and operating instructions should be read before the product is operated.

2. RETAIN INSTRUCTIONS

The safety and operating instructions should be retained for future reference.

3. HEED WARNINGS

All warnings on the product and in the operating instructions should be adhered to.

4. FOLLOW INSTRUCTIONS

All operating and use instructions should be followed.

5. CLEANING

Unplug this product from the wall outlet before cleaning. Do not use liquid cleaners or aerosol cleaners. Use a damp cloth for cleaning.

6. ATTACHMENTS

Do not use attachments not recommended by the product's manufacturer as they may cause hazards.

7. WATER AND MOISTURE

Do not use this product near water—for example, near a bathtub, washbowl, kitchen sink or laundry tub, in a wet basement, or near a swimming pool.

8. ACCESSORIES

Do not place this product on an unstable cart, stand, tripod, bracket, or table. The product may fall, causing serious injury and serious damage to the product. Use only with a cart, stand, tripod, bracket, or table recommended by the manufacturer or sold with the product. Any mounting of the product should follow the manufacturer's instructions, and should use a mounting accessory recommended by the manufacturer.

- 8A. An appliance and cart combination should be moved with care. Quick stops, excessive force, and uneven surfaces may cause the appliance and cart combination to overturn.

9. VENTILATION

Slots and openings in the cabinet and in the back or bottom are provided for ventilation and to ensure reliable operation of the product and to protect it from overheating. These openings must not be blocked or covered. The openings should never be blocked by placing the product on a bed, sofa, rug, or other similar surface. This product should never be placed near or over a radiator or heat source. This product should not be placed in a built-in installation such as a bookcase or rack unless proper ventilation is provided or the manufacturer's instructions have been adhered to.

10. POWER SOURCES

This product should be operated only from the type of power source indicated on the marking label. If you are not sure of the type of power supply to your home, consult your appliance dealer or local power company. For products intended to operate from battery power, or other sources, refer to the operating instructions.

11. GROUNDING OR POLARIZATION

This product is equipped with a polarized alternating-current line plug (a plug having one blade wider than the other). This plug will fit into the power outlet only one way. This is a safety feature. If you are unable to insert the plug fully into the outlet, try reversing the plug. If the plug should still fail to fit, contact your electrician to replace your obsolete outlet. Do not defeat the safety purpose of the polarized plug.

12. POWER-CORD PROTECTION

Power-supply cords should be routed so that they are not likely to be walked on or pinched by items placed upon or against them, playing particular attention to cords at plugs, convenience receptacles, and the point where they exit from the appliance.

13. LIGHTNING

To protect your product from a lightning storm, or when it is left unattended and unused for long periods of time, unplug it from the wall outlet and disconnect the antenna or cable system. This will prevent damage to the product due to lightning and power-line surges.

14. Nettoyage

An outside antenna system should not be located in the vicinity of overhead power lines or other electric light or power circuits, or where it can fall into such power lines or circuits. When installing an outside antenna system, extreme care should be taken to keep from touching such power lines or circuits as contact with them might be fatal.

15. OVERLOADING

Do not overload wall outlets and extension cords as this can result in a risk of fire or electric shock.

16. OBJECT AND LIQUID ENTRY

Never push objects of any kind into this product through openings as they may touch dangerous voltage points or short out parts that could result in fire or electric shock. Never spill or spray any type of liquid on the product.

17. OUTDOOR ANTENNA GROUNDING

If an outside antenna is connected to the product, be sure the antenna system is grounded so as to provide some protection against voltage surges and built-up static charges. Section 810 of the National Electric Code, ANSI/NFPA 70, Provides information with respect to proper grounding of the mast and supporting structure, grounding of proper in wire to an antenna discharge product, size of grounding conductors, location of antenna discharge point, connection to grounding electrodes, and requirements for grounding electrode.

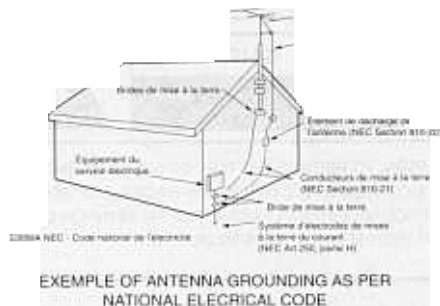

PORTABLE CART WARNING
(symbol provided by RETAC)



18. SERVICING

Do not attempt to service this product yourself as opening or removing covers may expose you to dangerous voltage or other hazards. Refer all servicing to qualified service personnel.

19. REPLACEMENT PARTS

When replacement parts are required, be sure the service technician uses replacement parts specified by the manufacturer or those that have the same characteristics as the original part. Unauthorized substitutions may result in fire, electric shock or other hazards.

20. SAFETY CHECK

Upon completion of any service or repairs to this product, ask the service technician to perform safety checks to determine that the product is in proper operating condition.

21. WALL OR CEILING MOUNTING

The product should be mounted to a wall or ceiling only as recommended by the manufacturer.

22. DAMAGE REQUIRING SERVICE

Unplug the product from the wall outlet and refer servicing to qualified service personnel under the following conditions:

- When the power-supply cord or plug is damaged.
- If liquid has been spilled, or objects have fallen into the product.
- If the product has been exposed to rain or water.
- If the product does not operate normally by following the operating instructions. Adjust only those controls that are covered by the operating instructions, as an adjustment to other controls may result in damage and will often require extensive work by a qualified technician to restore the product to its normal operation.
- If the product has been dropped or the cabinet has been damaged.
- When the product exhibits a distinct change in performance—this indicates a need for service.

23. HEAT

The product should be situated away from heat sources such as radiators, heat registers, stoves, or other products (including amplifiers) that produce heat.

24. NOTE TO CATV SYSTEM INSTALLER

This reminder is provided to call the CATV system installer's attention to Article 820-40 of the NEC that provides guidelines for proper grounding and, in particular, specifies that the cable ground shall be connected to the grounding system of the building, as close to the point of cable entry as practical.

TABLE OF CONTENTS

LOCATION OF CONTROLS 2
POWER SOURCES 3
Operating the player on AC power 3
Operating the player on batteries 3
When to replace the batteries 3
LISTENING TO THE RADIO 4
To improve reception 5
LISTENING TO THE CD 6
CD SKIP / SEARCH 7
LISTENING TO A TAPE 9
Cassette Operation	10
RECORDING FROM RADIO	11
RECORDING FROM CD	12
LISTENING WITH HEADPHONES (NOT INCLUDED)	13
GENERAL INFORMATION	14
Care and Maintenance	14
Compact Discs	14
Cassette Tapes	15
Cleaning the Tape Heads and Tape Path	15

LOCATION OF CONTROLS

FRONT

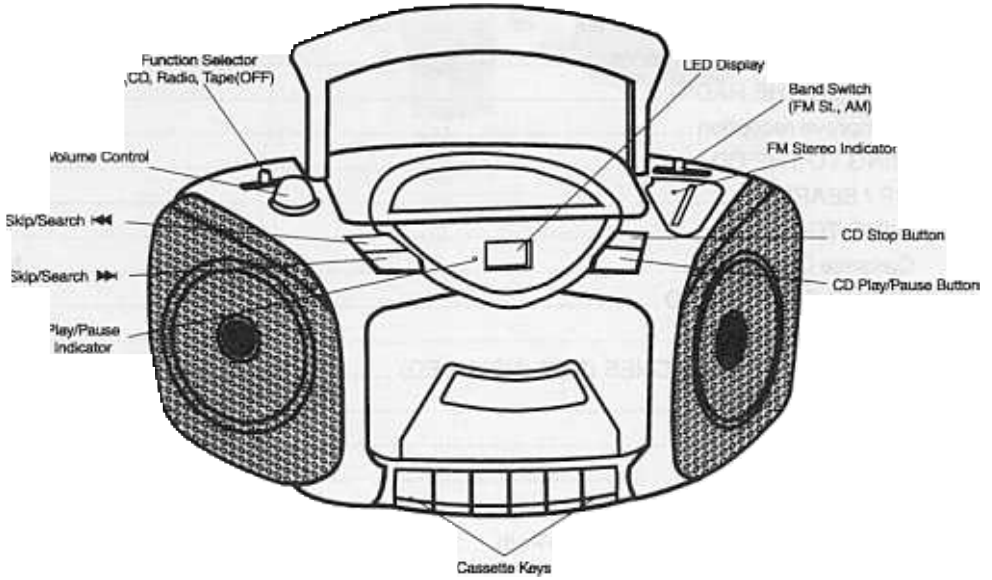

BACK

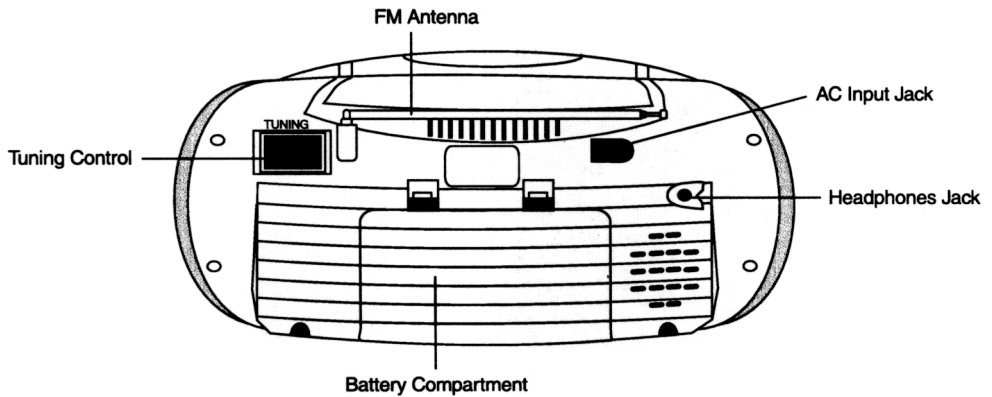

Operating the player on AC power

Insert one end of the supplied power cord into the AC IN Jack located at the rear of the unit, and the other end into the wall outlet.

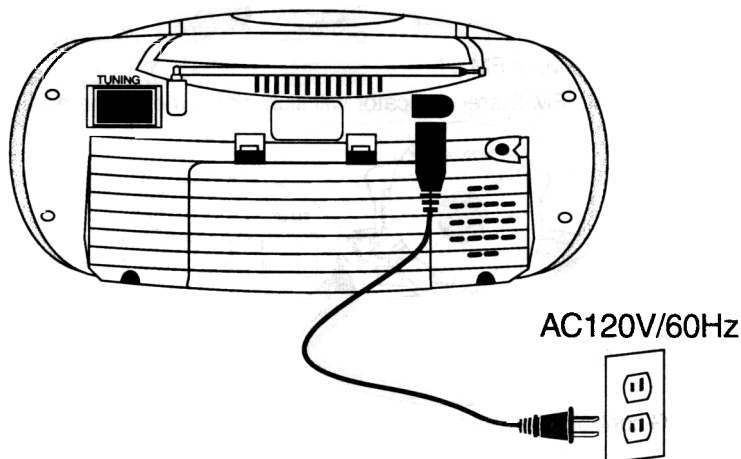

Operating the player on batteries

To play your unit on batteries, the AC power cord must be disconnected from the player. Unplug the AC power cord from the unit and insert eight size C alkaline batteries (not supplied) in the compartment.

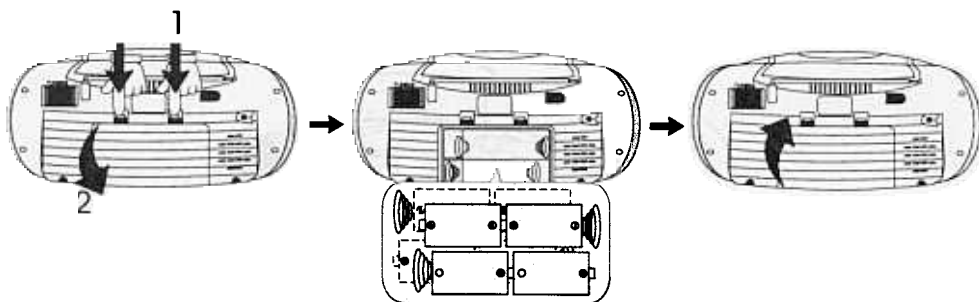

When to replace the batteries

Replace the old batteries with new ones when the sound becomes unstable or cannot be heard.

LISTENING TO THE RADIO

1. Set the FUNCTION switch to RADIO.

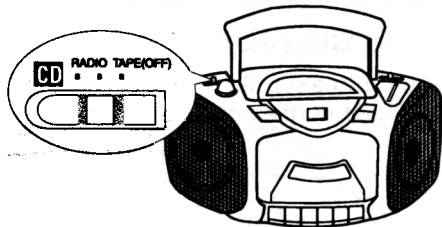

2. Set the BAND switch to AM, or FM ST.

In the FM ST. mode, the FM Stereo indicator will illuminate when a stereo broadcast is received.

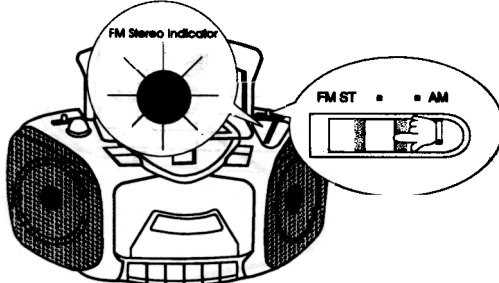

3. Turn the TUNING control to tune in a radio station.

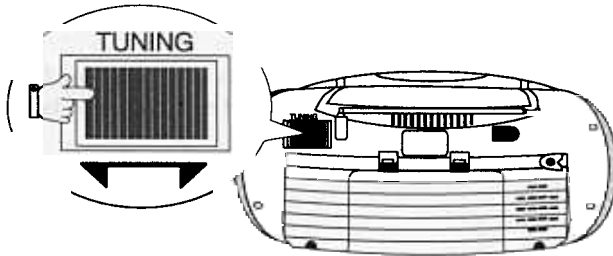

4. Adjust the VOLUME.

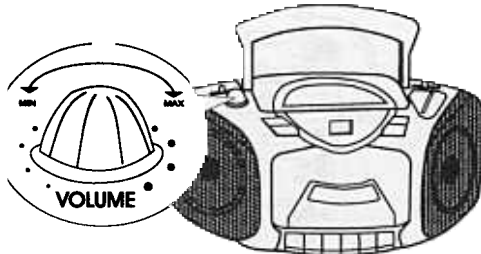

To turn off the Radio

Set the Function switch to TAPE (Off).

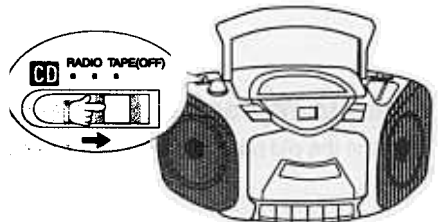

To Improve Reception

FM

Extend the FM Rod antenna to improve FM reception.

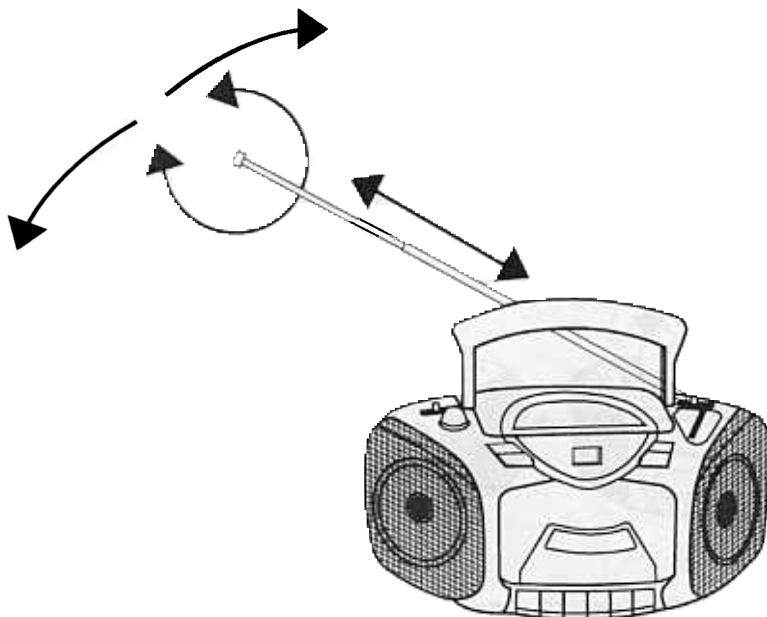

AM

The AM antenna is built into the unit. Rotate the unit to improve AM reception.

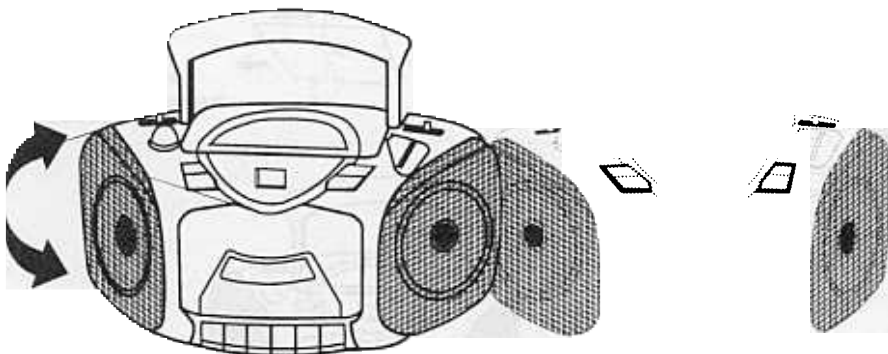

LISTENING TO THE CD

1. Set the Function switch to CD.

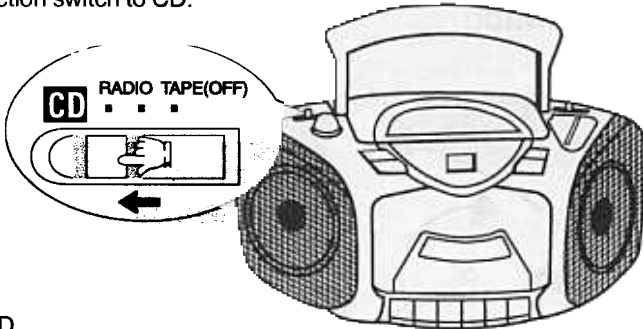

2. Insert the CD.

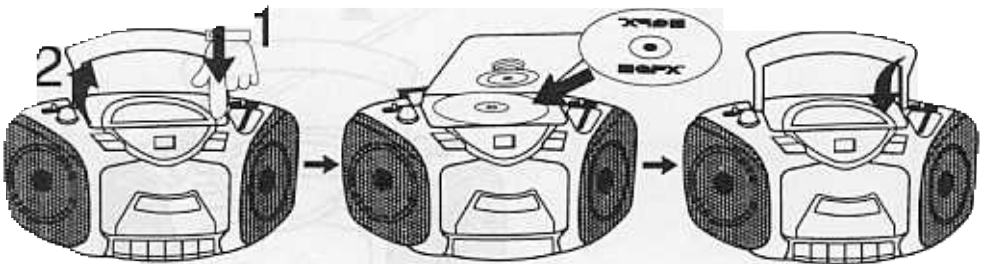

3. Press the **▶||** PLAY/PAUSE Button. The CD player will play all the tracks once. The PLAY/PAUSE indicator will illuminate.

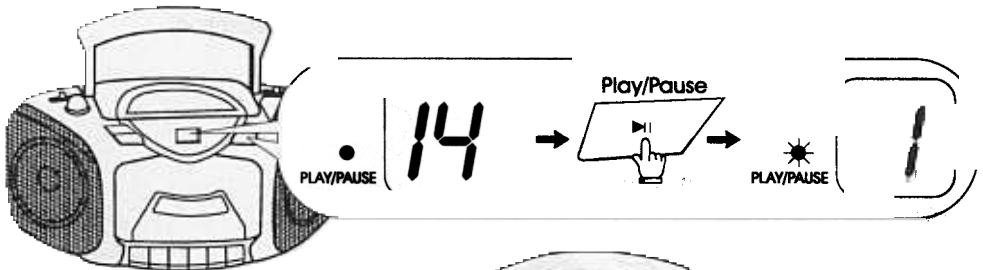

4. Adjust the VOLUME.

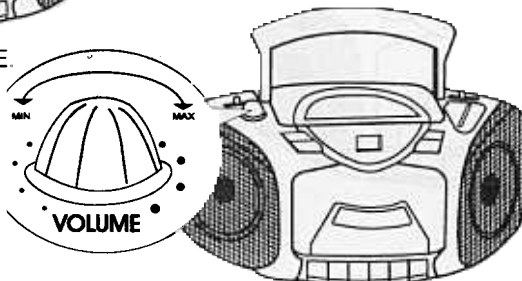

TO... **PRESS...**

Stop play

■ STOP

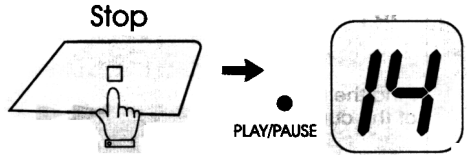

Pause

▶|| PLAY/PAUSE

The Play/Pause indicator will flash

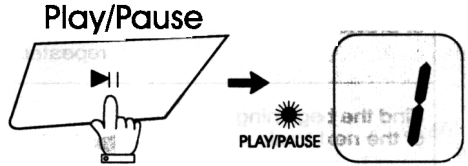

Resume play after pause

▶|| PLAY/PAUSE

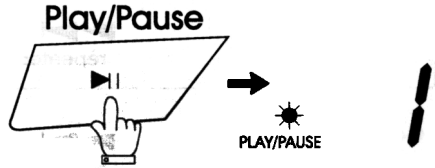

CD SKIP / SEARCH

Press Skip/Search forward ▶▶ or backward ◀◀ to select a particular track.

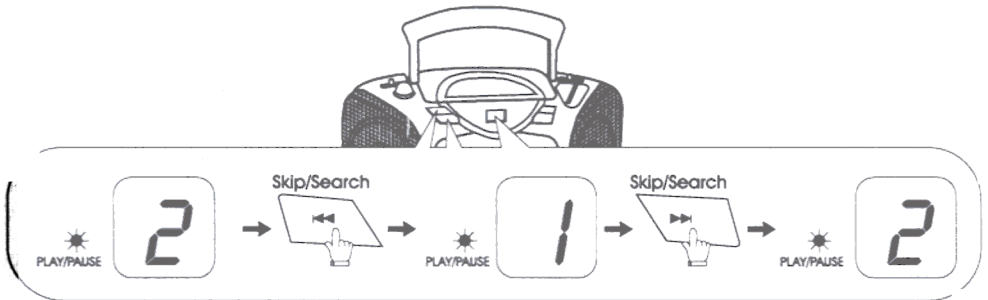

Press and hold Skip/Search forward **▶▶** or backward **◀◀** to quickly advance through music.

To	Press	Display
Find the beginning of the current track	◀◀ once	5 ▶ 5
Find the beginning of previous tracks	◀◀ repeatedly	5 ▶ 4
Find the beginning of the next track	▶▶ once	5 ▶ 6
Find the beginning of a succeeding track	▶▶ repeatedly	5 ▶ 6 ▶ 7
Go forward quickly	▶▶ hold down	7
Go backward quickly	◀◀ hold down	7

To turn off the power

Set the Function selector to TAPE (Off).

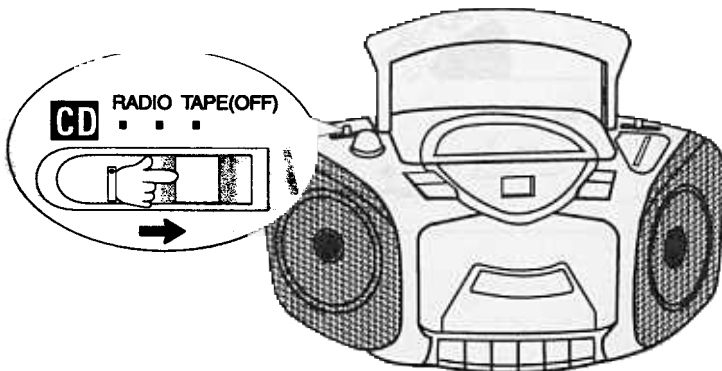

LISTENING TO A TAPE

Use Type 1 (normal) tape only.

1. Set the FUNCTION selector to Tape (OFF).

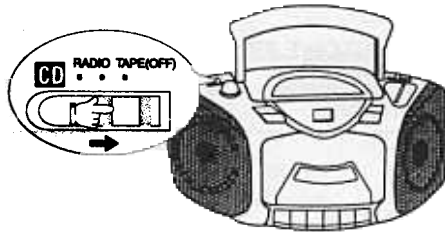

2. Insert a prerecorded tape.

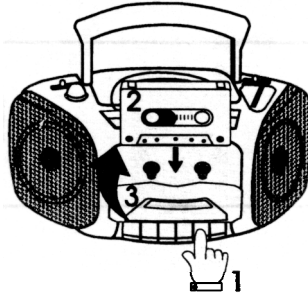

3. Press ► PLAY to start playing.

The unit will automatically turn off when the end of the tape is reached.

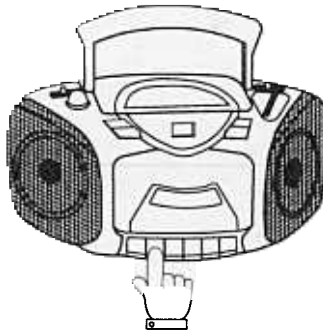

4. Adjust the VOLUME control to the desired listening level.

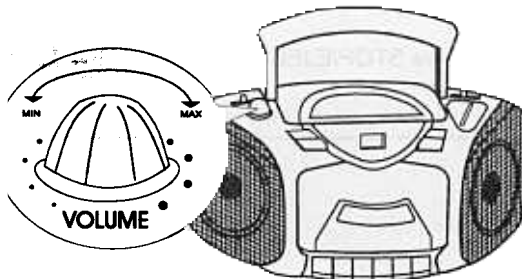

Cassette Operation

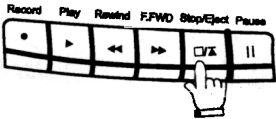
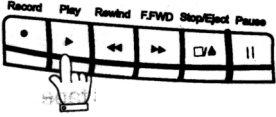
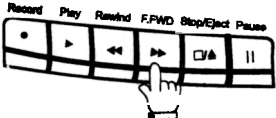
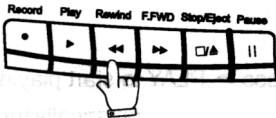
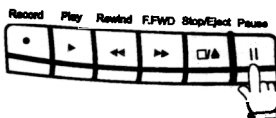
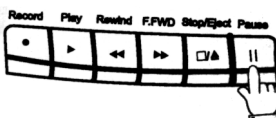
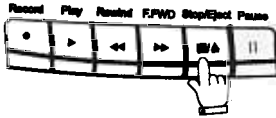
TO...	PRESS...	
	■/▲ STOP/EJECT	
	▶ Play	
Fast forward the tape	▶▶ F.F.	
Rewind the tape	◀◀ REW	
Pause tape	PAUSE	
Resume play after pause	PAUSE	
Remove the cassette	■/▲ STOP/EJECT	

RECORDING FROM RADIO

1. Set the FUNCTION switch to RADIO.

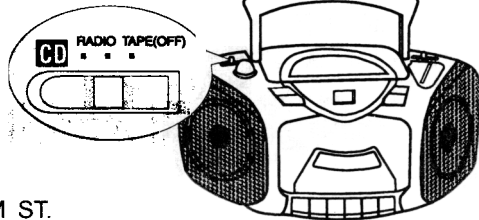

2. Set the BAND switch to AM or FM ST.

In the FM ST. mode, the FM Stereo indicator will illuminate when a stereo broadcast is received.

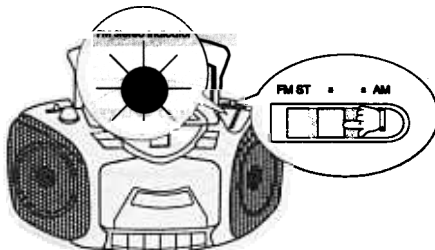

3. Turn the TUNING control to tune in a radio station.

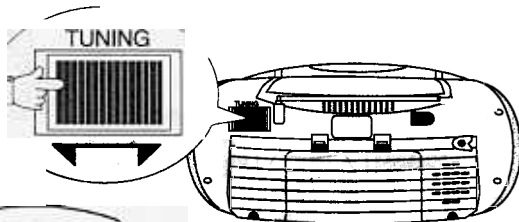

4. Insert a blank tape.

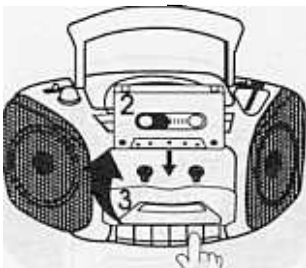

5. Press ● REC.

▶ PLAY will depress automatically, and recording starts.

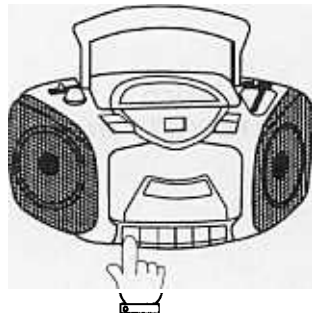

6. Press **■▲** STOP/EJ. to stop recording.

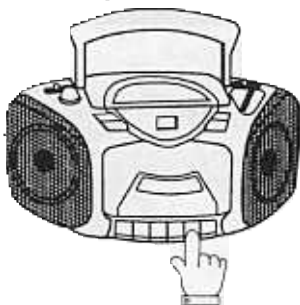

RECORDING FROM CD

1. Set the FUNCTION switch to CD.

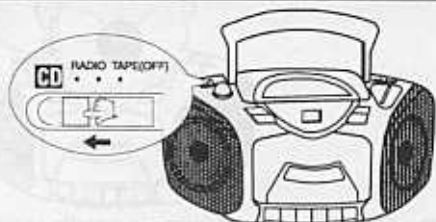

2. Insert the CD.

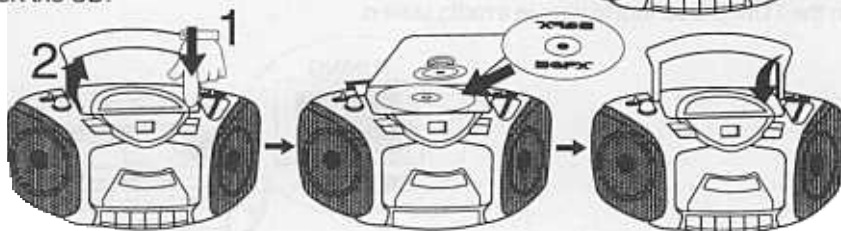

3. Insert a blank tape.

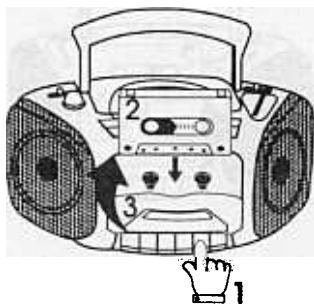

4. Press **●** REC.

► PLAY will depress automatically and recording starts.

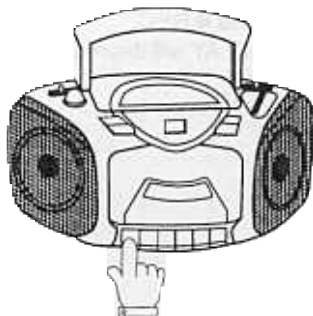

5. Press the **▶||** PLAY/PAUSE Button.

The CD player will play all the tracks once. The PLAY/PAUSE indicator will illuminate.

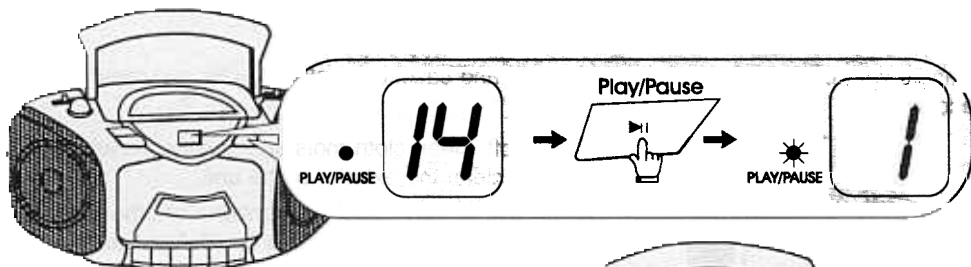

6. Press **■▲** STOP/EJ. to stop recording.

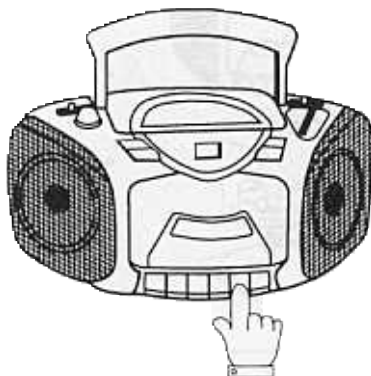

THE RECORDING LEVEL IS ADJUSTED AUTOMATICALLY

This unit is equipped with Automatic Level Control (ALC) circuitry. Adjusting the VOLUME will not affect the recording level. However these controls will change the sound levels you hear through the speakers, or headphones.

LISTENING WITH HEADPHONES (NOT INCLUDED)

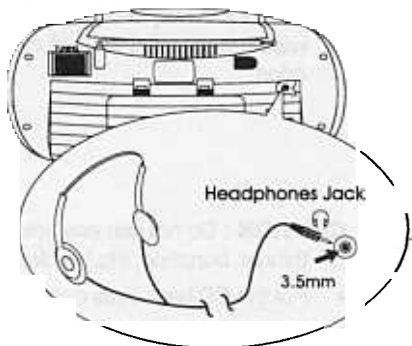

CAUTION. *Set the VOLUME to a low level before using headphones. Gradually adjust the VOLUME to a comfortable listening level.*

Please do not play the volume too loudly for extended periods of time.

Care and Maintenance

Handle your compact discs, cassette tapes, and cassette deck carefully, and they will last a long time.



- Use a soft, clean cloth moistened with plain lukewarm water to clean the exterior of the unit.
- Never use solvents such as benzene or other strong chemical cleaners since these could damage the unit's finish.
- It is important that no liquid reach the inside of the unit.

Compact Discs

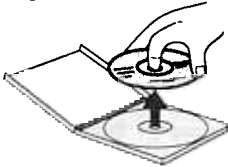

- Remove the CD from the case by holding it at the edges while pressing the center hole lightly.
- Do not touch the shiny surface of the CD, or bend the CD.

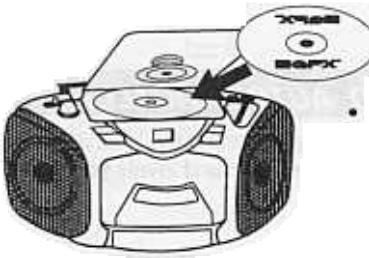

- Place the CD into the open tray positioned with label facing up.



A dirty CD may not play correctly. If a CD becomes dirty, wipe it with a soft cloth in a straight line from center to edge.

CAUTION : Do not use any solvent (eg : record sprays, thinner, benzene, etc.) to clean a CD.

- Put the CD back in its case after use to prevent warping.
- Be careful not to scratch the surface of the CD when placing it back in the case.
- Avoid exposure to direct sun light, temperature extremes, and moisture.

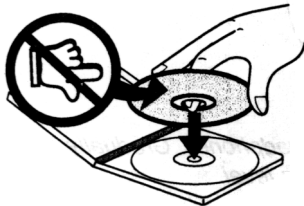

CASSETTE TAPES

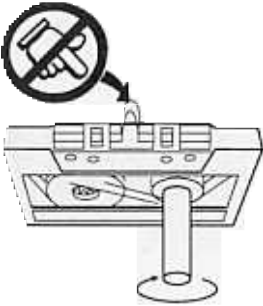

- If the tape is loose in its cassette, take up the slack by inserting a pencil in one of the reels and rotating
- If the tape is loose it may get stretched, cut, or caught in the cassette player.
- Do not touch the tape surface.

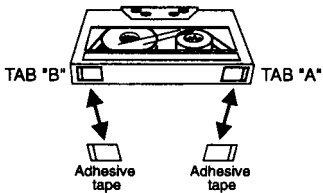

- To prevent recordings from being erased accidentally, remove the tab(s) A and B.
- To record after the tabs have been broken off, reseal the A and B with a piece of adhesive tape.

Cleaning the Tape Heads and Tape Path

For continued high performance from your cassette deck, periodically clean the head, pinch roller, and capstan. We recommend cleaning after every 20-30 hours of operation.

To clean the tape deck, press the STOP/EJECT key to open the deck door. Remove any tape in the deck. Make sure that the power to the unit is OFF. Moisten a cotton swab with isopropyl alcohol or a special head cleaning fluid. Carefully rub the face of each head, pinch roller, and capstan with the moistened cotton swab.

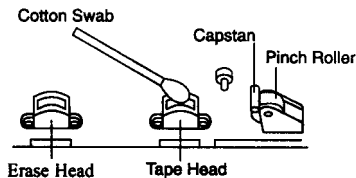

SPECIFICATION

POWER SOURCE :

AC: 120V - 60Hz
BATTERIES : 8 X C CELLS (LR14 OR EQUIVALENT)

RADIO FREQUENCY COVERAGE

FM: 88 -108MHz
AM: 530 - 1710kHz

RECORDING SYSTEM

RECORDING SYSTEM : DC BIAS
ERASING SYSTEM : MAGNETIC ERASE

GENERAL

SPEAKER 32 OHMS
POWER OUTPUT 1.8 WATT AT 10% T.H.D. PER CHANNEL
HEADPHONES: 3.5MM STEREO JACK PLUG. 8 - 32 Ω

CD PLAYER

PICK UP: 3-BEAM, SEMICONDUCTOR LASER
ENCODING: 1 BIT LINEAR 8 X OVERSAMPLING

TROUBLESHOOTING GUIDE

BEFORE REQUESTING SERVICE, PLEASE REFER TO THE FOLLOWING CHART FOR THE SYMPTOM AND POSSIBLE SOLUTION.

SYMPTOMS	POSSIBLE CAUSES	POSSIBLE SOLUTIONS
CD PLAYER		
CD PLAYER WILL NOT OPERATE	FUNCTION SELECTOR SWITCH NOT SET TO CD POSITION	SET FUNCTION SELECTOR SWITCH TO CD POSITION.
	CD NOT INSTALLED OR INSTALLED UPSIDE DOWN.	INSERT CD WITH LABEL SIDE UP.
CD SKIP WHILE PLAYING.	DISC IS DIRTY OR SCRATCHED.	WIPE DISC WITH A SOFT CLOTH OR TRY ANOTHER DISC.
RADIO		
FM STEREO INDICATOR DOESN'T LIGHT	STATION NOT PROPERLY TUNED. BAND/FM MODE SWITCH IS SET TO FM POSITION OR STATION IS BROADCASTING IN MONO.	RETUNE THE FM STATION. SET BAND/FM MODE SWITCH TO FM STEREO POSITION OR TUNE TO A STEREO BROADCAST STATION.
NOISE OR SOUND DISTORTED ON AM OR FM BROADCASTS	FM TELESCOPIC ANTENNA NOT EXTENDED OR WEAK STATION.	FM - EXTEND THE TELESCOPIC ANTENNA. AM - ROTATE UNIT UNTIL BEST RECEPTION IS OBTAINED.
NO SOUND	STATION NOT PROPERLY TUNED.	RETUNE AM OR FM STATION.
	FUNCTION SELECTOR SWITCH NOT SET TO RADIO POSITION.	SET FUNCTION SELECTOR SWITCH RADIO POSITION.
	VOLUME CONTROL IS AT MINIMUM POSITION.	INCREASE VOLUME.
CASSETTE		
NO SOUND	FUNCTION SELECTOR SWITCH NOT SET TO TAPE POSITION.	SET FUNCTION SELECTOR SWITCH TO TAPE POSITION.
	NO RECORDING ON TAPE.	CHECK CASSETTE.
CASSETTE DOES NOT PLAY THE PLAYBACK	PLAY BUTTON IS NOT PRESSED OR THE TAPE MUST BE REWOUND.	PRESS THE PLAY BUTTON OR TAPE.
SOUND DISTORTION OR SLOW ERRATIC SPEED.	DIRTY HEAD, TAPE TOO OLD OR WORN OUT.	CLEAN THE HEAD OR REPLACE PRE-RECORDED CASSETTE TAPE.
WEAK OR DISTORTED RECORDING.	CASSETTE TAPE IS POOR QUALITY OR BATTERIES ARE WEAK.	CHANGE TO ANOTHER CASSETTE TAPE. CHECK BATTERIES.
GENERAL		
NO SOUND	AC CORD NOT CONNECTED PROPERLY OR WEAK OR DEAD BATTERIES.	CHECK AC CORD CONNECTIONS OR REPLACE WEAK OR DEAD BATTERIES.
	HEADPHONE PLUGGED INTO PHONE JACK.	REMOVE HEADPHONE PLUG FROM JACK.
	VOLUME CONTROL SET TO MINIMUM.	INCREASE THE VOLUME.

Customer Service : 1-800-919-3647



LIMITED WARRANTY
AUDIO

We at Memorex believe you will be pleased with your new product. Please read this Warranty Carefully. Memorex warrants this product to be free from manufacturing defects including original parts and workmanship for a period of ninety (90) days from the date of original purchase in, and if used in, the United States.

Should you find your unit is not operating properly during the terms of full coverage of this warranty, ninety (90) days, you should contact your original place of purchase for an exchange with a valid receipt. If necessary, Memorex will provide one of the following options (at Memorex's discretion), providing the manufacturing defect is verified along with the date of purchase.

- Repair service for ninety (90) days from date of original purchase at no charge for labor and parts at their authorized warranty service facility, providing the manufacturing defect is verified along with the date of purchase.
- Replacement of defective unit with either a new, refurbished, or equivalent model at no charge for ninety (90) days from date of original purchase.

This warranty is void if the product is:

- A) Damaged through negligence, abuse, misuse, accident, or acts of God.
- B) Used in commercial applications or retails.
- C) Modified or repaired by anyone other than Memorex or their expressly authorized representative.
- D) Damage resulting from the improper connection to equipment of other manufactures.

This warranty does not cover:

- A) Cost incurred in the shipping of the product to and from the Memorex authorized repair facility listed.
- B) Damage or improper operation caused by the failure to follow the operating instructions provided with the product.
- C) Routine adjustments to the product, which can be performed by the customer as outlined in the owner's manual.
- D) Signal reception problems caused by external factors.
- E) Products not purchased in the United States.
- F) Damage to the products used outside the United States.
- G) Damage to audiocassette tapes.
- H) Damage to compact disc.

In the event that service is required under this warranty,, please contact CUSTOMER SERVICE at 1-800-919-3647 or contact our website at www.memorex.com.

THIS WARRANTY IS NON-TRANSFERABLE AND APPLIES SOLELY TO THE ORIGINAL PURCHASER AND DOES NOT EXTEND TO SUBSEQUENT OWNERS OF THE PRODUCT. ANY APPLICABLE IMPLIED WARRANTIES, INCLUDING THE WARRANTY OF MERCHANTABILITY, ARE LIMITED IN DURATION TO A PERIOD OF THE EXPRESSED WARRANTY AS PROVIDED HEREIN BEGINNING WITH THE DATE OF THE ORIGINAL PURCHASE AT RETAIL AND NO WARRANTIES, WHETHER EXPRESSED OR IMPLIED SHALL APPLY TO THE PRODUCT THEREAFTER. MEMOREX MAKES NO WARRANTY AS TO THE FITNESS OF THE PRODUCT FOR ANY PARTICULAR PURPOSE OR USE.

THE EXTENT OF MEMOREX'S LIABILITY UNDER THIS LIMITED WARRANTY IS THE REPAIR OR REPLACEMENT PROVIDED ABOVE AT THE SOLE DISCRETION OF MEMOREX. IN NO EVENT SHALL MEMOREX'S LIABILITY EXCEED THE PURCHASE PRICE PAID BY THE DIRECT, INDIRECT INCIDENTAL, FORESEEN, UNFORESEEN, SPECIAL, OR CONSEQUENTIAL DAMAGE ARISING OUT OF OR IN CONNECTION WITH THE SUE OF THIS PRODUCT.

THIS WARRANTY IS VALID ONLY IN THE UNITED STATES. THIS WARRANTY GIVES YOU SPECIFIC LEGAL RIGHTS, HOWEVER, YOU MAY HAVE OTHER RIGHTS WHICH MAY VARY FROM STATE TO STATE. SOME STATES DO NOT ALLOW LIMITATIONS ON IMPLIED WARRANTIES OR EXCLUSION OF CONSEQUENTIAL DAMAGE, THEREFORE THESE RESTRICTIONS MAY NOT APPLY TO YOU.

(c) 2000. Memorex is a registered trademark of Memorex Telex N.V.



Memcorp, Inc.
Weston, FL33331

© 2000 Memorex is a registered trademark of Memorex Telex N.V.
Printed in Hong Kong

Visit our website at www.memorex.com

Free Manuals Download Website

<http://myh66.com>

<http://usermanuals.us>

<http://www.somanuals.com>

<http://www.4manuals.cc>

<http://www.manual-lib.com>

<http://www.404manual.com>

<http://www.luxmanual.com>

<http://aubethermostatmanual.com>

Golf course search by state

<http://golfingnear.com>

Email search by domain

<http://emailbydomain.com>

Auto manuals search

<http://auto.somanuals.com>

TV manuals search

<http://tv.somanuals.com>