

Memorex®

Is it live or is it Memorex?™

MP3126

User's Guide

Portable CD Player with
AM/FM Stereo Radio and
Cassette Recorder

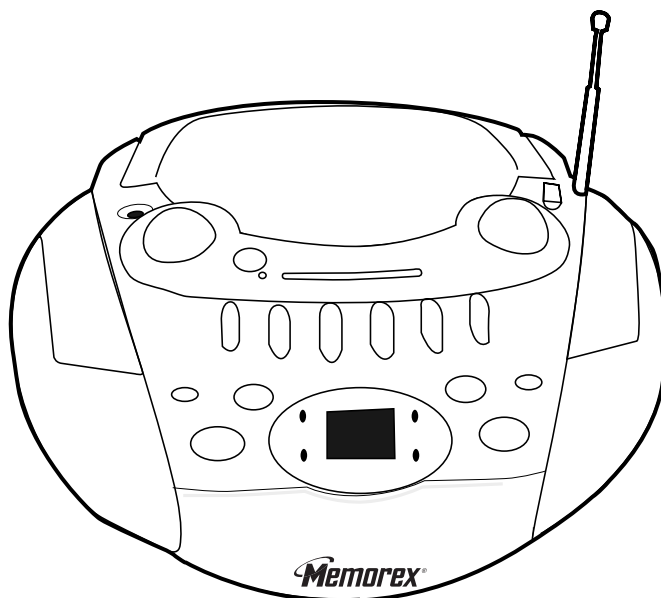

**Before operating this product,
please read these instructions completely.**



Dear Customer,

Please read this manual thoroughly before operating the unit to become more familiar with it and obtain the performance that will bring you continued enjoyment for many years. Keep these instructions handy for future reference.

PLEASE KEEP ALL PACKAGING MATERIAL FOR AT LEAST 90 DAYS IN CASE YOU NEED TO RETURN THIS PRODUCT TO YOUR PLACE OF PURCHASE OR MEMOREX.

For future reference, record the serial number of the unit printed on the rear of the cabinet.

Serial Number _____

	CAUTION RISK OF ELECTRIC SHOCK DO NOT OPEN	
CAUTION: TO REDUCE THE RISK OF ELECTRIC SHOCK, DO NOT REMOVE COVER (OR BACK). NO USER-SERVICEABLE PARTS INSIDE. REFER SERVICING TO QUALIFIED SERVICE PERSONNEL.		

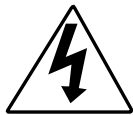
**DANGEROUS VOLTAGE:**

The lightning flash with arrowhead symbol, within an equilateral triangle is intended to alert the user to the presence of uninsulated dangerous voltage within the product's enclosure that may be of sufficient magnitude to constitute a risk of electric shock to persons.

**ATTENTION:**

The exclamation point within an equilateral triangle is intended to alert the user to the presence of important operating and maintenance (servicing) instructions in the literature accompanying the appliance.

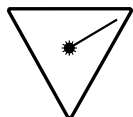
**DANGER:**

Invisible and hazardous laser radiation when open and interlock failed or defeated. Avoid direct exposure to beam.

FCC WARNING:

This equipment may generate or use radio frequency energy. Changes or modifications to this equipment may cause harmful interference unless the modifications are expressly approved in the instruction manual. The user could lose the authority to operate this equipment if an unauthorized change or modification is made.

LASER SAFETY: This unit employs a laser. Only qualified service personnel should attempt to service this device due to possible eye injury.

CAUTION: USE OF CONTROLS, ADJUSTMENTS OR PERFORMANCE PROCEDURE HEREIN MAY RESULT IN HAZARDOUS RADIATION EXPOSURE.

INFORMATION:

This equipment has been tested and found to comply with the limits for a Class B digital device, pursuant to Part 15 of the FCC Rules. These limits are designed to provide reasonable protection against harmful interference in a residential installation. This equipment generates, uses, and can radiate radio frequency energy and, if not installed and used in accordance with the instructions, may cause harmful interference to radio communications. However, there is no guarantee that interference will not occur in a particular installation. If this equipment does cause harmful interference to radio or television reception, which can be determined by turning the equipment off and on, the user is encouraged to try to correct the interference by one or more of the following measures:

- Reorient or relocate the receiving antenna.
- Increase the separation between the equipment and receiver.
- Connect the equipment into an outlet on a circuit different from that to which the receiver is connected.
- Consult the dealer or an experienced radio/TV technician for help.

WARNING: TO PREVENT FIRE OR SHOCK HAZARD, DO NOT EXPOSE THIS UNIT TO RAIN OR MOISTURE.

SURGE PROTECTORS:

It is recommended to use a surge protector for AC connection. Lightning and power surges ARE NOT covered under warranty for this product.

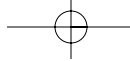

Dear Customer:

Selecting fine audio equipment such as the unit you've just purchased is only the start of your musical enjoyment. Now it's time to consider how you can maximize the fun and excitement your equipment offers. This manufacturer and the Electronic Industries Association's Consumer Electronics Group want you to get the most out of your equipment by playing it at a safe level. One that lets the sound come through loud and clear without annoying blaring or distortion and, most importantly, without affecting your sensitive hearing. Sound can be deceiving. Over time your hearing "comfort level" adapts to higher volumes of sound. So what sounds "normal" can actually be loud and harmful to your hearing. Guard against this by setting your equipment at a safe level BEFORE your hearing adapts.

To establish a safe level:

- Start your volume control at a low setting.
- Slowly increase the sound until you can hear it comfortably and clearly, and without distortion.

Once you have established a comfortable sound level:

- Set the dial and leave it there.

Taking a minute to do this now will help to prevent hearing damage or loss in the future. After all, we want you listening for a lifetime.

We Want You Listening For A Lifetime

Used wisely, your new sound equipment will provide a lifetime of fun and enjoyment. Since hearing damage from loud noise is often undetectable until it is too late, this manufacturer and the Electronic Industries Association's Consumer Electronics Group recommend you avoid prolonged exposure to excessive noise. This list of sound levels is included for your protection.

Decibel

<u>Level</u>	<u>Example</u>
30	Quiet library, soft whispers
40	Living room, refrigerator, bedroom away from traffic
50	Light traffic, normal conversation, quiet office
60	Air conditioner at 20 feet, sewing machine
70	Vacuum cleaner, hair dryer, noisy restaurant
80	Average city traffic, garbage disposals, alarm clock at two feet

THE FOLLOWING NOISES CAN BE DANGEROUS UNDER CONSTANT EXPOSURE:

90	Subway, motorcycle, truck traffic, lawn mower
100	Garbage truck, chain saw, pneumatic drill
120	Rock band concert in front of speakers, thunderclap
140	Gunshot blast, jet engine
180	Rocket launching pad

Information courtesy of the Deafness Research Foundation.



SAFETY INSTRUCTIONS

Before using the unit, be sure to read all operating instructions carefully. Please note that these are general precautions and may not pertain to your unit. For example, this unit may not have the capability to be connected to an outdoor antenna.

1. READ INSTRUCTIONS

All the safety and operating instructions should be read before the product is operated.

2. RETAIN INSTRUCTIONS

The safety and operating instructions should be retained for future reference.

3. HEED WARNINGS

All warnings on the product and in the operating instructions should be adhered to.

4. FOLLOW INSTRUCTIONS

All operating and use instructions should be followed.

5. CLEANING

Unplug this product from the wall outlet before cleaning. Do not use liquid cleaners or aerosol cleaners. Use a damp cloth for cleaning.

6. ATTACHMENTS

Do not use attachments not recommended by the product's manufacturer as they may cause hazards.

7. WATER AND MOISTURE

Do not use this product near water- for example, near a bathtub, washbowl, kitchen sink, or laundry tub, in a wet basement, or near a swimming pool.

8. ACCESSORIES

Do not place this product on an unstable cart, stand, tripod, bracket, or table. The product may fall, causing serious injury and serious damage to the product. Use only with a cart, stand, tripod, bracket, or table recommended by the manufacturer or sold with the product. Any mounting of the product should follow the manufacturer's instructions, and should use a mounting accessory recommended by the manufacturer.

PORTABLE CART WARNING
(symbol provided by RETAC)



- 8A. An appliance and cart combination should be moved with care. Quick stops, excessive force, and uneven surfaces may cause the appliance and cart combination to overturn.

9. VENTILATION

Slots and openings in the cabinet and in the back or bottom are provided for ventilation and to ensure reliable operation of the product and to protect it from overheating. These openings must not be blocked or covered. The openings should never be blocked by placing the product on a bed, sofa, rug, or other similar surface. This product should never be placed near or over a radiator or heat source. This product should not be placed in a built-in installation such as a bookcase or rack unless proper ventilation is provided or the manufacturer's instructions have been adhered to.

10. POWER SOURCES

This product should be operated only from the type of power source indicated on the marking label. If you are not sure of the type of power supply to your home, consult your appliance dealer or local power company. For products intended to operate from battery power, or other sources, refer to the operating instructions.

11. GROUNDING OR POLARIZATION

This product is equipped with a polarized alternating-current line plug (a plug having one blade wider than the other). This plug will fit into the power outlet only one way. This is a safety feature. If you are unable to insert the plug fully into the outlet, try reversing the plug. If the plug should still fail to fit, contact your electrician to replace your obsolete outlet. Do not defeat the safety purpose of the polarized plug.

12. POWER-CORD PROTECTION

Power-supply cords should be routed so that they are not likely to be walked on or pinched by items placed upon or against them, paying particular attention to cords at plugs, convenience receptacles, and the point where they exit from the appliance.

13. LIGHTNING

To protect your product from a lightning storm, or when it is left unattended and unused for long periods of time, unplug it from the wall outlet and disconnect the antenna or cable system. This will prevent damage to the product due to lightning and power-line surges.

14. POWER LINES

An outside antenna system should not be located in the vicinity of overhead power lines or other electric light or power circuits, or where it can fall into such power lines or circuits. When installing an outside antenna system, extreme care should be taken to keep from touching such power lines or circuits as contact with them might be fatal.

15. OVERLOADING

Do not overload wall outlets and extension cords as this can result in a risk of fire or electric shock.

16. OBJECT AND LIQUID ENTRY

Never push objects of any kind into this product through openings as they may touch dangerous voltage points or short out parts that could result in fire or electric shock. Never spill or spray any type of liquid on the product.

17. OUTDOOR ANTENNA GROUNDING

If an outside antenna is connected to the product, be sure the antenna system is grounded so as to provide some protection against voltage surges and built-up static charges. Section 810 of the National Electric Code, ANSI/NFPA 70, provides information with respect to proper grounding of the mast and supporting structure, grounding of the lead-in wire to an antenna discharge product, size of grounding conductors, location of antenna discharge product, connection to grounding electrodes, and requirements for grounding electrode.

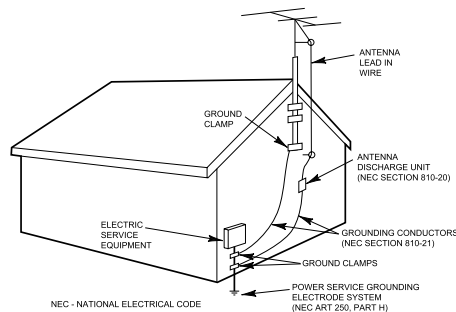

EXAMPLE OF ANTENNA GROUNDING AS PER NATIONAL ELECTRICAL CODE

18. SERVICING

Do not attempt to service this product yourself as opening or removing covers may expose you to dangerous voltage or other hazards. Refer all servicing to qualified service personnel.

19. REPLACEMENT PARTS

When replacement parts are required, be sure the service technician uses replacement parts specified by the manufacturer or those that have the same characteristics as the original part. Unauthorized substitutions may result in fire, electric shock or other hazards.

20. SAFETY CHECK

Upon completion of any service or repairs to this product, ask the service technician to perform safety checks to determine that the product is in proper operating condition.

21. WALL OR CEILING MOUNTING

The product should be mounted to a wall or ceiling only as recommended by the manufacturer.

22. DAMAGE REQUIRING SERVICE

Unplug the product from the wall outlet and refer servicing to qualified service personnel under the following conditions:

- When the power-supply cord or plug is damaged.
- If liquid has been spilled, or objects have fallen into the product.
- If the product has been exposed to rain or water.
- If the product does not operate normally by following the operating instructions. Adjust only those controls that are covered by the operating instructions, as an adjustment of other controls may result in damage and will often require extensive work by a qualified technician to restore the product to its normal operation.
- If the product has been dropped or the cabinet has been damaged.
- When the product exhibits a distinct change in performance - this indicates a need for service.

23. HEAT

The product should be situated away from heat sources such as radiators, heat registers, stoves, or other products (including amplifiers) that produce heat.

24. NOTE TO CATV SYSTEM INSTALLER

This reminder is provided to call the CATV system installer's attention to Article 820-40 of the NEC that provides guidelines for proper grounding and, in particular, specifies that the cable ground shall be connected to the grounding system of the building, as close to the point of cable entry as practical.

LOCATION OF CONTROLS

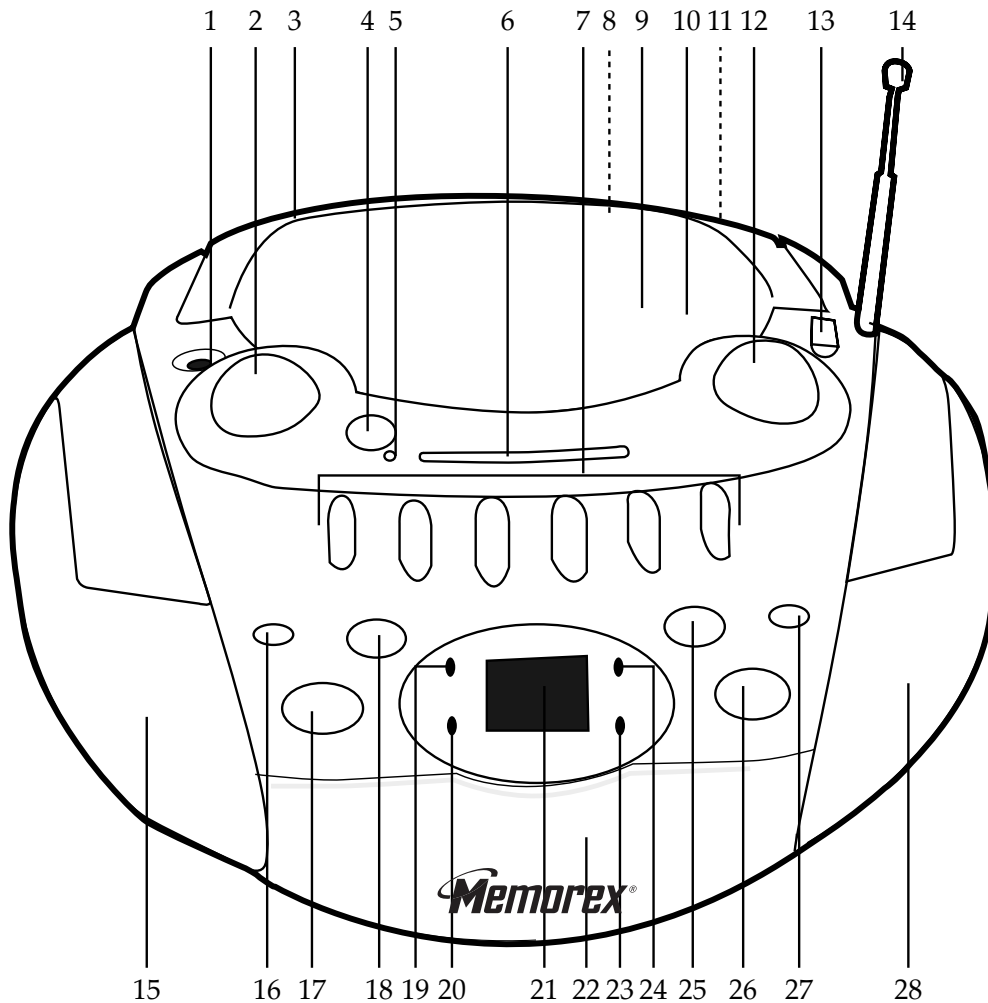

- | | |
|---|--|
| <ol style="list-style-type: none"> 1. PHONES (Headphones) Jack 2. VOLUME Control 3. Carrying Handle 4. X-BASS Button 5. FM STEREO Indicator 6. AM/FM Dial Scale and Pointer 7. Cassette Buttons (left to right):
PAUSE ()
STOP/EJECT (■)
F.FWD (◀◀)
REWIND (▶▶)
PLAY (◀)
RECORD (●) 8. Battery Compartment (Rear of Unit) 9. CD Compartment 10. CD Door OPEN/CLOSE Area 11. AC Power Jack (Rear of Unit) 12. TUNING Control | <ol style="list-style-type: none"> 13. Function Switch (POWER OFF/TAPE/CD/FM/AM) 14. FM Antenna 15. Speaker 16. REPEAT Button 17. STOP (■) Button 18. Skip/Search (◀◀) Button 19. POWER Indicator 20. REPEAT Indicator 21. Display 22. Cassette Compartment 23. PROGRAM Indicator 24. PLAY/PAUSE Indicator 25. Skip/Search (▶▶) Button 26. PLAY/PAUSE (▶/) Button 27. PROGRAM Button 28. Speaker |
|---|--|

POWER SOURCES

This unit is designed to operate on AC household current or DC (batteries).

AC:

Use the AC polarized line cord included with the unit for operation on AC power. Insert one end of the AC line cord into the AC power jack on the rear of the unit and the other end (with the 2 blades) into a conveniently located AC outlet having 120V, 60Hz. When the AC cord is plugged in, the batteries will be disconnected.

NOTE: The AC plug supplied with the unit is polarized to help minimize the possibility of electric shock. If the AC plug does not fit into a nonpolarized AC outlet, do not file or cut the wide blade. It is the user's responsibility to have an electrician replace the obsolete outlet.

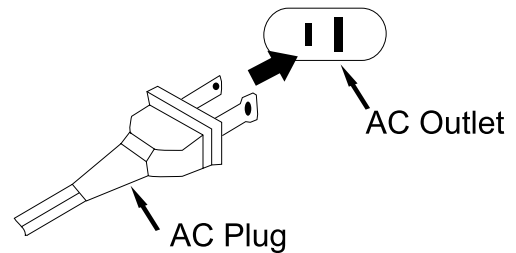

BATTERY INSTALLATION

To use this unit with battery power, remove the battery compartment on the rear of the unit by pressing in on the two tabs and lifting the battery door off. Insert eight (8) 'C' size batteries following the diagram in the compartment.

NOTE: The AC power cord must be disconnected from the AC power jack on the rear of the unit in order for the unit to operate on battery power.

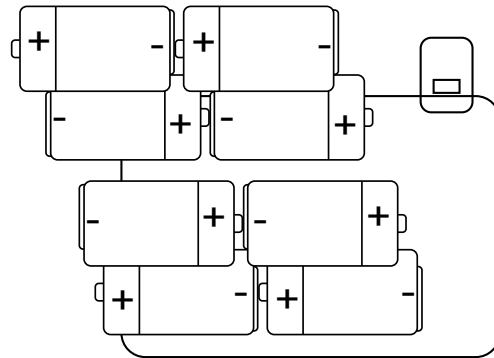

BATTERY PRECAUTIONS

Follow these precautions when using batteries in this device:

1. Use only the size and type of batteries specified.
2. Be sure to follow the correct polarity when installing the batteries as indicated in the battery compartment. Reversed batteries may cause damage to the device.
3. Do not mix different types of batteries together (e.g. Alkaline and Carbon-zinc) or old batteries with fresh ones.
4. If the device is not to be used for a long period of time, remove the batteries to prevent damage or injury from possible battery leakage.
5. Do not try to recharge batteries not intended to be recharged; they can overheat and rupture. (Follow battery manufacturer's directions.)

HEADPHONE JACK

For private listening, connect low impedance 3.5mm (32 ohm) stereo headphones (not included) to this jack. The speakers are automatically disconnected when the headphone plug is inserted in the jack.

RADIO OPERATION

TO PLAY THE RADIO

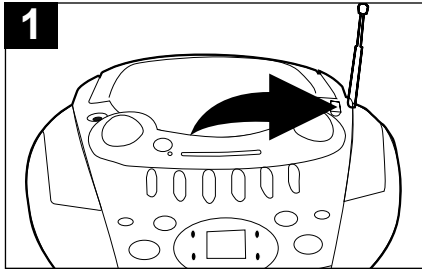

Slide the Function switch to select AM or FM; the POWER indicator will light.

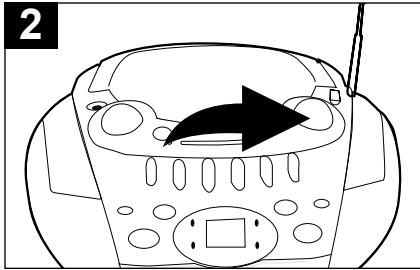

Tune a desired station by turning the TUNING control. If an FM station is selected, and is broadcasting an FM stereo station, the FM STEREO indicator will light.

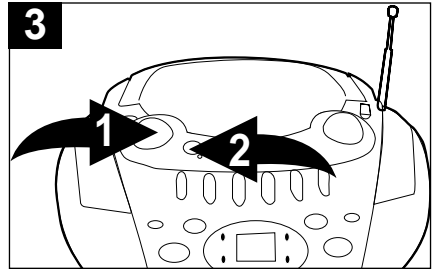

Adjust the VOLUME ❶ control and X-BASS ❷ button as desired. Press the X-BASS button ❷ to the in position to enhance the bass sound.

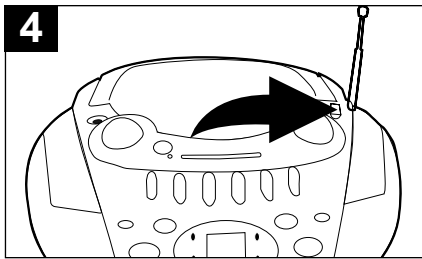

To turn the radio off, slide the Function switch to the OFF position; the POWER indicator will go off.

ANTENNAS

AM – This unit has a built-in ferrite rod antenna, which provides adequate reception in most areas. If reception is weak, turn the unit to improve reception.

FM – The FM Antenna is for FM reception only. If reception is weak, adjust the length and the angle of the antenna.

COMPACT DISC (CD) OPERATION

TO INSERT A CD

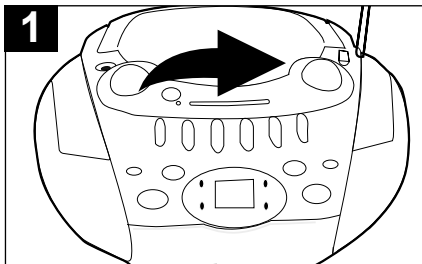

Open the CD compartment by pressing the CD Door OPEN/CLOSE area. Place a disc on the spindle, label side up, and close the CD compartment door.

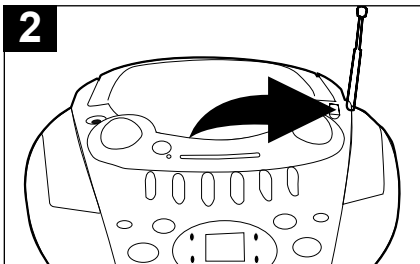

Slide the Function switch to the CD position; the POWER indicator will light.

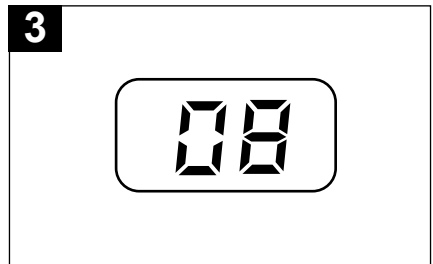

The total number of tracks will be displayed and the CD player will stop.

COMPACT DISC (CD) OPERATION (CONTINUED)

TO PLAY A CD (STANDARD CD, CD-R AND CD-RW CAN BE USED)

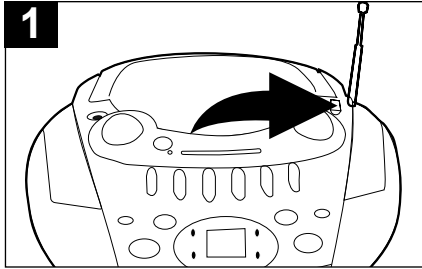

Slide the Function switch to the CD position; the POWER indicator will light. Insert a CD as described in the TO INSERT A CD section on page 6.

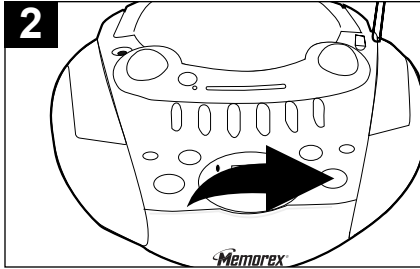

To play a disc from the beginning, press the PLAY/PAUSE (▶/||) button. Press the PLAY/PAUSE (▶/||) button again to pause playback; the CD track will blink in the display.

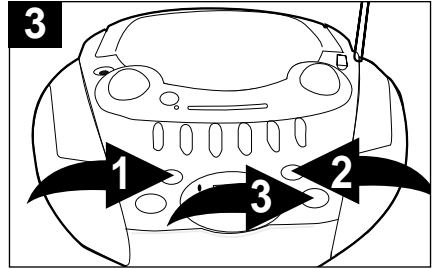

To start from a specific track, locate the track using the Skip/Search (◀◀) ❶ or (▶▶) ❷ button and press the PLAY/PAUSE (▶/||) button ❸.

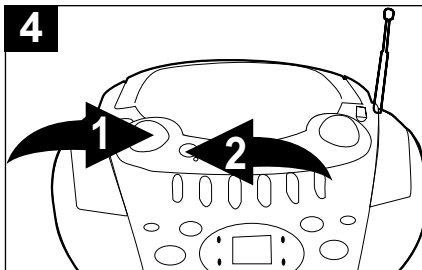

Adjust the VOLUME ❶ control and X-BASS ❷ button as desired. Press the X-BASS button ❷ to the in position to enhance the bass sound.

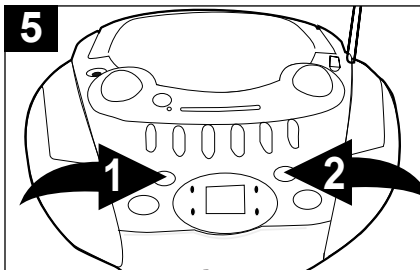

To skip forward or backward through the tracks on the disc, press the Skip/Search (◀◀) ❶ or (▶▶) ❷ button.

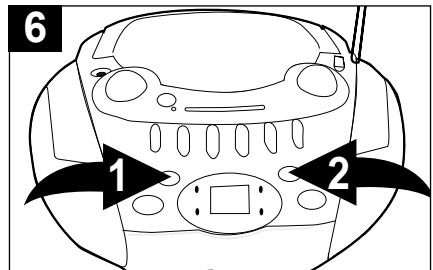

To search forward or backward through the music on a disc, press and hold the Skip/Search (◀◀) ❶ or (▶▶) ❷ button, a chattering noise will be heard.

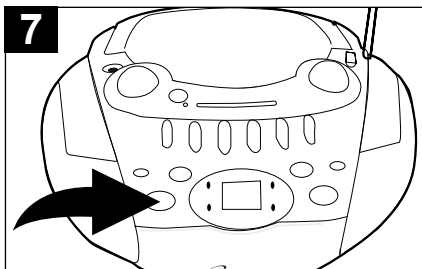

When the disc is through playing, it will stop rotating. Press the STOP (■) button to stop the disc before it is finished.

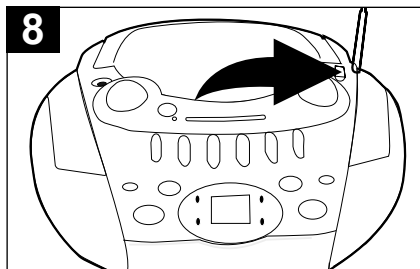

To turn the unit off, slide the Function switch to the OFF position; the POWER indicator will go off.

FAQS:

Do I need an adapter to play 3" singles?
No, simply insert the 3" single into the groove.

What is the maximum time for a CD in this unit?
The maximum time is 74 minutes.

What type of CDs can I play?
CD, CD-Rs and CD-RWs can be used.

NOTES:

- If a disc is inserted incorrectly, dirty, damaged or not present at all, it will not play.
- As each track is played, the track number is shown in the display.
- To prevent damage to the disc, never open the CD door while the disc is rotating. Wait for the disc to stop before opening the CD door. Never touch the lens when the CD compartment door is open.
- DO NOT use the carrying handle when playing a CD. The CD should only be used on a steady surface.

COMPACT DISC (CD) OPERATION (CONTINUED)

TO REPEATEDLY PLAY BACK ONE TRACK

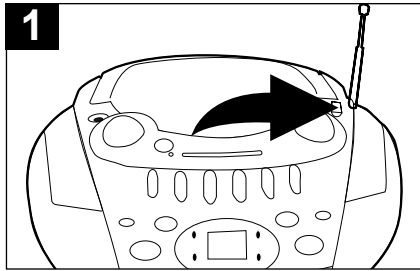

Slide the Function switch to the CD position and insert a CD as described in the TO INSERT A CD section on page 6.

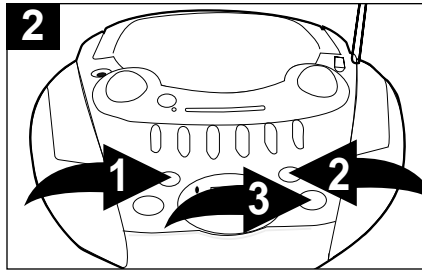

Select a track using the Skip/Search (◀) ❶ or (▶) ❷ button and press the PLAY/PAUSE (▶/||) button ❸.

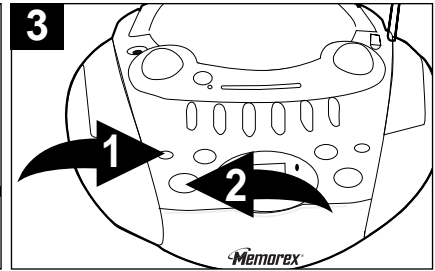

Press the REPEAT button ❶ once, the REPEAT indicator will blink and the unit will play the selected track over and over until the STOP (■) button ❷ is pressed.

TO REPEATEDLY PLAY BACK ALL TRACKS

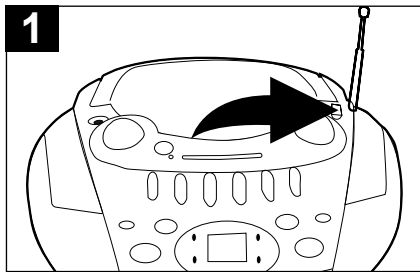

Slide the Function switch to the CD position and insert a CD as described in the TO INSERT A CD section on page 6.

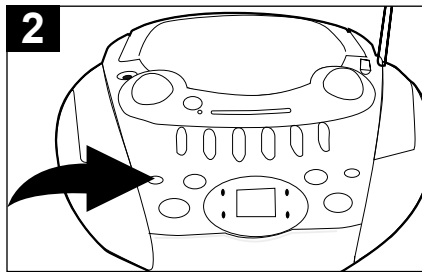

Press the REPEAT button twice, the REPEAT indicator will light.

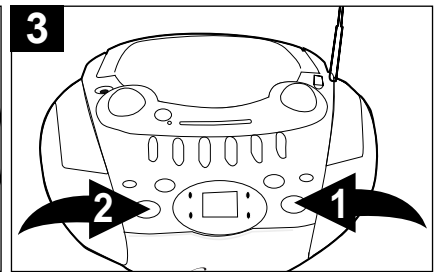

Press the PLAY/PAUSE button ❶ to begin playback and the unit will play the entire disc over and over until the STOP (■) button ❷ is pressed.

NOTE:

To stop and cancel Repeat playback, press the STOP (■) button.

COMPACT DISC (CD) OPERATION (CONTINUED)

TO PROGRAM THE MEMORY (UP TO 32 TRACKS)

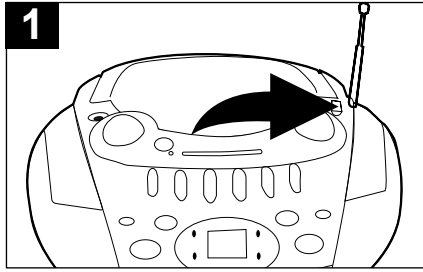

Slide the Function switch to the CD position; the POWER indicator will light. Insert a CD as described in the TO INSERT A CD section on page 6.

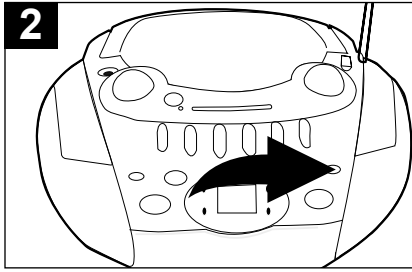

Press the PROGRAM button; the PROGRAM indicator will blink.

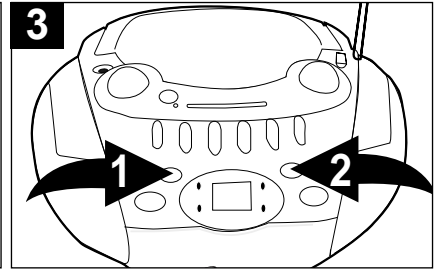

Use the Skip/Search (◀◀) ❶ or (▶▶) ❷ button to select the first track to be programmed.

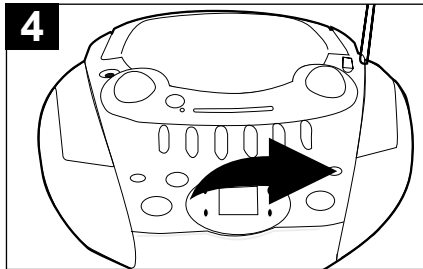

Press the PROGRAM button again; the selected track has now been programmed and counted as program 1.

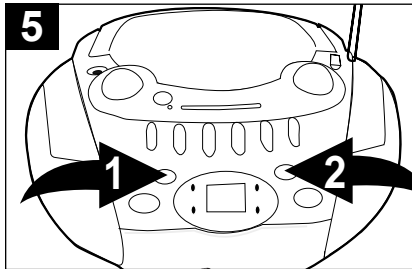

Repeat steps 3 and 4 to program the other desired tracks in sequence (up to 32 tracks).

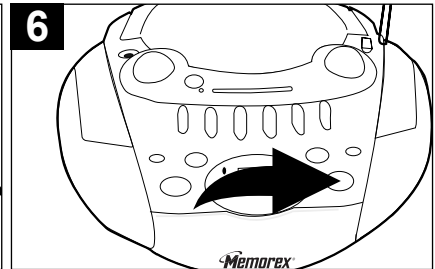

Press the PLAY/PAUSE (▶||) button to begin playback; the Program indicator will light and the tracks will play in the order programmed.

NOTES:

- Programming is the ability to preselect the order in which a series of tracks will be played.
- Each track may be stored in the program memory as many times as desired (up to 32 tracks).
- As each track is played, its track number will be displayed. You can move forward or backward through the programmed tracks with the Skip/Search ◀◀ or ▶▶ button.
- The CD player will stop after all programmed tracks have been played or the STOP (■) button is pressed.
- To cancel programmed playback, press the STOP (■) button while in the stop mode, or open the CD Door.
- To check the program, press the PROGRAM button once more, "01" will blink in display, then the first selected track will blink in the display. Press the PROGRAM button again, "02" will blink in the display, then the second selected track will blink in the display. Press PROGRAM button repeatedly to check the other programmed tracks.

CASSETTE OPERATION

PLAYING CASSETTE TAPES

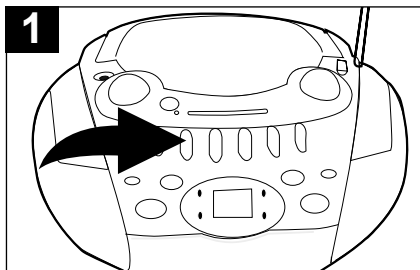

1 Press the STOP/EJECT (■) button to open the cassette compartment.

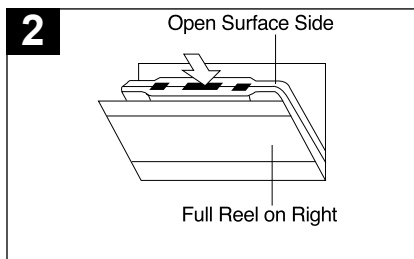

2 Insert a pre-recorded cassette into the slots in the Cassette Door with the open end facing up and the full reel on the right side. Close the cassette door.

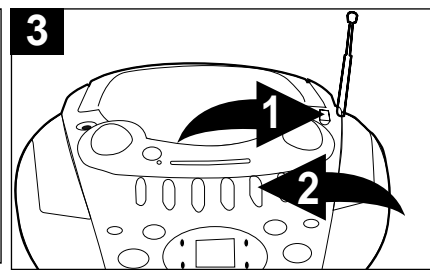

3 Slide the Function switch ❶ to the TAPE position, then press the PLAY (◀) button ❷ to begin playback.

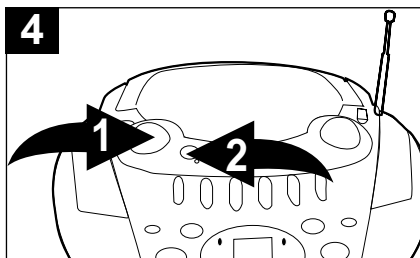

4 Adjust the VOLUME ❶ control and X-BASS ❷ button as desired. Press the X-BASS button ❷ to the in position to enhance the bass sound.

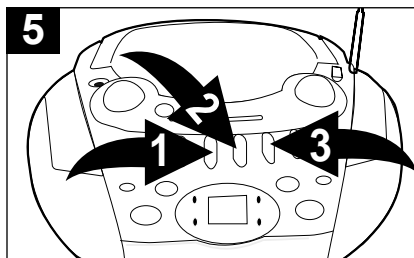

5 To advance or rewind the tape rapidly, press either the F.FWD (◀◀) ❶ or REWIND (▶▶) ❷ button. When you reach the desired point, press the PLAY (▶) button ❸ to resume normal playback.

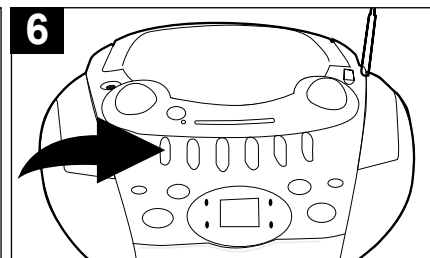

6 To pause playback momentarily, press the PAUSE (||) button. The tape movement stops but the tape motor is still running. Press the PAUSE (||) button again to release pause and resume normal playback.

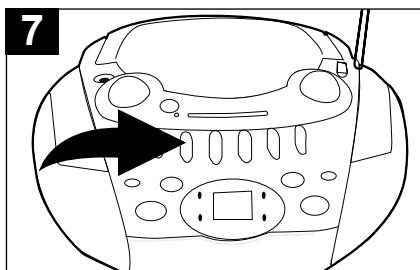

7 To stop playback before the tape ends, press the STOP/EJECT (■) button. The PLAY (▶) button is released and the tape motor shuts off.

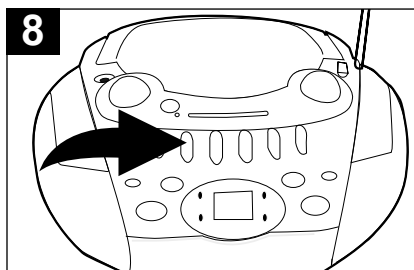

8 When the tape reaches the end, the auto-stop mechanism activates, the PLAY (▶) button is released and the tape motor shuts off. Press the STOP/EJECT (■) button to open the cassette compartment and remove the cassette.

CASSETTE OPERATION (CONTINUED)

MAKING A TAPE RECORDING

The tape recorder in this system allows you to make direct recordings from the radio or CD player to a blank cassette in the tape compartment. An automatic recording volume level control (ALC) circuit will automatically control the volume level of your recordings to prevent distortion. You may change the settings of the volume or the Bass Boost during a tape recording, as these controls have no effect on the material being recorded onto the tape.

To make a tape recording, proceed as follows:

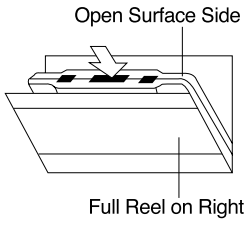
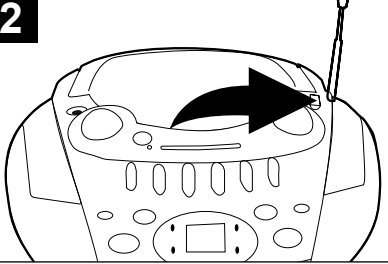
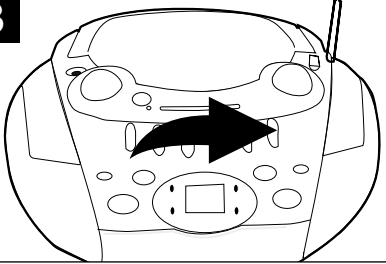
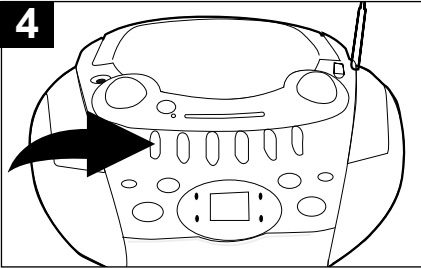
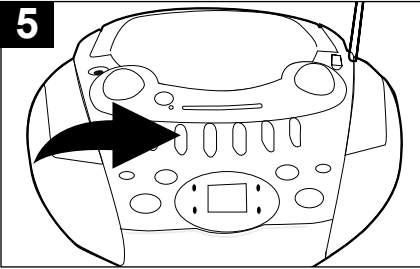
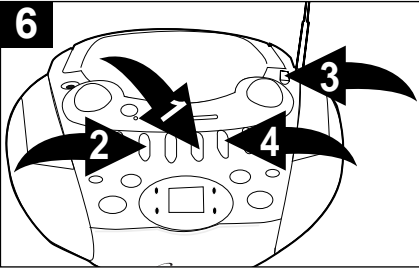
<p>1</p> 	<p>2</p> 	<p>3</p> 
<p>Open the Cassette Door and insert a good quality blank cassette tape into the slots on the door, with the open end facing up and the full reel on the right side. Close the Cassette Door.</p>	<p>Slide the Function switch to select the function you wish to record, either CD, AM or FM, and operate that function according to its own instructions.</p>	<p>When you are ready to begin recording, press the RECORD (●) button. The PLAY (◀) button will also engage. The tape will begin moving and all of the material from your selected source will be recorded on the tape.</p>
<p>4</p> 	<p>5</p> 	<p>6</p> 
<p>To avoid recording unwanted material, such as radio commercials, use the PAUSE () button to stop the recording temporarily. Release the PAUSE () button to begin recording again.</p>	<p>When you are finished recording, press the STOP/EJECT (■) button to stop the tape.</p>	<p>If you wish to listen to your recording immediately, press the cassette REWIND (▶▶) button ❶ until the tape rewinds to the beginning, then press the STOP/EJECT (■) button ❷. Slide the Function switch ❸ to the TAPE/POWER OFF position, then press the PLAY (◀) button ❹ to begin playback.</p>

CARE AND MAINTENANCE

SAFEGUARD AGAINST ACCIDENTAL ERASURE

When a new recording is made, any program material previously recorded is automatically erased and only the new recording remains. To safeguard valuable recordings from being erased accidentally, the cassette and the deck are equipped with a special device.

On the back of the cassette there is an erase prevention tab on each side. To prevent accidental erasing, break out these tabs with a screwdriver. If only one side of the tape is to be protected, break out the tab on the left side with the side desired facing you.

To record on a tape in which the tab has been broken, place a piece of adhesive tape over that area.

NOTE: When a tab is broken out, the record button cannot be depressed.

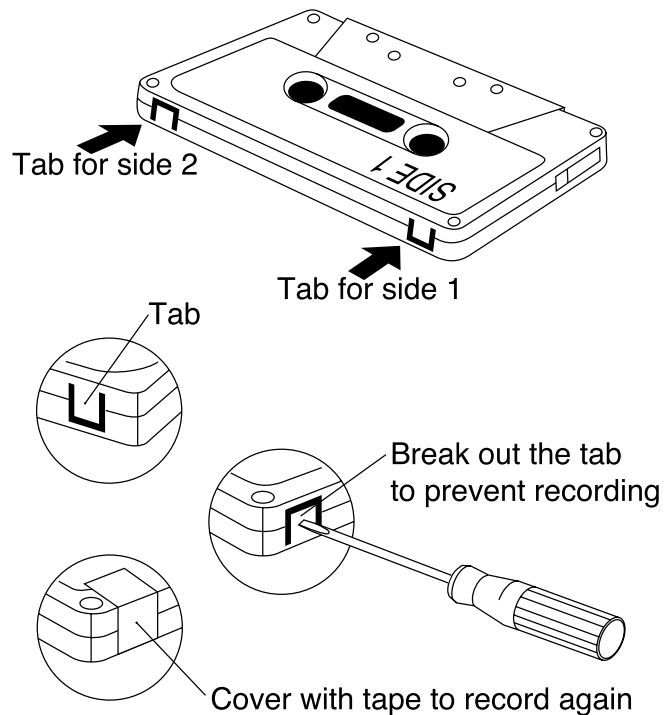

CASSETTE TAPE RECOMMENDATIONS

Standard tape lengths have 15 (C-30), 30 (C-60) and 45 (C-90) minutes of recording time on each side. Longer length tapes of 60 (C-120) minutes of recording time on each side are not recommended. Use only high quality tapes. If a problem develops, check the unit first with another cassette to determine if the problem is with the cassette, and not with the unit.

If there is any slack in the tape in the cassette, it should be removed before inserting the cassette. Place a pencil in one of the hubs and rotate clockwise until all slack is taken up.

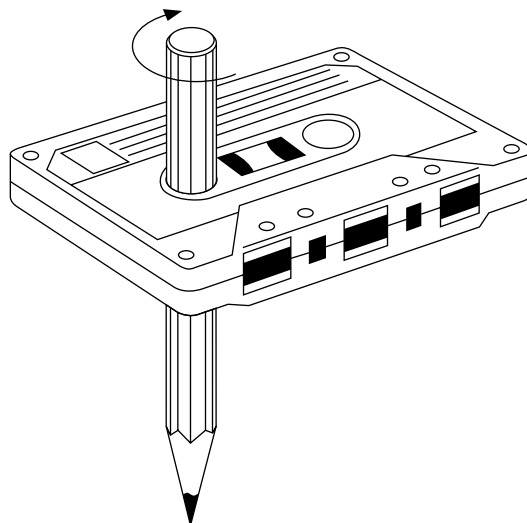

CARE AND MAINTENANCE (CONTINUED)

Caring for Compact Discs

- Treat the compact disc carefully. Handle the compact disc only by its edges. Never allow your fingers to come in contact with the shiny, unprinted side of the compact disc.
- Do not attach adhesive tape, stickers, etc. to the disc label.
- Clean the compact disc periodically with a soft, lint-free, dry cloth. Never use detergents or abrasive cleaners to clean the compact disc. If necessary, use a CD cleaning kit.
- If a disc skips or gets stuck on a section of the compact disc, it is probably dirty or damaged (scratched).
- When cleaning the compact disc, wipe in straight lines from the center of the compact disc to the outer edge of the compact disc. Never wipe in circular motions.

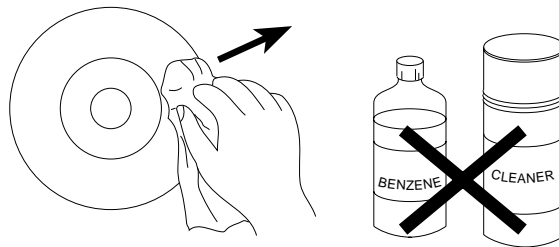
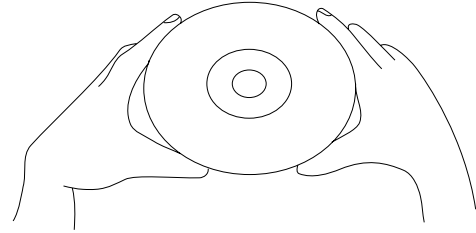

- This unit is designed to play only compact discs bearing the identification logo as shown here. Other discs may not conform to the CD standard and may not play properly.
- Compact Discs should be stored in their cases after each use to avoid damage.
- Do not expose compact discs to direct sunlight, high humidity, high temperatures, or dust, etc. Prolonged exposure or extreme temperatures can warp the compact disc.
- Do not stick or write anything on either side of the compact disc. Sharp writing instruments, or the ink may damage the surface.



Cleaning the unit

- To prevent fire or shock hazard, disconnect your unit from the AC power source when cleaning.
- The finish on your unit may be cleaned with a dust cloth and cared for as other furniture. Use caution when cleaning and wiping the plastic parts.
- Mild soap and a damp cloth may be used on the front panel.
- Periodic cleaning of the tape heads, capstan and pinch roller is necessary to maintain good sound reproduction. Clean them after every 100 hours of use or less if playback has deteriorated. Use a cotton swab moistened with head cleaning solution or isopropyl alcohol, then wipe dry with another swab.

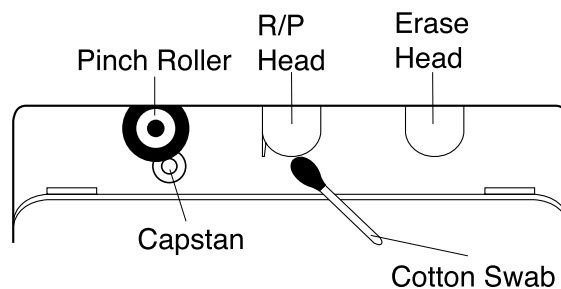

NOTE: Never use metal objects on or near the tape heads. Do not allow and cleaning material to fall into the tape assembly.

TROUBLESHOOTING GUIDE

Should this unit exhibit a problem, check the following before seeking service:

Symptom	Possible Cause	Solution
Radio		
Noise or sound distorted on radio broadcasts.	Station not tuned properly for AM or FM.	Retune the AM or FM broadcast station.
	FM: Telescopic antenna is not properly adjusted.	Reorient FM telescopic antenna.
	AM: Unit is not positioned correctly.	Rotate unit until best reception is obtained.
AM or FM, no sound.	Function switch not on AM or FM.	Slide to select AM or FM.
	Volume at minimum.	Increase volume.
Cassette Player		
No sound.	Volume at minimum.	Increase volume.
Sound distorted.	Dirty head.	Clean the head.
Speed varies.	Tape old or worn.	Replace the tape.
	Batteries are low.	Replace the batteries.
Cassette Recorder		
Will not record.	Erase prevention tab removed.	Cover hole with adhesive tape.
Distorted sound on playback.	Defective tape or dirty tape head.	Replace tape or clean tape head.
Compact Disc Player		
CD Player will not play.	Function switch not on CD.	Slide to the CD position.
	CD is not installed or installed upside-down.	Insert CD with label side up.
CD skips while playing.	Disc is dirty or scratched.	Wipe disc with cloth or use another disc.
General		
No sound.	Power cord disconnected.	Connect power cord.
	No batteries, dead batteries or batteries not installed properly.	Insert fresh batteries properly.

FOR ADDITIONAL SET-UP OR OPERATING ASSISTANCE, PLEASE VISIT OUR WEBSITE AT WWW.MEMOREXELECTRONICS.COM OR CONTACT CUSTOMER SERVICE AT 1-800-919-3647.

PLEASE KEEP ALL PACKAGING MATERIAL FOR AT LEAST 90 DAYS IN CASE YOU NEED TO RETURN THIS PRODUCT TO YOUR PLACE OF PURCHASE OR MEMOREX.

FOR PARTS AND ACCESSORIES, CONTACT FOX INTERNATIONAL AT 1-800-321-6993.

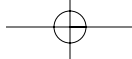

SPECIFICATIONS

GENERAL:

Power Source120V,60Hz AC
Battery12V DC (8 x 1.5V "C" Size batteries)
Alkaline is recommended for longer life
Speaker3W 8 Ohms

RADIO SECTION:

Frequency Range (FM).....88 - 108 MHz
Frequency Range (AM)530 -1710 KHz

CD SECTION:

Disc Diameter4.72" (120mm)
3.15" (80mm) Single CD
Optical SourceSemiconductor Laser

Specifications are subject to change without notice.

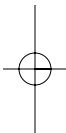
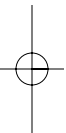

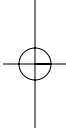
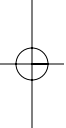
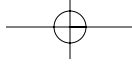

Memcorp, Inc.
Weston, FL
Printed in Hong Kong

Visit our website at www.memorexelectronics.com



Free Manuals Download Website

<http://myh66.com>

<http://usermanuals.us>

<http://www.somanuals.com>

<http://www.4manuals.cc>

<http://www.manual-lib.com>

<http://www.404manual.com>

<http://www.luxmanual.com>

<http://aubethermostatmanual.com>

Golf course search by state

<http://golfingnear.com>

Email search by domain

<http://emailbydomain.com>

Auto manuals search

<http://auto.somanuals.com>

TV manuals search

<http://tv.somanuals.com>