

Memorex®

PORTABLE CD/CD-RW/MP3 PLAYER WITH AM/FM STEREO RADIO

MODEL: MP3123

**BEFORE OPERATING THIS PRODUCT, PLEASE READ THESE
INSTRUCTIONS COMPLETELY.**



OPERATING INSTRUCTIONS

Thank you for purchasing the Memorex audio system.

The serial number of your unit can be found on a label on the bottom of the cabinet. We suggest that you record the serial number in the space provided below in case this information is ever needed at a future date.

PLEASE KEEP ALL PACKAGING MATERIAL FOR AT LEAST 90 DAYS IN CASE YOU NEED TO RETURN THIS PRODUCT TO YOUR PLACE OF PURCHASE OR MEMOREX.

Model Number: MP3123

Serial Number: _____

	CAUTION RISK OF ELECTRIC SHOCK DO NOT OPEN	
CAUTION: TO REDUCE THE RISK OF ELECTRIC SHOCK, DO NOT REMOVE COVER (OR BACK). NO USER-SERVICEABLE PARTS INSIDE. REFER SERVICING TO QUALIFIED SERVICE PERSONNEL.		

LASER SAFETY: This unit employs a laser. Only qualified service personnel should attempt to service this device due to possible eye injury.

CAUTION: USE OF CONTROLS, ADJUSTMENTS OR PERFORMANCE PROCEDURE HEREIN MAY RESULT IN HAZARDOUS RADIATION EXPOSURE.

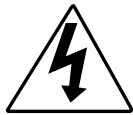

DANGEROUS VOLTAGE:

The lightning flash with arrowhead symbol, within an equilateral triangle is intended to alert the user to the presence of uninsulated dangerous voltage within the product's enclosure that may be of sufficient magnitude to constitute a risk of electric shock to persons.



ATTENTION:

The exclamation point within an equilateral triangle is intended to alert the user to the presence of important operating and maintenance (servicing) instructions in the literature accompanying the appliance.

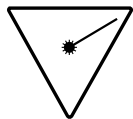

DANGER:

Invisible and hazardous laser radiation when open and interlock failed or defeated. Avoid direct exposure to beam.

INFORMATION:

This equipment has been tested and found to comply with the limits for a Class B digital device, pursuant to Part 15 of the FCC Rules. These limits are designed to provide reasonable protection against harmful interference in a residential installation. This equipment generates, uses, and can radiate radio frequency energy and, if not installed and used in accordance with the instructions, may cause harmful interference to radio communications. However, there is no guarantee that interference will not occur in a particular installation. If this equipment does cause harmful interference to radio or television reception, which can be determined by turning the equipment off and on, the user is encouraged to try to correct the interference by one or more of the following measures:

- Reorient or relocate the receiving antenna.
- Increase the separation between the equipment and receiver.
- Connect the equipment into an outlet on a circuit different from that to which the receiver is connected.
- Consult the dealer or an experienced radio/TV technician for help.

FCC WARNING:

This equipment may generate or use radio frequency energy. Changes or modifications to this equipment may cause harmful interference unless the modifications are expressly approved in the instruction manual. The user could lose the authority to operate this equipment if an unauthorized change or modification is made.

SURGE PROTECTORS:

It is recommended to use a surge protector for AC connection. Lightning and power surges ARE NOT covered under warranty for this product.

SAFETY INSTRUCTIONS

Before using the unit, be sure to read all operating instructions carefully. Please note that these are general precautions and may not pertain to your unit. For example, this unit may not have the capability to be connected to an outdoor antenna.

1. READ INSTRUCTIONS

All the safety and operating instructions should be read before the product is operated.

2. RETAIN INSTRUCTIONS

The safety and operating instructions should be retained for future reference.

3. HEED WARNINGS

All warnings on the product and in the operating instructions should be adhered to.

4. FOLLOW INSTRUCTIONS

All operating and use instructions should be followed.

5. CLEANING

Unplug this product from the wall outlet before cleaning. Do not use liquid cleaners or aerosol cleaners. Use a damp cloth for cleaning.

6. ATTACHMENTS

Do not use attachments not recommended by the product's manufacturer as they may cause hazards.

7. WATER AND MOISTURE

Do not use this product near water- for example, near a bathtub, washbowl, kitchen sink, or laundry tub, in a wet basement, or near a swimming pool.

8. ACCESSORIES

Do not place this product on an unstable cart, stand, tripod, bracket, or table. The product may fall, causing serious injury and serious damage to the product. Use only with a cart, stand, tripod, bracket, or table recommended by the manufacturer or sold with the product. Any mounting of the product should follow the manufacturer's instructions, and should use a mounting accessory recommended by the manufacturer.

- 8A. An appliance and cart combination should be moved with care. Quick stops, excessive force, and uneven surfaces may cause the appliance and cart combination to overturn.

PORTABLE CART WARNING
(symbol provided by RETAC)



9. VENTILATION

Slots and openings in the cabinet and in the back or bottom are provided for ventilation and to ensure reliable operation of the product and to protect it from overheating. These openings must not be blocked or covered. The openings should never be blocked by placing the product on a bed, sofa, rug, or other similar surface. This product should never be placed near or over a radiator or heat source. This product should not be placed in a built-in installation such as a bookcase or rack unless proper ventilation is provided or the manufacturer's instructions have been adhered to.

10. POWER SOURCES

This product should be operated only from the type of power source indicated on the marking label. If you are not sure of the type of power supply to your home, consult your appliance dealer or local power company. For products intended to operate from battery power, or other sources, refer to the operating instructions.

11. GROUNDING OR POLARIZATION

This product is equipped with a polarized alternating-current line plug (a plug having one blade wider than the other). This plug will fit into the power outlet only one way. This is a safety feature. If you are unable to insert the plug fully into the outlet, try reversing the plug. If the plug should still fail to fit, contact your electrician to replace your obsolete outlet. Do not defeat the safety purpose of the polarized plug.

12. POWER-CORD PROTECTION

Power-supply cords should be routed so that they are not likely to be walked on or pinched by items placed upon or against them, paying particular attention to cords at plugs, convenience receptacles, and the point where they exit from the appliance.

13. LIGHTNING

To protect your product from a lightning storm, or when it is left unattended and unused for long periods of time, unplug it from the wall outlet and disconnect the antenna or cable system. This will prevent damage to the product due to lightning and power-line surges.

14. POWER LINES

An outside antenna system should not be located in the vicinity of overhead power lines or other electric light or power circuits, or where it can fall into such power lines or circuits. When installing an outside antenna system, extreme care should be taken to keep from touching such power lines or circuits as contact with them might be fatal.

15. OVERLOADING

Do not overload wall outlets and extension cords as this can result in a risk of fire or electric shock.

16. OBJECT AND LIQUID ENTRY

Never push objects of any kind into this product through openings as they may touch dangerous voltage points or short out parts that could result in fire or electric shock. Never spill or spray any type of liquid on the product.

17. OUTDOOR ANTENNA GROUNDING

If an outside antenna is connected to the product, be sure the antenna system is grounded so as to provide some protection against voltage surges and built-up static charges. Section 810 of the National Electric Code, ANSI/NFPA 70, provides information with respect to proper grounding of the mast and supporting structure, grounding of the lead-in wire to an antenna discharge product, size of grounding conductors, location of antenna discharge product, connection to grounding electrodes, and requirements for grounding electrode.

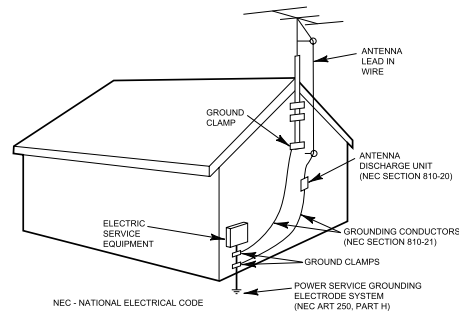

EXAMPLE OF ANTENNA GROUNDING AS PER NATIONAL ELECTRICAL CODE

18. SERVICING

Do not attempt to service this product yourself as opening or removing covers may expose you to dangerous voltage or other hazards. Refer all servicing to qualified service personnel.

19. REPLACEMENT PARTS

When replacement parts are required, be sure the service technician uses replacement parts specified by the manufacturer or those that have the same characteristics as the original part. Unauthorized substitutions may result in fire, electric shock or other hazards.

20. SAFETY CHECK

Upon completion of any service or repairs to this product, ask the service technician to perform safety checks to determine that the product is in proper operating condition.

21. WALL OR CEILING MOUNTING

The product should be mounted to a wall or ceiling only as recommended by the manufacturer.

22. DAMAGE REQUIRING SERVICE

Unplug the product from the wall outlet and refer servicing to qualified service personnel under the following conditions:

- When the power-supply cord or plug is damaged.
- If liquid has been spilled, or objects have fallen into the product.
- If the product has been exposed to rain or water.
- If the product does not operate normally by following the operating instructions. Adjust only those controls that are covered by the operating instructions, as an adjustment of other controls may result in damage and will often require extensive work by a qualified technician to restore the product to its normal operation.
- If the product has been dropped or the cabinet has been damaged.
- When the product exhibits a distinct change in performance - this indicates a need for service.

23. HEAT

The product should be situated away from heat sources such as radiators, heat registers, stoves, or other products (including amplifiers) that produce heat.

24. NOTE TO CATV SYSTEM INSTALLER

This reminder is provided to call the CATV system installer's attention to Article 820-40 of the NEC that provides guidelines for proper grounding and, in particular, specifies that the cable ground shall be connected to the grounding system of the building, as close to the point of cable entry as practical.

PREPARATION FOR USE

Unpacking and Setup

- Carefully remove the unit from the display carton and remove all packing material from the unit itself.
- The detachable AC power cord is packed in the carton separately from the unit. Make sure that the AC power cord is not accidentally discarded with the carton or packing material.
- Press the OPEN/CLOSE area to open the CD compartment door. There is a white card in the CD compartment which is intended to prevent the CD pickup from moving during shipment of the product. Remove this card from the CD compartment before use.

Power Sources

This portable audio system is designed to operate on either 110-120V AC 60Hz house current DC or by using eight (8) 'C' batteries, not included. Attempting to operate this unit from any other power source may cause damage to the unit, which is not covered by your warranty.

AC Operation

Unwind the AC cord and extend it to its full length. Insert the small end of the AC cord into the AC socket on the back cabinet of the unit. Insert the other end of the AC cord into any convenient 110-120V 60Hz household outlet.

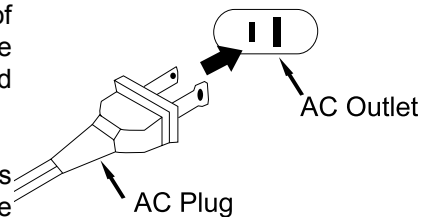

Please note that this unit is equipped with a polarized AC plug which has one blade wider than the other. This is a safety feature to reduce the likelihood of electric shock. This polarized AC plug will only fit in a polarized AC outlet. If you find that you cannot insert this plug into your outlet, you may have an obsolete non-polarized outlet. Please do not try to defeat this safety feature by using a non-polarized adapter or by filing the wider blade to make it fit into your outlet. If this plug does not fit into your outlet, you should contact a qualified licensed electrician to replace your obsolete outlet.

Battery Installation

To use this unit with battery power, remove the battery compartment on the bottom of the unit by sliding it towards the rear of the unit. Insert eight (8) 'C' size batteries following the diagram in the compartment.

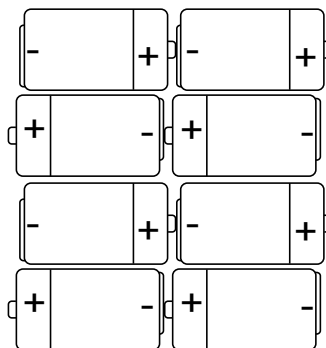

NOTE: The AC power cord must be disconnected from the AC socket on the rear of the unit in order for the unit to operate on battery power.

LOCATION OF CONTROLS

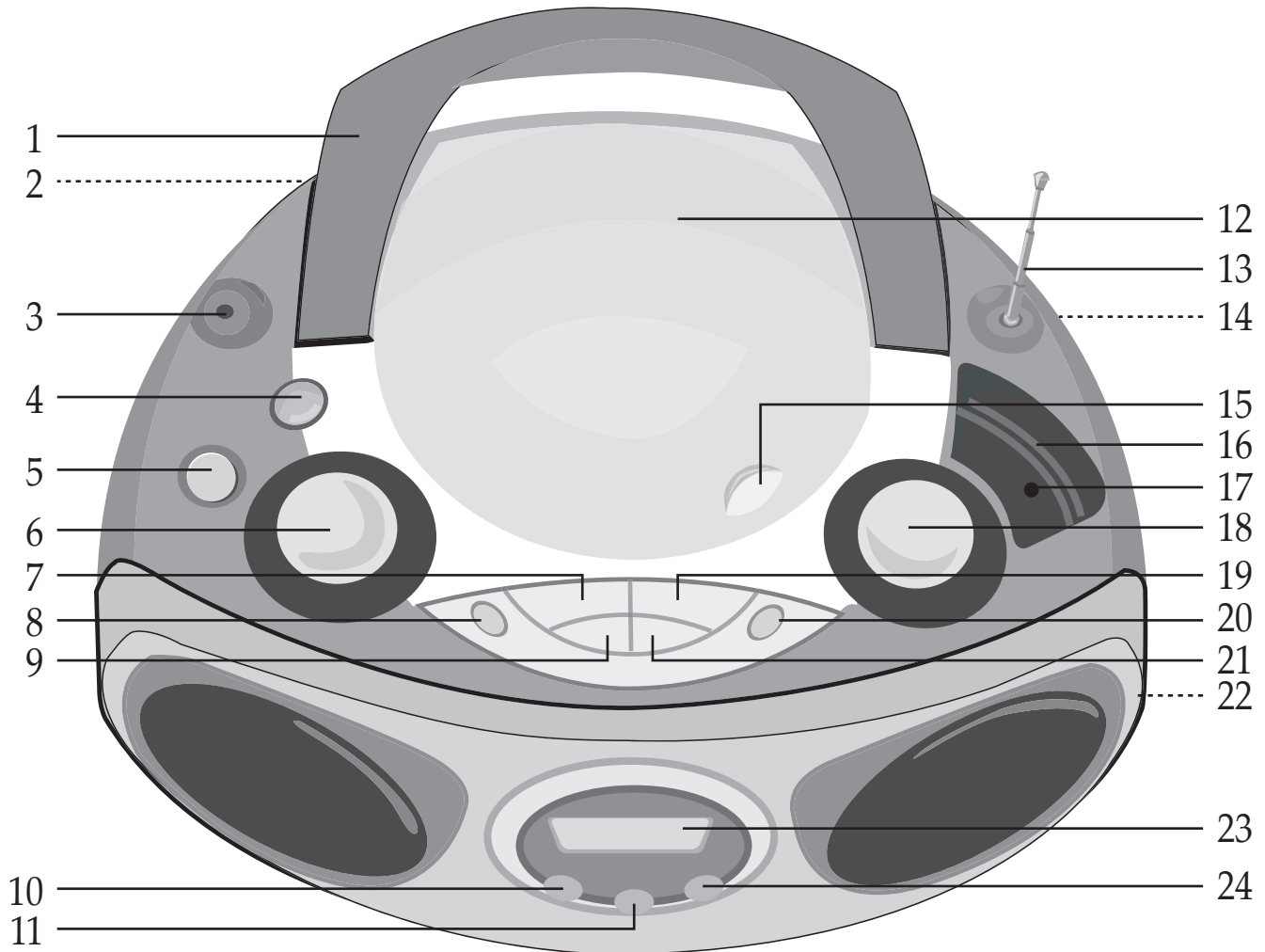

- | | |
|-----------------------------|---|
| 1. Carrying Handle | 14. FUNCTION (AM/FM/OFF/CD) Switch (Side of Unit) |
| 2. AC Socket (Rear of Unit) | 15. OPEN/CLOSE Area |
| 3. Headphones Jack | 16. Dial Scale and Pointer |
| 4. BACKLIGHT ON/OFF Button | 17. FM STEREO Indicator |
| 5. BASS BOOST Button | 18. TUNING Control |
| 6. VOLUME Control | 19. PLAY/PAUSE (▶/) Button |
| 7. STOP (■) Button | 20. PROGRAM Button |
| 8. REPEAT Button | 21. SKIP/Search (▶▶) Button |
| 9. SKIP/Search (◀◀) Button | 22. Battery Compartment (Bottom of Unit) |
| 10. DIRECTORY – Button | 23. CD Display |
| 11. FIND Button | 24. DIRECTORY + Button |
| 12. CD Compartment Door | |
| 13. FM Rod Antenna | |

OPERATING INSTRUCTIONS

LISTENING TO THE RADIO

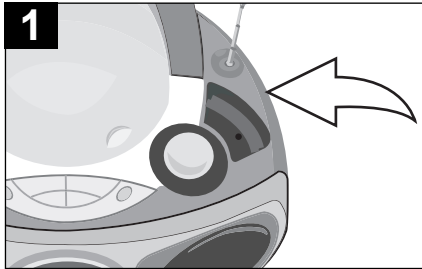

Slide the **FUNCTION** switch to the AM or FM position as desired.
NOTE: If you select the FM band, be sure to raise the FM rod antenna and extend it to its full length.

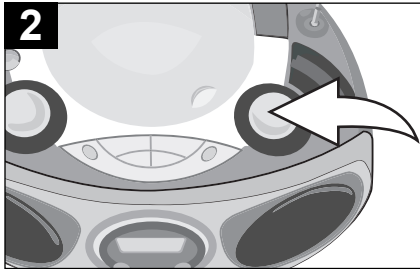

Use the **TUNING** control to select the desired AM or FM station. When a strong FM Stereo signal is received, the FM STEREO indicator will light.

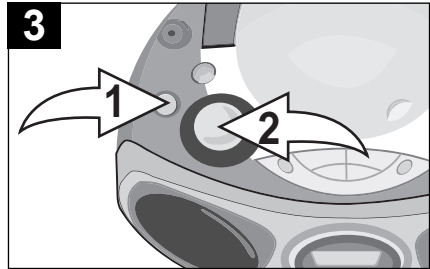

For an enhanced Bass sound, press the **BASS BOOST** button ①. Adjust the **VOLUME** control ② as desired.

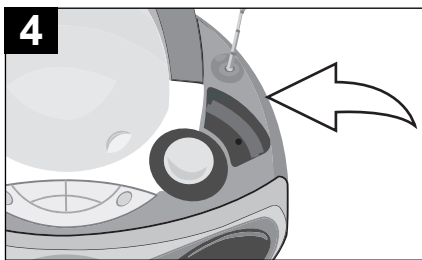

Slide the **FUNCTION** switch to the OFF position to turn off the radio off.

BACKLIGHT

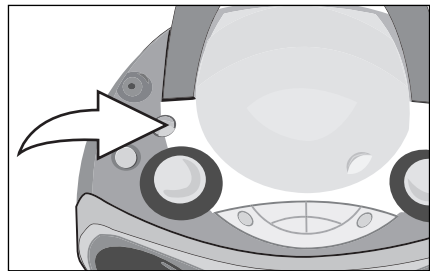

Press the **BACKLIGHT ON/OFF** button to turn off the display's backlight on or off.

HINTS FOR BETTER RECEPTION

FM - Make sure that the telescopic FM Rod Antenna is raised and extended to its full length. You may have to vary the direction of the antenna to find the strongest signal for each FM station.

AM - The AM ferrite bar antenna is located inside the cabinet. It may be necessary to turn the unit slightly so that the internal antenna is pointing in the direction of the AM transmitter. You may have to experiment to find the position that provides the strongest reception for each of your favorite AM stations.

HEADPHONES JACK

For private listening, plug headphones (not included) into the Headphones jack. The speakers will be disconnected when the headphones are plugged in.

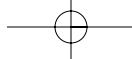

PLAYING COMPACT DISCS

NORMAL PLAYBACK

This CD player is designed to play all kinds of Audio Discs and MP3 CD ROMS, such as CD recordables and rewritables. Do not try to play CDI, CDV, DVD or computer CDs.

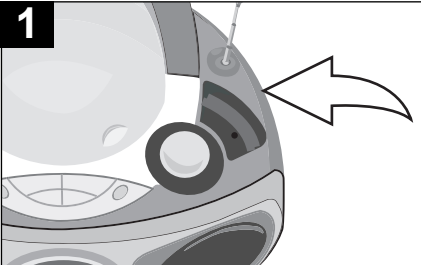
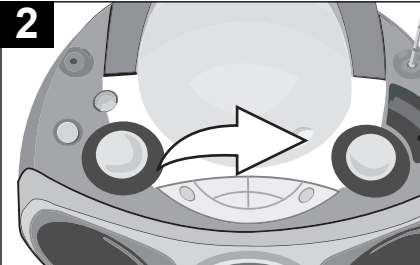
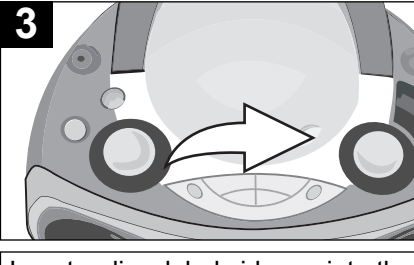
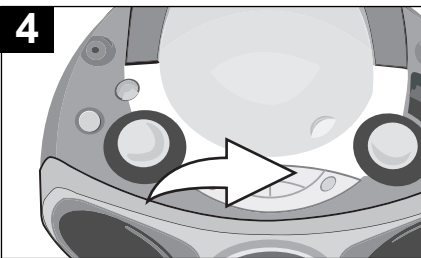
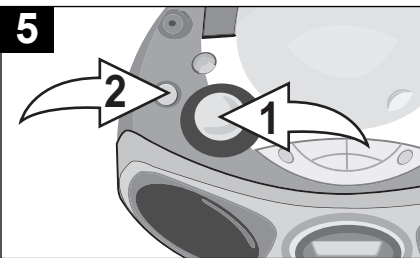
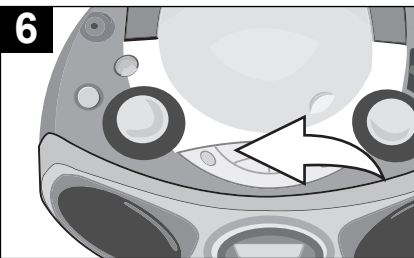
		
<p>Slide the FUNCTION switch to the CD position.</p>	<p>Open the CD compartment lid by pressing the OPEN/CLOSE area.</p>	<p>Insert a disc, label side up, into the compartment. Press the OPEN/CLOSE area to close the CD compartment lid; the total tracks and playing time will appear in the display. (If an MP3 CD is inserted, the total albums/folders will appear at the top right also.)</p>
		
<p>Press the PLAY/PAUSE (▶) button to begin playback; the current track and elapsed playing time will appear in the display.</p>	<p>Set the VOLUME control ❶ and BASS BOOST button ❷ as desired.</p>	<p>When the disc is through playing, it will stop. Press the STOP (■) button to stop the disc before it is finished.</p>

CHANGING THE DISPLAY

During playback of an MP3 CD, press the **FIND** button to cycle the display as follows:

- 1st Press: The file name will appear.
- 2nd Press: The folder name will appear.
- 3rd Press: The display will revert back to normal.

During playback, press and hold the **FIND** button and the MP3 information will scroll across the display. Press and hold the **FIND** button again and the display will revert back to normal.

CD PLAYBACK NOTES:

- See page 10 for more information on MP3's.
- When recording ("burning") CDs, make sure the session is "finalized", or simply record ("burn") only one session. You can find more information on "finalizing" in your CD recorder's manual.
- This unit is capable of playing standard CDs or 3" singles; no adapter is required.
- If a disc is inserted incorrectly, dirty, damaged or not present at all, "NO DISC" will appear in the display.
- Playback will stop when you open the CD compartment, but it is not recommended to open the compartment before the **STOP** (■) button is pressed.
- It may take 10 to 30 seconds for the player to read an MP3 CD and begin playback, depending on the number of tracks "burned" on the CD.



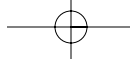

CD PAUSE CONTROL

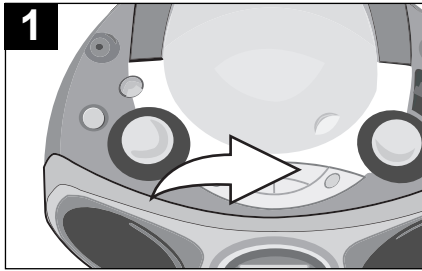

1 During CD playback, if you wish to pause the disc momentarily, press the PLAY/PAUSE (▶||) button. Playback stops but the disc continues to spin and the time blinks in the display.

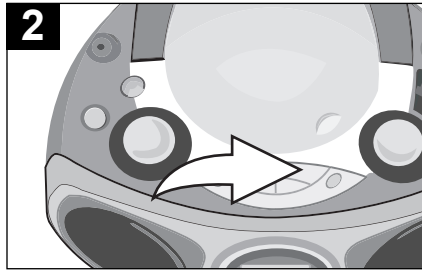

2 Press the PLAY/PAUSE (▶||) button again to release Pause and resume normal CD playback. The sound returns and the display stops blinking.

TO BEGIN PLAYBACK FROM A SPECIFIC TRACK

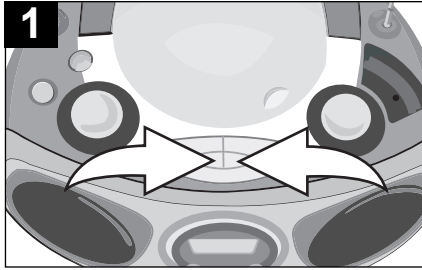

1 After you insert the disc into the CD player and the total number of tracks and playing time will appear on the display, you may press the SKIP/Search ◀◀ or ▶▶ button to select a specific track for playback.

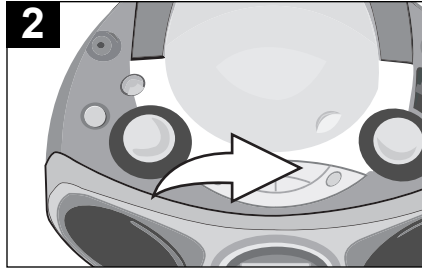

2 When the desired track number appears in the display, press the PLAY/PAUSE (▶||) button. Playback will begin on the track you selected.

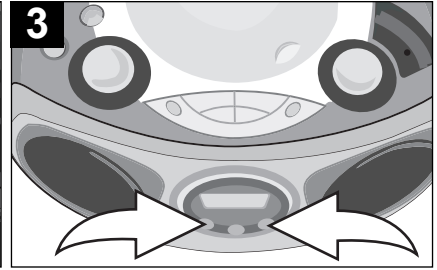

MP3: When an MP3 disc is inserted, press the DIRECTORY + or - button to select an album/folder.

FORWARD/REVERSE SKIP TRACK AND HIGH-SPEED MUSIC SEARCH

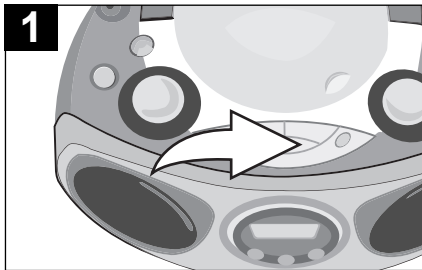

1 During playback, press the SKIP/Search ▶▶ button once to advance the player to the beginning of the next track. Press the SKIP/Search ▶▶ button repeatedly to advance the player to higher numbered tracks.

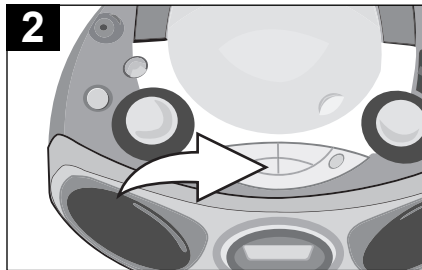

2 During playback, press the SKIP/Search ◀◀ button once to move the player back to the beginning of the playing track. Press the SKIP/Search ◀◀ button repeatedly to move the player back to lower numbered tracks.

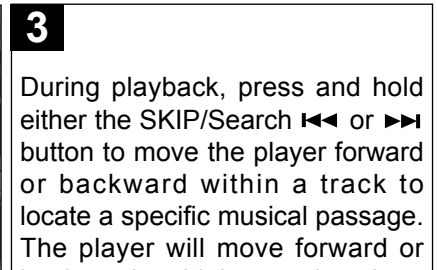

3 During playback, press and hold either the SKIP/Search ◀◀ or ▶▶ button to move the player forward or backward within a track to locate a specific musical passage. The player will move forward or backward at high speed as long as the buttons are depressed. When you release the SKIP/Search ◀◀ or ▶▶ button, normal playback will resume.

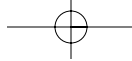

REPEAT PLAYBACK (TRACK, DISC OR MP3 ALBUM)

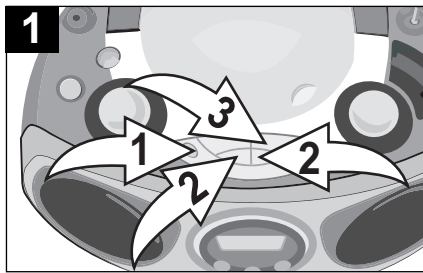

1 To repeat a single track, press the REPEAT button **1** once: “” will appear in the display. Press the SKIP/Search **2** or **3** button **2** to select the specific track that you wish to repeat. When the desired track number appears in the display, press the PLAY/PAUSE () button **2** to begin playback. The specific track you selected will be repeated continuously.

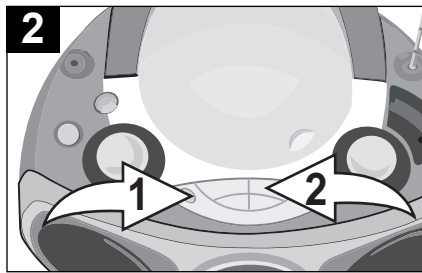

2 To repeat all of the tracks on a disc continuously, press the REPEAT button **1** twice; “” will appear in the display. Press the PLAY/PAUSE () button **2** to begin playback.

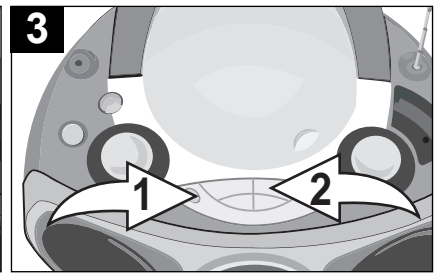

MP3 ONLY:
To repeat all of the tracks on an album continuously, press the REPEAT button **1** three times; “ ALBUM” will appear in the display. Press the PLAY/PAUSE () button **2** to begin playback. To cancel Repeat Playback, press the REPEAT button **1** until the Repeat indicator disappears from the display. See page 10 for more info on MP3 format.

PROGRAMMED PLAYBACK

The CD player in this unit has a 64 track programmable memory that allows you to program up to 64 tracks on any disc for playback in any desired order. You may program 64 different tracks or you may also program certain tracks to play more than once.

To perform programmed playback, proceed as follows:

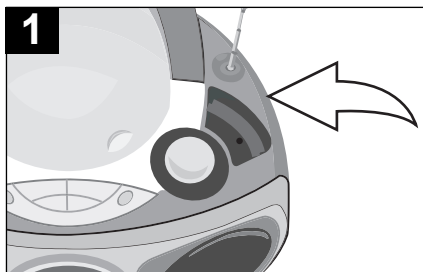

1 Slide the FUNCTION switch to the CD position.

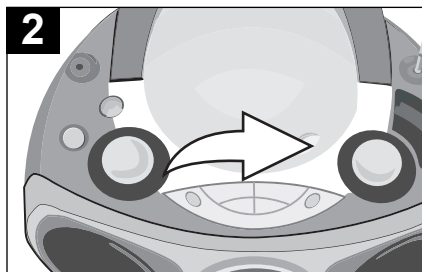

2 Open the CD compartment lid by pressing the OPEN/CLOSE area and insert your disc in the CD player. Close the CD compartment door.

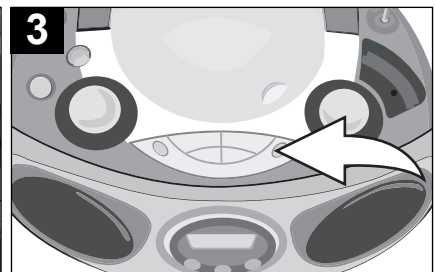

3 Press the PROGRAM button; “P:01” (Program Number) and “00” (track number) will appear and “PROG” will blink in the display.

PROGRAMMED PLAYBACK SECTION CONTINUED ON NEXT PAGE.

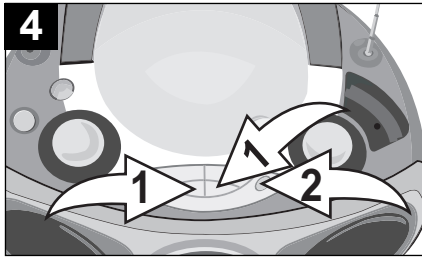

Press the SKIP/Search ◀◀ or ▶▶ button ❶ to select the first track that you wish to program. When the desired track number (Example: Track 5) appears in the display, press the PROGRAM button ❷ again. The display will then show, "P:02" indicating program 2 is ready to be set.

MP3: If using a MP3 disc, see note below.

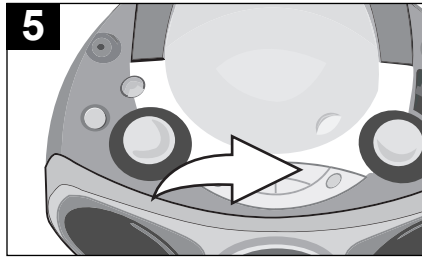

After programming up to 64 tracks in the CD Program Memory, press the PLAY/PAUSE (▶||) button to begin programmed playback; "PROG" will appear in the display and playback will begin on the first track that you programmed. The player will continue to play all of the tracks that you programmed in the order in which you programmed them.

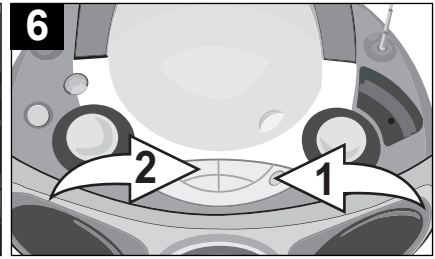

When the last programmed track has been played, the player will stop. To cancel the Programmed Playback mode, press the PROGRAM button ❶ to enter the Program mode and then press the STOP (■) button ❷ to cancel.

NOTES ON PROGRAMMED PLAYBACK:

- **MP3 PROGRAM:** If an MP3 CD is inserted, you will first select the directory number in step 1, and then the file.
- You can review the program by pressing the PROGRAM button when playback is stopped.
- You can change tracks in a program by simply selecting the desired track using the PROGRAM button, and then use the SKIP/Search ◀◀ or ▶▶ button to change it.
- Press the STOP (■) button to stop the program before it is finished.
- Each file may be stored in the program memory as many times as desired (up to 64 files).
- You can scroll through the program while it is playing using the SKIP/Search ◀◀ or ▶▶ button.

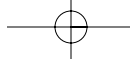

PROGRAMMED REPEAT

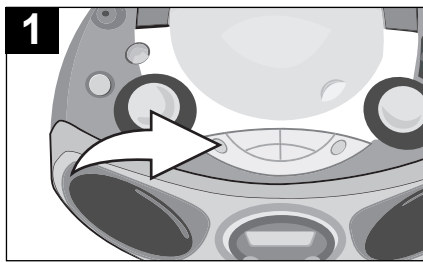

It is also possible to use the Program and Repeat functions together to repeat a specific program indefinitely. First, program the tracks you wish to hear in the order you wish to hear them, as described on the previous page. Then, press the REPEAT button twice. Both indicators will appear in the display.

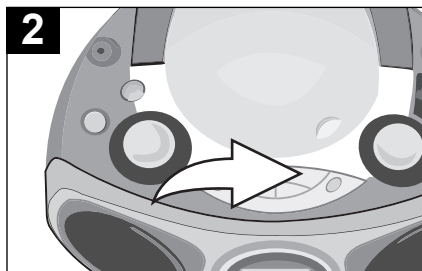

Press the PLAY/PAUSE (▶||) button to begin program-med repeat playback. The player will play the tracks you selected in the order in which you programmed them. When the last track in the program has been played, the entire program will begin again.

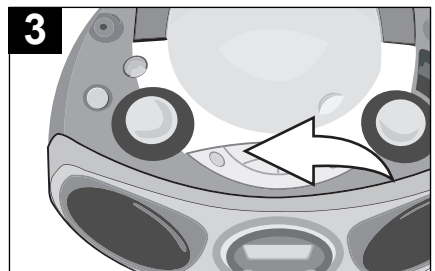

Programmed Repeat operation will continue indefinitely until you press the STOP (■) button, or turn the unit off.

MP3 FAQs (Frequently Asked Questions)

Please read before playing an MP3 CD.

What is an MP3 file?

An MP3 file is a computer format that makes a usually large music file into a smaller one which is more convenient to download and share.

Can I record my own MP3 CDs?

Yes, but you need a CD recorder, which is available from you local computer store.

Where can I find MP3 files?

MP3 files are available all over the internet.

Can the MP3123 read CD-RW (Rewriteable CDRs)?

Yes it can. However, you must reformat the CD-RW every time you want to record a new group of MP3 files. No multi-session recording is allowed.

Can the MP3123 read regular music CDs?

Yes it can. However, you cannot mix MP3s and WAV files on the same CD. If you do, this CD Player will play only the MP3 files.

Can I use the MP3 extension for non-audio data files?

No, this may result in serious malfunction and harmful noise interference.

Can I mix MP3 files with other file types on the CDR?

Yes, but your CD player will ignore those files and read only the MP3 files on the CDR.

Does the MP3123 support multi-session CDRs?

No, it will not. It supports only single session recorded CDRs. Single-session means you must burn all of your MP3 files on the CDR at once, and they must have an MPEG rate of 32-256Kbps.

Does the MP3123 support subdirectories (subfolders)?

Yes, the MP3123 can read MP3 files from subfolders.

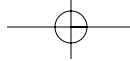

SEARCHING THROUGH MP3 TRACKS/FILES

You can search the contents of the MP3 albums (if burned on CD) as follows:

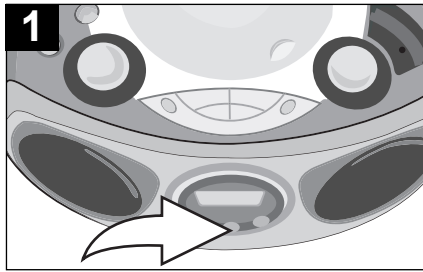

1 Press the FIND button once and the track/file starting with the letter "A" will appear in the display.

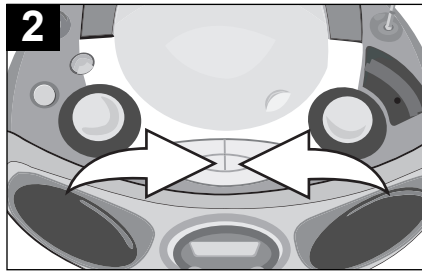

2 Press the SKIP/Search ◀◀ or ▶▶ button to scroll through the letters and numbers to locate a specific track/file.

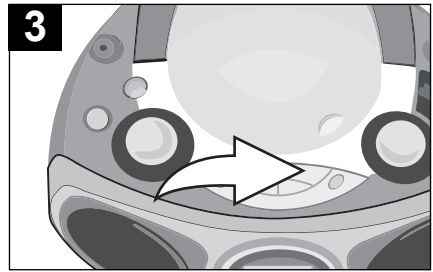

3 When the desired track/file appears, press the PLAY/PAUSE (▶||) button to play the track/file.

SEARCHING THROUGH MP3 ALBUMS/FOLDERS

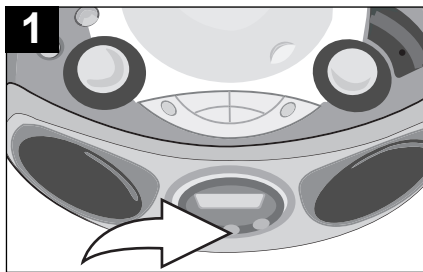

1 Press the FIND button twice and the first album/folder name and number will appear in the display.

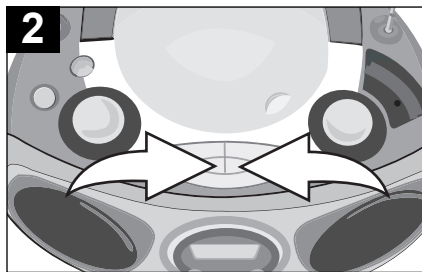

2 Press the SKIP/Search ◀◀ or ▶▶ button to scroll through the albums/folders and numbers to locate a specific album/folder.

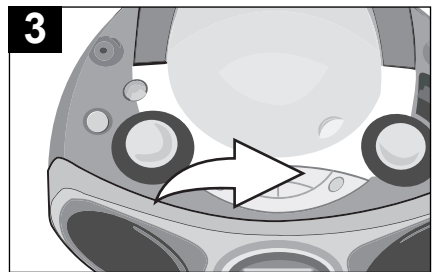

3 When the desired album/folder appears, press the PLAY/PAUSE (▶||) button to play the first track/file of the album/folder.

NOTE: When scrolling through track/files or albums/folders, if there is no name or contents, "NOTHING" will appear in the display.

SINGLE SESSION

The following chart is an example of a **Windows Explorer** display that will appear on your computer monitor for a single session MP3 CD ROM with Folders/Albums. Check the added notes to help you understand the MP3 CD unit display and the playback sequence of folders/albums and tracks on a single session MP3 CD.

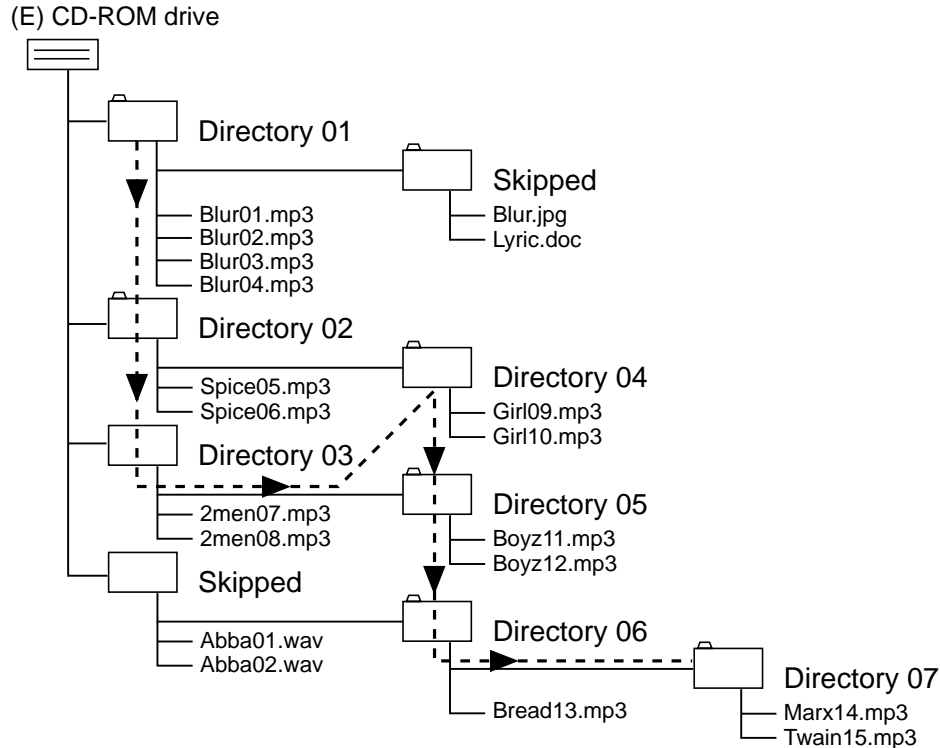

- The arrow pathway shows the sequence of MP3 directory and file playback.
- This example has a total of seven MP3 directories.
- Based on this layout, the first file will be "Blur01.mp3" and the last file will be "Twain15.mp3".
- When the MP3 CD is inserted into the CD player, the first digit in the display will be the folders, and the second digit will be the total number of tracks.
- "Skipped" denotes a directory which contains non-audio files only, e.g. jpg, wav, etc. These cannot be detected nor played on this player. When an album contains mixed format files, the non-MP3 files will be skipped.

CARE AND MAINTENANCE

Caring for Compact Discs

- Treat the disc carefully. Handle the disc only by its edges. Never allow your fingers to come in contact with the shiny, unprinted side of the disc.
- Do not attach adhesive tape, stickers, etc. to the disc label.
- Clean the disc periodically with a soft, lint-free, dry cloth. Never use detergents or abrasive cleaners to clean the disc. If necessary, use a CD cleaning kit.
- If a disc skips or gets stuck on a section of the disc, it is probably dirty or damaged (scratched).
- When cleaning the disc, wipe in straight lines from the center of the disc to the outer edge of the disc. Never wipe in circular motions.

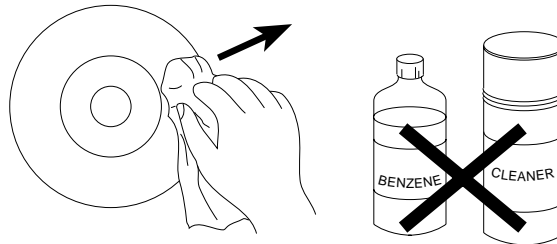
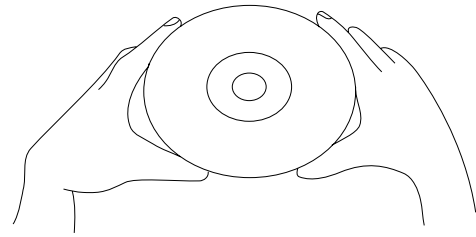

- This unit is designed to play only compact discs bearing the identification logo as shown here.
- Compact Discs should be stored in their cases after each use to avoid damage.
- Do not expose compact discs to direct sunlight, high humidity, high temperatures, or dust, etc. Prolonged exposure or extreme temperatures can warp the disc.
- Do not stick or write anything on either side of the disc. Sharp writing instruments, or the ink may damage the surface.



Cleaning the unit

- To prevent fire or shock hazard, disconnect your unit from the AC power source when cleaning.
- The finish on your unit may be cleaned with a dust cloth and cared for as other furniture. Use caution when cleaning and wiping the plastic parts.
- Mild soap and a damp cloth may be used on the front panel.

TROUBLESHOOTING GUIDE

Should this unit exhibit a problem, check the following before seeking service.

Symptom	Possible Cause	Solution
Radio		
Noise or sound distorted on radio broadcasts.	Station not tuned properly for AM or FM.	Retune the AM or FM broadcast station.
	FM: Telescopic antenna is not properly adjusted.	Reorient FM telescopic antenna.
	AM: Unit is not positioned correctly.	Rotate unit until best reception is obtained.
AM or FM, no sound.	FUNCTION switch not set to AM or FM.	Slide to select AM or FM.
	Volume at minimum.	Increase volume.
Compact Disc Player		
CD Player will not play.	Function switch not set to CD.	Slide to select CD.
	CD is not installed or installed upside-down.	Insert CD with label side up.
CD skips while playing.	Disc is dirty or scratched.	Wipe disc with cloth or use another disc.
General		
No sound.	Power cord disconnected.	Connect power cord.
	No batteries, or weak, dead or inserted incorrectly.	Insert fresh batteries correctly.

**FOR ADDITIONAL SET-UP OR OPERATING ASSISTANCE, PLEASE VISIT OUR WEBSITE AT WWW.MEMCORPINC.COM OR CONTACT CUSTOMER SERVICE AT
1-800-919-3647**

PLEASE KEEP ALL PACKAGING MATERIAL FOR AT LEAST 90 DAYS IN CASE YOU NEED TO RETURN THIS PRODUCT TO YOUR PLACE OF PURCHASE OR MEMOREX.

FOR PARTS AND ACCESSORIES, CONTACT FOX INT'L AT 1-800-321-6993.

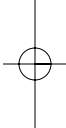
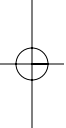
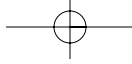

Memcorp, Inc.
Weston, FL
Printed in Hong Kong

Visit our website at www.memcorpinc.com



Free Manuals Download Website

<http://myh66.com>

<http://usermanuals.us>

<http://www.somanuals.com>

<http://www.4manuals.cc>

<http://www.manual-lib.com>

<http://www.404manual.com>

<http://www.luxmanual.com>

<http://aubethermostatmanual.com>

Golf course search by state

<http://golfingnear.com>

Email search by domain

<http://emailbydomain.com>

Auto manuals search

<http://auto.somanuals.com>

TV manuals search

<http://tv.somanuals.com>