

Memorex®

Is it live or is it Memorex?™

MX4501

User's Guide

Home Audio System with
5-CD Player and AM/FM
Stereo Radio

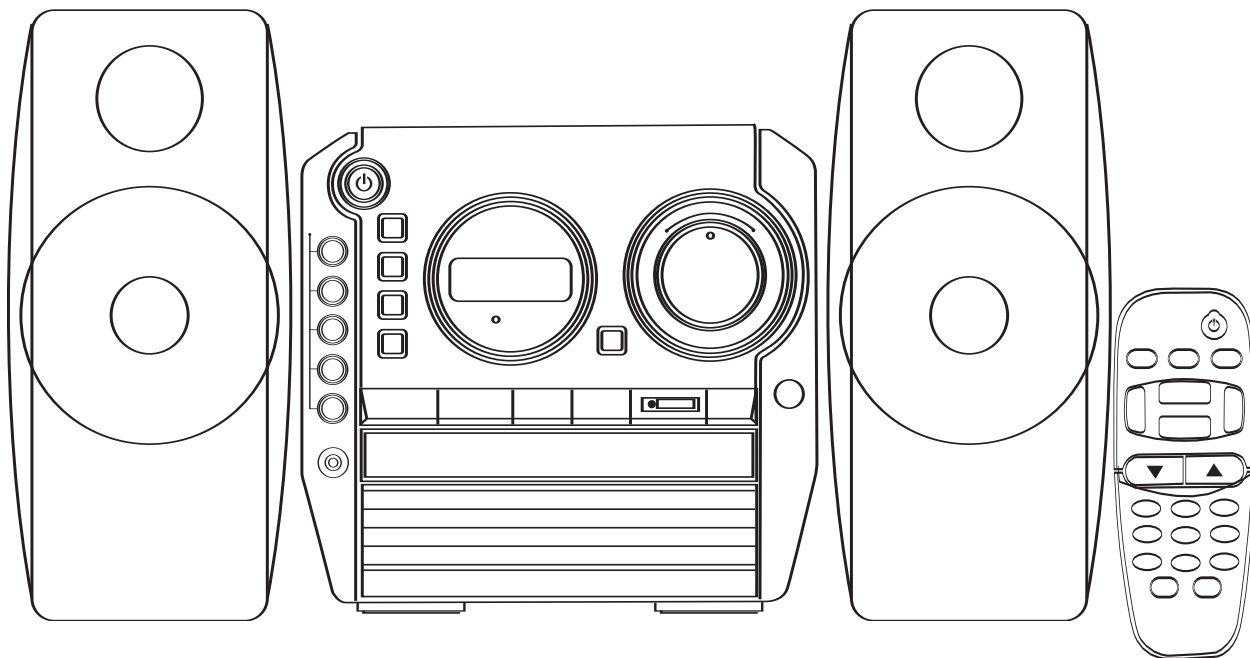

**Before operating this product,
please read these instructions completely.**

Dear Customer,

Please read this manual thoroughly before operating the unit to become more familiar with it and obtain the performance that will bring you continued enjoyment for many years. Keep these instructions handy for future reference.

PLEASE KEEP ALL PACKAGING MATERIAL FOR AT LEAST 90 DAYS IN CASE YOU NEED TO RETURN THIS PRODUCT TO YOUR PLACE OF PURCHASE OR MEMOREX.

For future reference, record the serial number of the unit printed on the rear of the cabinet.

Serial Number _____

	CAUTION RISK OF ELECTRIC SHOCK DO NOT OPEN	
CAUTION: TO REDUCE THE RISK OF ELECTRIC SHOCK, DO NOT REMOVE COVER (OR BACK). NO USER-SERVICEABLE PARTS INSIDE. REFER SERVICING TO QUALIFIED SERVICE PERSONNEL.		



DANGEROUS VOLTAGE

The lightning flash with arrowhead symbol, within an equilateral triangle is intended to alert the user to the presence of uninsulated dangerous voltage within the product's enclosure that may be of sufficient magnitude to constitute a risk of electric shock to persons.



ATTENTION

The exclamation point within an equilateral triangle is intended to alert the user to the presence of important operating and maintenance (servicing) instructions in the literature accompanying the appliance.

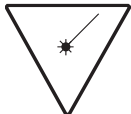

DANGER:

Invisible and hazardous laser radiation when open and interlock failed or defeated. Avoid direct exposure to beam.

FCC WARNING:

This equipment may generate or use radio frequency energy. Changes or modifications to this equipment may cause harmful interference unless the modifications are expressly approved in the instruction manual. The user could lose the authority to operate this equipment if an unauthorized change or modification is made.

LASER SAFETY: This unit employs a laser. Only qualified service personnel should attempt to service this device due to possible eye injury.

CAUTION: USE OF CONTROLS, ADJUSTMENTS OR PERFORMANCE PROCEDURE HEREIN MAY RESULT IN HAZARDOUS RADIATION EXPOSURE.

INFORMATION

This equipment has been tested and found to comply with the limits for a Class B digital device, pursuant to Part 15 of the FCC Rules. These limits are designed to provide reasonable protection against harmful interference in a residential installation. This equipment generates, uses and can radiate radio frequency energy and, if not installed and used in accordance with the instructions, may cause harmful interference to radio communications. However, there is no guarantee that interference will not occur in a particular installation. If this equipment does cause harmful interference to radio or television reception, which can be determined by turning the equipment off and on, the user is encouraged to try to correct the interference by one or more of the following measures:

- Reorient or relocate the receiving antenna.
- Increase the separation between the equipment and receiver.
- Connect the equipment into an outlet on a circuit different from that to which the receiver is connected.
- Consult the dealer or an experienced radio/TV technician for help.

WARNING: TO PREVENT FIRE OR SHOCK HAZARD, DO NOT EXPOSE THIS UNIT TO RAIN OR MOISTURE.

SURGE PROTECTORS:

It is recommended to use a surge protector for AC connection. Lightning and power surges ARE NOT covered under warranty for this product.

Dear Customer:

Selecting fine audio equipment such as the unit you've just purchased is only the start of your musical enjoyment. Now it's time to consider how you can maximize the fun and excitement your equipment offers. This manufacturer and the Electronic Industries Association's Consumer Electronics Group want you to get the most out of your equipment by playing it at a safe level. One that lets the sound come through loud and clear without annoying blaring or distortion-and, most importantly, without affecting your sensitive hearing.

Sound can be deceiving. Over time your hearing "comfort level" adapts to higher volumes of sound. So what sounds "normal" can actually be loud and harmful to your hearing. Guard against this by setting your equipment at a safe level BEFORE your hearing adapts.

To establish a safe level:

- Start your volume control at a low setting.
- Slowly increase the sound until you can hear it comfortably and clearly, and without distortion.

Once you have established a comfortable sound level:

- Set the dial and leave it there.

Taking a minute to do this now will help to prevent hearing damage or loss in the future. After all, we want you listening for a lifetime.

We Want You Listening For A Lifetime

Used wisely, your new sound equipment will provide a lifetime of fun and enjoyment. Since hearing damage from loud noise is often undetectable until it is too late, this manufacturer and the Electronic Industries Association's Consumer Electronics Group recommend you avoid prolonged exposure to excessive noise. This list of sound levels is included for your protection.

Decibel

<u>Level</u>	<u>Example</u>
30	Quiet library, soft whispers
40	Living room, refrigerator, bedroom away from traffic
50	Light traffic, normal conversation, quiet office
60	Air conditioner at 20 feet, sewing machine
70	Vacuum cleaner, hair dryer, noisy restaurant
80	Average city traffic, garbage disposals, alarm clock at two feet

THE FOLLOWING NOISES CAN BE DANGEROUS UNDER CONSTANT EXPOSURE:

90	Subway, motorcycle, truck traffic, lawn mower
100	Garbage truck, chain saw, pneumatic drill
120	Rock band concert in front of speakers, thunderclap
140	Gunshot blast, jet engine
180	Rocket launching pad

Information courtesy of the Deafness Research Foundation.



IMPORTANT SERVICE SAFETY INSTRUCTIONS

Before using the unit, be sure to read all operating instructions carefully. Please note that these are general precautions and may not pertain to your unit. For example, this unit may not have the capability to be connected to an outdoor antenna.

1. READ INSTRUCTIONS

All the safety and operating instructions should be read before the product is operated.

2. RETAIN INSTRUCTIONS

The safety and operating instructions should be retained for future reference.

3. HEED WARNINGS

All warnings on the product and in the operating instructions should be adhered to.

4. FOLLOW INSTRUCTIONS

All operating and use instructions should be followed.

5. CLEANING

Unplug this product from the wall outlet before cleaning. Do not use liquid cleaners or aerosol cleaners. Use a dry cloth for cleaning.

6. ATTACHMENTS

Do not use attachments not recommended by the product's manufacturer as they may cause hazards.

7. WATER AND MOISTURE

Do not use this product near water—for example: near a bathtub, washbowl, kitchen sink or laundry tub; in a wet basement; or near a swimming pool.

8. ACCESSORIES

Do not place this product on an unstable cart, stand, tripod, bracket or table. The product may fall, causing serious injury and serious damage to the product. Use only with a cart, stand, tripod, bracket or table recommended by the manufacturer or sold with the product. Any mounting of the product should follow the manufacturer's instructions, and should use a mounting accessory recommended by the manufacturer.

- 8A. An appliance and cart combination should be moved with care. Quick stops, excessive force and uneven surfaces may cause the appliance and cart combination to overturn.

PORTABLE CART WARNING
(symbol provided by RETAC)



9. VENTILATION

Slots and openings in the cabinet and in the back or bottom are provided for ventilation, to ensure reliable operation of the product and to protect it from overheating. These openings must not be blocked or covered. The openings should never be blocked by placing the product on a bed, sofa, rug or other similar surface. This product should never be placed near or over a radiator or heat source. This product should not be placed in a built-in installation such as a bookcase or rack unless proper ventilation is provided or the manufacturer's instructions have been adhered to.

10. POWER SOURCES

This product should be operated only from the type of power source indicated on the marking label. If you are not sure of the type of power supply to your home, consult your appliance dealer or local power company. For products intended to operate from battery power, or other sources, refer to the operating instructions.

11. GROUNDING OR POLARIZATION

This product is equipped with a polarized alternating-current line plug (a plug having one blade wider than the other). This plug will fit into the power outlet only one way. This is a safety feature. If you are unable to insert the plug fully into the outlet, try reversing the plug. If the plug should still fail to fit, contact your electrician to replace your obsolete outlet. Do not defeat the safety purpose of the polarized plug.

12. POWER-CORD PROTECTION

Power-supply cords should be routed so that they are not likely to be walked on or pinched by items placed upon or against them, paying particular attention to cords at plugs, convenience receptacles, and the point where they exit from the appliance.

13. LIGHTNING

To protect your product from a lightning storm, or when it is left unattended and unused for long periods of time, unplug it from the wall outlet and disconnect the antenna or cable system. This will prevent damage to the product due to lightning and power-line surges.

14. POWER LINES

An outside antenna system should not be located in the vicinity of overhead power lines or other electric light or power circuits, or where it can fall into such power lines or circuits. When installing an outside antenna system, extreme care should be taken to keep from touching such power lines or circuits as contact with them might be fatal.

15. OVERLOADING

Do not overload wall outlets and extension cords as this can result in a risk of fire or electric shock.

16. OBJECT AND LIQUID ENTRY

Never push objects of any kind into this product through openings as they may touch dangerous voltage points or short out parts that could result in fire or electric shock. Never spill or spray any type of liquid on the product.

17. OUTDOOR ANTENNA GROUNDING

If an outside antenna is connected to the product, be sure the antenna system is grounded so as to provide some protection against voltage surges and built-up static charges. Section 810 of the National Electric Code, ANSI/NFPA 70, provides information with respect to proper grounding of the mast and supporting structure, grounding of the lead-in wire to an antenna discharge product, size of grounding conductors, location of antenna discharge product, connection to grounding electrodes and requirements for grounding electrodes.

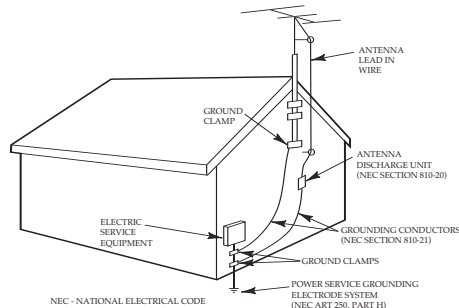

EXAMPLE OF ANTENNA GROUNDING AS PER NATIONAL ELECTRICAL CODE

18. SERVICING

Do not attempt to service this product yourself as opening or removing covers may expose you to dangerous voltage or other hazards. Refer all servicing to qualified service personnel.

19. REPLACEMENT PARTS

When replacement parts are required, be sure the service technician uses replacement parts specified by the manufacturer or those that have the same characteristics as the original part. Unauthorized substitutions may result in fire, electric shock or other hazards.

20. SAFETY CHECK

Upon completion of any service or repairs to this product, ask the service technician to perform safety checks to determine that the product is in proper operating condition.

21. WALL OR CEILING MOUNTING

The product should be mounted to a wall or ceiling only as recommended by the manufacturer.

22. DAMAGE REQUIRING SERVICE

Unplug the product from the wall outlet and refer servicing to qualified service personnel under the following conditions:

- When the power-supply cord or plug is damaged.
- If liquid has been spilled or objects have fallen into the product.
- If the product has been exposed to rain or water.
- If the product does not operate normally by following the operating instructions. Adjust only those controls that are covered by the operating instructions, as an adjustment of other controls may result in damage and will often require extensive work by a qualified technician to restore the product to its normal operation.
- If the product has been dropped or the cabinet has been damaged.
- When the product exhibits a distinct change in performance—this indicates a need for service.

23. HEAT

The product should be situated away from heat sources such as radiators, heat registers, stoves or other products (including amplifiers) that produce heat.

24. NOTE TO CATV SYSTEM INSTALLER

This reminder is provided to call the CATV system installer's attention to Article 820-40 of the NEC that provides guidelines for proper grounding and, in particular, specifies that the cable ground shall be connected to the grounding system of the building, as close to the point of cable entry as practical.

PREPARATION FOR USE

SPEAKER CONNECTION

1. Place the speakers in convenient locations on either side of the unit. Usually a distance of five to eight feet between speakers provides the best stereo effect, but this may vary depending on the size and acoustics of the room.
2. Locate the Speaker Jacks on the rear of the unit and connect the red wires to the red (+) terminals and connect the black wires to the black (-) terminals.
3. To connect the speakers, press and hold the terminal down, insert the speaker wire and release.
4. Pull lightly on the connection to make sure it is secure.

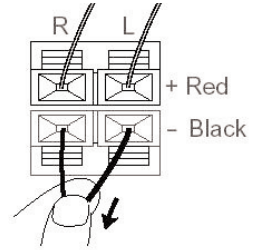

CAUTION: Only connect the speakers which are supplied with the unit. The use of any other or additional speakers may cause damage to the unit. Never operate the unit without the speakers connected.

BATTERY OPERATION FOR THE REMOTE CONTROL

The battery compartment is located on the rear of the remote control.

- Remove the battery compartment door by pressing down on the tab and lifting the battery compartment off.
- Insert two (2) AAA size batteries into the battery compartment as shown to the right. Be sure to observe the polarity markings which are engraved inside the battery compartment. If the batteries are inserted incorrectly, the remote control will not operate.
- Replace the battery compartment door.

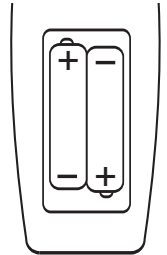

BATTERY PRECAUTIONS

Follow these precautions when using batteries in this device:

1. Use only the size and type of batteries specified (alkaline are recommended).
2. Be sure to follow the correct polarity when installing the batteries as indicated in the battery compartment. Reversed batteries may cause damage to the device.
3. Do not mix different types of batteries together (e.g. Alkaline, Carbon-zinc or rechargeable) or old batteries with fresh ones.
4. If the device is not to be used for a long period of time, remove the batteries to prevent damage or injury from possible battery leakage.
5. Do not try to recharge batteries not intended to be recharged; they can overheat and rupture.
(Follow battery manufacturer's directions.)

AC CONNECTION

Unwind the AC cord and extend it to its full length. Insert the end of the AC cord into any convenient 120V 60Hz household outlet.

Please note that this unit is equipped with a polarized AC plug which has one blade wider than the other. This is a safety feature to reduce the likelihood of electric shock. This polarized AC plug will only fit in a polarized AC outlet. If you find that you cannot insert this plug into your outlet, you may have an obsolete non-polarized outlet. Please do not try to defeat this safety feature by using a non-polarized adapter or by filing the wider blade to make it fit into your outlet. If this plug does not fit into your outlet, you should contact a qualified licensed electrician to replace your obsolete outlet.

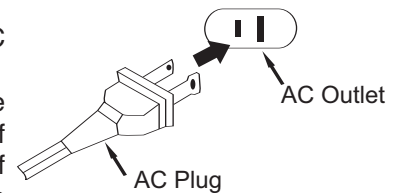

IMPORTANT NOTES:

- Before moving or lifting the unit, make sure the power plug is disconnected from the power source.
- Do not move or lift the unit during playing/loading of a CD as this may cause malfunction to the CD mechanism.
- If there is a power failure or the AC cord is disconnected, when the AC cord is connected again, the clock will be reset ("12:00" will appear in the display) and you will need to set the clock again.

PREPARATION FOR USE (CONTINUED)

CONNECTING AN EXTERNAL UNIT

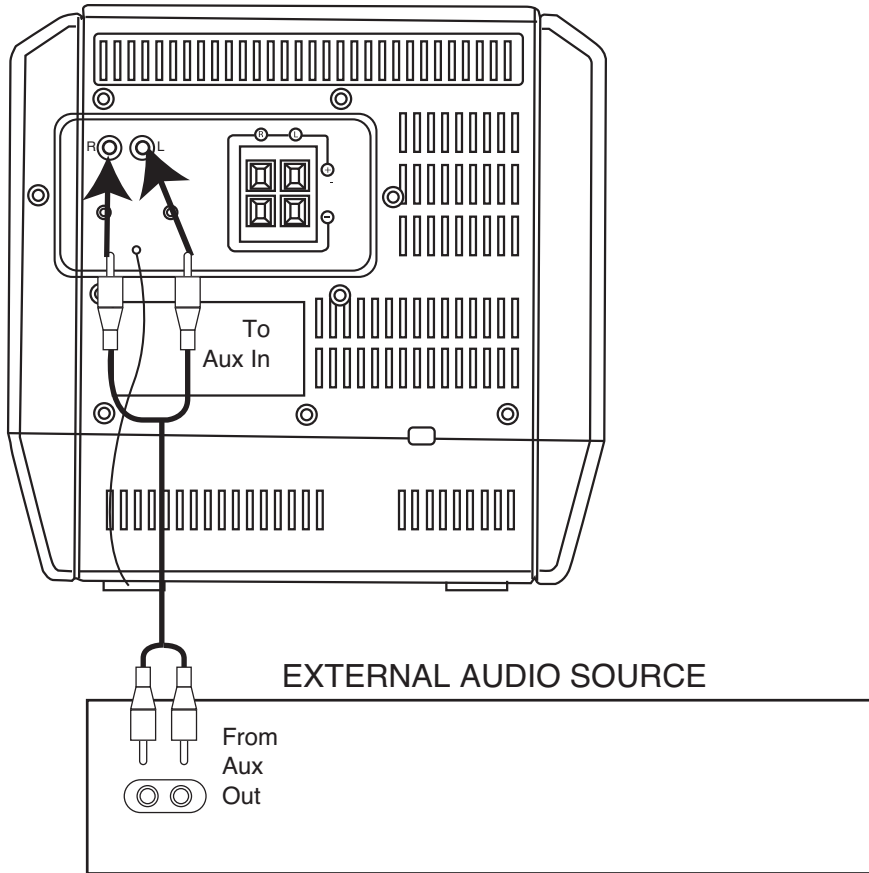

NOTES:

- Connecting the unit to an external audio source will allow you to broadcast the external unit's sound through this unit's speakers.
- When connecting the external unit, refer to the owner's manual of the external unit, as well as this manual.
- When connecting the external unit, make sure the power is off and both units are unplugged before making any connections.

To hear the unit connected to the Aux In jacks, turn both units on, then press the FUNCTION button until the AUX indicator appears in the display.

REMOTE SENSOR

To operate the unit with the remote control, point the remote at the remote sensor on the front of the main unit and press the appropriate button. The remote control has an effective operating range of approximately 15 feet and an angle of no more than 30°.

NOTE: Bright sunlight may interfere with the operation of the remote control.

LOCATION OF CONTROLS

FRONT

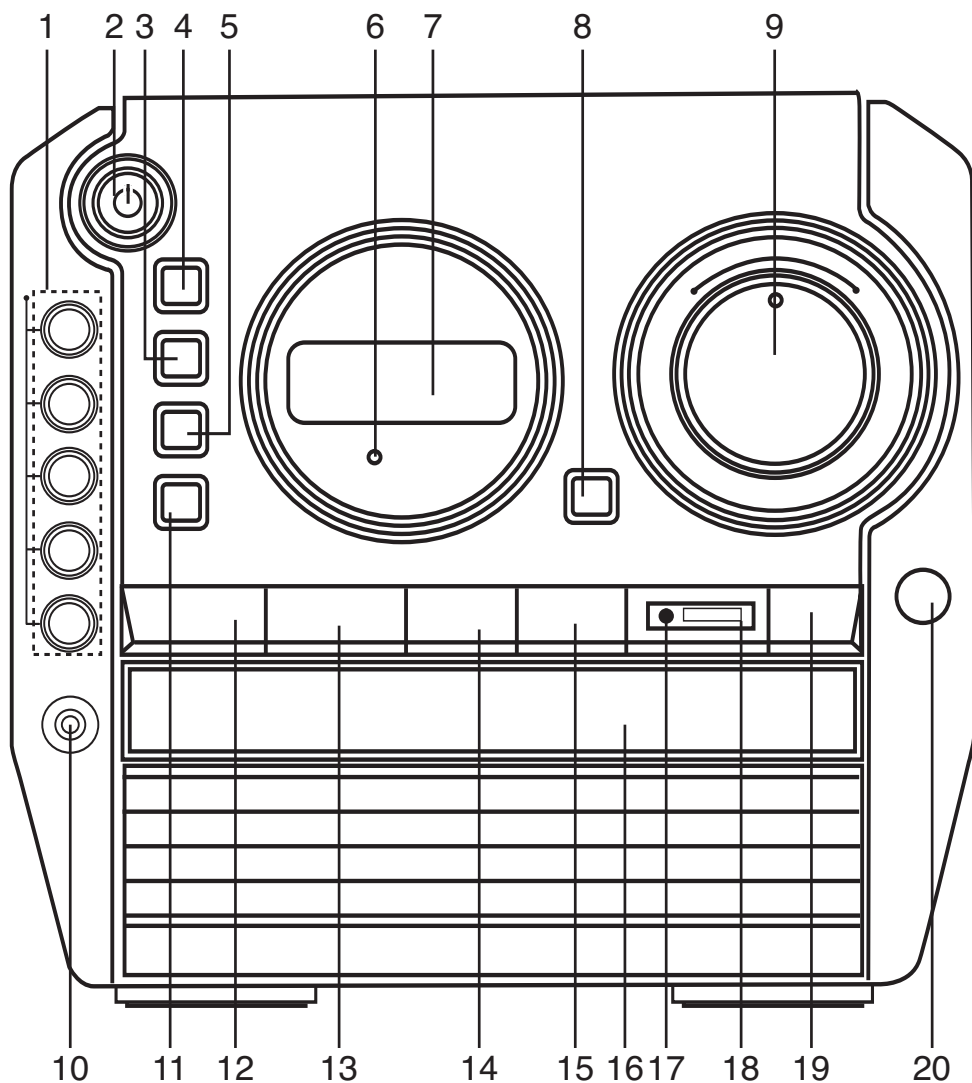

- | | |
|--|-----------------------------|
| 1. DISC SELECT 1-5 Buttons/Disc Indicators | 10. Headphone Jack |
| 2. POWER Button | 11. MEM-UP Button |
| 3. PROGRAM//MEMORY/ CLOCK SET Button | 12. PLAY/PAUSE (▶) Button |
| 4. FUNCTION Button | 13. STOP (■) Button |
| 5. CD MODE Button | 14. SKIP/TUNING ◀◀ Button |
| 6. REPEAT ALL DISC Indicator | 15. SKIP/TUNING ▶▶ Button |
| 7. Display | 16. CD Tray |
| 8. BAND Button | 17. BASS BOOST Indicator |
| 9. VOLUME Control | 18. BASS BOOST Button |
| | 19. Open/Close Button |
| | 20. Remote Sensor |

LOCATION OF CONTROLS (CONTINUED)

REAR

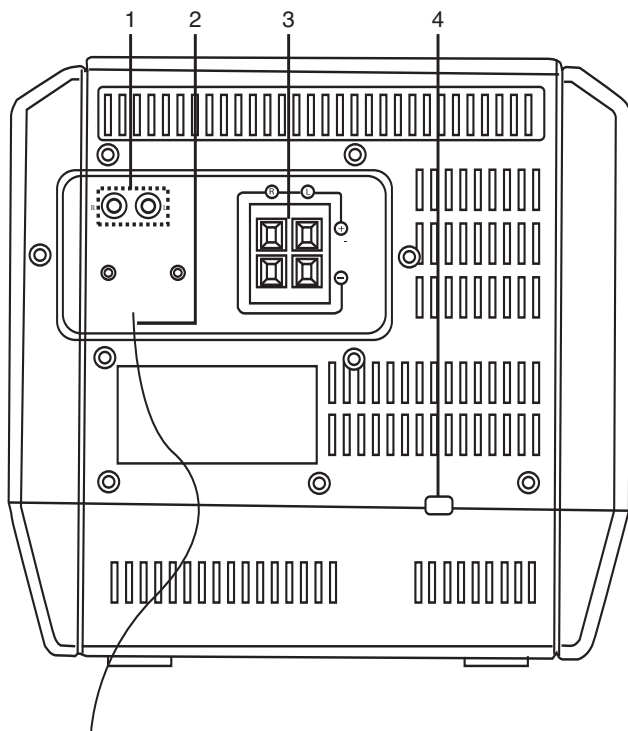

1. AUX In Jacks
2. FM Wire Antenna
3. Speaker Jacks
4. AC Cord

REMOTE

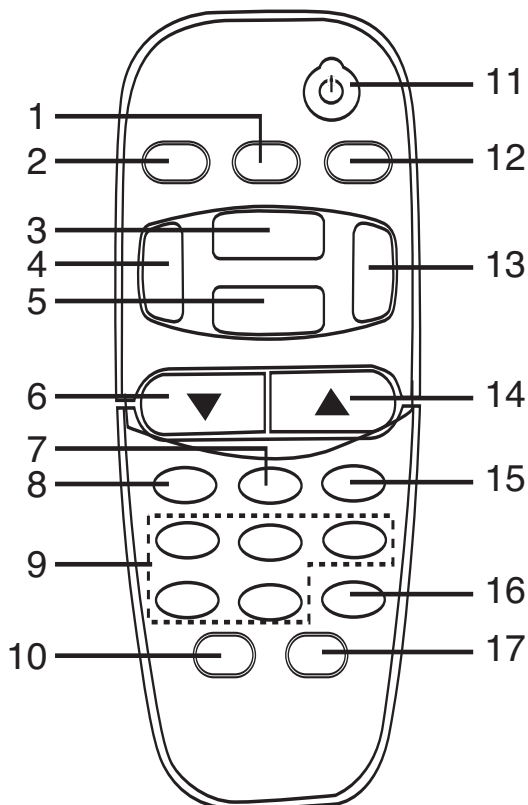

1. FUNCTION Button
2. OPEN/CLOSE Button
3. PLAY/PAUSE (▶||) Button
4. SKIP/TUNING ◀◀ Button
5. STOP (■) Button
6. VOLUME Down Button
7. PROGRAM/MEMORY/CLOCK SET Button
8. CD MODE Button
9. DISC 1-5 Buttons
10. MEM-DOWN Button
11. POWER Button
12. BASS BOOST Button
13. SKIP/TUNING ▶▶ Button
14. Volume Up Button
15. BAND Button
16. REPEAT ALL DISC Button
17. MEM-UP Button

OPERATING INSTRUCTIONS

SETTING THE CLOCK

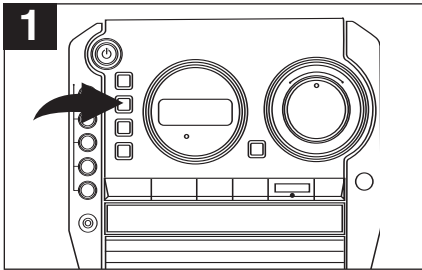

While the unit is at the standby mode (the clock appears in the display and the backlight is dimly lit), press and hold the PROGRAM/MEMORY/CLOCK SET button; "24" or "12" will blink in the display.

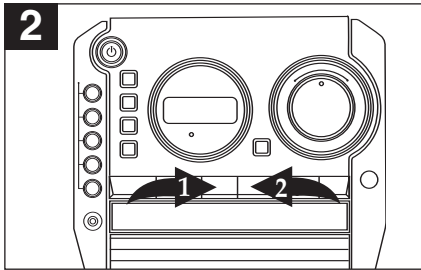

Press the SKIP/TUNING **1** or **2** button to set the unit to the 24 hour (24H) mode (also known as military time), or 12 hour (12H) mode.

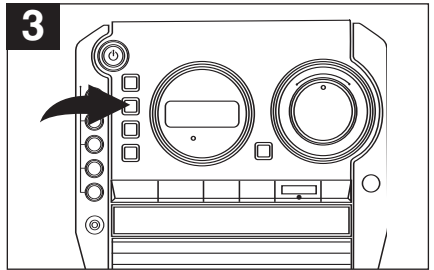

Press the PROGRAM/MEMORY/CLOCK SET button and the hours will blink.

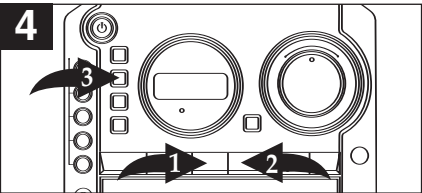

Press the SKIP/TUNING **1** or **2** button to set the current hour (making sure to also set the correct AM/PM setting if in 12H mode), then press the PROGRAM/MEMORY/CLOCK SET button **3** again; the minute digits will blink.

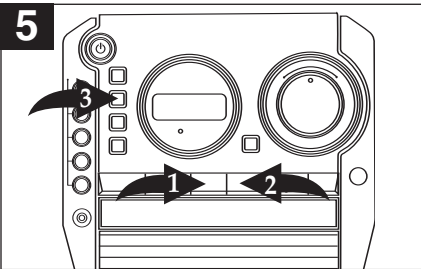

Press the SKIP/TUNING **1** or **2** button to set the current minute. Press the PROGRAM/MEMORY/CLOCK SET button **3** and the time will be set.

BASS BOOST

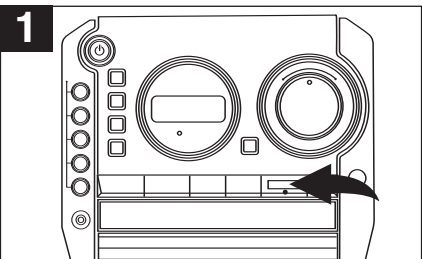

To enhance the overall bass sound, press the BASS BOOST button; the BASS BOOST indicator will light. Press again for normal bass sound; the BASS BOOST indicator will go out.

HEADPHONE JACK

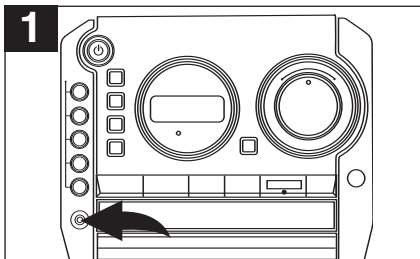

To listen to the unit through headphones, simply insert the headphones (not included) into the Headphone jack. The speakers will be disconnected when the headphones are plugged in.

BACKLIGHT

While the unit is on Standby mode, the backlight will light dimly. While the unit is on, the backlight will light brightly.

OPERATING INSTRUCTIONS (CONTINUED)

LISTENING TO THE RADIO

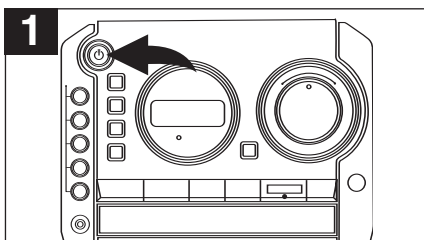

Press the POWER button to turn the unit on; the display will light brightly.

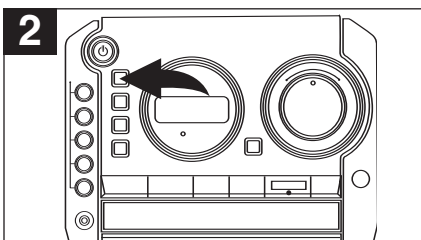

Press the FUNCTION button repeatedly until the tuner is selected; "AM" or "FM" and the frequency will appear in the display.

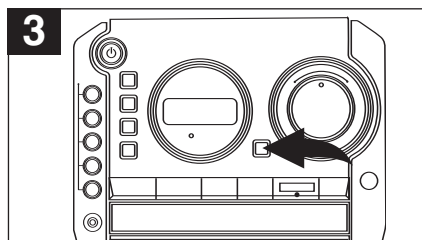

Press the BAND button on the main unit or at the remote to select AM or FM.

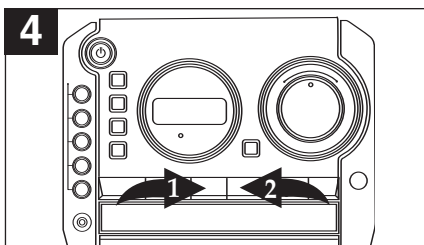

MANUAL TUNING: Repeatedly press the SKIP/TUNING ◀ ❶ or ▶ ❷ button to manually advance the frequency in the display up or down until the desired frequency appears. For FM, "ST" (Stereo indicator) will appear if the station is broadcasting in stereo.

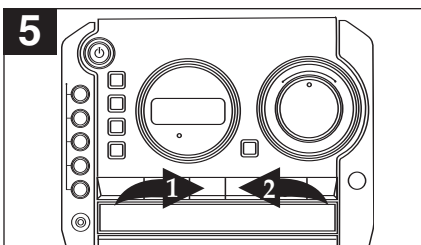

AUTOMATIC TUNING: Press and hold the SKIP/TUNING ◀ ❶ or ▶ ❷ button until the frequency in the display starts to scan, and then release the button; the tuner will search and then stop on the next strong station it finds. Repeat this step until the desired frequency appears in the display.

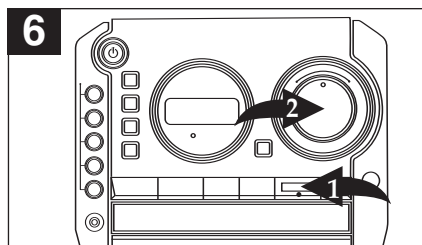

Adjust the BASS BOOST button ❶ and VOLUME control ❷ as desired.

Hints for Better Reception

AM—The AM ferrite bar antenna is located inside the unit. It may be necessary to turn the unit slightly so that the internal antenna is pointing in the direction of the AM transmitter. You may have to experiment to find the position that provides the strongest reception for each of your favorite AM stations.

FM—Make sure that the FM Wire Antenna is extended to its full length. You may have to vary the direction of the antenna to find the strongest signal for each FM station.

NOTE:

When you turn the unit off and then back on again, the volume setting will return to the default setting level.

OPERATING INSTRUCTIONS (CONTINUED)

SETTING RADIO PRESETS

This unit can preset 10 AM and 10 FM radio stations for convenient recall.

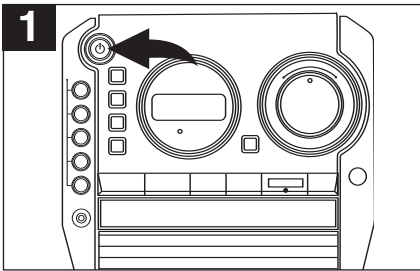

Press the POWER button to turn the unit on; the display will light brightly.

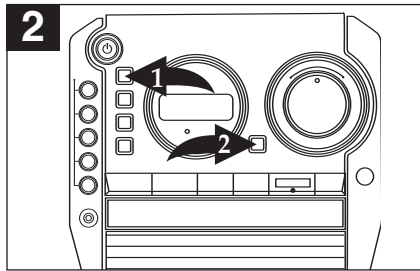

Press the FUNCTION button ❶ repeatedly until the tuner is selected; "AM" or "FM" indicator will appear in the display. Press the BAND button ❷ on the main unit to select AM or FM.

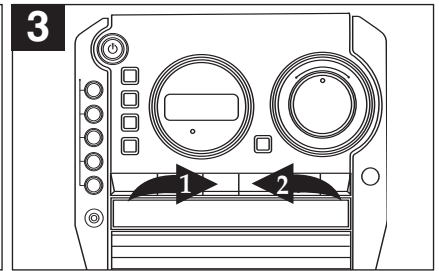

Press the SKIP/TUNING ◀❶ or ▶❷ button to select a station.

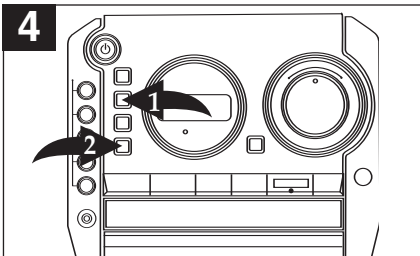

Press the PROGRAM/MEMORY/CLOCK SET button ❶; the preset number will appear and MEM will blink in the display. Press the MEM-UP button ❷ (or MEM-DOWN on the remote) until the desired memory number appears on the display.

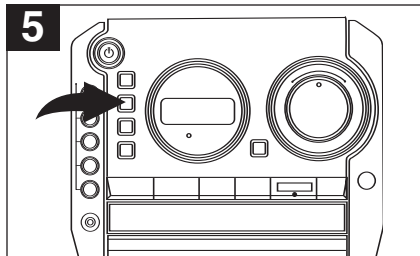

Press the PROGRAM/MEMORY/CLOCK SET button again to set the station in the selected memory.

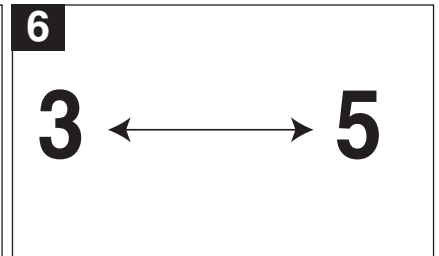

Repeat steps 3 through 5 to program up to 10 stations in each band, if desired.

RECALLING RADIO PRESETS (10 EACH BAND)



Follow steps 1 and 2 above.

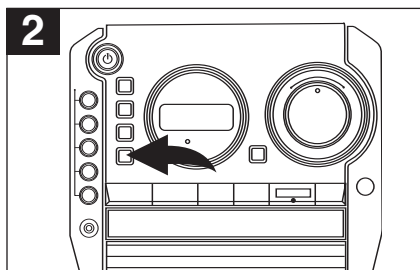

Press the MEM-UP button (or MEM-DOWN button on remote) to select a preset; the station will automatically be tuned in.

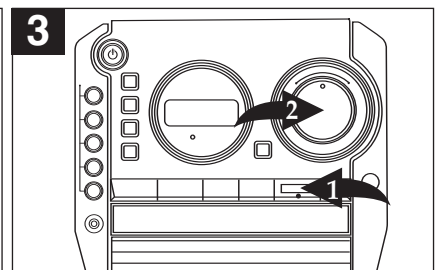

Adjust the BASS BOOST button ❶ and VOLUME control ❷ as desired.

OPERATING INSTRUCTIONS (CONTINUED)

PLAYING COMPACT DISCS

This unit can play standard, single or CD-R CDs.

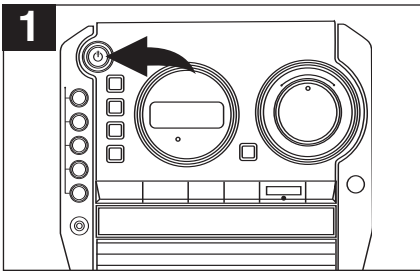

1 Press the **POWER** button to turn the unit on; the display will light brightly.

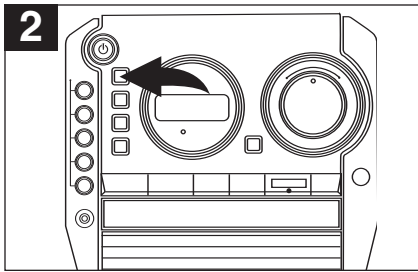

2 Press the **FUNCTION** button repeatedly until CD is selected; one of the disc indicator will blink and the other disc indicators will light. Then the unit will start playback the discs automatically (If there are discs in the trays).

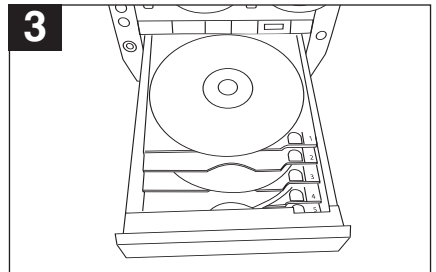

3 Press the **STOP** button to stop the playback, then press the **Open/Close** button and insert a CD onto the top spindle.

NOTE: If a CD is already playing, that CD spindle will not eject, it will remain in the unit. To eject all the CD spindles, press the **STOP** (■) button before pressing the **Open/Close** button.

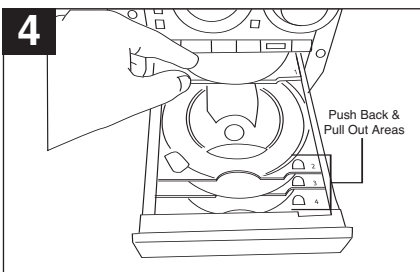

4 To insert more CDs, insert a disc in the top spindle, then slightly push the **Push Back & Pull Out** areas to push back the top spindle to the unit. Then, insert another CD. Repeat this step for up to five CDs.

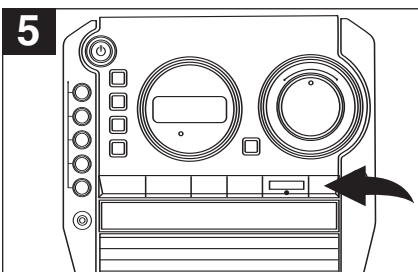

5 Press the **Open/Close** button to close the CD tray. The first disc will automatically start playing.

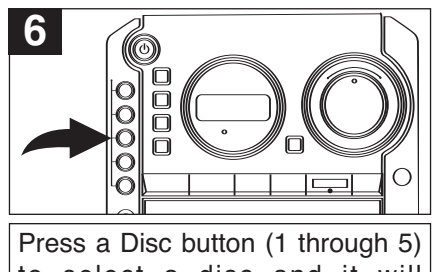

6 Press a **Disc** button (1 through 5) to select a disc and it will automatically start playing.

NOTE: The respective disc indicator will light when a disc is inserted, blink when the disc is playing. If there is no disc on the selected spindle, that Disc indicator will turn off and the unit will skip to playback the next disc.

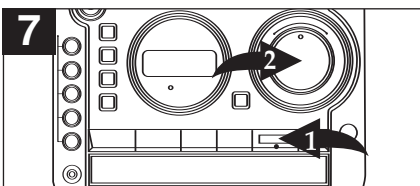

7 Adjust the **BASS BOOST** button ① and **VOLUME** control ② as desired. Playback will continue until all the tracks on all the discs have played.

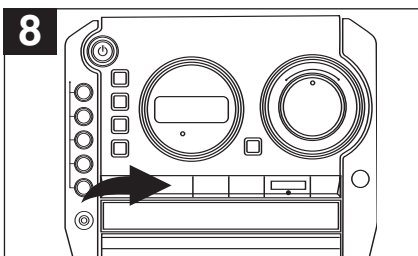

8 To stop playback before the discs end, press the **STOP** (■) button. The disc will stop and the display will show the total number of tracks on the selected disc.

OPERATING INSTRUCTIONS (CONTINUED)

CD PAUSE CONTROL

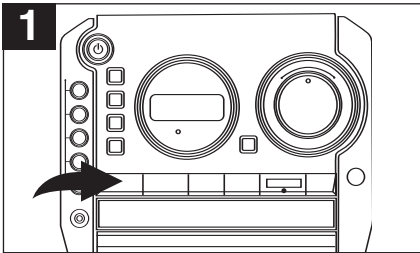

1 During CD playback, if you wish to pause the disc momentarily, press the PLAY/PAUSE (▶||) button. Playback stops but the disc continues to spin and the Play indicator will blink.

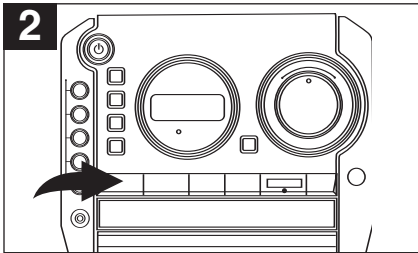

2 Press the PLAY/PAUSE (▶||) button again to release pause and resume normal CD playback.

FORWARD/REVERSE SKIP TRACK AND HIGH-SPEED MUSIC SEARCH (▶▶/◀◀)

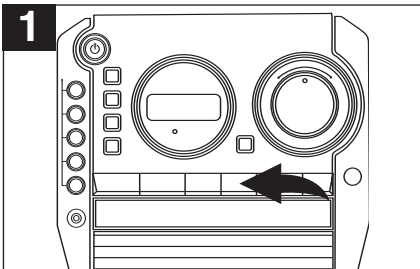

1 During playback, press the SKIP/TUNING ▶▶ button once to advance the player to the beginning of the next track. Press the SKIP/TUNING ▶▶ button repeatedly to advance the player to higher-numbered tracks.

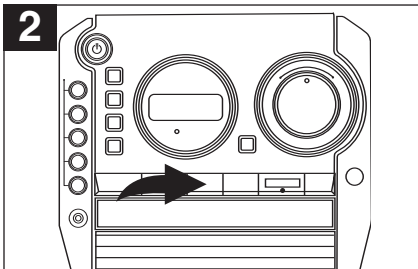

2 During playback, press the SKIP/TUNING ◀◀ button once to move the player back to the beginning of the current track. Press the SKIP/TUNING ◀◀ button repeatedly to move the player back to lower-numbered tracks.

3 During playback, depress and hold either the SKIP/TUNING ▶▶ or ◀◀ button to move the player forward or backward within a track to locate a specific musical passage. The player will move forward or backward at high speed as long as the button is depressed. When you release the SKIP/TUNING ▶▶ or ◀◀ button, normal playback will resume.

NOTE: You can only using the SKIP/TUNING ▶▶ or ◀◀ button to skip through the tracks on the selected CD playing back. If you want to skip to playback the tracks on the other discs, use the Disc select button (1 through 5) to select the desired disc first, then using the SKIP/TUNING ▶▶ or ◀◀ button to select the desired track.

OPERATING INSTRUCTIONS (CONTINUED)

REPEAT PLAYBACK ONE TRACK OR ALL TRACKS ON A SELECTED DISC

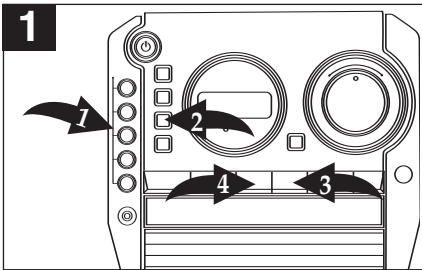

To repeat a single track, select a Disc by pressing one of the Disc (1 through 5) buttons ❶; playback will start automatically. Press the CD MODE button ❷ once; "RPT" will blink in the display. Press the SKIP/TUNING ►► ❸ or ◄◄ ❹ button to select the specific track that you wish to repeat. The specific track you selected will be repeated continuously.

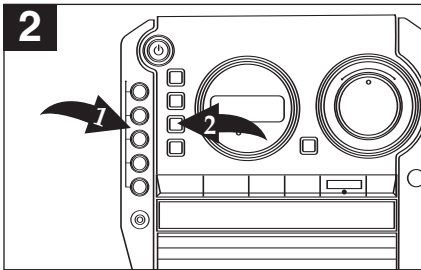

To repeat all of the tracks on a disc continuously, select a Disc by pressing one of the Disc (1 through 5) buttons ❶; playback will start automatically. Press the CD MODE button ❷ twice; "RPT" will light solid in the display. All tracks on the selected CD will repeat playback continuously.

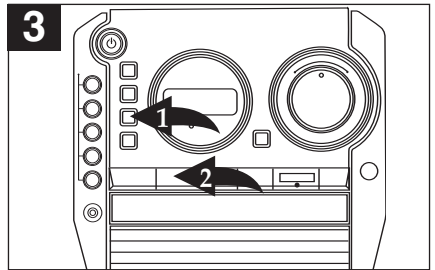

To cancel Repeat Playback, press the CD MODE button ❶ until "RPT" and "RND" disappear from the display or press the STOP (■) button ❷ to stop the repeat playback."

REPEAT ALL DISC PLAYBACK

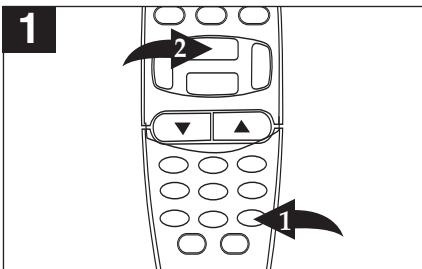

To repeat ALL discs, press the REPEAT ALL DISC button ❶ on the remote control; the REPEAT ALL DISC indicator will light. Press the PLAY/PAUSE (▶||) button ❷ to begin the repeat all function.

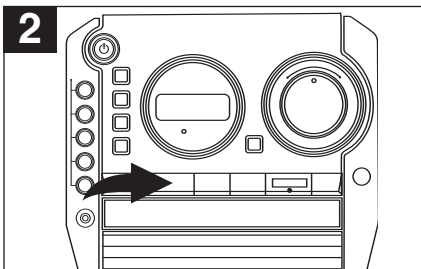

All of the discs will repeat until the STOP (■) button is pressed.

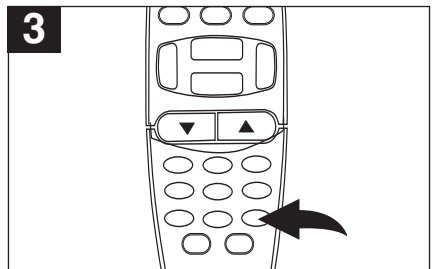

To cancel Repeat Playback, press the REPEAT ALL DISC button again; the REPEAT ALL DISC indicator will turn off.

OPERATING INSTRUCTIONS (CONTINUED)

RANDOM PLAYBACK

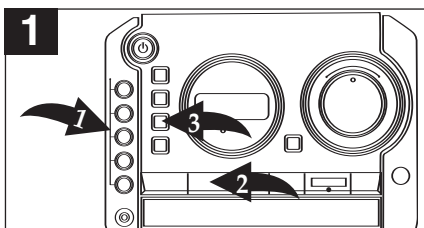

To play the tracks on the desired CD in a random order. Press a Disc Select button (1 through 5) ❶ to select the desired disc, then press the STOP (■) button ❷ to stop the playback. Press the CD MODE button ❸ three times; "RND" will appear in the display.

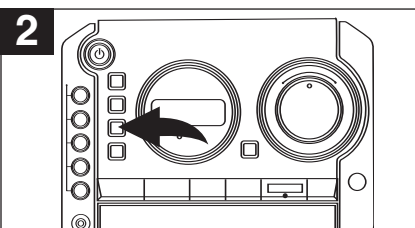

Press the PLAY/PAUSE button to start random playback of the selected disc. The CD player will play back all the tracks of the selected disc randomly, then it will skip to playback the tracks on next disc in Normal sequence order. Playback will continue until all the tracks on all the discs have played.

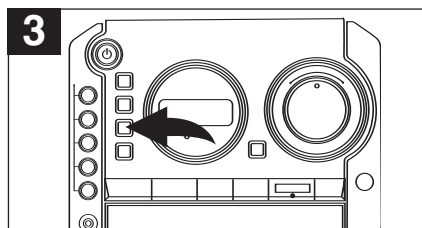

To cancel random playback, press the CD MODE button until "RPT" and "RND" disappear from the display.

NOTE: The Random feature will randomly play the selected disc, not all of the inserted discs.

PROGRAMMED PLAYBACK

The CD player in this unit has a 20 track programmable memory that allows you to program up to 20 tracks on any disc for playback in any desired order. You may program 20 different tracks or you may also program certain tracks to play more than once.

IMPORTANT: You can only program tracks on the selected disc, not all of the inserted discs. To perform programmed playback, proceed as follows:

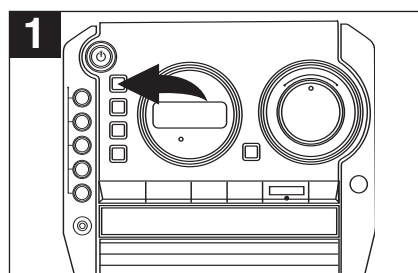

With the unit on, press the FUNCTION button repeatedly until CD is selected; one of the Disc indicator will blink and the other disc indicators will light.

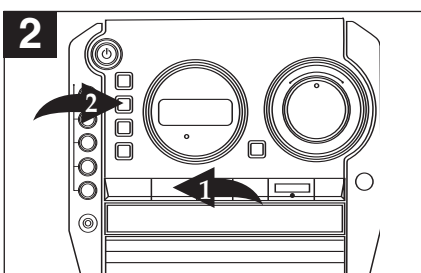

Press the STOP (■) button ❶ to stop automatic playback. Press the PROGRAM/MEMORY/CLOCK SET button ❷; "P-01" (program number) will appear briefly, then "MEM" and "01" (track number) will blink in the display.

PROGRAMMED PLAYBACK SECTION CONTINUED ON NEXT PAGE.

OPERATING INSTRUCTIONS (CONTINUED)

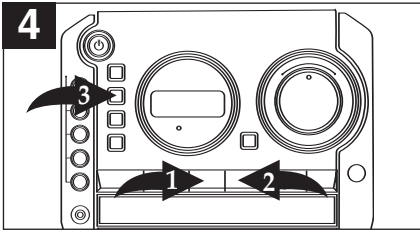

Press the SKIP/TUNING \ll ❶ or \gg ❷ button to select the first track that you wish to program. When the desired track number appears in the display, press the PROGRAM/MEMORY/CLOCK SET button ❸ again.

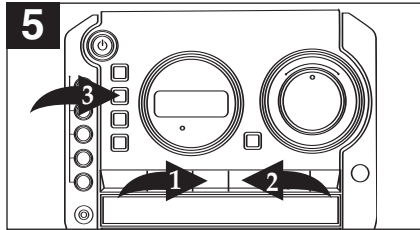

Press either the SKIP/TUNING \ll ❶ or \gg ❷ button to select the next track you wish to program. When the desired track number appears in the display, press the PROGRAM/MEMORY/CLOCK SET button ❸ again.

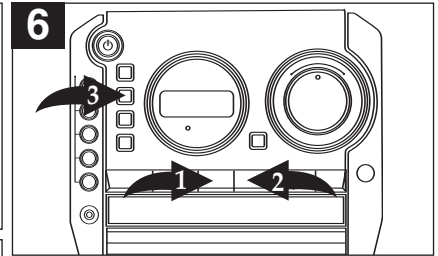

Repeat step 5 until you have programmed up to 20 track numbers into the CD Program Memory. When the memory is full, "- -" will blink in the display.

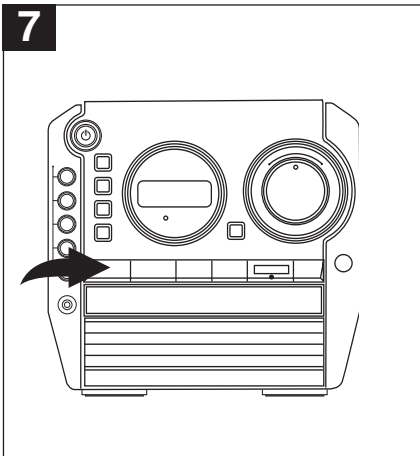

After programming up to 20 tracks in the CD Program Memory, press the PLAY/PAUSE (\blacktriangleright ||) button to begin programmed playback. "MEM" will appear in the display and playback will begin on the first track that you programmed. The player will continue to play all of the tracks that you programmed in the order in which you programmed them. When the last programmed track has been played, the player will start playback the first track on the next disc. Playback will continue until all the tracks on all the discs have played.

NOTE: When the programmed tracks are played, the player will start playback the tracks on next disc and the programmed memory will be cleared. To repeat playback the program, see below.

PROGRAMMED REPEAT

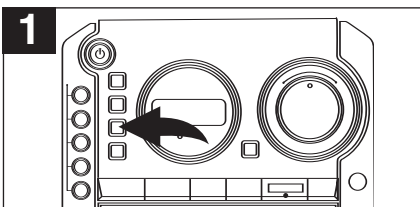

It is also possible to use the Program and Repeat functions together to repeat a specific program indefinitely. First, press the CD MODE button twice to enter the Repeat All mode and then program the tracks you wish to hear in the order you wish to hear them, as described above. The "MEM" indicator will flash and the "RPT" indicator will appear in the display.

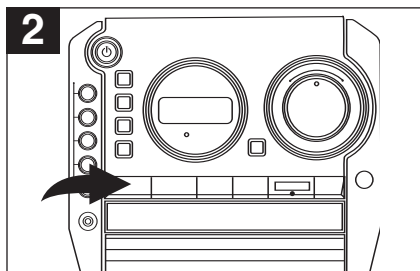

Press the PLAY/PAUSE (\blacktriangleright ||) button to begin programmed repeat playback. The player will play the tracks you selected in the order in which you programmed them. When the last track in the program has been played, the entire program will begin again.

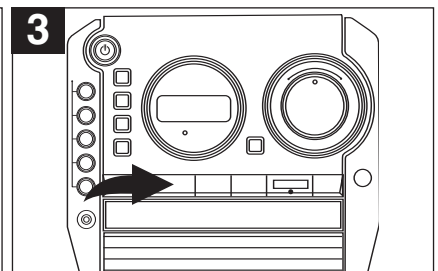

Programmed Repeat operation will continue indefinitely until you press the STOP (\blacksquare) button.

CARE AND MAINTENANCE

Caring for Compact Discs

- Treat the compact disc carefully. Handle the compact disc only by its edges. Never allow your fingers to come in contact with the shiny, unprinted side of the compact disc.
- Do not attach adhesive tape, stickers, etc. to the compact disc label.
- Clean the compact disc periodically with a soft, lint-free, dry cloth. Never use detergents or abrasive cleaners to clean the compact disc. If necessary, use a CD cleaning kit.
- If a compact disc skips or gets stuck on a section of the compact disc, it is probably dirty or damaged (scratched).
- When cleaning the compact disc, wipe in straight lines from the center of the compact disc to the outer edge of the compact disc. Never wipe in circular motions.

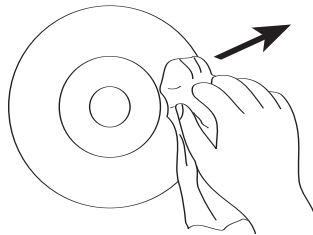
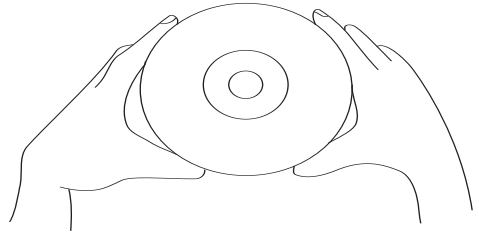

- This unit is designed to play only compact discs bearing the identification logo as shown here. Other compact discs may not conform to the CD standard and may not play properly.
- Compact discs should be stored in their cases after each use to avoid damage.
- Do not expose compact discs to direct sunlight, high humidity, high temperatures or dust, etc. Prolonged exposure or extreme temperatures can warp the compact disc.
- Do not stick or write anything on either side of the compact disc. Sharp writing instruments, or the ink, may damage the surface.



Cleaning the unit

- To prevent fire or shock hazard, disconnect your unit from the AC power source when cleaning.
- The finish on your unit may be cleaned with a dust cloth and cared for as other furniture. Use caution when cleaning and wiping the plastic parts.
- Mild soap and a damp cloth may be used on the front panel.

TROUBLESHOOTING GUIDE

Should this unit exhibit a problem, check the following before seeking service:

Symptom	Possible Cause	Solution
Radio		
Noise or sound distorted on radio broadcasts.	Station not tuned properly for AM or FM.	Retune the AM or FM broadcast station.
	AM: Unit is not positioned correctly.	Rotate unit for best reception.
	FM: Wire antenna is not extended.	Extend wire antenna.
FM ST indicator does not light.	Poor FM signal being received.	Retune station or try another station that broadcasts in stereo.
	Station is not broadcasting in stereo.	Change stations.
AM or FM, no sound.	Tuner is not selected.	Press the FUNCTION button to select Tuner; AM or FM will appear.
	Volume at minimum.	Increase volume.
Compact Disc Player		
CD Player will not play.	CD is not selected.	Press the FUNCTION button to select CD; one of the disc indicators will blink and the others will light.
	CD is not installed or is installed incorrectly.	Insert CD with label facing up.
CD skips while playing.	Disc is dirty or scratched.	Wipe disc with cloth or use another disc.
General		
No power.	AC power cord is not connected.	Connect AC power cord.
Remote not working.	Batteries not inserted, or inserted incorrectly.	Insert batteries correctly.

**FOR ADDITIONAL SET-UP OR OPERATING ASSISTANCE, PLEASE VISIT OUR WEBSITE AT
WWW.MEMOREXELECTRONICS.COM
OR CONTACT CUSTOMER SERVICE AT (954) 660-7100.**

PLEASE KEEP ALL PACKAGING MATERIAL FOR AT LEAST 90 DAYS IN CASE YOU NEED TO RETURN THIS PRODUCT TO YOUR PLACE OF PURCHASE OR MEMOREX.

FOR PARTS AND ACCESSORIES, CONTACT FOX INTERNATIONAL AT 1-800-321-6993.

SPECIFICATIONS

GENERAL

Power Source (Main Unit)	AC 120V, 60 Hz
Power Source (Remote Control)	DC 3V, 2 x "AAA" size battery
Speaker	8 Ohms x 2
Output Power.....	12.5W x 2

RADIO SECTION

Frequency Range (FM).....	87.5 - 108 MHz
Frequency Range (AM).....	530 - 1710 KHz

CD SECTION

Disc Diameter.....	4.72" (120mm)
.....	3.15" (80mm) Single CD
Optical Source	Semiconductor Laser

Memcorp, Inc.
Weston, FL
Printed in Hong Kong

Visit our website at www.memorexelectronics.com

Free Manuals Download Website

<http://myh66.com>

<http://usermanuals.us>

<http://www.somanuals.com>

<http://www.4manuals.cc>

<http://www.manual-lib.com>

<http://www.404manual.com>

<http://www.luxmanual.com>

<http://aubethermostatmanual.com>

Golf course search by state

<http://golfingnear.com>

Email search by domain

<http://emailbydomain.com>

Auto manuals search

<http://auto.somanuals.com>

TV manuals search

<http://tv.somanuals.com>