



OWNER'S MANUAL

Memorex®

**COMBINATION 20" FLAT COLOR TELEVISION
AND VIDEO CASSETTE / DVD VIDEO PLAYER**

MVDT2002A



Hi-Fi

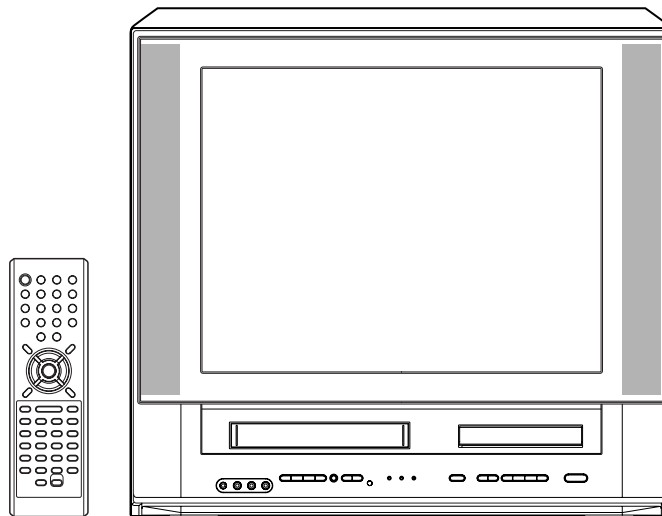

ATTENTION

If you purchase a universal remote control from your local retailer, please contact the remote manufacturer for the required programming code.

TV/CABLE MODE SELECTION

When shipped from the factory, the TV/CABLE menu option is set to the "CABLE" (Cable Television) mode. If not using CABLE, set this menu option to the "TV" position.

Before operating the unit, please read this manual thoroughly.



	CAUTION RISK OF ELECTRIC SHOCK DO NOT OPEN	
<p>CAUTION: TO REDUCE THE RISK OF ELECTRIC SHOCK, DO NOT REMOVE COVER (OR BACK). NO USER-SERVICEABLE PARTS INSIDE. REFER SERVICING TO QUALIFIED SERVICE PERSONNEL.</p>		



The lightning flash with arrowhead symbol, within an equilateral triangle is intended to alert the user to the presence of uninsulated dangerous voltage within the product's enclosure that may be of sufficient magnitude to constitute a risk of electric shock to persons.



The exclamation point within an equilateral triangle is intended to alert the user to the presence of important operating and maintenance (servicing) instructions in the literature accompanying the appliance.

WARNING: TO REDUCE THE RISK OF FIRE OR ELECTRIC SHOCK, DO NOT EXPOSE THIS APPLIANCE TO RAIN OR MOISTURE.

NOTE: Please keep all packaging material for at least 90 days in case you need to return this product to your place of purchase or Memorex.

WARNING: This equipment has been tested and found to comply with the limits for a Class B digital device, pursuant to Part 15 of the FCC Rules. These limits are designed to provide reasonable protection against harmful interference in a residential installation. This equipment generates, uses and can radiate radio frequency energy and, if not installed and used in accordance with the instructions, may cause harmful interference to radio communications. However, there is no guarantee that interference will not occur in a particular installation. If this equipment does cause harmful interference to radio or television reception, which can be determined by turning the equipment off and on, the user is encouraged to try to correct the interference by one or more of the following measures:

- Reorient or relocate the receiving antenna.
- Increase the separation between the equipment and receiver.
- Connect the equipment into an outlet on a circuit different from that to which the receiver is connected.
- Consult the dealer or an experienced radio/TV technician for help.

CAUTION: Changes or modifications not expressly approved by the party responsible for compliance with the FCC Rules could void the user's authority to operate this equipment.

CAUTION:
THIS DIGITAL VIDEO PLAYER EMPLOYS A LASER SYSTEM.

TO ENSURE PROPER USE OF THIS PRODUCT, PLEASE READ THIS USER'S GUIDE CAREFULLY AND RETAIN FOR FUTURE REFERENCE. SHOULD THE UNIT REQUIRE MAINTENANCE, CONTACT AN AUTHORIZED SERVICE LOCATION-SEE SERVICE PROCEDURE.

USE OF CONTROLS, ADJUSTMENTS OR THE PERFORMANCE OF PROCEDURES OTHER THAN THOSE SPECIFIED HEREIN MAY RESULT IN HAZARDOUS RADIATION EXPOSURE.

TO PREVENT DIRECT EXPOSURE TO LASER BEAM, DO NOT TRY TO OPEN THE ENCLOSURE. VISIBLE LASER RADIATION MAY BE PRESENT WHEN THE ENCLOSURE IS OPENED. DO NOT STARE INTO BEAM.

Location of the required Marking

The rating sheet and the safety caution are on the rear of the unit.

CERTIFICATION: COMPLIES WITH FDA RADIATION PERFORMANCE STANDARDS, 21 CFR SUBCHAPTER J.

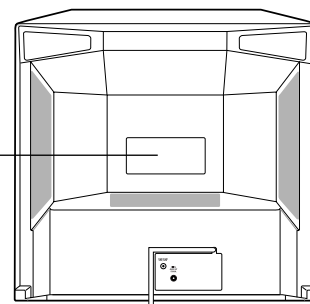



IMPORTANT SAFEGUARDS

1. READ INSTRUCTIONS

All the safety and operating instructions should be read before the unit is operated.

2. RETAIN INSTRUCTIONS

The safety and operating instructions should be retained for future reference.

3. HEED WARNINGS

All warnings on the unit and in the operating instructions should be adhered to.

4. FOLLOW INSTRUCTIONS

All operating and use instructions should be followed.

5. CLEANING

Unplug this unit from the wall outlet before cleaning. Do not use liquid cleaners or aerosol cleaners.

Use a damp cloth for cleaning the exterior cabinet only.

6. ATTACHMENTS

The manufacturer of this unit does not make any recommendations for attachments, as they may cause hazards.

7. WATER AND MOISTURE

Do not use this unit near water. For example, near a bathtub, washbowl, kitchen sink, laundry tub, in a wet basement, or near a swimming pool.

8. ACCESSORIES

Do not place this unit on an unstable cart, stand, tripod, bracket, or table.

The unit may fall, causing serious injury, and serious damage to the unit.

- 8A.** An appliance and cart combination should be moved with care. Quick stops, excessive force, and uneven surfaces may cause the appliance and cart combination to overturn.

9. VENTILATION

Slots and openings in the cabinet back or bottom are provided for ventilation, to ensure reliable operation of the unit, and to protect it from overheating.

These openings must not be blocked or covered. The openings should never be blocked by placing the unit on a bed, sofa, rug, or other similar surface. This unit should never be placed near or over a radiator or heat source. This unit should not be placed in a built-in installation such as a bookcase or rack unless proper ventilation is provided and/or the manufacturer's instructions have been adhered to.

10. POWER SOURCES

This unit should be operated only from the type of power source indicated on the rating plate. If you are not sure of the type of power supply to your home, consult your appliance dealer or local power company. For units intended to operate from battery power, or other sources, refer to the operating instructions.

11. GROUNDING OR POLARIZATION

This unit is equipped with a polarized alternating-current line plug (a plug having one blade wider than the other). This plug will fit into the power outlet only one way. This is a safety feature. If you are unable to insert the plug fully into the outlet, try reversing the plug. If the plug should still fail to fit, contact your electrician to replace your obsolete outlet. Do not defeat the safety purpose of the polarized plug, if your unit is equipped with a 3-wire grounding-type plug, a plug having a third (grounding) pin. This plug will only fit into a grounding-type power outlet. This too, is a safety feature. If you are unable to insert the plug into the outlet, contact your electrician to replace your obsolete outlet. Do not defeat the safety purpose of the grounding-type plug.

12. POWER-CORD PROTECTION

Power-supply cords should be routed so that they are not likely to be walked on or pinched by items placed upon or against them, paying particular attention to cords at plugs, convenience receptacles, and the point where they exit from the appliance.

PORTABLE CART WARNING
(symbol provided by RETAC)



S3126A



IMPORTANT SAFEGUARDS (continued)

13. LIGHTNING

To protect your unit from a lightning storm, or when it is left unattended and unused for long periods of time, unplug it from the wall outlet and disconnect the antenna or cable system. This will prevent damage to the unit due to lightning and power line surges.

14. POWER LINES

An outside antenna system should not be located in the vicinity of overhead power lines or other electric light or power circuits, or where it can fall into such power lines or circuits. When installing an outside antenna system, extreme care should be taken to keep from touching such power lines or circuits, as contact with them might be fatal.

15. OVERLOADING

Do not overload wall outlets and extension cords, as this can result in a risk of fire or electric shock.

16. OBJECT AND LIQUID ENTRY

Do not push objects through any openings in this unit, as they may touch dangerous voltage points or short out parts that could result in fire or electric shock. Never spill or spray any type of liquid into the unit.

17. OUTDOOR ANTENNA GROUNDING

If an outside antenna or cable system is connected to the unit, be sure the antenna or cable system is grounded to provide some protection against voltage surges and built-up static charges, Section 810 of the National Electrical Code, ANSI/NFPA 70, provides information with respect to proper grounding of the mast and supporting structure, grounding of the lead-in wire to an antenna discharge unit, size of grounding conductors, location of antenna discharge unit, connection to grounding electrodes, and requirements for the grounding electrode.

18. SERVICING

Do not attempt to service this unit yourself as opening or removing covers may expose you to dangerous voltage or other hazards. Refer all servicing to qualified service personnel.

19. DAMAGE REQUIRING SERVICE

Unplug this unit from the wall outlet and refer servicing to qualified service personnel under the following conditions:

- a. When the power-supply cord or plug is damaged.
- b. If liquid has been spilled, or objects have fallen into the unit.
- c. If the unit has been exposed to rain or water.
- d. If the unit does not operate normally by following the operating instructions. Adjust only those controls that are covered by the operating instructions, as an improper adjustment of other controls may result in damage and will often require extensive work by a qualified technician to restore the unit to its normal operation.
- e. If the unit has been dropped or the cabinet has been damaged.
- f. When the unit exhibits a distinct change in performance, this indicates a need for service.

20. REPLACEMENT PARTS

When replacement parts are required, be sure the service technician uses replacement parts specified by the manufacturer or those that have the same characteristics as the original part.

Unauthorized substitutions may result in fire, electric shock or other hazards.

21. SAFETY CHECK

Upon completion of any service or repairs to this unit, ask the service technician to perform safety checks to determine that the unit is in proper operating condition.

22. HEAT

The product should be situated away from heat sources such as radiators, heat registers, stoves, or other products (including amplifiers) that produce heat.

23. DISC TRAY

Keep your fingers well clear of the disc tray as it is closing. It may cause serious personal injury.

24. CONNECTING

When you connect the product to other equipment, turn off the power and unplug all of the equipment from the wall outlet. Failure to do so may cause an electric shock and serious personal injury. Read the owner's manual of the other equipment carefully and follow the instructions when making any connections.

4

IMPORTANT SAFEGUARDS

(continued)

25. LASER BEAM

Do not look into the opening of the disc tray or ventilation opening of the product to see the source of the laser beam. It may cause sight damage.

26. DISC

Do not use a cracked, deformed, or repaired disc. These discs are easily broken and may cause serious personal injury and product malfunction.

27. NOTE TO CABLE TV SYSTEM INSTALLER

This reminder is provided to call the Cable TV system installer's attention to Article 820-40 of the NEC that provides guidelines for proper grounding and, in particular, specifies that the cable ground shall be connected to the grounding system of the building, as close to the point of cable entry as practical.

EXAMPLE OF ANTENNA GROUNDING AS PER THE NATIONAL ELECTRICAL CODE

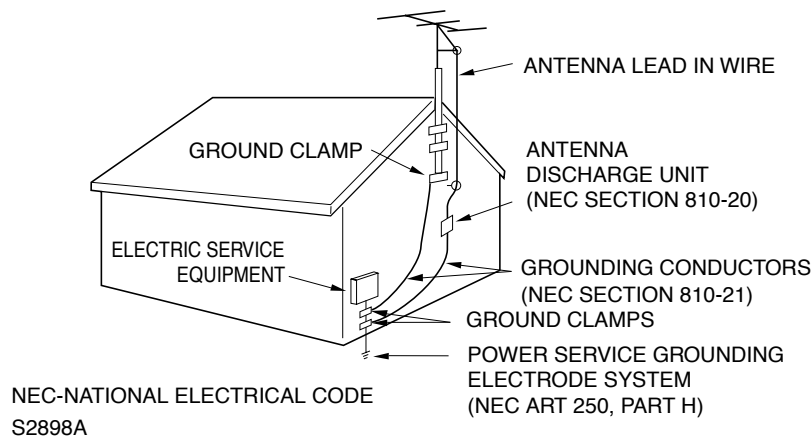

CONDENSATION

Moisture will form in the operating section of the unit if the unit is brought from cool surroundings into a warm room or if the temperature of the room rises suddenly. When this happens, the unit's performance will be impaired.

To prevent this, let the unit stand in its new surroundings for about an hour before switching it on, or make sure that the room temperature rises gradually.

Condensation may also form during the summer if the unit is exposed to the breeze from an air conditioner. In such cases, change the location of the unit.

Power source

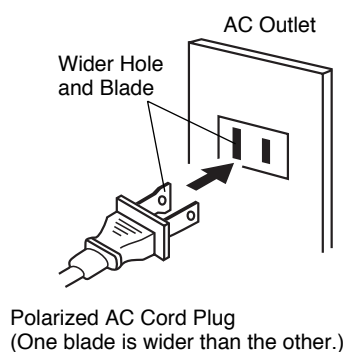

TO USE AC POWER SOURCE

Use the AC polarized line cord provided for operation on AC. Insert the AC cord plug into a standard 120V 60Hz polarized AC outlet.

NOTES:

- Never connect the AC line cord plug to other than the specified voltage (120V 60Hz). Use the attached power cord only.
- If the polarized AC cord does not fit into a non-polarized AC outlet, do not attempt to file or cut the blade. It is the user's responsibility to have an electrician replace the obsolete outlet.
- If you cause a static discharge when touching the unit and the unit fails to function, simply unplug the unit from the AC outlet and plug it back in. The unit should return to normal operation.



Features

Color TV with DVD/CD Player/Video Cassette Recorder

- **Color TV with DVD/CD player with Video Cassette Recorder** - Unique space saving design combines a color TV, a DVD/CD player and a Hi-Fi Video cassette recorder. A DVD disc has much more capacity, but is the same size as an audio CD disc. The picture quality is higher than Super VHS video cassettes. The audio quality is higher than an audio CD. The DVD PLAYER can play back audio CDs.
- **High Quality Picture** - More than 400 lines (VCR mode: 220 lines) of Horizontal Resolution.
- **On-Screen 3 Language Display** - You can select one of 3 languages, English, Spanish or French for on-screen programming.

TV Section

- **Closed Caption Decoder With Full Text Mode** - Displays text captions or full screen text on the screen for hearing impaired viewers.
- **Picture Adjustments Using The Remote Control** - The On-Screen display allows precise remote control adjustment of BRIGHTNESS, CONTRAST, COLOR, TINT and SHARPNESS.
- **Programmable TV Sleep Timer** - Operable from the remote control, the TV can be programmed for up to 120 minutes to turn off automatically.
- **V-Chip** - The V-Chip function can read the rating of a TV program or movie content if the program is encoded with this information. V-chip will allow you to set a restriction level.

VCR Section

- **Stereo/SAP Reception** - This VCR is designed to receive stereo and second audio program (SAP) broadcasts where available.
- **4 Video Heads** - Provides optimal picture quality for special effects playback.
- **19µm HEAD** - For superior picture quality even in SLP mode, 19micron width technology helps to avoid crosstalk and boost SLP picture quality to near SP levels. With precision technology, ghosts and color beats are virtually eliminated.
- **Hi-Fi Stereo Sound** - With a frequency response of 20 to 20,000 Hz and a dynamic range of better than 90dB, this VCR provides a level of excellence that rivals compact discs.
- **One-touch Timer Recording (OTR)** - Simply by pressing the REC/OTR button, the VCR can be programmed for up to 6 hours of recording with an immediate start.

DVD Section

- **Compatible with a wide range of DVD audio outputs**

Digital Audio Jack:

- When a component with a built-in Dolby Digital decoder is connected, Dolby Digital sound can produce the effect of being in a movie theater or a concert hall.
- Surround standard different from Dolby Digital. This format is already in use in many theaters. By connecting this unit to a DTS decoder or an AV amplifier with a built-in DTS decoder, the DTS audio of DVD discs recorded in this format can be enjoyed. However, audio will not be output from the analog audio output jacks.
- The MPEG audio of DVD discs recorded in this format can be enjoyed.
- The Linear PCM sound of a 48 kHz/16 bit through 96 kHz/24 bit exceeds audio CD sound.
- **Multi-Language** - Since this DVD matches with 136 language-subtitles/-soundtracks, you can enjoy selecting a favorite one. (You can not select the language that is not recorded on the disc.)
- **Multi-Angle** - Pictures of Sports or a Live Concert are recorded with many cameras. When you play such a disc, you can change the angles during playback. (If a Multi-Angle is not recorded on the disc, you can not change the angle.)
- **Repeat Playback** - You can repeat chapter, track, title, sides or material between two selected points.
- **Memory/Random Playback** - You can play back tracks, titles or chapters in programmed or random-selected sequences.
- **Zoom** - You can zoom in on the selected subject on the screen during playback.
- **Video Aspect Ratio** - You can change the aspect ratio of the screen for your monitor/television on a suitable disc.
- **Parental Control** - You can limit the play back of scenes or sounds of DVD discs that have a rating level encoded on the disc.

* This product incorporates copyright protection technology that is protected by U.S. patents and other intellectual property rights. Use of this copyright protection technology must be authorized by Macrovision, and is intended for home and other limited viewing uses only unless otherwise authorized by Macrovision. Reverse engineering or disassembly is prohibited.

* **DVD** is a trademark of DVD Format/Logo Licensing Corporation.

* Manufactured under license from Dolby Laboratories. "Dolby" and the double-D symbol are trademarks of Dolby Laboratories.

* Unauthorized recording of copyrighted television programs, films, video cassettes and other materials may infringe the rights of copyright owners and be contrary to copyright laws.





Contents

Before using your unit

IMPORTANT SAFEGUARDS	3
Power source	5
Features	6
Contents	7
Parts and functions	8
Remote control	9
Antenna connections	11
Cable TV connections	12
Connections to other equipment	13
Setting the on screen display language	15
Auto clock setting	16
Manual clock setting	18

TV operation

TV operation	19
Closed caption	21
Memorizing channels	22
Setting the V-Chip	24
Setting the on timer	27
Setting the off timer	28
Picture control adjustment	29
Adjusting the picture preference	30
Stereo recording and playback	31
Second Audio Program (SAP)	31

Tape playback operation

Loading and Unloading a cassette tape	32
Cassette tape playback	33
Special playback	34
ZERO RETURN function	35
Video index search system	35

Recording

Recording a TV program	36
One-touch Timer Recording (OTR)	38
Timer recording	39

Advanced function of VCR section

Duplicating a video tape	41
--------------------------------	----

Disc playback operation

Disc	42
Preparation	43
Status display of disc	43
Playback procedure	44
Special playback	45
MP3 playback	46
Zooming	47
Locating desired scene	47
Repeat playback	48
Program playback	49
Random playback (only CD)	49
Changing soundtrack language	50
Subtitles	50
Changing angles	51
Title selection	51
DVD menu	51

Advanced function of DVD section

Setting the aspect ratio of TV screen	52
Setting on screen display	52
Setting the picture mode	53
Screen saver function	53
Dynamic Range Control	54
Parental control setting	55
To change the parental level	56
Temporary disabling of rating level by DVD disc	57
Setting the language	58

Additional information

Language code list	59
Problems and troubleshooting	60
Video head cleaning	61
Reception disturbances	62
Specifications	63

Parts and functions

Front

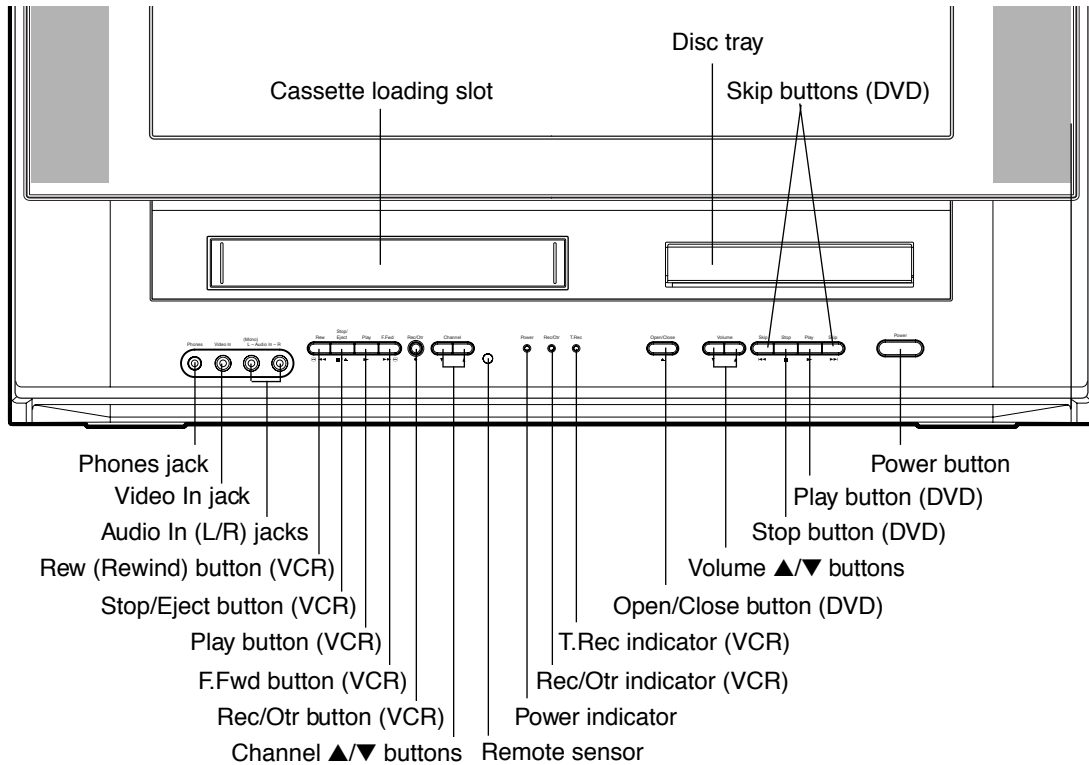

Rear

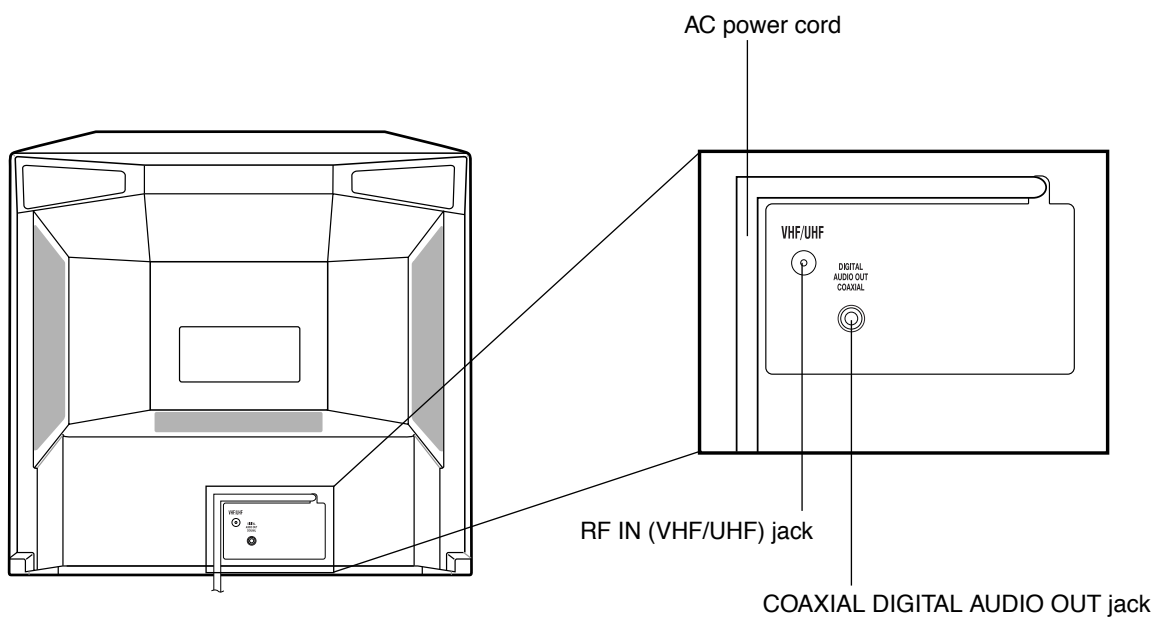



Remote control

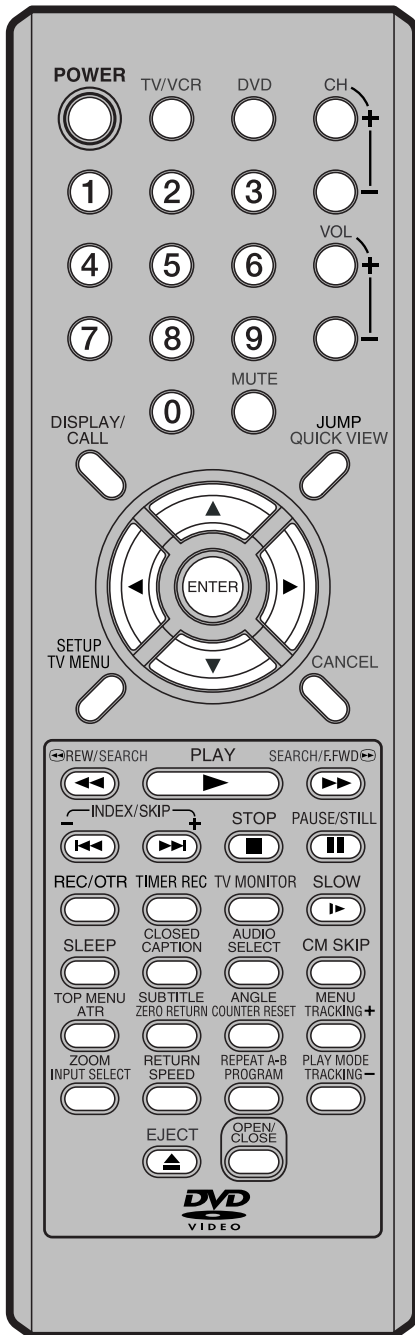

		Page
POWER	Power on/off	10,15,16,19,43,44
TV/VCR	Press to operate TV/VCR	10,15,33,35,36,38,39
DVD	Press to operate DVD	10,38,43,44,52~56
CH +/-	Select channel	10,20,36,38
0-9	Direct channel selection of TV	10,19,23,36,38
	Input setting	46,47,49
	Enter a password	24,26,55~57
VOL +/-	Adjust volume of TV	19,20
MUTE	Switch off the sound	20
DISPLAY/CALL	Display TV/VCR or DVD operation status	16,20,25,34,35,37,39,43
JUMP	Locating desired scene	47
QUICK VIEW	Switch between present/last channel	20
▲ / ▼ / ◀ / ▶	Cursor buttons	
ENTER	Enter information in the menu	
	Select option in the menu	
SETUP/TV MENU	Display the setup menu	
CANCEL	Delete Timer program	40
	Cancel input data in the setting mode	24,26,29,47,49,55,56
REW/SEARCH	Rewind/Review playback	33,34,45
PLAY	Playback	33,34,44,45,46,48,49,51,57
F.FWD/SEARCH	Fast Forward/Forward search playback	33,34,45
INDEX +/-	Search for the INDEX mark of a tape	35
SKIP +/-	Skip chapter to forward or reverse direction	45
STOP	Stop	33,35~38,44,46
PAUSE/STILL	Still picture/Recording pause on/off	34,37,41,45
REC/OTR	Recording	36,38,41
TIMER REC	Set the unit to start recording at a preset time	39,40
TV MONITOR	Temporarily view a TV channel select on the VCR while in the playback mode	34
SLOW	Slow-motion playback	34,45
SLEEP	Sleep timer	20
CLOSED CAPTION	Switch between TV/Caption/Text in Closed Caption mode	21
AUDIO SELECT	Switches sound between mono and stereo	31
	Change sound track language of DVD	50
CM SKIP	Skip the unwanted short material of a tape	34
TOP MENU	Select title of a DVD disc	51
ATR	Digital AUTO TRACKING	34
SUBTITLE	Set Subtitle of a DVD disc	50
ZERO RETURN	Stop the tape when the counter reaches 00:00:00	35
ANGLE	Change playback angle of a DVD disc	51
COUNTER RESET	Reset the counter to 00:00:00	35
MENU	Select menu of a DVD disc	51
TRACKING +	Manual tracking button in playback mode	34
ZOOM	Zoom (for DVD playback)	47
INPUT SELECT	Switch the connected TV to external mode	14,41
RETURN	Remove DVD set up menu	52~55,57,58
SPEED	Sets the tape speed for recording	36,38,41
REPEAT A-B	Repeat playback between A and B (DVD/CD)	48
PROGRAM	Confirm the timer program	28,40
PLAY MODE	Select playback mode	48,49
TRACKING -	Manual tracking button in playback mode	34
EJECT	Eject a cassette tape	32,39
OPEN/CLOSE	Open or Close the DVD tray	44,46,57

Remote control

(continued)

Inserting Batteries

- 1 Open the battery compartment cover in the direction of the arrow.
- 2 Install two "AAA" batteries (not supplied), paying attention to the polarity diagram in the battery compartment.
- 3 Replace the compartment cover.

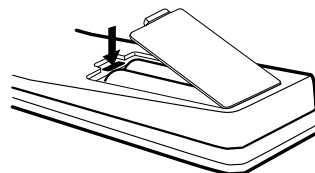
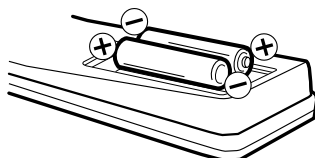
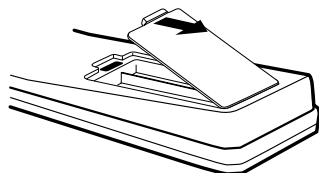

Battery precautions

The precautions below should be followed when using batteries in this device:

1. Use only the size and type of batteries specified.
2. Be sure to follow the correct polarity when installing the batteries as indicated in the battery compartment.
Reversed batteries may cause damage to the device. To avoid a potential short circuit, insert the "-" end first.
3. Do not mix different types of batteries together (e.g. Alkaline and Carbon-zinc) or old batteries with fresh ones.
4. If the device is not to be used for a long period of time, remove the batteries to prevent damage or injury from possible battery leakage.
5. Do not try to recharge batteries not intended to be recharged; they can overheat and rupture. (Follow battery manufacturer's directions.)

Remote control basics

- Press **POWER** to turn the unit on or off.
- Select your desired operating mode (TV/VCR or DVD) using **TV/VCR** or **DVD**.
- Press **CH +/-** to move through the channels one channel at a time.
- The **Cursor buttons** (**▲/▼/◀/▶**) are also used to navigate on-screen menu system.
- You can directly access specific channels using **Direct Channel Selection** buttons.

Operation

- Aim the remote control at the remote sensor and press control buttons to operate.
- Operate the remote control within a 30° angle on either side of the remote sensor, up to a distance of approximately 15 feet.

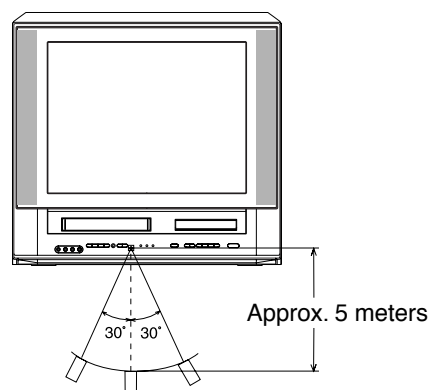

Antenna connections

If you are using an indoor or outdoor antenna, follow the instructions below that correspond to your antenna system. If you are using a Cable TV service (CABLE), see page 12 for Cable TV connections.

Combination VHF/UHF antenna (Single 75 ohm cable or 300 ohm twin-lead wire)

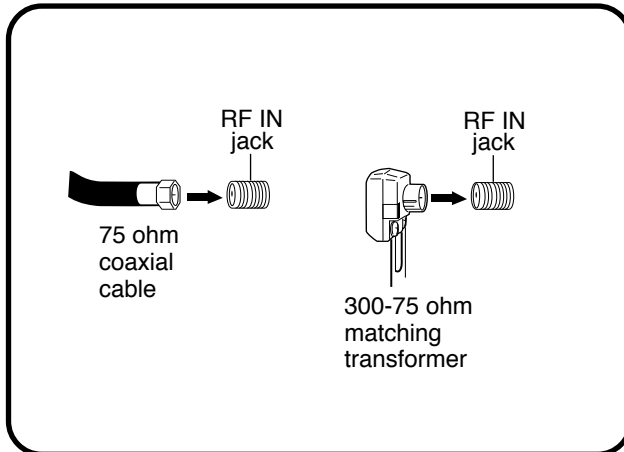

Connect the 75 ohm cable from the combination VHF/UHF antenna to the RF IN jack.

If your combination VHF/UHF antenna has a 300 ohm twin-lead wire, the use of the 300-75 ohm matching transformer may be necessary.

Combination VHF/UHF antenna (Separate VHF and UHF 300 ohm twin-lead wires)

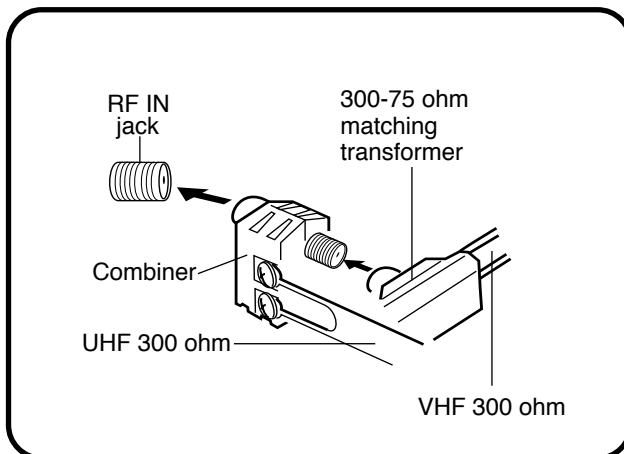

Connect the UHF 300 ohm twin-lead wire to the combiner (not supplied). Connect the VHF 300 ohm twin-lead wire to the 300-75 ohm matching transformer. Attach the transformer to the combiner, then attach the combiner to the RF IN jack.

Separate VHF/UHF antennas (75 ohm VHF cable and 300 ohm UHF twin-lead wires)

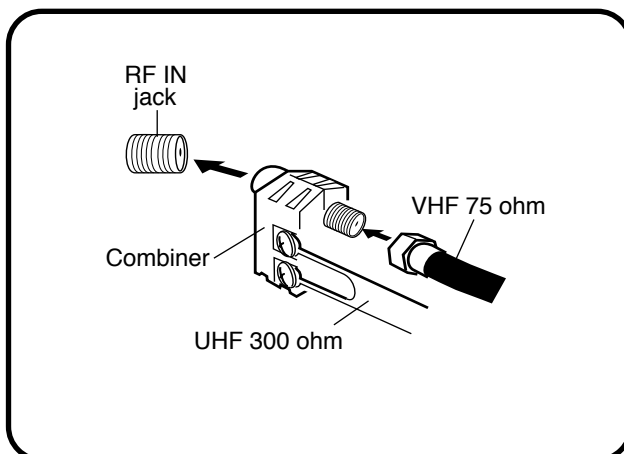

Connect the VHF 75 ohm cable and UHF 300 ohm twin-lead wire to the combiner. Attach the combiner to the RF IN jack.



Cable TV connections

This unit has an extended tuning range and can tune most Cable TV channels without using a Cable TV Converter box. Some Cable TV companies offer “premium pay channels” in which the signal is scrambled. Descrambling these signals for normal viewing requires the use of a descrambler device which is generally provided by the Cable TV company.

For subscribers to basic to basic Cable TV service

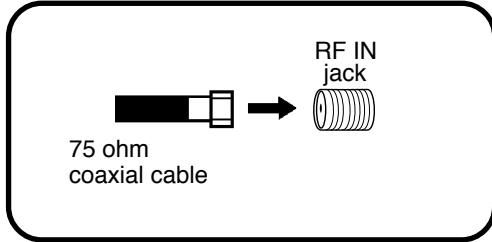

For basic Cable TV service not requiring a Converter/Descrambler box, connect the 75 ohm coaxial cable directly to the RF IN jack on the back of the unit.

For subscribers to scrambled Cable TV service

If you subscribe to a Cable TV service which requires the use of a Converter/Descrambler box, connect the incoming 75 ohm coaxial cable to the Converter/Descrambler box. Using another 75 ohm coaxial cable, connect the output jack of the Converter/Descrambler box to the RF IN jack on the unit. Follow the connections shown below. Set the unit to the output channel of the Converter/Descrambler box (usually channel 3 or 4) and use the Converter/Descrambler box to select channels.

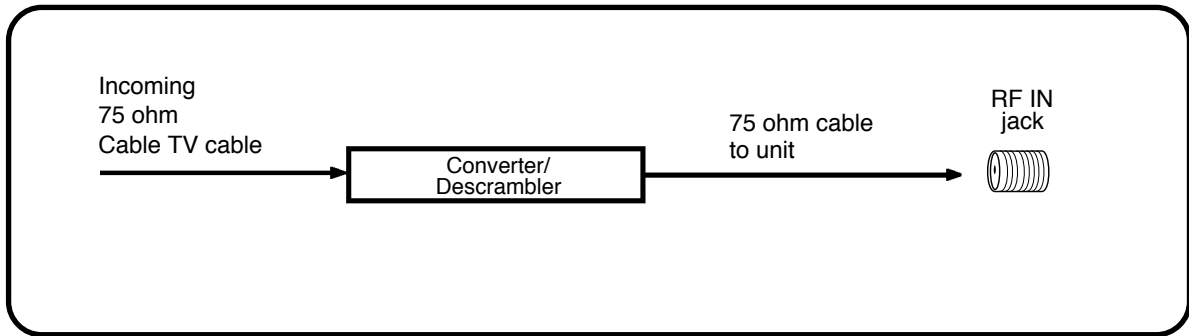

For subscribers to unscrambled basic Cable TV service with scrambled premium channels

If you subscribe to a Cable TV service in which basic channels are unscrambled and premium channels require the use of a Converter/Descrambler box, you may wish to use a signal splitter and an A/B switch box (available from the Cable TV company or an electronics supply store). Follow the connections shown below. With the switch in the “B” position, you can directly tune any unscrambled channels on your unit. With the switch in the “A” position, tune your unit to the output of the Converter/Descrambler box (usually channel 3 or 4) and use the Converter/Descrambler box to tune scrambled channels.

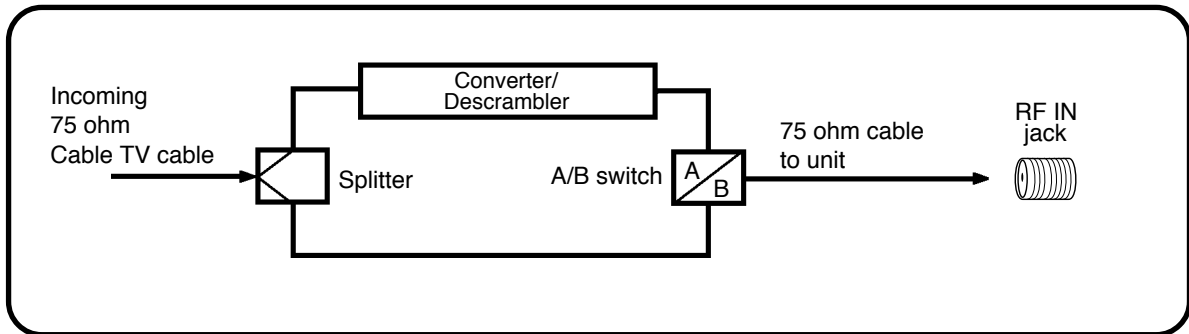

Connections to other equipment

The exact arrangement you use to interconnect various video and audio components to the unit is dependent on the model and features of each component. Check the Owner's Manual provided with each component for the location of video and audio inputs and outputs.

Using an AV Amplifier with built-in digital surround

If you are using an Amplifier with a built-in digital surround sound as follows, you can enjoy the various audio systems including Dolby Digital Surround audio that sounds just like the movie.

Connect an AV amplifier with built-in Dolby Digital decoder, DTS decoder, MPEG decoder or etc as shown below.

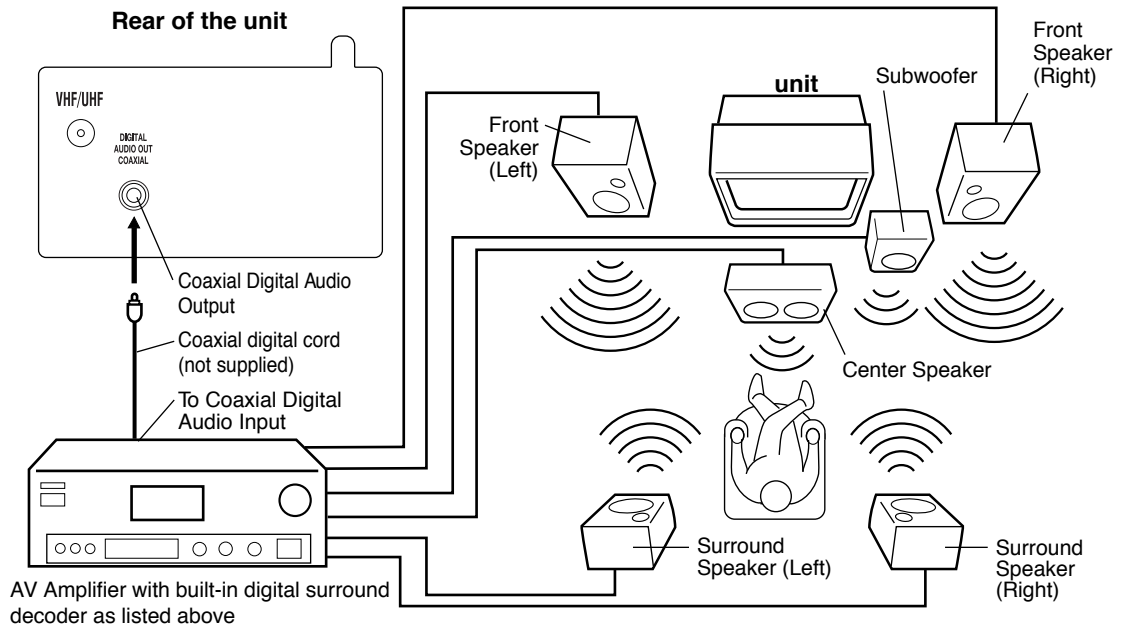

* Manufactured under license from Dolby Laboratories. "Dolby" and the double-D symbol are trademarks of Dolby Laboratories.

* "DTS" and "DTS Digital Out" are trademarks of Digital Theater Systems, Inc.

NOTES:

- When you make the connection above, on the AV Amplifier, do not set DOLBY DIGITAL to DOLBY DIGITAL "ON". If you do, a loud noise will emit from the speakers possibly causing damage to your hearing or to the speakers.
- Some DTS decoders which do not support DVD-DTS interface may not work properly with the unit.



Connections to other equipment

(continued)

Using the audio/video inputs

If you connect the unit to camcorder or TV game, you can select by pressing **INPUT SELECT**.

Press **INPUT SELECT** repeatedly to select the desired mode. "LINE" or TV channel will display on the screen for 4 seconds.

TV Channel ↔ LINE (Front)

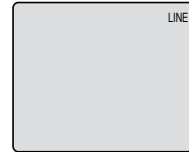

NOTE:

In the DVD mode this key will not operate.

1. To connect the unit to a camcorder

To playback from a camcorder, connect the camcorder to the unit as shown.

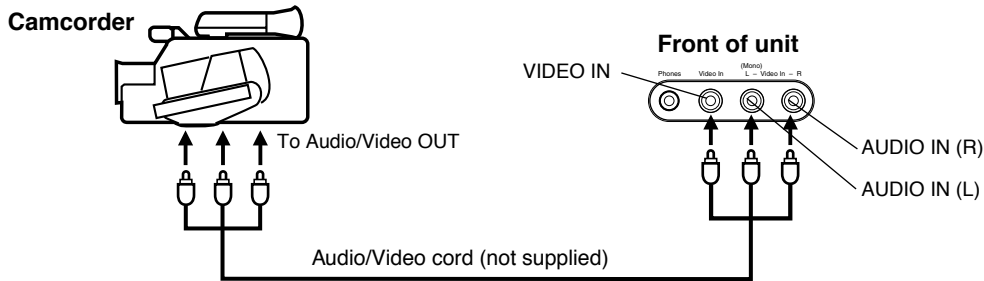

2. To connect the unit to a Game

The unit can also be used as a display device for many video games. However, due to the wide variety signals generated by these devices and subsequent hook-up variations required, they have not all been included in the suggested connection diagrams. You'll need to consult each component's Owner's Manual for additional information.

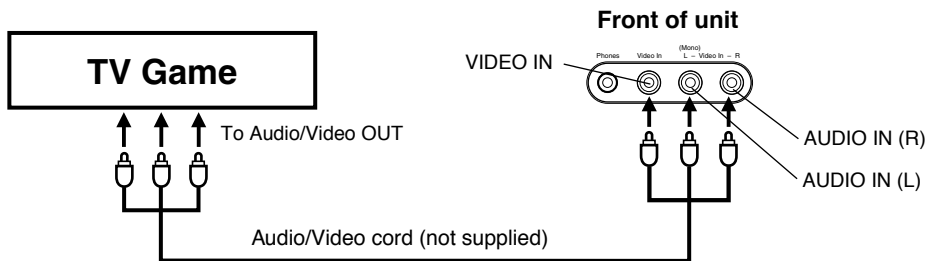

Setting the on screen display language

You can choose from three different languages (English, Spanish and French) for the on-screen displays.

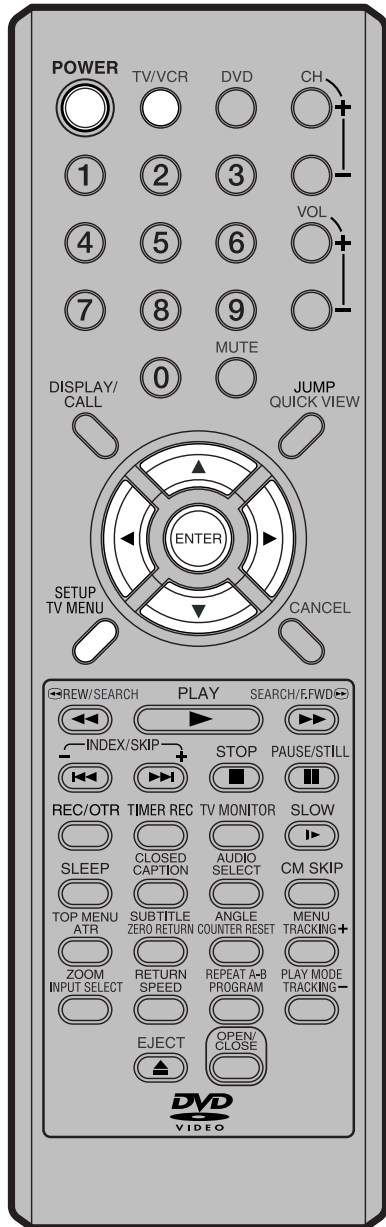

- 1 Press **POWER** to turn on the unit.
- 2 Press **TV/VCR** to select the TV/VCR mode.
- 3 Press **SETUP/TV MENU**. Press ◀ or ▶ to select option.

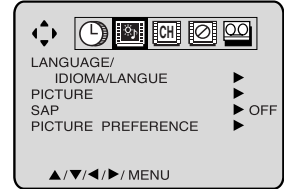

- 4 Press ▲ or ▼ to select "LANGUAGE", then press ▶.

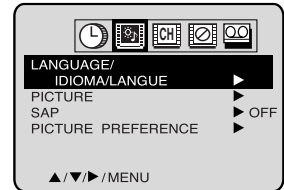

- 5 Press ▲ or ▼ to select the desired language: English (ENGLISH), Spanish (ESPAÑOL) or French (FRANCAIS), then press **ENTER**.



- 6 Press **SETUP/TV MENU** until the menu screen is cleared.

NOTE:

If no buttons are pressed for more than 60 seconds, the MENU screen will return to normal TV-operation automatically.



Auto clock setting

The Auto clock function will automatically set the built-in clock (Month, Day, Year and Time) when the unit is connected to an Antenna or Cable TV system and it is turned off. As the unit searches for a receivable station in your area and it receives a broadcast signal for Auto clock, the Auto clock needs several minutes to set itself.

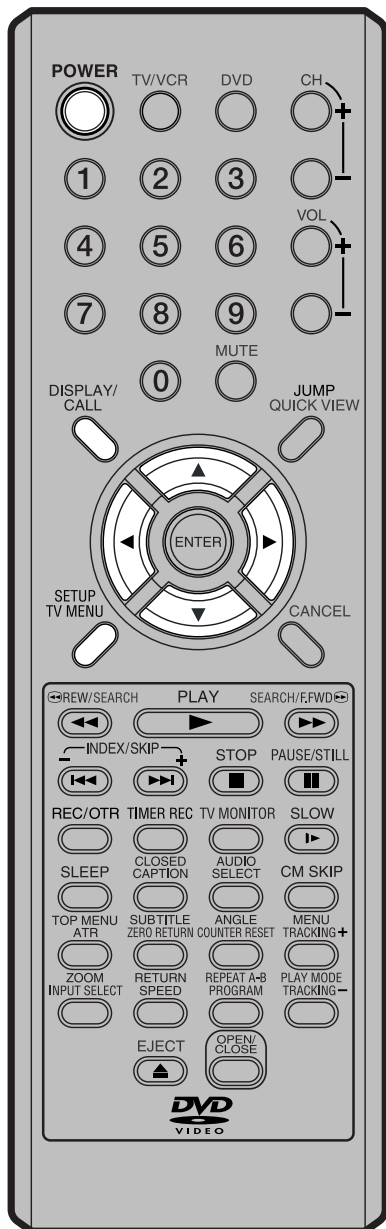

Auto clock setting

- 1 Connect the Antenna or Cable system.
 - If you use a cable box, turn it on.
- 2 Plug the AC Power cord to the AC outlet.
- 3 Make sure the unit is turned off.
 - If you press **POWER**, Auto clock set is not effective.
- 4 Wait at least three minutes and press **POWER**.
 - Depending on the reception condition, it may take approx. 30 minutes.
- 5 Press **DISPLAY/CALL** to check the clock on the screen.
- 6 If the clock is not set, make sure you are receiving TV channels. The Auto clock may not function properly if the reception condition is not good.

Auto clock adjustment

The Auto clock adjustment will be performed at 12:00 PM everyday if you turn off the unit.

- If you use a cable box and you want Auto clock adjustment to be performed, the cable box must be left on.
- The Auto clock adjustment won't work if there is more than 5 minutes between the built-in clock time and the actual time.

To set Auto clock to off

When shipped from factory "AUTO CLOCK" is set to "ON". But if you do not want Auto clock set (Adjustment):

- 1 Turn on the unit.
- 2 Press **SETUP/TV MENU** in the TV/VCR mode. The TV/VCR menu screen will appear.
- 3 Press **◀** or **▶** to select  option.
- 4 Press **▲** or **▼** to select "AUTO CLOCK".
- 5 Press **◀** or **▶** to select "OFF".
- 6 Press **SETUP/TV MENU** repeatedly to return to the normal screen.

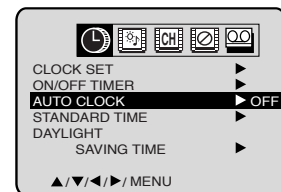
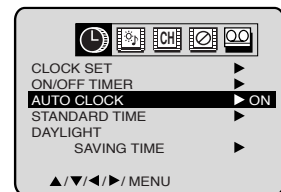
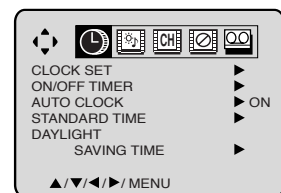

- When "AUTO CLOCK" is set to "OFF", the Auto clock adjustment does not function.
- Set the clock manually (see page 18).

Auto clock setting

(continued)

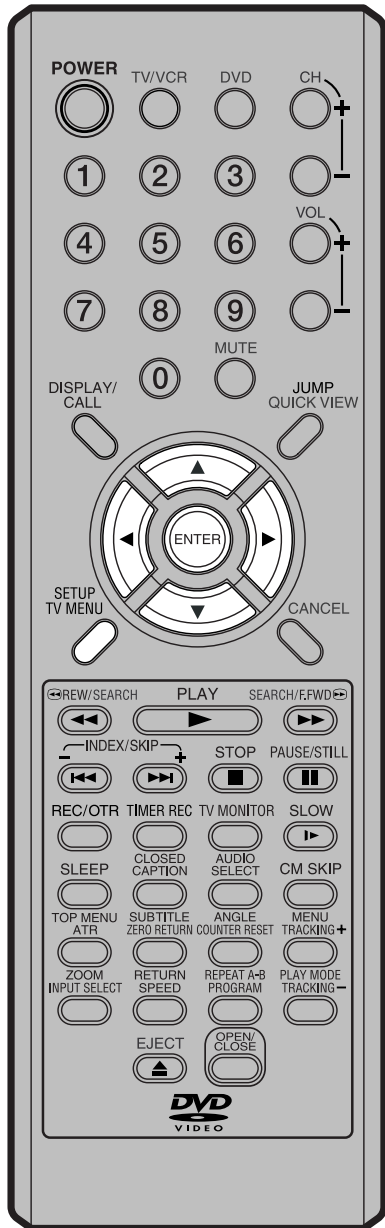

To set standard time

In the rare event that you live within broadcast range of two stations in two different time zones, the unit may recognize the wrong station for the Auto clock set.

To correct the situation:

- 1 Press **SETUP/TV MENU** in the TV/VCR mode. The TV/VCR menu screen will appear.
- 2 Press ◀ or ▶ to select ⌚ option.
- 3 Press ▲ or ▼ to select "STANDARD TIME", then press ▶.
- 4 Press ▲ or ▼ to select your time zone, then press **ENTER**.

ATLANTIC : GMT – 4 hours
(GMT: Greenwich Mean Time)
EASTERN : GMT – 5 hours
CENTRAL : GMT – 6 hours
MOUNTAIN : GMT – 7 hours
PACIFIC : GMT – 8 hours
ALASKA : GMT – 9 hours
HAWAII : GMT – 10 hours
AUTO : AUTO SET

- 5 Press **SETUP/TV MENU** repeatedly to return to the normal screen.

NOTE: To be able to select the standard time, the clock must first be set by "AUTO CLOCK" once.

Daylight saving time setting

You can set the Daylight Saving Time automatically or manually.

- 1 Press **SETUP/TV MENU**. Press ◀ or ▶ to select ⌚ option.

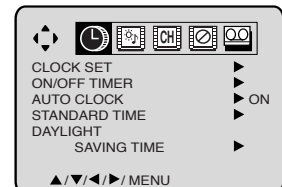

- 2 Press ▲ or ▼ to select "DAYLIGHT SAVING TIME", then press ▶.

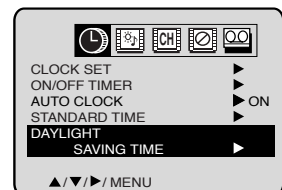

- 3 Press ▲ or ▼ to select one of the options, then press **ENTER**. Press **SETUP/TV MENU** until the menu screen disappears.



ON: for manual setting (forward one hour)
OFF: for manual setting (back one hour)
AUTO: for automatic setting

NOTES:

- When shipped from factory, "DAYLIGHT SAVING TIME" is set to "AUTO".
- When you want to set the Daylight Saving Time manually, on the first Sunday in April you set to "ON", and on the last Sunday in October you set to "OFF".
- When the clock is not set, Daylight Saving Time setting is not available.
- When there is no Daylight Saving Time in your area, always select "OFF" in step 3.

Manual clock setting

You must set the date and time manually for Timer Recordings, ON/OFF Timer and Daylight Saving Time if the Auto clock process did not set them correctly.

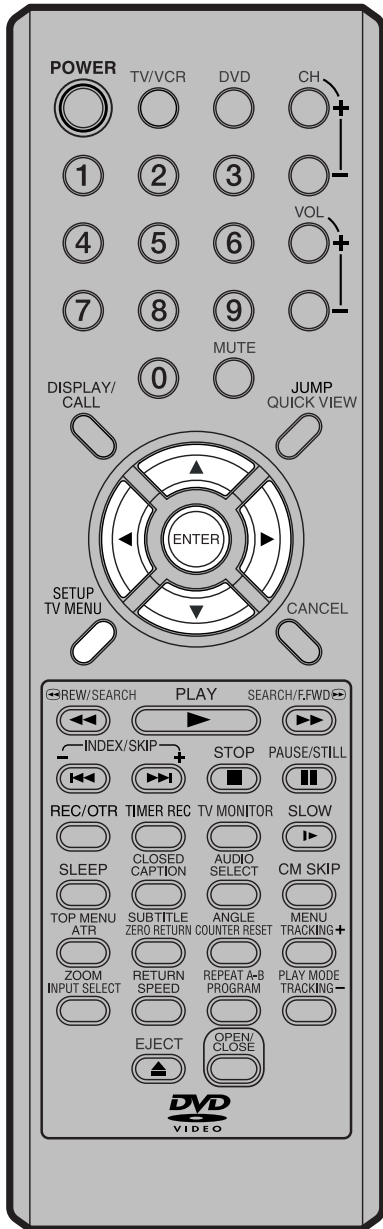

EXAMPLE: Setting the clock to "8:30 AM" March, 25 (SAT), 2006.

1 Press **SETUP/TV MENU** in the TV/VCR mode. The TV/VCR menu screen will appear.

2 Press **◀** or **▶** to select the  option.

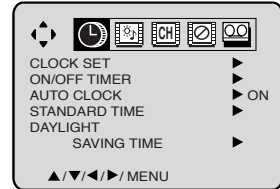

3 Press **▲** or **▼** to select the "CLOCK SET" option, then press **▶**.

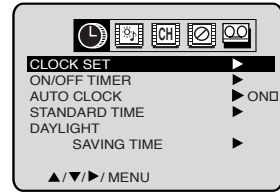

4 Press **◀** or **▶** to set the month, then press **▼**.

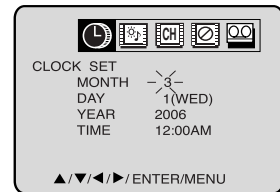

To make corrections any time during the process
Press **▲** repeatedly until the item you want to change blinks, then press **◀** or **▶**.

5 Set the day, year and time as in step 4, then press **ENTER**.

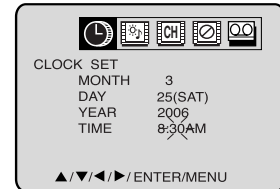

6 After setting the clock, date and time starts functioning automatically.

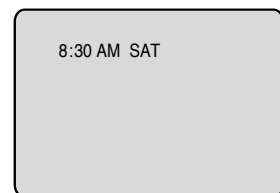

NOTE:
After a power failure or disconnection of the power, the timer settings will be lost. In this case, reset the present time.



TV operation

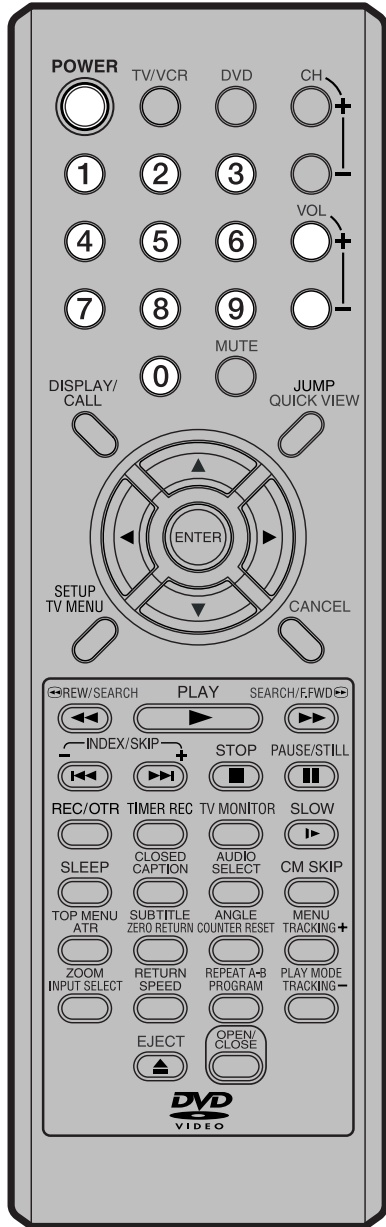

1 To turn on the unit, press **POWER**.

2 Adjust the volume level by pressing **VOL +** or **-**. The volume level will be indicated on the screen by green bars. As the volume level increases, so do the number of bars. If the volume decreases, the number of green bars also decreases.

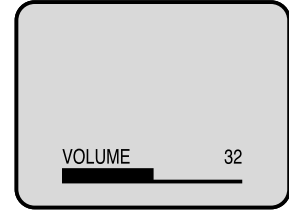

3 Set the TV/CABLE menu option to the appropriate position. (See page 22.)

TV - VHF/UHF channels
CABLE - Cable TV channels

4 Press the **Direct Channel Selection** buttons to select the channel.

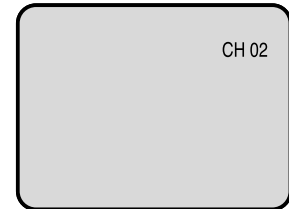

TV Mode Direct Channel Selection

When the TV/CABLE menu option is in the TV position, all channels can be instantly selected by using two buttons. (for example, to select channel 2, press **0**, then **2**. If you press only **2**, channel selection will be delayed for a few seconds.) For channels 10 and above, press the 2 digits in order.

CABLE Mode Direct Channel Selection

When the TV/CABLE menu option is in the CABLE position, channels can be selected as follows:

TO SELECT CABLE CHANNELS:

- 1-9: Press **0** twice, then 1-9 as needed. Example, to select channel 2, press **002**.
- 10-12: Press **0**, then the remaining 2 digits. Example, to select channel 12, press **012**.
- 13-99: Press the 2 digits in order. Example, to select channel 36, press **36**.
- 100-125: Press the 3 digits in order. Example, to select channel 120, press **120**.

Note for channels 1-12:

If only 1 or 2 buttons are pressed, the corresponding channel will be selected in 2 seconds.

VHF/UHF/Cable TV channels

TV	Cable TV
VHF 2-13	VHF 2-13
UHF 14-69	STD/HRC/IRC 14-36 (A) (W) 37-59 (AA) (WW) 60-85 (AAA) (ZZZ) 86-94 (86) (94) 95-99 (A-5) (A-1) 100-125 (100) (125) 01 (5A)

NOTES:

- If a channel with no broadcast is selected, the sound will automatically be muted.
- If a station being viewed stops broadcasting, the unit will automatically shut itself off after 15 minutes.



TV operation

(continued)

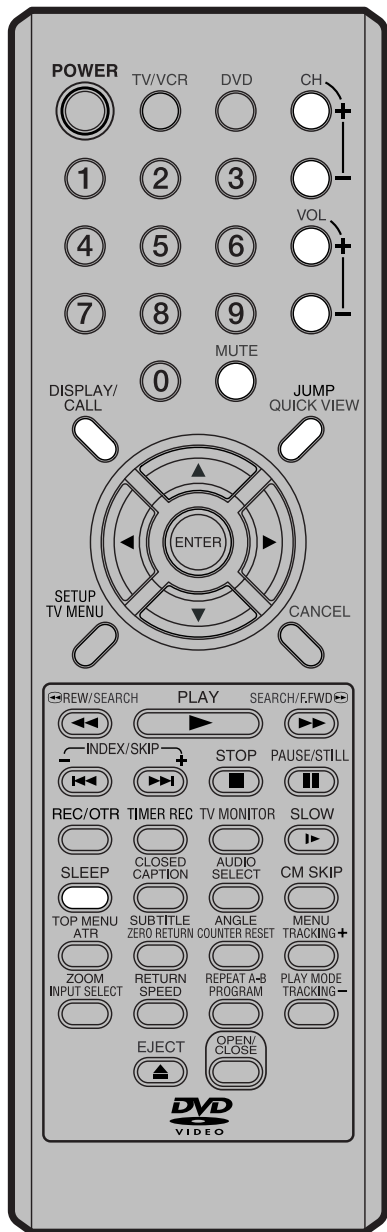

NOTE:

To listen through the headphones, insert the plug to your headphones (not supplied) equipped with a 1/8 inch mini plug into the PHONES jack on the front of the unit. The sound from the unit speaker is muted.

CHANNEL +/-

Press and release **CH +** or **-**. The channel automatically stops at the next channel set into memory. For proper operation, before selecting channels, they should be set into the memory. See pages 22 and 23 "Memorizing channels".

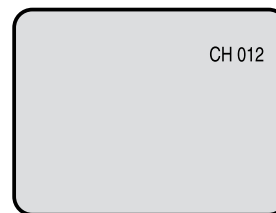

CALL

Press **DISPLAY/CALL** to display the current information on the screen. Press **DISPLAY/CALL** again to clear the call display.

- Channel number or VIDEO mode
- Stereo or SAP (second audio program) audio status
- Audio output status

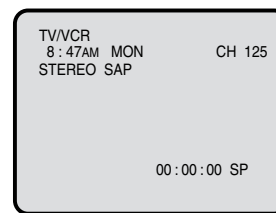

QUICK VIEW

This button allows you to go back to the last channel selected by pressing **QUICK VIEW**. Press **QUICK VIEW** again to return to the last channel you were watching.

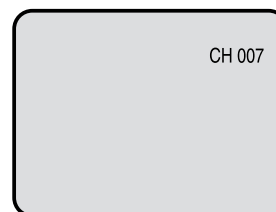

MUTE

Press **MUTE** to switch off the sound. The unit's sound will be silenced and "MUTE" will briefly appear on the screen. The sound can be switched back on by pressing this button again or one of the **VOL +** or **-** buttons.

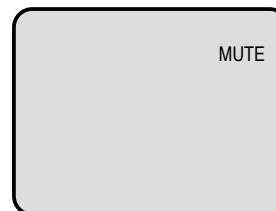

SLEEP

To set the unit to turn off after a preset amount of time, press **SLEEP** on the remote control. The clock will count down 10 minutes for each press of the **SLEEP** button (120, 110, ...10, 0). After the sleep time is programmed, the display will appear briefly every ten minutes to remind you that the sleep timer is operating.

To confirm the sleep timer setting, press **SLEEP** and the remaining time will be displayed for a few seconds. To cancel the sleep timer, press **SLEEP** repeatedly until the display turns to 0.

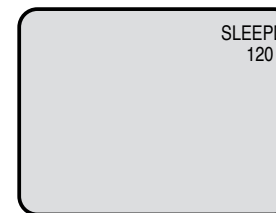



Closed caption

What is closed captioning?

This television has the capability to decode and display Closed Captioned television programs. Closed Captioning will display text on the screen for hearing impaired viewers or it will translate and display text in another language.

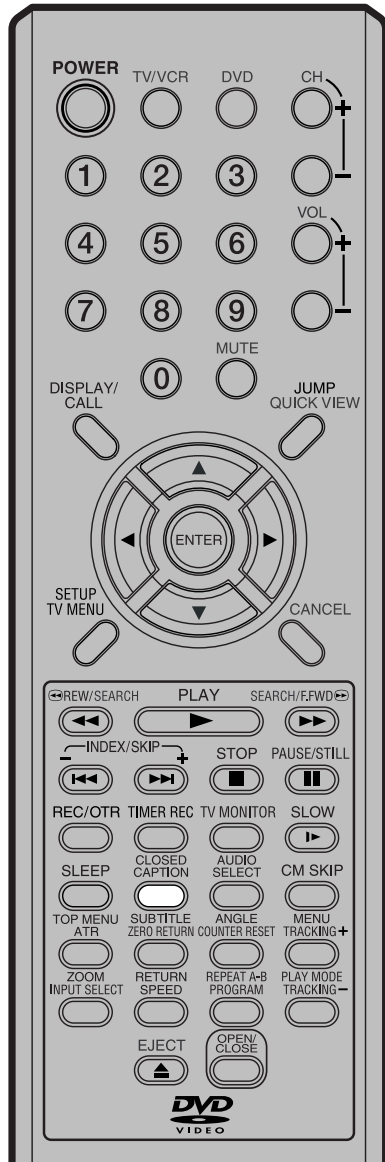

Captions: This closed caption mode will display text on the screen in English or another language (depending on the setting of the closed captions CH 1/2).

Generally, closed captions in English are transmitted on captions channel 1 and closed captions in other languages are transmitted on captions channel 2.

The captions will appear in places on the screen where they will least interfere with the picture, usually on the bottom of the screen. News programs will usually show three-line closed captions which scroll onto the screen.

Most other shows provide two or three lined captions placed near the character who is speaking so the viewer can follow the dialogue. Words in italics or underlined describe titles, words in foreign languages or words requiring emphasis. Words that are sung usually appear enclosed by musical notes.

Text: The text closed caption mode will usually fill the screen with a programming schedule or other information.

After selecting a closed caption mode, it will stay in effect until it is changed, even if the channel is changed.

If the captions signal is lost due to a commercial or a break in the signal, the captions will reappear when the signal is received again. If the channels are changed, the captions will be delayed approximately 10 seconds.

For television programs broadcasting with closed captions, look in your TV guide for the closed captions symbol (CC).

To view closed captions

Press **CLOSED CAPTION** to switch between normal TV and the two closed caption modes (captions and full screen text). Closed captioning will display text on the screen for hearing impaired viewers.

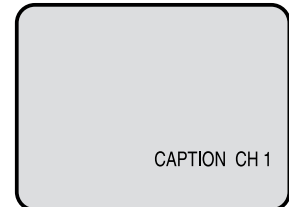

NOTES:

- When selecting Closed Captions, the captioning will be delayed approximately 10 seconds.
- If no caption signal is received, no captions will appear, but the television will remain in the Caption Mode.
- Misspellings or unusual characters may occasionally appear during Closed Captioning. This is normal with Closed Captioning, especially with live programs. This is because during live programs, captions are also entered live. These transmissions do not allow time for editing.
- When Captions are being displayed, on-screen displays, such as volume and mute may not be seen or may interfere with Closed Captions.
- Some cable systems and copy protection systems may interfere with the Closed Captioned signal.
- If using an indoor antenna or if TV reception is very poor, the Closed Caption Decoder may not appear or may appear with strange characters or misspelled words. In this case, adjust the antenna for better reception or use an outdoor antenna.



Memorizing channels

This unit is equipped with a channel memory feature which allows channels to skip up or down to the next channel set into memory, skipping over unwanted channels. Before selecting channels, they must be programmed into the unit's memory. In addition to normal VHF and UHF channels, this unit can receive up to 113 Cable TV channels. To use this unit with an antenna, set the TV/CABLE menu option to the TV mode. When shipped from the factory, this menu option is in the CABLE mode.

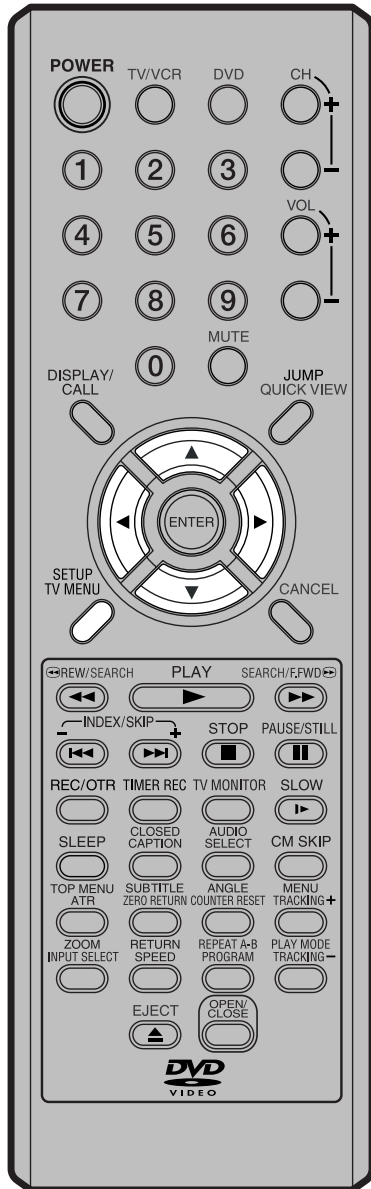

TV/CABLE selection

1 Press **SETUP/TV MENU** in the TV/VCR mode. The TV/VCR menu screen will appear.

2 Press **◀** or **▶** to select **CH** option.

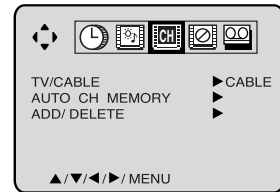

3 Press **▲** or **▼** to select "TV/CABLE".

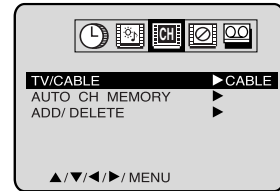

4 Press **◀** or **▶** to select "TV" or "CABLE".

TV - VHF/UHF channels
CABLE - Cable TV channels

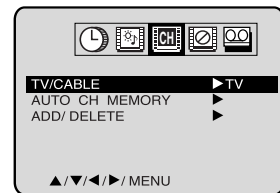

5 Press **SETUP/TV MENU** until the menu screen is cleared.

Cable TV chart

The chart below is typical of many Cable TV system channel allocations.

Number on this TV	14	15	16	17	18	19	20	21	22
Corresponding Cable TV channel	A	B	C	D	E	F	G	H	I
23	24	25	26	27	28	29	30	31	32
J	K	L	M	N	O	P	Q	R	S
33	34	35	36	37	38	39	40	41	42
T	U	V	W	AA	BB	CC	DD	EE	FF
43	44	45	46	47	48	49	50	51	52
GG	HH	II	JJ	KK	LL	MM	NN	OO	PP
53	54	55	56	57	58	59	60	61	62
QQ	RR	SS	TT	UU	VV	WW	XX	YY	ZZ
63	64	65	66	67	68	69	70	71	72
AAA	BBB	CCC	DDD	EEE	FFF	GGG	HHH	III	JJJ
73	74	75	76	77	78	79	80	81	82
KKK	LLL	MMM	NNN	OOO	PPP	QQQ	RRR	SSS	TTT
83	84	85	86	87	88	89	90	91	92
88	89	90	91	92	93	94	95	96	97
98	99	100	101	102	103	104	105	106	107
108	109	110	111	112	113	114	115	116	117
118	119	120	121	122	123	124	125	01	5A

Memorizing channels

(continued)

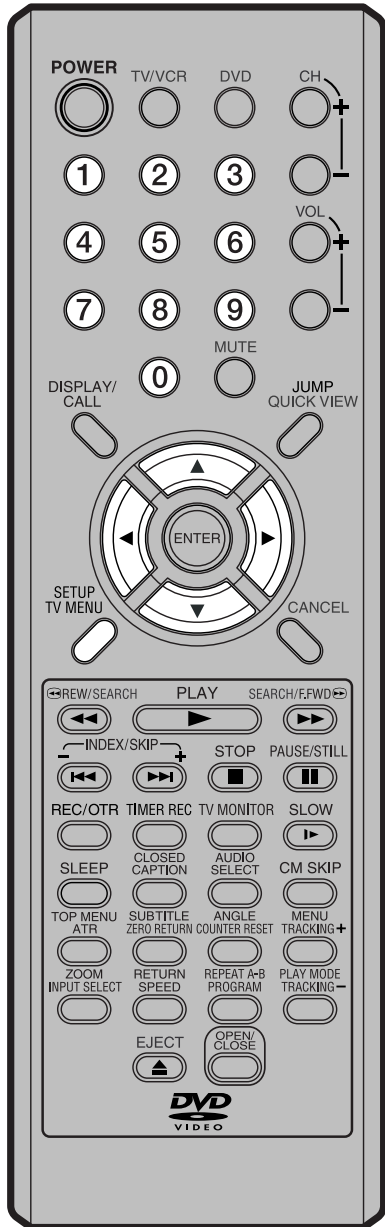

Automatic memory tuning

- 1 Press **SETUP/TV MENU** in the TV/VCR mode. The TV/VCR menu screen will appear.
- 2 Press **◀** or **▶** to select **CH** option.
- 3 Press **▲** or **▼** to select "AUTO CH MEMORY".
- 4 Press **▶**. The TV will begin memorizing all the channels available in your area.
- 5 Press **SETUP/TV MENU** until the menu screen is cleared.

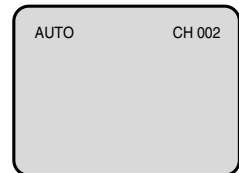
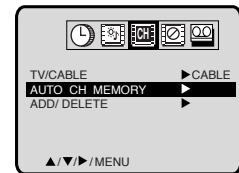
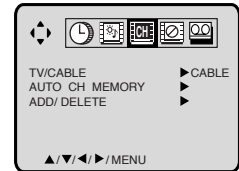

To ADD/DELETE channels

- 1 Press **SETUP/TV MENU** in the TV/VCR mode. The TV/VCR menu screen will appear.
- 2 Press **◀** or **▶** to select **CH** option.
- 3 Press **▲** or **▼** to select "ADD/DELETE", then press **▶**.
- 4 Select the desired channel to be memorized or deleted using **Direct Channel Selection (0-9)**, or **▲/▼**.
- 5 Press **◀** or **▶** to select "ADD" or "DELETE", whichever function you want to perform.
- 6 Press **SETUP/TV MENU** until the menu screen is cleared.

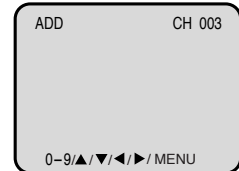
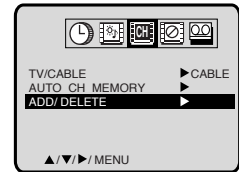
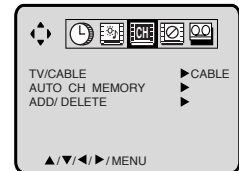

Setting the V-Chip

An age limitation can be set to restrict children from viewing or hearing violent scene or pictures that you may choose to exclude. The restriction applies to "TV RATING" and "MOVIE RATING" if this data is transmitted. You may set this restriction separately. To use the V-Chip function, you must register a password.

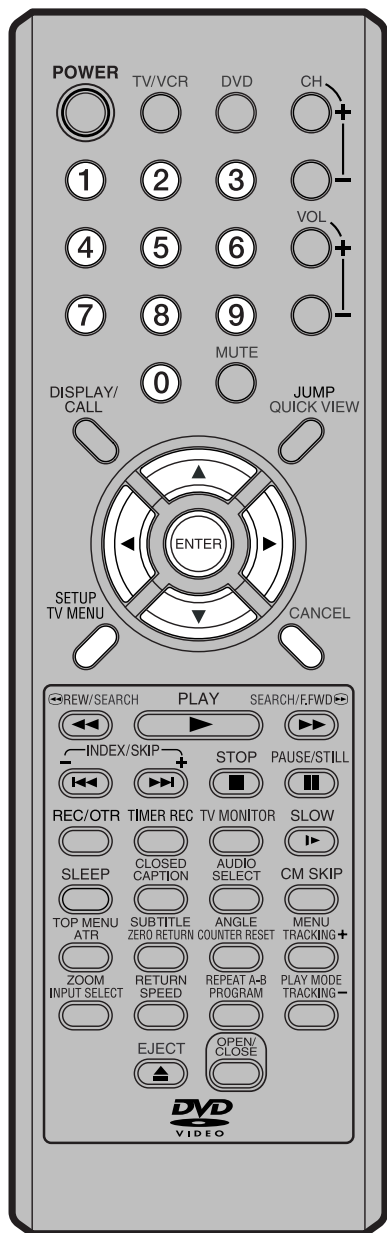

To register a password

1 Press **SETUP/TV MENU** in the TV/VCR mode. The TV/VCR menu screen will appear.

2 Press **◀** or **▶** to select  option, then press **▲** or **▼** to select "PASSWORD".

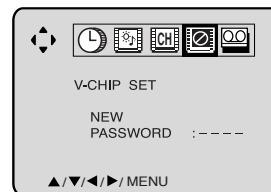

3 Select and enter a password (4 digits) using **Number buttons (0-9)**, then press **ENTER**.

- If you put a wrong number, press **CANCEL**.

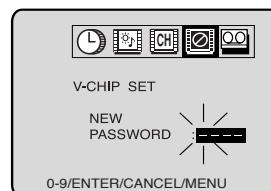

"*" appears instead of the number.

4 Enter the same password again to confirm, then press **ENTER**. The password is now registered and the V-Chip menu will appear on the screen.

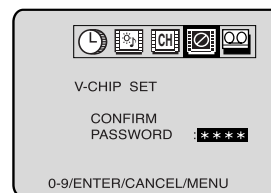

NOTES:

- If you forget the password, you cannot set the V-Chip.
- To avoid forgetting the password, write it down and keep in the safe place.

Setting the V-Chip

(continued)

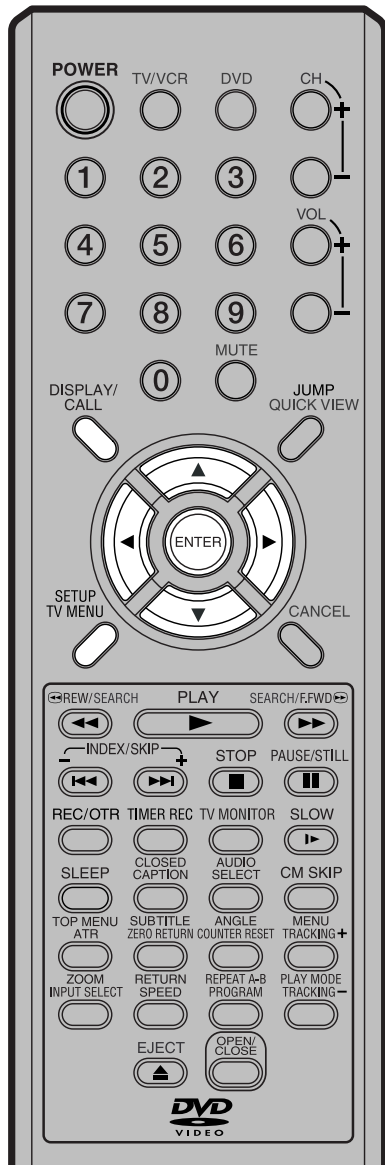

To set the V-Chip

1 In the V-CHIP SET menu, press ▲ or ▼ to select "V-CHIP SET", then press ►.

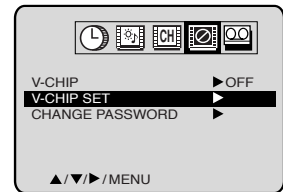

2 Press ▲ or ▼ to select "TV RATING", then press ◀ or ▶ to display the desired setting.

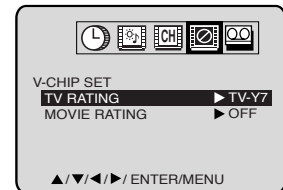

- OFF** : TV RATING is not set
- TV-Y** : All children
- TV-Y7** : 7 years old and above
- TV-G** : General audience
- TV-PG** : Parental guidance
- TV-14** : 14 years old and above
- TV-MA** : 17 years old and above

When you select TV- Y7, TV-PG, TV-14 or TV-MA, press **DISPLAY/CALL** to show the contained rating. Press ▲ or ▼ to select the desired item you want. Press ◀ or ▶ to select the setting "ON" or "OFF".

3 Press ▲ or ▼ to select "MOVIE RATING".

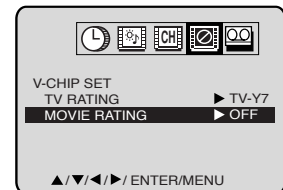

4 Press ◀ or ▶ to select desired rating, then press **ENTER**.

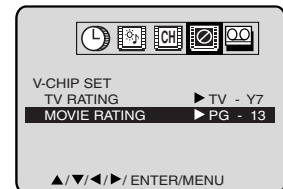

- OFF** : MOVIE RATING is not set
- G** : All ages
- PG** : Parental guidance
- PG-13** : Parental guidance less than 13 years old
- R** : Under 17 years old Parental guidance suggested
- NC-17** : 17 years old and above
- X** : Adult only

5 Press ▲ or ▼ to select "V-CHIP".

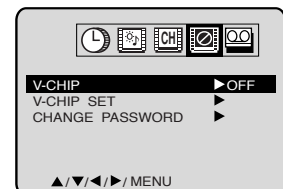

6 Press ◀ or ▶ to display "ON". Your settings are now set into the memory.

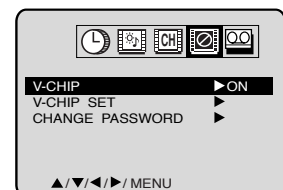

7 Press **SETUP/TV MENU** until the menu screen is cleared.

To use the TV after the TV is protected.

When a program is received that is blocked by the V-Chip, enter the password, then press **ENTER**. When the password is entered correctly the protection will be temporarily overridden. If the TV is turned off, or the channel is changed the V-Chip restriction will be reactivated.

NOTE:

The V-Chip function is activated only on programs and tapes that have the rating signal.

Setting the V-Chip

(continued)

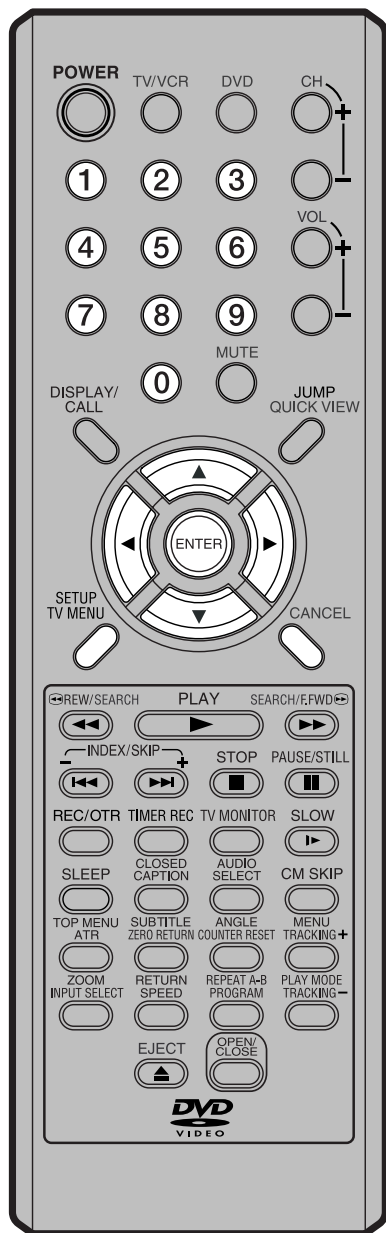

To change password

- 1 Press **SETUP/TV MENU** in the TV/VCR mode. The TV/VCR menu screen will appear.
- 2 Press **◀** or **▶** to select  option.
- 3 Press **▲** or **▼** to select the "PASSWORD".
- 4 Enter the Password using the **Number buttons (0-9)**, then press **ENTER**.
 - If you put a wrong number, press **CANCEL**.
- 5 Press **▲** or **▼** to select "CHANGE PASSWORD", then press **▶**.
- 6 Enter a new password using the **Number buttons (0-9)**, then press **ENTER**.
- 7 Enter the same password again to confirm, then press **ENTER**.
- 8 Press **SETUP/TV MENU** repeatedly to return to normal screen.

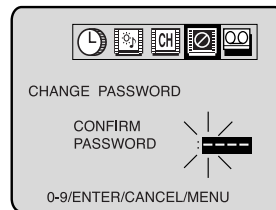
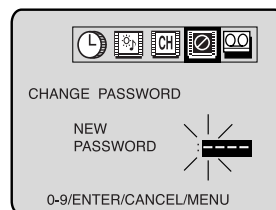
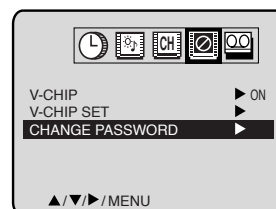
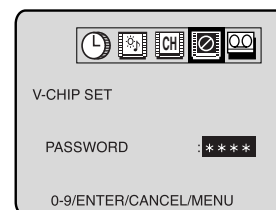
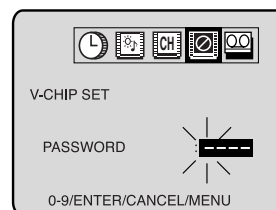
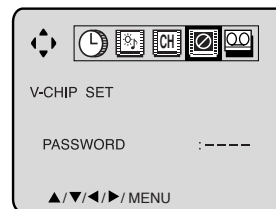





Setting the on timer

This feature allows you to program the unit to turn on at a predetermined time. If you program the ONTIMER to "DAILY" the TV will turn on everyday at the same time to the same channel.

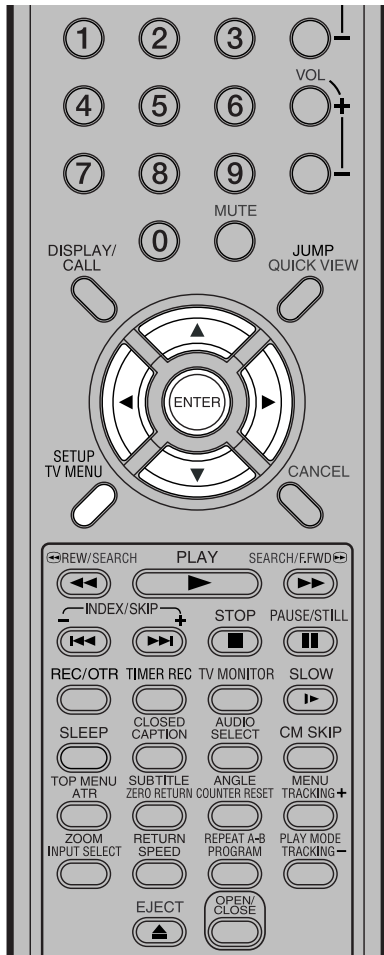
EXAMPLE: Turning on the TV to channel 12 at 7:00 AM, MON-DAY-FRIDAY.



1 Press **SETUP/TV MENU** in the TV/VCR mode. The TV/VCR menu screen will appear.

2 Press **◀** or **▶** to select  option.

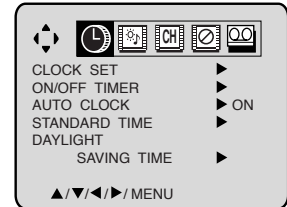

3 Press **▲** or **▼** to select "ON/OFF TIMER", then press **▶**.

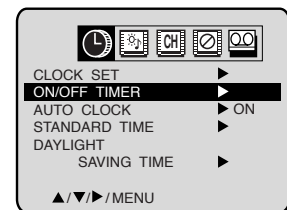

4 Press **▲** or **▼** to select "ON TIMER", then press **▶**.

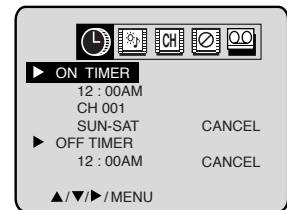

5 Press **◀** or **▶** to set the desired hour, then press **▼**.

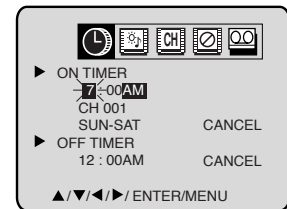

6 Set the desired minute, channel and daily or weekly timer date as in step 5.

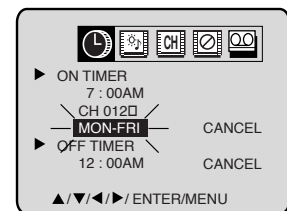

7 Press **◀** or **▶** to select "SET", then press **ENTER**. Press **SETUP/TV MENU** repeatedly to return to normal screen.

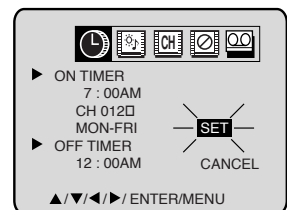

NOTES:

- The unit will automatically turn off approximately 1 hour later after the ON TIMER turns on if no OFF TIMER has been set. To continue watching the TV, press any button to cancel the one hour automatic shut off.
- To cancel the ON TIMER, follow above steps 1-6, then press **◀** or **▶** to select "CANCEL". Press **SETUP/TV MENU** repeatedly to return to the normal screen.
- After setting the ON TIMER, the arrow moves to OFF TIMER position. If you wish to set the OFF TIMER, press **▶** then follow the steps 5-7 on page 28 "Setting the off timer".

Setting the off timer

This feature allows you to program the unit to turn off at a predetermined time. If you program the OFF TIMER to "DAILY" the TV will turn off at the same time everyday.

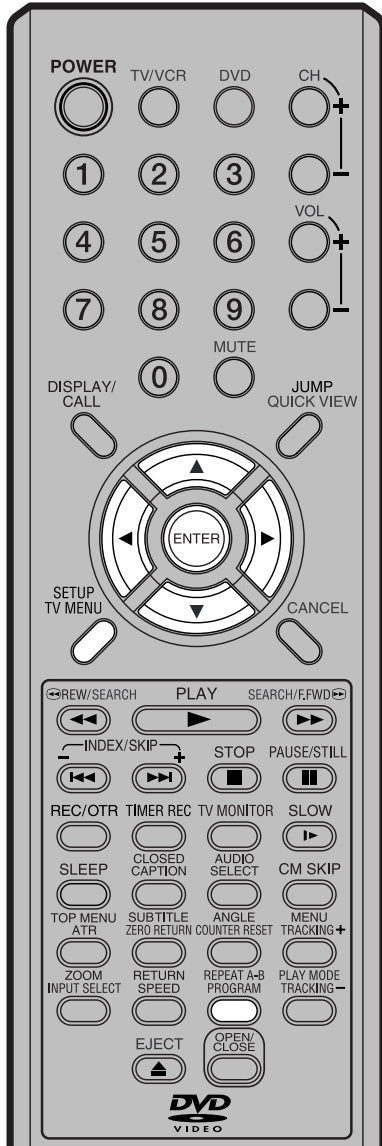

NOTES:

- If a station being viewed stops broadcasting, the unit will automatically shut itself off after 15 minutes.
- To cancel the OFF TIMER, follow above steps 1-6, then press ◀ or ▶ to select "CANCEL". Press **SETUP/TV MENU** to return to the normal screen.
- **To confirm the ON/OFF TIMER:** Press **PROGRAM** twice to indicate the program on the screen.

EXAMPLE: Turning off the TV at 11:30 PM.

1 Press **SETUP/TV MENU** in the TV/VCR mode. The TV/VCR menu screen will appear.

2 Press ◀ or ▶ to select option.

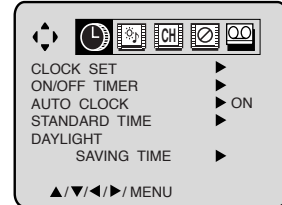

3 Press ▲ or ▼ to select "ON/OFF TIMER", then press ▶.

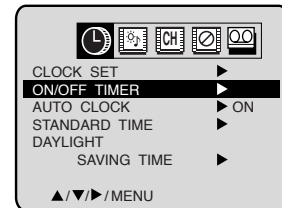

4 Press ▲ or ▼ to select "OFF TIMER", then press ▶.

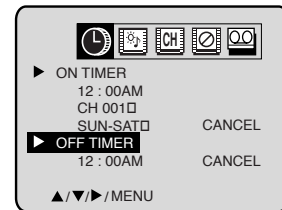

5 Press ◀ or ▶ to set the desired hour, then press ▼.

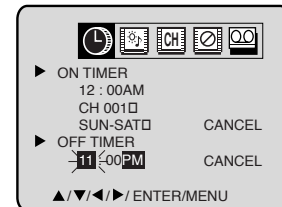

6 Press ◀ or ▶ to set the desired minute, then press ▼.

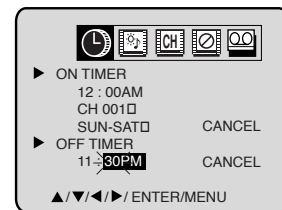

7 Press ◀ or ▶ to select "SET", then press **ENTER**. Press **SETUP/TV MENU** repeatedly to return to the normal screen.

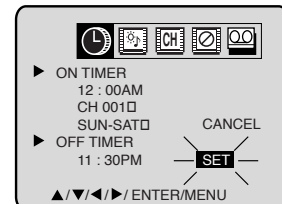



Picture control adjustment

Picture controls are factory preset but you can adjust them individually as follows:

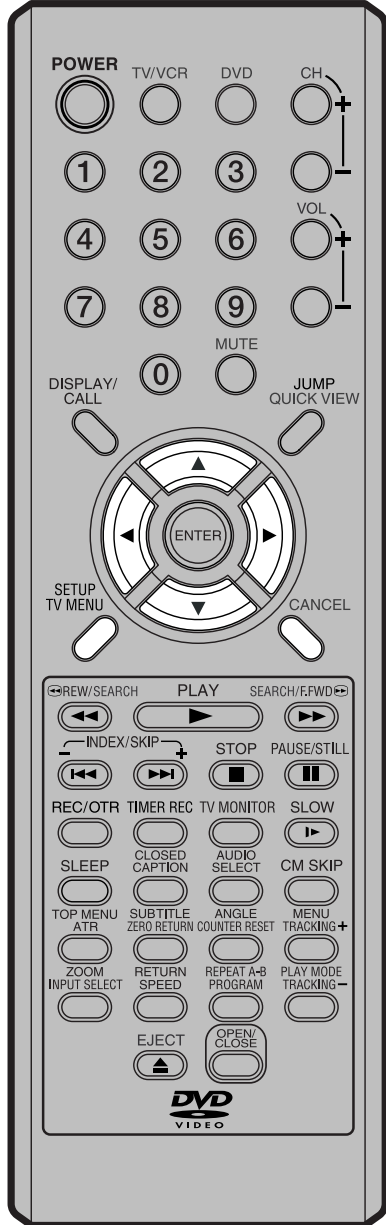

1 Press **SETUP/TV MENU** in the TV/VCR mode. The TV/VCR menu screen will appear.

2 Press **◀** or **▶** to select  option.

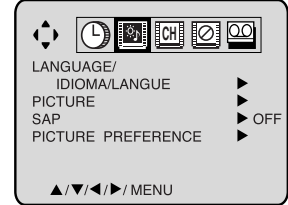

3 Press **▲** or **▼** to select "PICTURE", then press **▶**.

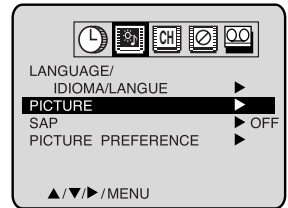

4 Press **▲** or **▼** to select the item you want to adjust. Press **◀** or **▶** to adjust the setting.

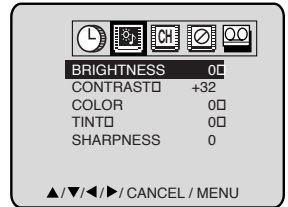

	◀	▶
BRIGHTNESS	decrease brightness	increase brightness
CONTRAST	decrease contrast	increase contrast
COLOR	be pale color	be brilliant color
TINT	be reddish color	be greenish color
SHARPNESS	makes picture softer	makes picture clearer

5 After your desired setting press **SETUP/TV MENU** until the menu screen is cleared.

CANCEL

Pressing **CANCEL** while making picture adjustments will return all adjustments to the factory preset levels.

NOTES:

- The **CONTRAST** default setting is set to maximum at the factory.
- The On-screen display will disappear 60 seconds after finishing an adjustment or by pressing **SETUP/TV MENU** three times.

The setting can only be adjusted when they are displayed on the TV screen.



Adjusting the picture preference

You can select four picture modes—**STANDARD**, **SPORTS**, **MOVIE**, and **MEMORY**—as described in the following table:

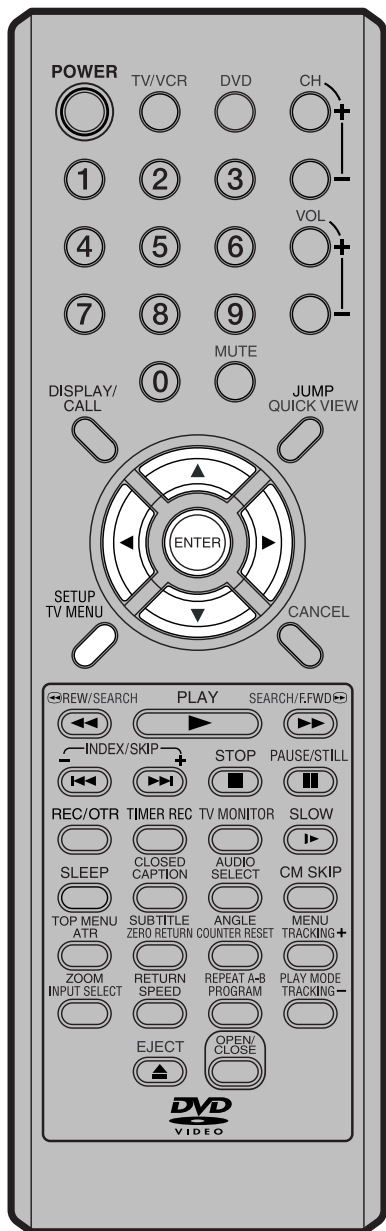

1 Press **SETUP/TV MENU** in the TV/VCR mode. The TV/VCR menu screen will appear.

2 Press **◀** or **▶** to select  option.

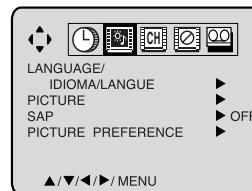

3 Press **▲** or **▼** to select “**PICTURE PREFERENCE**”, then press **▶**.

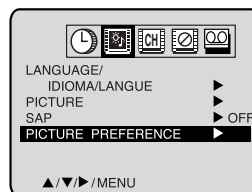

4 Press **▲** or **▼** to select the item you want to adjust. Press **ENTER** to adjust the setting.

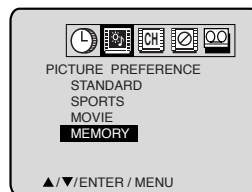

Mode	Picture Quality
STANDARD	Standard picture quality (factory-set)
SPORTS	Bright and dynamic picture (factory-set)
MOVIE	Movie-like picture setting (factory-set)
MEMORY	Your personal preferences (set by you; see “Picture control adjustment” on the page 29).

5 After your desired setting, press **SETUP/TV MENU** until the menu screen disappears.

Stereo recording and playback / Second Audio Program (SAP)

Stereo recording and playback

The VHS Hi-Fi audio system permits high fidelity recording of MTS STEREO TV broadcasts.

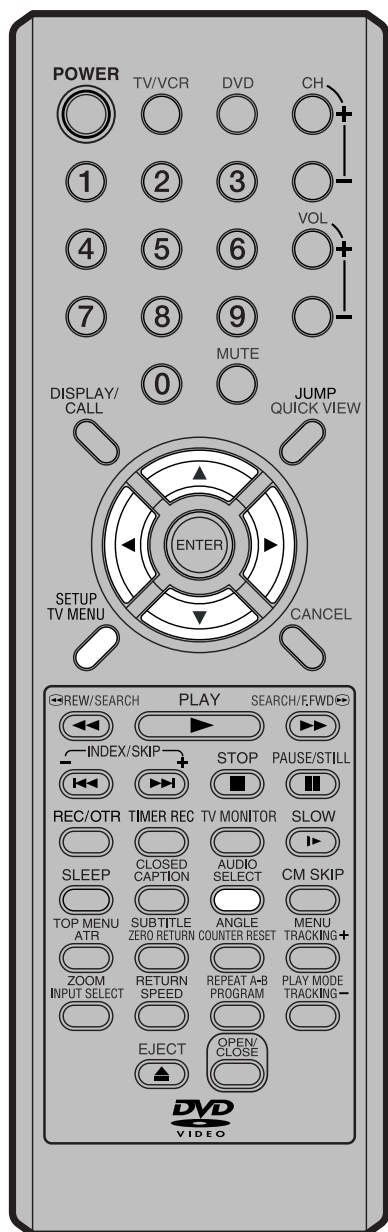

When an MTS STEREO broadcast is received, the word STEREO will appear on the screen and the program can be viewed or recorded in stereo. The Hi-Fi STEREO recording procedure is the same as for normal recordings.

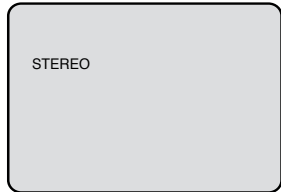

NOTE:

When using a Cable TV system, stereo TV programs may be transmitted over a mono cable channel. In this case the word "STEREO" will not appear and the sound will be in mono.

Output selection

When viewing an MTS STEREO TV program, or playing a pre-recorded VHS Hi-Fi STEREO video tape, press **AUDIO SELECT** to select how the audio will be heard through the speakers. Normally set to the Hi-Fi STEREO position, this button can be set to the MONO position if the stereo broadcast or videotape audio is of poor quality. The "R" and "L" positions allow the audio from the Right or Left Hi-Fi channel to be heard over both TV speakers. This button has no effect when viewing a MONO video tape or TV program. Each time when you press the button, **OUTPUT SELECTION** display appears on the screen for several seconds. Refer to the chart below.

OUTPUT SELECTION	SOUND HEARD ON BOTH SPEAKERS
STEREO	STEREO
L ch	LEFT CHANNEL AUDIO
R ch	RIGHT CHANNEL AUDIO
MONO	MONO

Second Audio Program (SAP)

Your unit is fitted with a SAP broadcast system which enables you to switch to a second audio program when viewing a selected channel.

This function applies only when the program is broadcast in multi-languages through the SAP broadcast system.

1 Press **SETUP/TV MENU** in the TV/VCR mode. Then press ◀ or ▶ to select option.

2 Press ▲ or ▼ to select "SAP". Then press ▶ to select "ON".

Then press **SETUP/TV MENU** until the menu screen is cleared.

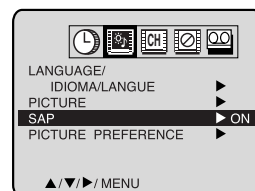

NOTES:

- When playing back a tape that is not recorded in Hi-Fi stereo mode, the audio will automatically be monaural.
- When listening to a VHS Hi-Fi video tape or MTS broadcast through the VHF/UHF jack (Audio/Video cord not connected), the sound will be monaural.

Listening to SAP

When the unit is turned on or a channel selection is made, make certain the letters "SAP" appear on the screen. This means that the "Second Audio Program" broadcasting is available.

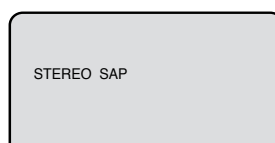

OR

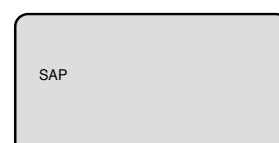



Loading and Unloading a cassette tape

Use only video cassette tapes marked **VHS**.

Loading

Push the center of the tape until it is automatically inserted.

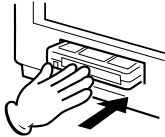

Insert the cassette tape with its labeled side facing up and the erase prevention tab positioned at your left. An inverted cassette tape cannot be inserted.

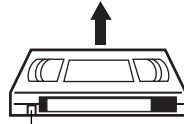

Erase prevention tab

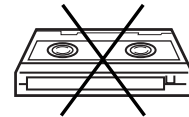

Automatic power ON

When you insert a cassette tape the unit power will turn ON automatically.

Automatic playback

When loading a cassette tape without an erase prevention tab, playback will start automatically.

Unloading

1 Press **EJECT** on the unit or the Remote.



2 Remove the cassette tape.

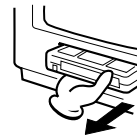

Automatic tape eject

This unit will automatically rewind the tape when the tape has ended. When the tape is rewound to its beginning, the cassette tape will be ejected automatically.

To prevent accidental erasure

Remove the erase prevention tab with a screwdriver.

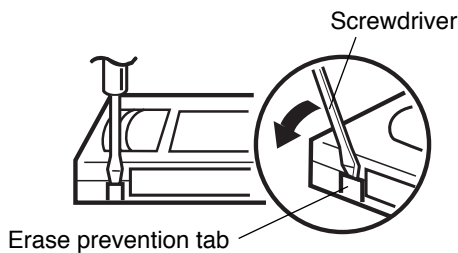

To record again

Cover the hole with a piece of adhesive tape.

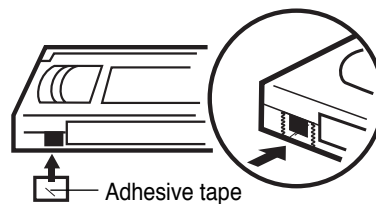

Tape speed and maximum recording time

Tape Speed	Video cassette tape				
	T-160	T-120	T-90	T-60	T-30
SP (Standard Play)	2-2/3 hours	2 hours	1-1/2 hours	1 hour	30 minutes
SLP (Super Long Play)	8 hours	6 hours	4-1/2 hours	3 hours	1-1/2 hours





Cassette tape playback

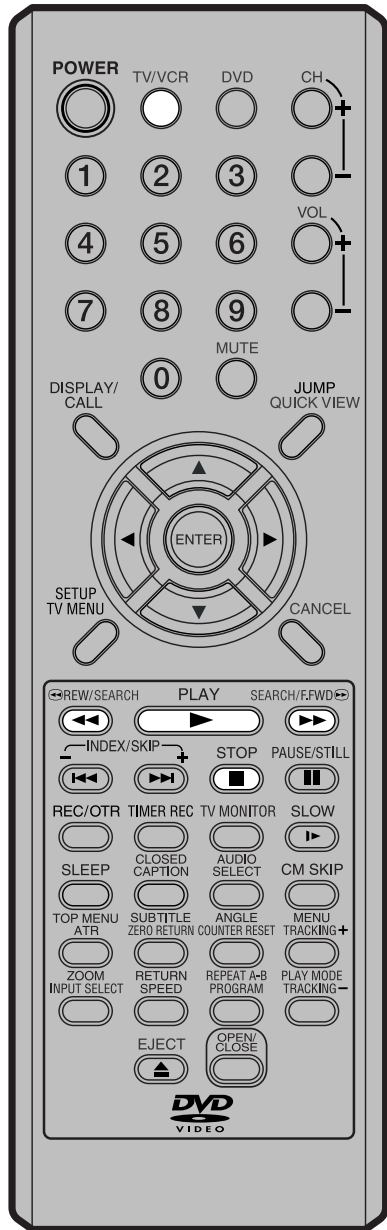

Preparation:

Press **TV/VCR** to select the TV/VCR mode.

- 1 Load a prerecorded tape (When loading a cassette tape without the erase prevention tab, playback will start automatically).

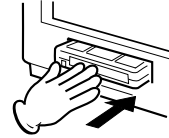

- 2 To start playback

Press **PLAY**. Playback will start. "▶" will appear on the screen for about 4 seconds.



To stop playback

Press **STOP** once. The tape will stop but remain fully loaded and ready to play. "■" will appear on the screen for about 4 seconds.



To rewind the tape or forward it rapidly

Stop the playback or recording with **STOP**.

To rewind the tape:
Press **REW**.



To forward the tape:
Press **F.FWD**.



To stop the tape-winding, press **STOP**. To switch to playback directly (without **STOP**), press **PLAY**.

Forward/Reverse picture search mode

When the tape is being winded, you can switch to picture search mode (see next page). To do this, press **REW** or **F.FWD** and hold it down. The unit will resume the tape winding as soon as the button is released.

NOTES:

- This unit selects the playback tape speed SP, LP or SLP automatically.
- If you play a prerecorded tape after the DVD playback, you must set the unit to TV/VCR mode using **TV/VCR**.
- When you select the TV/VCR mode during DVD playback, DVD playback will change to the still mode, and after 5 minutes it will change to the stop mode automatically.



Special playback

Picture Search

Reverse picture search function

Press **REW** x 1 or x 2 during the playback.

Forward picture search function

Press **FWD** x 1 or x 2 during the playback.

To return to playback: Press **PLAY**.

SPEED SEARCH TIMES

TAPE SPEED	PICTURE SEARCH SPEED	
	PRESS ONCE	PRESS TWICE
SP (Standard Play)	3 X	5 X
LP (Long Play)	7 X	9 X
SLP (Super Long Play)	9 X	15 X

Still Picture

Press **PAUSE/STILL** during playback. To resume normal playback: Press **PLAY**.

Slow Motion

During playback press **SLOW**.

To return to playback: Press **PLAY** or **SLOW**.

Slow tracking and vertical lock adjustment

If noise bars appear in the picture during slow motion, press the **TRACKING +** or **-** to reduce the noise bars. If the still picture jitters excessively, press **TRACKING +** or **-** to stabilize the still picture.

Frame by Frame Picture

Press **PAUSE/STILL** during playback.

Press **SLOW** one by one: The picture advances frame by frame.

To return to playback: Press **PLAY** or **PAUSE/STILL**.

Adjusting tracking condition

Automatic tracking adjustment

Whenever you insert a tape and start playback, automatic tracking starts working and continuously analyzes the signal to enable optimum picture quality during playback.

Manual tracking adjustment

If automatic tracking cannot eliminate noises well during playback, press **TRACKING +/-** to eliminate the noises. "MANUAL TR." will appear. Press it briefly for a fine adjustment, or press and hold for a coarse adjustment.

- Press **ATR** to reactivate automatic tracking again. "AUTO TR." will appear.

NOTES:

- The audio output is muted during Picture Search, Still Picture, Slow Motion and Frame by Frame Picture.
- During Picture Search mode there will be noise bars which are caused by the system.
- The Special Playback will automatically change to playback after approx. 5 minutes to protect the video tape against excessive wear.

Repeat playback

The entire video tape will be played until its end. The tape will then automatically rewind to the beginning and the playback will be repeated.

- 1 Press **SETUP/TV MENU**. Press **◀** or **▶** to select option.

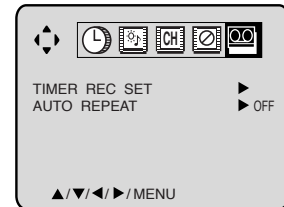

- 2 Press **▲** or **▼** to select "AUTO REPEAT", then press **◀** or **▶** to select "ON" or "OFF". If "ON" is selected, the playback will be repeated endlessly.

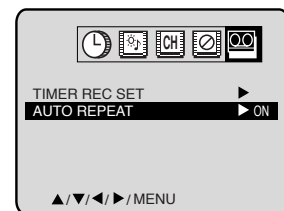

- 3 Press **SETUP/TV MENU** until the menu screen is cleared. If you press **DISPLAY/CALL**, "⌂" will appear on the screen.

- 4 To start the playback, press **PLAY**. The playback will be repeated endlessly.

To cancel repeat mode:

Follow the above step 2, then press **◀** or **▶** to select the OFF position. Press **SETUP/TV MENU** to return to the TV.

To monitor a TV program

Press **TV MONITOR** while in the playback mode. The video tape will continue to play while the picture switches to the TV channel selected on the unit. Press the button to return to the playback picture.

CM SKIP

Press **CM SKIP** in the PLAY mode. The unit will search forward through approximately 30 seconds of the tape (e.g. unwanted commercial time) for each press of **CM SKIP** (maximum six presses) and then resume normal playback.

For example: 1 press: 30 second of tape
 2 press: 60 second of tape
 3 press: 90 second of tape

ZERO RETURN function / Video index search system

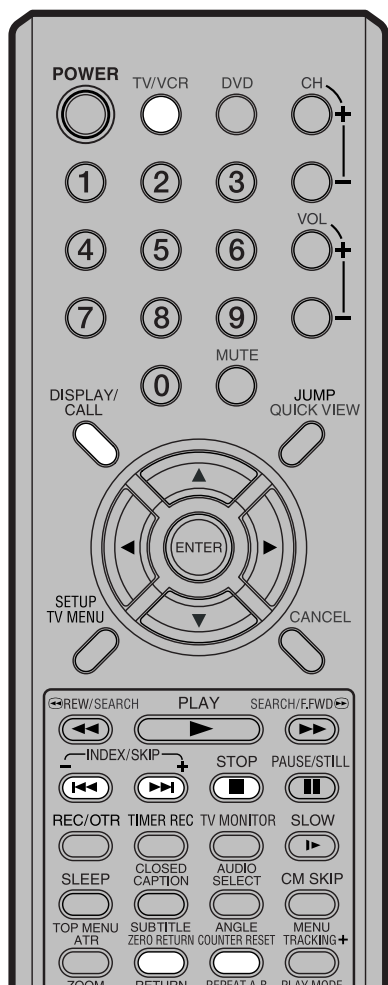

ZERO RETURN function

This function makes tape-rewinding stop at the counter 00:00:00 position automatically.

Preparation:

Press **TV/VCR** to select the TV/VCR mode.

- 1 Press **DISPLAY/CALL**.
The counter display shows the tape running time during playback or recording.

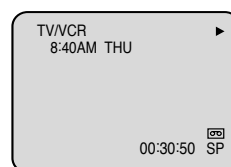

- 2 Press **COUNTER RESET** at the desired tape position. The counter display will be reset to the "00:00:00" position (e.g. the beginning of recording).

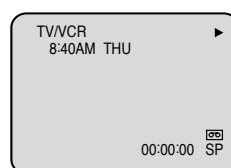

- 3 Press **STOP** when playback or recording is finished. Press **ZERO RETURN**.
The tape will be rewinded or fast forwarded and automatically stop at the "00:00:00" position.

Video index search system

This function enables you to locate the beginning of any recording made on the VCR.

Recording an INDEX MARK

The Index Search function automatically records an INDEX mark on the tape whenever a recording is initiated.

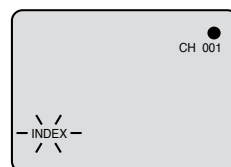

Index Search

Press **INDEX +** or **-** during stop or play mode.

For Succeeding programs: Press **INDEX +**.
For Preceding programs: Press **INDEX -**.
(Additional press increases the INDEX NO. up to 9.)

When the **INDEX +** or **-** is pressed, the unit starts searching the INDEX NO. selected and finds the portion, then playback starts automatically.

To stop the Index Search, press **STOP**.



▶▶ or ◀◀ is displayed
INDEX NO. (up to 9)

NOTES for Counter Display:

- If you rewind the tape beyond "00:00:00", a minus sign ("-") will be displayed in front of the time.
- When you load a tape, the counter will reset to "00:00:00".
- The counter does not function on nonrecorded (blank) sections of the tape. When you rewind, fast forward or play tapes through blank sections, the counter stops.

NOTES for Video index search system:

- When you record an INDEX mark at the very beginning of the tape, the mark may not be found.
- During INDEX search, the tape may stop and begin to play at a slightly different location.
- INDEX may not function properly with old or worn out video tapes.
- INDEX marks may not be found if it is extremely close to the point where the search began.
- In recording, if you stop recording temporarily, the INDEX mark is not recorded on the tape.



Recording a TV program

Recording and viewing the same TV program

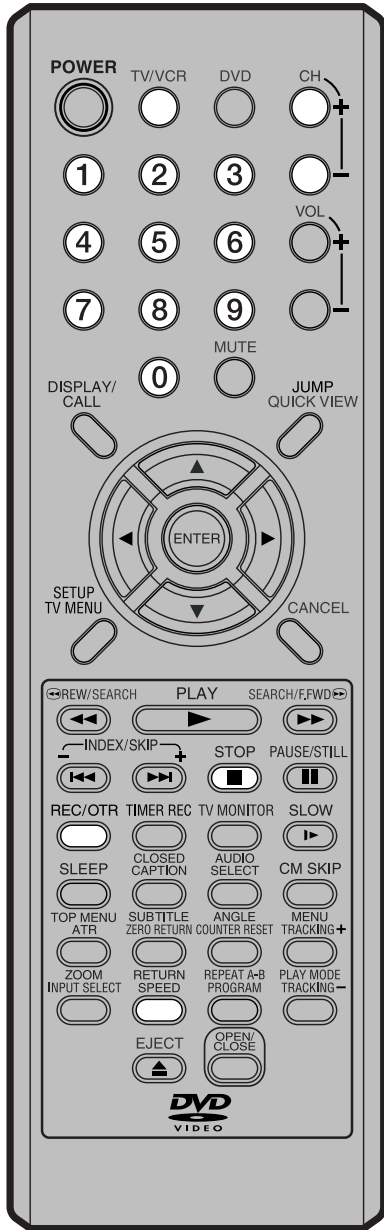

Preparation:

Press **TV/VCR** to select the TV/VCR mode.

- 1 Load a cassette tape with the erase prevention tab intact. The unit will automatically turn on.

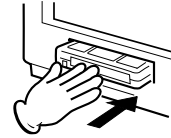

- 2 Press **SPEED** to select the desired tape speed SP or SLP. The tape counter and SP or SLP will appear on the screen for about 4 seconds.

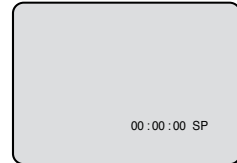

- 3 Set the TV/CABLE option to the appropriate position (See page 22).

TV - VHF/UHF channels
CABLE - Cable TV channels

- 4 Press **Direct Channel Selection (0-9)** or **CH +/-** to select the channel to be recorded.

- 1-9 Press **0** twice and then **1-9** as required. Example: To select 2, Press **002**.
- 10-12 Press **0** first and then the remaining 2 digits in order from left to right. Example: Press **012** for "12".
- 13-99 Press 2 digits in order. Example: Press **22** for "22".
- 100-125 Press the 3 digits in order. Example: Press **110** for "110".

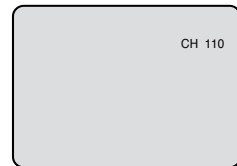

VHF/UHF/Cable TV channels

TV	Cable TV
VHF 2-13	VHF 2-13
UHF 14-69	STD/HRC/IRC 14-36 (A) (W) 37-59 (AA) (WW) 60-85 (AAA) (ZZZ) 86-94 (86) (94) 95-99 (A-5) (A-1) 100-125 (100) (125) 01 (5A)

- 5 Press **REC/OTR**. "●" will appear on the screen for about 4 seconds and the REC/OTR indicator will light.

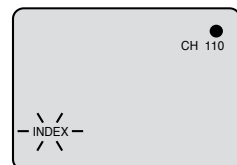

NOTES:

- If power is switched off during recording, the TV and the DVD sections go off and the VCR continues to record. Press **STOP** to halt the recording and turn off the VCR.
- The unit channel cannot be changed during recording.
- If you record the TV program after the DVD playback, you must set the unit to TV/VCR mode using **TV/VCR**.



Recording a TV program

(continued)

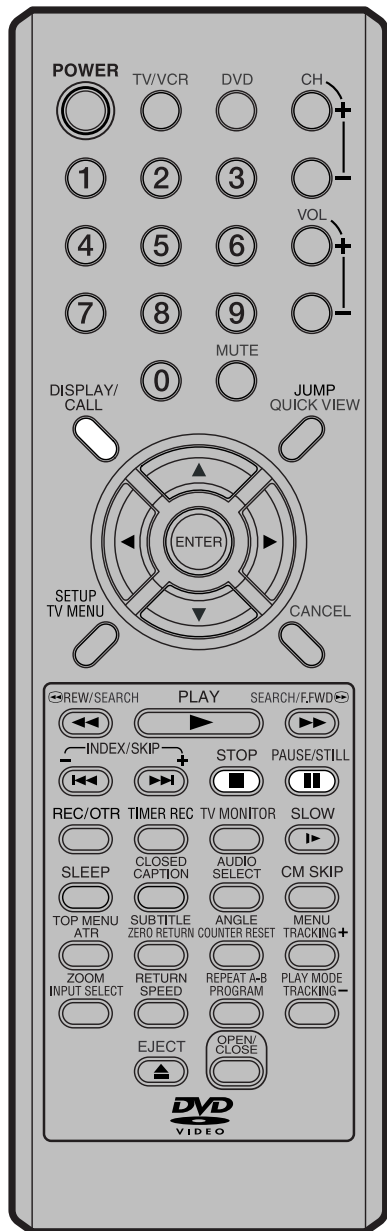

To stop recording

Press **STOP** to stop recording. "■" will appear on screen for about 4 seconds.



To stop recording temporarily

Press **PAUSE/STILL** to avoid recording unwanted material. Press again to continue the recording. "||" will appear on screen for about 4 seconds.

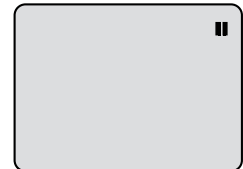

NOTES:

- The pause function will be released after 5 minutes to prevent damage to the tape or the unit. The unit will change to the STOP mode.
- You can select a recording channel in the recording pause mode.

To Display VCR operation Status

Press **DISPLAY/CALL**. The clock, day of the week and more information will be indicated.

While watching TV

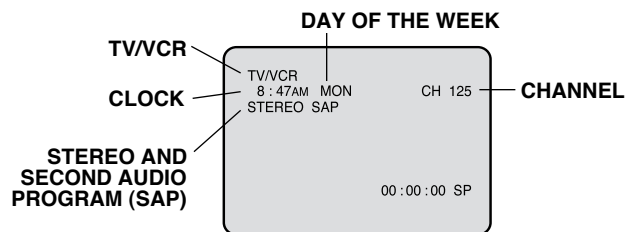

While operating a tape

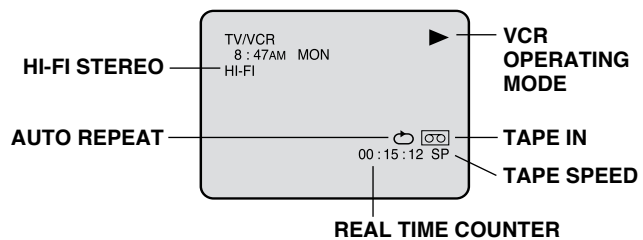

Auto Rewind feature

This VCR will automatically rewind the tape when the tape has ended (except during OTR and TIMER REC). It will also eject the tape.

To cancel the display: Press **DISPLAY/CALL** until all indicators disappear.



One-touch Timer Recording (OTR)

The One-touch Timer Recording feature provides a simple and convenient way to make a timed recording.

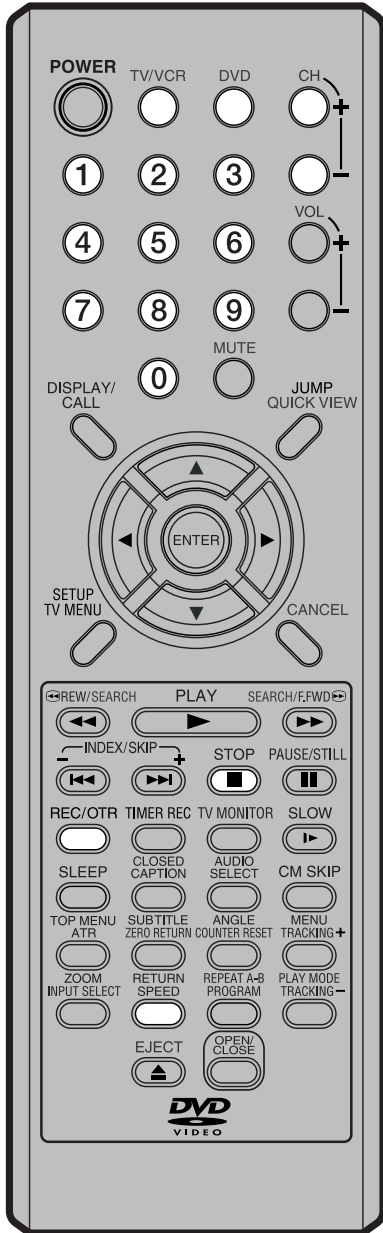

Preparation:

Press **TV/VCR** to select the TV/VCR mode.

EXAMPLE: One-touch Timer Recording for 30 minutes.

1 Load a cassette tape with the erase prevention tab intact. The unit will automatically turn on.

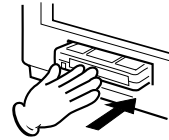

2 Press **SPEED** to select the desired tape speed SP or SLP. The tape counter and SP or SLP will appear on the screen for about 4 seconds.

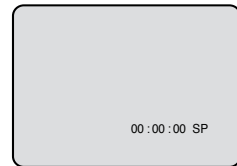

3 Set the TV/CABLE option to the appropriate position (See page 22).

TV - VHF/UHF channels
CABLE - Cable TV channels

4 Press **Direct Channel Selection (0-9)** or **CH +/-** to select the channel to be recorded.

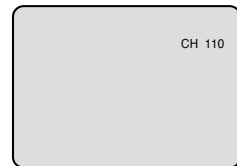

5 Press **REC/OTR**. Press the button again to stop recording after 30 minutes. Each additional press of **REC/OTR** will increase recording time as shown in the chart below, up to a maximum of 6 hours. The OTR and recording time will appear on the screen for about 4 seconds.

Press	Recording time	Press	Recording time
once	NORMAL REC	6 times	3:00
twice	0:30	7 times	4:00
3 times	1:00	8 times	5:00
4 times	1:30	9 times	6:00
5 times	2:00	10 times	NORMAL REC

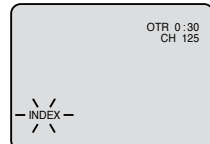

To cancel OTR

Press **STOP**.

"■" will appear on screen for about 4 seconds.



NOTES:

- If you wish to watch a DVD during a one-touch recording (OTR), press **DVD** to change to the DVD mode and perform the DVD playback.
- The channel cannot be changed during recording.





Timer recording

Timer recording can be programmed on-screen with the remote control. The built-in timer allows automatic unattended recording of up to 8 programs within 1 month.

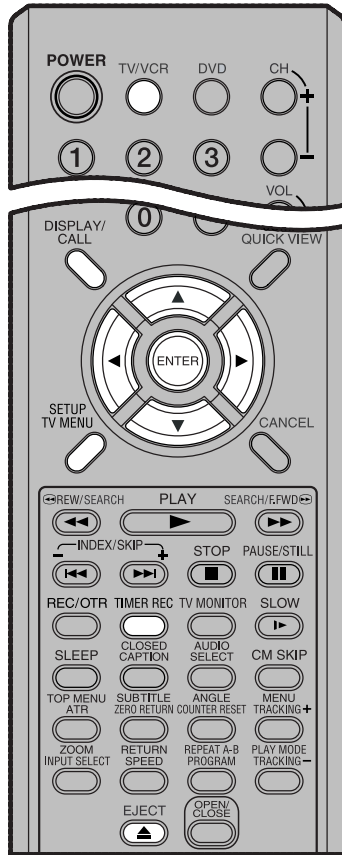

NOTES:

- If the **TIMER REC** indicator blinks when the timer recording ended, the TV program has not been completely recorded because of an insufficient tape supply. Press **TIMER REC** to cancel the timer program or press **EJECT** to remove the cassette tape.
- During timer recording standby mode, the VCR operation cannot be used. To use the VCR operation, press **TIMER REC** to deactivate the timer. After you use the VCR, press **TIMER REC** again to put the VCR into timer recording standby mode.
- If you press **TIMER REC** during timer recording, the recording operation will be interrupted. If you press **TIMER REC** again within the programmed time, the recording operation will start again.
- After a power failure or disconnection of the power plug, all programmed recording settings and time display will be lost upon resumption of power. In this case, reset the clock (see pages 16-18) and reprogram any timer recordings.

Preparation:

- Press **TV/VCR** to select the TV/VCR mode.
- Load a cassette tape with the erase prevention tab intact.
- Press **DISPLAY/CALL** to verify that the time and date are correct (see page 37).

EXAMPLE: Program a timer recording for the 23rd day, channel 125 (CABLE), 7:00 - 9:30 PM on timer program number 1 (Tape speed: SLP).

1 Press **SETUP/TV MENU**. Press ◀ or ▶ to select option.

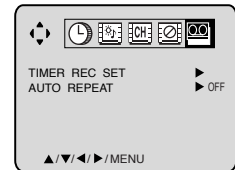

2 Press ▲ or ▼ to select "TIMER REC SET", then press ▶.

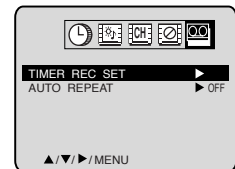

3 Press ▲ or ▼ to select one of the program line, then press **ENTER**.



4 Press ◀ or ▶ to select the date, then press ▼.

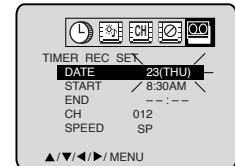

5 Set the **start time, end time, channel and tape speed** as in step 4, then press **ENTER**.

NOTES:

- Press ▲ to move arrow backward for correction.
- To record from external source set the channel to "L". "L" will appear next to CH 125 (or 69).

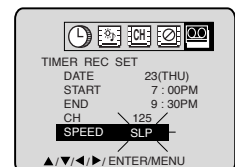

6 To enter other programs, repeat steps 3-5.

- To return to the normal screen, press **SETUP/TV MENU** 3 times.

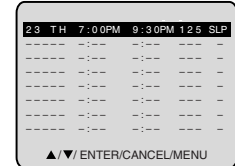

7 Press **TIMER REC**. The **TIMER REC** indicator will light and the VCR stands by for recording. The timer recording will start at 5 seconds before the time you predetermined.

NOTES:

- If the **TIMER REC** indicator does not light in spite of the pressing of **TIMER REC**, the cassette may not have been loaded yet (see page 32).
- If the cassette is ejected in spite of the pressing of **TIMER REC**, the erase prevention tab of the cassette may have been removed (see page 32).



Timer recording

(continued)

Timer recording special case

Weekly (e.g. WKL-TUE: each Tuesday) or daily (e.g. MON-SAT: Monday to Saturday) Timer recording

Follow the procedure of timer recording on the previous page. At picture 4 press ◀ repeatedly until the desired setting appears. Then press **ENTER**.

When you press ◀ repeated, the indicator at DATE will change as follows, in this example the day is Friday.

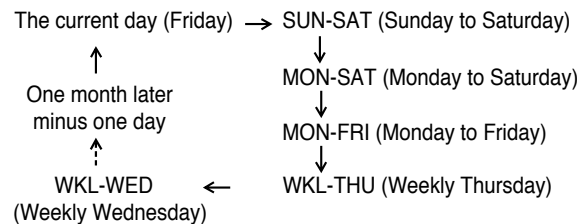

In case Timer programs-overlap

Do not overlap timer programs as portions of the conflicting programs will be lost. The first recording time has priority over the next recording time as shown in the diagram below.

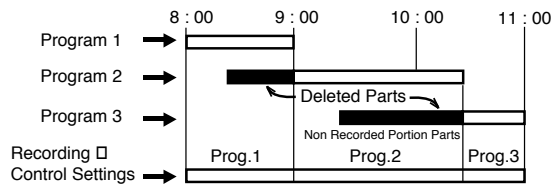

NOTES:

- The daily/weekly recording can be made continuously until the recording is canceled or the tape reaches the end.
- During timer recording the automatic rewinding mechanism does not function.

To confirm the settings

Press **PROGRAM** once. The TV screen displays the timer program list. Press **PROGRAM** again. The TV screen displays the ON/OFF TIMER setting.

(once)

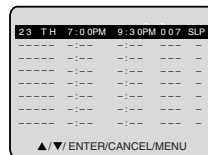

(twice)

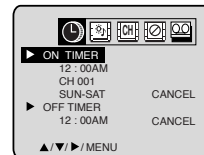

Press **PROGRAM** 3 times. The screen returns to the normal screen.

To cancel a program

Press ▲ or ▼ to select "TIMER REC SET" in the option, then press ▶. Press ▲ or ▼ to select the unnecessary program, and press **CANCEL** to cancel the program.

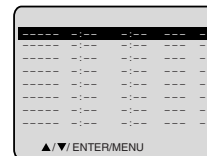

NOTES:

- If there are other timer record programs remaining, **TIMER REC** must be pressed to reactivate the timer, otherwise the remaining timer record programs will be ignored.
- You can correct or cancel a programmed setting in program confirm mode.



Duplicating a video tape

Duplicating a video tape

If you connect the unit to another VCR or camcorder, you can duplicate a previously recorded tape. Make all connections before turning on the power.

- 1 Load a blank cassette tape with the erase prevention tab intact into the recording unit. Load a previously recorded tape into the playback VCR or CAMCORDER.
- 2 Press **SPEED** to select the desired tape speed SP or SLP. It is recommended that you set the speed to the SP mode on the recording unit for best results.
- 3 Press **INPUT SELECT** to select AUDIO/VIDEO input position. "LINE" will appear on the screen.
- 4 Press **REC/OTR** on the recording unit, then press **PAUSE/STILL**.
- 5 Press the **PLAY** button on the playback VCR or CAMCORDER, then press the **PAUSE/STILL** button.
- 6 Release the recording pause and the playback still simultaneously to begin the duplicating process.

Connection with second Video recorder

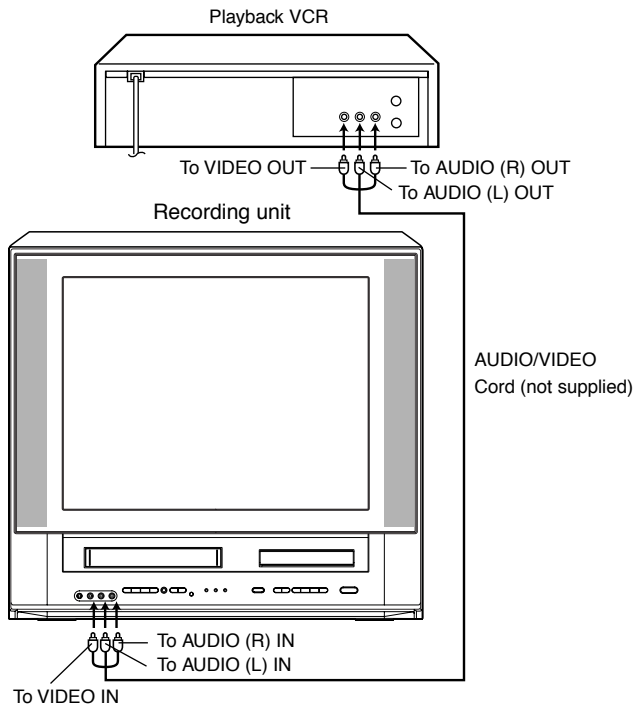

Connection with Video camera

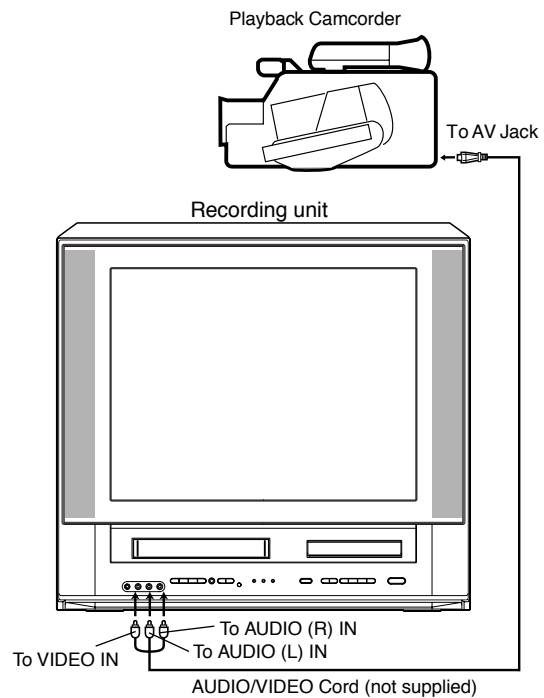

For duplicating a previously recorded tape from a camcorder, follow the camcorder manufacturer's instructions. A typical camcorder dubbing hookup is shown above.





Disc

This unit applies to DVD discs from Region 1 or ALL.

The loaded Disc (DVD, Audio-CD and MP3-CD) will be recognized automatically.

The suitable Disc-formats are: DVD, CD, CD-R/RW and DVD-R/RW (Video format only).

Some CD-R/RW and DVD-R/RW discs may be incompatible.

Do not play DVD-ROM, DVD-Audio, CDV, Video-CD, MP3/WMA/JPEG-CD or CD-G to prevent accidental erasure of prerecorded material.

Title/Chapter/Track

Title

When two or more movies are recorded on a disc, the disc is divided into two or more sections. Each section is called a "TITLE".

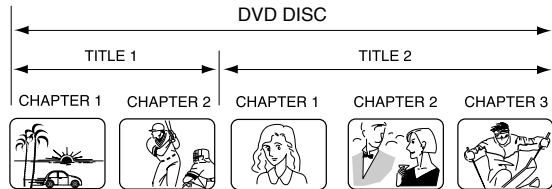

Chapter

The titles can be subdivided into many sections. Each section is called a "CHAPTER".



Track

An Audio CD can contain several items. These are assigned to a "TRACK".

Removing disc from case

Be sure to hold the edge of disc. Do not touch the surface of the disc. Pick up the disc gently from the case.

- Do not scratch the disc.
- Do not get dirt on the surface of the disc.
- Do not stick a label or adhesive tape on the disc.
- Do not drop or bend the disc.

Storing disc

- Store the disc in the case to avoid risk of scratches, dirt or damage.
- Do not leave disc exposed to direct sunlight or in hot or humid places.

Cleaning disc

Wipe the disc with a clean, dry cloth from center to edge.

- Do not wipe the disc round.
- Do not use liquid or aerosol cleaners.

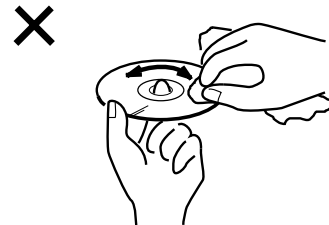
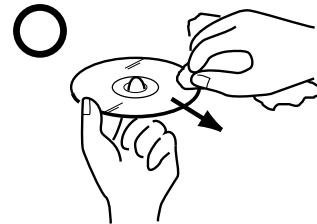
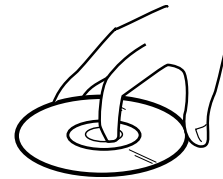

Preparation / Status display of disc

The following pages describe the setup/operation in DVD mode.

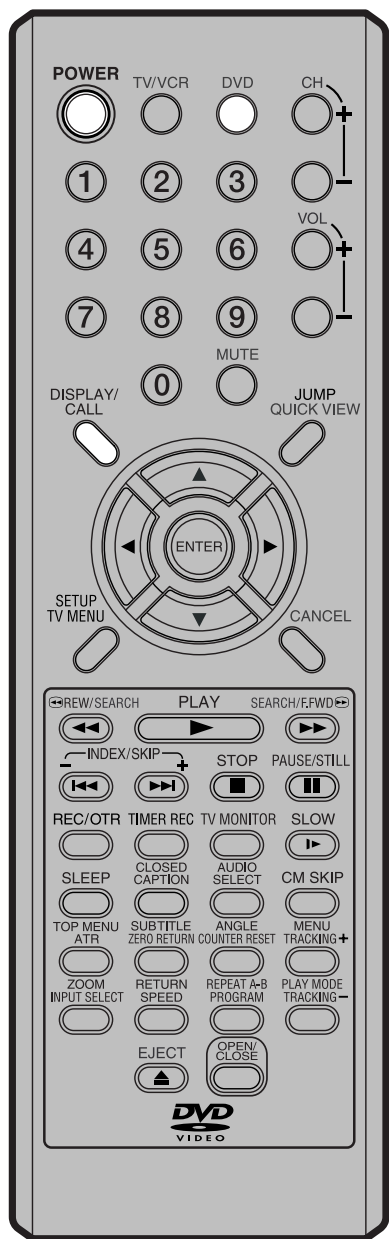

Preparation

Before DVD/CD operation, please make preparations as follows.

- 1 Insert the AC cord plug into a standard 120V 60Hz polarized AC outlet.
 - If the AC cord plug is plugged in for the first time, wait for about 5 seconds before pressing **POWER**.

NOTE: When connecting to other equipment, unplug the unit from the AC outlet.
- 2 Press **POWER** on the unit or on the remote control to turn on the unit. The POWER indicator will light.
 - Every time you press **POWER**, the TV/DVD starts from TV mode.
 - When using an amplifier, switch on the amplifier.
- 3 Press **DVD** to select DVD mode. The DVD startup screen will appear on the screen.



Status display of disc

Press **DISPLAY/CALL**. The status display of the disc will appear on the screen in order like the figure below.

DVD

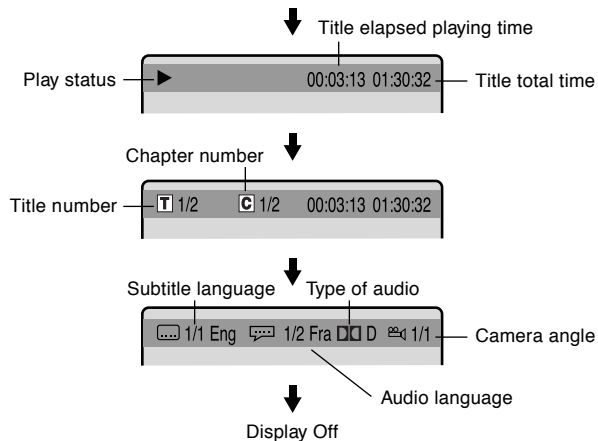

Audio CD

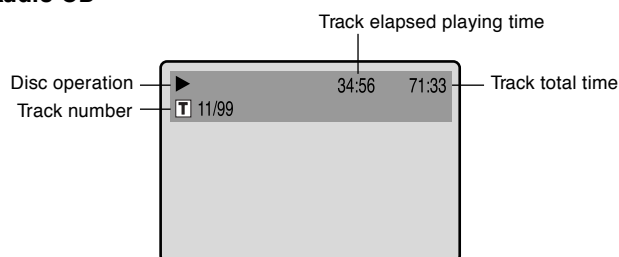

- When you play a CD disc, the status display will appear and remain on the screen.

NOTE:
If the unit does not operate properly: Static electricity, etc., may affect the player's operation. Disconnect the AC power cord once, then connect it again.

Playback procedure

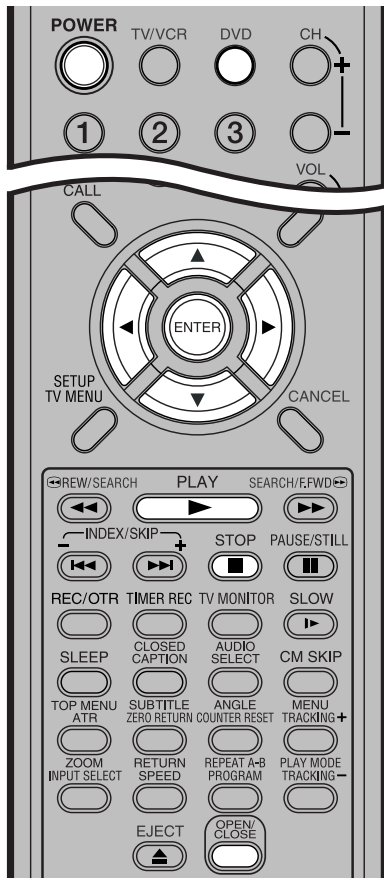

1 Press **DVD** to select DVD mode. Press **OPEN/CLOSE** on the unit or the remote control. The disc tray will open.

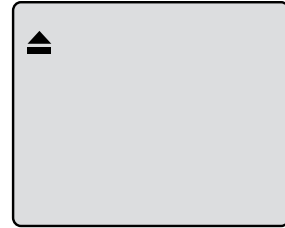

2 Place a disc onto the tray. Position it with the printed label side up, align it with the guides, and place it in its proper position.

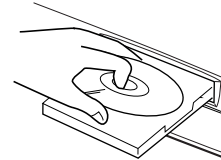

3 Press **OPEN/CLOSE** or **PLAY**. The disc tray closes automatically. The TV-screen, "▲" changes to "Reading" and then playback commences.



- A menu screen will appear on the TV screen, if the disc has a menu feature. In this case, press ▲, ▼, ◀, ▶ or ENTER to operate a menu feature.

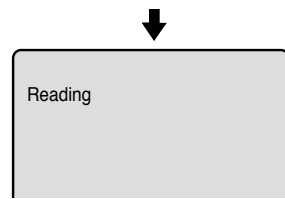

4 Press **STOP** to end playback.

- The unit memorizes the stopped point, depending on the disc. "■" appears on the screen. Press **PLAY** to resume playback (from the scene point).
- If you press **STOP** again or unload the disc ("■" appears on the screen.), the unit will clear the stopped point.

5 Press **OPEN/CLOSE**. The disc tray opens. Remove the disc and press **POWER**. The disc tray closes automatically and unit turns off.

NOTES:

- If a non-compatible disc is loaded, "Incorrect Disc", "Region Code Error" or "Parental Error" will appear on the TV screen according to the type of loaded disc. If these appear, check your disc again (see pages 42 and 55).
- Some discs may take a minute or so to start playback.
- A "Prohibition" symbol "🚫" may appear at the upper left of the screen. This symbol means either the feature you tried is not available on the disc, or the unit cannot access the feature at this time. This does not indicate a problem with the unit.
- When you set a single-faced disc label downwards (i.e. the wrong way up) and press **PLAY** or **OPEN/CLOSE** on the unit, "Reading" will appear on the display for about 30 seconds and then "Incorrect Disc" will be displayed.
- Some playback operations of DVDs may be intentionally fixed by software producers. Since this unit plays DVDs according to the disc content recorded, some playback features may not be available. Also refer to the instructions supplied with the DVDs.



Special playback

NOTE: There may be a slight delay between when you press the button and the function activating.

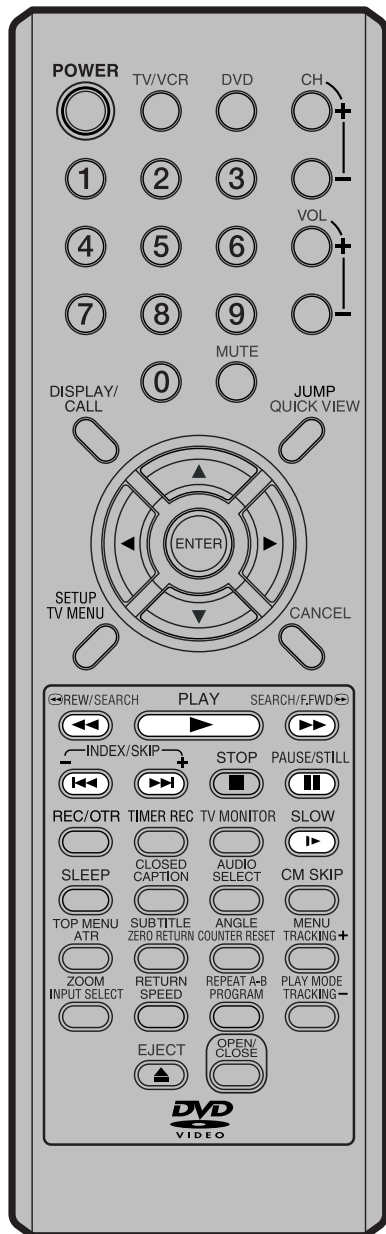

Fast Forward Playback

Press **SEARCH** during normal playback.
Each press of **SEARCH** will increase the speed of the search
 (x 2), (x 4), (x 8), (x 15).
(CD: (x 2), (x 4), (x 8), (x 20))

- To resume normal playback, press **PLAY**.

Review Playback

Press **SEARCH** during normal playback.
Each press of **SEARCH** will increase the speed of the search
 (x 2), (x 4), (x 8), (x 15).
(CD: (x 2), (x 4), (x 8), (x 20))

- To resume normal playback, press **PLAY**.

Still Playback

Press **PAUSE/STILL** during normal playback to pause playback.

- To resume normal playback, press **PLAY**.

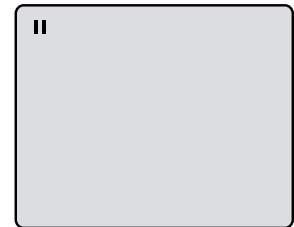

Frame Advance

Press **PAUSE/STILL** during still playback.
One frame is advanced each time you press **PAUSE/STILL**.

- To resume normal playback, press **PLAY**.

Slow-motion Playback

Press **SLOW** () during normal playback or still playback.
Each press of **SLOW** will change the speed of the slow x1/2, x1/4, x1/6, x1/7.

- To resume normal playback, press **PLAY**.
- To resume the still playback, press **PAUSE/STILL**.

Locating a chapter or track

Press **SKIP** () Forward or **SKIP** () Reverse during playback to locate a chapter that you want to watch.
Each time you press the button, a chapter or track is skipped.

NOTE:

The unit is capable of holding a still video image or On screen display image on your television screen indefinitely. If you leave the still video image or On screen display image displayed on your TV for an extended period of time, you risk permanent damage to your television screen.



MP3 playback

This player can play back the MP3-data which has been recorded on CD-R or CD-RW. To produce the MP3-data, you need a Windows-PC with CD-ROM drive and a MP3-encoding Software (not supplied). The Apple-HFS-System cannot be played.

MP3 CD information

Limitations on MP3 CD playback

- MP3 CD is the disc that is standardized by ISO9660, its file name must include 3-digits extension letters, "mp3".
- The directory and file names of the MP3 CD must be correspond to the ISO standardized files.
- This unit can read 999 files per disc. If one directory has more than 999 files, it reads up to 999 files, the remaining files will be omitted.
- The unit is able to recognize up to a maximum of 50 directories per disc.
- MP3 CDs cannot be used for playback for the purpose of recording.
- If the CD has both audio tracks and MP3 files, only audio tracks are played.
- It may take more than one minute for this unit to read MP3 files depending on its structure.
- Music recorded by "Joliet Recording Specification" can be played back, the file name is displayed (within 10 letters) on the screen Long file names will be condensed.
- The music files recorded by "Hierarchical File System" (HFS) cannot be played.

Limitations on display

- The maximum number for display is 10 letters. Available letters for display are the following: capital or small alphabets of A through Z, numbers of 0 through 9, and _ (under score).
- Other letters than those above are replaced in hyphen.

Notes on MP3 files

- To play back MP3 CD in the recorded order,
1. Use MP3 software that records data alphabetically or numerically.
 2. Name each file including two-digit or three-digit number (e.g. "01" "02" or "001" "002").
 3. Refrain from making too many sub-folders.

CAUTION:

- Some MP3 CDs cannot be played back depending on the recording conditions.
- The CD-R/RW that has no music data or non-MP3 files can not be played back.

MP3 CD playback

- 1 Press **OPEN/CLOSE**.
The disc tray will open.
Place a disc on which MP3 files have been recorded onto the tray.

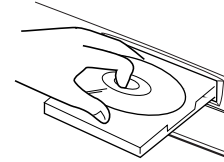

- 2 Press **OPEN/CLOSE** or **PLAY**.
The disc tray closes automatically.
On the TV-screen, "Reading" will appear. Reading will take as much time as the number of file.

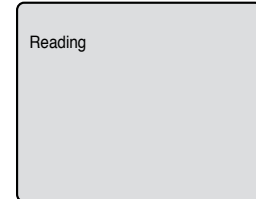

- 3 A file menu screen will appear on the TV screen.
Press **◀** or **▶** to select folder.

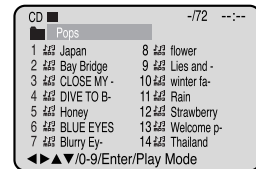

- 4 Press **▲/▼/◀/▶** or **Number buttons (0-9)** to select the desired file.
• In case the folder includes more than 15 files, press **◀** or **▶** to display next file list.

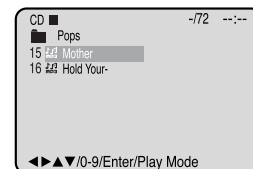
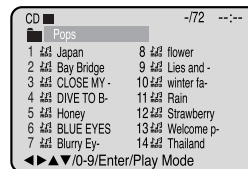

- When **PLAY** has been pressed after displaying the file menu, or when the disc tray has been closed after pressing **PLAY** in step 2, playback begins automatically starting from the first file. In this case, if the first file is an MP3 file, only MP3 files are played back in order.

- 5 Press **ENTER**.
The selected file starts playing back.

Press **STOP** to end playback.

- The unit records the stopped point. "■" appears on the screen. Press **PLAY** to resume playback (from the scene point).
- If you press **STOP** again or unload the disc, the unit will clear the stopped point.

NOTES:

- During MP3-Playback, you cannot use SEARCH, A-B Repeat functions.
- You can use Repeat (Track or All), Random functions and Program playback for MP3 CD Playback (see pages 48 and 49).





Zooming / Locating desired scene

Zooming

This unit will allow you to zoom in on the frame image. You can then make selections by switching the position of the frame.

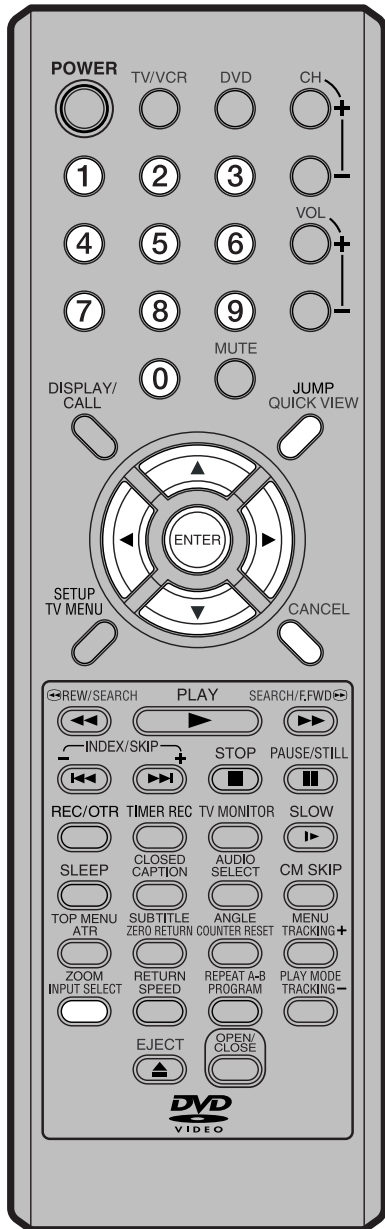

- 1 Press **ZOOM** during playback. The center part of the image will be zoomed in. Each press of **ZOOM** will change the ZOOM magnification Q₁ (x 1.3), Q₂ (x 1.5) and Q₃ (x 2.0).

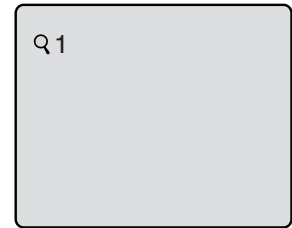

- 2 Press **▲/▼/◀/▶** to view a different part of the frame. You may move the frame from the center position UP, DOWN, LEFT or RIGHT.
- 3 In the zoom mode press **ZOOM** repeatedly to return to a 1:1 view (Q Off).

Locating desired scene

Use the title, chapter and time recorded on the disc to locate the desired point to play back.

- 1 Press **JUMP** during playback.
- 2 Press **◀** or **▶** to select the "L Time", "T Title" or "C Chapter".
- 3 Press **Number buttons (0-9)** to input the number.
 - If you input a wrong number, press **CANCEL**.
 - Refer to the package supplied with the disc to check the numbers.
- 4 Press **ENTER**.



NOTES:

- You can select the Still Playback, Slow-motion Playback or Fast Forward (Review) Playback in the zoom mode.
- Some discs may not respond to zoom feature.

Repeat playback

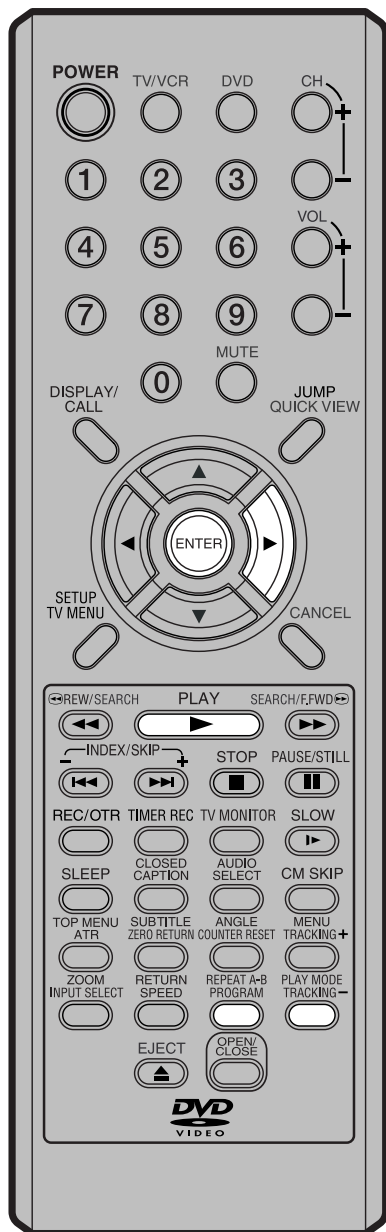

Title, Chapter, Track Playback

1 Press **PLAY MODE** during playback or stop mode.

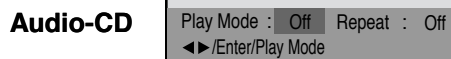
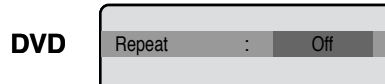

2 Press **ENTER** to select "Chapter" or "Title".
 • In case of Audio-CD, first press **▶** to select "Repeat" and then press **ENTER** to select "Track" or "All".

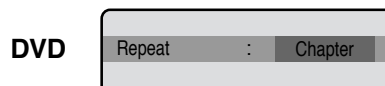

3 Press **PLAY MODE** again to make the screen disappear.

- Press **PLAY** to start Repeat playback.
- To resume normal playback, select Repeat "Off".

A-B Repeat Playback

A-B repeat playback allows you to repeat material between two selected points.

1 Press **REPEAT A-B** during playback.
The start point is selected.

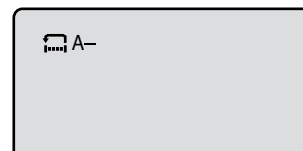

2 Press **REPEAT A-B** again.
The end point is selected.
Playback starts at the point that you selected. Playback stops at the end point, returns to Point A automatically, then starts again.

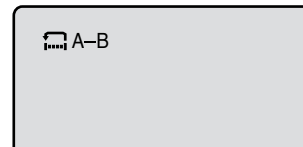

NOTES:

- Some discs may not be compatible with the repeat operation.
- In A-B Repeat mode, subtitles near the A or B locations may not be displayed.
- You cannot set the A-B Repeat for the scenes that include multiple angles.
- You may not be able to set A-B Repeat during certain scenes of the DVD.
- A-B Repeat does not work with an interactive DVD, MP3-CD.

To resume normal playback press **REPEAT A-B** again.
 "Off" appears on the screen.

Program playback/Random playback (only CD)

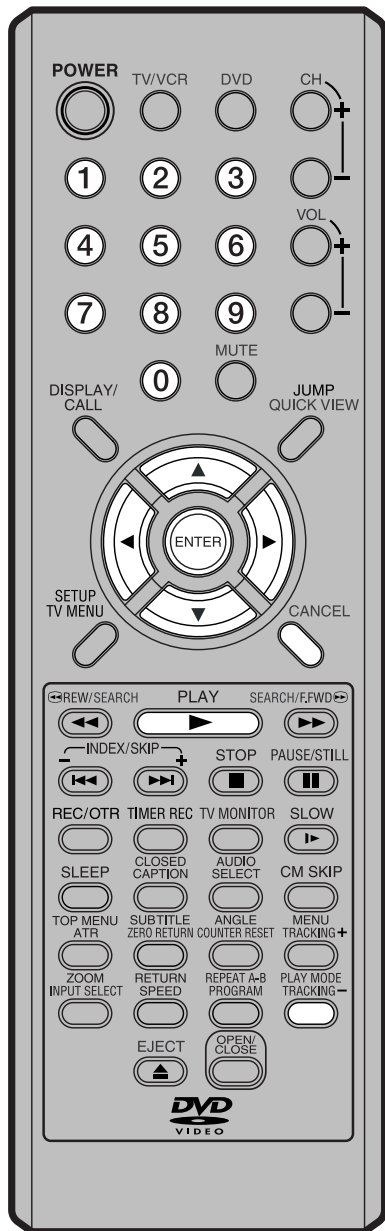

Program playback

You can arrange the order of tracks on the disc.

1 Press **PLAY MODE** in the stop mode.

```
Play Mode : Off Repeat : Off
◀▶/Enter/Play Mode
```

2 Press **◀** or **▶** to select "Play Mode", then press **ENTER** to select "Program".

```
Play Mode : Program Repeat : Off
1 --- 4 --- 7 --- 10 ---
2 --- 5 --- 8 --- 11 ---
3 --- 6 --- 9 --- 12 ---
Clear Program Playback
◀▶/Enter/0-9/Cancel/Play Mode
```

3 **Example:** In case you wish to program in order of 7, 3, 11:
Enter as **7 ▼, 3 ▼, 11**.

• If you input a wrong number, press **CANCEL**.

```
Play Mode : Program Repeat : Off
1 7 -- 4 --- 7 --- 10 ---
2 3 -- 5 --- 8 --- 11 ---
3 11 -- 6 --- 9 --- 12 ---
Clear Program Playback
◀▶/Enter/0-9/Cancel/Play Mode
```

4 Press **▲/▼** or **◀/▶** to select "Program Playback" and press **ENTER**. "Program Playback" will appear on the screen. The program you selected will begin to playback in the order set. To return to normal playback, select "Play Mode: Off" at step 2 above.

```
Program Playback 02:31 08:29
T 7/11
```

Random playback (only CD)

1 Press **PLAY MODE** during playback or stop mode.

```
Play Mode : Off Repeat : Off
◀▶/Enter/Play Mode
```

2 Press **◀** or **▶** to select "Play Mode", then press **ENTER** to select "Random".

```
Play Mode : Random Repeat : Off
◀▶/Enter/Play Mode
```

3 Press **PLAY**. "Random Play" will appear on the screen and Random playback will start.

To return to normal playback, select "Play Mode : Off" at step 2 above.

NOTES:

- To cancel program play, select "Clear" at step 4 and press **ENTER**.
- The program is cancelled when you open the disc tray or turn the power off.
- Random playback cannot be combined with Repeat playback.

Changing soundtrack language / Subtitles

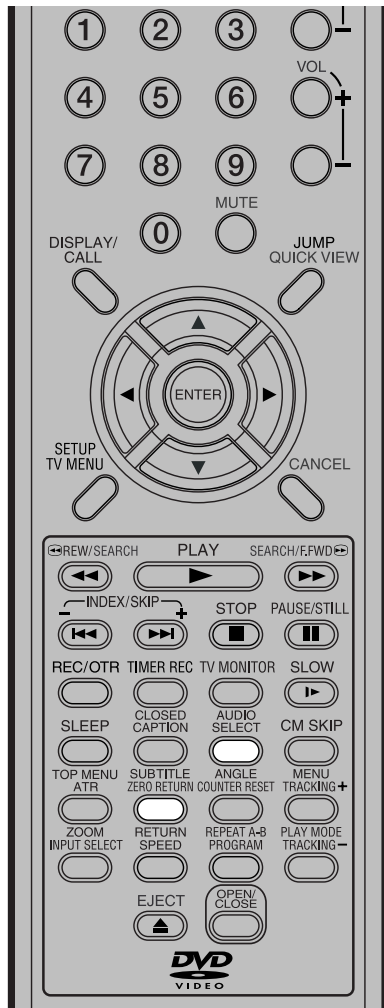

Changing soundtrack language

You can select the language when you play a multilingual disc.

- 1 Press **AUDIO SELECT** during playback.



The current soundtrack language will appear.

- 2 Press **AUDIO SELECT** repeatedly until the desired language is selected.



The on-screen display will disappear after a few seconds.

Subtitles

Turning the subtitles on and off

When playing back a disc recorded with subtitles, you can turn the subtitles on or off.

- 1 Press **SUBTITLE** during playback until "Off" appears.



Changing the subtitle language

You can select the language when playing back a disc recorded with multi-lingual subtitles.

- 1 Press **SUBTITLE** repeatedly during playback until your desired language appears.

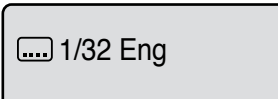

- 2 The on-screen display will disappear after a few seconds.

NOTES:

- If the desired language is not heard after pressing **AUDIO SELECT** several times, the language is not recorded on the disc.
- Changing soundtrack language is cancelled when you open the disc tray. The initial default language or available language will be heard if the disc is played back again.
- Changing subtitle language is cancelled when you open the disc tray.
- Some functions may not work on some DVDs. You may not be able to turn subtitles on or off or change subtitles. While playing the DVD, the subtitle may change when:
 - you open or close the disc tray.
 - you change the title.
- In some cases, the subtitle language is not changed to the selected one immediately.

Changing angles / Title selection / DVD menu

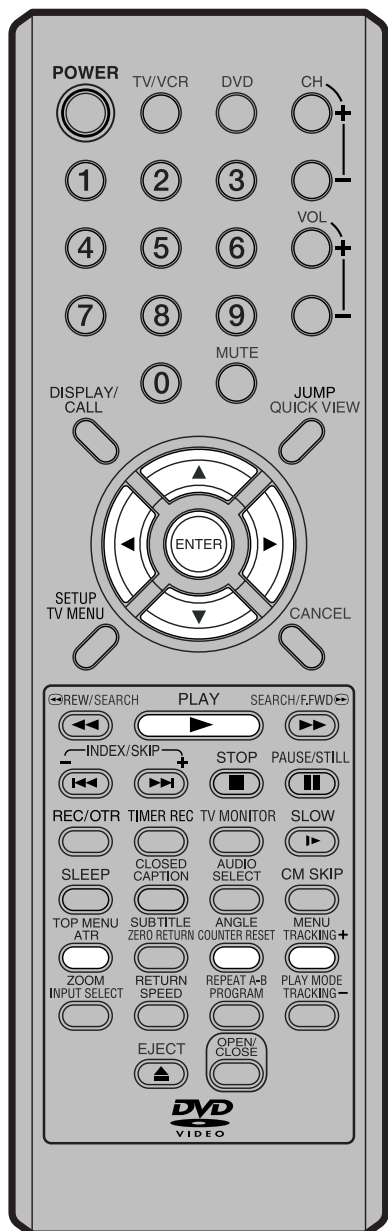

NOTES:

- Depending on the DVD, you may not be able to change the angles even if multi-angles are recorded on the DVD.
- Depending on the DVD, you may not be able to select the title. Depending on the DVD, a "title menu" may simply be called a "menu" or "title" in the instructions supplied with the disc.

Changing angles

When playing back a disc recorded with multi-angle facility, you can change the view angle.

- 1 Press **ANGLE** during playback.
The current angle will appear.

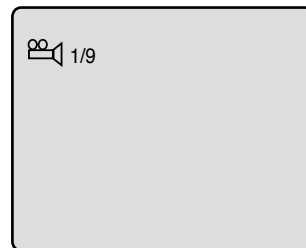

- 2 Press **ANGLE** repeatedly until the desired angle is selected.

Title selection

Two or more titles are recorded on some discs. If the title menu is recorded on the disc, you can select the desired title.

- 1 Press **TOP MENU** during playback.
Title menu appears on the screen.
- 2 Press **▲/▼/◀/▶** to select the desired title.
- 3 Press **ENTER** or **PLAY**.
The playback of the selected title will start.

DVD menu

Some DVDs allow you to select the disc contents using the menu.

When you play back these DVDs, you can select the sub-title language and sound-track language, etc. using the DVD menu.

- 1 Press **MENU** during playback.
The DVD menu appears on the screen.
 - Press **MENU** again to resume playback at the scene when you pressed **MENU**.
- 2 Press **▲/▼/◀/▶** to select the desired item.
- 3 Press **ENTER**.
The menu continues to another screen. Repeat steps 2 and 3 to set additional items if any.



Setting the aspect ratio of TV screen / Setting on screen display

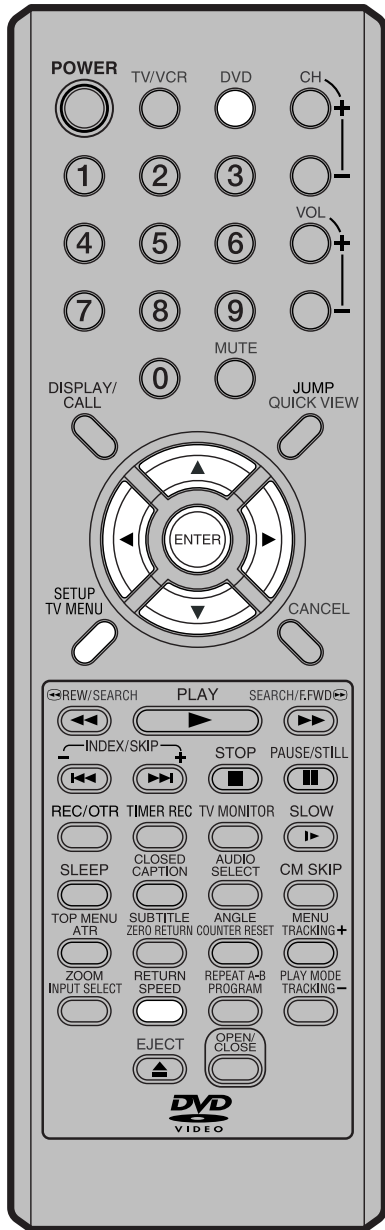

Setting the aspect ratio of TV screen

You can select the aspect ratio of the picture.

- 1 Press **DVD** to select DVD mode. Press **SETUP/TV MENU** in the stop mode or No Disc. Press **◀** or **▶** to select  option.



- 2 Press **▼** or **ENTER**, then press **▲** or **▼** to select "TV Screen".

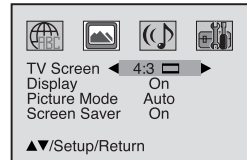

- 3 Press **◀** or **▶** to select your desired screen type.

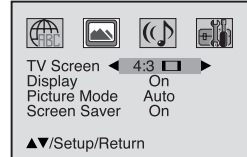

You have the following screen sizes to choose from:

4:3 Letterbox

When playing back a wide screen DVD disc, it displays the wide picture with black bands at the top and bottom of screen.

4:3 Panscan

It displays the wide picture on the whole screen with left and right edges automatically cut off.

- 4 Press **SETUP/TV MENU** or **RETURN** to remove the Menu screen.

Setting on screen display

On screen display can be switched on or off when you press the **DISPLAY/CALL** button.

- 1 Press **DVD** to select DVD mode. Press **SETUP/TV MENU** in the stop mode or No Disc. Press **◀** or **▶** to select  option.

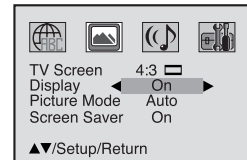

- 2 Press **▼** or **ENTER**, then press **▲** or **▼** to select "Display".

- 3 Press **◀** or **▶** to select "On" or "Off".

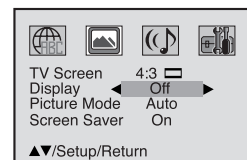

On: On screen displays appear when you press the buttons (factory setting).

Off: On screen displays do not appear when you press any buttons except **SETUP/TV MENU**, **SEARCH MODE**, **PLAY MODE** and **DISPLAY/CALL**.

- 4 Press **SETUP/TV MENU** or **RETURN** to remove the menu screen.

NOTE:

It is not always possible for the DVD disc to display the picture as per your preferred picture setting - for example, if you select "4:3 Panscan", the disc may not offer this option. In this case the picture would display the format the disc is capable of playing back.



Setting the Picture mode/Screen saver function

There are two types of source content in pictures recorded in DVD video discs: film content (pictures recorded from films at 24 frames per second) and video content (video signals recorded at 30 frames per second). Make this selection according to the type of content being viewed.

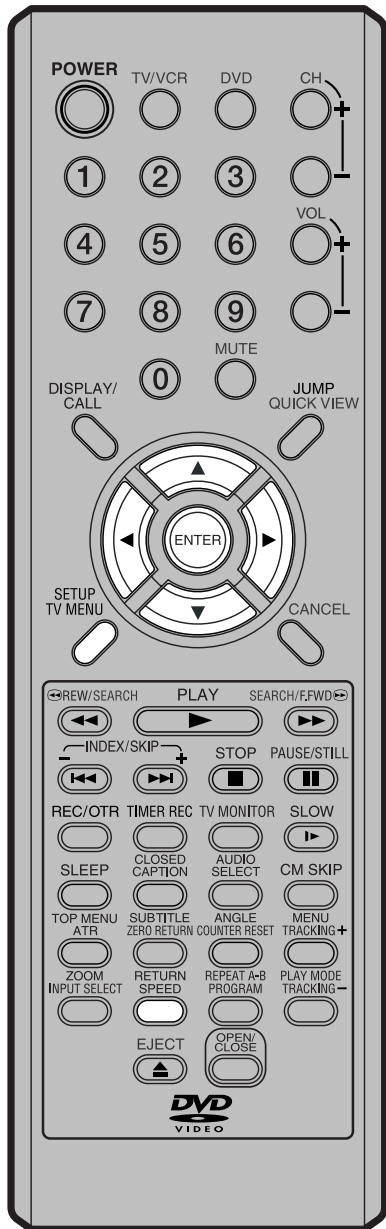

NOTE:
Depending on the disc, pictures may be cut off or doubled. In this case, select "Video".

Setting the Picture mode

1 Press **SETUP/TV MENU** in the stop mode or No Disc.
Press **◀** or **▶** to select  option.

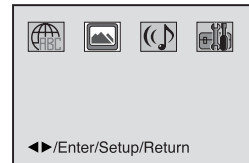

2 Press **▼** or **ENTER**, then press **▲** or **▼** to select "Picture Mode".

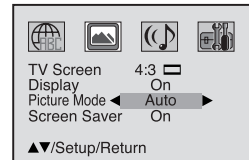

3 Press **◀** or **▶** to select your desired picture mode.

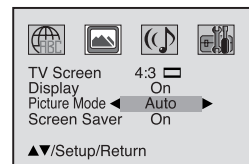

Auto:

Select this position normally.
The DVD player automatically detects source content, film or video, of playback source.

Film:

Suitable for playback of film content pictures.

Video:

Suitable for playback of video content pictures.

4 Press **SETUP/TV MENU** or **RETURN** to remove the menu screen.

Screen saver function

With some discs, a menu or similar screen appears when playback ends. Leaving a fixed display such as a menu on the screen for an extended period may cause image burn-in on the TV screen. To prevent this, this TV/DVD is equipped with a screen saver function. If an image is left continuously on the screen for approximately 5 minutes, the screen gradually darkens and then gradually brightens again. This process repeats until the image is changed.

1 Press **SETUP/TV MENU** in the stop mode or No Disc.
Press **◀** or **▶** to select  option.

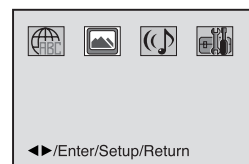

2 Press **▼** or **ENTER**, then press **▲** or **▼** to select "Screen Saver".

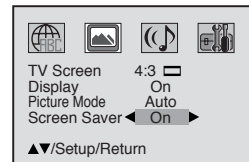

3 Press **◀** or **▶** to select "On" or "Off".

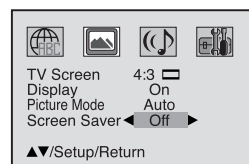



4 Press **SETUP/TV MENU** or **RETURN** to remove the menu screen.

53

Dynamic Range Control

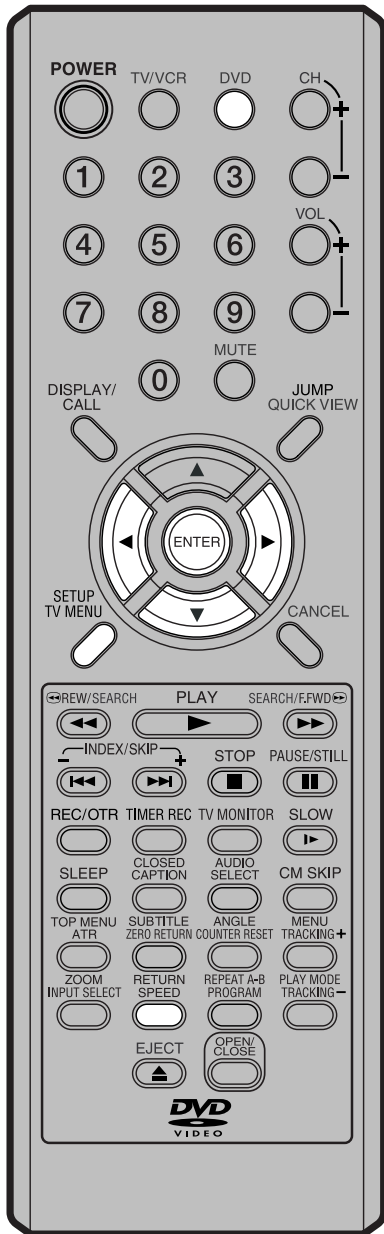
DRC (Dynamic Range Control) enables you to control the dynamic range so as to achieve a suitable sound for your equipment.



1 Press **DVD** to select DVD mode. Press **SETUP/TV MENU** in the stop mode or No Disc. Press **◀** or **▶** to select  option.

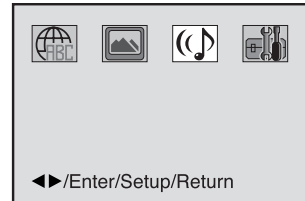

2 Press **▼** or **ENTER** to select "DRC".

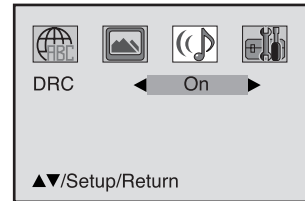

3 Press **◀** or **▶** to select "On" or "Off", then press **ENTER**.

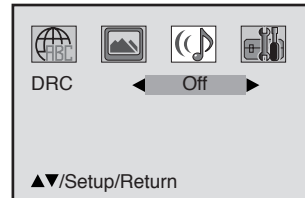

On: Loud sound such as explosion or similar is toned down slightly when played back. This makes it suitable for when it is connected to a stereo.

Off: It plays back at the recording level on the disc.

4 Press **SETUP/TV MENU** or **RETURN** to remove the menu screen.

NOTES:

- This function works only during playback of Dolby Digital recorded discs.
- The level of Dynamic Range Reduction may differ depending on DVD video disc.



Parental control setting

Some discs are specified as not suitable for children. Playback of such discs can be restricted with this unit.

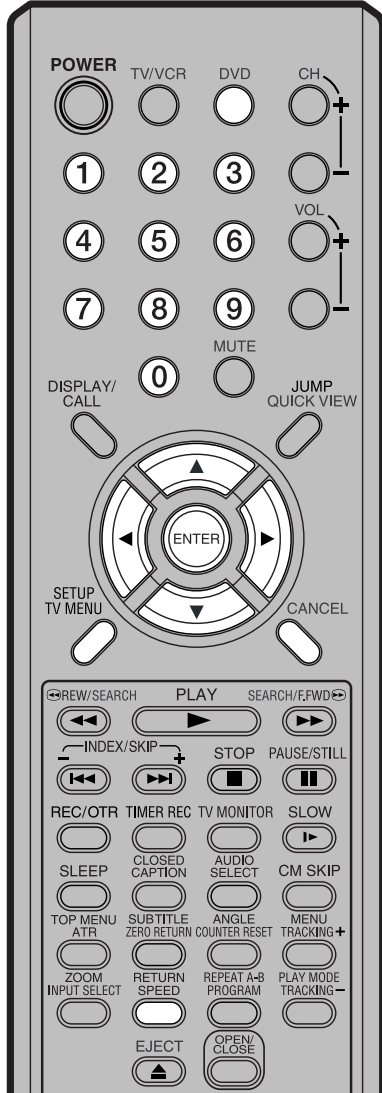

1 Press **DVD** to select DVD mode. Press **SETUP/TV MENU** in the stop mode or No Disc. Press **◀** or **▶** to select  option.

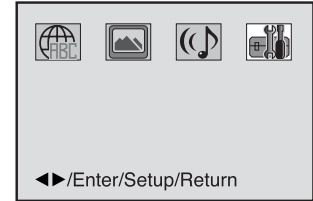

2 Press **▼** or **ENTER**. Press **▼** to select "Parental", then press **◀** or **▶** until the level you require appears.

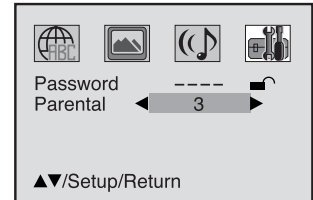

- **Level Off** : The parental control setting does not function.
- **Level 8** : Virtually all DVD software can be played back.
- **Level 1** : DVD software for adults cannot be played back.

• Select from level 1 to level 8. The limitation will be more severe as the level number decreases.

3 Press **▲** to select "Password". Press **Number buttons (0-9)** to input a 4-digit password. Be sure to remember this number!

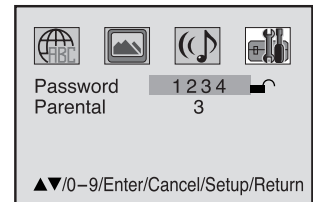

• If you input a wrong number, press **CANCEL**.

4 Press **ENTER** to store the password.

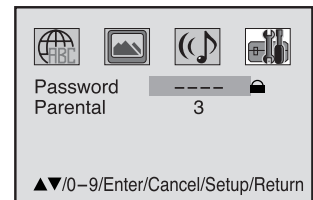

NOTE: After the rating is locked, the setting cannot be changed unless you enter the correct password.

5 Press **SETUP/TV MENU** or **RETURN** to remove the menu screen.

NOTES:

- When each setup function (P.52~56, 58) has been completed, the unit can always be operated under the same conditions (especially with DVD discs).

Each setup command will be retained in the memory even if you turn the power off.

- Depending on the discs, the unit may not be able to limit playback.
- Some discs may not be encoded with specific rating level information though its disc jacket says "adult." For those discs, the parental control feature will not work.

To change the parental level

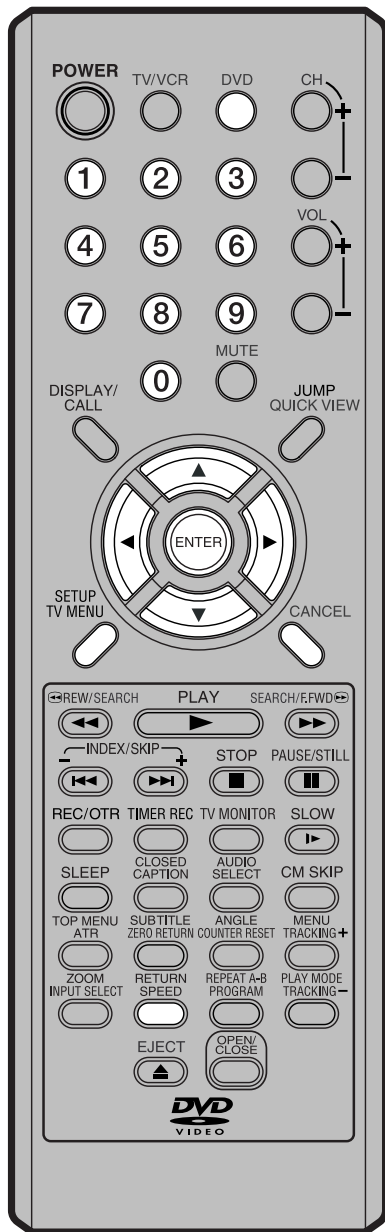

NOTE:

Do not forget the password. If you forget the password, contact the dealer that you purchased the unit from.

1 Press **DVD** to select DVD mode. Press **SETUP/TV MENU** in the stop mode or No Disc. Press **◀** or **▶** to select option. Then press **▼** or **ENTER**.

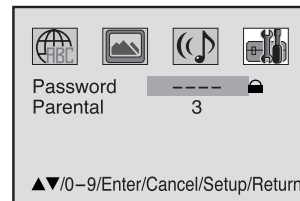

2 Press **Number buttons (0-9)** to enter the password you have stored.

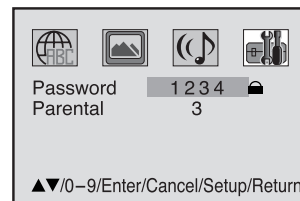

- If you input a wrong number, press **CANCEL**.

3 Press **ENTER**. The rating is now unlocked.

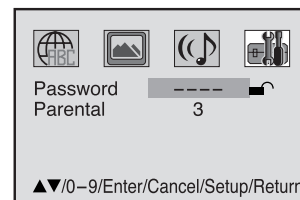

4 Press **▼** to select "Parental", then press **◀** or **▶** to change the parental level.

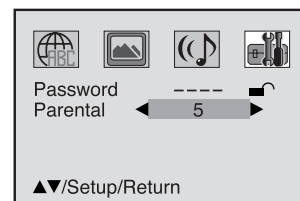

5 Press **▲** to select "Password", then press **Number buttons (0-9)** to enter the password.

NOTE: You can change the password at this time if you want.

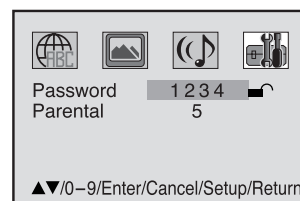

6 Press **ENTER**. The parental level is changed and locked.

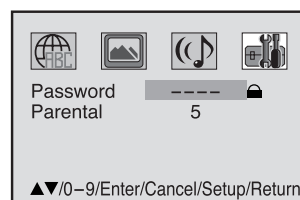

7 Press **SETUP/TV MENU** or **RETURN** to remove the menu screen.



Temporary disabling of rating level by DVD disc

Depending on the DVD disc, the disc may try to temporarily cancel the rating level that you have set. It is up to you to decide whether to cancel the rating level or not.

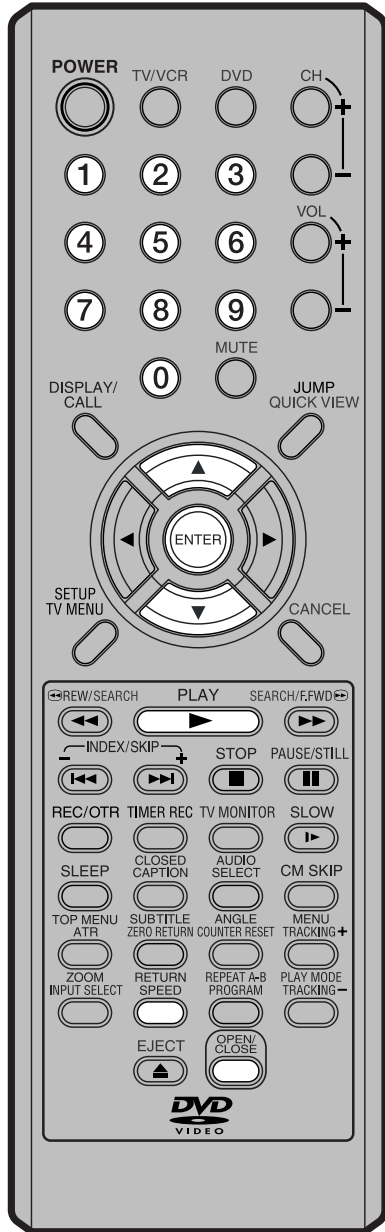

- 1 Load a DVD disc and press **PLAY** or **OPEN/CLOSE** (see page 44).

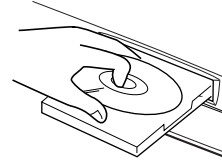

- 2 If the DVD disc has been designed to temporarily cancel the rating level, the screen which follows the "Reading" screen will change, depending on which disc is played. If you select "YES" with pressing **ENTER**, "Your disc exceeds the parental control level 1." (e.g.) screen will then appear.

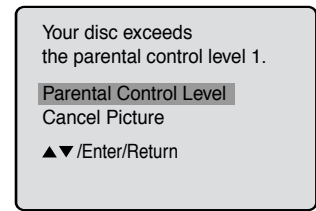

- 3 If you wish to cancel the set rating level temporarily, select "Parental Control Level" with **▲** or **▼**, then press **ENTER**. If the 4-digits password at step 3 on page 55 has been set, the password entering screen will appear as shown in step 4 below.

Alternatively, if the password has not been set, playback will commence. If you don't know (or have forgotten) the password, select "Cancel Picture".

The setting screen will disappear. Press **OPEN/CLOSE** to remove the disc.

- 4 Enter the password with **Number buttons (0-9)**. Then press **ENTER**.

- If you interrupt the entering, press **RETURN**.

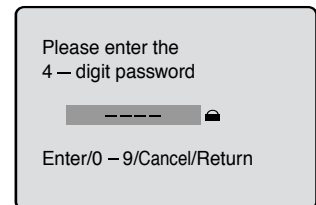

- 5 Playback will commence if the entered password was correct.

NOTE:

This temporary cancellation of the rating level will be kept until the disc is ejected. When the disc is ejected, the original rating level will be set again automatically.

Setting the language

You can select the language of the disc menu messages of DVDs. The same language can always be selected even if you replace the disc or turn the power off.

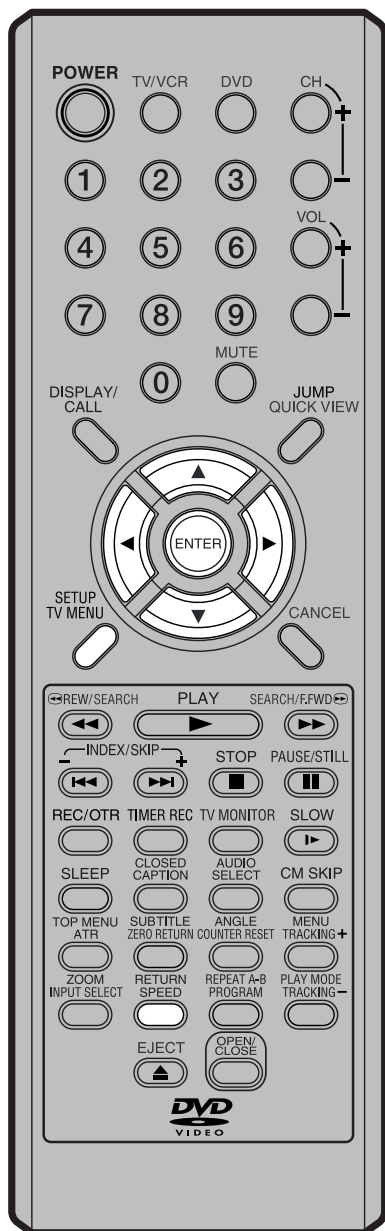

- 1 Press **SETUP/TV MENU** in the stop mode.
Press ◀ or ▶ to select option.

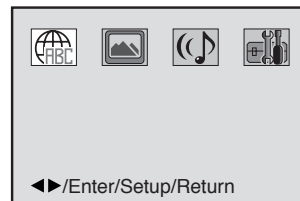

- 2 Press ▼ or **ENTER**.
Then press ▲ or ▼ to select desired option.

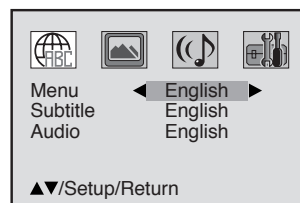

- 3 Press ◀ or ▶ to select your desired language (e.g. English).

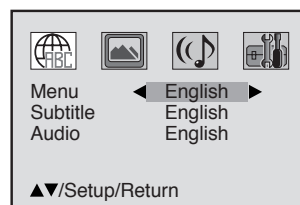

English, Francais, Espanol:

The selected language will be heard or seen.

Other:

Other language can be selected (see the "Language code list" on page 59).

Off: (Subtitle)

Subtitles do not appear.

Original: (Audio)

The unit will select the first priority language of each disc.

- 4 Press **SETUP/TV MENU** or **RETURN** to remove the menu screen.

NOTE:

If the selected language is not recorded on the disc, the first priority Menu language is selected.



Language code list

Enter the appropriate code number for the initial settings "Menu", "Subtitle" and/or "Audio" (see page 58).

Language	Name Code	Language	Name Code	Language	Name Code	Language	Name Code
Abkhazian	1112	Fiji	1620	Lingala	2224	Singhalese	2919
Afar	1111	Finnish	1619	Lithuanian	2230	Slovak	2921
Afrikaans	1116	French	1628	Macedonian	2321	Slovenian	2922
Albanian	2927	Frisian	1635	Malagasy	2317	Somali	2925
Amharic	1123	Galician	1722	Malay	2329	Spanish	1529
Arabic	1128	Georgian	2111	Malayalam	2322	Sundanese	2931
Armenian	1835	German	1415	Maltese	2330	Swahili	2933
Assamese	1129	Greek	1522	Maori	2319	Swedish	2932
Aymara	1135	Greenlandic	2122	Marathi	2328	Tagalog	3022
Azerbaijani	1136	Guarani	1724	Moldavian	2325	Tajik	3017
Bashkir	1211	Gujarati	1731	Mongolian	2324	Tamil	3011
Basque	1531	Hausa	1811	Nauru	2411	Tatar	3030
Bengali; Bangla	1224	Hebrew	1933	Nepali	2415	Telugu	3015
Bhutani	1436	Hindi	1819	Norwegian	2425	Thai	3018
Bihari	1218	Hungarian	1831	Oriya	2528	Tibetan	1225
Breton	1228	Icelandic	1929	Panjabi	2611	Tigrinya	3019
Bulgarian	1217	Indonesian	1924	Pashto, Pushto	2629	Tonga	3025
Burmese	2335	Interlingua	1911	Persian	1611	Turkish	3028
Byelorussian	1215	Irish	1711	Polish	2622	Turkmen	3021
Cambodian	2123	Italian	1930	Portuguese	2630	Twi	3033
Catalan	1311	Japanese	2011	Quechua	2731	Ukrainian	3121
Chinese	3618	Javanese	2033	Rhaeto-Romance	2823	Urdu	3128
Corsican	1325	Kannada	2124	Romanian	2825	Uzbek	3136
Croatian	1828	Kashmiri	2129	Russian	2831	Vietnamese	3219
Czech	1329	Kazakh	2121	Samoan	2923	Volapük	3225
Danish	1411	Kirghiz	2135	Sanskrit	2911	Welsh	1335
Dutch	2422	Korean	2125	Scots Gaelic	1714	Wolof	3325
English	1524	Kurdish	2131	Serbian	2928	Xhosa	3418
Esperanto	1525	Laothian	2225	Serbo-Croatian	2918	Yiddish	2019
Estonian	1530	Latin	2211	Shona	2924	Yoruba	3525
Faroese	1625	Latvian, Lettish	2232	Sindhi	2914	Zulu	3631





Problems and troubleshooting

Use the following check list for troubleshooting when you have problems with your unit. Consult your local dealer or service outlet if problems persist.

Be sure all connections are properly made when using with other units.

SYMPTOMS	CAUSE	POSSIBLE SOLUTIONS	PAGE
POWER			
No power.	The AC power cord is not connected.	Connect the AC power cord to the AC outlet.	5
Although the power is on, the unit does not operate.	Cassette or disc is not inserted.	Insert a video cassette or disc.	32, 44
	The TIMER REC buttons are depressed.	Press the TIMER REC buttons.	39
TV BROADCAST RECEPTION			
Poor or no picture.	TV station experiencing problems.	Try another channel.	19
	Picture control is not adjusted.	Check picture control adjustments.	29
	Possible local interference.	Check for source of reception disturbance.	62
	Antenna or Cable TV connector is not connected or possible local interference.	Check VHF/UHF antenna or Cable TV connection, reposition or rotate antenna.	11, 12
Poor or no color.	TV station experiencing problems.	Try another channel.	19
	Picture control is not adjusted.	Check picture control adjustments.	29
	Possible local interference.	Check for source of reception disturbance.	62
	Antenna or Cable TV connector is not connected or possible local interference.	Check VHF/UHF antenna or Cable TV connection, reposition or rotate antenna.	11, 12
Picture wobbles or drifts.	TV station experiencing problems.	Try another channel.	19
	Antenna or Cable TV connector is not connected or possible local interference.	Check VHF/UHF antenna or Cable TV connection, reposition or rotate antenna.	11, 12
	Cable TV channel is scrambled.	Try another channel.	19
No Cable TV reception.	Cable TV connector is not connected.	Check all Cable TV connections.	12
	TV/CABLE Mode menu option is set to the TV mode.	Set the TV/CABLE Menu option to the CABLE mode.	22
	Cable TV service interrupted.	Contact your Cable TV company.	12
No reception above channel 13.	TV/CABLE Mode menu option is not set to the appropriate mode.	Make sure TV/CABLE menu option is in the appropriate mode.	22
	UHF antenna is not connected.	Check UHF antenna.	11
Poor or no sound.	TV station experiencing problems.	Try another channel.	19
	Antenna (CABLE) connector is not connected or possible local interference.	Check Cable TV connection or VHF/UHF antenna, reposition or rotate antenna.	11, 12
	Possible local interference.	Check for source of reception disturbance.	62
	The MUTE button is depressed.	Check the MUTE button has not been pressed.	20
TV shuts off.	TV station stopped broadcasting.	Tune new channel.	19
	Sleep timer is set.	Set Sleep Timer to "0".	20
Closed caption is not activated.	TV station experiencing problems or program tuned is not closed captions.	Try another channel.	19
	TV signal is weak.	Check Cable TV connection of VHF/UHF antenna, reposition or rotate antenna.	11, 12
	The CLOSED CAPTION button is not depressed.	Press the CLOSED CAPTION button to turn on the closed caption.	21
VCR			
TV recording does not work.	The video cassette's erase prevention tab is broken off.	Place a piece of adhesive tape over the hole.	32
Timer recording does not work.	The time is not set correctly.	Reset the present time.	16~18
	The recording start/end time is not set correctly.	Reset the start/end time.	39
Noise bars appear on the screen.	Tape is old or worn.	Replace the tape.	-
	Tracking adjustment is beyond range of automatic tracking circuit.	Adjust tracking manually using the TRACKING +/- buttons on the remote control.	34
	Video heads are dirty.	Clean the video heads.	61



Problems and troubleshooting (continued) / Video head cleaning

SYMPTOMS	CAUSE	POSSIBLE SOLUTIONS	PAGE
DVD			
The playback picture has occasional distortion.	The disc is dirty.	Eject the disc and clean it.	42
	It is in fast forward or fast reverse playback.	Some times a small amount of picture distortion may appear. This is not a malfunction.	–
The unit does not start playback.	No disc is inserted.	Insert a disc.	44
	An unplayable disc is inserted.	Insert a playable disc (Check the disc type and color system).	42
	The disc is placed upside down.	Place the disc with the playback side down.	44
	The disc is not placed within the guide.	Place the disc correctly inside the guide on the disc tray.	44
	The disc is dirty.	Clean the disc.	42
	The parental lock function is set.	Cancel the parental lock function or change the parental lock level.	55, 56
Playback does not follow the course of the disc's program.	It is in the mode of repeat playback, memory playback, etc.	These operations may prevent a proper progress of the contents.	–
 appears on the screen.	The function is prohibited with the unit or the disc.	–	44
REMOTE CONTROL			
Remote control does not operate.	The remote control is not aimed at the sensor.	Aim the remote control at the remote sensor.	10
	Distance is too far or too much light in the room.	Operate within 5 m or reduce the light of the room.	10
	There is an obstacle in the path of the beam.	Clear the path of the beam.	10
	The batteries are weak.	Replace the batteries.	10
	The batteries are not inserted correctly.	Insert correctly.	10

Video head cleaning

Video head clogging

The video heads are the means by which the unit reads the picture from the tape during playback. In the unlikely event that the heads become dirty enough to be clogged, no picture will be played back. This can easily be determined if, during playback of a known good tape, there is good sound, but no picture (picture is extremely snowy). If this is the case, have the unit checked by qualified service personnel.



Good Picture



Snowy Picture

- NOTES:**
- DO NOT ATTEMPT TO CLEAN THE VIDEO HEADS OR SERVICE THE UNIT BY REMOVING THE REAR COVER.
 - Video heads may eventually wear out and should be replaced when they fail to produce clear pictures.
 - To help prevent video head clogging, use only good quality VHS tapes. Discard worn out tapes.

DEGAUSSING SYSTEM

This television has a degaussing circuit that will clear up color distortions on the TV screen that are caused by any excess magnetism which happens to get too close to the TV. This circuit is designed to operate once when the set is first plugged in. If minor color distortions are seen in some locations on the screen, please unplug the TV for approximately 15 minutes. When the TV is plugged back in, the degaussing circuit will operate once to clear up any color distortions. Repeat this procedure any time the TV screen is accidentally magnetized, or when the TV is moved or relocated.



Reception disturbances

Most types of television interference can be remedied by adjusting the height and position of the VHF/UHF antenna. Outdoor antennas are recommended for best results. The most common types of television interference are shown below. If one of these symptoms appear when the unit is connected to a Cable TV system, the disturbance may be caused by the local Cable TV company broadcast.

IGNITION

Black spots or horizontal streaks may appear, the picture may flutter or drift. Usually caused by interference from automobile ignition systems, neon lamps or AC powered tools and appliances such as drills or hair dryers.



GHOSTS

Ghosts are caused by the television signal following two paths. One is the direct path and the other is reflected by tall buildings, hills or other large objects. Changing the direction or position of the antenna may improve the reception.



SNOW

If the unit is located far from the TV station, in a fringe reception area where the signal is weak, small dots may appear in the picture. If the signal is extremely weak, the installation of a larger external antenna may be necessary.



RADIO FREQUENCY INTERFERENCE (RFI)

Caused by two-way radios, this type of interference produces moving ripples or diagonal streaks in the picture. Some cases may cause a loss of contrast in the picture. Changing the direction and position of the antenna or installing an RFI filter may improve the picture.



PICTURE SIZE VARIATION

A slight picture size variation is normal when you adjust the CONTRAST or BRIGHTNESS settings.



CARE AND MAINTENANCE

To prevent fire or shock hazard, disconnect the unit from the power source before cleaning. The finish on the cabinet may be cleaned with mild soap and a soft, damp cloth and cared for as other furniture. Use caution when cleaning or wiping the plastic parts.





J5V40401A SH 06/02

Printed in Thailand



Specifications

GENERAL

Power supply: AC 120V 60Hz
 Power consumption: Operation: 110 W
 Stand by: 4 W
 Weight: 59.5 lbs (27.0 kg)
 Dimensions: Width : 22-9/16 inches (573 mm)
 Height: 20-3/8 inches (517 mm)
 Depth : 19-1/8 inches (485 mm)

TELEVISION

Picture tube: 20 inches (508 mm diagonal)
 Tuner type: 181 Channel Freq. Synthesized
 Receiving channels: VHF 2-13
 UHF 14-69
 CABLE TV 14-36 (A)-(W)
 37-59 (AA)-(WW)
 60-85 (AAA)-(ZZZ)
 86-94 (86)-(94)
 95-99 (A-5)-(A-1)
 100-125 (100)-(125)
 01 (5A)
 Antenna input: VHF/UHF In 75 ohms coaxial
 Speakers: 1-13/16 inches (46 mm) x 3-7/8 inches (99 mm), 8 ohms x 2
 Audio output power: 1.0 W + 1.0 W

VCR section

Video head: 4 Rotary Heads
 Audio track: Hi-Fi Sound - 2 Tracks / MONO Sound - 1 Track
 F.FWD/REW Time at 25°C (77°F): Approx. 1 minute and 48 seconds (with T-120 Cassette Tape)

DVD section

Signal system: NTSC
 Applicable disc: DVD (12 cm, 8 cm), CD (12 cm, 8 cm)
 Input: Video : (RCA) 1 Vp-p/75 ohms
 Audio : (RCA) -8 dBm/50K ohms
 Output: Digital Audio : 0.5 Vp-p/75 ohms
 Pickup: CD : Wavelength: 780 - 790 nm
 Maximum output power: 7 mW
 DVD : Wavelength: 652 - 662 nm
 Maximum output power: 5 mW

ACCESSORY: Remote control

Designs and specifications are subject to change without notice.

Memorex®

FOR ADDITIONAL SET-UP OR OPERATING ASSISTANCE, PLEASE VISIT OUR WEBSITE AT
 WWW.MEMOREXELECTRONICS.COM OR CONTACT CUSTOMER SERVICE AT (954) 660-7100.
 PLEASE KEEP ALL PACKAGING MATERIAL FOR AT LEAST 90 DAYS IN CASE YOU NEED TO RETURN THIS
 PRODUCT TO YOUR PLACE OF PURCHASE OR MEMOREX.
 FOR PARTS AND ACCESSORIES, CONTACT FOX INTERNATIONAL AT 1-800-321-6993.

63



 J5V40401A SH 06/02

Memcorp Inc.
 Weston, FL 33331
 Printed in Thailand
 Visit our website at www.memorexelectronics.com



Free Manuals Download Website

<http://myh66.com>

<http://usermanuals.us>

<http://www.somanuals.com>

<http://www.4manuals.cc>

<http://www.manual-lib.com>

<http://www.404manual.com>

<http://www.luxmanual.com>

<http://aubethermostatmanual.com>

Golf course search by state

<http://golfingnear.com>

Email search by domain

<http://emailbydomain.com>

Auto manuals search

<http://auto.somanuals.com>

TV manuals search

<http://tv.somanuals.com>