



Is it live or is it Memorex?TM

MVUC821

User's Guide

8" TFT DVD Player
with AM/FM Radio



**Before operating this product,
please read these instructions completely.**

CONTENTS

Contents	1	• Language Setup Menu	37
Important Safety Instructions	2	• Video Setup Menu	38
Precautions	5	• Speaker Setup Menu.....	38
Power Source	5	• TVG (TV Guardian).....	39
Installation	6	Basic Operation	42
Location of Controls	7	• Resume	42
• Front	7	• Volume.....	42
• Rear	8	• Mute.....	42
• Remote	9	• EQ/Bass.....	42
Remote Control	10	• Playback of a DVD	43
• Battery Installation	10	• Skip.....	44
• Effective Distance of the Remote Control Transmitter	10	• Fast Search	44
Antenna Connections	11	• Zoom.....	44
Connection	12	• Pause.....	44
• Connection Using A/V Cables	12	• Title/Chapter/Time Search	45
Adjusting the Screen	12	• Repeat Playback	45
About Discs	13	• A-B Repeat Playback	45
Setting the Time	15	• Title Menu	46
Setting the Timer	16	• Subtitle Menu.....	46
Radio Operation	17	• DVD Menu	46
• Tuning Radio Stations	17	• OSD/Info.....	46
• Setting and Recalling Radio Presets.....	18	• Adjusting the Picture.....	46
Closed Captions	19	• Angle.....	46
Setting the DTV Menus	20	• Programmed Playback	47
• Setting the Closed Captions (ATSC).....	20	CD Operation	48
• Setting the Language	21	• Playback of a CD.....	48
• Default	21	• Pause.....	48
• Setting the Time Zone and the Daylight Savings Time	22	• Selecting Tracks/Files Using the Direct Channel Selection/Number Buttons (0-9).....	48
• Setting Channels Into Memory	23	• Selecting Tracks/Files Using the NEXT/ PREV Buttons.....	48
• Manual Program	24	• Forward/Reverse Search.....	49
• Setting the DTV Channel List.....	25	• Repeat One/All Play	49
• Editing the Favorite List.....	25	• OSD/Info	49
• Setting the Favorite Channel List.....	26	• Adjusting the Picture.....	49
• Setting the Video	26	MP3 Operation	50
TV Parental Control	27	• Playback of an MP3 Disc	50
• Parental Control Set-up	27	• Pause.....	50
• TV Parental Guide Set-up	28	• Selecting Tracks/Files Using the NEXT/ PREV Buttons.....	51
• MPAA Set-up	29	• Forward/Reverse Search.....	51
• Canadian English/French Set-up.....	30	• Repeat One/All Play	51
• Changing the password.....	31	• OSD/Info	51
• Downloadable RRT.....	31	• Adjusting the Picture.....	51
DTV Operation	32	Picture CD Operation	52
• OSD/Info	33	• Adjusting the Picture.....	52
• Volume.....	33	AV Function	53
• Mute.....	33	• Playback of a Unit Connected to the AV Jacks	53
• EQ/Bass.....	33	• Adjusting the Picture.....	53
• Guide	34	Troubleshooting Guide	54
• Audio.....	34	Care and Maintenance	56
• Scale Mode.....	34	Specifications	57
• Adjusting the Picture.....	34		
DVD Setup Menu	35		
• General Setup Menu	36		

IMPORTANT SAFETY INSTRUCTIONS

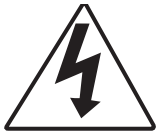

CAUTION

**RISK OF ELECTRIC SHOCK
DO NOT OPEN**



The lightning flash with arrowhead symbol within an equilateral triangle is intended to alert the user to the presence of uninsulated dangerous voltage within the product's enclosure that may be of sufficient magnitude to constitute a risk of electric shock to persons.



The exclamation point within an equilateral triangle is intended to alert the user to the presence of important operating and maintenance (servicing) instructions in the literature accompanying the appliance.

CAUTION: TO REDUCE THE RISK OF ELECTRIC SHOCK, DO NOT REMOVE COVER (OR BACK). NO USER-SERVICEABLE PARTS INSIDE. REFER SERVICING TO QUALIFIED SERVICE PERSONNEL. This Caution Marking with Rating Label is located at the rear enclosure of the unit.



The symbol for class II
(Double Insulation)

FCC NOTICE: This equipment has been tested and found to comply with the limits for a Class B digital device, pursuant to part 15 of the FCC Rules. These limits are designed to provide reasonable protection against harmful interference in a residential installation. This equipment generates, uses and can radiate radio frequency energy and, if not installed and used in accordance with the instructions, may cause harmful interference to radio communications.

However, there is no guarantee that interference will not occur in a particular installation. If this equipment does cause harmful interference to radio or television reception, which can be determined by turning the equipment off and on, the user is encouraged to try to correct the interference by one or more of the following measures:

- Reorient or relocate the receiving antenna.
- Increase the separation between the equipment and receiver.
- Connect the equipment into an outlet on a circuit different from that to which the receiver is connected.
- Consult the dealer or an experienced radio/TV technician for help.

FCC CAUTION: To assure continued compliance, follow the attached installation instructions and use only shielded cables when connecting to other devices. Also, any changes or modifications not expressly approved by the party responsible for compliance could void the user's authority to operate the equipment.

This Class B digital apparatus complies with Canadian ICES-003. / Cet appareil numérique de la classe B est conforme à la norme NMB-003 du Canada.

CAUTION:

THIS DIGITAL VIDEO DISC PLAYER EMPLOYS A LASER SYSTEM.

TO ENSURE PROPER USE OF THIS PRODUCT, PLEASE READ THIS OWNER'S MANUAL CAREFULLY AND RETAIN FOR FUTURE REFERENCE. SHOULD THE UNIT REQUIRE MAINTENANCE, CONTACT AN AUTHORIZED SERVICE LOCATION (SEE SERVICE PROCEDURE).

USE OF CONTROLS, ADJUSTMENTS OR THE PERFORMANCE OF PROCEDURES OTHER THAN THOSE SPECIFIED HEREIN MAY RESULT IN HAZARDOUS RADIATION EXPOSURE.

TO PREVENT DIRECT EXPOSURE TO LASER BEAM, DO NOT TRY TO OPEN THE ENCLOSURE. VISIBLE LASER RADIATION MAY BE PRESENT WHEN THE ENCLOSURE IS OPENED. DO NOT STARE INTO BEAM.

WARNING:

TO REDUCE THE RISK OF FIRE OR ELECTRIC SHOCK, DO NOT EXPOSE THIS PRODUCT TO RAIN OR MOISTURE.

WARNING:

TO REDUCE THE RISK OF FIRE OR ELECTRIC SHOCK, AND ANNOYING INTERFERENCE, USE THE RECOMMENDED ACCESSORIES ONLY.

SURGE PROTECTORS:

It is recommended to use a surge protector for AC connection. Lightning and power surges ARE NOT covered under warranty for this product.

ATTENTION:

POUR ÉVITER LES CHOC ÉLECTRIQUES, INTRODUIRE LA LAME LA PLUS LARGE DE LA FICHE DANS LA BORNE CORRESPONDANTE DE LA PRISES ET POUSSER JUSQU'AU FOND.

Manufactured under license from Dolby Laboratories.
"Dolby" and the double-D symbol are trademarks of Dolby Laboratories.

IMPORTANT SAFETY INSTRUCTIONS

Before using the unit, be sure to read all operating instructions carefully. Please note that these are general precautions and may not pertain to your unit. For example, this unit may not have the capability to be connected to an outdoor antenna.

1. READ INSTRUCTIONS

All the safety and operating instructions should be read before the product is operated.

2. RETAIN INSTRUCTIONS

The safety and operating instructions should be retained for future reference.

3. HEED WARNINGS

All warnings on the product and in the operating instructions should be adhered to.

4. FOLLOW INSTRUCTIONS

All operating and use instructions should be followed.

5. CLEANING

Unplug this product from the wall outlet before cleaning. Do not use liquid cleaners or aerosol cleaners. Use a dry cloth for cleaning.

6. ATTACHMENTS

Do not use attachments not recommended by the product's manufacturer as they may cause hazards.

7. WATER AND MOISTURE

Do not use this product near water—for example: near a bathtub, washbowl, kitchen sink or laundry tub; in a wet basement; or near a swimming pool.

8. ACCESSORIES

Do not place this product on an unstable cart, stand, tripod, bracket or table. The product may fall, causing serious injury and serious damage to the product. Use only with a cart, stand, tripod, bracket or table recommended by the manufacturer or sold with the product. Any mounting of the product should follow the manufacturer's instructions, and should use a mounting accessory recommended by the manufacturer.

8A. An appliance and cart combination should be moved with care. Quick stops, excessive force and uneven surfaces may cause the appliance and cart combination to overturn.

9. VENTILATION

Slots and openings in the cabinet and in the back or bottom are provided for ventilation, to ensure reliable operation of the product and to protect it from overheating. These openings must not be blocked or covered. The openings should never be blocked by placing the product on a bed, sofa, rug or other similar surface. This product should never be placed near or over a radiator or heat source. This product should not be placed in a built-in installation such as a bookcase or rack unless proper ventilation is provided or the manufacturer's instructions have been adhered to.

10. POWER SOURCES

This product should be operated only from the type of power source indicated on the marking label. If you are not sure of the type of power supply to your home, consult your appliance dealer or local power company. For products intended to operate from battery power, or other sources, refer to the operating instructions.

11. GROUNDING OR POLARIZATION

This product is equipped with a polarized alternating-current line plug (a plug having one blade wider than the other). This plug will fit into the power outlet only one way. This is a safety feature. If you are unable to insert the plug fully into the outlet, try reversing the plug. If the plug should still fail to fit, contact your electrician to replace your obsolete outlet. Do not defeat the safety purpose of the polarized plug.

12. POWER-CORD PROTECTION

Power-supply cords should be routed so that they are not likely to be walked on or pinched by items placed upon or against them, paying particular attention to cords at plugs, convenience receptacles, and the point where they exit from the appliance.

13. LIGHTNING

To protect your product from a lightning storm, or when it is left unattended and unused for long periods of time, unplug it from the wall outlet and disconnect the antenna or cable system. This will prevent damage to the product due to lightning and power-line surges.

14. POWER LINES

An outside antenna system should not be located in the vicinity of overhead power lines or other electric light or power circuits, or where it can fall into such power lines or circuits. When installing an outside antenna system, extreme care should be taken to keep from touching such power lines or circuits as contact with them might be fatal.

15. OVERLOADING

Do not overload wall outlets and extension cords as this can result in a risk of fire or electric shock.

PORTABLE CART WARNING
(symbol provided by RETAC)



S3126A

IMPORTANT SAFETY INSTRUCTIONS

16. OBJECT AND LIQUID ENTRY

Never push objects of any kind into this product through openings as they may touch dangerous voltage points or short out parts that could result in fire or electric shock. Never spill or spray any type of liquid on the product.

17. OUTDOOR ANTENNA GROUNDING

If an outside antenna is connected to the product, be sure the antenna system is grounded so as to provide some protection against voltage surges and built-up static charges. Section 810 of the National Electric Code, ANSI/NFPA 70, provides information with respect to proper grounding of the mast and supporting structure, grounding of the lead-in wire to an antenna discharge product, size of grounding conductors, location of antenna discharge product, connection to grounding electrodes and requirements for grounding electrodes.

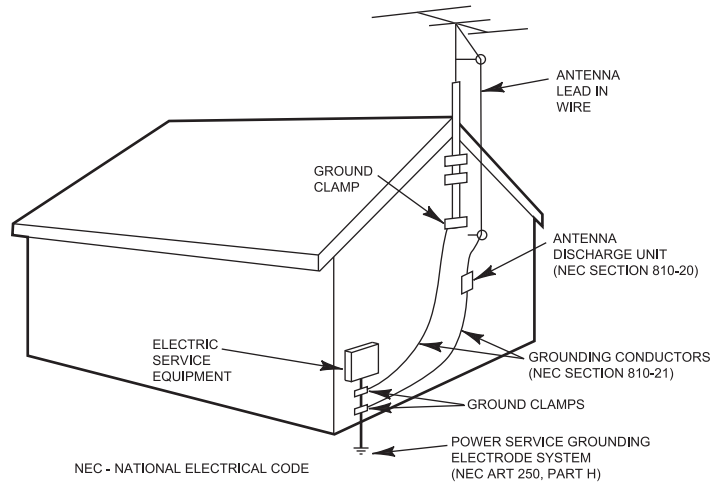

EXAMPLE OF ANTENNA GROUNDING AS PER NATIONAL ELECTRICAL CODE

18. SERVICING

Do not attempt to service this product yourself as opening or removing covers may expose you to dangerous voltage or other hazards. Refer all servicing to qualified service personnel.

19. REPLACEMENT PARTS

When replacement parts are required, be sure the service technician uses replacement parts specified by the manufacturer or those that have the same characteristics as the original part. Unauthorized substitutions may result in fire, electric shock or other hazards.

20. SAFETY CHECK

Upon completion of any service or repairs to this product, ask the service technician to perform safety checks to determine that the product is in proper operating condition.

21. WALL OR CEILING MOUNTING

The product should be mounted to a wall or ceiling only as recommended by the manufacturer.

22. DAMAGE REQUIRING SERVICE

Unplug the product from the wall outlet and refer servicing to qualified service personnel under the following conditions:

- When the power-supply cord or plug is damaged.
- If liquid has been spilled or objects have fallen into the product.
- If the product has been exposed to rain or water.
- If the product does not operate normally by following the operating instructions. Adjust only those controls that are covered by the operating instructions, as an adjustment of other controls may result in damage and will often require extensive work by a qualified technician to restore the product to its normal operation.
- If the product has been dropped or the cabinet has been damaged.
- When the product exhibits a distinct change in performance—this indicates a need for service.

23. HEAT

The product should be situated away from heat sources such as radiators, heat registers, stoves or other products (including amplifiers) that produce heat.

24. NOTE TO CATV SYSTEM INSTALLER

This reminder is provided to call the CATV system installer's attention to Article 820-40 of the NEC that provides guidelines for proper grounding and, in particular, specifies that the cable ground shall be connected to the grounding system of the building, as close to the point of cable entry as practical.

PRECAUTIONS

NOTES ON HANDLING:

- When shipping this unit, always use the original shipping carton and packing materials. For maximum protection, repack the unit as it was originally packed at the factory.
- Do not use volatile liquids, such as insect spray, near the player. Do not leave rubber or plastic products in contact with the DVD player for a long time. They will leave marks on the finish.
- The top and rear panels of the player may become warm after a long period of use. This is normal and not a malfunction.
- When the player is not in use, be sure to remove the disc and turn off the power.
- If you do not use the player for a long period, the unit may not function properly in the future. Turn on and use the player occasionally.

NOTES ON LOCATING THE UNIT:

- When you place this unit near another TV or a radio, the playback picture may become poor and the sound may be distorted. In this case, move the player away from the other TV or the radio.

NOTES ON CLEANING:

Use a soft, dry cloth for cleaning.

- For stubborn dirt, soak the cloth in a weak detergent solution, wring well and wipe. Use a dry cloth to wipe it dry. Do not use any type of solvent, such as thinner and benzene, as they may damage the surface of the player.
- If you use a chemical-saturated cloth to clean the unit, follow that product's instructions.

Warning: Cleaning and adjustment of lenses and/or other components of playback mechanism should be performed by a qualified service technician.

TO OBTAIN A CLEAR PICTURE:

The DVD player is a high technology, precision device. If the optical pick-up lens and disc drive parts are dirty or worn down, the picture quality becomes poor. To obtain a clear picture, we recommend regular inspection and maintenance (cleaning or parts replacement) every 1,000 hours of use depending on the operating environment. For details, contact your nearest dealer.

NOTES ON MOISTURE CONDENSATION:

Moisture condensation damages this unit. Please read the following carefully.

- Moisture condensation occurs, for example, when you pour a cold drink into a glass on a warm day. Drops of water form on the outside of the glass. In the same way, moisture may condense on the optical pick-up lens inside this unit, one of the most crucial internal parts of the player.

Moisture condensation occurs during the following cases:

- When you bring this unit directly from a cold place to a warm place.
- When you use this unit in a room where you just turned on the heater, or a place where the cold wind from the air conditioner directly hits the unit.
- In summer, when you use this unit in a hot and humid place just after you moved this unit from an air conditioned room.
- When you use this unit in a humid place.

Do not use this unit when moisture condensation may occur.

- If you use this unit in such a situation, it may damage discs and internal parts. Remove the disc, connect the power cord of this unit to the wall outlet, turn on this unit and leave it "ON" for two or three hours. After two or three hours, this unit will have warmed up and evaporated any moisture. Keep this unit connected to the wall outlet and moisture condensation will seldom occur.

POWER SOURCE

AC CONNECTION

Insert the small end of the AC adapter into the jack on the rear of the unit. Insert the other end (with the 2 blades) into a conveniently located AC outlet having 120V AC, 60Hz.

AC ADAPTER SPECIFICATIONS:

DC 12V 

NOTES:

- To disconnect the AC adapter, remove it from the DC IN jack as well as from the AC outlet.
- Use the enclosed AC adapter for this product only.

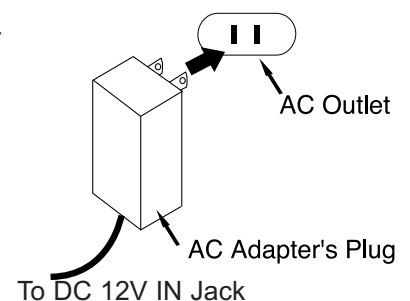

INSTALLATION

INSTALLING THE UNIT UNDER A CABINET

The suggested mounting position of the unit is under a wall cabinet, but it can be installed under many areas. There should be at least 2-1/2" distance between the unit and the wall to allow for connections and ventilation.

IMPORTANT NOTES:

- Since the unit is rather heavy, be careful while mounting.
 - To reduce risk of fire, do not place any heating or cooking appliance beneath the unit, especially while the LCD screen is open.
 - Mount the unit so that its AC adapter can be plugged directly to a wall outlet.
 - Do not use a converter or extension cord.
- Install the unit as far as possible from a source of noise; i.e., a refrigerator, microwave oven, fluorescent lamp, etc.
 - Please allow ample space on each side for the speakers.
 - Keep unit away when drilling to avoid getting wood shavings in the ventilation holes.
 - Drill from bottom up if there is not enough room in the cabinet.

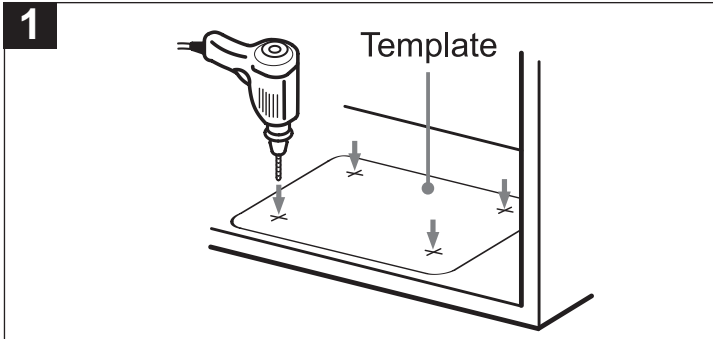

Cut the template and place inside the cabinet with the template border marked "FRONT" along the front edge of the cabinet, then use adhesive tape to fix the template. Drill four 1/4" diameter holes as shown on the template. Remove template when finished.

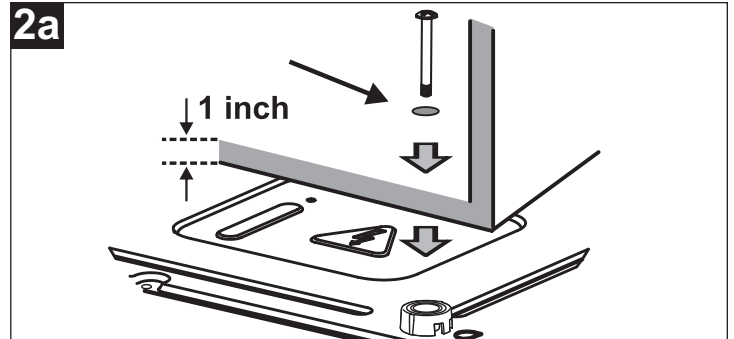

Measure the height of the cabinet bottom and overhang. If the cabinet bottom is 1" thick, then the spacers are not necessary, use screws only as shown.

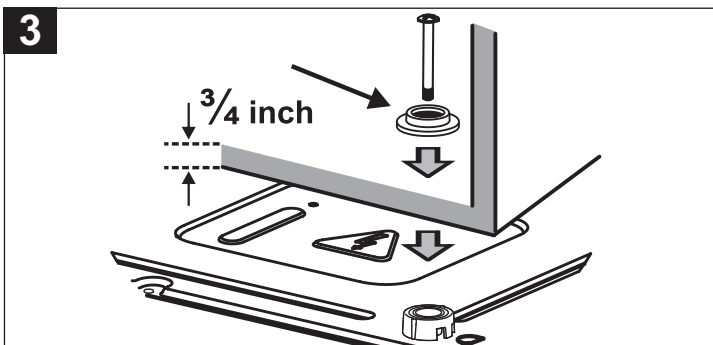

If the cabinet bottom is 3/4" thick, then use the spacers turned upwards as shown.

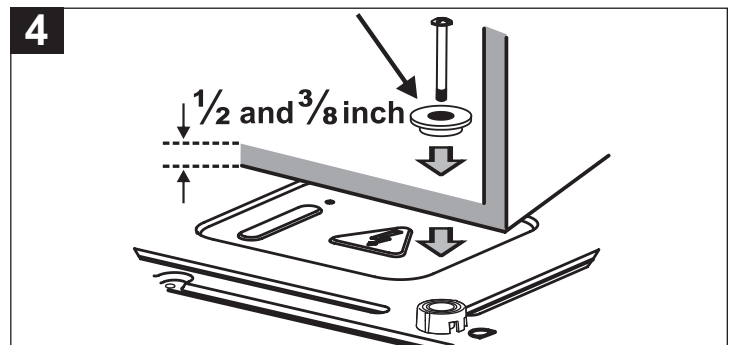

If the cabinet bottom is 3/8" to 1/2" thick, then use the spacers turned downwards as shown.

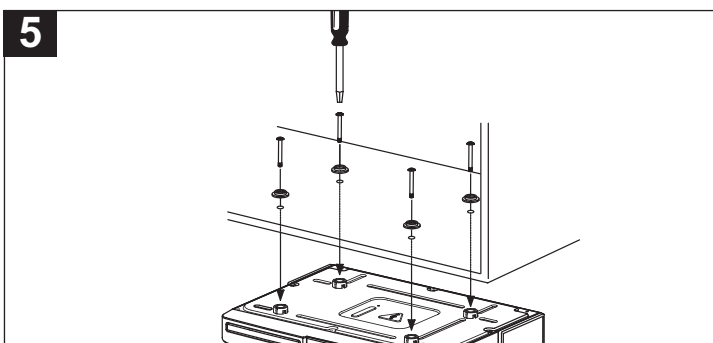

With a screwdriver (not an electric screwdriver or drill), fasten the four screws into the spacer holder holes (or fasten the screw to your set if spacers were not needed). Start screwing at two opposite corners of the unit for better support.

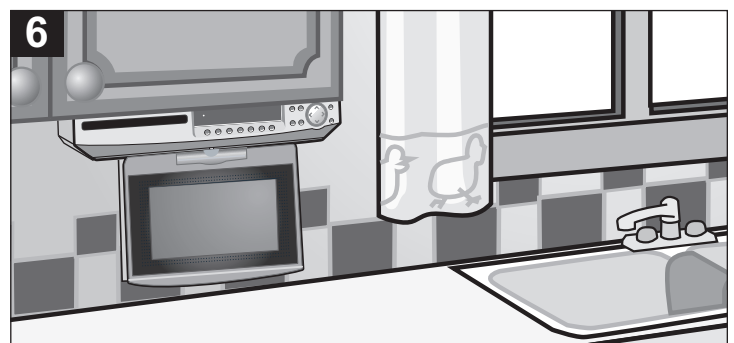

Push the release latch, pull down the screen to a maximum of 180° and rotate.

LOCATION OF CONTROLS

FRONT

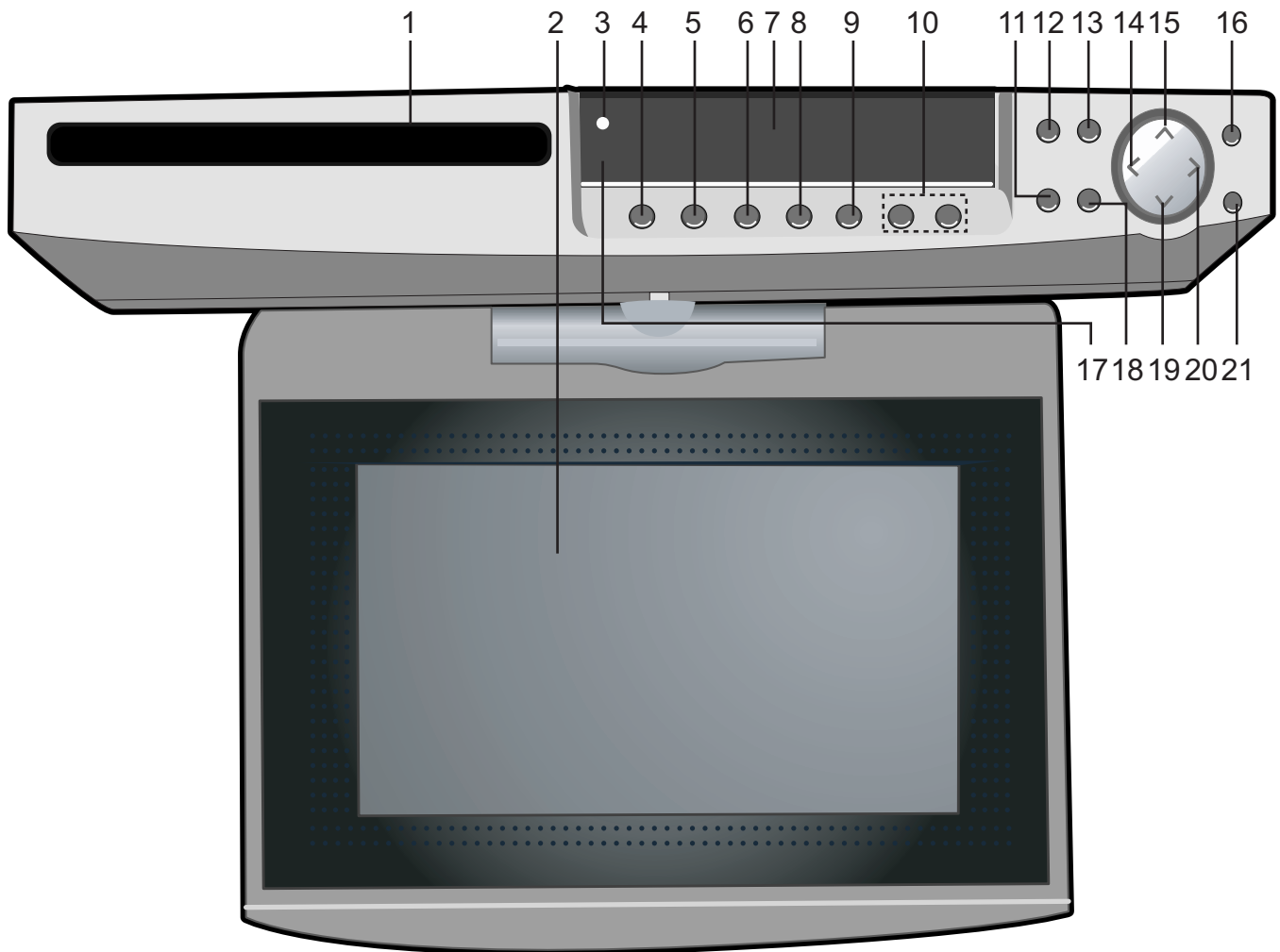

1. Disc Compartment
2. Screen
3. STANDBY Indicator
4. SOURCE Button
5. BAND Button
6. SETUP Button
7. Display
8. EXIT Button
9. MENU Button
10. VOLUME Up/Down Buttons
11. Open/Close Button
12. Play/Pause (▶||) Button
13. Stop (■) Button
14. Navigation ◀/Skip ◀◀ Button
15. Navigation ▲ Button
16. Power Button
17. Remote Sensor
18. CLOCK Button
19. Navigation ▼ Button
20. Navigation ▶/Skip ▶▶ Button
21. TIMER Button

LOCATION OF CONTROLS (CONTINUED)

REAR

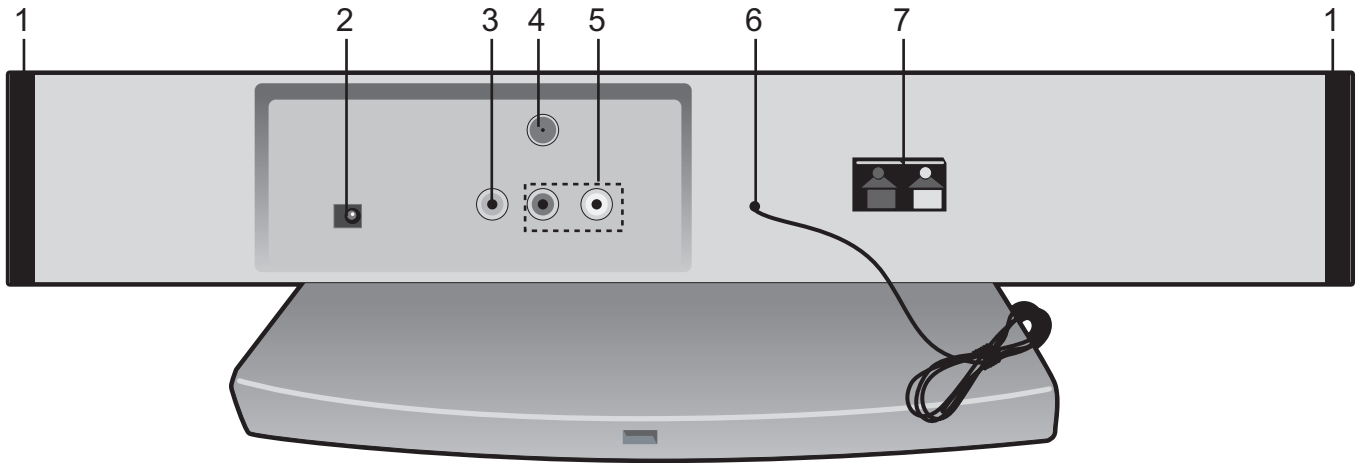

1. Speakers (Sides of Unit)
2. DC 12V Input Jack $\ominus \oplus$
(AC ADAPTER PART NO. 0251-207200-90005*)
3. VIDEO Input Jack
4. ANT INPUT Jack
5. AUDIO Left/Right Input Jack
6. FM Wire Antenna
7. AM Antenna Terminals
(AM LOOP ANTENNA PART NO. 129E-0002711-00*)

SPACER PART NO. 3111-001005-30000*

SCREW PART NO. 0431-150361-10002*

***Consumer Replaceable Part
(See page 55 to order.)**

LOCATION OF CONTROLS (CONTINUED)

REMOTE

The remote has magnet at the back. It can be placed on the refrigerator or other metal surface so it will not get misplaced.

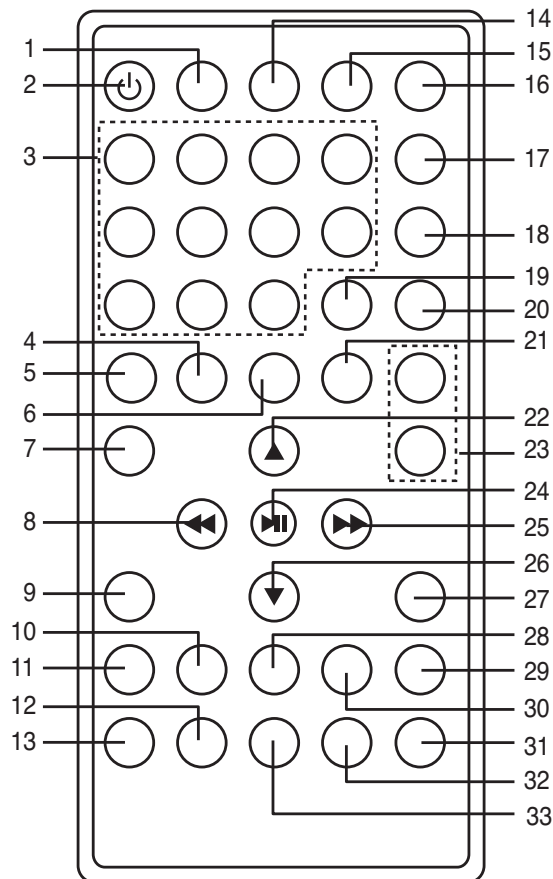

- | | |
|---|-----------------------------------|
| 1. AUX Button | 21. PROGRAM Button |
| 2. Power Button | 22. Navigation ▲ Button |
| 3. Direct Channel Selection/Number (0-9, -) Buttons | 23. VOLUME Up/Down Buttons |
| 4. Repeat A-B Button | 24. ENTER/Play/Pause (▶) Button |
| 5. Channel Up/Skip (▶▶) Button | 25. Navigation ▶/Search ▶▶ Button |
| 6. Repeat Button | 26. Navigation ▼ Button |
| 7. Channel Down/Skip (◀◀) Button | 27. Stop (■) Button |
| 8. Navigation ◀/Search ◀◀ Button | 28. TITLE Button |
| 9. OSD/INFO Button | 29. TIMER Button |
| 10. MENU/GUIDE Button | 30. CLOCK Button |
| 11. SETUP Button | 31. SCALE MODE Button |
| 12. SUBTITLE/CC (Closed Captions) Button | 32. ANGLE Button |
| 13. EXIT/ZOOM button | 33. AUDIO Button |

**REMOTE CONTROL PART
NO. 0861-001000-00100***

***Consumer Replaceable Part
(See page 55 to order.)**

REMOTE CONTROL

BATTERY INSTALLATION

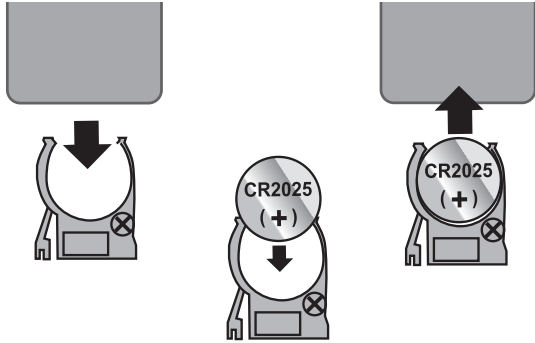

1. Remove the Battery Compartment by pressing in on the tab and pushing out.
2. Install a CR2025 battery, paying attention to the polarity diagram in the Battery Compartment.
3. Replace the Battery Compartment.

BATTERY PRECAUTIONS

Follow these precautions when using a battery in this device:

1. Warning—Danger of explosion if battery is incorrectly replaced. Replace only with the same or equivalent type.
2. Use only the size and type of battery specified.
3. Be sure to follow the correct polarity when installing the battery as indicated next to the battery compartment. A reversed battery may cause damage to the device.
4. If the device is not to be used for a long period of time, remove the battery to prevent damage or injury from possible battery leakage.
5. Do not try to recharge a battery not intended to be recharged; it can overheat and rupture. (Follow battery manufacturer's directions.)

EFFECTIVE DISTANCE OF THE REMOTE CONTROL TRANSMITTER

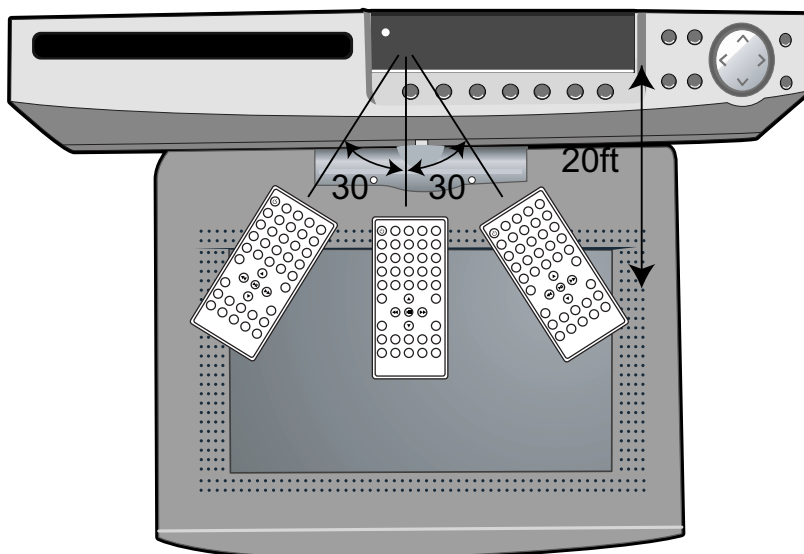

NOTES:

- When there is an obstacle between the unit and the transmitter, the transmitter may not operate.
- When direct sunlight, an incandescent lamp, fluorescent lamp or any other strong light shines on the REMOTE SENSOR of the unit, the remote operation may be unstable.

ANTENNA CONNECTIONS

AM ANTENNA:

Connect the black AM Loop Antenna wire to the black AM Antenna terminal and the white AM Loop Antenna wire to the white AM Antenna terminal.

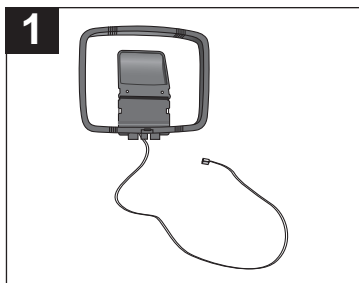

1
Extend the AM Loop Antenna wire.

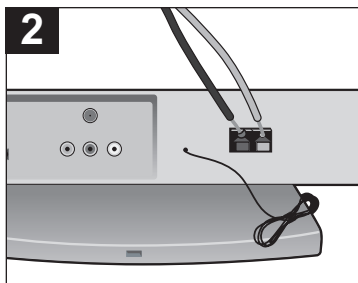

2
Connect the AM Loop Antenna's black wire to the black terminal and the white wire to the white terminal at the rear of the main unit. Make sure the wires are inserted correctly into the terminals as shown.

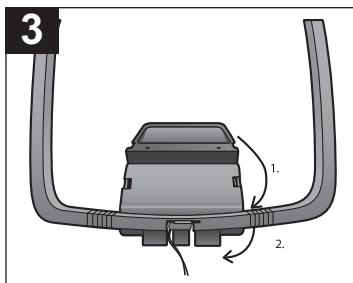

3
At the bottom of the AM Loop Antenna, rotate the stand to the rear and then push the stand to the front.

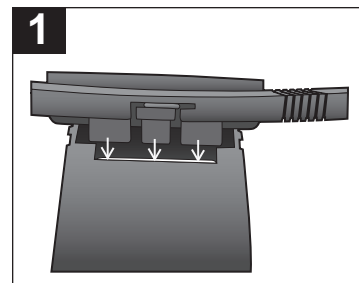

1
Insert the tabs into the gaps in the stand. Remember to fully extend the AM Loop Antenna wire and locate it away from the main unit, AC adaptor and other equipment for better reception and to prevent interference.

FM ANTENNA:

For best FM reception, extend the FM Wire Antenna to its full length

NOTES:

- To improve the AM signal, move the AM Loop Antenna away from the system, AC Adaptor and other equipment.
- To improve FM signal, extend FM antenna fully and keep the FM antenna as horizontal as possible after connection.

OUTDOOR VHF/UHF ANTENNA CONNECTION (ANTENNA NOT INCLUDED)

Follow the instructions for the type of antenna system you intend to use.

Combination VHF/UHF Antenna (Single 75 ohm cable or 300 ohm twin-lead wire)

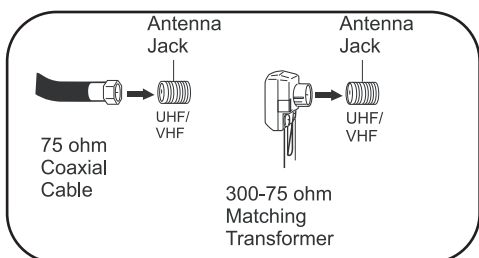

Connect the 75 ohm cable from combination VHF/UHF antenna to the antenna jack.

OR

If your combination antenna has a 300 ohm twin-lead wire, use a 300-75 ohm matching transformer (NOT SUPPLIED).

Combination VHF/UHF Antenna (Separate VHF and UHF 300 ohm twin-leads)

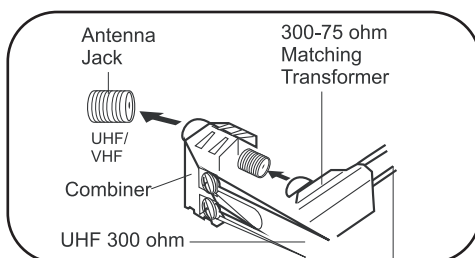

Connect the UHF twin-lead wire to a combiner (NOT SUPPLIED). Connect the VHF twin-lead to a 300-75 ohm matching transformer (NOT SUPPLIED). Attach the transformer to the combiner. Attach the combiner to the antenna jack.

Separate VHF/UHF Antennas

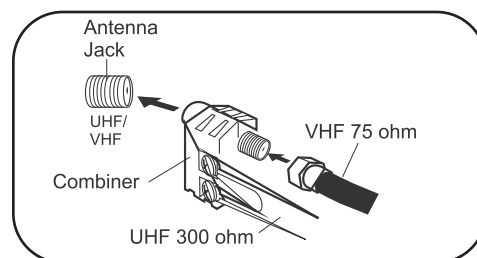

Connect the 75 ohm cable from the VHF antenna and the UHF antenna twin-lead wire to a combiner (NOT SUPPLIED). Attach the combiner to the antenna jack. **NOTE:** If your VHF antenna has a twin-lead wire, use a 300-75 ohm matching transformer, then connect the transformer to the combiner.

CONNECTIONS

CONNECTION USING AUDIO/VIDEO CABLES:

Follow the instructions below to connect an external unit, such as a VCR or second DVD player, to your unit using Audio/Video cables. (CABLES NOT INCLUDED.)

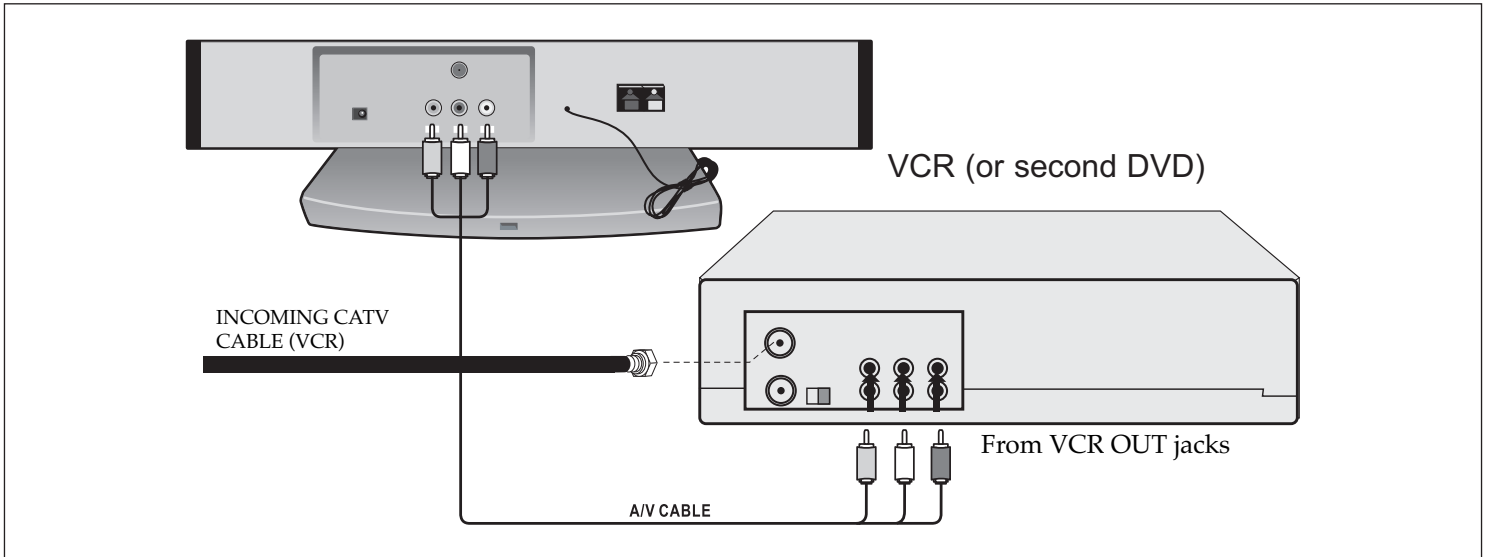

1. Connect the cable, satellite or incoming antenna to the VHF/UHF IN jack on the rear of the VCR.
2. Connect the left and right audio cable from the external unit's Audio OUT jacks to this unit's AUDIO IN jacks. Connect the external unit's Video OUT jack to this unit's VIDEO IN jack.
3. Press the AUX button on the remote to select the auxiliary input ("AUX IN" will appear in the display) and press PLAY on the external unit.

ADJUSTING THE SCREEN

Adjust the 8" TFT LCD screen as follows:

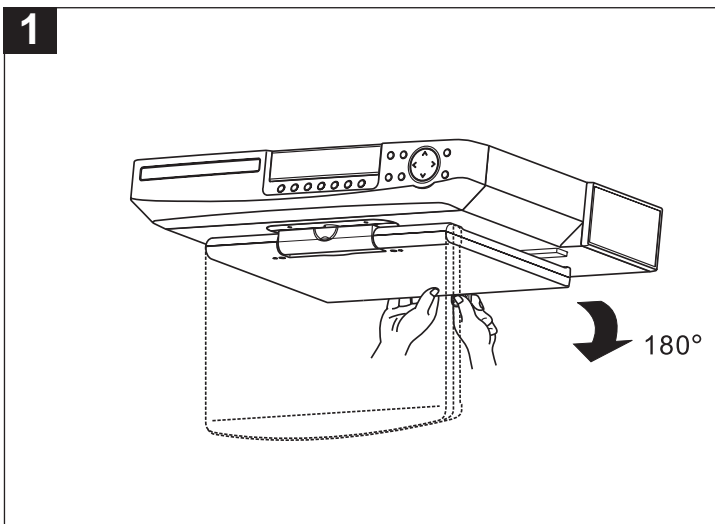

Push the area as shown in the step above and pull down the screen to a maximum of 180°.

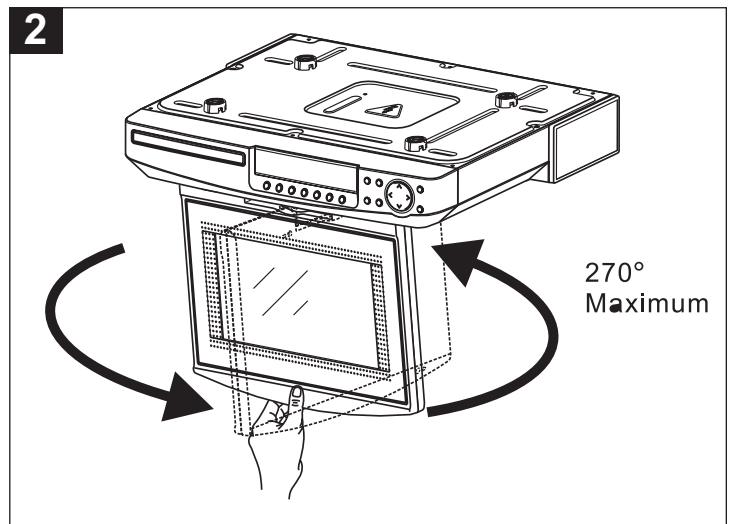

Rotate the screen to a maximum viewing angle of 270°.

ABOUT DISCS

The region number for this DVD Player is:
See the following page for information regarding region numbers.



PLAYABLE DISCS:

The following discs can be played back on this DVD player:



DISC TYPES:

DVD

Data on most DVDs is divided into sections called “titles” and then into subsections called “chapters”, each of which is given a title or chapter number. Some features of this DVD player will not operate with some DVD discs as they are preset. If a function you selected does not run as desired, refer to the manual accompanying the DVD disc.

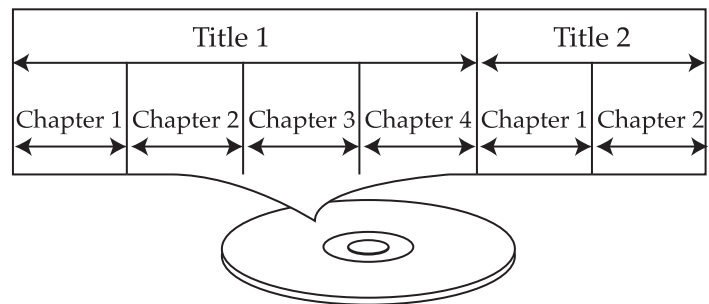

AUDIO CD

Data on an audio CD is divided into sections called “tracks”, each of which is given a track number.

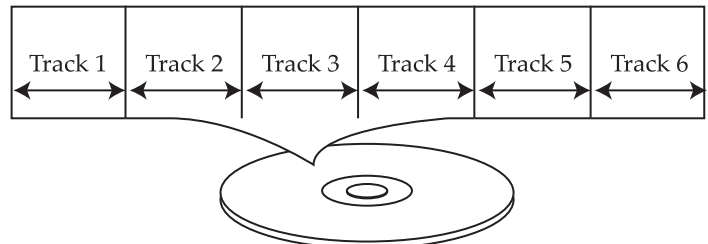

MP3 CD

When playing an MP3, the selected file will appear in the display and the unit will list the folders/tracks.

MP3 is the abbreviation of “MPEG1 Audio Layer 3”. MPEG Audio is a format that compresses the audio portion only.

IMPORTANT NOTES:

Due to many variables, including recording condition, type of disc, writing software, etc., this unit does not guarantee playback of all MP3 discs.

IMPORTANT:

It is important that you read the manual that accompanies the DVD disc, as there are features that are on the DVD player that cannot be used with certain DVDs. There are also extra features on the DVD disc that are different for each DVD disc, so they are not explained in this owner’s manual.

ABOUT DISCS (CONTINUED)

Notes on Copyright:

It is forbidden by law to copy, broadcast, show, broadcast on cable, play in public and rent copyrighted material without permission. DVD video discs are copy protected, and any recordings made from these discs will be distorted. This product incorporates copyright protection technology that is protected by method claims of certain U.S. patents and other intellectual property rights owned by Macrovision Corporation and other rights owners. Use of this copyright protection technology must be authorized by Macrovision Corporation, and is intended for home and other limited viewing uses only, unless otherwise authorized by Macrovision Corporation. Reverse engineering or disassembly is prohibited.

Region Management Information:

This DVD Player is designed and manufactured to respond to the Region Management Information that is recorded on a DVD disc. If the Region number described on the DVD disc does not correspond to the Region number of this DVD player, this DVD player cannot play that disc. You may not be able to play back some DVD video discs on this player if they were purchased from outside your geographic area or made for business purposes. When you try to play back an unauthorized disc, "Wrong Region" appears on the TV screen.

SETTING THE TIME

SETTING THE TIME

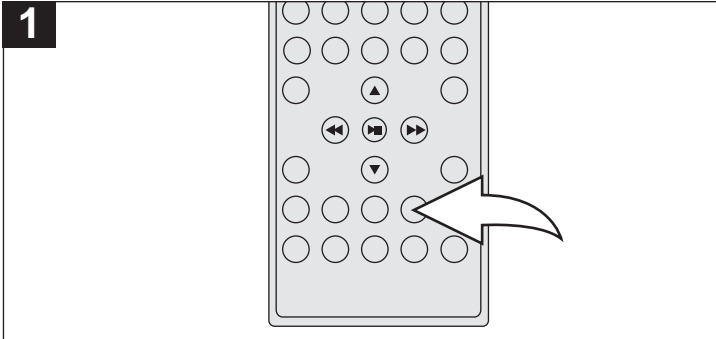

1 With the power on, press and hold the CLOCK button; the hours digits will blink in the display.

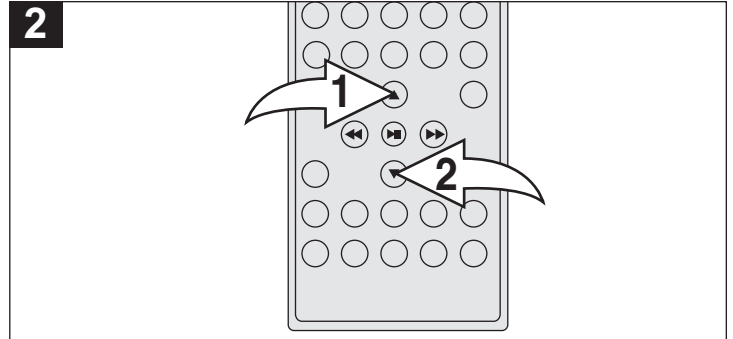

2 Within five seconds, press the Navigation ▲ ① and/or ▼ ② button to set the current hour. Make sure to set the correct AM/PM setting.

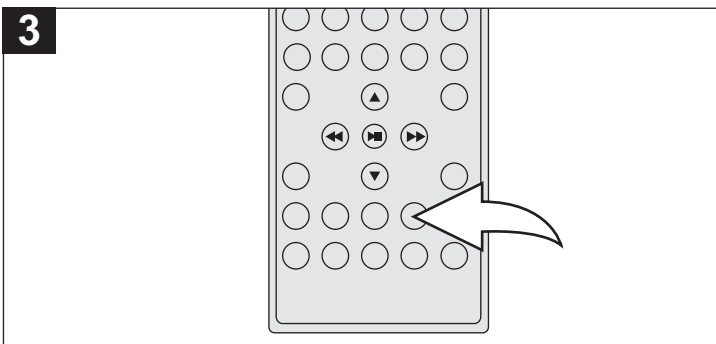

3 Press the CLOCK button again; the minute digits will blink.

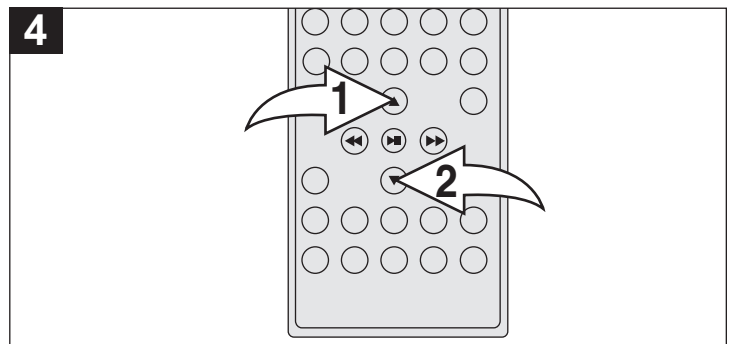

4 Press the Navigation ▲ ① and/or ▼ ② button to set the current minute.

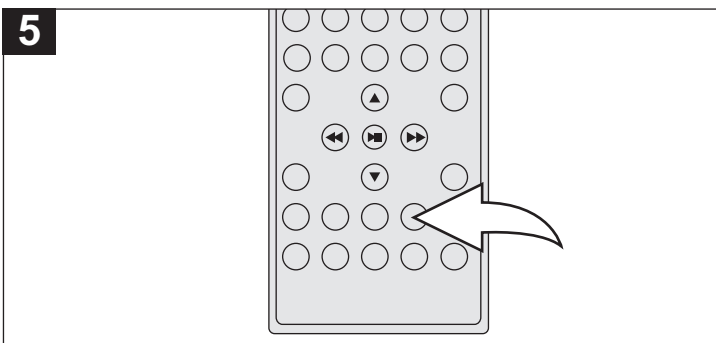

5 Press the CLOCK button again and the clock will be set.

NOTE:

While in the DTV, Aux In or Disc mode, press the CLOCK button to show the time in the display. Press again to return to the previous mode.

SETTING THE TIMER

SETTING THE TIMER

This unit has a convenient countdown timer, set as shown below.

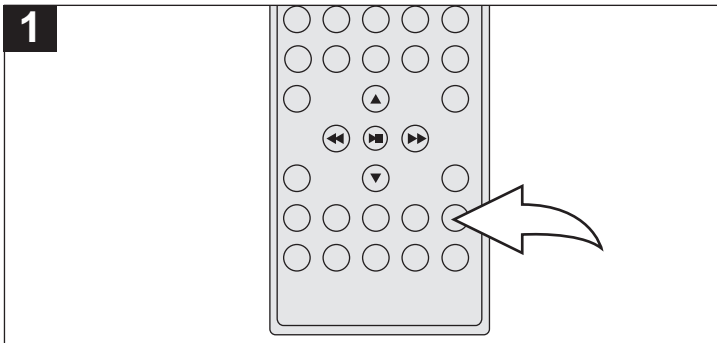

1 With the power on, press and hold the TIMER button; the 000 MIN will blink in the display.

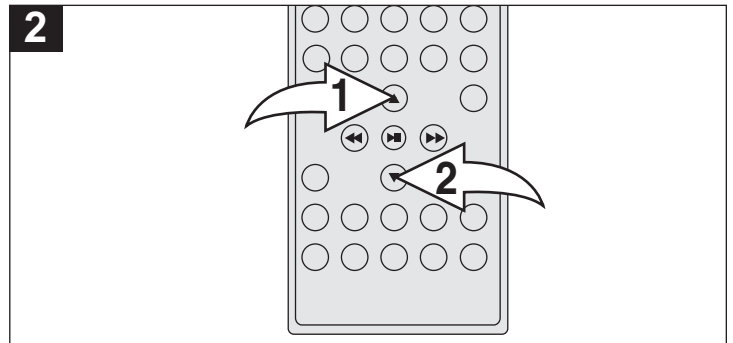

2 Within three seconds, press the Navigation ▲ ⏪ and/or ▼ ⏩ button to set the desired timer time (0 to 180 minutes).

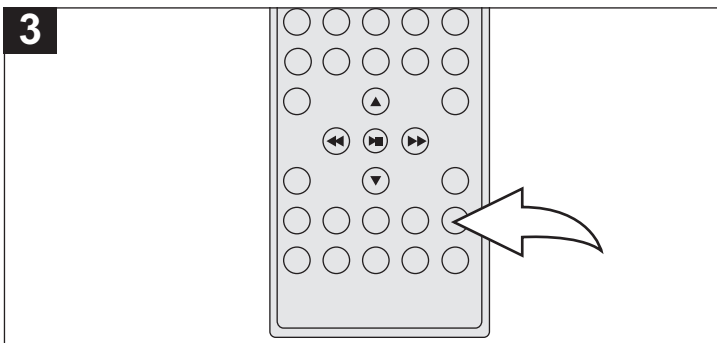

3 Press the TIMER button again to confirm; the Timer Indicator will appear in the display and the timer will count down.

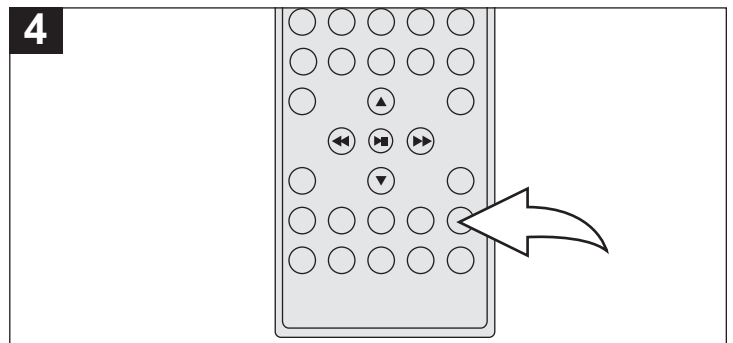

4 To cancel the Timer feature, press the TIMER button again; the Timer indicator will disappear from the display. To shut the timer off, press the TIMER button.

RADIO OPERATION

TUNING RADIO STATIONS

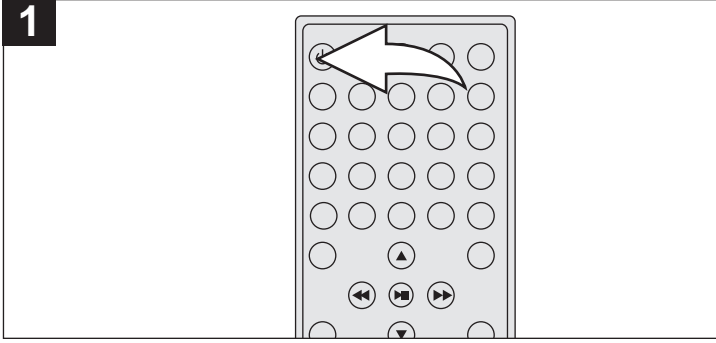

1 Press the Power button to turn the unit on; the STANDBY indicator will turn off.

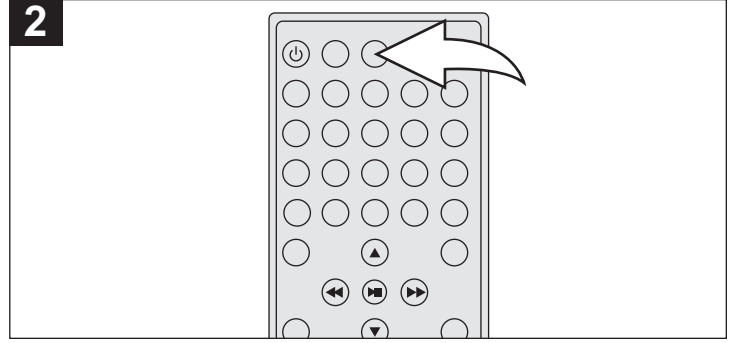

2 Press the TUNER/BAND button on the remote control to select the Radio mode.

Note: You can also press the SOURCE button on the main unit until the display shows an AM or FM reception. Press the CLOCK button to show the time in the display and press again to show the frequency.

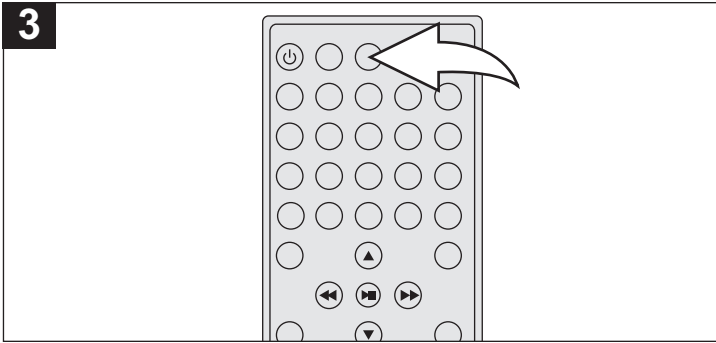

3 Press the TUNER/BAND button on the remote or the BAND button on the main unit to select the desired band (AM or FM).

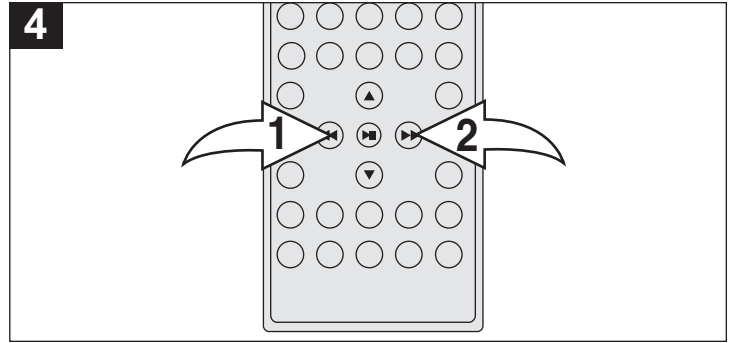

4 Manually tune a station using the Navigation ◀/Search ◀◀ button ❶ and/or Navigation ▶/Search ▶▶ button ❷. When a strong FM station is received, the FM Stereo indicator will light.

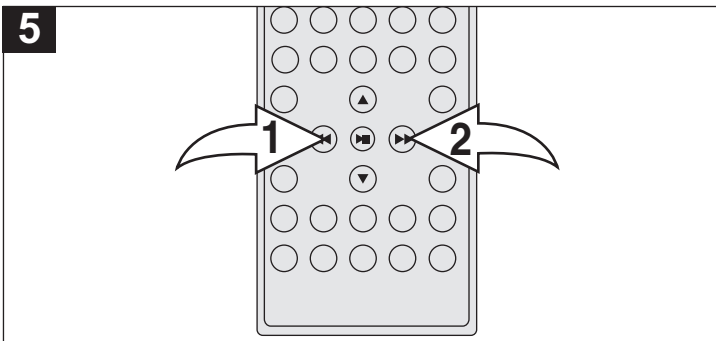

5 To automatically tune a station, press and hold the Navigation ◀/Search ◀◀ button ❶ and/or Navigation ▶/Search ▶▶ button ❷. for approximately one second; the unit will automatically tune in the next strong broadcasting station. When a strong FM station is received, the FM Stereo indicator will light.

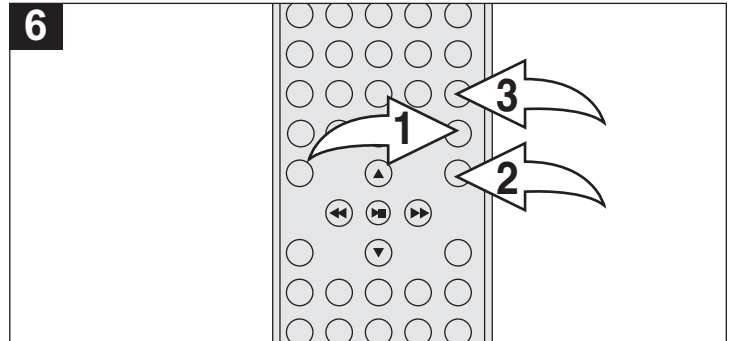

6 Adjust the volume as desired using the VOLUME Up ❶ and Down ❷ buttons. Repeatedly press the EQ/BASS button ❸ to select one of the EQ settings (Flat, Classic, Rock, Jazz or Pop) or press and hold to turn Bass Boost On or Off.

RADIO OPERATION (CONTINUED)

SETTING AND RECALLING RADIO PRESETS

1

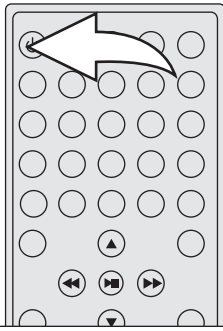

Press the Power button to turn the unit on; the STANDBY indicator will turn off.

2

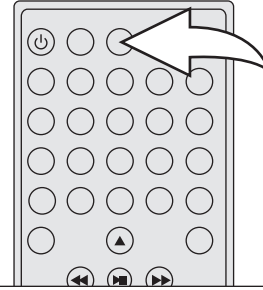

Press the TUNER/BAND button on the remote control to select the Radio mode. Select a radio station as described on the previous page.

NOTE: You can also press the SOURCE button on the main unit until the display shows an AM or FM reception to select the Radio mode.

3

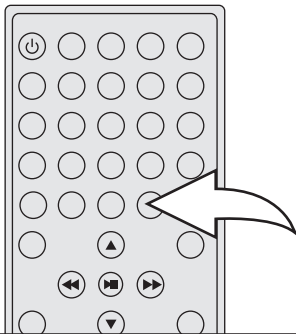

Press the PROGRAM button; STORE 1 will appear in the display.

4

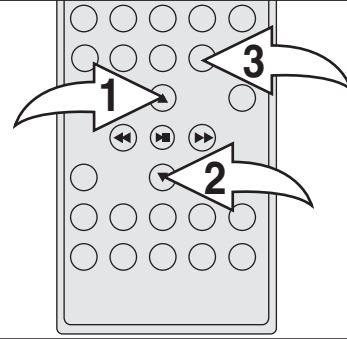

Select the desired preset using the Navigation ▲ ① and/or ▼ ② button, then press the PROGRAM button ③ again to confirm; STORED will appear in the display. Repeat steps 2 through 4 to set more presets (up to 20 each band).

5

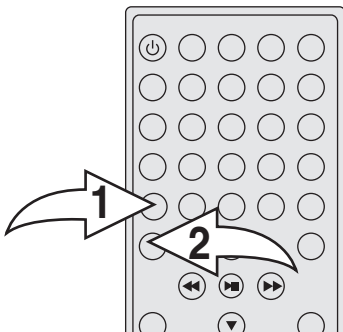

TO RECALL PRESETS:

While in Radio mode (AM/FM): To recall a radio preset, press the Channel Up/Skip (▶) button ① to increase and/or the Channel Down/Skip (◀) button ② to decrease the Radio Preset number.

CLOSED CAPTIONS

WHAT IS CLOSED CAPTIONING?

This unit has the capability to decode and display Closed Captioned television programs. Closed Captioning will display text on the screen for hearing-impaired viewers or it will translate and display text in another language.

CLOSED CAPTIONING WITH A VCR

Closed Captioned programs can be recorded and played back on a VCR with the Closed Captioned text intact. The Closed Captioned text will disappear during Cue (Fast Forward Search), Review (Rewind Search) and Pause modes or if the VCR tracking is not adjusted properly.

TO VIEW CLOSED CAPTIONS

ANALOG CAPTIONS

Please see the next page for setting the Analog Caption.

CC1: This Closed Caption mode will display text on the screen in English or another language. Generally, Closed Captions in English are transmitted on Captions 1.

CC2-4 These Closed Caption modes will display text on the screen in English or another language. Generally, Closed Captions in another language is transmitted on these channels.

TEXT: The Text Closed Caption Modes will usually fill the screen with a programming schedule or other information. Select T1, T2, T3 or T4.

DIGITAL CAPTIONS

Please see the next page for setting the Digital Caption.

SERVICE 1-6 : These Closed Caption modes will display text on the screen in English or another language. Generally, Closed Captions in English are transmitted on Service 1 and Closed Captions in other languages are transmitted on Service 2 through 6.

After selecting a Closed Caption Mode, it will stay in effect until it is changed, even if the channel is changed. If the Captions signal is lost due to a commercial or a break in the signal, the Captions will reappear when the signal is received again. If the channels are changed, the Captions will be delayed approximately 10 seconds.

The Captions will appear in places on the screen where they will least interfere with the picture, usually on the bottom of the screen. News programs will usually show three-line Closed Captions which scroll onto the screen. Most other shows provide two or three lined Captions placed near the character who is speaking so the viewer can follow the dialogue.

Words in italics or underlined describe titles, words in foreign languages or words requiring emphasis. Words that are sung usually appear enclosed by musical notes.

For television programs broadcasting with Closed Captions, look in your TV guide for the Closed Captions symbol (CC).

NOTES:

- When selecting Closed Captions, the captioning will be delayed approximately 10 seconds.
- Misspellings or unusual characters may occasionally appear during Closed Captioning. This is normal with Closed Captioning, especially with live programs. This is because during live programs, captions are also entered live. These transmissions do not allow time for editing.
- When Captions are being displayed, on-screen displays, such as Mute, may not be seen or may interfere with Closed Captions.
- Some cable systems and copy protection systems may interfere with the Closed Captioned signal.
- If using an indoor antenna or if TV reception is very poor, the Closed Caption Decoder may not appear or may appear with strange characters or misspelled words. In this case, adjust the antenna for better reception or use an outdoor antenna.

FAQs:

When I press the MUTE button, the captions do not appear, is this normal?

Yes, this is normal for this unit. Once the display information disappears, the captions will continue.

I entered the Captions mode, but no captions are appearing, why?

If no caption signal is received, no captions will appear, but the television will remain in the Caption mode.

Why is there a big black box on the screen?

Because you are in a Captions mode. Turn the captions off, or select a different Captions mode.

SETTING THE DTV MENUS

SETTING THE CLOSED CAPTIONS (ATSC)

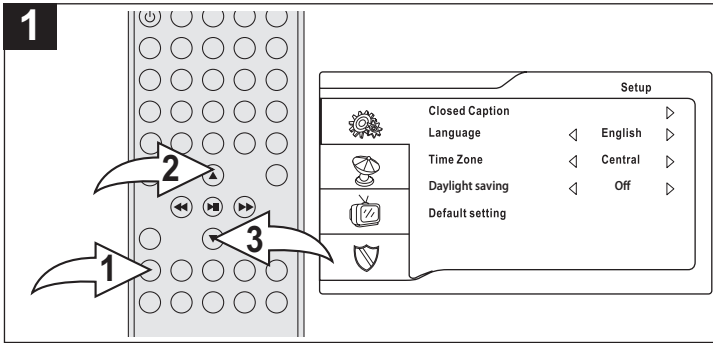

With the power on and the DTV mode selected (see page 32), press the SETUP button ❶; the menu will appear. Press the Navigation ▲ ❷ and/or ▼ ❸ button to select the Setup menu.

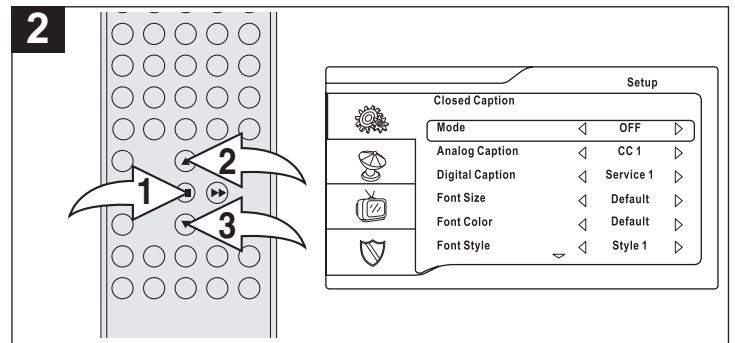

Press the ENTER/Play/Pause (▶||) button ❶ to enter the Setup menu. Press the Navigation ▲ ❷ and/or ▼ ❸ button to select the Closed Caption option, then press the ENTER/Play/Pause (▶||) button ❶ again.

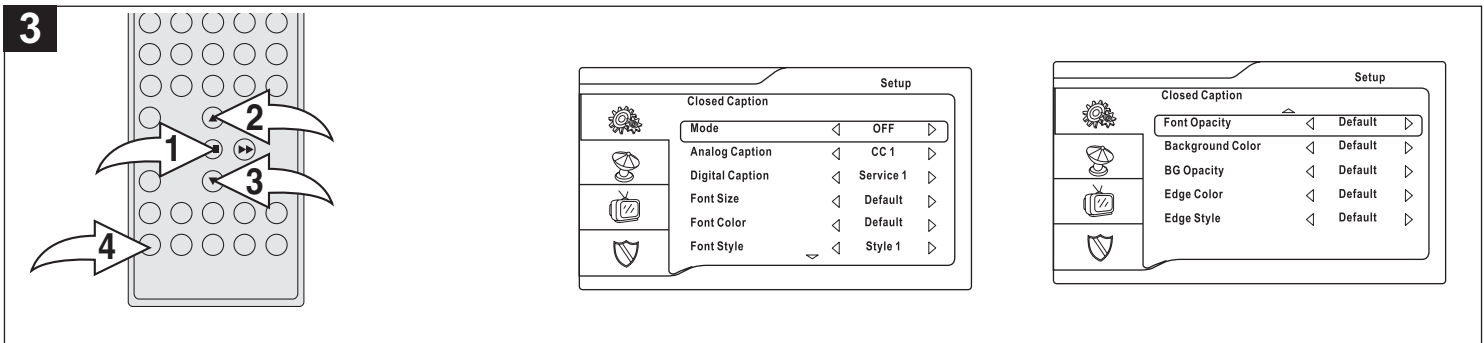

Select the desired Closed Caption setting (as shown below) by using the Navigation ▲ ❷ and/or ▼ ❸ button, then pressing the ENTER/Play/Pause (▶||) button ❶. Then press the Navigation ▲ ❷ and/or ▼ ❸ button to set as desired. Press the ENTER/Play/Pause (▶||) button ❶ again to set.

MODE: Select OFF to turn closed captions off, ON to turn closed captions on or ON MUTE to turn on closed captioning only when the unit is muted.

ANALOG CAPTION: Select OFF to turn the analog closed captions off, CC1-CC4 to select one of the closed captions or T1-T4 to select one of the text modes.

DIGITAL CAPTION: Select OFF to turn the digital closed captions off or SERVICE1 to SERVICE 6 to select one of the service digital closed captions.

FONT SIZE: Select a font size for the captions.

FONT COLOR: Select the desired font color for the captions.

FONT STYLE: Select a desired font style for the captions.

FONT OPACITY: Select the desired font effect for the captions.

BACKGROUND COLOR: Select the desired background color for the captions.

BG OPACITY: Select the background effect for the captions.

EDGE COLOR: Select the color of the font's edges for the captions.

EDGE STYLE: Select the style of the font's edges for the captions.

Press the ZOOM/EXIT button ❹ twice to exit the setup menu.

NOTES:

- You can also use the SUBTITLE/CC (Closed Caption) button on your remote to scroll through and select a Closed Captions option while viewing a program.

SETTING THE DTV MENUS (CONTINUED)

SETTING THE LANGUAGE

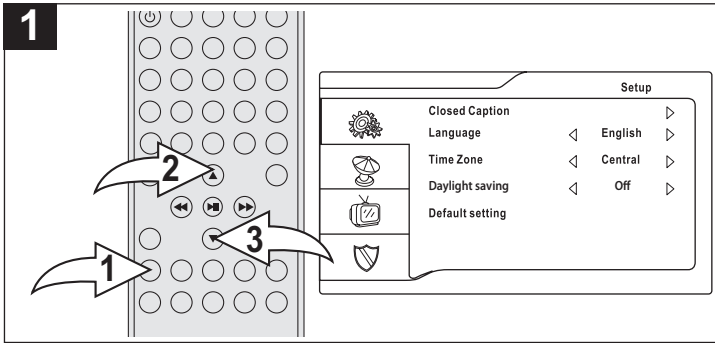

With the power on and the DTV mode selected, press the SETUP button ❶; the menu will appear. Press the Navigation ▲ ❷ and/or ▼ ❸ button to select the Setup menu.

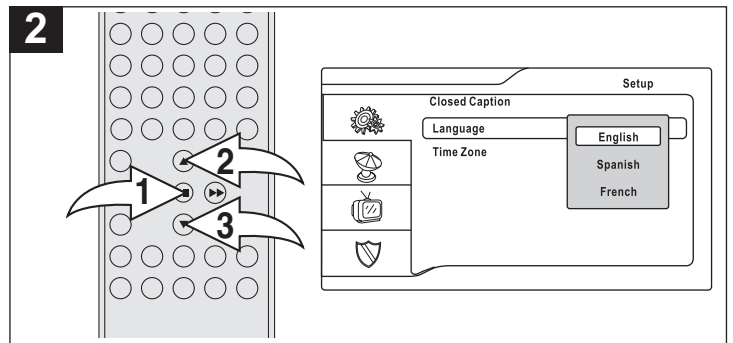

Press the ENTER/Play/Pause (▶||) button ❶ to enter the Setup menu. Press the Navigation ▲ ❷ and/or ▼ ❸ button to select the LANGUAGE option, then press the ENTER/Play/Pause (▶||) button ❶ again.

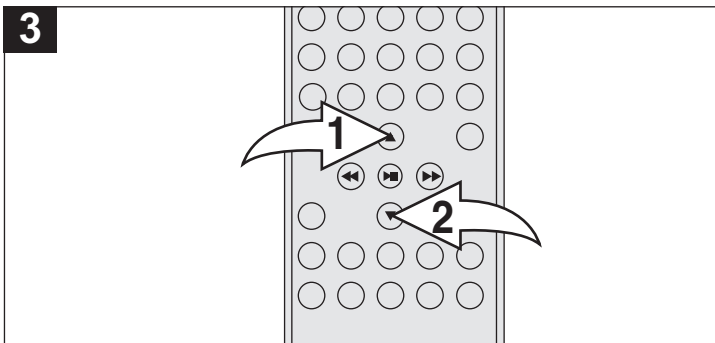

Select the desired Language (English, Spanish or French), using the Navigation ▲ ❶ and/or ▼ ❷ button to set as desired.

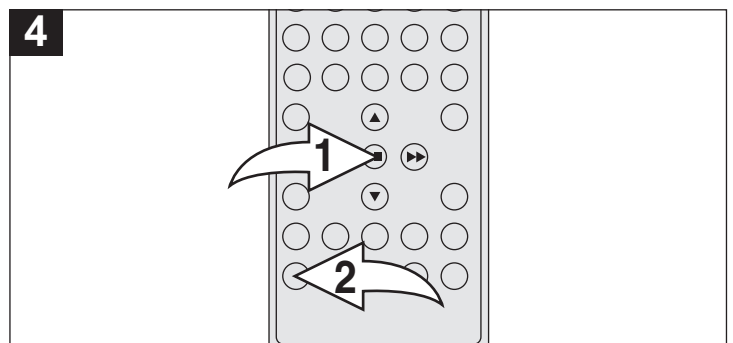

Press the ENTER/Play/Pause (▶||) button ❶ again to set. Press the ZOOM/EXIT button ❷ twice to exit the setup menu.

DEFAULT

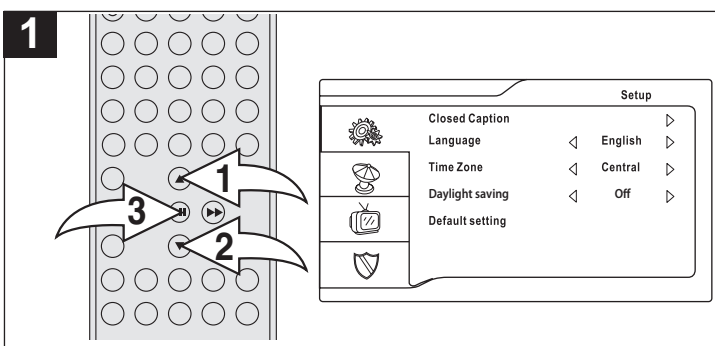

Select the Setup menu as described in steps 1 and 2 above. Press the Navigation ▲ ❶ and/or ▼ ❷ button to select the DEFAULT SETTING option, then press the ENTER/Play/Pause (▶||) button ❸ to select it. Press the Navigation ▲ ❶ and/or ▼ ❷ button to select On (to reset all of the unit's settings to the factory default settings.) or select OFF to cancel and NOT reset to the factory default settings.

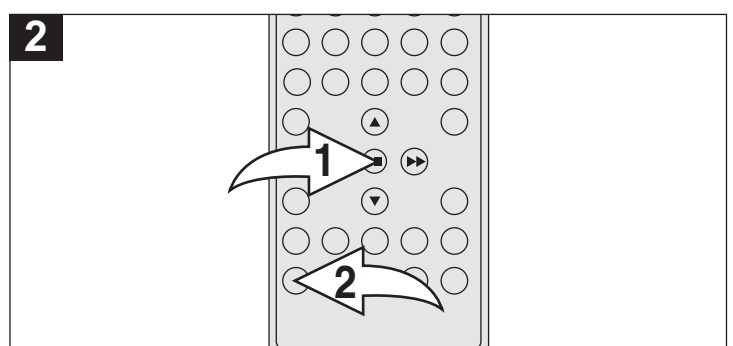

Press the ENTER/Play/Pause (▶||) button ❶ again to select it. Press the ZOOM/EXIT button ❷ to exit the setup menu.

SETTING THE DTV MENUS (CONTINUED)

SETTING THE TIME ZONE AND THE (DST) DAYLIGHT SAVING TIME

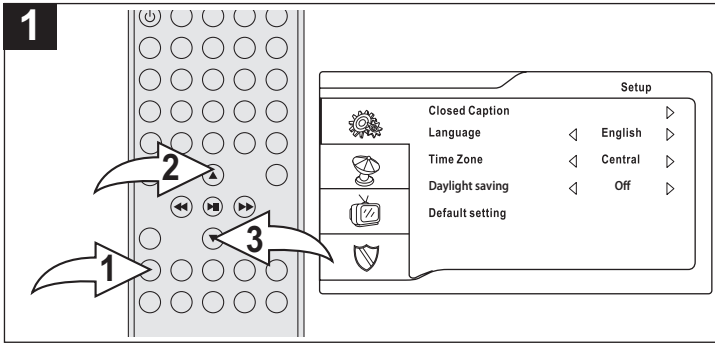

With the power on and the DTV mode selected, press the **SETUP** button ❶; the menu will appear. Press the Navigation **▲** ❷ and/or **▼** ❸ button to select the Setup menu.

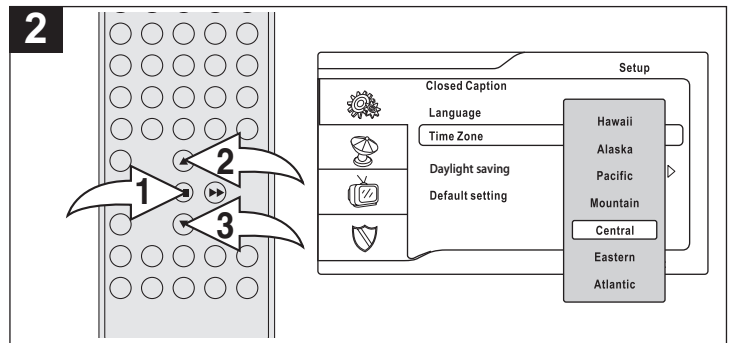

Press the **ENTER/Play/Pause** (▶||) button ❶ to enter the Setup menu. Press the Navigation **▲** ❷ and/or **▼** ❸ button to select the **TIME ZONE** option, then press the **ENTER/Play/Pause** (▶||) button ❶ again.

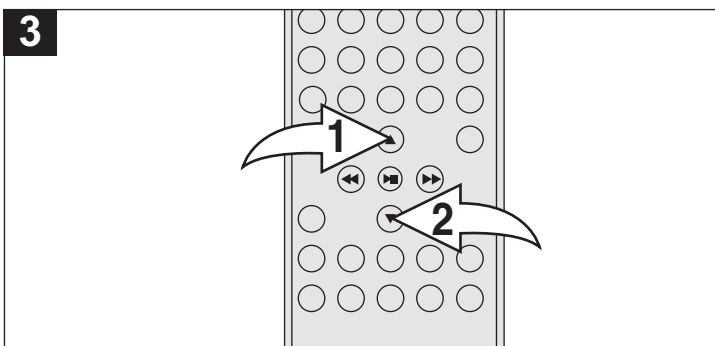

Select the desired Time Zone using the Navigation **▲** ❶ and/or **▼** ❷ button to set as desired.

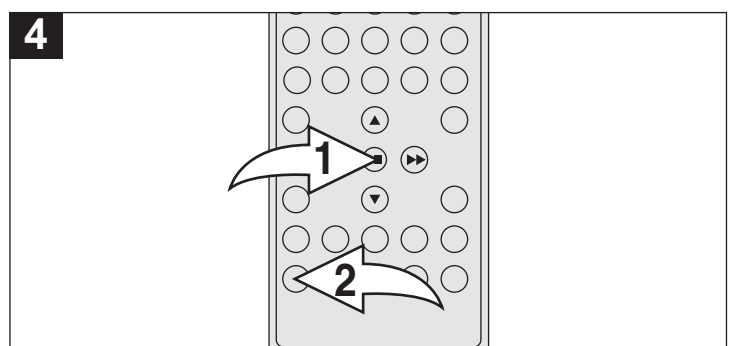

Press the **ENTER/Play/Pause** (▶||) button ❶ again to set.

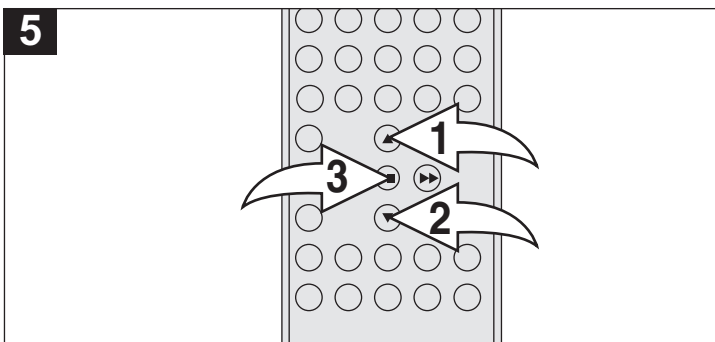

Press the Navigation **▲** ❶ and/or **▼** ❷ button to select the **DAYLIGHT SAVINGS** option, then press the **ENTER/Play/Pause** (▶||) button ❸ again. Select **ON** or **OFF** using the Navigation **▲** ❶ and/or **▼** ❷ button, then the **ENTER/Play/Pause** (▶||) button ❸ again to set.

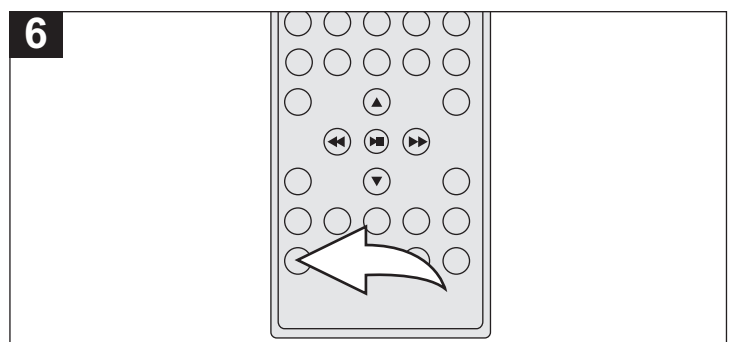

Press the **ZOOM/EXIT** button to exit the setup menu.

SETTING THE DTV MENUS (CONTINUED)

SETTING CHANNELS INTO MEMORY

This unit is equipped with a channel memory feature which allows channels to skip up or down to the next channels set into memory, skipping over unwanted channels. Before selecting channels, they must be programmed into the unit's memory.

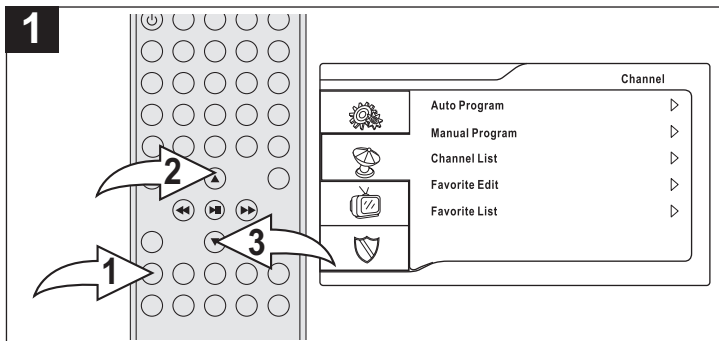

With the power on and the DTV mode selected, press the SETUP button ❶; the menu will appear. Press the Navigation ▲ ❷ and/or ▼ ❸ button to select the Channel menu.

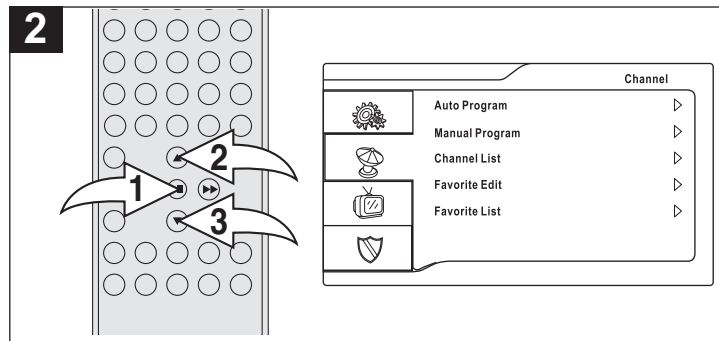

Press the ENTER/Play/Pause (▶||) button ❶ to enter the Channel menu. Press the Navigation ▲ ❷ and/or ▼ ❸ button to select the AUTO PROGRAM option, then press the ENTER/Play/Pause (▶||) button ❶ again.

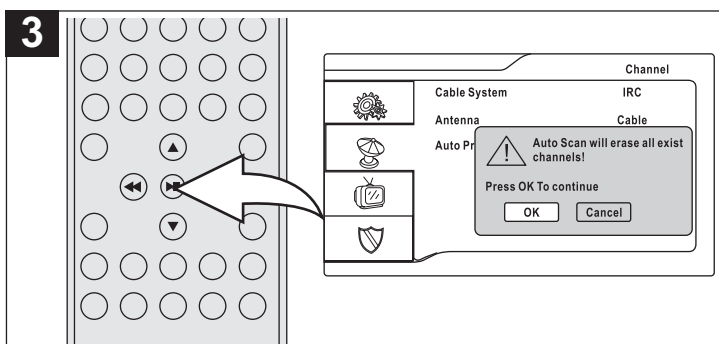

Select OK by pressing the ENTER/Play/Pause (▶||) button to start the Auto Programming. The unit will automatically cycle through all the ATSC channels and store active channels into memory. When Auto Scan is complete, the lowest memorized channel will be displayed.

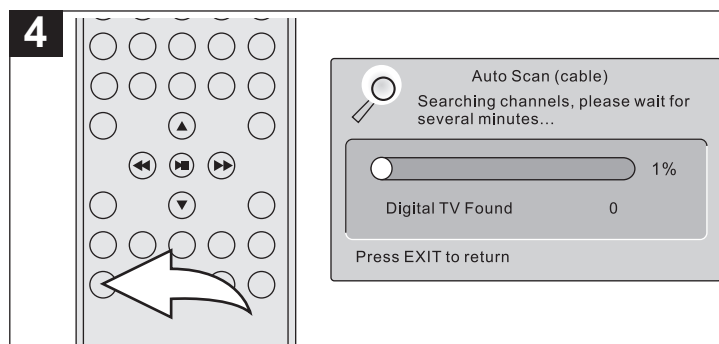

To stop Auto Scan before it is finished, press the ZOOM/EXIT button; the lowest memorized channel (ATSC) will be displayed.

FAQs:

How many channels will I actually receive?

The actual number of channels that can be received depends on how many channels your satellite company, or local area, provides. Contact your company to determine the number of channels in your area.

NOTE:

- Make sure that the antenna is connected properly before plugging in the AC power cord, turning on the unit and accessing the Channel menu.
- In step 3, Select CANCEL to cancel the auto programming.

SETTING THE DTV MENUS (CONTINUED)

MANUAL PROGRAM

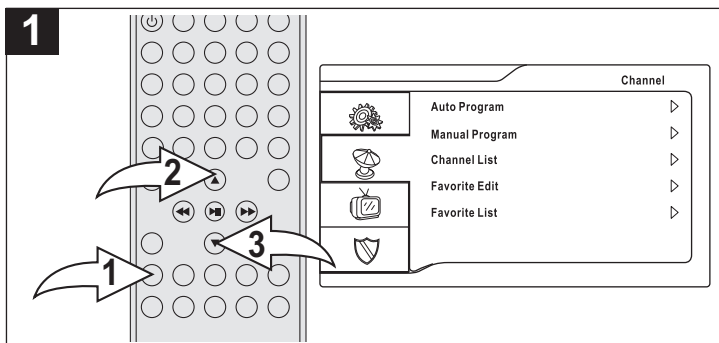

With the power on and the DTV mode selected, press the SETUP button ❶; the menu will appear. Press the Navigation ▲ ❷ and/or ▼ ❸ button to select the Channel menu.

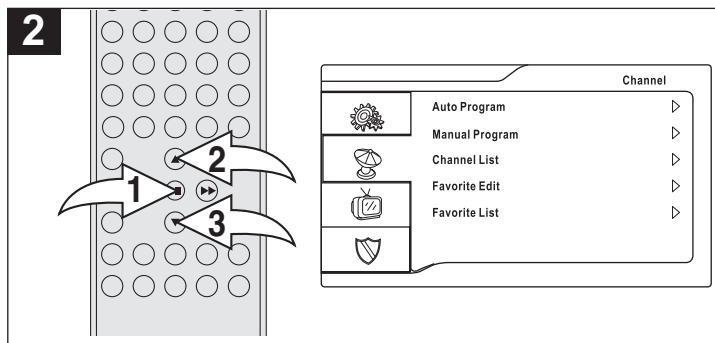

Press the ENTER/Play/Pause (▶||) button ❶ to enter the Channel menu. Press the Navigation ▲ ❷ and/or ▼ ❸ button to select the MANUAL PROGRAM option, then press the ENTER/Play/Pause (▶||) button ❶ again.

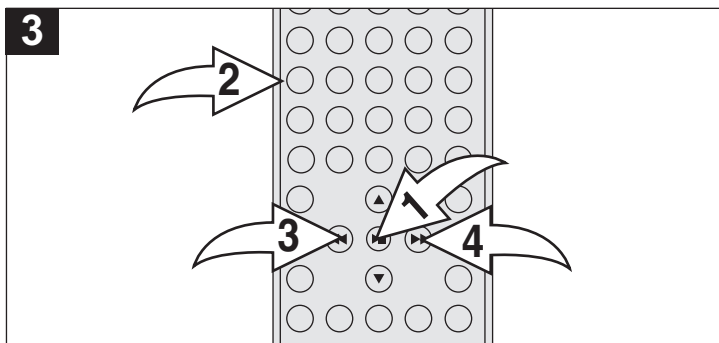

Select OK by pressing the ENTER/Play/Pause (▶||) button ❶ to start the Manual Programming. Press the number (0-9) buttons ❷ or the Navigation ◀/Search ◀◀ button ❸ and/or Navigation ▶/Search ▶▶ button ❹ to select the channels.

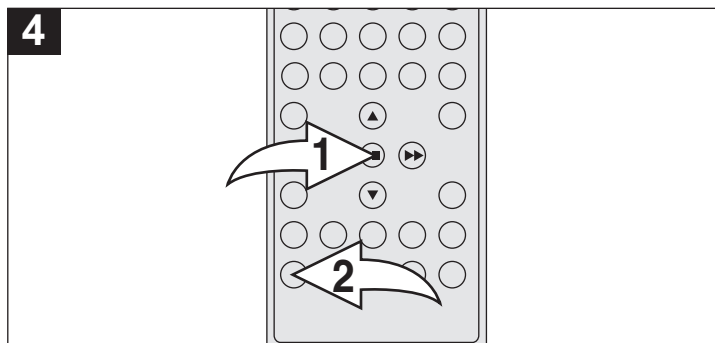

Press the ENTER/Play/Pause (▶||) button ❶ again to scan the channel. Repeat steps 3 and 4 to set the desired channels. Press the ZOOM/EXIT button ❷ to exit the setup menu.

SETTING THE DTV MENUS (CONTINUED)

SELECTING THE DTV CHANNEL LIST

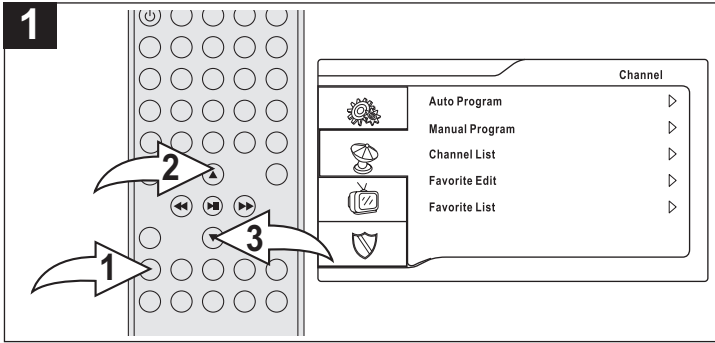

With the power on and the DTV mode selected, press the SETUP button ❶; the menu will appear. Press the Navigation ▲ ❷ and/or ▼ ❸ button to select the Channel menu.

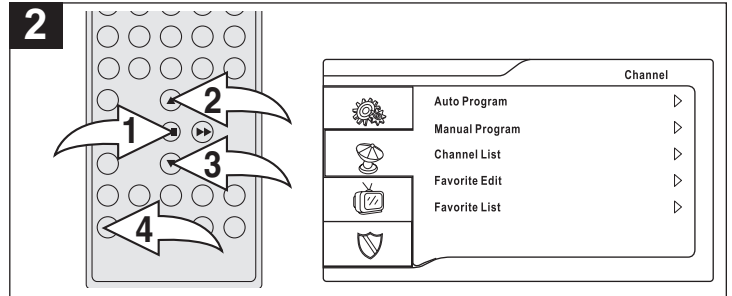

Press the ENTER/Play/Pause (▶||) button ❶ to enter the Channel menu. Press the Navigation ▲ ❷ and/or ▼ ❸ button to select the CHANNEL LIST option, then press the ENTER/Play/Pause (▶||) button ❶ again to view the Channel List. Press Navigation ▲ ❷ and/or ▼ ❸ button to select the desired channel and press ENTER/Play/Pause (▶||) button ❶ again to confirm, then press ZOOM/EXIT button ❹ to exit the setup menu.

EDITING THE FAVORITE LIST

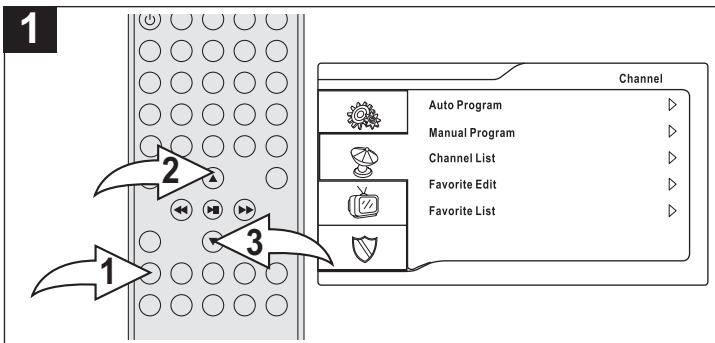

With the power on and the DTV mode selected, press the SETUP button ❶; the menu will appear. Press the Navigation ▲ ❷ and/or ▼ ❸ button to select the Channel menu.

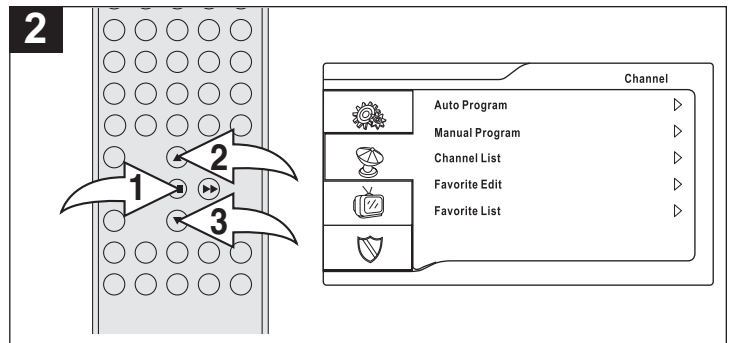

Press the ENTER/Play/Pause (▶||) button ❶ to enter the Channel menu. Press the Navigation ▲ ❷ and/or ▼ ❸ button to select the FAVORITE EDIT option, then press the ENTER/Play/Pause (▶||) button ❶ again.

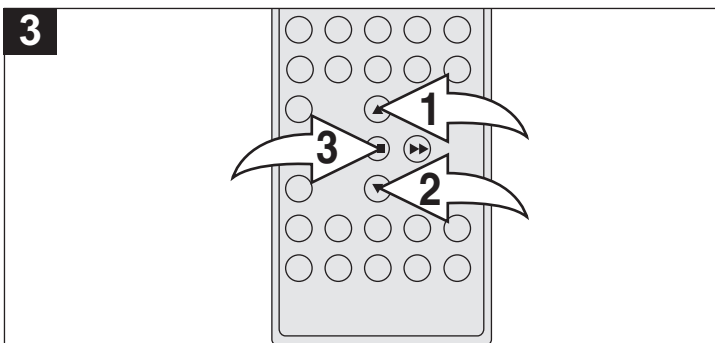

Press the Navigation ▲ ❶ and/or ▼ ❷ button to select a channel, then press the ENTER/Play/Pause (▶||) button ❸ to set Favorite program; one heart will appear and the channel will be added to the favorite list. Press the ENTER/Play/Pause (▶||) button ❸ again to cancel the selection.

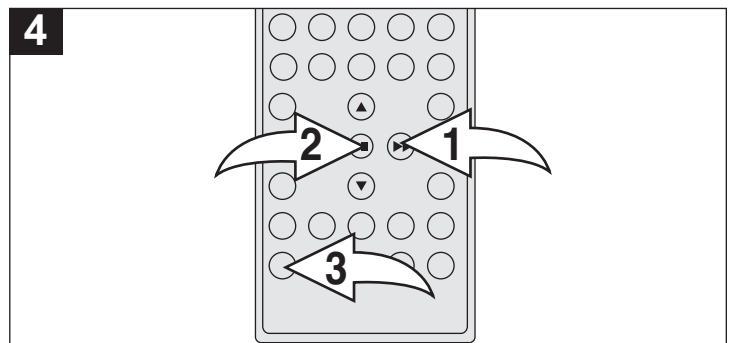

You can also set the rating, up to 4 hearts. Press the Navigation ▶/Search button ❶ to select the next square, then press the ENTER/Play/Pause (▶||) button ❷ again to add another heart. Repeat up to 2 more times (four hearts total). Press the ZOOM/EXIT button ❸ to exit the setup menu.

SETTING THE DTV MENUS (CONTINUED)

SELECTING THE FAVORITE CHANNEL LIST

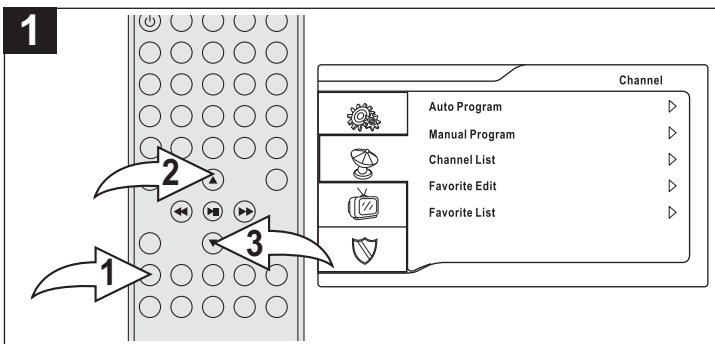

With the power on and the DTV mode selected, press the SETUP button ❶; the menu will appear. Press the Navigation ▲ ❷ and/or ▼ ❸ button to select the Channel menu.

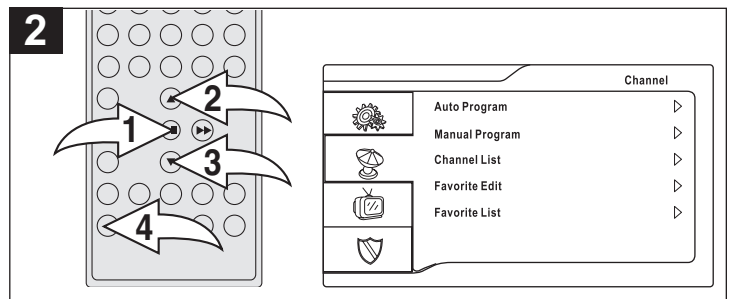

Press the ENTER/Play/Pause (▶||) button ❶ to enter the Channel menu. Press the Navigation ▲ ❷ and/or ▼ ❸ button to select the FAVORITE LIST option, then press the ENTER/Play/Pause (▶||) button ❶ again to view the Favorite Channel List. Press Navigation ▲ ❷ and/or ▼ ❸ button to select the desired channel and press ENTER/Play/Pause (▶||) button ❶ again to confirm, then press ZOOM/EXIT button ❹ to exit the setup menu.

SETTING THE VIDEO

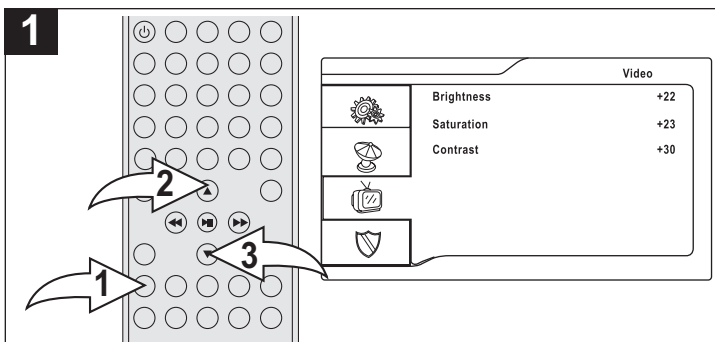

With the power on and the DTV mode selected, press the SETUP button ❶; the menu will appear. Press the Navigation ▲ ❷ and/or ▼ ❸ button to select the Video menu.

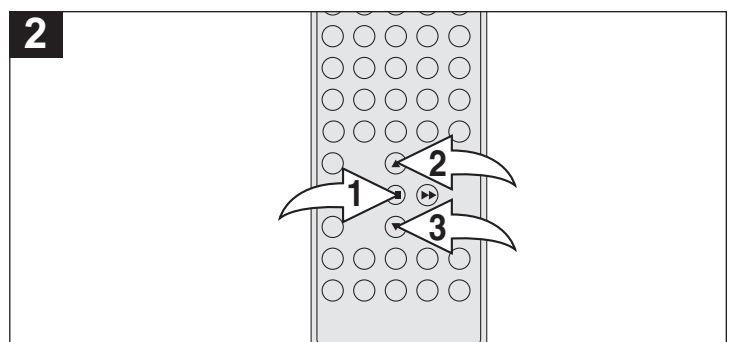

Press the ENTER/Play/Pause (▶||) button ❶ to enter the Video menu. Press the Navigation ▲ ❷ and/or ▼ ❸ button to select one of the video options (Brightness, Saturation or Contrast).

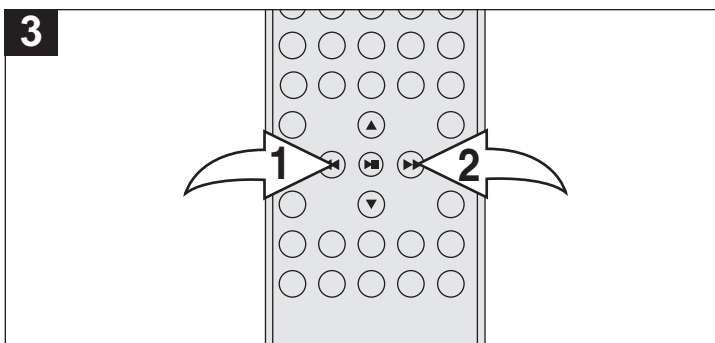

With the desired option selected, adjust using the Navigation ◀/Search ◀◀ button ❶ and/or Navigation ▶/Search ▶▶ button ❷.

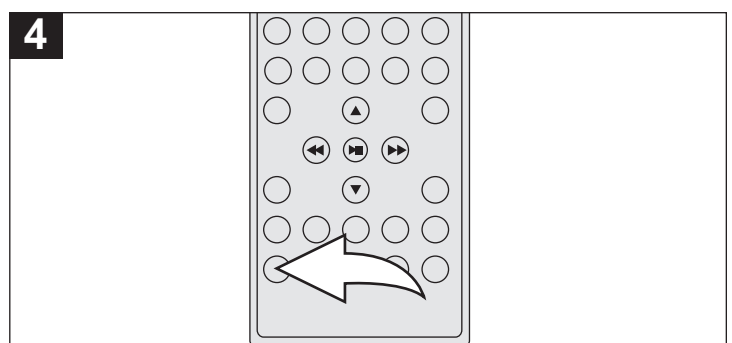

Press the ZOOM/EXIT button to exit and return to the Video menu. Press two more times to exit the Setup menu entirely.

TV PARENTAL CONTROL

V-Chip enables parents to prevent their children from watching inappropriate material on TV. V-Chip reads the ratings for programming (except for news, sports, unedited movies on premium cable and Emergency System signals), then denies access to programming if the program's rating meets the limitations you select. In this case, the program will be blocked.

PARENTAL CONTROL SET-UP

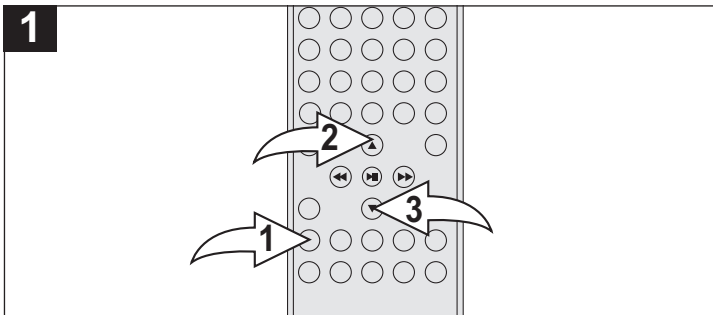

With the power on and the DTV mode selected, press the SETUP button ❶; the menu will appear. Press the Navigation ▲ ❷ and/or ▼ ❸ button to select the Parental Control menu.

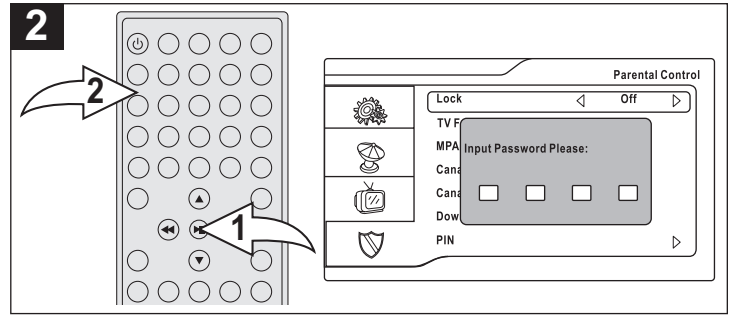

Press the ENTER/Play/Pause (▶||) button ❶ to enter. Enter the 4-digit password using the Number (0-9) buttons ❷. After inputting the password correctly, the Parental Lock submenu appears.

NOTE: The default password is "1234".

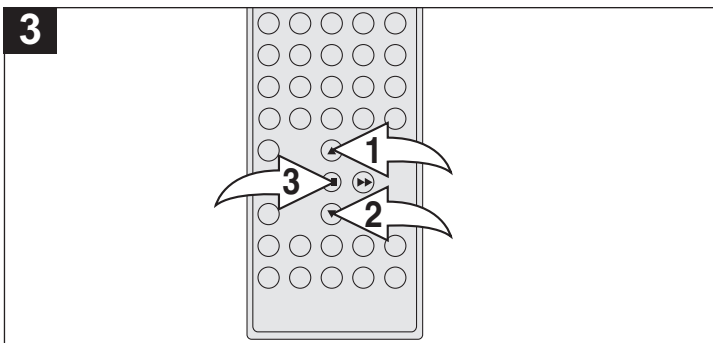

Press the Navigation ▲ ❶ and/or ▼ ❷ button to select the LOCK option, then press the ENTER/Play/Pause (▶||) button ❸ again.

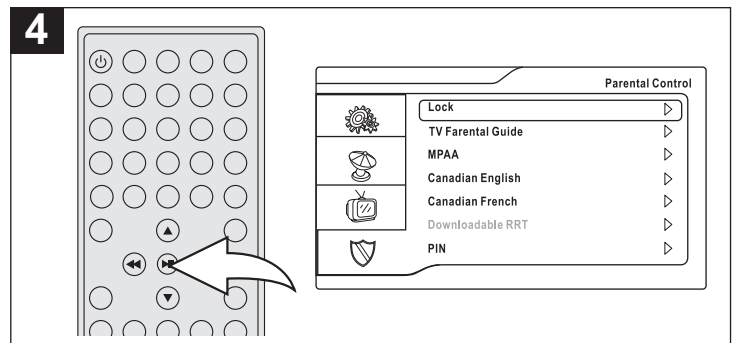

Select ON to turn the Parental Lock On or OFF to turn the Parental Lock Off, then press the ENTER/Play/Pause (▶||) button.

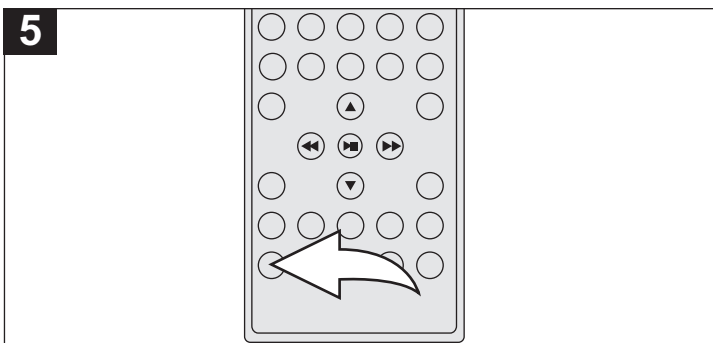

Select the Parental options as described in the upcoming pages or press the ZOOM/EXIT button twice to exit the menus.

NOTE:

- See page 31 to change the password.

TV PARENTAL CONTROL (CONTINUED)

TV PARENTAL GUIDE SET-UP

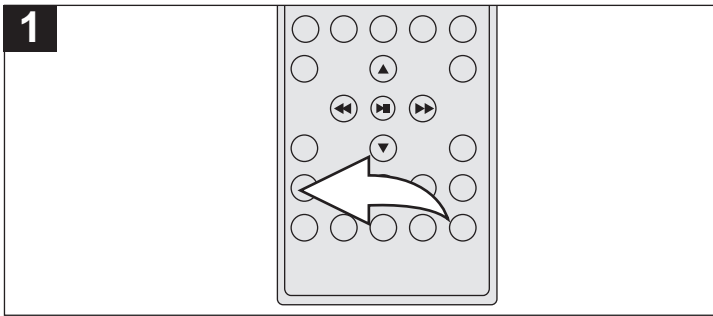

With the power on and the DTV mode selected, press the SETUP button; the menu will appear. Please refer to the previous page to enter the Parental Control menu.

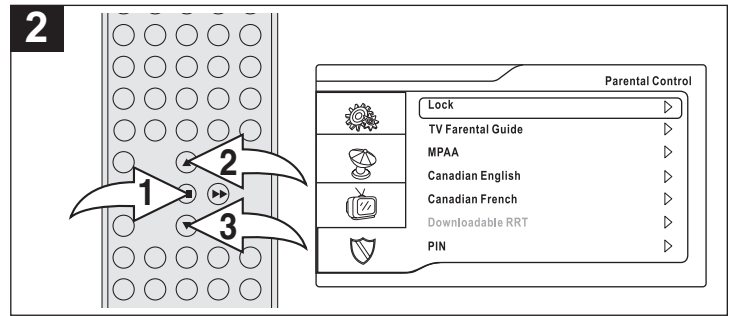

Press the Navigation ▲ and/or ▼ button to select the TV PARENTAL GUIDE option, then press the ENTER/Play/Pause button again.

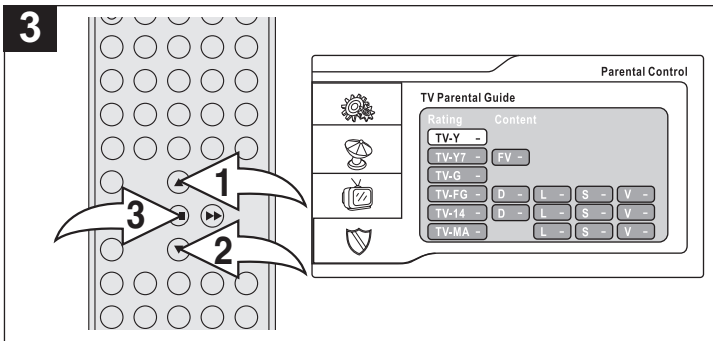

Press the Navigation ▲ and/or ▼ button to select a rating and then the ENTER/Play/Pause button to Block (ratings at or above cannot be viewed) or Unblock (ratings at or under can be viewed).

TVY: All ages	TV14: Parental Guidance less than 14 years old
TVY7: Ages 7 and up	
TVG: General Audience	
TVPG: Parental Guidance	TVMA: Mature Audiences Only

NOTE: A Lock indicates that the rating is blocked.

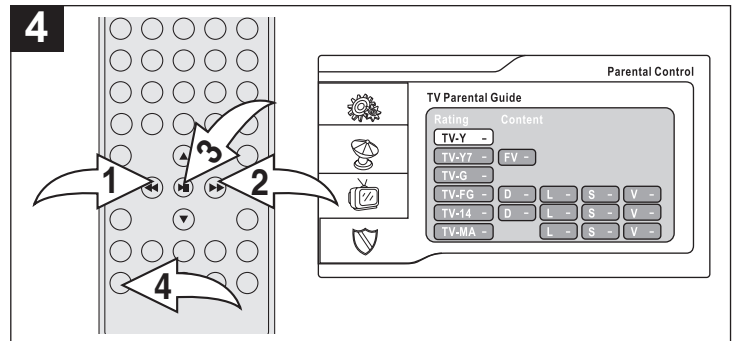

You can also block some or all criteria for each level for Fantasy Violence (FV), Sexual Dialogue (D), Language (L), Sexual Situations (S) or Violence (V).

While in a column for a particular rating level (i.e. TV-PG), use the Navigation ◀/Search ◀ button and/or Navigation ▶/Search ▶ button to select the desired criteria, then press the ENTER/Play/Pause button to turn the option On or Off. When finished, press the ZOOM/EXIT button three times to exit the menus.

NOTE: A Lock indicates that the criteria is blocked.

TV PARENTAL CONTROL (CONTINUED)

MPAA SET-UP

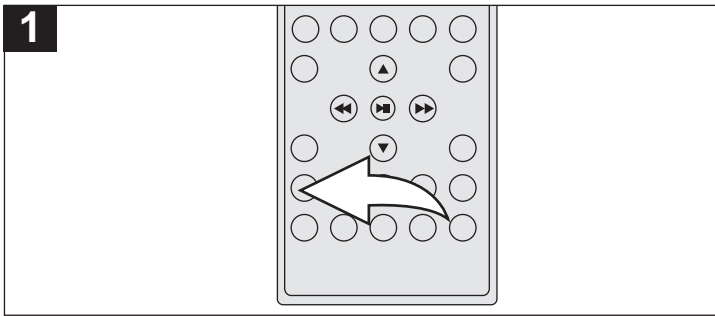

With the power on and the DTV mode selected, press the SETUP button; the menu will appear. Please refer to page 27 to enter the Parental Control menu.

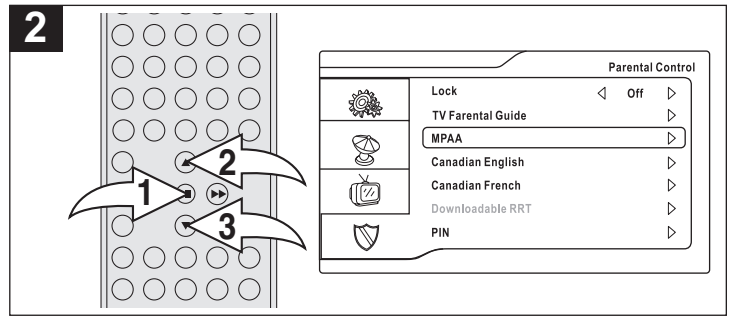

Press the Navigation ▲ and/or ▼ button to select the MPAA option, then press the ENTER/Play/Pause (▶||) button again.

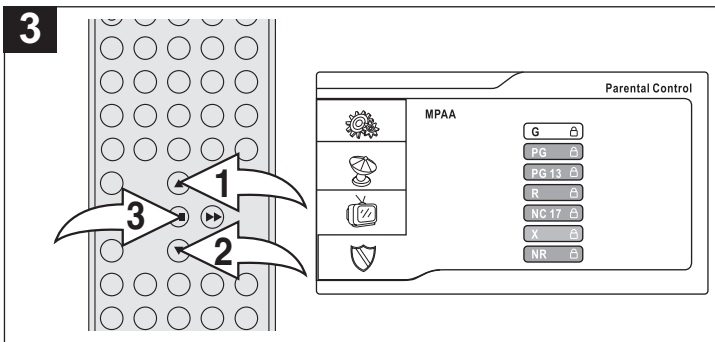

Press the Navigation ▲ and/or ▼ button to select a rating and then the ENTER/Play/Pause (▶||) button to Block (ratings at or above cannot be viewed) or Unblock (ratings at or under can be viewed).

G:	All ages	Parental Guidance
PG:	Parental Guidance	suggested
PG-13:	Parental Guidance less than 13 years old	NC17: 17 years old and above
R:	Under 17 years old,	X: Adult only
		NR: No rating

NOTE: A Lock indicates that the rating is blocked.

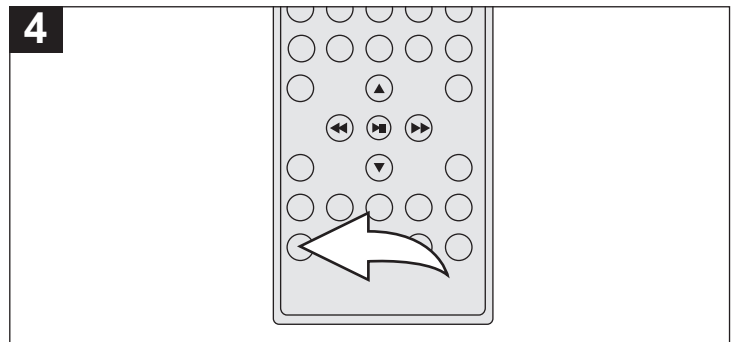

When finished, press the ZOOM/EXIT button three times to exit the menus.

TV PARENTAL CONTROL (CONTINUED)

CANADIAN ENGLISH/FRENCH RATING SET-UP

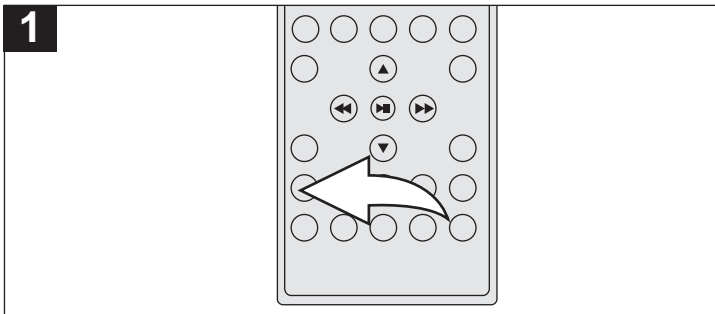

With the power on and the DTV mode selected, press the SETUP button; the menu will appear. Please refer to page 27 to enter the Parental Control menu.

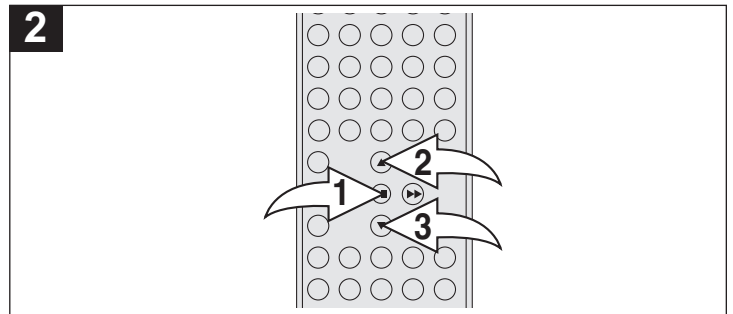

Press the Navigation ▲ and/or ▼ button to select the CANADIAN ENGLISH RATING or CANADIAN FRENCH RATING option, then press the ENTER/Play/Pause (▶||) button again.

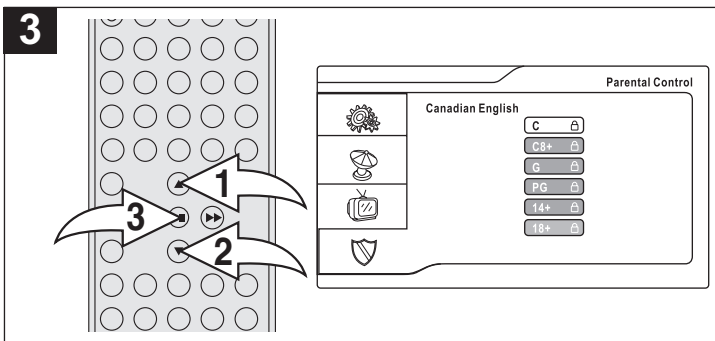

Press the Navigation ▲ and/or ▼ button to select a rating and then the ENTER/Play/Pause (▶||) button to Block (ratings at or above cannot be viewed) or Unblock (ratings at or under can be viewed). See below for rating descriptions.

NOTE: A Lock indicates that the rating is blocked.

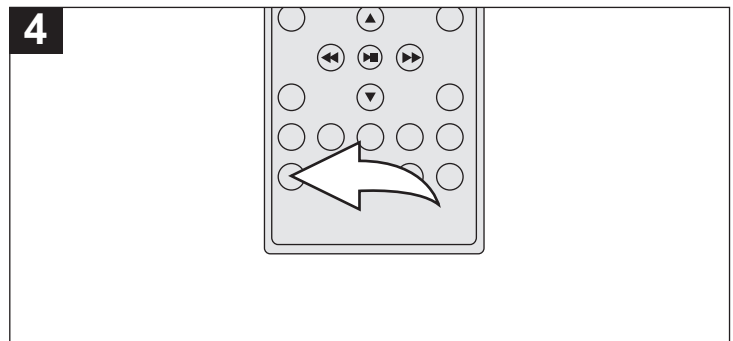

When finished, press the ZOOM/EXIT button three times to exit the menus.

CANADIAN ENGLISH

C	Children
C8	Children 8 years and older
G	General programming, suitable for all audiences
PG	Parental guidance
14+	Viewers 14 years and older
18+	Adult programming

CANADIAN FRENCH

G	Children
8 ans+	Children 8 years and older
13ans+	Children 13 years and older
16 ans+	Viewers 16 years and older
18 ans+	Adult programming

TV PARENTAL CONTROL (CONTINUED)

CHANGING THE PASSWORD

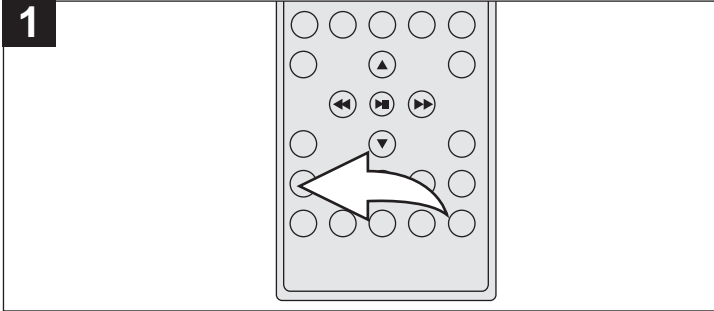

With the power on and the DTV mode selected, press the SETUP button; the menu will appear. Please refer to page 27 to enter the Parental Control menu.

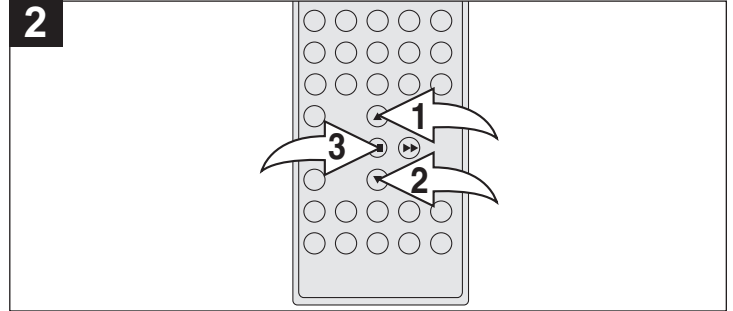

Press the Navigation ▲ ① and/or ▼ ② button to select the PIN option, then press the ENTER/Play/Pause (▶||) button ③.

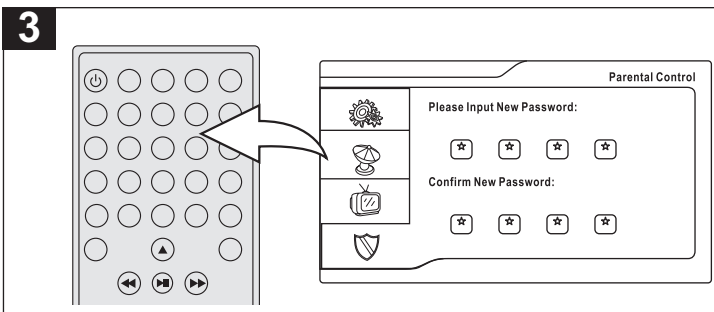

Enter the 4-digit password using the Number (0-9) buttons, then enter the 4-digit password again to confirm and "Password Changed" will appear to indicate the password has been changed.

NOTE: The default password is "1234".

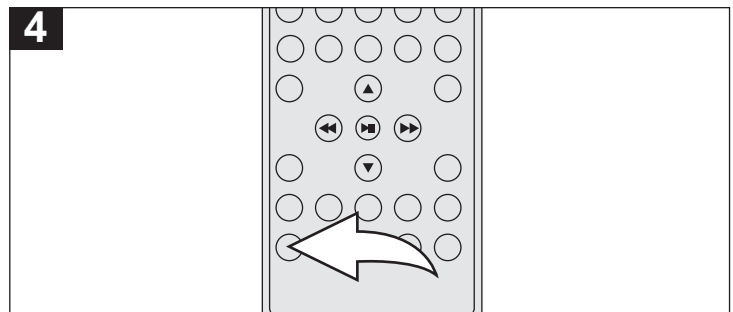

When finished, press the ZOOM/EXIT button twice to exit the menus.

DOWNLOADABLE RRT: (ATSC ONLY)

The function of Download RRT is same as the other parental control rating settings (i.e. such as TV Rating, CANADIAN FRENCH rating set up, etc.). However, these rating levels are downloaded from the corresponding program and some of the program may not have this function.

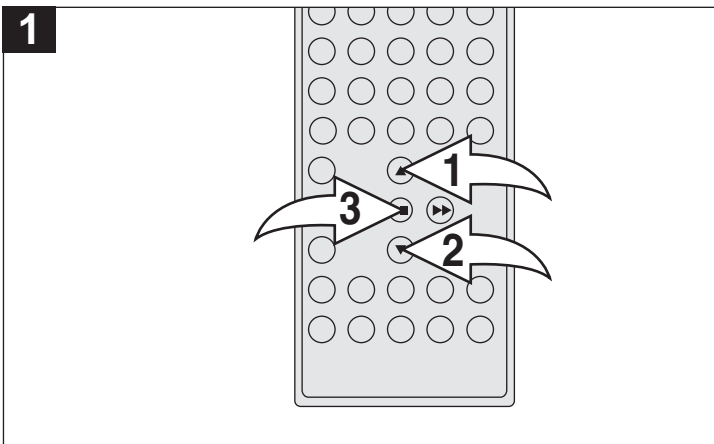

Once in the Parental Control Menu, Press the Navigation ▲ ① and/or ▼ ② button to select the DOWNLOADABLE RRT option, then press the ENTER/Play/Pause (▶||) button ③ again. Then the RRT Setting (Region Rating Table Setting) menu will appear. Use the Navigation ▲ ① and/or ▼ ② button to select the desired rating level and press the ENTER/Play/Pause (▶||) button ③ to confirm the selection.

DTV OPERATION

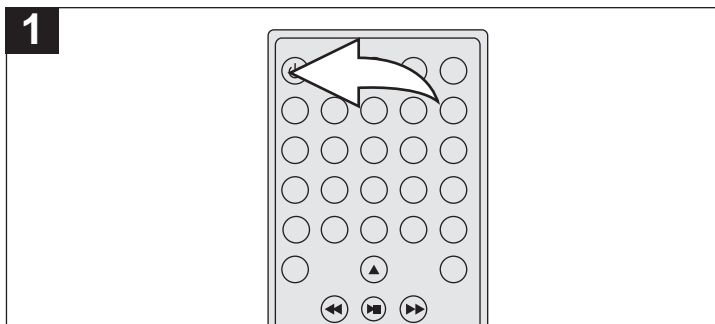

1 Press the Power button to turn the unit on; the STANDBY indicator will turn off.

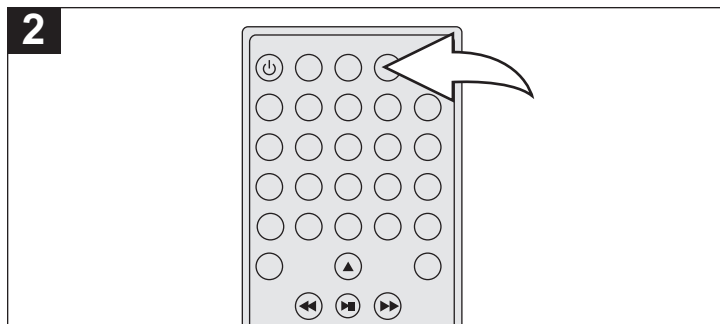

2 Press the DTV button on the remote to select the DTV option. Make sure the channels have been set into memory, see page 23.

NOTE: You can also press the SOURCE button on the main unit until the display shows ATSC to select the DTV mode. Press the CLOCK button to show the time in the display and press again to show ATSC.

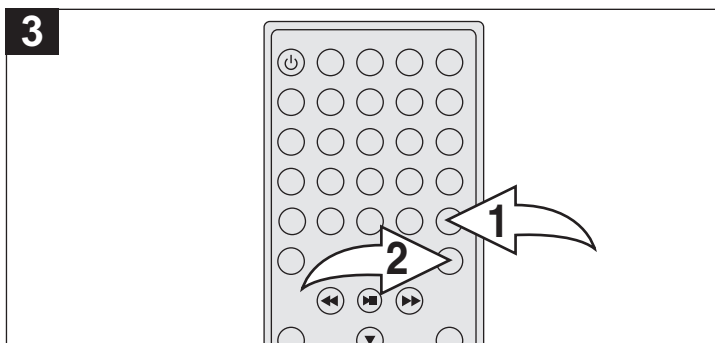

3 Adjust the volume level by pressing the VOLUME Up ❶ or Down ❷ button.

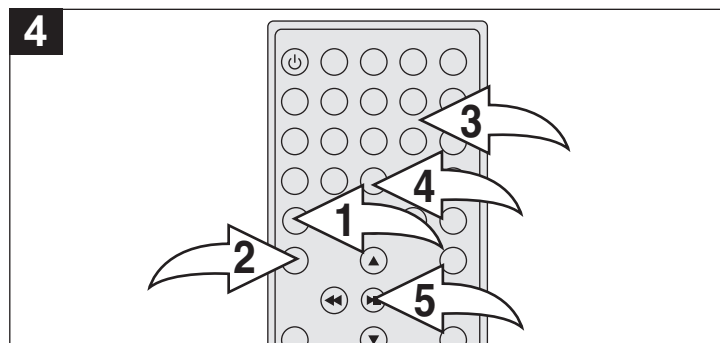

4 For proper operation, before selecting channels, they must be set into the unit's program memory, see page 23. Press and release the Channel Up/Skip (❶) button or Channel Down/Skip (❷) button. The TV automatically stops at the next channel set into memory.

ATSC Direct Channel Selection buttons (0-9) ❸

Use these buttons to select a channel. The channel number will appear at the top right corner of the screen. Enter the main channel number, then the - button ❹, then enter the sub-channel, followed by the ENTER/Play/Pause (❺) button.

DTV OPERATION (CONTINUED)

OSD/INFO

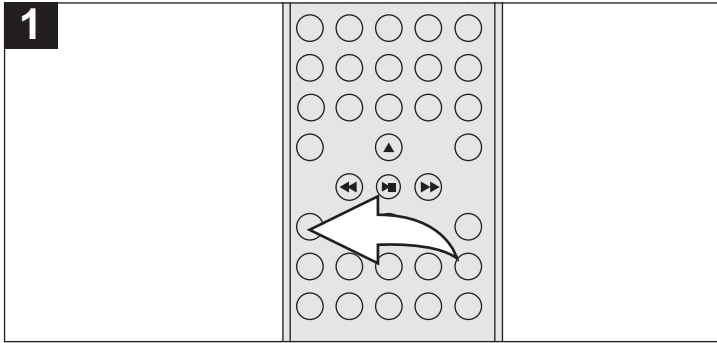

Press OSD/INFO key on remote, a sub menu will display on the top left corner of the screen showing the status of existing signal (e.g. Language, Channel Signal, Signal Strength etc.). This screen will disappear after few seconds.

VOLUME

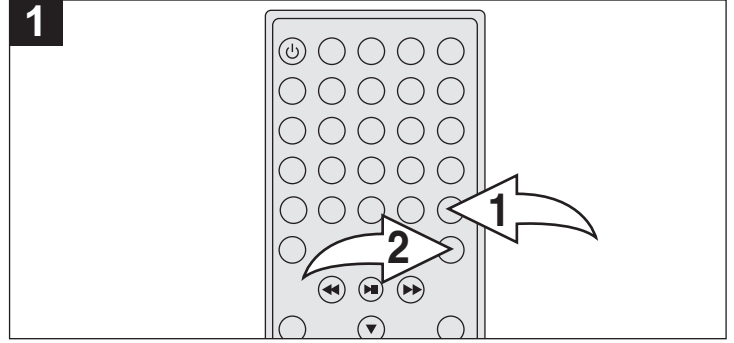

Press the VOLUME Up ❶/Down ❷ buttons to adjust the sound level.

MUTE

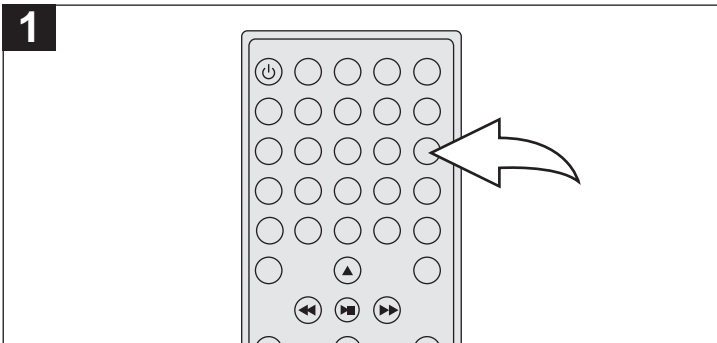

Press the MUTE button to turn off the sound; the TV's sound will be silenced and "MUTE" will appear on the screen. The sound can be turned back on by pressing this button again; "MUTE" will disappear from the screen.

EQ/BASS

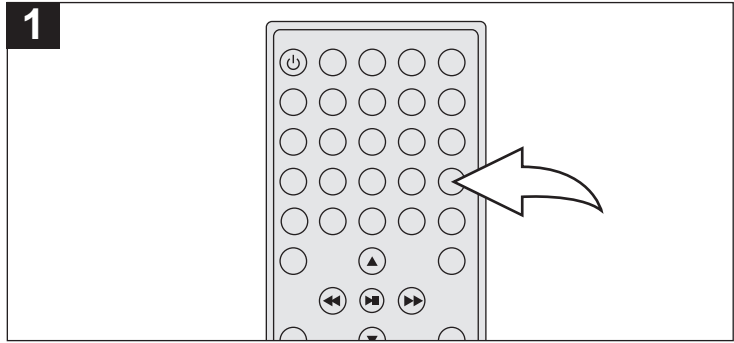

Repeatedly press the EQ/BASS button to select one of the EQ settings (Flat, Classic, Rock, Jazz or Pop) or press and hold to turn Bass Boost On or Off.

DTV OPERATION (CONTINUED)

GUIDE

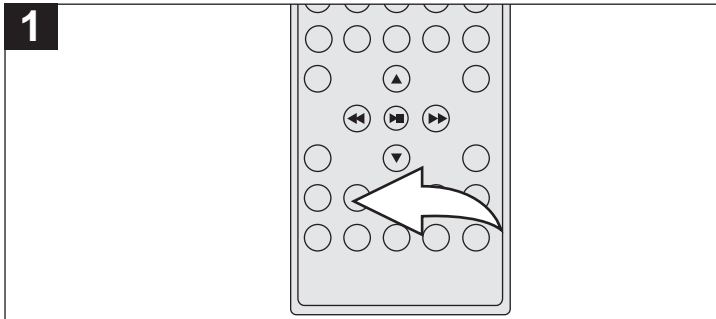

1 Press the MENU/GUIDE button; the existing signal will be reduced to a small size and move to the top left corner. The Program List will appear on the screen.

AUDIO

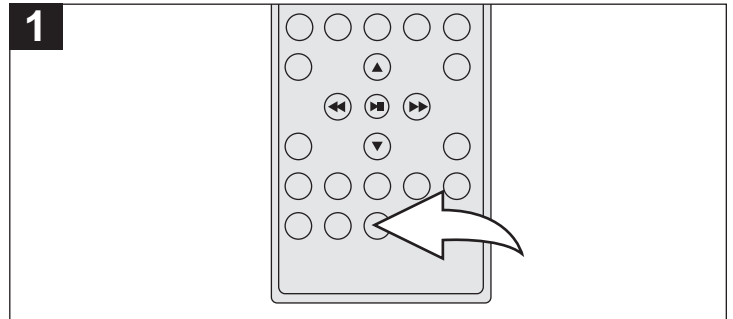

1 While using DTV, press the AUDIO button repeatedly to scroll through all available language programs.

SCALE MODE

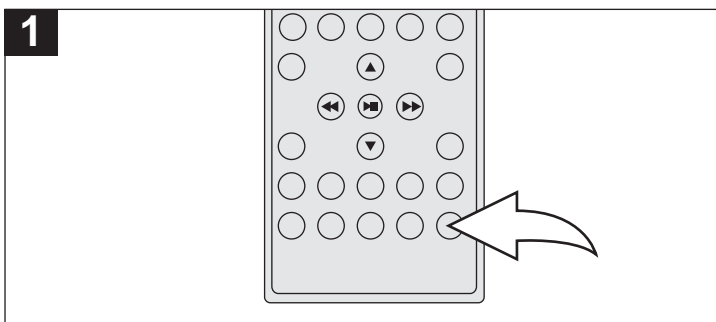

1 While using DTV, press the SCALE MODE button to set the desired screen mode, NORMAL, FILL or OVERSCAN.

ADJUSTING THE PICTURE

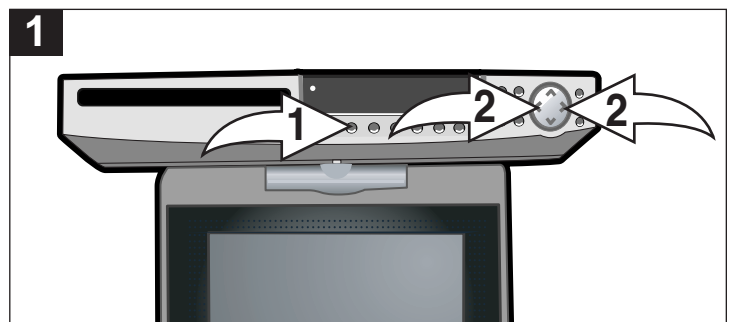

1 Press the BAND button ❶ on the main unit repeatedly to select one of the video options, BRIGHTNESS, Saturation and Screen type (Wide Screen or normal). Adjust as desired using the Navigation (◀, ▶) buttons ❷.

SETTING THE DVD MENUS

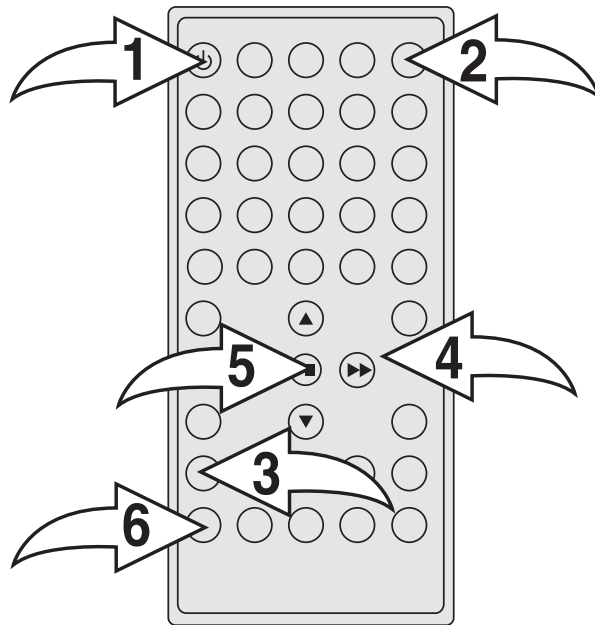

The Setup menu lets you customize the DVD player by allowing you to select various language preferences, set-up a parental level, turn screen saver on and off, adjust what type of television screen you have and more. Pages 36 to 41 describe the individual menus in detail.

1. Press the Power button ❶ to turn on the unit; the STANDBY indicator will go out. Press the DISC button ❷ to select the DVD mode.
2. Press the SETUP button ❸ to enter the Setup menu.
3. Select one of the Setup icons at the top of the screen using the Navigation (◀, ▶) buttons ❹, then press the Navigation (▼) button ❺ to select it.
4. Use the Navigation (▲, ▼) buttons ❻ to select one of the Setup options, then press the Navigation (▶) button ❹ to select it.
5. Use the Navigation (▲, ▼) buttons ❻ to select the desired setting, then press the ENTER/Play/Pause (▶||) button ❽ to make the change. Press the ZOOM/EXIT button ❾ to exit setup.

DVD SETUP MENU (CONTINUED)

GENERAL SETUP MENU (Must be in the DVD mode):

Select GENERAL SETUP using the Navigation (◀,▶) buttons, then select/change the setup option as described on page 35.

SCREEN SAVER

1

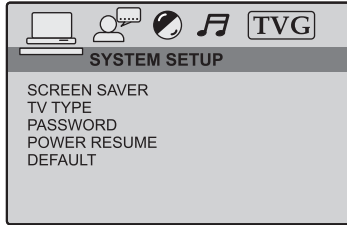

When this option is set to ON, the screen saver will come on when the unit stops for approximately three minutes. When this option is OFF, the screen saver will not come on.

TV TYPE

1

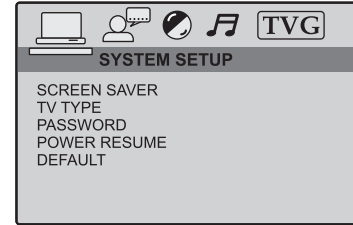

4:3 PS, Pan Scan: Video material formatted in the Pan Scan style is played back in that style (the left and right edges are cut off).

4:3 LB, Letterbox: Wide-screen images are shown on the screen with a black band at the top or bottom.

16:9, Wide: Select to fit the whole image on the screen.

PASSWORD

1

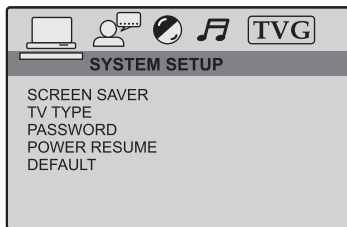

To change the password, press the Navigation (▶) button to enter the password input section. Enter the default password ("1234") using the Number buttons if this is the first time entering the password, then press the ENTER/Play/Pause (▶||) button to confirm. When the correct password is entered, the Lock icon will be opened.

Press the Navigation (▶) button again and enter the new password using the Number buttons and then press the ENTER/Play/Pause (▶||) button to confirm; the Lock icon will be locked again and the password will be changed.

NOTE: If the old password is incorrect, the Lock icon will not be opened.

DVD SETUP MENU (CONTINUED)

POWER RESUME

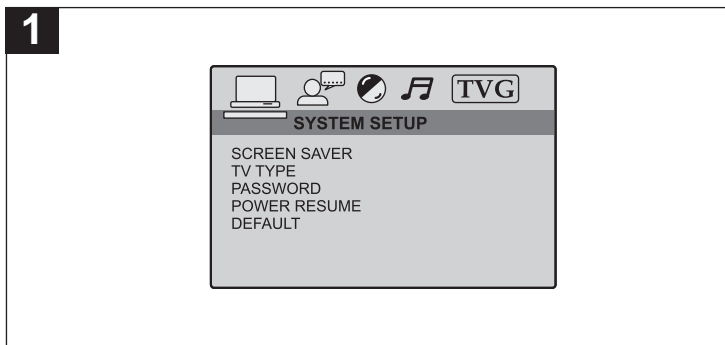

When this option is set to ON, during playback of a DVD or CD, if you open the disc compartment without pressing the STOP (■) button, when you playback the disc again or if you change the unit to another source (i.e. switch to AV OUT), when you playback the disc again, it will resume to the last segment before stopped. When this option is OFF, the segment will not be saved.

DEFAULT

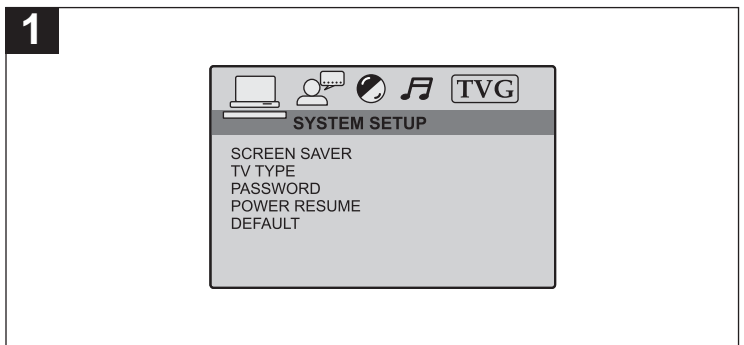

Select this option to reset all the preferences (except password) to their original factory settings.

LANGUAGE SETUP MENU:

Press the SETUP button to enter the menu, select LANGUAGE SETUP using the Navigation (◀, ▶) buttons, then press the Navigation (▼) button to select it. Select/change the Setup option as described on page 35.

OSD LANGUAGE

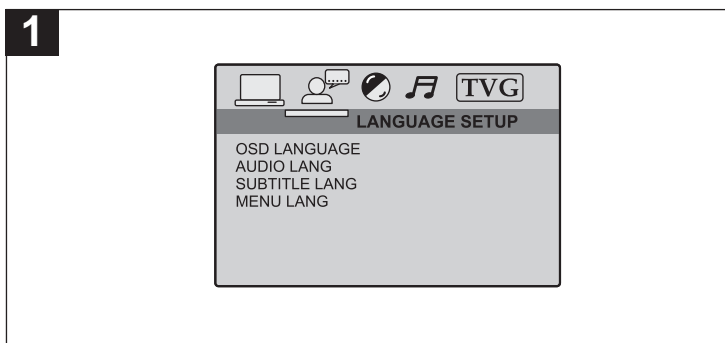

Select the desired language (ENGLISH, SPANISH OR FRENCH) for the On-Screen display to display text. Note that the DVD must have the language included in order to display it.

AUDIO LANGUAGE

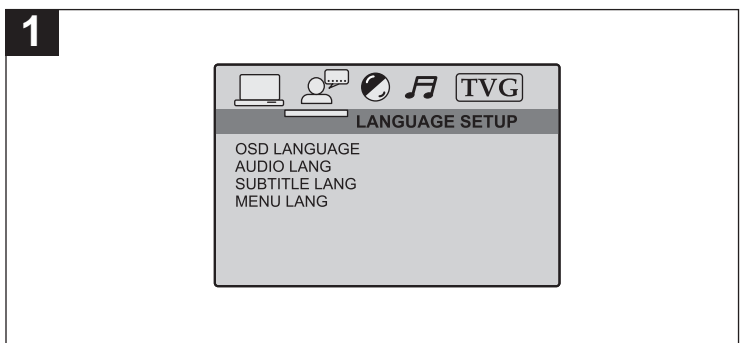

Select the language the DVD will be played back in (ENGLISH, SPANISH OR FRENCH). The DVD must be recorded in the selected language, otherwise the default language of the DVD will be played.

DVD SETUP MENU (CONTINUED)

SUBTITLE LANGUAGE

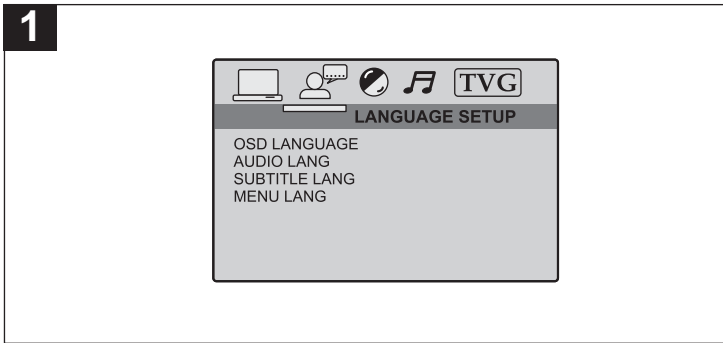

Select the language the subtitles will be in (ENGLISH, SPANISH OR FRENCH). The DVD must be recorded in the selected language, otherwise the default language of the DVD will be shown. Select OFF to turn the subtitles off.

MENU LANGUAGE

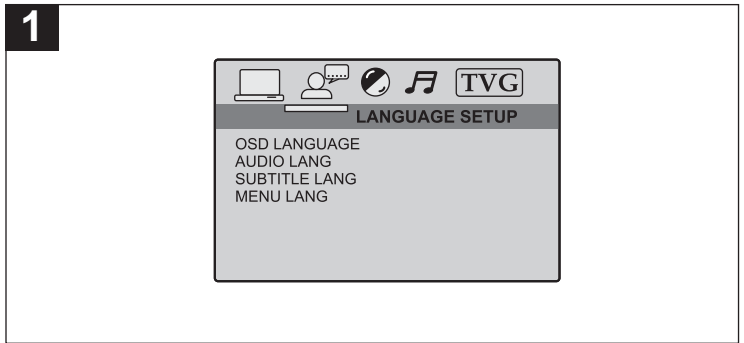

Select the language the disc menu will be in (ENGLISH, SPANISH OR FRENCH). The DVD's disc menu must be made in the selected language, otherwise the default language of the DVD will be shown.

VIDEO SETUP MENU:

Press the SETUP button to enter the menu, select VIDEO SETUP using the Navigation (◀, ▶) buttons, then press the Navigation (▼) button to select it. Use the Navigation (▲, ▼) buttons to select one of the Setup options, then press the ENTER/Play/Pause (▶||) or Navigation (▶) button to select it. Use the Navigation (▲, ▼) buttons to change the desired setting, then press the ENTER/Play/Pause (▶||) or Navigation (▶) button to return to the previous setting. Return to the previous menu as described on page 35.

PICTURE SETTINGS

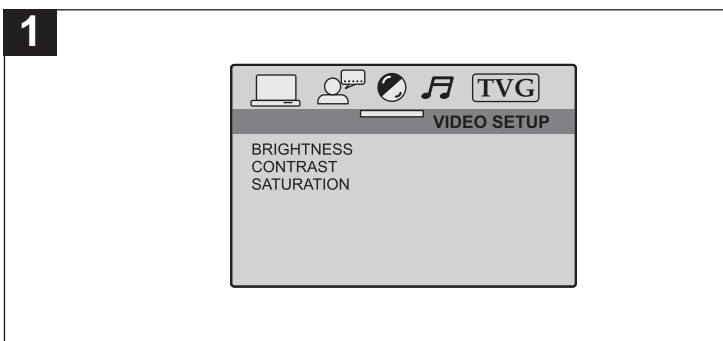

Adjust the settings as follows:

Brightness: Adjust to lighten or darken the picture.

Contrast: Adjust to increase or decrease the contrast.

Saturation: Adjust to increase or decrease the overall saturation.

SPEAKER SETUP MENU:

Press the SETUP button to enter the menu, select SPEAKER SETUP using the Navigation (◀, ▶) buttons, then press the Navigation (▼) button to select it. Select/change the Setup option as described on page 35.

DOWNMIX

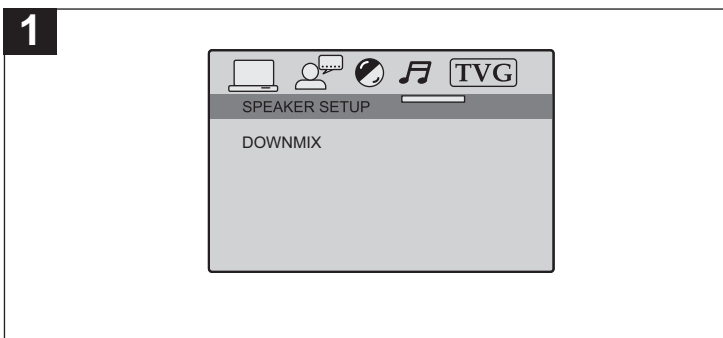

LT/RT: Select to hear the sound in theatrical downmix mode.

STEREO: Select to hear the sound in stereo downmix mode.

TVG (TV GUARDIAN)



TVGuardian® Feature

This product supports TVGuardian® Foul Language Filtering Technology, offering your family the very best control of objectionable language in your home.

HOW IT WORKS

TVGuardian® (TVG®) filters out objectionable language. When objectionable words or phrases are detected, TVG® mutes the audio. TVG® technology also offers various levels of filtering and is easily adjustable with simple on-screen menus.

NOTE: TVG® is available when viewing movies on DVD only.

TO ACTIVATE THE TVGuardian® FEATURE

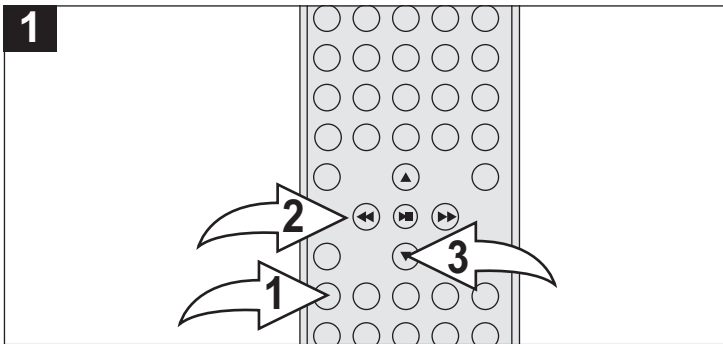

Press the SETUP button ❶ to enter the Setup Menu. Scroll to TVG using the Navigation (◀, ▶) buttons ❷, then press the Navigation (▼) button ❸.

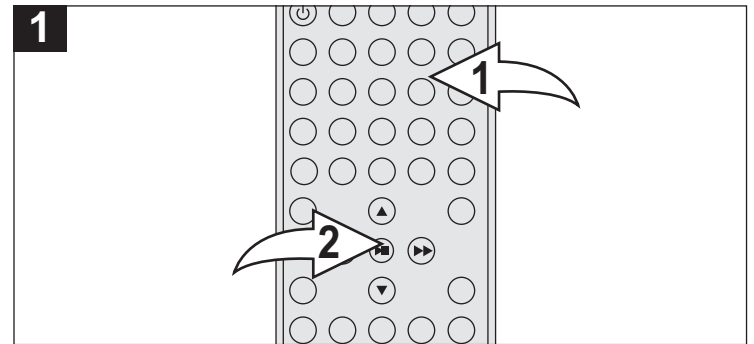

The Activation screen will appear and the Registration key will be shown on the screen; you will need the Registration key to activate the TVGuardian® feature.

To activate the TVG® feature, you must first purchase the service either by visiting www.TVGuardian.com OR by calling **1-866-884-3458**.

NOTE: To activate the TVG® feature, an activation fee is required. Phone-in activation also incurs an additional service fee.

Once you have obtained your Activation code, use the Number (0-9) buttons ❶ to enter where prompted. Once activated, you may use TVGuardian® for the life of your unit.

Then, the TVG® Password menu will appear. Input your password, then press the ENTER/Play/Pause (▶||) button ❷ to enter the TVG® Setup menu.

NOTE: The default password is "1234". Please refer to page 31 for how to change the TVG® password.

DVD SETUP MENU (CONTINUED)

TVGuardian® Setup Menu

TVG® Modes

OffNo filtering
Tolerant..Filters only the most offensive foul language
Moderate....Increased standards for language filtering
StrictFilters out all common offensive language

See the following page for TVG notes.

Word Subset Filtering

In addition to the main TVG® modes listed above, you can turn certain word subsets on or off according to your preferences.

Damn and HellFilters out variations of“Damn”/“Hell”
ReligiousFilters out references to deities
(To watch religious programming, turn this word subset off.)
SexualFilters sexually-explicit language

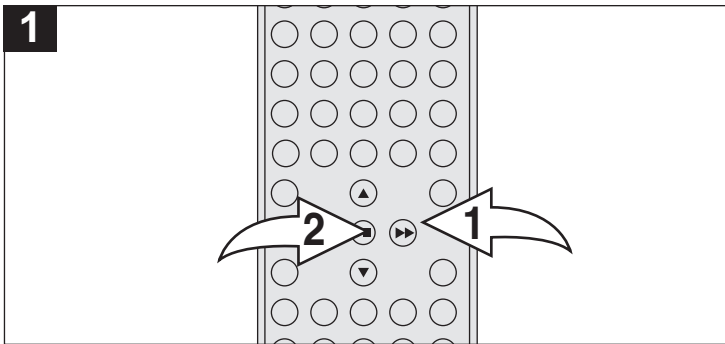

1
Activate the TVG® function and enter the menu as described on the previous page. Select TVG MODE using the Navigation (▲, ▼) buttons ❶, then press the Navigation (▶) button ❶ to enter the mode selection. Press the Navigation (▲, ▼) buttons ❶ to select between the four modes described above (Off, Tolerant, Moderate, Strict), then press the ENTER/Play/Pause (▶||) button ❷ to confirm.

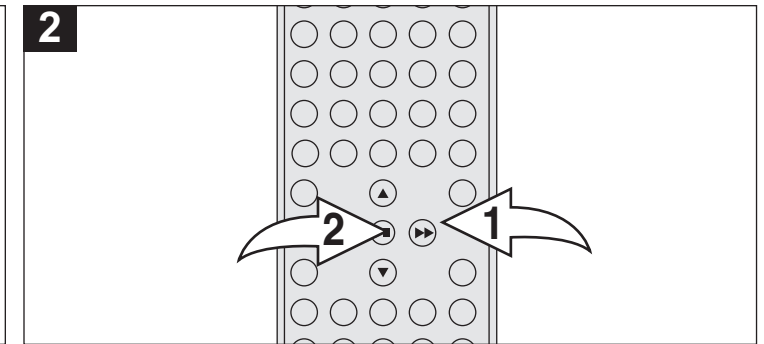

2
If you have selected any TVG mode except Off, you can then use the Navigation (▲, ▼) buttons ❶ to select HELL/DAMN, RELIGIOUS and/or SEXUAL. Press the Navigation (▶) button ❶ to enter the mode selection. Press the Navigation (▲, ▼) buttons ❶ to select between Filtered and Off (select Filtered to filter the word subset), then press the ENTER/Play/Pause (▶||) button ❷ to confirm.

TVG HELP

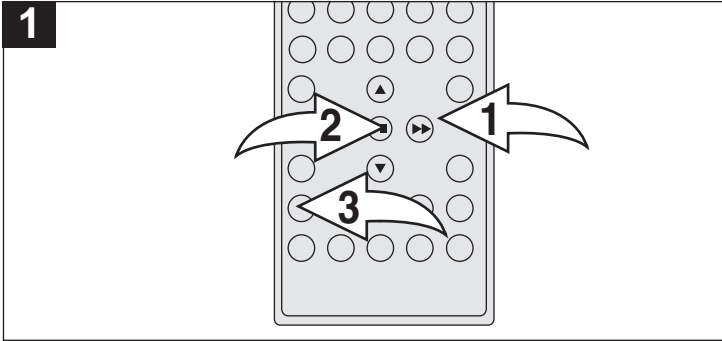

While the TVG MODE is set to Off, you can press the Navigation (▲, ▼) buttons ❶ to select TVG HELP. Press the ENTER/Play/Pause (▶||) button ❷ and a TVG Help screen will appear. The TVG Help page will display the TVGuardian Web site, as well as some additional information. Press the SETUP button ❸ to exit the screen.

NOTE:

- TVG[®] filters 95% of foul language in closed captioned words; TVG[®] does not filter out scenes or do “voice-overs”. Errors in the CC can cause TVG[®] to miss words/phrases. TVG[®] works on media that includes CC information. You can verify whether a DVD supports CC by looking for the CC logo on the back cover of the DVD case.

BASIC OPERATION (GENERAL)

IMPORTANT:

When “Invalid Key” appears while pressing a button, this means that the corresponding function cannot be performed either on the disc inserted, or in the selected mode.

RESUME

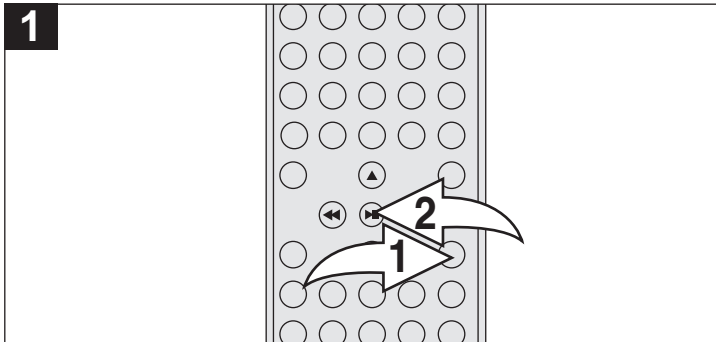

To stop playback, press the Stop (■) button ❶; “PRE-STOP” will appear on the TV screen. Because the unit will remember where you stopped, simply press the ENTER/Play/Pause (▶||) button ❷ to resume playback where you left off (resuming playback).

If the Stop (■) button ❶ is pressed twice, the unit will stop completely.

VOLUME

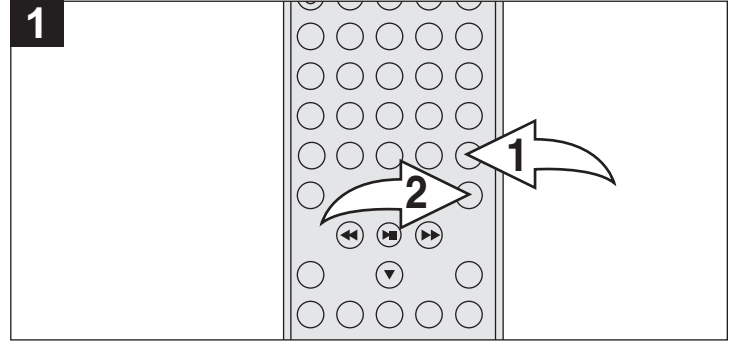

Press the VOLUME Up ❶/Down ❷ buttons to adjust the sound level.

MUTE

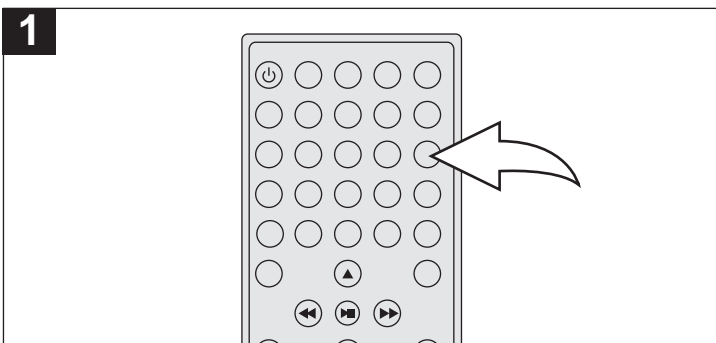

Press the MUTE button ❶ to turn off the sound; the TV's sound will be silenced and “MUTE” will appear on the screen. The sound can be turned back on by pressing this button again; “MUTE” will disappear from the screen.

EQ/BASS

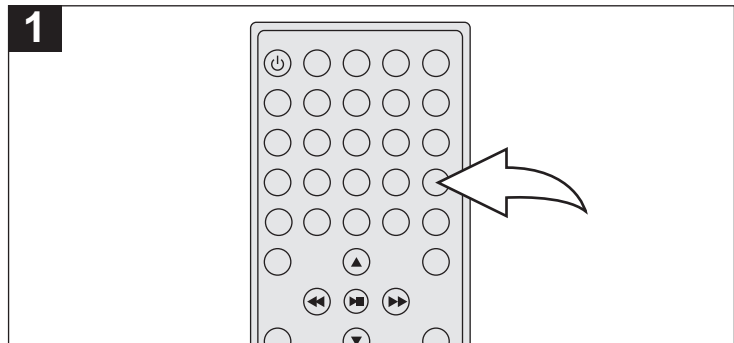

Repeatedly press the EQ/BASS button to select one of the EQ settings (Flat, Classic, Rock, Jazz or Pop) or press and hold to turn Bass Boost On or Off.

DVD OPERATION

IMPORTANT NOTES:

- “INVALID KEY” will appear on the TV screen during operation if you try to access a function that is not available on the disc.
- Some discs may take a few seconds to load.
- If a disc is inserted incorrectly, dirty, damaged, or is not present at all, “NO DISC” will appear in the display.
- Always hold the disc without touching either of its surfaces. When inserting a disc, position it with the printed title side facing up, align it with the guides and place it in its proper position.
- It is important that you read the manual that accompanies the DVD disc as there are features that are on this unit that cannot be used with certain DVDs. There are also extra features that are different for each DVD disc, so they are not explained in this owner’s manual.

PLAYBACK OF A DVD

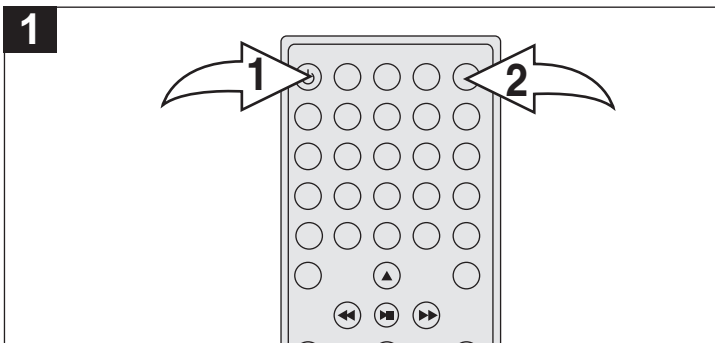

Press the Power button ❶ to turn on the unit; the STANDBY indicator will go out. Press the DISC button ❷ to select the DVD mode.

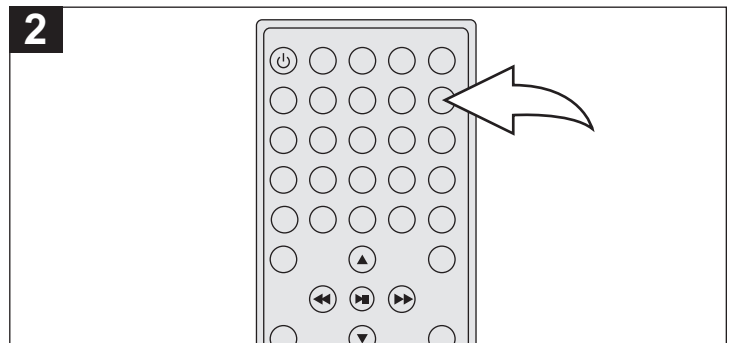

Press the OPEN/CLOSE button to open the compartment. Insert a disc with the label side facing up into the disc tray. Press the OPEN/CLOSE button to close the compartment.

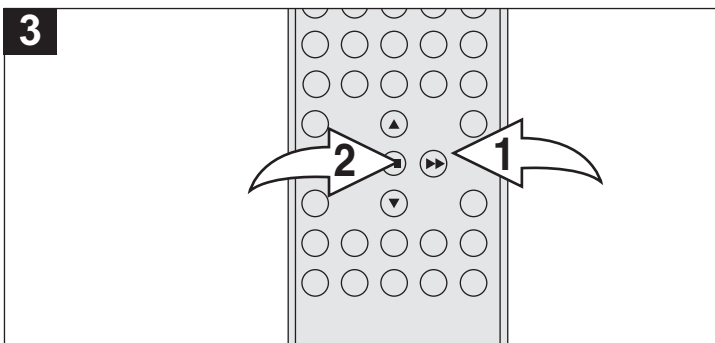

After loading, the menu screen of the DVD should appear. Use the Navigation (◀, ▶, ▲, ▼) buttons ❶ to select the desired option and the ENTER/Play/Pause (▶||) button ❷ to select it.

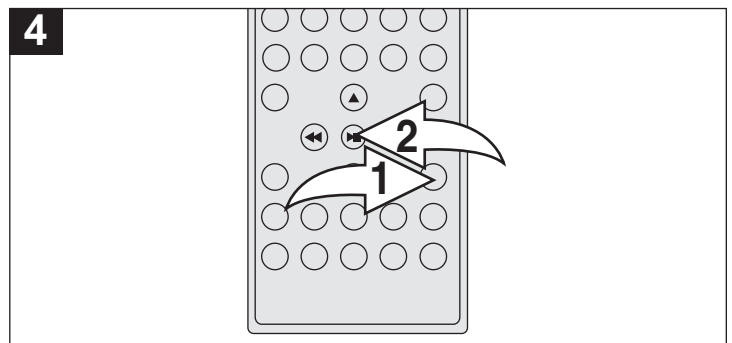

To stop playback, press the Stop (■) button ❶; “PRE-STOP” will appear on the TV screen. Because the unit will remember where you stopped, simply press the ENTER/Play/Pause (▶||) button ❷ to resume playback where you left off (resuming playback). If the Stop (■) button ❶ is pressed twice, the unit will stop completely.

NOTES:

- If a MENU appears on the TV screen, press the Navigation (◀, ▶, ▲, ▼) buttons to select the desired option/item, then press the ENTER/Play/Pause (▶||) button. Please make sure to refer to the disc’s jacket or case for additional information.
- Resuming playback may not work on all discs.
- Press the CLOCK button to show the time in the display and press again to show the Title/Chapter playback time.

DVD OPERATION (CONTINUED)

SKIP

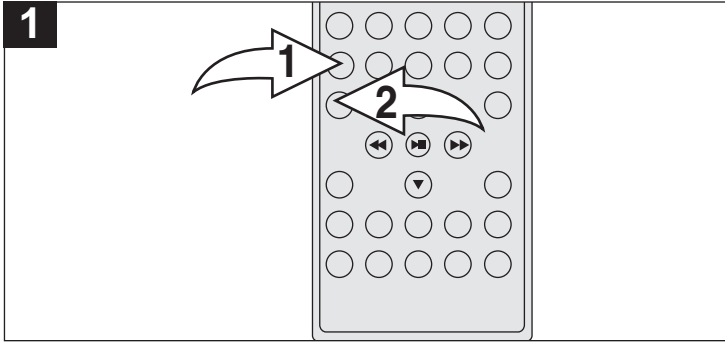

Press the Channel Up/Skip (▶▶) Button ❶ to advance the DVD to the beginning of the next chapter.

Press the Channel Down/Skip (◀◀) Button ❷ to move the DVD to the beginning of the current or previous chapters.

FAST SEARCH

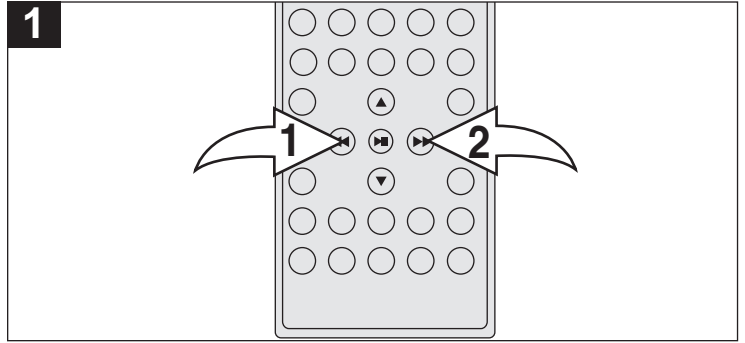

During playback, press either the Navigation ▶/Search ▶▶ ❶ or Navigation ◀/Search ◀◀ ❷ button to move the DVD forward or backward at double (x2) speed to locate a specific section. Repeatedly press these buttons and the speed will increase to x2, x4, x8, x20 and resume normal playback. The DVD will move forward or backward at high speed until the ENTER/Play/Pause (▶||) button ❸ is pressed; normal playback will resume at that point.

ZOOM

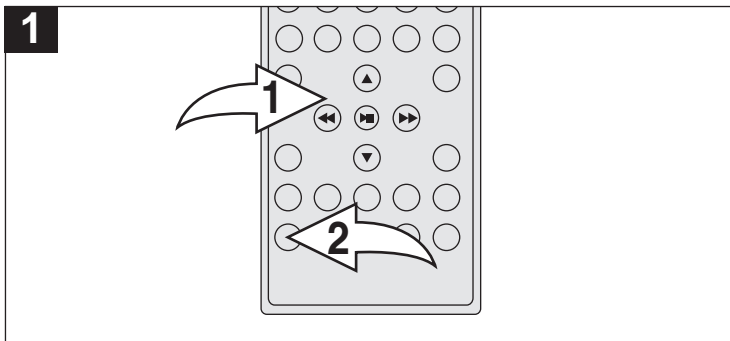

Press the EXIT/ZOOM button ❶ once and the unit will zoom in 2x. Press a second or third time and the unit will zoom in 3x, 4x. Press a fourth time and the unit will zoom out 1/2x. Press a fifth or sixth time and the unit will zoom out 1/3x, 1/4x. Use the Navigation (◀, ▶, ▲, ▼) buttons ❷ while zooming in to move the image on the TV screen. Press the EXIT/ZOOM button ❶ once more to cancel the zoom function. This is not available on all discs.

PAUSE

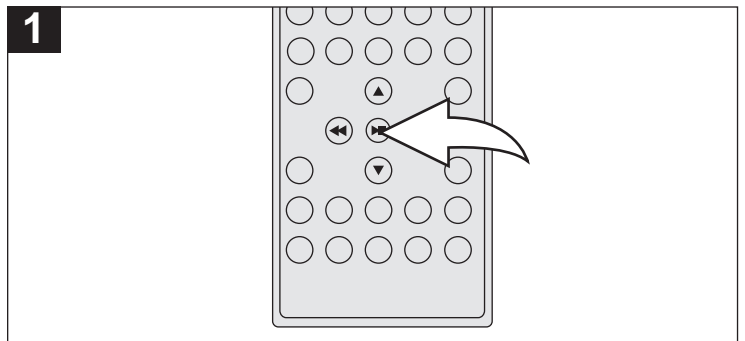

Press the ENTER/Play/Pause (▶||) button once to pause the picture. Press again to resume normal playback.

DVD OPERATION (CONTINUED)

TITLE/CHAPTER/TIME SEARCH

Use this feature to directly go to a specific title, chapter and/or time.

1

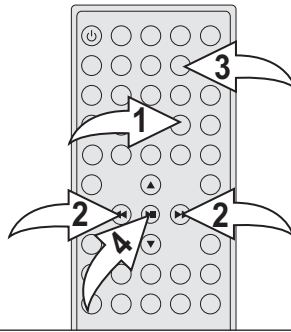

Press the GOTO button ❶ once.

Press the Navigation (◀,▶) buttons ❷ to select TITLE (TT), then use the Number (0-9) buttons ❸ to select the desired title number. Then press the ENTER/Play/Pause (▶||) button ❹; playback will start immediately.

OR

Press the Navigation (◀,▶) buttons ❷ to select CHAPTER (CH), then use the Number (0-9) buttons ❸ to select the desired chapter number (i.e, for 003, press "0", "0", "3"). Then press the ENTER/Play/Pause (▶||) button ❹; playback will start immediately.

OR

Press the Navigation (◀,▶) buttons ❷ to select the time, then use the Number (0-9) buttons ❸ to select the desired time (Hour/Minutes/Seconds). Then press the ENTER/Play/Pause (▶||) button ❹; playback will start immediately.

REPEAT PLAYBACK

While playing back a DVD, this unit can repeatedly play back a chapter or title.

1

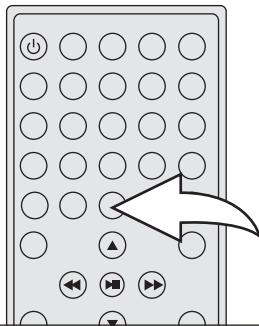

While in the Playback mode, press the REPEAT button once; "CHAPTER" will appear on the screen for a few seconds and the currently playing Chapter will repeat continuously.

Press the REPEAT button a second time; "TITLE" will appear on the screen for a few seconds and the currently playing Title will repeat continuously.

Press the REPEAT button once more to cancel Repeat mode.

1

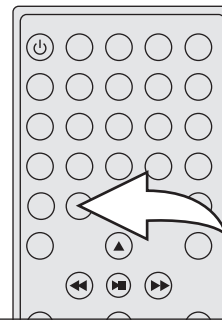

While in the Playback mode, press the Repeat A-B button to define where you want the section to start. Press the Repeat A-B button again to define where you would like the section to end, the unit will then play the selected area continuously. Press the Repeat A-B button again to cancel Repeat A-B mode.

NOTE:

- Repeat may not work properly with some discs.

DVD OPERATION (CONTINUED)

TITLE MENU

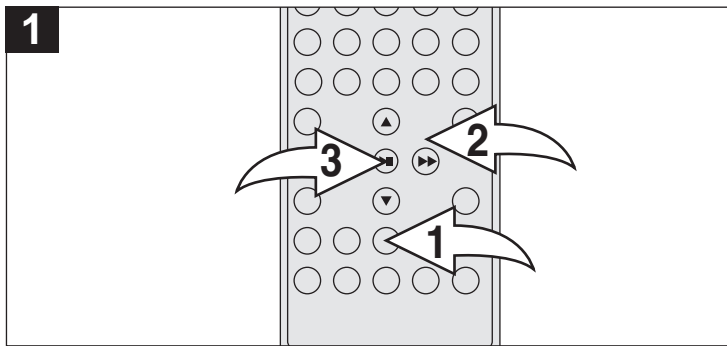

Press the TITLE button ❶, and the Title Menu of the disc will appear. Use the Navigation (◀, ▶, ▲, ▼) buttons ❷ to select the desired option, and then press the ENTER/Play/Pause (▶||) button ❸.
This is not available on all discs.

SUBTITLE MENU

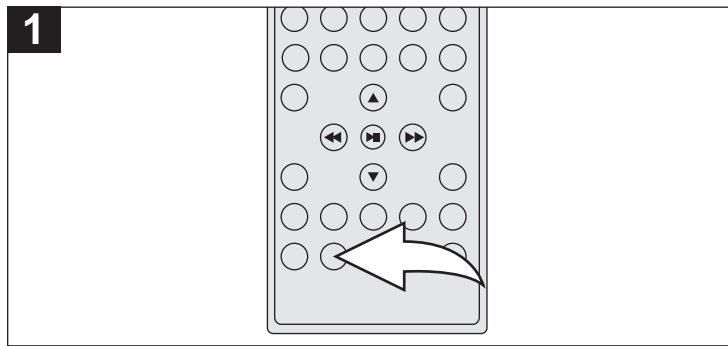

Press the SUBTITLE MENU button repeatedly to select a subtitle language, and to turn the subtitle menu on/off. This feature is not available on all discs.

DVD MENU

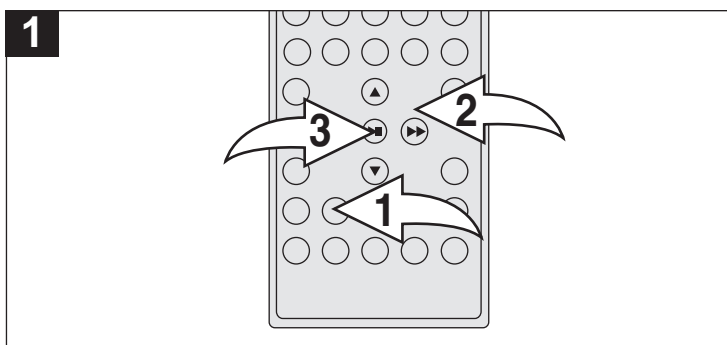

Press the MENU button ❶, and the Main Menu of the disc will appear. Use the Navigation (◀, ▶, ▲, ▼) buttons ❷ to select the desired option, and then press the ENTER/Play/Pause (▶||) button ❸.
This is not available on all discs.

OSD/INFO

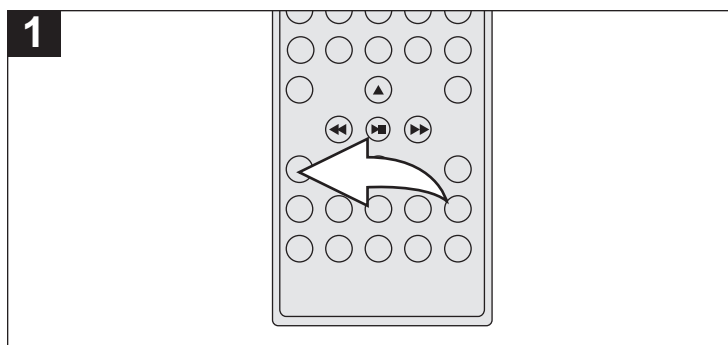

When in the DVD playback mode, press the OSD/INFO button once to display the disc type, track, chapter and elapsed playing time. Press a second time to display the Language, Language type, Audio type, Subtitle mode and Angle. Press a third time and the OSD information will disappear from the display.

ADJUSTING THE PICTURE

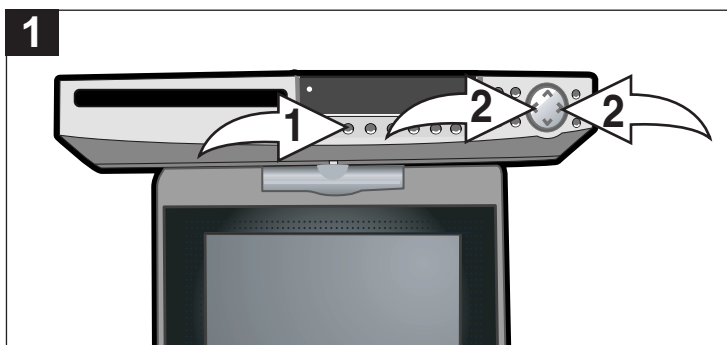

When in the DVD mode, press the BAND button ❶ on the main unit repeatedly to select one of the video options, BRIGHTNESS, Saturation and Screen type (Wide Screen or normal). Adjust as desired using the Navigation (◀, ▶) buttons ❷.

ANGLE

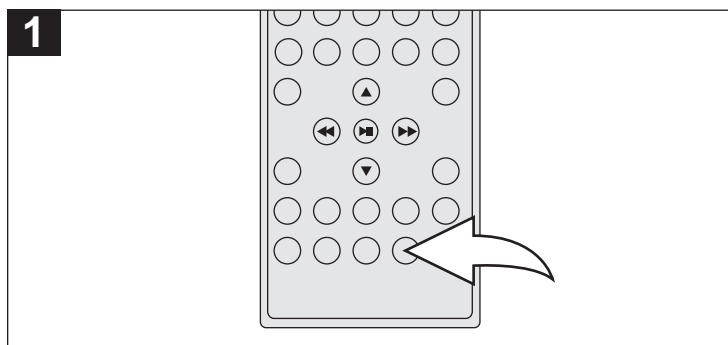

Some discs may contain scenes which have been shot simultaneously from a number of different camera angles. This feature only works on discs with more than one camera angle. The jacket will be marked with "◻". Press the ANGLE button repeatedly to select an alternate angle.
This feature is not available on all discs.

DVD OPERATION (CONTINUED)

PROGRAMMED PLAYBACK

The DVD player in this unit has a 16 chapter programmable memory that allows you to program up to 16 chapters on any disc for playback in any desired order. You may program 16 different chapters or you may also program certain chapters to play more than once. To perform Programmed Playback, proceed as follows:

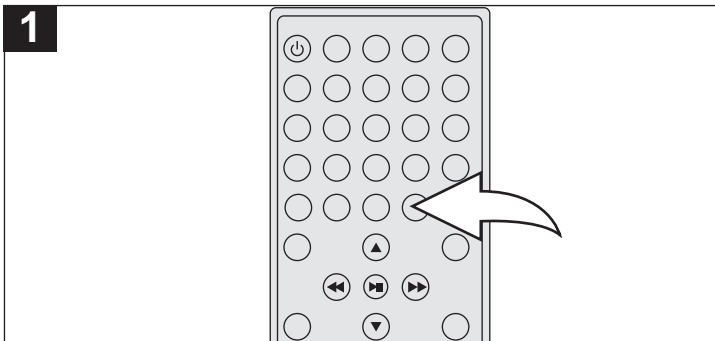

While in the DVD mode, press the PROG button; the Program menu will appear on the TV screen.

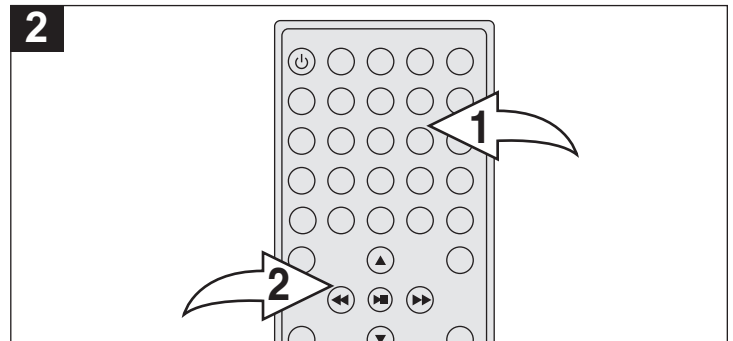

Select the first title and chapter to be played back using the Number (0-9) buttons ❶. Use the Navigation (◀, ▶, ▲, ▼) buttons ❷ to move the cursor.

NOTE:

- To enter a title or chapter number larger than 9, simply enter the two digit number.

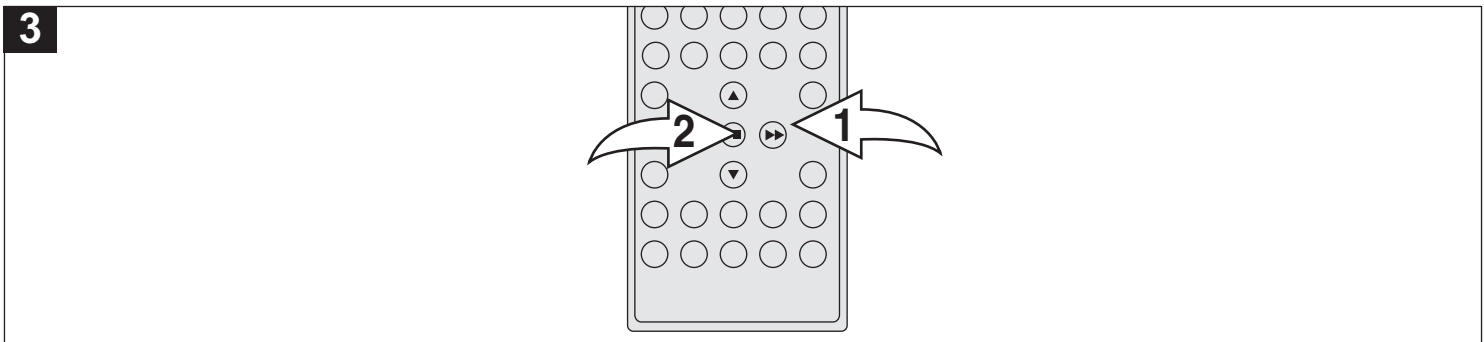

Repeat step 2 until all desired chapters have been programmed (up to 16). Use the Navigation (◀, ▶, ▲, ▼) buttons ❶ to select "PLAY" at the bottom of the Program menu; then press the ENTER/Play/Pause (▶||) button ❷ to begin Programmed playback. Playback will begin on the first chapter that you programmed and the player will continue to play all of the chapters that you programmed in the order in which you programmed them.

TO CLEAR ALL THE PROGRAMS:

Use the Navigation (◀, ▶, ▲, ▼) button to select "CLEAR" at the bottom of the Program menu; then press the ENTER/Play/Pause (▶||) button.

TO MODIFY A PROGRAM:

To modify the programmed order, use Navigation (◀, ▶, ▲, ▼) buttons to highlight the modified item and re-enter the new chapter you want to program directly.

CD OPERATION

PLAYBACK OF A CD

Press the CLOCK button to show the time in the display and press again to show the CD playback time.

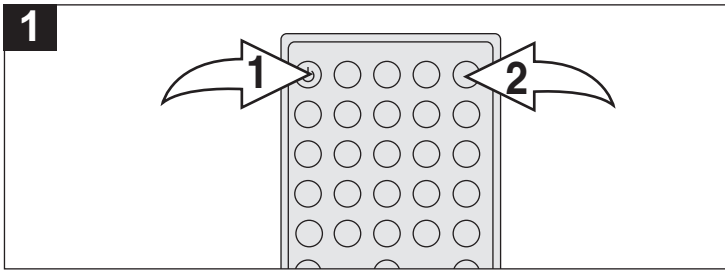

Press the Power button ❶ to turn on the unit; the STANDBY indicator will go out. Press the DISC button ❷ to select the DVD mode.

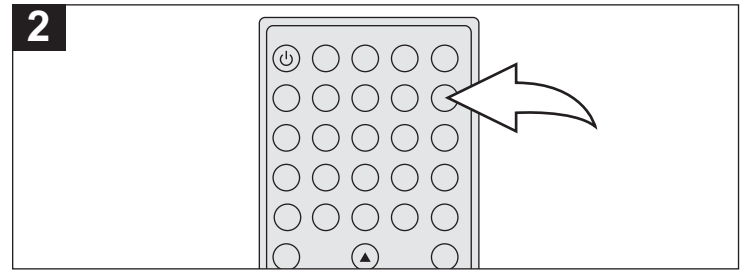

Press the OPEN/CLOSE button to open the compartment. Insert an audio CD with the label side facing up into the disc tray. Press the OPEN/CLOSE button to close the compartment. Playback will start immediately.

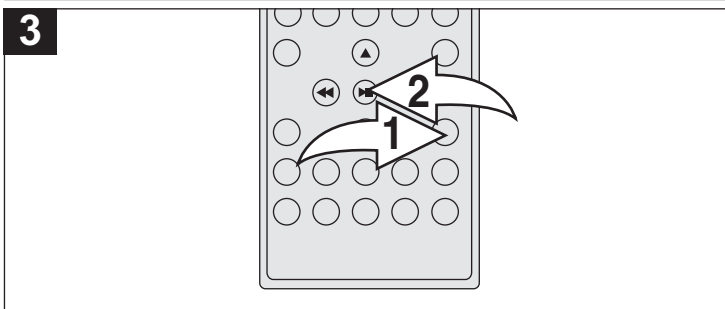

To stop playback, press the Stop (■) button ❶; "PRE-STOP" will appear on the TV screen. Because the unit will remember where you stopped, simply press the ENTER/Play/Pause (▶||) button ❷ to resume playback where you left off (resuming playback). If the Stop (■) button ❶ is pressed twice, the unit will stop completely.

PAUSE

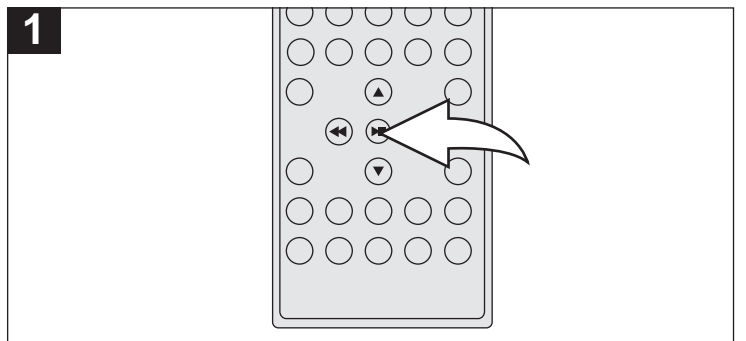

Press the ENTER/Play/Pause (▶||) button once to pause the CD. Press again to resume normal playback.

SELECTING TRACKS/FILES USING THE DIRECT CHANNEL SELECTION/NUMBER BUTTONS (0-9)

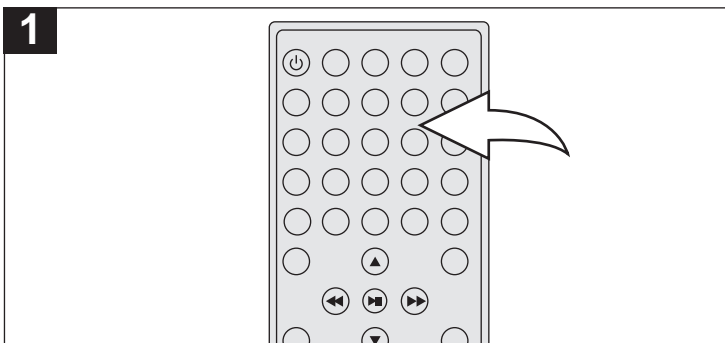

Press the Number buttons (0-9) corresponding to the track number you would like to play, and the unit will playback the desired track automatically.

SELECTING TRACKS USING THE NEXT/PREV BUTTONS

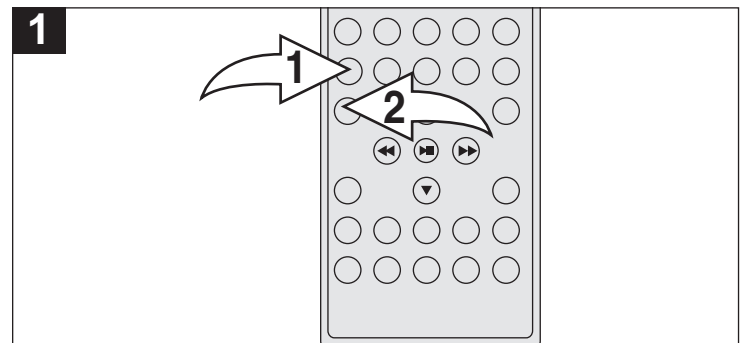

Press the Channel Up/Skip (▶▶) Button ❶ to advance the disc to the beginning of the next track.

Press the Channel Down/Skip (◀◀) Button ❷ to move the disc to the beginning of the current or previous tracks.

CD OPERATION (CONTINUED)

FORWARD ►►/REVERSE ◀◀

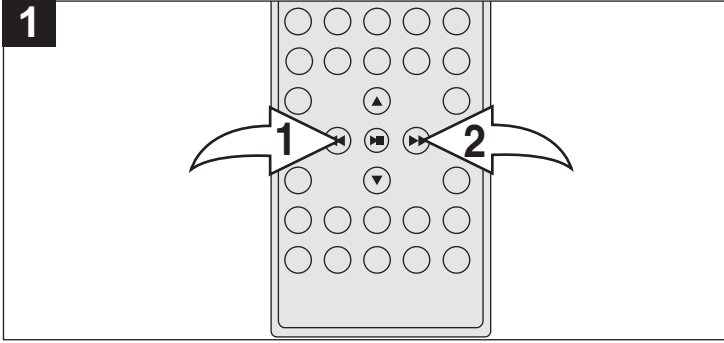

During playback, press either the Navigation ►/Search ►► ❶ or Navigation ◀/Search ◀◀ ❷ button to move the disc forward or backward at double (x2) speed to locate a specific section. Repeatedly press these buttons and the speed will increase to x2, x4, x8, x20 and resume normal playback. The disc will move forward or backward at high speed until the ENTER/Play/Pause (►||) button ❸ is pressed; normal playback will resume at that point.

REPEAT ONE/ALL PLAY

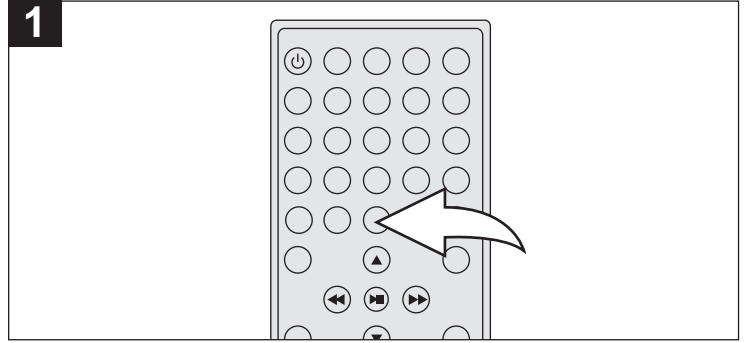

Press the REPEAT button to cycle through the following options: REP 1 (will repeat the selected track continuously until the STOP button is pressed), REP ALL (will repeat the entire disc continuously until the STOP button is pressed) or OFF.

OS/INFO

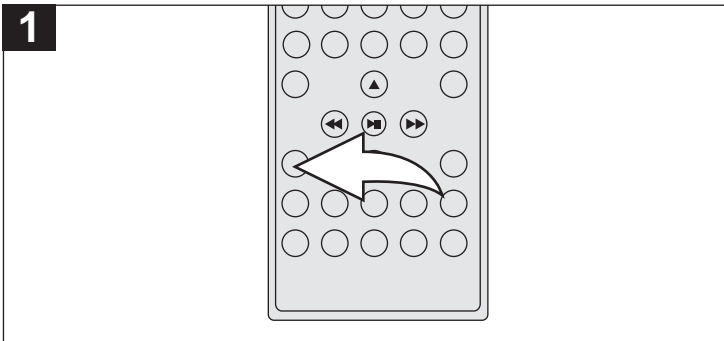

When in the CD playback mode, press the OSD/INFO button once to display the track, Repeat mode and elapsed playing time. Press a second time and the OSD information will disappear from the display.

ADJUSTING THE PICTURE

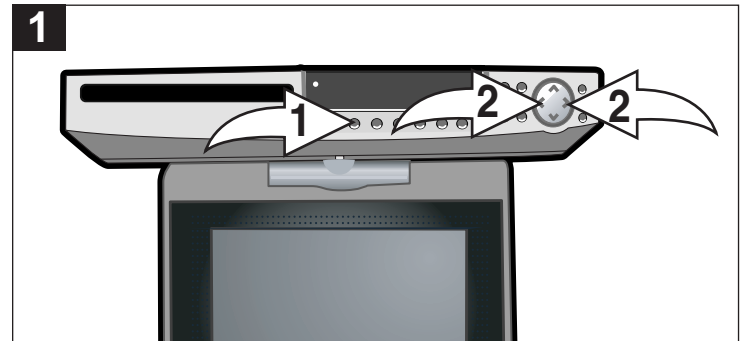

Press the BAND button ❶ on the main unit repeatedly to select one of the video options, BRIGHTNESS, Saturation and Screen type (Wide Screen or normal). Adjust as desired using the Navigation (◀, ►) buttons ❷.

MP3 OPERATION

PLAYBACK OF AN MP3 DISC

Press the CLOCK button to show the time in the display and press again to show the Disc playback time.

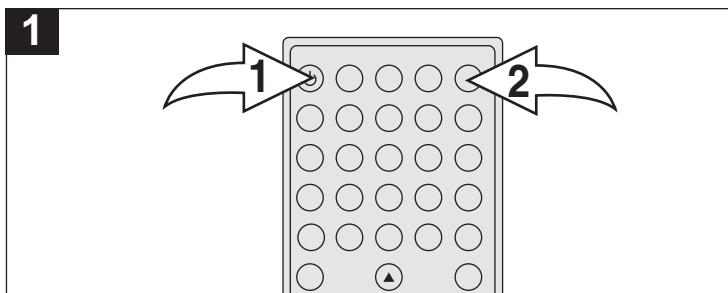

Press the Power button ❶ to turn on the unit; the STANDBY indicator will go out. Press the DISC button ❷ to select the DVD mode.

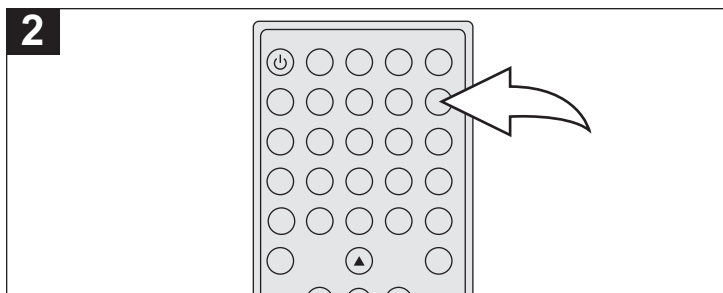

Press the OPEN/CLOSE button to make sure there is not a disc in the compartment. Insert an MP3 CD with the label side facing up into the disc tray. Press the OPEN/CLOSE button to close the compartment. Playback will start immediately.

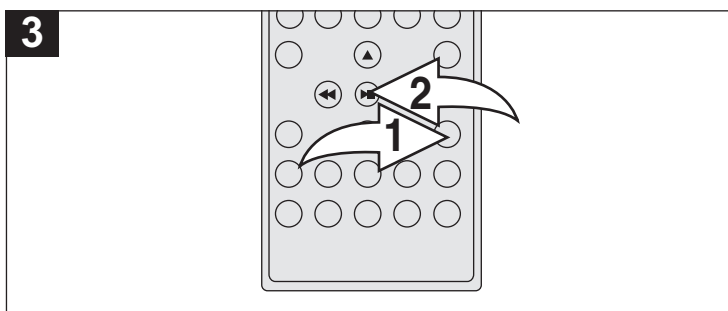

To stop playback, press the Stop (■) button ❶; "PRE-STOP" will appear on the TV screen. Because the unit will remember where you stopped, simply press the ENTER/Play/Pause (▶||) button ❷ to resume playback where you left off (resuming playback).

If the Stop (■) button ❶ is pressed twice, the unit will stop completely.

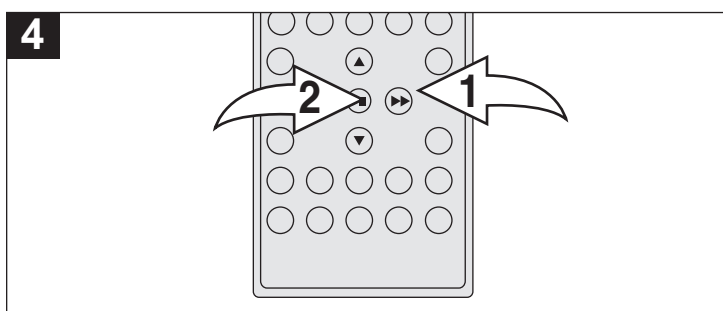

Press the Navigation ◀ button ❶ and select the desired folder using the Navigation (▲, ▼) buttons ❶. Then, press the ENTER/Play/Pause (▶||) button ❷ to show all the tracks inside the folder. (If you enter the folder number, playback of the first track of the first folder will begin automatically.) Press the Navigation (▶) button ❶ and then the Navigation (▲, ▼) button ❶ to select the track. You can also press the Navigation ◀ button ❶ to select the folder again.

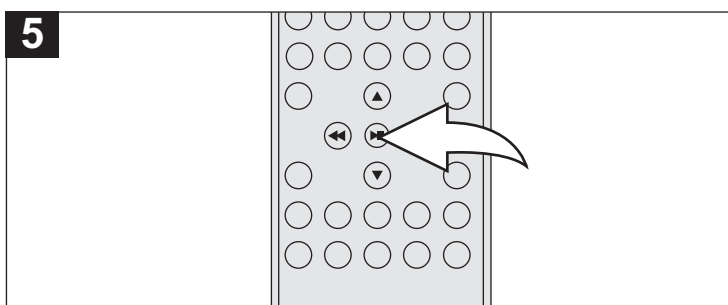

Press the ENTER/Play/Pause button (▶||) to begin playback of the selected file to start playback.

NOTES:

- The blue cursor indicates the currently playing file and the yellow cursor indicates the file to be selected.
- You can press the Navigation (◀, ▶, ▲, ▼) and ENTER/Play/Pause button to select the Music or Picture logo at the bottom of the screen which will show the music or picture files inside the disc.

PAUSE

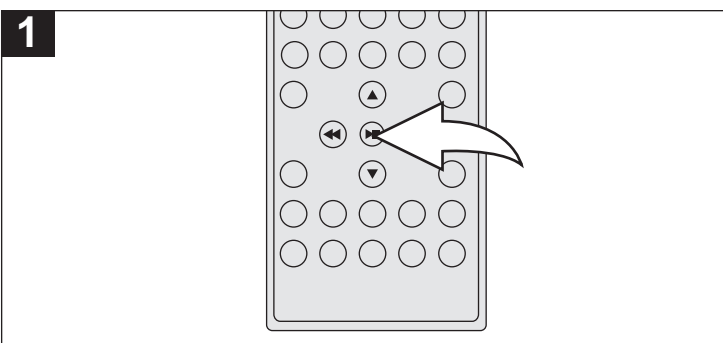

Press the ENTER/Play/Pause (▶||) button once to pause the playback. Press again to resume normal playback.

MP3 OPERATION (CONTINUED)

SELECTING TRACKS USING THE NEXT/PREV BUTTONS

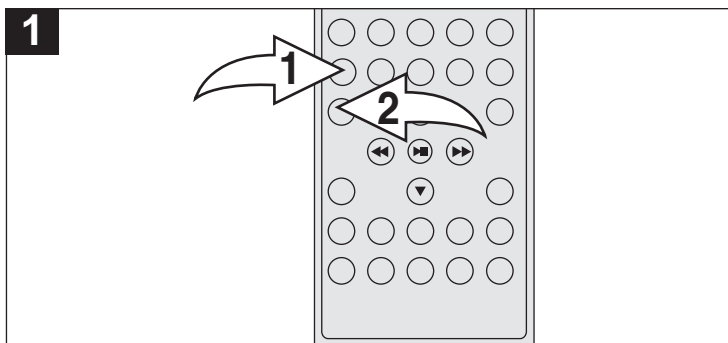

Press the Channel Up/Skip (1) button to advance the disc to the beginning of the next file.

Press the Channel Down/Skip (2) button to move the disc to the beginning of the current or previous files.

FORWARD ►►/REVERSE ◀◀

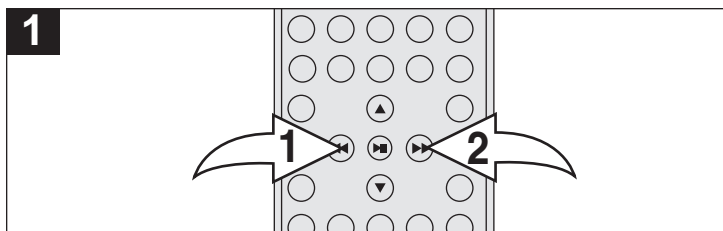

During playback, press either the Navigation ►/Search ► 1 or Navigation ◀/Search ◀ 2 button to move the disc forward or backward at double (x2) speed to locate a specific section. Repeatedly press these buttons and the speed will increase to x2, x4, x8, x20 and resume normal playback.

The disc will move forward or backward at high speed until the ENTER/Play/Pause (►||) button 3 is pressed; normal playback will resume at that point.

REPEAT ONE/ALL PLAY

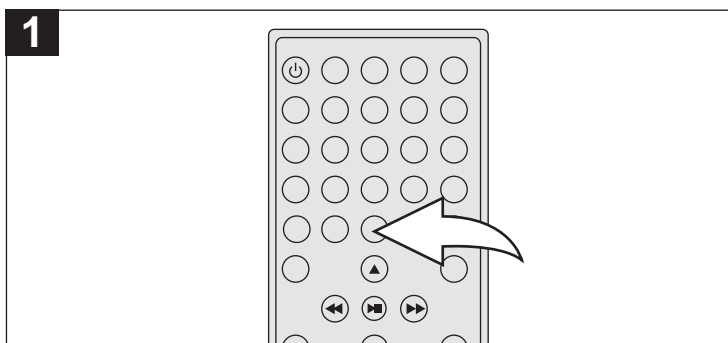

Press the REPEAT button to cycle through the following options: REP 1 (will repeat the selected file continuously until the Stop (■) button is pressed), REP DIR (will repeat the selected folder continuously until the STOP button is pressed), REP ALL (will repeat the entire disc continuously until the Stop (■) button is pressed) or OFF.

OSD INFO

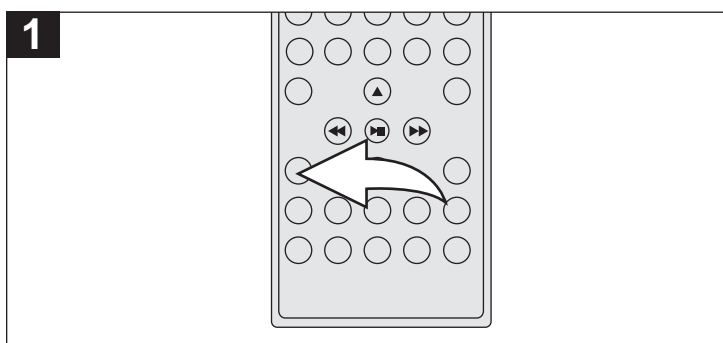

When in the MP3 playback mode, press the OSD/INFO button once to display the track, Repeat mode and elapsed playing time. Press a second time and the OSD information will disappear from the display.

MP3 FAQs (Frequently Asked Questions)

Please read before playing an MP3 disc.

What is an MP3 file?

An MP3 file is a computer format that makes a usually large music file into a smaller one which is more convenient to download and share.

Can I record my own MP3 CDs?

Yes, but you need a CD recorder, which is available from your local computer store.

Where can I find MP3 files?

MP3 files are available on the Internet.

Can this unit read regular music CDs?

Yes, it can. However, you cannot mix MP3s and WAV files on the same CD. If you do this, the CD Player will play only the MP3 files.

Can I use the MP3 extension for non-audio data files?

No, this may result in serious malfunction and harmful noise interference.

Can I mix MP3 files with other file types on the CDR?

Yes, but your CD player will ignore those files and read only the MP3 files on the CDR.

Does this unit support subdirectories (subfolders)?

Yes, it can read MP3 files from subfolders.

PICTURE CD OPERATION

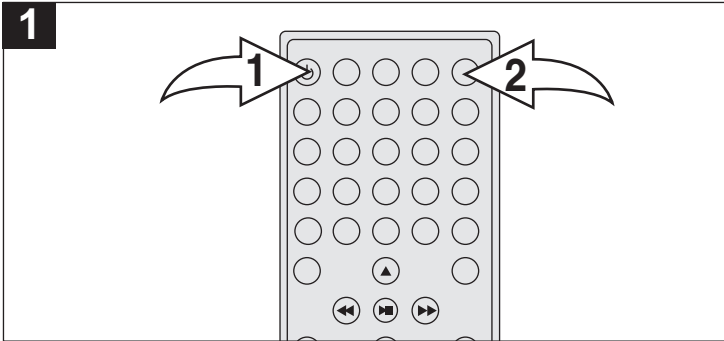

Press the Power button ❶ to turn on the unit; the STANDBY indicator will go out. Press the DISC button ❷ to select the DVD mode.

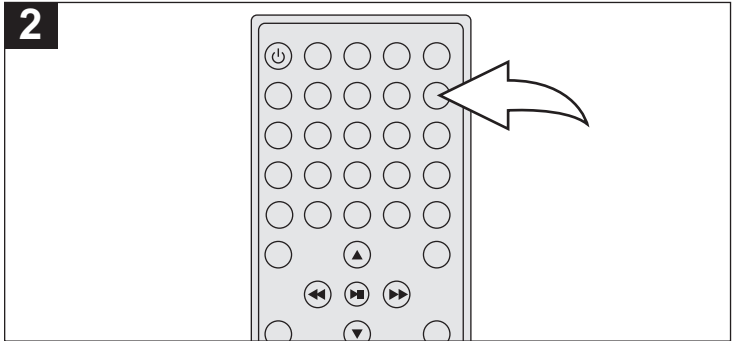

Press the OPEN/CLOSE button to open the compartment. Insert an picture CD with the label side facing up into the disc tray. Press the OPEN/CLOSE button to close the compartment.

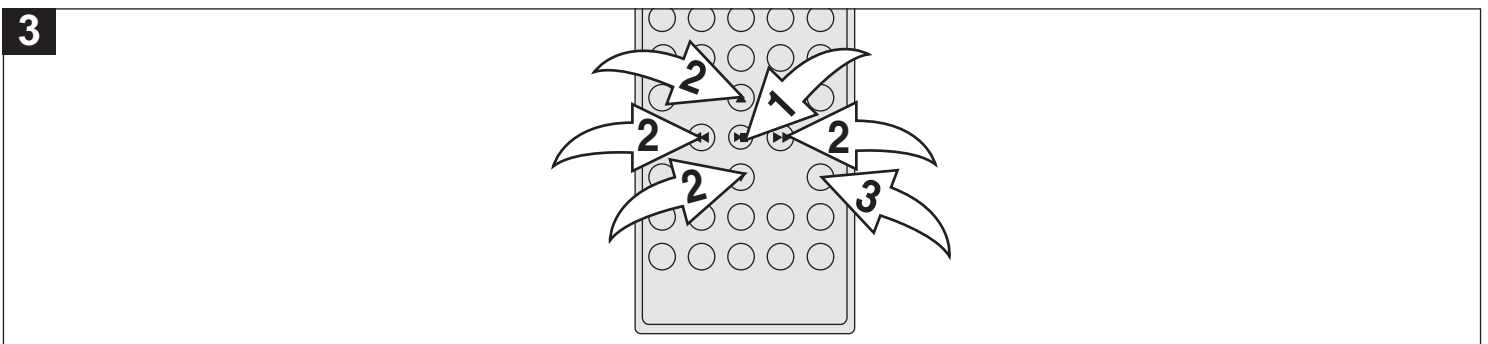

After loading a picture CD, the pictures will automatically show as a slideshow on the screen. (If playback does not start automatically, press the ENTER/Play/Pause (▶||) button ❶ to start playback.) Press the Navigation ▶/Search ▶▶ or Navigation ◀/Search ◀◀ buttons ❷ to select the next or previous picture. After the slideshow is done, it will go to thumbnail view. You can press the Stop (■) button ❸ to stop the slideshow before it is finished; then the thumbnail view will appear. In thumbnail view, you can press the Navigation (◀, ▶, ▲, ▼) button ❷ to select the desired picture or go to the next/previous page. Select the desired picture and then press the ENTER/Play/Pause (▶||) button ❶ to view it.

ADJUSTING THE PICTURE

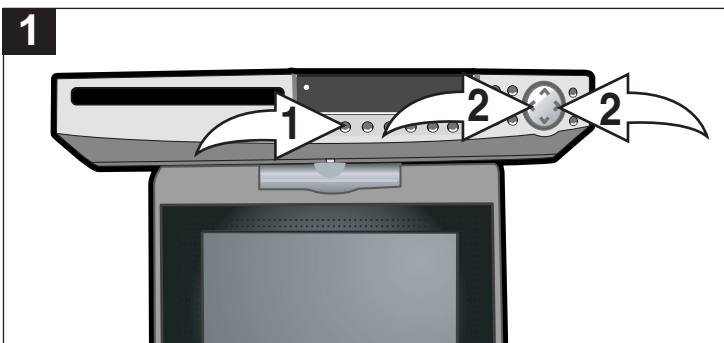

Press the BAND button ❶ on the main unit repeatedly to select one of the video options, BRIGHTNESS, Saturation and Screen type (Wide Screen or normal). Adjust as desired using the Navigation (◀, ▶) buttons ❷.

NOTES:

- You can rotate the picture on-screen using the Navigation (◀, ▶, ▲, ▼) buttons during slideshow playback.
- Press the CLOCK button to show the time in the display.

AV FUNCTION

PLAYBACK OF A UNIT CONNECTED TO THE AV JACKS

1

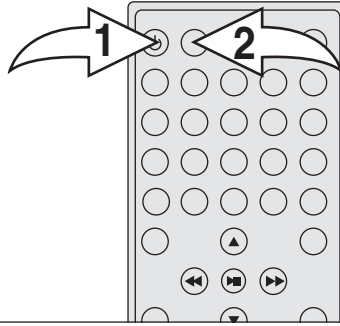

Press the POWER button ❶ to turn on the unit. Press the AUX button ❷ to select the AV mode and then start playback of the AV unit.

NOTE:

For the AV unit connection, please refer to page 12.

Press the CLOCK button to show the time in the display and press again to show the AUX IN.

ADJUSTING THE PICTURE

1

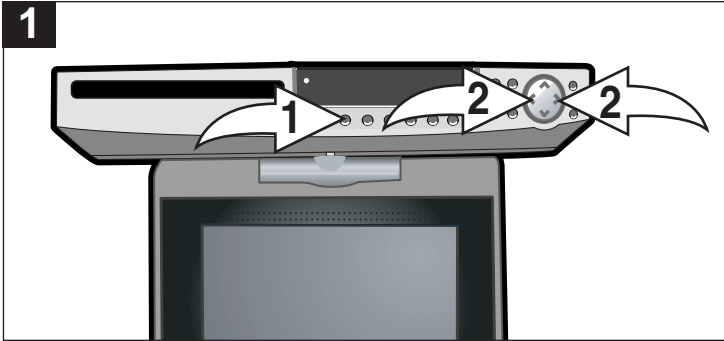

Press the BAND button ❶ on the main unit repeatedly to select one of the video options, BRIGHTNESS, Saturation and Screen type (Wide Screen or normal). Adjust as desired using the Navigation (◀, ▶) buttons ❷.

Note: For the Volume Control, Mute & EQ/BASS, please refer to page 33.

TROUBLESHOOTING GUIDE

Check the following before requesting service:

SYMPTOM	POSSIBLE CAUSE	POSSIBLE SOLUTION
GENERAL		
No power.	AC cord unplugged.	Plug in the AC cord to an AC outlet.
Power on, but unit not functioning properly.	Condensation has formed.	Unplug the unit and wait about one to two hours to allow the player to dry.
	Wrong type of disc inserted.	This unit cannot play discs, other than the specified discs.
	Unit needs to be reset.	Press the POWER button, then unplug the AC cord. Wait one minute and then plug the unit back in.
	The disc is dirty or inserted incorrectly.	Clean disc and insert label side-up.
	Some features and functions are not available on all discs.	This is normal; try another function.
No picture.	The equipment is not connected properly.	Connect the equipment according to the instructions in this manual.
	The INPUT of the TV is not set to receive the DVD signal output.	Press the DISC button.
	The video cables are not securely connected.	Connect the video cables securely.
	The connected external unit's power is off.	Turn the unit on.
No sound.	The equipment is not connected properly.	Connect the equipment according to the instructions in this manual.
	The MUTE button is pressed.	Press the MUTE or one of the VOLUME buttons to restore the sound.
	The audio cables are not securely connected.	Connect the audio cables securely.
	The connected external unit's power is off.	Turn the unit on.
Playback picture rolls.	Unit needs to be reset to NTSC.	Set menu option to NTSC.
The playback picture is poor.	The disc is dirty.	Clean the disc.
The Search feature is not working.	Some discs have sections that do not allow searching.	This is normal on some discs.
The picture is not fitting properly.	Wrong menu option is selected in the General Setup Menu.	Select the TV type (4:3PS, 4:3LB, 16:9) desired.
The remote control is not working.	The batteries are weak or dead.	Install fresh batteries.
	The batteries are not installed properly.	Install batteries according to the diagram.
	The remote is not aimed at the sensor.	Aim the remote at the sensor.
	Distance is too far or there is too much light in the room.	Operate within approx. 5 meters, or reduce the light in the room.
	There is an obstacle in the path of the beam.	Move obstacle.

TROUBLESHOOTING GUIDE (CONTINUED)

SYMPTOM	POSSIBLE CAUSE	POSSIBLE SOLUTION
DVD		
The unit does not start playback.	Rating level set to block the DVD.	Enter your password, and/or change the rating level.
	DVD not inserted, or inserted upside-down.	Insert DVD correctly.
	DVD is not selected.	Press the DISC button to select the DVD mode.
	The disc is not placed in the guide.	Place the disc on the disc tray correctly inside the guide.
	The disc is dirty.	Clean the disc.
Some functions do not operate as stated.	Some features and functions are not available on all discs.	This is normal; try another function.
Selected language is not being shown in the subtitles, or spoken.	If the audio or subtitle language does not appear on the disc, then the initial setting will not be seen/heard.	This is normal; try another disc.
Subtitles are not working properly.	Subtitles appear only when the discs contain them.	This is normal; try another disc.
	Subtitles not turned on.	Turn the subtitles on.
The Rating Level password has been forgotten.	Password forgotten.	Use the Super Code "0000" to reset rating level.

**FOR ADDITIONAL SET-UP OR OPERATING ASSISTANCE, PLEASE VISIT OUR WEBSITE AT
WWW.MEMOREXELECTRONICS.COM
OR CONTACT CUSTOMER SERVICE AT 1-888-636-5238.**

PLEASE KEEP ALL PACKAGING MATERIAL FOR AT LEAST 90 DAYS IN CASE YOU NEED TO RETURN THIS PRODUCT TO YOUR PLACE OF PURCHASE OR IMATION ELECTRONICS PRODUCTS.

FOR CONSUMER REPLACEABLE PART(S), SEE PART NUMBER(S) ON PAGES 8 AND 9 AND THEN CONTACT FOX INTERNATIONAL AT 1-800-321-6993.

CARE AND MAINTENANCE

Caring for Discs

- Treat the disc carefully. Handle the disc only by its edges. Never allow your fingers to come in contact with the shiny, unprinted side of the disc.

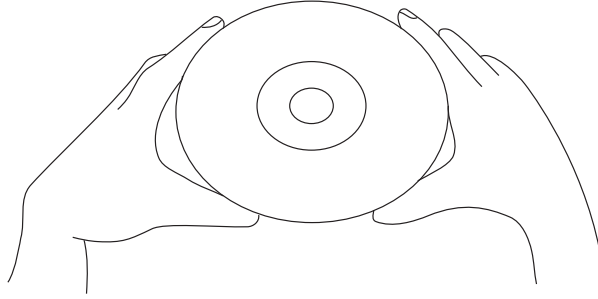

- Do not attach adhesive tape, stickers, etc. to the disc label.
- Clean the disc periodically with a soft, lint-free, dry cloth. Never use detergents or abrasive cleaners to clean the disc. If necessary, use a CD cleaning kit.
- If a disc skips or gets stuck on a section of the disc, it is probably dirty or damaged (scratched).
- When cleaning the disc, wipe in straight lines from the center of the disc to the outer edge of the disc. Never wipe in circular motions.

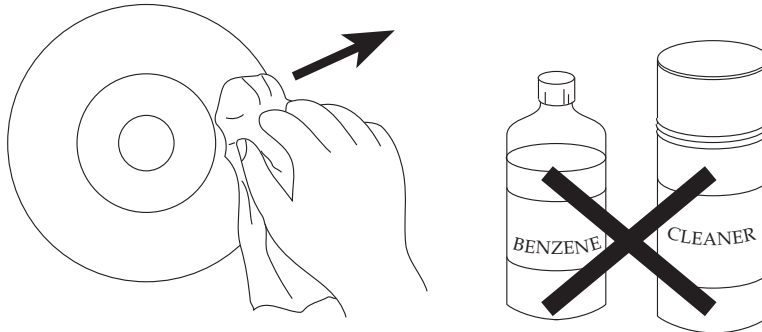

- Discs should be stored in their cases after each use to avoid damage.
- Do not expose discs to direct sunlight, high humidity, high temperatures or dust, etc. Prolonged exposure or extreme temperatures can warp the disc.
- Do not stick or write anything on either side of the disc. Sharp writing instruments, or the ink, may damage the surface.

Cleaning the Unit

- To prevent fire or shock hazard, disconnect your unit from the AC power source when cleaning.
- The finish on your unit may be cleaned with a dust cloth and cared for as other furniture. Use caution when cleaning and wiping the plastic parts.
- Mild soap and a damp cloth may be used on the front panel.

SPECIFICATIONS

Power Requirements.....	DC IN 12V/2000mA (Center Positive ⊖⊕)
Power Consumption	<25W
Weight	5.75Lbs
Dimensions	4 (H) x 10 (L) x 14.5 (W) inches
Operating Temperature.....	32° to 104°F
Operating Humidity Range	< 95% (no condensation)
Accessories	AC Adapter, Remote Control, Remote Battery, AM Loop Antenna, Spacers(4), Screws (4)
Screen.....	8"/TFT Panel

LCD TV

LCD Monitor	8" LCD Panel
Viewing Angle.....	H: 100° V: 50°
Screen Ratio	4:3 and 16:9
Resolution	480 x 220
Contrast Ratio	300:1
Brightness	300 cd/m2
Speaker Output Power	5W x 2
DTV Signal supported	480i, 480p, 720p, 1080i
TV Tuner	ATSC

Discs Played:

DVD-VIDEO Disc

.....	12cm single-sided, single layer
.....	12cm single-sided, dual layer
.....	12cm double-sided, single layer
.....	8cm single-sided, single layer
.....	8cm single-sided, dual layer
.....	8cm double-sided, single layer

COMPACT DISC

.....	12cm disc
.....	8cm disc
Video Input Level.....	1Vp-p
Audio Input Level.....	800mVrms (1KHz, 0dB)

Pickup:

Wavelength	655nm
Laser Power	Class 1

Specifications are subject to change without notice.

Imation Electronics Products,
A Division of Imation Enterprises Corp.
Weston, FL
Printed in Hong Kong

www.memorexelectronics.com

0521-001000-00000

Free Manuals Download Website

<http://myh66.com>

<http://usermanuals.us>

<http://www.somanuals.com>

<http://www.4manuals.cc>

<http://www.manual-lib.com>

<http://www.404manual.com>

<http://www.luxmanual.com>

<http://aubethermostatmanual.com>

Golf course search by state

<http://golfingnear.com>

Email search by domain

<http://emailbydomain.com>

Auto manuals search

<http://auto.somanuals.com>

TV manuals search

<http://tv.somanuals.com>