

SL 500
SL 55 AMG

Our company and staff congratulate you on the purchase of your new Mercedes-Benz.

Your selection of our product is a demonstration of your trust in our company name. Further, it exemplifies your desire to own an automobile that will be as easy as possible to operate and provide years of service.

Your Mercedes-Benz represents the efforts of many skilled engineers and craftsmen. To help assure your driving pleasure, and also the safety of you and your passengers, we ask you to make a small investment of time:

- Please read this manual carefully before putting it aside. Then return it to your vehicle where it will be handy for your reference.
- Please follow the recommendations contained in this manual. They are designed to acquaint you with the operation of your Mercedes-Benz.
- Please pay attention to the warnings and cautions contained in this manual. They are designed to help improve the safety of the vehicle operator and occupants.

We extend our best wishes for many miles of safe, pleasurable driving.

Mercedes-Benz USA, LLC
A DaimlerChrysler Company

<p>Introduction 7</p> <p>Product information 7</p> <p>Operator's Manual 8</p> <p> Service and warranty information 8</p> <p> Important notice for California retail buyers and lessees of Mercedes-Benz automobiles 9</p> <p> Maintenance 10</p> <p> Roadside Assistance 10</p> <p> Change of address or ownership.... 10</p> <p> Operating your vehicle outside the USA or Canada 11</p> <p>Where to find it 12</p> <p>Symbols 13</p> <p>Operating safety 14</p> <p> Proper use of the vehicle 14</p> <p>Problems with your vehicle 15</p> <p>Reporting safety defects 16</p> <p> Reporting safety defects 16</p> <hr/> <p>At a glance 17</p> <p>Cockpit 18</p> <p>Instrument cluster 20</p> <p>Multifunction steering wheel 22</p>	<p>Center console 23</p> <p> Upper part 23</p> <p> Lower part 24</p> <p>Overhead control panel 25</p> <p>Door control panel 26</p> <hr/> <p>Getting started 27</p> <p>Unlocking 28</p> <p> Unlocking with the SmartKey 28</p> <p> Unlocking with KEYLESS-GO* 30</p> <p>Adjusting 32</p> <p> Seats 32</p> <p> Steering wheel 34</p> <p> Mirrors 35</p> <p>Driving 37</p> <p> Fastening the seat belts 37</p> <p> Starting the engine 39</p> <p> Switching on headlamps 43</p> <p> Turn signals and high beam 43</p> <p> Windshield wipers 44</p> <p> Problems while driving 45</p> <p>Parking and locking 47</p> <p> Parking brake 47</p> <p> Switching off headlamps 48</p> <p> Turning off engine with the key 48</p>	<p>Turning off engine with KEYLESS-GO* 49</p> <p>Emergency engine shut-down 50</p> <hr/> <p>Safety and Security 51</p> <p>Occupant safety 52</p> <p> Airbags 53</p> <p> Seat belts 58</p> <p> Roll bar 61</p> <p> Children in the vehicle 62</p> <p>Panic alarm 67</p> <p> Activating 67</p> <p> Deactivating 67</p> <p>Driving safety systems 68</p> <p> ABS 68</p> <p> BAS 69</p> <p> ESP 70</p> <p> SBC brake system 72</p> <p>Anti-theft systems 75</p> <p> Immobilizer 75</p> <p> Anti-theft alarm system 75</p> <p> Tow-away alarm 77</p>
--	---	---

Contents

Controls in detail	79	Hazard warning flasher	105	Accelerator position.....	142
Locking and unlocking	80	Interior lighting.....	106	Steering wheel gearshift control	
Keys	80	Courtesy lighting	107	(Speedshift) and manual shift program	
KEYLESS-GO card*	84	Instrument cluster	108	SL 55 AMG.....	142
Opening the doors from the inside ..	89	Instrument cluster illumination	108	Emergency operation (Limp Home	
Opening the trunk from the inside..	89	Coolant temperature gauge	108	Mode)	144
Trunk lid emergency release	90	Trip odometer	109	Good visibility	145
Closing the trunk lid	91	Tachometer	109	Rear view mirror	145
Automatic central locking	91	Outside temperature indicator	109	Headlamp cleaning system	146
Locking and unlocking		Control system	110	Rear window defroster.....	146
from the inside	92	Multifunction display.....	110	Sun visors	146
Seats.....	93	Multifunction steering wheel.....	111	Automatic climate control	147
Lumbar support.....	93	Menus	113	Setting the temperature.....	149
Multicontour backrest*	93	Standard display menu	115	Adjusting air volume	150
Moving the seats forward and		AUDIO menu	115	Adjusting air distribution.....	151
backward.....	95	NAVI menu	117	Maximum cooling MAXCOOL	151
Seat ventilation*	96	Distronic* menu.....	117	Defrosting	151
Seat heater.....	97	Malfunction memory menu	118	Air recirculation mode.....	152
Memory function.....	99	Settings menu.....	119	Rear window defroster.....	153
Storing positions into memory	100	Trip computer menu.....	131	Residual heat and ventilation	154
Recalling positions from memory .	100	TEL menu*	133	Deactivating the automatic climate	
Storing parking position	100	Automatic transmission	137	control system	154
Lighting.....	102	One-touch gearshifting.....	138	Air conditioning.....	155
Exterior lamp switch.....	102	Gear ranges.....	139	Ventilated storage compartments	156
Combination switch.....	104	Gear selector lever position	140	Power windows.....	157
		Program mode selector switch.....	141	Opening and closing the windows	157

Retractable hardtop.....	159	Pedals	215	Engine compartment	227
Opening and closing the retractable hardtop	159	Power assistance	216	Hood	227
Driving systems	168	Brakes.....	216	Engine oil	228
Cruise control	168	Driving off	218	Transmission fluid level	230
Distronic*	171	Parking.....	218	Oil level in the ABC system	230
Active Body Control (ABC)	183	Tires.....	219	Coolant	230
Parktronic system*	186	Hydroplaning.....	219	Battery.....	232
Useful features	190	Tire traction	220	Windshield washer system and headlamp cleaning system	233
Interior storage spaces	190	Tire speed rating.....	220	Tires and wheels	234
Ashtray.....	196	Winter driving instructions	221	Important guidelines.....	234
Cigarette lighter	197	Standing water.....	222	Life of tires	235
Heated steering wheel* (Canada only-model SL 500).....	197	Passenger compartment.....	222	Direction of rotation	235
Easy-Pack load assist in the trunk	198	Driving abroad	222	Checking tire inflation pressure	235
Electrical outlet	199	Control and operation of radio trans- mitters	222	Rotating wheels	238
Telephone*	199	Catalytic converter.....	223	Winter driving.....	239
Tele Aid	200	Emission control	224	Winter tires	239
Garage door opener	208	Coolant temperature.....	224	Block heater (Canada only).....	240
		At the gas station	225	Snow chains	240
		Check regularly and before a long trip	226	Maintenance	241
Operation	213			Clearing the service indicator	241
The first 1000 miles (1500 km)	214			Service term exceeded	241
Driving instructions.....	215			Calling up the service indicator	242
Drive sensibly – save fuel.....	215			Resetting the service indicator	242
Drinking and driving	215			Vehicle care	243
				Cleaning and care of the vehicle...	243

Contents

Practical hints	249	Batteries	319	Spare wheel.....	338
What to do if	250	Disconnecting the batteries	320	Electrical system	339
Lamps in instrument cluster.....	250	Removing the batteries	321	Main dimensions	340
Messages in the display	257	Charging and reinstalling		Weights	341
Where will I find ...?.....	288	batteries.....	321	Fuels, coolants, lubricants, etc.	342
First aid kit	288	Reconnecting the batteries	321	Capacities	342
Vehicle tool kit	288	Jump starting	323	Engine oils	343
Locking/unlocking in an emergency..	290	Towing the vehicle	325	Engine oil additives	343
Unlocking the vehicle	290	Installing towing eye bolt	327	Air conditioner refrigerant.....	343
Locking the vehicle	292	Fuses	329	Brake fluid.....	343
Lowering the Easy Pack feature		Main fuse box.....	329	Premium unleaded gasoline	344
manually.....	292			Fuel requirements.....	344
Changing batteries	293			Gasoline additives.....	344
Replacing bulbs	295	Technical data	331	Coolants	345
Bulbs	295	Spare parts service.....	332	Windshield and headlamp washer	
Replacing bulbs for front lamps....	298	Warranty coverage.....	333	system	347
Replacing bulbs for rear lamps	299	Loss of Service and Warranty		Consumer information.....	348
Replacing wiper blades	301	Information Booklet	333	Uniform tire quality grading	348
Removing	301	Identification labels	334		
Installing.....	301	Layout of poly-V-belt drive.....	335		
Flat tire	302	SL 500	335		
Preparing the vehicle.....	302	SL 55 AMG.....	335	Technical terms	351
Sealing tires with TIREFIT kit 1	302	Engine.....	336		
Sealing tires with TIREFIT kit 2	308	Rims and tires.....	337		
Mounting the spare wheel	312	Same size tires.....	337	Index	357
		Mixed size tires	338		

Product information

Please observe the following in your own best interest:

We recommend using Mercedes-Benz original parts as well as conversion parts and accessories explicitly approved by us for your vehicle model.

We have tested these parts to determine their reliability, safety and their special suitability for Mercedes-Benz vehicles.

We are unable to make an assessment for other products and therefore cannot be held responsible for them, even if in individual cases an official approval or authorization by governmental or other agencies should exist. Use of such parts and accessories could adversely affect the safety, performance or reliability of your vehicle. Please do not use them.

Mercedes-Benz original parts as well as conversion parts and accessories approved by us are available at your authorized Mercedes-Benz Center where you will receive comprehensive information, also on permissible technical modifications, and where proper installation will be performed.

Operator's Manual

Operator's Manual

This Operator's Manual contains a great deal of useful information. We urge you to read it carefully and familiarize yourself with the vehicle before driving.

For your own safety and longer service life of the vehicle, we urge you to follow the instructions and warnings contained in this manual. Ignoring them could result in damage to the vehicle or personal injury to you or others. Vehicle damage caused by failure to follow instructions is not covered by the Mercedes-Benz Limited Warranty.

Your vehicle may have some or all of the equipment described in this manual. Therefore, you may find explanations for optional equipment not installed in your vehicle. If you have any questions about the operation of any equipment, your authorized Mercedes-Benz Center will be glad to demonstrate the proper procedures.

We continuously strive to improve our product, and ask for your understanding that we reserve the right to make changes in design and equipment. Therefore, information, illustrations, and descriptions in this Operator's Manual might differ from your vehicle.

Optional equipment is also described in this manual, including operating instructions wherever necessary. Since they are special-order items, the descriptions and illustrations herein may vary slightly from the actual equipment of your vehicle.

If there are any equipment details that are not shown or described in this Operator's Manual, your authorized Mercedes-Benz Center will be glad to inform you of correct care and operating procedures.

The Operator's Manual and Service Booklet are important documents and should be kept with the vehicle.

Service and warranty information

The Service and Warranty Information Booklet contains detailed information about the warranties covering your Mercedes-Benz, including:

- New Car Limited Warranty,
- Emission System Warranty,
- Emission Performance Warranty,
- California, Maine, Massachusetts, and Vermont Emission Control System Warranty (California, Maine, Massachusetts, and Vermont only),
- State Warranty Enforcement Laws (Lemon Laws).

Important notice for California retail buyers and lessees of Mercedes-Benz automobiles

Under California law you may be entitled to a replacement of your vehicle or a refund of the purchase price or lease price, if Mercedes-Benz USA, LLC and / or its authorized repair or service facilities fail to fix one or more substantial defects or malfunctions in the vehicle that are covered by its express warranty after a reasonable number of repair attempts. During the period of 18 months from original delivery of the vehicle or the accumulation of 18000 miles (approx. 29000 km) on the odometer of the vehicle, whichever occurs first, a reasonable number of repair attempts is presumed for a retail buyer or lessee if one or more of the following occurs:

- (1) the same substantial defect or malfunction results in a condition that is likely to cause death or serious bodily injury if the vehicle is driven, that defect or malfunction has been subject to repair two or more times, and you have directly notified Mercedes-Benz USA, LLC in writing of the need for its repair,
- (2) the same substantial defect or malfunction of a less serious nature than category (1) has been subject to repair four or more times and you have directly notified us in writing of the need for its repair, or
- (3) the vehicle is out of service by reason of repair of the same or different substantial defects or malfunctions for a cumulative total of more than 30 calendar days. Written notification should be sent to us, not a dealer, at Mercedes-Benz USA, LLC, Customer Assistance Center, One Mercedes Drive, Montvale, NJ 07645-0350.

Maintenance

The Service Booklet describes all the necessary maintenance work which should be performed at regular intervals.

Always have the Service Booklet with you when you take the vehicle to your authorized Mercedes-Benz Center for service. The service advisor will record each service in the booklet for you.

Roadside Assistance

The Mercedes-Benz Roadside Assistance Program provides factory trained technical help in the event of a breakdown. Calls to the toll-free Roadside Assistance number:

1-800-FOR-MERCEdes (in the USA)
1-800-387-0100 (in Canada)

will be answered by Mercedes-Benz Customer Assistance Representatives 24 hours a day, 365 days a year.

For additional information refer to the Mercedes-Benz Roadside Assistance Program brochure in your glove box.

Change of address or ownership

If you change your address, be sure to send in the "Change of Address Notice" found in the Service and Warranty Information Booklet, or simply call the Mercedes-Benz Customer Assistance Center (in the USA) at 1-800-FOR-MERCEdes, or Customer Service (in Canada) at 1-800-387-0100. It is in your own interest that we can contact you should the need arise.

If you sell your Mercedes, please leave all literature with the vehicle to make it available to the next operator.

If you bought this vehicle used, be sure to send in the "Notice of Purchase of Used Car" found in the Service and Warranty Information Booklet, or call the Mercedes-Benz Customer Assistance Center (in the USA) at 1-800-FOR-MERCEdes, or Customer Service (in Canada) at 1-800-387-0100.

Operating your vehicle outside the USA or Canada

If you plan to operate your vehicle in foreign countries, please be aware that:

- Service facilities or replacement parts may not be readily available,
- unleaded gasoline for vehicles with catalytic converters may not be available; the use of leaded fuels will damage the catalyts,
- gasoline may have a considerably lower octane rating, and improper fuel can cause engine damage.

Certain Mercedes-Benz models are available for delivery in Europe under our European Delivery Program. For details, consult your authorized Mercedes-Benz Center or write to:

In the USA:

Mercedes-Benz USA, LLC
European Delivery Department
One Mercedes Drive
Montvale, NJ 07645-0350

In Canada:

Mercedes-Benz Canada, Inc.
European Delivery Department
849 Eglinton Avenue East
Toronto, Ontario M4G 2L5

We continuously strive to improve our product, and ask for your understanding that we reserve the right to make changes in design and equipment. Therefore, information, illustrations and descriptions in this Operator's Manual might differ from your vehicle.

Optional equipment is also described in this manual, including operating instructions wherever necessary. Since they are special-order items, the descriptions and illustrations herein may vary slightly from the actual equipment of your vehicle.

If there are any equipment details that are not shown or described in this Operator's Manual, your authorized Mercedes-Benz Center will be glad to inform you of correct care and operating procedures.

The Operator's Manual and Service Booklet are important documents and should be kept with the vehicle.

Where to find it

Where to find it

This Operator's Manual is designed to provide comprehensive support information for you, the vehicle operator. For you to find information quickly each section has its own reference color:

At a glance

Here you will find an overview of all the controls that can be operated from the driver's seat.

Getting started

Here you will find all the information you need for your first drive. You should read this section first if this is your first Mercedes-Benz vehicle or if you are renting or borrowing this vehicle.

Safety and Security

Here you will find descriptions of the safety features in your vehicle.

Controls in detail

Here you will find detailed information about the equipment installed on your vehicle. This section expands on the "Getting started" section and also describes technical innovations. If you are already familiar with the basic functions of your vehicle, this section will be of particular interest to you.

Operation

Here you will find all the information you need for the proper operation of your vehicle.

Practical hints

This section provides fast assistance for dealing with problems you may encounter.

Technical data

All important technical data for your vehicle can be found in this section.

Indexes

The glossary provides explanations of the most important technical terms.

The table of contents and the index are designed to help you find information quickly and easily.

The following publications are part of your vehicle documentation:

- this Operator's Manual
- the Service Booklet

Separate operating instructions will be provided as required depending on the equipment options installed in your vehicle.

Symbols

The following symbols are found in this Operator's Manual:

- * Optional equipment is identified with an asterisk. Since standard equipment varies between models, the descriptions and illustrations in this manual may differ slightly from the actual equipment of your vehicle.

Warning!



Warning notices draw your attention to hazards that may endanger your health or life, or the health or life of others.



Highlights hazards that may result in damage to your vehicle.



Helpful hints or further information you may find useful.

- ▶ This symbol points to instructions for you to follow.
- ▶ A number of these symbols appearing in succession indicates a multiple-step procedure.
- ▷ Page This symbol tells you where to look for further information on a topic.
- ▷▷ This continuation symbol marks an interrupted procedure which will be continued on the next page.
- > In the glossary of technical terms, this symbol is used to cross-reference term definitions.
- Display Words appearing in the multi-function display are printed in the type shown here.

Operating safety

Operating safety

Warning!



Work improperly carried out on electronic components and associated software could cause them to cease functioning. Because the vehicle's electronic components are interconnected, any modification made may produce an undesired effect on other systems.

Electronic system malfunctions could seriously impair the operating safety of your vehicle.

Ensure that any repairs or modifications to electronic components are carried out by an authorized Mercedes-Benz Center.

Other improper work or modifications on the vehicle could also have a negative impact on the operating safety of the vehicle.

Some safety systems only function while the engine is running. You should therefore never turn off the engine while driving.

Proper use of the vehicle

Proper use of the vehicle requires that you are familiar with the following information and rules:

- the safety precautions in this manual
- the “Technical data” section in this manual
- traffic rules and regulations
- motor vehicle laws and safety standards

Problems with your vehicle

If you should experience a problem with your vehicle, particularly one that you believe may affect its safe operation, we urge you to immediately contact your authorized Mercedes-Benz Center to have the problem diagnosed and corrected if required. If the matter is not handled to your satisfaction, please discuss the problem with the Mercedes-Benz Center management, or if necessary contact us at one of the following addresses:

In the USA:

Customer Assistance Center
Mercedes-Benz USA, LLC
One Mercedes Drive
Montvale, NJ 07645-0350

In Canada:

Customer Relations Department
Mercedes-Benz Canada, Inc.
849 Eglinton Avenue East
Toronto, Ontario, M4G 2L5

Reporting safety defects

Reporting safety defects

For the USA only:

The following text is published as required of manufacturers under Title 49, Code of U.S. Federal Regulations, Part 575 pursuant to the “National Traffic and Motor Vehicle Safety Act of 1966”.

Reporting safety defects

If you believe that your vehicle has a defect which could cause a crash or could cause injury or death, you should immediately inform the National Highway Traffic Safety Administration (NHTSA) in addition to notifying Mercedes-Benz USA, LLC.

If NHTSA receives similar complaints, it may open an investigation, and if it finds that a safety defect exists in a group of vehicles, it may order a recall and remedy campaign. However, NHTSA cannot become involved in individual problems between you, your dealer, or Mercedes-Benz USA, LLC.

To contact NHTSA, you may either call the Auto Safety Hotline toll-free at 1-888-327-4236 (or 366-0123 in Washington, D.C. area) or write to: NHTSA, U.S. Department of Transportation, Washington, D.C. 20590. You can also obtain other information about motor vehicle safety from the Hotline.

At a glance

Cockpit

Instrument cluster

Multifunction steering wheel

Center console

Overhead control panel

Door control panel

At a glance

Cockpit

Cockpit

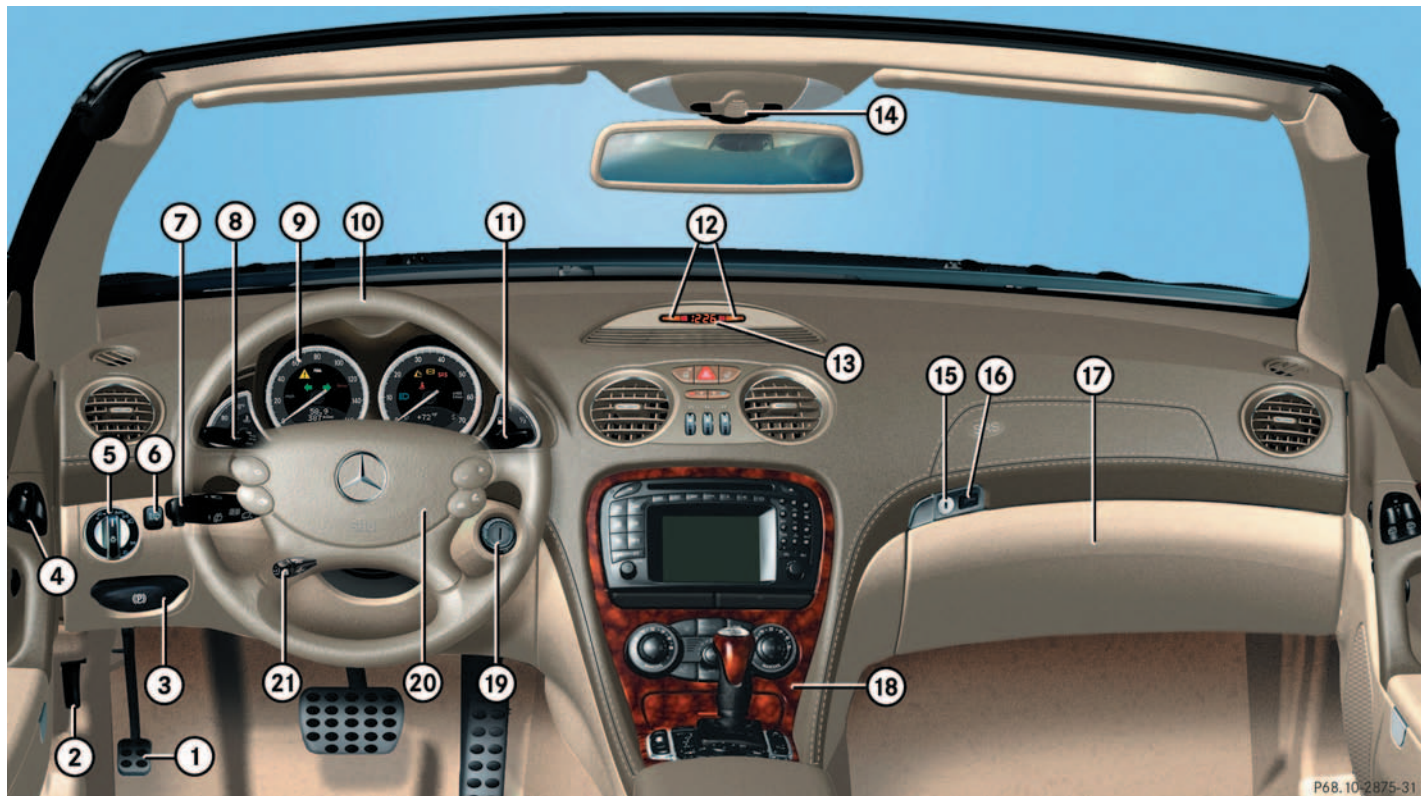

P68.10-2875-31

	Item	Page
1	Parking brake pedal	41
2	Hood lock release	227
3	Parking brake release	47
4	Door control panel	26
5	Exterior lamp switch	43, 102
6	Headlamp washer switch	146
7	Combination switch	
	• Turn signals	43
	• Windshield wipers	44
	• High beam	104
8	Cruise control switch	
	• Cruise control	168
	• Distronic*	171
9	Instrument cluster	20, 108
10	Multifunction steering wheel	22, 111





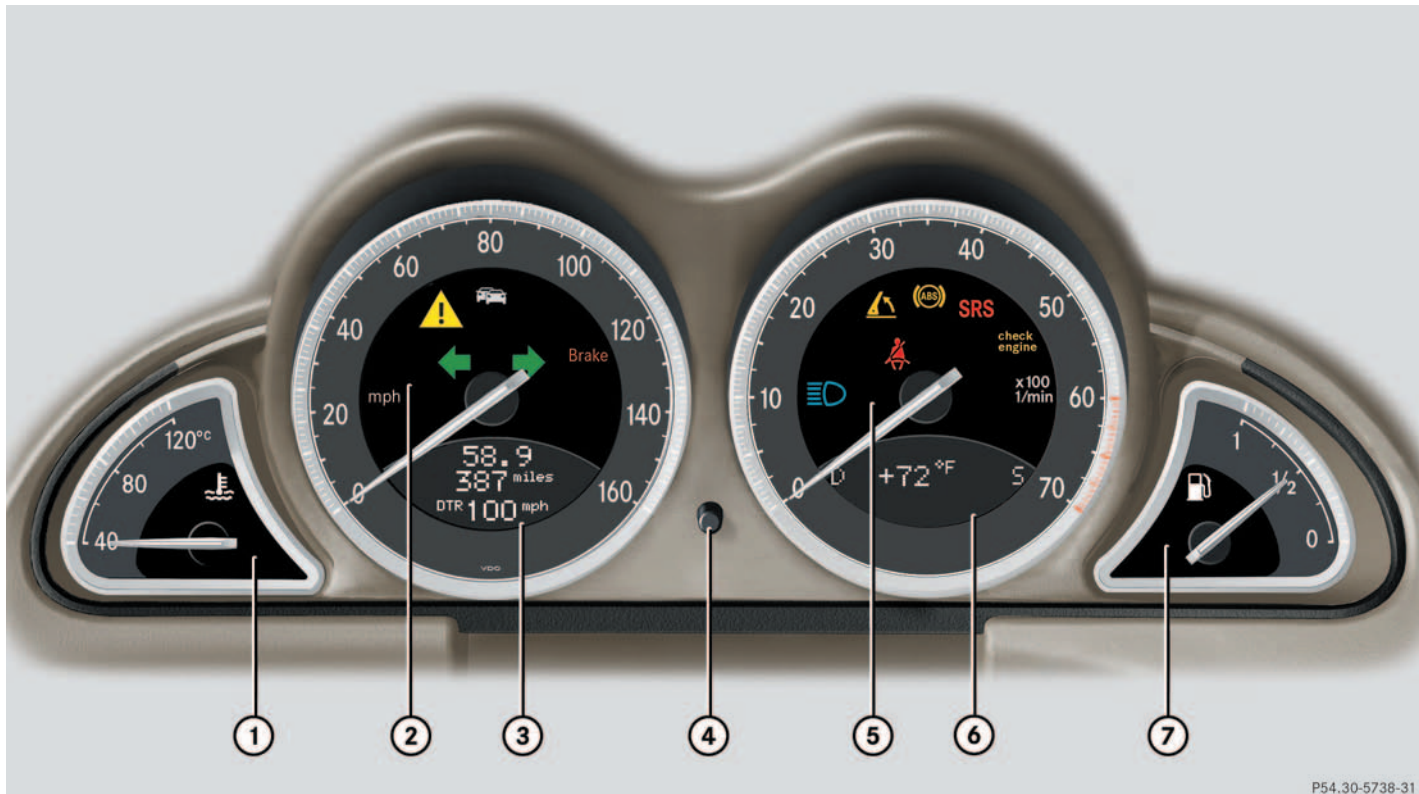

	Item	Page
11	Lever for voice control system, see separate operating instructions	
12	Front Parktronic* warning indicator	186
13	Digital clock	122
14	Overhead control panel	25
15	Interior storage compartments (locking/unlocking)	194
16	 indicator lamp	64
17	Glove box	190
18	Center console	23, 24
19	Starter switch	31
20	Horn	
21	Steering wheel adjustment stalk	34
	Heated steering wheel*	197





Instrument cluster



Instrument cluster



P54.30-5738-31

Item	Page
1 Coolant temperature gauge with:	
 Coolant temperature warning lamp	254
2 Speedometer with:	
 Brake warning lamp, except Canada	253
 Brake warning lamp, Canada only	
 Antilock Brake System (ABS)/Electronic Stability Program (ESP) warning lamp	250
 Distronic (DTR)* indicator lamp (white) or warning lamp (red) ¹	251
 Turn signal indicator lamps	

Item	Page
3 Left multifunction display with:	
Trip odometer	109
Main odometer	
Stored speed for Distronic*	117
4 Reset knob	
5 Tachometer with:	109
 High beam headlamp indicator	104
 Engine malfunction indicator lamp	256
 Roll bar warning lamp	255
 Antilock Brake System (ABS) malfunction indicator lamp	251





Item	Page
 Supplemental restraint system (SRS) indicator lamp	252
 Seat belt nonusage warning lamp	256
6 Right multifunction display with:	
Selector lever position	39
Outside temperature display	109
Program mode	141
7 Fuel gauge with:	
 Fuel reserve warning lamp	255





¹ Vehicles without Distronic*: Indicator lamp without function. It illuminates with the key in starter switch position **2**. It should go out when the engine is running.

Multifunction steering wheel

Multifunction steering wheel



Item	Page
1 Left multifunction display in speedometer	110
2 Right multifunction display in tachometer	110
Operating control system	
3 Selecting the submenu or setting the volume	111
 down / to decrease	
 up / to increase	
4 Telephone*: press button	
 to take a call	
 to end a call	

Item	Page
5 Menu systems: Press button	
 for next system	
 for previous system	
6 Moving within a menu: Press button	
 for next display	
 for previous display	

Center console

Upper part



	Item	Page
1	Central locking switch	92
2	Hazard warning flasher on/off switch	105
3	Central unlocking switch	92
4	Center and side air vent adjustment	147
5	COMAND system, see separate operating instructions	113
6	Automatic climate control	149
7	Right cup holder	190
8	KEYLESS-GO* start/stop button	30
9	Ashtray Cigarette lighter	196 197
10	Left cup holder	190

Center console

Lower part



	Item	Page
1	Parking assist (Parktronic system)* deactivation switch	186
2	Active Body Control (ABC) switch	183
3	Tow-away alarm switch	77
4	Hardtop open/close control with buttons for roll bar	159 61
5	Exterior rear view mirror adjustment	35

	Item	Page
6	Vehicle level control switch	184
7	ESP control switch	71
8	Thumbwheel for setting distance for DISTRONIC*	179
9	Distance warning function* on/off switch	179
10	Program mode selector for automatic transmission	141
11	Selector lever for automatic transmission	137

Overhead control panel

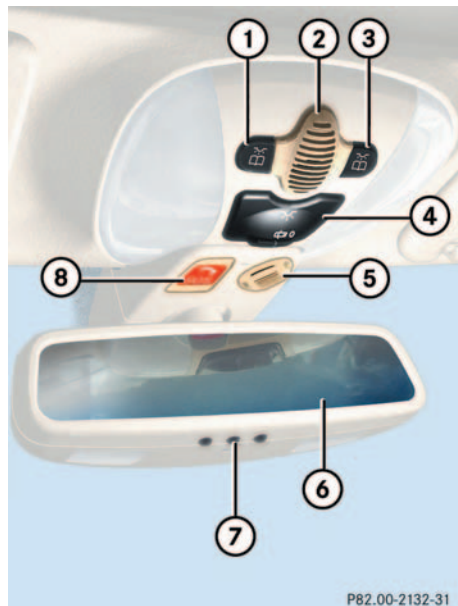

	Item	Page
1	Left reading lamp on/off	106
2	Temperature sensor for automatic climate control	147
3	Right reading lamp on/off	106
4	Interior lighting control	106
5	Hands-free microphone for Tele Aid (emergency call system), telephone* and voice control system* (see separate operating instructions)	199
6	Rear view mirror	35, 145
7	Garage door opener	208
8	Tele Aid (emergency call system) button	200

Door control panel

Door control panel

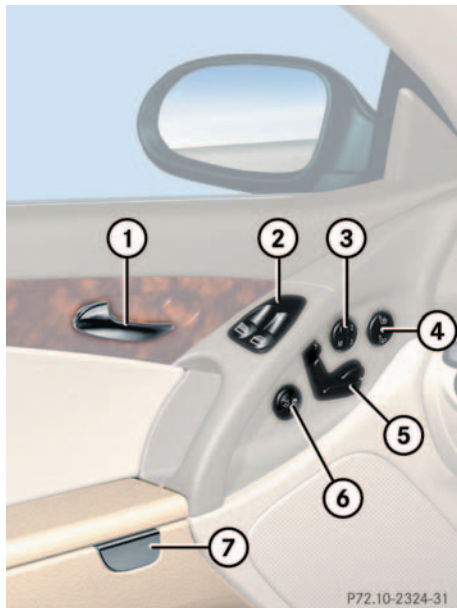

	Item	Page
1	Door handle	89
2	Switches for opening/closing front and rear side windows	157
3	Memory function (for storing seat, mirror and steering wheel settings)	99
4	Seat heater	97
	Seat ventilation*	96
5	Seat adjustment	32, 93
6	Remote trunk lid release switch	90
7	Door pocket	192

Getting started

Unlocking

Adjusting

Driving

Parking and locking



Unlocking

The “Getting started” section provides an overview of the vehicle’s most basic functions. First-time Mercedes-Benz owners should pay special attention to the information given here.



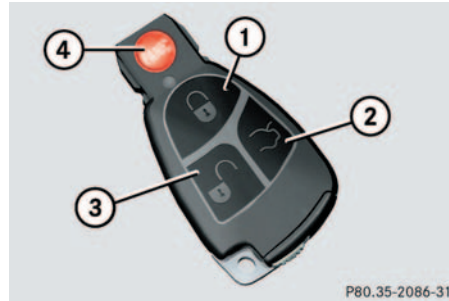

If you are already familiar with the basic functions described here, the “Controls in detail” section will help you with further information. The corresponding page references are at the end of each segment.

Unlocking

Unlocking with the SmartKey



Electronic key with remote control

- 1  Lock button
- 2  Unlock button for trunk lid
- 3  Unlock button
- 4  Panic button

- ▶ Press unlock button 3  on the key.

The indicator lamps light up for a short time. The locking knobs in the doors move up.



The SBC brake system is activated.

- ▶ Get in the vehicle and insert the key in the starter switch.



Opening a door causes the windows on that side of the car to open slightly. They will return to the up position when the door is closed.

Starter switch positions



Starter switch

- 0** For removing key
- 1** Power supplies to some electrical consumers, such as seat adjustment
- 2** Ignition (power supply for all electrical consumers) and driving position
- 3** Starting position

Warning!



When leaving the vehicle always remove the key from the starter switch, take the KEY-LESS-GO* card (if so equipped) with you and lock the vehicle. Do not leave children unattended in the vehicle, or with access to an unlocked vehicle. Unsupervised use of vehicle equipment may cause an accident and/or serious personal injury.



If the key is left in the starter switch position **0** for an extended period of time, it can no longer be turned in the starter switch.

- Remove the key from the starter switch and reinsert.

If the key can still not be turned, the starter battery may not be sufficiently charged.

- Check the starter battery and charge it if necessary (▷ page 319).
- Get a jump start (▷ page 323).

More information can be found in the “Controls in detail” section (▷ page 80).

Unlocking

Unlocking with KEYLESS-GO*

The functions of the KEYLESS-GO card are nearly identical to those of the key, except that it cannot be used to open the retractable hardtop. When using the key and the card at the same time, the key overrules the card.



The KEYLESS-GO card must be outside the vehicle to unlock it.

Warning!



When leaving the vehicle, always take the key and the KEYLESS-GO card with you, and lock the vehicle. Do not leave children unattended in the vehicle, or with access to an unlocked vehicle. Unsupervised use of vehicle equipment may cause an accident and/or serious personal injury.

- ▶ Grasp the door handle.

The turn signal lamps blink once. The locking knobs on the doors move up.



The SBC brake system is activated.

Pressing the KEYLESS-GO start/stop button on the selector lever corresponds to turning the key to the various starter switch positions.



1 KEYLESS-GO start/stop button

Before you press the KEYLESS-GO start/stop button, the vehicle's on-board electronics have the status **0** (as with key removed).

Make sure the gear selector lever is set to **P**.

Do not depress the brake pedal.

Position 1

- ▶ Press the KEYLESS-GO start/stop button once.

Power supply for some electrical consumers, such as seat adjustment.



If you now press the KEYLESS-GO start/stop button twice, the power supply is again switched off.

Ignition (or Position 2)

- ▶ Press the KEYLESS-GO start/stop button twice.

Power supply for all electrical consumers. All the lights in the instrument cluster light up.



If you now press the KEYLESS-GO start/stop button once, the power supply is again switched off.

More information can be found in the “Controls in detail” section (▷ page 84). For information on starting the engine using the KEYLESS-GO start/stop button, see Starting with KEYLESS-GO (▷ page 40).

Adjusting Adjusting

Warning!



All seat, head restraint, steering wheel, and rear view mirror adjustments, as well as fastening of seat belts, must be done before the vehicle is put into motion.

Seats

Warning!



Do not adjust the driver's seat while driving. Adjusting the seat while driving could cause the driver to lose control of the vehicle.

Never ride in a moving vehicle with the seat back reclined. Sitting in an excessively reclined position can be dangerous. You could slide under the seat belt in a collision. If you slide under it, the belt would apply force at the abdomen or neck. That could cause serious or fatal injuries. The seat back and seat

belts provide the best restraint when the wearer is in an upright position and belts are properly positioned on the body. Your seat must be adjusted so that you can correctly fasten your seat belt (▷ page 37).

Never place hands under the seat or near any moving parts while a seat is being adjusted.

Warning!



When leaving the vehicle, always remove the key from the starter switch, take the KEY-LESS-GO* card (if so equipped) with you, and lock your vehicle.

The power seats can also be operated with the appropriate door open. Do not leave children unattended in the vehicle, or with access to an unlocked vehicle. Unsupervised use of vehicle equipment may cause an accident and/or serious personal injury.

Warning!



Children 12 years old and under must never ride in this vehicle, except in a Mercedes-Benz authorized BabySmart™ compatible child seat, which operates with the BabySmart™ system installed in the vehicle to deactivate the passenger side front airbag when it is properly installed. Otherwise they will be struck by the airbag when it inflates in a crash. If this happens, serious or fatal injury will result.

Infants and small children must be seated in an appropriate infant or child restraint system, which is properly secured with the vehicle's seat belt, fully in accordance with the child seat manufacturer's instructions.

A child's risk of serious or fatal injuries is significantly increased if the child restraints are not properly secured in the vehicle and the child is not properly secured in the child restraint.

The seat adjustment switch is located in the door.

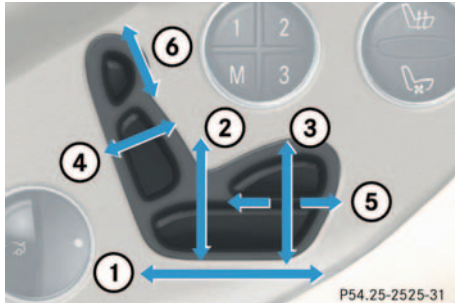

- 1 Seat fore and aft adjustment
- 2 Seat height
- 3 Seat cushion tilt
- 4 Backrest tilt
- 5 Seat cushion depth
- 6 Head restraint height

- ▶ Switch on the ignition by turning the key in the starter switch to position 2 or pressing the KEYLESS GO* start/stop button twice.

Seat fore and aft adjustment

- ▶ Press the switch forward or backward in the direction of arrow 1.



When moving the seat, be sure that nothing is in the auxiliary cup holder and that there are no items in the footwell or behind the seats. Otherwise the seats could be damaged.

Seat height

- ▶ Press the switch up or down in the direction of arrow 2.

Seat cushion tilt

- ▶ Press the switch up or down in the direction of arrow 3 until your upper legs are lightly supported.

Backrest tilt

- ▶ Press the switch forward or back in the direction of arrow 4.

Seat cushion depth

- ▶ Press the switch forward or back in the direction of arrow 5.

Head restraint height

Warning!



For your protection, drive only with properly positioned head restraints.

Adjust head restraint to support the back of the head approximately at ear level.

Do not drive the vehicle without the seat head restraints. Head restraints are intended to help reduce injuries during an accident.

- ▶ Press the switch up or down in the direction of arrow 6.

Adjusting

Head restraint tilt

- ▶ Manually adjust the angle of the head restraint. Push or pull on the lower edge of the head restraint cushion.



The memory function (▷ page 99) lets you store the steering wheel adjustment together with the adjustment for the seat and the exterior rear view mirrors.

More information can be found in the “Controls in detail” section (▷ page 93).

Steering wheel

Warning!



Do not adjust the steering wheel while driving. Adjusting the steering wheel while driving could cause the driver to lose control of the vehicle.

When leaving the vehicle, always remove the key from the starter switch, and take the KEYLESS-GO* card (if so equipped) with you.

The steering wheel adjustment feature can also be operated with the driver's door open. Do not leave children unattended in the vehicle, or with access to an unlocked vehicle. Unsupervised use of vehicle equipment may cause an accident and/or serious personal injury.

The stalk is located on the steering column (lower left).

- ▶ Make sure that the ignition is switched on.

All the lights in the instrument cluster light up.

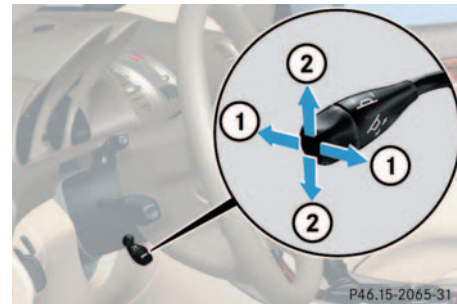

- 1 Steering column, lengthen or shorten
- 2 Steering column, height

Steering column, lengthen or shorten

- ▶ Move stalk forward or back in the direction of arrow 1 until a comfortable steering wheel position is reached with your arms slightly bent at the elbow.

Steering column, height

- ▶ Move the stalk up or down in the direction of arrow **2**. Make sure that your legs can move freely and that all the displays (including malfunction and indicator lamps) on the instrument cluster are clearly visible.



The memory function (▷ page 99) lets you store the steering wheel adjustment together with the adjustment for the seat and the exterior rear view mirrors.

Mirrors

Adjust the inside and exterior rear view mirrors before driving so that you have a good view of the road and traffic conditions.

Inside rear view mirror

- ▶ Manually adjust the inside rear view mirror.

Exterior rear view mirror

The buttons are located on the lower part of the center console.

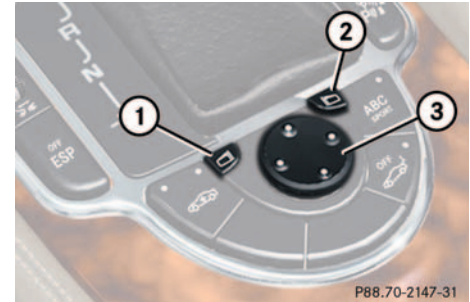

- 1 Driver's side mirror
- 2 Passenger side mirror
- 3 Adjustment button

Adjusting

Warning!



Exercise care when using the passenger side exterior rear view mirror. The mirror surface is convex (outwardly curved surface for a wider field of view). Objects in mirror are closer than they appear. Check your inside rear view mirror or glance over your shoulder before changing lanes.

Warning!



In case of an accident, liquid electrolyte may escape the mirror housing if the mirror glass breaks.

Electrolyte has an irritating effect. Do not allow the liquid to come into contact with eyes, skin, clothing, or respiratory system. In case it does, immediately flush the affected area with water, and seek medical help if necessary.



Electrolyte drops coming into contact with the vehicle paint finish can only be completely removed while in their liquid state and by applying plenty of water.

- ▶ Make sure that the ignition is switched on.

All the lights in the instrument cluster light up.

- ▶ Press button **1** for the left mirror or button **2** for the right mirror.
- ▶ Push adjustment button **3** up, down, left or right according to the setting desired.



The memory function (▷ page 99) lets you store the steering wheel adjustment together with the adjustment for the seat and the exterior rear view mirrors.



If an exterior rear view mirror housing is forcibly pushed forward or rearward, reposition it by applying firm pressure until it snaps into place. The mirror housing is now properly positioned and you can adjust the mirror normally.

More information can be found in the “Controls in detail” section (▷ page 145).

Driving

Warning!



Do not lay any objects in the driver's footwell. Be careful that floor mats or carpets in the driver's footwell have sufficient clearance for the pedals.

During sudden driving or braking maneuvers, the objects could get caught between the pedals. You could then no longer brake or accelerate.

Fastening the seat belts

Warning!



Always fasten your seat belt before driving off. Always make sure your passengers are properly restrained, even pregnant women.

Failure to wear and properly fasten and position your seat belt greatly increases your risk of injuries and their likely severity in an accident. You and your passenger should always wear seat belts.

If you are ever in an accident, your injuries can be considerably more severe without your seat belt properly buckled. Without your seat belt buckled, you are much more likely to hit the interior of the vehicle or be ejected from it. You can be seriously injured or killed.

In the same crash, the possibility of injury or death is lessened if you are wearing your seat belt. The airbags can only protect as expected if the occupants are using their seat belts (▷ page 52).

Warning!



Children 12 years old and under must never ride in this vehicle, except in a Mercedes-Benz authorized BabySmart™ compatible child seat, which operates with the BabySmart™ system installed in the vehicle to deactivate the passenger side front airbag when it is properly installed. Otherwise they will be struck by the airbag when it inflates in a crash. If this happens, serious or fatal injury will result.

Infants and small children must be seated in an appropriate BabySmart™ compatible infant or child restraint system, which is properly secured with the vehicle's seat belt, fully in accordance with the child seat manufacturer's instructions.

A child's risk of serious or fatal injuries is significantly increased if the child restraints are not properly secured in the vehicle and the child is not properly secured in the child restraint.

Warning!



Never ride in a moving vehicle with the seat backrest reclined. Sitting in an excessively reclined position can be dangerous. You could slide under the seat belt in a collision. If you slide under it, the belt would apply force at the abdomen or neck. That could cause serious or even fatal injuries. The seat backrest and seat belt provide the best restraint when the wearer is in an upright position and the belt is properly positioned on the body.

Warning!



Never let more people ride in the vehicle than there are seat belts available. Be sure everyone riding in the vehicle is correctly restrained with a separate seat belt.

Warning!



Read and observe the additional warning notices in the “Safety and Security” section (▷ page 58).

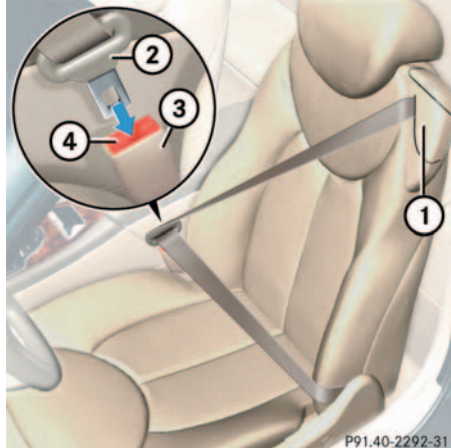

- 1 Seat belt housing
- 2 Latch plate
- 3 Buckle
- 4 Release button

- ▶ With a smooth motion, pull the belt from the seat belt outlet **1**.
- ▶ Place the belt over your shoulder.
- ▶ Push the latch plate **2** into the buckle **3** until it clicks.
- ▶ If necessary, tighten the lap portion to a snug fit by pulling shoulder portion up.

Proper use of seat belts:

- Do not twist the belt when fastening.
- Adjust seat belt so that the shoulder portion is located as close as possible to the middle of the shoulder (it should not touch the neck or pass under the arm).
- Position the lap belt as low as possible on your hips (over hip joint) and not across the abdomen.
- Place the seat backrest in a nearly upright position.
- Never use a seat belt for more than one person at a time.

- Do not fasten a seat belt around a person and another object at the same time.
- Check your seat belt during travel to ensure that it is properly positioned.
- Ensure that the seat belt is always fitted snugly. You should avoid wearing bulky clothing, such as winter coats, when traveling in the vehicle.

Warning!

Do not pass belts over sharp edges. They could tear.

Do not allow the belt to get caught in the door or in the seat adjustment mechanism. This could damage the belt.

Never attempt to make modifications to seat belts. This could impair the effectiveness of the belts.

Damaged seat belts or belts that were highly stressed in an accident must be replaced by an authorized Mercedes-Benz Center.

Starting the engine**Warning!**

Inhalation of exhaust gas is hazardous to your health. All exhaust gas contains carbon monoxide, and inhaling it can cause unconsciousness and lead to death.

Do not run the engine in confined areas (such as a garage) which are not properly ventilated. If you think that exhaust gas fumes are entering the vehicle while driving, have the cause determined and corrected immediately. If you must drive under these conditions, drive with at least one window fully open.

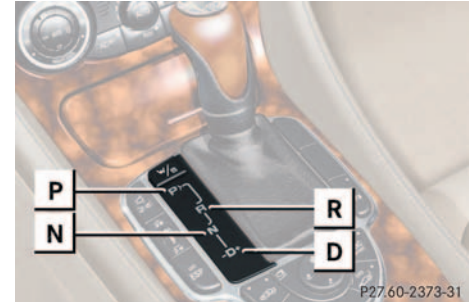
**Gearshift pattern for automatic transmission**

- P** Park position with selector lever lock
- R** Reverse gear
- N** Neutral
- D** Drive position

More information can be found in the “Controls in detail” section (▷ page 137).

- ▶ Make sure that the gear selector lever is set to **P**.

Driving

Starting with the SmartKey

- ▶ Turn the key in the starter switch to position **3** and hold until the engine starts (▷ page 29).



You can also use the “touch-start” function. Turn the key to position **3** and release it again immediately. The engine then starts automatically.

- ▶ Depress the brake pedal.

The selector lever lock is released.

For information on turning off the engine with the key, see “Turning off engine with the key” (▷ page 48).

Starting with KEYLESS-GO*

You can start your vehicle without a key using the KEYLESS-GO start/stop button on the gear selector lever.



1 KEYLESS-GO start/stop button

- ▶ Depress the brake pedal during the starting procedure. Do not depress accelerator.

The selector lever lock is released.

- ▶ Press the KEYLESS-GO start/stop button **1** once.

The engine starts automatically.

For information on turning off the engine with KEYLESS-GO, see “Turning off engine with KEYLESS-GO*” (▷ page 49).

Starting difficulties

If the engine does not start as described, carry out the following steps:

- ▶ If you are starting the engine with the key: Turn key in starter to position **0** and repeat starting procedure.
- ▶ If you are starting the engine with KEYLESS-GO: Close any doors that may be open to allow for better detection of the card.
Or:
Start the engine with the key as radio signals from another source may be interfering with the KEYLESS-GO card.
- ▶ Repeat the starting procedure (▷ page 39). Remember that extended starting attempts can drain the battery.
- ▶ Get a jump start (▷ page 323).

If the engine does not start after several starting attempts, there could be a malfunction in the engine electronics or in the fuel supply system.

- ▶ Notify an authorized Mercedes-Benz Center.

Parking brake

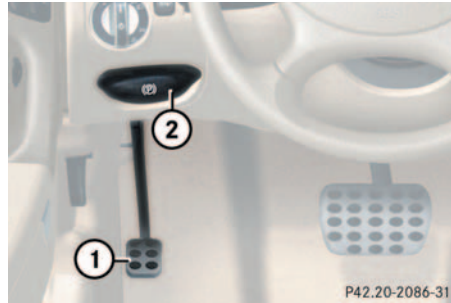

- 1 Parking brake
- 2 Release handle

Warning!



When leaving the vehicle always remove the key from the starter switch, take the KEYLESS-GO card (if so equipped) with you and lock the vehicle. Do not leave children unattended in the vehicle, or with access to an unlocked vehicle. Children could release the parking brake, which could result in an accident and/or serious injury.

- ▶ Release the parking brake by pulling on handle **2**.

The indicator lamp **BRAKE** (USA only) or  (Canada only) in the speedometer goes out.

Driving

Driving

- ▶ Place the gear selector lever in position **D** or **R**.
- ▶ Release the brake pedal.
- ▶ Carefully depress the accelerator pedal.

Once the vehicle is in motion, the automatic central locking system engages and the locking knobs drop down.



You can open a locked door from the inside. Open door only when conditions are safe to do so.



If you hear a warning signal when driving off, you have forgotten to release the parking brake.

Release the parking brake.

After a cold start, the transmission engages at a higher revolution. This allows the catalytic converter to reach its operating temperature earlier.



Wait for the gear selection process to complete before setting the vehicle in motion.

Warning!



It is dangerous to shift the selector lever out of **P** or **N** if the engine speed is higher than idle speed. If your foot is not firmly on the brake pedal, the vehicle could accelerate quickly forward or in reverse. You could lose control of the vehicle and hit someone or something. Only shift into gear when the engine is idling normally and when your right foot is firmly on the brake pedal.



Simultaneously depressing the accelerator pedal and applying the brake reduces engine performance and causes premature brake and drivetrain wear.

Warning!



On slippery road surfaces, never downshift in order to obtain braking action. This could result in drive wheel slip and reduced vehicle control. Your vehicle's ABS will not prevent this type of loss of control.

Switching on headlamps

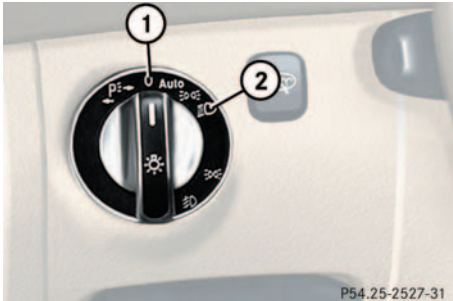

Exterior lamp switch

- 1 Off
- 2 Low beam headlamps on

► Turn the switch to .

More information can be found in the “Controls in detail” section (► page 102).

Turn signals and high beam

The combination switch is on the left of the steering column.

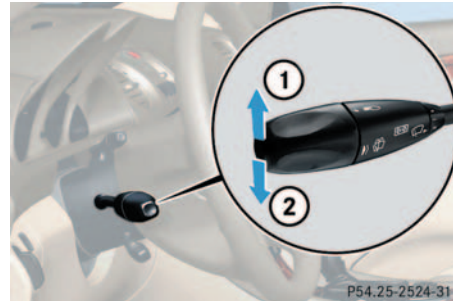

Combination switch

- 1 Turn signals, right
- 2 Turn signals, left

► Press the combination switch up **1** or down **2**.



To signal minor directional changes, move combination switch to point of resistance only and release. The turn signal blinks three times.

High beam

► Push the combination switch forward.

The high beam symbol  in the tachometer lights up.

Driving

Windshield wipers

The combination switch is on the left of the steering column.



Combination switch

- 1 Single wipe
 - 2 Switching on windshield wipers
- ▶ Make sure that the ignition is switched on.

Switching on windshield wipers

- ▶ Turn the combination switch to the desired position depending on the intensity of the rain.

- 0 Windshield wipers off
- I Intermittent wiping (interval dependent on wetness of windshield)
- II Normal wiper speed
- III Fast wiper speed (Canada only: goes to setting II when the car is standing still)



The intermittent wiping interval is dependent on wetness of windshield. Wiping will not occur with a door open.



Do not leave windshield wipers in intermittent setting when vehicle is taken to an automatic car wash or during windshield cleaning. Wipers will operate in the presence of water sprayed on the windshield, and wipers may be damaged as a result.

The switch should not be left in intermittent setting as the wipers will wipe the windshield once every time the engine is started. Dust that accumulates on the windshield might scratch the glass when wiping occurs on a dry windshield.

Single wipe

- ▶ Press switch briefly in the direction of arrow 1.

The windshield wipers wipe one time without washer fluid.

Wiping with windshield washer fluid

- ▶ Push switch in the direction of arrow 1 past the resistance point.

The windshield wiper operates with washer fluid.

Information on filling up the washer reservoir can be found in the "Operation" section (▷ page 233).



If leaves, snow, etc. block the windshield wipers, the wiper motor turns off.

- For safety reasons, withdraw key from starter switch. Remove blockage.
- Turn the windshield wipers on again.

If windshield wipers fail to function at all in switch position I,

- set the combination switch to the next highest wiper speed.
- have the windshield wipers checked at the nearest authorized Mercedes-Benz Center.

Problems while driving

The engine runs erratically and misfires

- An ignition cable may be damaged.
 - The engine electronics may not be operating properly.
 - Unburned gasoline may have entered the catalytic converter and damaged it.
- ▶ Give very little gas.
 - ▶ Have the problem repaired by an authorized Mercedes-Benz Center as soon as possible.

The coolant temperature gauge is over 248°F (120°C)

The coolant is too hot and is no longer cooling the engine.

- ▶ Stop the vehicle as soon as possible and turn off the engine. Allow engine and coolant to cool.
- ▶ Check the coolant level and add coolant if necessary (▷ page 230).

Driving

In case of accident

If the vehicle is leaking gasoline:

- ▶ Do not start the engine under any circumstances.
- ▶ Notify local fire and/or police authorities.

If the extent of the damage cannot be determined:

- ▶ Notify an authorized Mercedes-Benz Center.

If no damage can be determined on the

- major assemblies
 - fuel system
 - engine mount:
- ▶ Start the engine in the usual manner.

Parking and locking

You have now completed your first drive. You have properly stopped and parked your vehicle. End your drive as follows:

Warning!



Wait until the vehicle is stationary before removing the key from the starter switch. The vehicle cannot be steered when the key is removed.

Warning!



With the engine not running, there is no power assistance for the steering system. In this case, it is important to keep in mind that a considerably higher degree of effort is necessary to steer the vehicle.

Warning!



Do not park this vehicle in areas where combustible materials such as grass, hay or leaves can come into contact with the hot exhaust system, as these materials could be ignited and cause a vehicle fire.

To reduce the risk of personal injury as a result of vehicle movement, before turning off the engine and leaving the vehicle always:

- Keep right foot on brake pedal.
- Firmly depress parking brake pedal.
- Move the selector lever to position **P**.
- Slowly release brake pedal.
- When parked on an incline, turn front wheel against road curb.
- Turn the key to starter switch position **0** and remove, or press start / stop button (vehicles with KEYLESS-GO*).
- Take the key and the KEYLESS-GO* card (vehicles with KEYLESS-GO*) and lock vehicle when leaving.

Parking brake

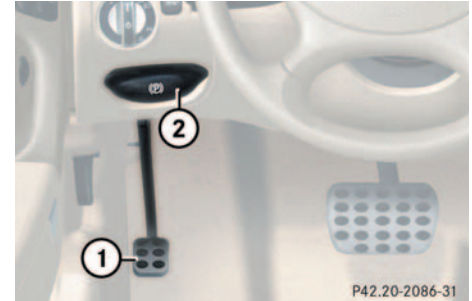

- 1** Parking brake
2 Release handle

- Step firmly on the parking brake **1**.

When the engine is running, the indicator lamp **BRAKE** (USA only) or **(P)** (Canada only) in the speedometer dial will be illuminated

Warning!



When leaving the vehicle, always remove the key from the starter switch, take the KEY-LESS-GO* card (if so equipped) with you and lock the vehicle. Do not leave children unattended in the vehicle, or with access to an unlocked vehicle. Children could release the parking brake and/or move the gear selector lever from position **P**, either of which could result in an accident and/or serious injury.

Warning!



Getting out of your vehicle with the selector lever not fully engaged in position **P** is dangerous. Also, when parked on an incline, position **P** alone may not prevent your vehicle from moving, possibly hitting people or objects.

Always set the parking brake in addition to shifting to position **P** (▷ page 140).

When parked on an incline, also turn front wheel against road curb.

Switching off headlamps

- ▶ Turn the switch to **0** (▷ page 43).

More information can be found in the “Controls in detail” section (▷ page 102).

Turning off engine with the key

- ▶ Place the gear selector lever in **P**.



Always set the parking brake in addition to shifting to position **P**.

On steep slopes, turn the front wheels towards the road curb.

- ▶ Turn the key in the starter switch (▷ page 29) to position **0** and remove it.
The immobilizer is activated.
- ▶ Press the seat belt release button (▷ page 37).



If you hear a warning signal you have either

- forgotten to turn off the lights, or
- not put the gear selector lever in **P** before opening the driver's door.

Turn off the lights or place the gear selector lever in **P**.

- ▶ After exiting the vehicle, press the lock button  on the remote control (▷ page 28).

The locking knobs on the doors move down.

More information can be found in the “Controls in detail” section (▷ page 80).

Turning off engine with KEYLESS-GO*

- ▶ Place the gear selector lever in **P**.
- ▶ Press the KEYLESS-GO start/stop button until the engine shuts off.

With the driver's door closed, the starter switch is now in the position **1**. With the driver's door opened, the starter switch is set to position **0**, same as key removed from starter switch (▷ page 29).

- ▶ Press the seat belt release button (▷ page 37).



If you hear a warning signal you have either

- forgotten to turn off the lights, or
- not put the gear selector lever in **P** before opening the driver's door.

Turn off the lights or place the gear selector lever in **P**.

Warning!



To prevent possible personal injury, always keep hands and fingers away from the door openings when closing the doors. Be especially careful when small children are around.

Before closing doors, make sure that there is no possibility of someone getting caught in a door during closing.

Warning!



To prevent possible personal injury, always keep hands and fingers away from the door openings when closing the doors. Be especially careful when small children are around.

Before closing doors, make sure that there is no possibility of someone getting caught in a door during closing.

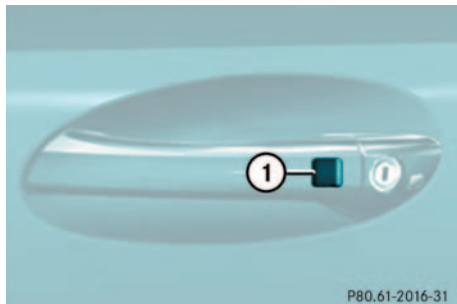

1 Lock button on the door handle

- ▶ After exiting the vehicle, press the lock button **1** on the door handle.

The locking knobs on the doors move down.

More information can be found in the “Controls in detail” section (▶ page 80).

Emergency engine shut-down

If the engine cannot be turned off as described, you may use the following backup procedure.

- ▶ Open the main fuse box (▶ page 329).
- ▶ Pull out the two fuses labeled “ENGINE EMERGENCY STOP” (▶ page 329).

Warning!



When leaving the vehicle, always remove the key from the starter switch, take the KEYLESS-GO* card (if so equipped) with you, and lock your vehicle. Do not leave children unattended in the vehicle, or with access to an unlocked vehicle. Unsupervised use of vehicle equipment may cause an accident and/or serious personal injury.

Safety and Security

Occupant safety

Panic alarm

Driving safety systems

Anti-theft systems



Occupant safety

In this section you will learn the most important facts about the restraint systems of the vehicle.

The restraint systems are

- Seat belts
- Emergency tensioning device
- Airbags
- Child seats
- Child seat recognition

As independent systems their protective effects work in conjunction with each other.



For information on infants and children traveling with you in the vehicle and restraint systems for infants and children, see "Children in the vehicle" (▷ page 62).

Occupant safety

The **SRS** warning lamp in the instrument cluster lights up for about 4 seconds when you turn the key in the starter switch to position **1** or **2**, or press the KEYLESS-GO* (if so equipped) start/stop button once or twice. It goes out when you start the engine. This shows that the restraint systems are operational.

If the lamp does not come on at all or if it fails to extinguish after approximately 4 seconds or if it comes on thereafter, a malfunction in the system has been detected.

More information can be found in the "Practical hints" section (▷ page 252).

Warning!



In the event that the SRS malfunction indicator lamp lights up during driving or does not come on at all, the SRS may not be operational. For your safety, we strongly recommend that you visit an authorized Mercedes-Benz Center immediately to have the system checked; otherwise the SRS may not be activated when needed in an accident, which could result in serious or fatal injury, or it might deploy unexpectedly and unnecessarily which could also result in injury.

Improper work on the restraint systems can lead to unintentional deployment or operational failure.

In addition, through improper work there is a risk of rendering the SRS inoperative or causing unintended airbag deployment. Work on the SRS must therefore only be performed by an authorized Mercedes-Benz Center.

Airbags

Warning!



Airbags are designed to reduce the potential for injury resulting from certain frontal impacts (front airbags, driver-side kneebag) or side impacts (head-thorax airbags) which may cause significant injuries. However, no system available today can totally eliminate injuries and fatalities.

The activation of the SRS temporarily releases a small amount of dust from the airbags. This dust, however, is neither injurious to your health, nor does it indicate a fire in the vehicle. The dust might cause some temporary breathing difficulty for people with asthma or other breathing trouble. To avoid this, you may wish to get out of the vehicle as soon as it is safe to do so. If you have any breathing difficulty but cannot get out of the vehicle after the airbag inflates, then get fresh air by opening a window or door.

Warning!



To reduce the risk of injury when the front airbags inflate, it is very important for the driver and passenger to always be in a properly seated position and to wear your seat belts.

For maximum protection in the event of a collision always be in normal seated position with your back against the backrest. Fasten your seat belt and ensure that it is properly positioned on your body (▷ page 37).

Since the airbag inflates with considerable speed and force, a proper seating and hands on steering wheel position will help to keep you at a safe distance from the airbag. Occupants who are unbelted, out of position or too close to the airbag can be seriously injured by an airbag as it inflates with great force in the blink of an eye:

- Sit properly belted in an upright position with your back against the seat backrest.

- Adjust the driver seat as far as possible rearward, still permitting proper operation of vehicle controls. The distance from the center of the driver's breastbone to the center of the airbag cover on the steering wheel must be at least ten inches (25 cm) or more. You should be able to accomplish this by a combination of adjustments to the seat and steering wheel. If you have any problems, please see your authorized Mercedes-Benz Center.
- Do not lean with your head or chest close to the steering wheel or dashboard.
- Keep hands on the outside of steering wheel rim. Placing hands and arms inside the rim can increase the risk and potential severity of hand / arm injury when driver front airbag inflates.
- Adjust the passenger seat as far as possible rearward from the dashboard when the seat is occupied.

Occupant safety

- Occupants, especially children, should never lean their heads in the area of the door where the head-thorax airbag inflates. This could result in serious injuries or death should the airbag be triggered. Always sit upright, properly use the seat belts and appropriate size infant or child restraint system.
- Children 12 years old and under must never ride in this vehicle, except in a Mercedes-Benz authorized BabySmart™ compatible child seat, which operates with the BabySmart™ system installed in the vehicle to deactivate the passenger side front airbag when it is properly installed. Otherwise they will be struck by the airbag when it inflates in a crash. If this happens, serious or fatal injury will result.

Failure to follow these instructions can result in severe injuries to you or other occupants.

If you sell your vehicle you are responsible to make the buyer aware of these points. Be sure to give the buyer this Operator's Manual.

Warning!



Should you choose to place a child 12 years old or under in the passenger seat of your vehicle, you must properly use a BabySmart™ child restraint which will turn off the passenger side front airbag (▷ page 62). BabySmart™ will not, however, turn off any side impact airbag.

It should be noted, however, that there is a possibility for a head-thorax airbag related injury if occupants, especially children, are not properly seated or restrained when next to a head-thorax airbag which needs to deploy rapidly in a side impact in order to do its job.

To help avoid the possibility of injury, please follow these guidelines:

- (1) Occupants, especially children, should never place their bodies or lean their heads in the area of the door where the head-thorax airbag inflates. This could result in serious injuries or death should the head-thorax airbag be activated.

- (2) Always sit upright, properly use the seat belts and use an appropriately sized infant or child restraint system for all children 12 years old or under.

- (3) Always wear seat belts properly.

If you believe that, even with the use of these guidelines, it would be safer for your passenger seat occupants to have the passenger side head-thorax airbag deactivated, then deactivation can be accomplished upon your written election to do so at your authorized Mercedes-Benz Center at an additional cost. Please contact your local authorized Mercedes-Benz Center or call our Customer Assistance Center at 1-800-FOR-MERCEDES (1-800-367-6372) for details.



Airbags are designed to activate only in certain frontal impacts (front air bags, driver-side knee bag), side impacts (head-thorax airbags) which exceed preset thresholds. Only during these types of impacts, if of sufficient severity to meet the deployment threshold, will they provide their supplemental protection.

The driver and passengers should always wear their seat belts. Otherwise it is not possible for the airbags to provide their intended supplemental protection.

In cases of other frontal impacts, angled impacts, roll-overs, other side impacts, rear collisions, or other accidents and impacts below air bag deployment thresholds, the airbags will not be activated. The driver and passenger will then be protected to the extent possible by a properly fastened seat belt.

We caution you not to rely on the presence of the airbags in order to avoid wearing your seat belt.

Your vehicle was originally equipped with airbags which are designed to activate in certain impacts exceeding a preset threshold to reduce the potential and severity of injury. It is important to your safety and that of your passenger that you replace deployed airbags and repair any malfunctioning airbags to ensure that the vehicle will continue to provide supplemental crash protection for occupants.

Safety guidelines for the seat belt, emergency tensioning device and airbag

Warning!



- Damaged seat belts or belts that were highly stressed in an accident must be replaced and their anchoring points must also be checked. Only use belts installed or supplied by an authorized Mercedes-Benz Center.
- Airbags and ETDs (Emergency Tensioning Devices) are designed to function on a one-time-only basis. An airbag or ETD that was activated must be replaced.

Occupant safety

- No modifications of any kind may be made to any components or wiring of the SRS. This includes changing or removing any component or part of the SRS, the installation of additional trim material, badges, etc., over the steering wheel hub, passenger front airbag cover, or door trim panels, and installation of additional electrical/electronic equipment on or near SRS components and wiring. Keep area between airbags and occupants free from objects (e.g. packages, purses, umbrellas, etc.).
 - Do not pass belts over sharp edges. They could tear.
 - Do not make any modification that could change the effectiveness of the belts.
 - An airbag system component within the steering wheel gets hot after the airbag has inflated. Do not touch.
 - Improper work on the system, including incorrect installation and removal, can lead to possible injury through an unintended activation of the SRS.
- In addition, through improper work there is a risk of rendering the SRS inoperative or causing unintended airbag deployment. Work on the SRS must therefore only be performed by an authorized Mercedes-Benz Center.
 - For your protection and the protection of others, when scrapping the airbag unit or emergency tensioning device, our safety instructions must be followed. These instructions are available from your authorized Mercedes-Benz Center.
 - Given the considerable deployment speed and the textile structure of the airbags, there is the possibility of abrasions or other injuries resulting from airbag deployment.

When you sell your vehicle, we strongly urge you to give notice to the subsequent owner that it is equipped with an SRS by alerting them to the applicable section in the Operator's Manual.

Warning!



In the event that the SRS malfunction indicator lamp lights up while driving, the SRS may not be operational. For your safety, we strongly recommend that you visit an authorized Mercedes-Benz Center immediately to have the system checked; otherwise the SRS may not be activated when needed in an accident, which could result in serious or fatal injury, or it might deploy unexpectedly and unnecessarily which could also result in injury.

When an airbag deploys, a small amount of dust is released while inflating. This dust is neither injurious to your health, nor does it indicate a fire in the vehicle.

The textile texture of the airbags can cause light skin abrasions due to the speed of inflation.

Front airbags

Driver and passenger airbags are deployed:

- in the event of a frontal impact
- if impact exceeds a preset deployment threshold
- independently of the head-thorax airbags

The airbags will not deploy in impacts which do not exceed the system's deployment thresholds. You will then be protected by the fastened seat belts.

The passenger airbag will only be deployed if:

- the passenger seat is occupied
- the **AIRBAG off** indicator lamp on the glove box is not lit (▷ page 64)



- 1 Driver airbag
- 2 Passenger airbag
- 3 Kneebag



Do not place objects heavier than 20 lbs (9 kg) on the front passenger seat. This could cause the front or side impact airbag on the front passenger side to deploy in a crash which exceeds the system's deployment threshold.

Kneebag

The kneebag is located on the driver-side lower instrument panel. It is designed to operate together with the driver airbag in certain frontal impacts exceeding a preset threshold. The kneebag operates best in conjunction with a properly positioned and fastened seat belt.

Occupant safety

Head-thorax airbags

The head-thorax airbags are deployed:

- on the impacted side of the vehicle
- in impacts exceeding a preset deployment threshold
- independently of the front airbags

The head-thorax airbags are not deployed in impacts which do not exceed the system's deployment threshold.

The passenger head-thorax airbag will only deploy if the system senses that the passenger seat is occupied.

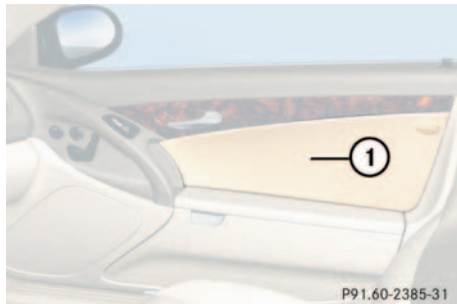

1 Head-thorax airbag

Seat belts

The use of seat belts and infant and child restraint systems is required by law in all 50 states, the District of Columbia, the U.S. territories, and all Canadian provinces. Even where this is not the case, all vehicle occupants should have their seat belts fastened whenever the vehicle is in motion.

Information on fastening seat belts is found in the “Getting started” section (▷ page 37).



For information on infants and children traveling with you in the vehicle and restraint systems for infants and children, see Children in the vehicle (▷ page 62).

Warning!



Always fasten your seat belt before driving off. Always make sure your passengers are properly restrained, even pregnant women.

Failure to wear and properly fasten and position your seat belt greatly increases your risk of injuries and their likely severity in an accident. You and your passenger should always wear seat belts.

If you are ever in an accident, your injuries can be considerably more severe without your seat belt properly buckled. Without your seat belt buckled, you are much more likely to hit the interior of the vehicle or be ejected from it. You can be seriously injured or killed.

In the same crash, the possibility of injury or death is lessened if you are properly wearing your seat belt. Airbags can only protect as they are designed if the occupants are properly wearing their seat belts (▷ page 53).

Warning!

Never ride in a moving vehicle with the seat backrest reclined. Sitting in an excessively reclined position can be dangerous. You could slide under the seat belt in a collision. If you slide under it, the belt would apply force at the abdomen or neck. This could cause serious or even fatal injuries. The seat backrest and seat belt provide the best restraint when the wearer is in an upright position and the belt is properly positioned on the body.

Keep door storage compartments closed while vehicle is in motion. Failure to do so may cause the seat belt to catch at the rear and prevent proper positioning of the seat belt.

Warning!

Never let more people ride in the vehicle than there are seat belts available. Be sure everyone riding in the vehicle is correctly restrained with a separate seat belt.

Warning!

Damaged seat belts or belts that were highly stressed in an accident must be replaced and their anchoring points must also be checked.

Only use seat belts which have been approved by Mercedes-Benz.

Do not make any modifications to the seat belts. This can lead to unintended activation or to failure.

Have all work carried out only by an authorized Mercedes-Benz Center.

Warning!**USE SEAT BELTS PROPERLY**

- Seat belts can only work when used properly. Never wear seat belts in any other way than as described in this section, as that could result in serious injuries in case of an accident.
- Each occupant should wear their seat belt at all times, because seat belts help reduce the likelihood of and potential severity of injuries in accidents, including rollovers. The integrated restraint system includes SRS (driver airbag, driver-side knee bag, passenger airbag, head-thorax airbags) and ETD (seat belt emergency tensioning device). The system is designed to enhance the protection offered to properly belted occupants in certain frontal (front airbags, driver-side knee bag) and side (head-thorax airbags) impacts which exceed preset deployment thresholds.

Occupant safety

- Never wear the shoulder belt under your arm, against your neck or off your shoulder. In a crash, your body would move too far forward. That would increase the chance of head and neck injuries. The belt would also apply too much force to the ribs or abdomen, which could severely injure internal organs such as your liver or spleen.
 - Never wear belts over rigid or breakable objects in or on your clothing, such as eyeglasses, pens, keys etc., as these might cause injuries.
 - Position the lap belt as low as possible on your hips and not across the abdomen. If the belt is positioned across your abdomen, it could cause serious injuries in a crash.
- Never use a seat belt for more than one person at a time. Do not fasten a seat belt around a person and another person or other objects.
 - Belts should not be worn twisted. In a crash, you wouldn't have the full width of the belt to manage impact forces. The twisted belt against your body could cause injuries.
 - Pregnant women should also use a lap-shoulder belt. The lap belt portion should be positioned as low as possible on the hips to avoid any possible pressure on the abdomen.
 - Never place your feet on the instrument panel or on the seat. Always keep both feet on the floor in front of the seat.

Emergency tensioning device (ETD), seat belt force limiter

The seat belts are equipped with emergency tensioning devices, belt force limiters, and automatic comfort-fit.

The ETD is designed to activate in the following cases when the seat belts are fastened:

- in frontal or rear-end impacts exceeding a preset severity level
- if the restraint systems are operational and functioning correctly, see **SRS** indicator lamp (▷ page 52).

In an impact, emergency tensioning devices remove slack from the belts in such a way that the seat belts fit more snugly against the body. Belt force limiters reduce the force exerted by the seat belts on occupants during a crash.

The automatic comfort-fit feature reduces the retracting force of the seat belts when they are in normal use.

Warning!



An emergency tensioning device (ETD) that was activated must be replaced.

When scrapping the emergency tensioning device, our safety instructions must be followed. These are available at your authorized Mercedes-Benz Center.



Do not place objects heavier than 20 lbs (9 kg) on the front passenger seat. This could cause the front or side impact airbag on the front passenger side to deploy in a crash which exceeds the system's deployment threshold.

Roll bar

Warning!



This vehicle is a two occupant vehicle. The rear storage area is not intended for use by occupants and is not equipped for properly seating or restraining occupants. Thus this area should never be used by any persons.

Before operating the roll bar switch make sure that the roll bar's path is clear and no persons are injured by the moving roll bar due to inattention. Raising or lowering of the roll bar could injure someone inadvertently occupying the rear storage area.

For your own safety we recommend to drive with the roll bar raised if the outside temperature is below +5°F (-15°C).



If the outside temperature falls below +5°F (-15°C), the roll bar must be raised manually using the buttons provided to avoid damaging the hydraulics.

The roll bar raises automatically in an accident or in a critical driving situation. You can also raise and lower the roll bar manually using the buttons provided.



When the roll bar is raised automatically, you will hear a ratcheting sound.

The buttons for the roll bar are on the center console under the roof switch.



- 1 Lower roll bar
- 2 Raise roll bar

The roll bar can be moved manually when the ignition is turned on.

Occupant safety

Warning!



If the roll bar warning light  in the tachometer remains lit after starting the engine, there is a malfunction. In the display you see the message `Raise the roll-over bar`.

For safety reasons drive only with the roll bar upright until the malfunction is repaired. Have your vehicle checked at an authorized Mercedes-Benz Center.

Raising the roll bar

- ▶ Lift the switch for the retractable hardtop.
- ▶ Press and hold button **2** until the roll bar is raised.

Lowering the roll bar

If the rollbar was raised manually:

- ▶ Lift the switch for the retractable hardtop.
- ▶ Press and hold button **1** until the roll bar is lowered.

If the rollbar was raised automatically:

- ▶ Press and hold button **2** until you hear the roll bar lock into place.
- ▶ Press and hold button **1** until the roll bar is lowered.



If you raised the roll bar manually using the button, the roll bar will be automatically lowered and then raised again when you open or close the retractable hardtop.

Children in the vehicle

If an infant or child is traveling with you in the vehicle:

- Secure the child using an infant or child restraint appropriate to the age and size of the child and recommended for use by Mercedes-Benz.
- Ensure that the infant or child is properly secured by a belt at all times while the vehicle is in motion.

Infant and child restraint seats and information on choosing an appropriate restraint system can be obtained from any Mercedes-Benz Center.

Infant and child restraint systems

Only use a BabySmart™ compatible child restraint for the front passenger seat in this vehicle.

BabySmart™ is a trademark of Siemens Automotive Corp.

We recommend all infants and children be properly restrained at all times while the vehicle is in motion.

The passenger lap-shoulder belt has a special seat belt retractor for the secure fastening of child restraints.

To fasten a child restraint follow child restraint instructions for mounting. Then pull the shoulder belt out completely and let it retract. During the seat belt retraction a ratcheting sound can be heard to indicate that the special seat belt retractor is activated. The belt is now locked. Push down on child restraint to take up any slack.

To deactivate, release seat belt buckle and let seat belt retract completely. The seat belt can again be used in the usual manner.

Warning!

Never release the seat belt buckle while the vehicle is in motion, since the special seat belt retractor will be deactivated.



The use of infant or child restraints is required by law in all 50 states, the District of Columbia, the U.S. territories, and all Canadian provinces.

Infants and small children should be seated in an appropriate infant or child restraint system properly secured by a lap-shoulder belt, and that complies with U.S. Federal Motor Vehicle Safety Standard 213 and Canadian Motor Vehicle Safety Standard 213.

A statement by the child restraint manufacturer of compliance with this standard can be found on the instruction label on the restraint and in the instruction manual provided with the restraint.

When using any infant or child restraint system, be sure to carefully read and follow all manufacturer's instructions for installation and use.

Please read and observe warning labels affixed to inside of vehicle and to infant or child restraints.

Warning!

Children 12 years old and under must never ride in this vehicle, except in a Mercedes-Benz authorized BabySmart™ compatible child seat, which operates with the BabySmart™ system installed in the vehicle to deactivate the passenger side front airbag when it is properly installed. Otherwise they will be struck by the airbag when it inflates in a crash. If this happens, serious or fatal injury will result.

Infants and small children must be seated in an appropriate BabySmart™ compatible infant or child restraint system, which is properly secured with the vehicle's seat belt, fully in accordance with the child seat manufacturer's instructions.

Occupant safety

Infants and small children should never share a seat belt with another occupant. During an accident, they could be crushed between the occupant and seat belt.

A child's risk of serious or fatal injuries is significantly increased if the child restraints are not properly secured in the vehicle and the child is not properly secured in the child restraint.

Adjust the passenger seat as far as possible rearward from the dashboard when the seat is occupied.

Warning!



Children too big for child restraint systems should use regular seat belts. Position the shoulder belt across chest and shoulder, not face or neck. A booster seat may be necessary to achieve proper belt positioning for children from 41 lbs. until they reach a height where a lap/shoulder belt fits properly without a booster.

When the child restraint is not in use, remove it from the vehicle or secure it with the seat belt to prevent the child restraint from becoming a projectile in the event of an accident.

Do not leave children unattended in the vehicle; even if the children are secured in a child restraint system. Unsupervised children in a child restraint system may use vehicle equipment and may cause serious personal injury.

BabySmart™ airbag deactivation system

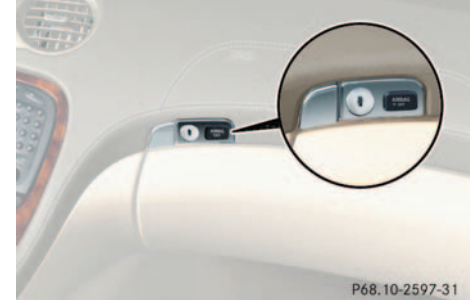

Special BabySmart™ compatible child seats, designed for use with the Mercedes-Benz system and available at any authorized Mercedes-Benz Center, are required for use with the BabySmart™ airbag deactivation system. With the special child seat properly installed, the passenger front airbag will not deploy.

BabySmart™ is a trademark of Siemens Automotive Corp.

The  indicator lamp located on the glove box will be illuminated, except with the key removed or in the starter switch position **0**.



The system does not deactivate the head-thorax airbag and the emergency tensioning device.

Self-test BabySmart™ without special child seat installed

After turning the key in the starter switch to position **1** or **2**, the  indicator lamp located on the glove box lights up for approx. 6 seconds and then goes out.

If the indicator lamp should not come on or is continuously lit, the system is not functioning. You must see an authorized Mercedes-Benz Center before seating any child on the passenger seat.

Warning!



The BabySmart™ airbag deactivation system will **ONLY** work with a special child seat designed to operate with it. It will not work with child seats which are not BabySmart™ compatible.

Never place anything between seat cushion and child seat (e.g. pillow), since it reduces the effectiveness of the deactivation system. The bottom of the child seat must make full contact with the passenger seat cushion. An incorrectly mounted child seat could cause injuries to the child in case of an accident, instead of protecting the child.

Follow the manufacturer's instructions for installation of special child seats.

Warning!



When using a BabySmart compatible child seat on the front passenger seat, the front passenger airbag will not deploy only if the  indicator lamp remains illuminated.

Please be sure to check the indicator every time you use the special system child seat. Should the light go out while the restraint is installed, please check installation. If the light remains out, do not use the BabySmart™ restraint to transport children on the passenger seat until the system has been repaired.

Occupant safety

Warning!



Do not place powered-on laptops, cell phones and like electronic devices on the passenger seat. Signals from such devices may interfere with the BabySmart™ system. Such signal interference may cause the  indicator lamp not to come on during self-test or be continuously lit, indicating that the system is not functioning.

Panic alarm

An audible alarm and blinking exterior lamps will operate for approximately 2 ¹/₂ minutes.

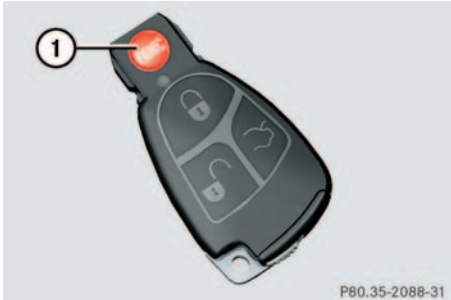

1 **PANIC** button

Activating

- ▶ Press and hold button 1 for at least one second.

Deactivating

- ▶ Press button 1 again.
or
- ▶ Insert key in starter switch.



For operation in the USA only: This device complies with Part 15 of the FCC Rules. Operation is subject to the following two conditions:

- (1) This device may not cause harmful interference, and
- (2) this device must accept any interference received, including interference that may cause undesired operation.

Any unauthorized modification to this device could void the user's authority to operate the equipment.

Driving safety systems

Driving safety systems

In this section you will find information on the following driving safety systems:

- ABS (Antilock Brake System)
- BAS (Brake Assist System)
- ESP (Electronic Stability Program)
- SBC brake system (Sensotronic Brake Control)



In winter operation, the maximum effectiveness of the ABS, the BAS, the ESP, and SBC is only achieved with winter tires (M+S tires), or snow chains as required.

Warning!



The following factors increase the risk of accidents:

- excessive speed, especially in turns
- wet and slippery road surfaces
- following another vehicle too closely

ABS, BAS, ESP and SBC cannot reduce this risk.

Always adjust your driving style to the prevailing road and weather conditions.

ABS

Warning!





Do not pump the brake pedal, rather use firm, steady brake pedal pressure. Pumping the brake pedal defeats the purpose for ABS and significantly reduces braking effectiveness.

The ABS regulates the brake pressure so that the wheels do not lock during braking. This allows you to maintain the ability to steer your vehicle.

The ABS is functional above a speed of approximately 5 mph (8 km/h) independent of road surface conditions.

On slippery road surfaces, the ABS will respond even with light brake pressure.

If the ABS activates during braking, the ABS/ESP warning lamp  in the speedometer dial flashes. Because of the SBC brake system, you will not feel any pulsation in the brake pedal.

The  warning lamp in the speedometer (▷ page 21) lights up when you turn the key to position **1** or **2**. It goes out when the engine is running.

Flashing warning lamp while braking

The  warning lamp flashes whenever the ABS is activated. Always adapt your driving style to the prevailing road and weather conditions.

- ▶ When the ABS is in the regulating mode, continue to apply pressure on the brake pedal.

Warning!



The ABS cannot prevent the natural laws of physics from acting on the vehicle, nor can it increase braking or steering efficiency beyond that afforded by the condition of the vehicle brakes and tires or the traction afforded. The ABS cannot prevent accidents, including those resulting from excessive speed in turns, following another vehicle too closely, or aquaplaning. Only a safe, attentive, and skillful driver can prevent accidents. The capabilities of an ABS equipped vehicle must never be exploited in a reckless or dangerous manner which could jeopardize the user's safety or the safety of others.

BAS

The Brake Assist System (BAS) operates in emergency situations. If you apply the brakes very quickly, the BAS automatically provides full brake boost thereby potentially reducing the braking distance. Apply continuous full braking pressure until the emergency braking situation is over. The ABS will prevent the wheels from locking.

When you release the brake pedal the brakes function again as normal. The BAS is then deactivated.

Warning!





BAS cannot prevent the natural laws of physics from acting on the vehicle, nor can it increase braking efficiency beyond that afforded by the condition of the vehicle brakes and tires or the traction. The BAS cannot prevent accidents, including those resulting from excessive speed in turns, following another vehicle too closely, or hydroplaning. Only a safe, attentive, and skillful driver can prevent accidents. The capabilities of a BAS equipped vehicle must never be exploited in a reckless or dangerous manner which could jeopardize the user's safety or the safety of others.

ESP

The Electronic Stability Program (ESP) monitors the vehicle's traction (force of adhesive friction between the tires and the road surface) and handling.

The ESP recognizes when a wheel is spinning or if the vehicle starts to skid. By applying brakes to the appropriate wheel and by limiting engine output, the ESP works to stabilize the vehicle. The ESP is especially useful while driving off and on wet or slippery road surfaces.

The ABS/ESP warning lamp  in the speedometer dial flashes when the ESP is engaged.

The warning lamp  in the speedometer dial (▷ page 21) lights up when you turn the key to position **1** or **2**. It goes out when you start the engine

Warning!



Never switch off the ESP when you see the ABS/ESP-warning lamp  flashing in the speedometer dial. In this case proceed as follows:

- While driving off, apply as little throttle as possible.
- While driving, ease up on the accelerator.
- Adapt your speed and driving style to the prevailing road conditions.

Failure to observe these guidelines could cause the vehicle to skid.

The ESP cannot prevent accidents resulting from excessive speed.

Warning!

The ESP cannot prevent the natural laws of physics from acting on the vehicle, nor can it increase the traction afforded. The ESP cannot prevent accidents, including those resulting from excessive speed in turns, or hydroplaning. Only a safe, attentive, and skillful driver can prevent accidents. The capabilities of an ESP equipped vehicle must never be exploited in a reckless or dangerous manner which could jeopardize the user's safety or the safety of others.



Because of ESP's automatic operation, the engine must be shut off when

- the parking brake is being tested on a brake test dynamometer.
- the vehicle is being towed with the front axle raised.

Active braking action through the ESP may otherwise seriously damage the rear axle brake system.

ESP will only function properly if you use wheels of the recommended tire size (▷ page 337).

Switching off ESP**Warning!**

ESP should not be switched off during normal driving other than in the circumstances described below. Disabling of the system will reduce vehicle stability in standard driving maneuvers.

To improve the vehicle's traction, turn off the ESP in driving situations where it would be advantageous to have drive wheels spin and thus cut into surfaces for better grip such as:

- starting out on slippery surfaces and in deep snow in conjunction with snow chains
- in sand or gravel



Distronic* cannot be activated when ESP has been deactivated.

Driving safety systems

The button is located in the lower part of the center console.



1 ESP on/off

- ▶ Press ESP button **1** until the ESP warning lamp  in the speedometer lights up.

ESP is deactivated.

If one or more wheels are spinning, the ESP warning lamp  in the speedometer flashes, regardless of the speed.

Traction control brakes a spinning wheel even when ESP is deactivated.

ESP always operates when you are braking, even when it has been deactivated.



Avoid spinning of a drive wheel for an extended period with the ESP switched off. This may cause serious damage to the drive train which is not covered by the Mercedes-Benz Limited Warranty.

Warning!



When the ESP warning lamp  is illuminated continuously, ESP is switched off.

Adapt your speed and driving to the prevailing road conditions and to the non-operating status of the ESP.

Switching on ESP

- ▶ Press button **1**.

The ESP warning lamp  in the speedometer goes out. You are now again in normal driving mode.

SBC brake system

The SBC brake system combines a hydraulic brake circuit with electronically controlled brake servo assistance. You have increased braking safety and improved braking comfort.

Warning!



Never ignore a brake malfunction indicated in the speedometer display, for example by the **BRAKE** (USA only) or  (Canada only) indicator lamp. Refer to the “Practical hints” section (▷ page 253). Also read and observe the messages in the instrument cluster display (▷ page 257).

Warning!

The SBC brake system requires electrical power to operate.

A malfunction in the vehicle's power supply or electrical system may impair brake system operation and switch it into its emergency operation mode. In such a case, the red brake warning lamp (▷ page 253) and the warning messages (▷ page 265) light up while driving. To brake, the driver must then apply significantly greater brake pedal pressure and depress the pedal much further to obtain the expected braking effect. If necessary, apply full pressure to the brake pedal. Brakes are only applied to the front wheels. Stopping distance is increased!

If there is a malfunction in the SBC brake system, we recommend that the vehicle be transported with all wheels off the ground using flatbed or appropriate wheel lift/dolly equipment.

A tow bar must be used if circumstances do not permit the use of the recommended towing methods and the vehicle requires towing with all four wheels on the ground. Towing the vehicle with all four wheels on the ground is only permissible for distances up to 30 miles (50 km) and at a speed not to exceed 30 mph (50 km/h). For more information, refer to "Towing the vehicle" (▷ page 325).

The SBC brake system is automatically activated when you:

- unlock the vehicle with the key or the KEYLESS-GO* card
- open the driver's or passenger door
- turn the key in the starter switch to position 1
- in vehicles with KEYLESS-GO*, press start/stop button on selector lever once
- depress the brake pedal
- release the parking brake



If the SBC brake system is activated as the brake pedal is first depressed, you may feel a reduced pedal resistance and longer pedal travel than normal. When releasing the pedal, you may also feel the brake pedal pulsate and you may hear a sound which is caused by the activation of the SBC pump. This is normal and not an indication of a malfunction. Pedal travel returns to normal when you release the brake pedal and the sound soon ceases.

Driving safety systems

Warning!



Have brake pad replacement and other work on the SBC brake system carried out by qualified technicians only. Contact your Mercedes-Benz Center for further information. The SBC brake system must be deactivated prior to working on the system. High pressure is intermittently built up in the system as part of its automatic self-test. In addition, the system is automatically activated when the vehicle is unlocked by remote control, when the driver or passenger door is opened, when the key in the starter switch is turned to position **1**, when the brake pedal is depressed or when the parking brake is released. Failure to deactivate the system prior to maintenance will cause brake pistons to extend and brake fluid to leak, which may result in injuries (contusions and acid burns). Extended brake pistons may also cause injury.

The SBC brake servo assistance switches off automatically when you

- remove the key from the starter switch (after approximately two minutes)
- lock the vehicle (after approximately 20 seconds)

Note on driving with SBC

- Following extended periods of only minor loads to your brake system, you should occasionally apply the brakes when traveling at high speeds. This improves the grip of the brake pads.

Warning!



Be very careful not to endanger other road users when you apply the brakes.

- After driving on wet or snow-covered roads, you should apply your brakes firmly before parking your vehicle. This produces heat which serves to dry the brake disks and help prevent corrosion.
- On long and steep grades, shift to a lower gear (gear range **1**, **2**, or **3**) to prevent the brakes from overheating and to reduce brake wear.
- After hard braking, it is advisable to drive on for some time so that the air stream will cool down the brakes faster.
- Only Mercedes-Benz approved components (e.g. brake pads) should be installed on your vehicle. Brake pads not approved by Mercedes-Benz may impair the safety of your vehicle.

Anti-theft systems

Immobilizer

The immobilizer prevents unauthorized persons from starting your vehicle.

Activating

- With the key: Removing the key from the starter switch activates the immobilizer.
- With KEYLESS-GO*: Turning off the engine by means of the start/stop button on the gear selector lever activates the immobilizer.

Deactivating

- With the key: Inserting the key in the starter switch deactivates the immobilizer.
- With KEYLESS-GO*: Starting the engine by means of the start/stop button on the gear selector lever deactivates the immobilizer.

Anti-theft alarm system

Once the alarm system has been armed, a visual and audible alarm is triggered when someone opens

- a door
- the trunk lid
- the hood
- a storage compartment in the rear
- the glove box
- the storage space under the armrest

The alarm system will also be triggered when

- someone attempts to raise the vehicle
- unlocking and opening the driver's door with the mechanical key



If the alarm stays on for more than 20 seconds, an emergency call is initiated automatically by the Tele Aid system (▷ page 202) provided Tele Aid service was subscribed to and properly activated.

Anti-theft systems

Arming the alarm system

The alarm system is armed after locking the vehicle with the remote control. The turn signal lamps blink three times to indicate that the alarm system is activated. The  indicator lamp in the central locking switch (▷ page 23) will blink after approximately 10 seconds when the alarm system is completely armed.



If the turn signal lamps do not blink three times, a door or the hood may not be closed properly.

Close the respective element and lock the vehicle again.

Disarming the alarm system

The alarm system is disarmed when you unlock your vehicle with the remote control. The turn signal lamps blink once to indicate that the alarm system is deactivated.





The alarm system will rearm automatically again after approximately 40 seconds if no door was opened.

Canceling the alarm

To cancel the alarm:

With the key

- ▶ Insert the key in the starter switch.
or
- ▶ Press the  or  button.
The alarm is canceled.

*With KEYLESS-GO**

- ▶ Grasp the outside door handle.
or
- ▶ Press the KEYLESS-GO start/stop button.
The alarm is canceled.

Tow-away alarm

Once the tow-away alarm is armed, a visual and audible alarm will be triggered when someone attempts to raise the vehicle.



The tow-away protection alarm is triggered, for example, if the vehicle is lifted on one side.

If the alarm stays on for more than 20 seconds, an emergency call is initiated automatically by the Tele Aid system (► page 202) provided Tele Aid service was subscribed to and properly activated.

Arming tow-away alarm

When you lock your vehicle, the tow-away alarm is automatically armed after about 30 seconds.

When you unlock your vehicle, the tow-away protection disarms automatically.

Disarming tow-away alarm

To prevent triggering the tow-away alarm feature, switch off the tow-away alarm before towing the vehicle, or when parking on a surface subject to movement, such as a ferry or auto train.

The switch is on the center console between the driver's seat and the passenger seat.



- 1 Tow-away alarm off switch
- 2 Indicator lamp

- Turn off the ignition and remove the key.



You cannot disarm the tow-away alarm if the ignition is turned on.

- Press switch **1**.

The indicator lamp **2** in the switch lights up briefly.

- Lock your vehicle with the key or (vehicles with KEYLESS-GO*) the lock button at each door handle.

The tow-away alarm remains disarmed until you lock your vehicle again.

Locking and unlocking

Seats

Memory function

Lighting

Instrument cluster

Control system

Automatic transmission

Good visibility

Automatic climate control

Power windows

Retractable hardtop

Driving systems

Useful features

Locking and unlocking

In the “Controls in detail” section you will find detailed information on how to operate the equipment installed on your vehicle. If you are already familiar with the basic functions of your vehicle, this section will be of particular interest to you.

To quickly familiarize yourself with the basic functions of the vehicle, refer to the “Getting started” section of this manual. The corresponding page numbers are given at the beginning of each segment.

Locking and unlocking

Keys

Your vehicle comes supplied with two SmartKeys with remote controls and a removable mechanical key. The locking tabs for the mechanical key portion of the two keys are a different color to help distinguish each key unit.



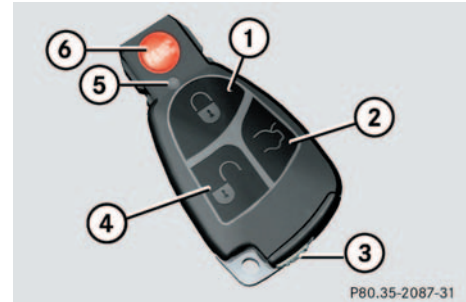

The remote control key provides an extended operating range. To prevent theft, however, it is advisable to only unlock the vehicle when you are in close proximity to it.

The key centrally locks and unlocks:

- the doors
- the trunk lid
- the glove box
- the storage space under the armrest
- the storage compartment in the rear
- the fuel filler flap



SmartKey with remote controls

- 1  Lock button
- 2  Unlock button for the trunk lid
- 3 Mechanical key locking tab
- 4  Unlock button
- 5 Battery check lamp
- 6  PANIC Panic button (> page 67)



You can also open and close the retractable hardtop using the key (> page 163).



To prevent possible malfunction, avoid exposing the key to high levels of electromagnetic radiation.

Factory setting

Global unlocking

- ▶ Press button

All turn signals blink once. The locking knobs in the doors move up.

The vehicle will lock again automatically within approximately 40 seconds of unlocking if neither door nor trunk is opened.

Global locking

- ▶ Press button

All turn signals blink three times. The locking knobs in the doors move down.

Individual setting

If you frequently travel alone, you may wish to reprogram the key so that pressing only unlocks the driver's door, interior lockable storage compartments and the fuel filler flap.

- ▶ Press and hold buttons and simultaneously for about six seconds until the battery check lamp **5** blinks twice.

The key will then function as follows:

Unlocking driver's door

- ▶ Press button once.

Global unlocking

- ▶ Press button twice.

Global locking

- ▶ Press button .

Restoring to factory setting

- ▶ Press and hold buttons and simultaneously for about six seconds until the battery check lamp **5** blinks twice.

Warning!



When leaving the vehicle, always remove the key from the starter switch, take the KEY-LESS-GO* card (if so equipped) with you and lock the vehicle. Do not leave children unattended in the vehicle, or with access to an unlocked vehicle. It is possible for children to open a locked door from the inside, which could result in an accident or serious injury.

Locking and unlocking





If you can no longer lock or unlock the vehicle with the key, then either the batteries in the electronics are discharged or the key is malfunctioning.

- Check the batteries in the key (▷ page 82) and replace them if necessary (▷ page 293).
or
- Use the mechanical key to unlock the doors (▷ page 290) and trunk (▷ page 291) as required. Lock the vehicle using the mechanical key (▷ page 292).

If the key is malfunctioning, contact an authorized Mercedes-Benz Center.

Checking the batteries

- ▶ Press button  or .

The battery check lamp **5** lights up briefly to indicate that the key batteries are in order.



If the battery check lamp **5** does not light up briefly during check then the key batteries are discharged.

- Change the batteries (▷ page 293).

You can obtain the required batteries at any authorized Mercedes-Benz Center.

Unlocking the trunk lid

You can unlock the trunk separately.

- ▶ Press and hold button  until trunk unlocks.



If the vehicle was previously centrally locked, the trunk lid will lock automatically when closed. The turn signals will flash three times to confirm locking.

Opening the trunk lid

The handle is located in the rear license plate recess.

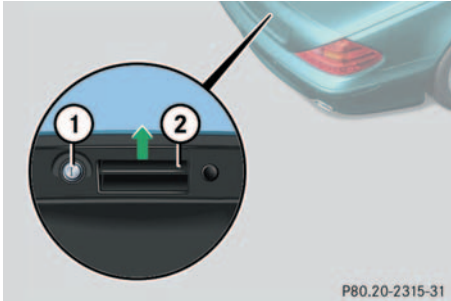

- 1 Trunk lid lock
- 2 Handle

- ▶ Lift the trunk lid.



The vehicle must be unlocked.

To facilitate trunk loading and unloading when the hardtop is retracted, you can raise the hardtop from its storage position in the trunk using the loading aid feature (> page 198). You may also unhook the luggage cover.

Remember to resecure the luggage cover after loading/unloading the trunk. Otherwise you will not be able to lower the retractable hardtop.

The trunk can also be opened from the inside in an emergency, see Trunk lid emergency release (> page 90).

Separately locking the trunk

- ▶ Close the trunk lid (> page 91).
- ▶ Pull the mechanical key out of the SmartKey (> page 290).
- ▶ Insert the mechanical key in the trunk lid lock.

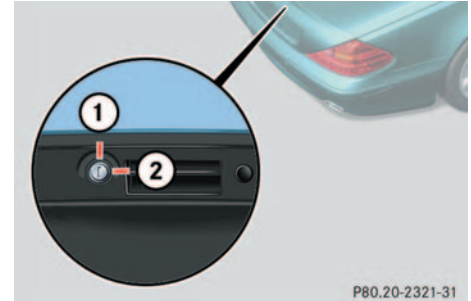

- 1 Unlocked
- 2 Locked

- ▶ Turn the key completely to the right to position 2.

The trunk remains locked even when the vehicle is centrally unlocked.



You can only cancel the separate trunk locking mode by means of the mechanical key.

Locking and unlocking

Separately unlocking the trunk

- ▶ Turn the key completely to the left to position 1.

You can now open the trunk.

Loss of SmartKey or mechanical key

If you lose a SmartKey or mechanical key, you should do the following:

- ▶ Have the SmartKey deactivated by an authorized Mercedes-Benz Center.
- ▶ Report the loss of the SmartKey or the mechanical key immediately to your car insurance company.
- ▶ If necessary have the mechanical lock replaced.

Your authorized Mercedes-Benz Center will be glad to supply you with a replacement.

KEYLESS-GO card*

Specially equipped vehicles come with two KEYLESS-GO cards. On these vehicles, the validity of the KEYLESS-GO card is checked every time you grasp a door handle.

If the card is valid, your vehicle unlocks

- the doors
- the trunk lid
- the glove box
- the storage space under the armrest
- the storage compartment in the rear
- the fuel filler flap

Warning!



When leaving the vehicle, always remove the key from the starter switch, take the KEYLESS-GO* card (if so equipped) with you and lock the vehicle. Do not leave children unattended in the vehicle, or with access to an unlocked vehicle. Unsupervised use of vehicle equipment may cause an accident and/or serious personal injury.



To prevent possible malfunction, avoid exposing the KEYLESS-GO* card to high levels of electromagnetic radiation.

Important notes on using KEYLESS-GO*

- Always carry the KEYLESS-GO card with you.
 - Never store the KEYLESS-GO card together with:
 - electronic items such as a cellular phone or another KEYLESS-GO card
 - metallic objects such as coins or metal foil
- Doing so could impair the function of the KEYLESS-GO system.
- Always take a SmartKey with you in case of a malfunction of the KEYLESS-GO system.
 - To lock or unlock the vehicle, the card must be located outside the vehicle within approximately 3 ft. (1 m) of a door or the trunk lid.
- In order to start the engine with the KEYLESS-GO card
 - the KEYLESS-GO card must be located in the vehicle
 - all the doors must be closed
 - If you have started the engine with the KEYLESS-GO start/stop button, you can only turn it off again with this button, even if you have put the key in the starter switch in the meantime.
 - This does not apply if, after starting, the selector lever is still in position **P**. The key will then have priority over the card and the vehicle's electrical system will operate according to the position of the key in the starter switch, even stopping the engine.
 - If the KEYLESS-GO card is positioned farther away from the vehicle (e.g. inside clothing or briefcase) and can no longer be recognized by the system, the vehicle cannot be locked or the engine started via the KEYLESS-GO system.

- If the KEYLESS-GO card is removed from the vehicle while the ignition is switched on (e.g. if passenger exits the vehicle with the card), the message *Chip card not recognized! will appear in the multifunction display.*

Find the card or change its present location immediately (e.g. place it on the front passenger seat or insert it in shirt pocket).

- Remember that the engine can be started by anyone with a KEYLESS-GO card that is left inside the vehicle. If you leave the card behind when exiting and locking the vehicle, the message *Chip card still in vehicle! will appear in the multifunction display.*

Locking and unlocking

Factory setting

Global unlocking

- ▶ Grasp the door handle.

The vehicle will lock again automatically within approximately 40 seconds of unlocking if neither door nor trunk is opened.



The vehicle could inadvertently unlock if the KEYLESS-GO card is within 3 ft. (1 m) of the vehicle and

- the door handle is splashed with water, or
- you attempt to clean the door handle.

Global locking

- ▶ Press lock button at door handle (> page 50) or trunk (> page 88).

Individual setting

If you frequently travel alone, you may wish to reprogram the KEYLESS-GO card so that grasping a door handle only unlocks the driver's door, interior lockable storage compartments and the fuel filler flap.



- 1 Programming button
- 2 "Driver's door" symbol
- 3 "Global unlock" symbol

- ▶ Press and hold the programming button **1** until the "Driver's door" symbol **2** lights up.

The KEYLESS-GO card will then function as follows:

Unlocking the driver's door

- ▶ Grasp the driver's handle.

Global unlocking

- ▶ Grasp the door handle on the passenger side.

Global locking

- ▶ Press lock button at door handle or trunk.

Restoring to factory setting

- ▶ Press and hold the programming button **1** until the “Global unlock” symbol **3** lights up.



If you cannot lock or unlock the vehicle with the KEYLESS-GO card, then either the batteries of the KEYLESS-GO card are discharged or the KEYLESS-GO card is malfunctioning.

- Check the batteries of the KEYLESS-GO card (▷ page 87) and replace them if necessary (▷ page 294).
- or
- Use the key to unlock the doors (▷ page 81) and trunk (▷ page 82) as required. Lock the vehicle using the key (▷ page 81).

If your KEYLESS-GO card is malfunctioning, contact your authorized Mercedes-Benz Center.

Checking the batteries

- ▶ Briefly press the programming button **1**.

The KEYLESS-GO card batteries are in order if the indicator lamp for either the “Driver’s door” **2** or “Global unlock” **3** comes on red or green.



If the symbols **2** or **3** do not light up during the check, then the batteries of the KEYLESS-GO card are discharged.

- ▶ Change the batteries (▷ page 294).

You can obtain the batteries at any authorized Mercedes-Benz Center.

Checking vehicle lock status

If you cannot remember whether you have locked the vehicle, you can check the lock status using the KEYLESS-GO card.

- ▶ Briefly press the programming button **1**.

The indicator lamp for the “Driver’s door” **2** or “Global unlock” **3** lights up in red or green.

Vehicle lock status:

Red Vehicle is locked

Green Vehicle is unlocked

Locking and unlocking

Unlocking the trunk lid

The handle is located in the rear license plate recess.

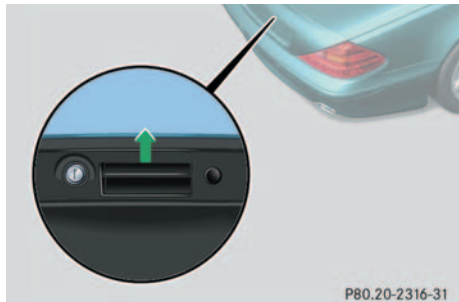

- ▶ Pull on the handle and lift up the trunk lid.

The vehicle unlocks the trunk lid only.



If the vehicle was previously centrally locked, the trunk lid will lock automatically when closed. The turn signals will flash three times to confirm locking.

To prevent a possible inadvertent lock-out, the trunk lid will open automatically if a KEYLESS-GO card is recognized inside the trunk.

Locking the vehicle

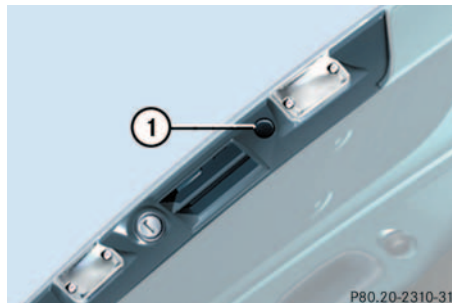

1 Trunk lock button

- ▶ Press the lock button at door (▷ page 49) or trunk.

Closing the side windows

- ▶ Press and hold lock button at door (▷ page 49) until the side windows are closed.

Warning!



When closing the windows, be sure that there is no danger of anyone being harmed by the closing procedure.

If potential danger exists, proceed as follows:

- Release the lock button.
- Pull on the door handle and hold firmly. The side windows will open for as long as the door handle is held but the door is not opened.

Loss of KEYLESS-GO-card

If you lose your KEYLESS-GO card, you should do the following:

- ▶ Have the KEYLESS-GO card deactivated by an authorized Mercedes-Benz Center.
- ▶ Report the loss immediately to your car insurance company.
- ▶ Have the mechanical lock replaced if necessary.

Your authorized Mercedes-Benz Center will be glad to supply you with a replacement.

Opening the doors from the inside

You can open a locked door from the inside. Open door only when conditions are safe to do so.

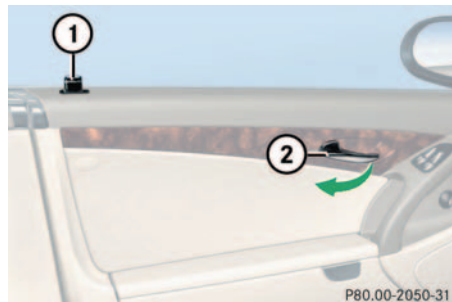

- 1 Locking knob
- 2 Inside door handle

- ▶ Pull on the door handle **2**.

If door was locked, the locking knob **1** will move up.

i

If you open a door, the side windows on that side of the vehicle will lower slightly. The windows close again when you close the door.

Opening the trunk from the inside

You can open the trunk from the inside if the vehicle is stationary and the retractable hardtop is fully opened or closed. The switch is located on the driver's door.

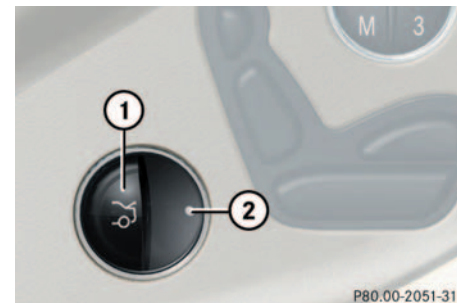

- 1 Remote trunk lid release switch
- 2 Indicator lamp

Locking and unlocking

- ▶ Pull remote trunk lid release switch **1**.

The trunk unlocks. The indicator lamp **2** comes on. It remains lit until you close the trunk again.



To facilitate trunk loading and unloading when the hardtop is retracted, you can raise the hardtop from its storage position in the trunk using the loading aid feature (▷ page 198). You may also unhook the luggage cover.

Remember to resecure the luggage cover after loading/unloading the trunk. Otherwise you will not be able to lower the retractable hardtop.

Trunk lid emergency release

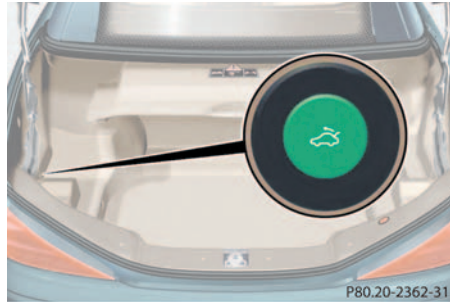

The emergency release button is located on the left side of the trunk.

Illumination of the emergency release button:

- The button will blink for 30 minutes after opening the trunk.
- The button will blink for 60 minutes after closing the trunk.
- ▶ Briefly press the emergency release button.



The trunk unlocks and the trunk lid opens.



The emergency release button does not open the trunk lid if the vehicle battery is discharged or disconnected.



If the emergency release button is pressed and the vehicle was centrally locked, the exterior lamps will flash and the alarm will sound as the trunk lid opens.

To cancel the alarm, insert the key in the starter switch or press button  or  on the key.

Closing the trunk lid

Warning!



To prevent possible personal injury, always keep hands and fingers away from the trunk opening when closing the trunk lid. Be especially careful when small children are around.

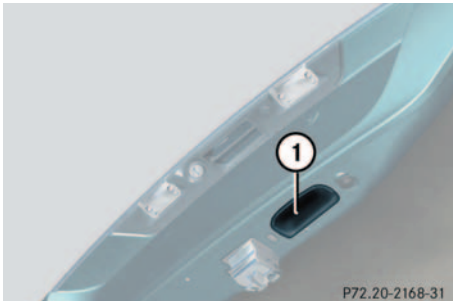

1 Handle

- Lower trunk lid by pulling firmly on handle 1.



To prevent an inadvertent lockout, do not place the key in the trunk.

Vehicles with KEYLESS-GO*: To prevent a possible inadvertent lockout, the trunk lid will open automatically if a KEYLESS-GO card is recognized inside the trunk.

When the hardtop is retracted, it must be completely lowered in the trunk before the trunk lid can be closed (► page 199).

Warning!



Only drive with the trunk closed as, among other dangers such as visibility blockage, exhaust fumes may enter the vehicle interior.

Automatic central locking

The doors and the trunk lid automatically lock when the vehicle is set into motion.

You can open a locked door from the inside. Open door only when conditions are safe to do so.



The doors unlock automatically after an accident if the force of the impact exceeds a preset threshold.

The vehicle automatically locks when the ignition is switched on and the wheels are turning at vehicle speeds of approximately 9 mph (15 km/h) or more. You could therefore lock yourself out when the vehicle

- is pushed
- is on a test stand

You can deactivate the automatic locking using the control system (► page 128).

Locking and unlocking

Locking and unlocking from the inside

You can lock or unlock the vehicle from inside using the central locking switches. This can be useful, for example, if you want to unlock the passenger door from the inside or want to lock the vehicle before starting to drive.



You can open a locked door from inside at any time. Open door only when conditions are safe to do so.

If you have locked the vehicle with the key or the KEYLESS-GO* card, the central locking switches do not work.

The switches are located above and between the center air vents of the air conditioning.

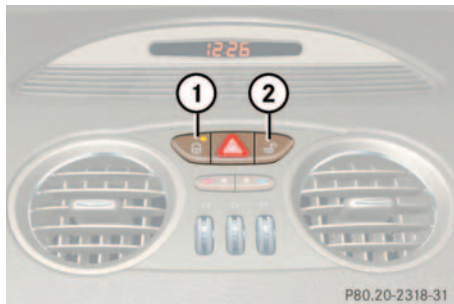

Central locking switches

- 1 Locking
- 2 Unlocking

Locking

- ▶ Press central locking switch **1**.

If all the doors are closed, the vehicle locks.

Unlocking

- ▶ Press central locking switch **2**.

The vehicle unlocks.



If the vehicle was previously centrally locked using the SmartKey or the KEYLESS-GO* card, it will not unlock using the central locking switch.

Warning!



When leaving the vehicle, always remove the key from the starter switch, take the KEYLESS-GO* card (if so equipped) with you and lock the vehicle. Do not leave children unattended in the vehicle, or with access to an unlocked vehicle. Unsupervised use of vehicle equipment may cause an accident and/or serious personal injury.

Seats

Information on seat adjustment can be found in the “Getting started” section (▷ page 32).

Lumbar support

You can adjust the contour of the seat’s lumbar support to best support your spine.

The thumbwheel is located on the lower side of the seat.

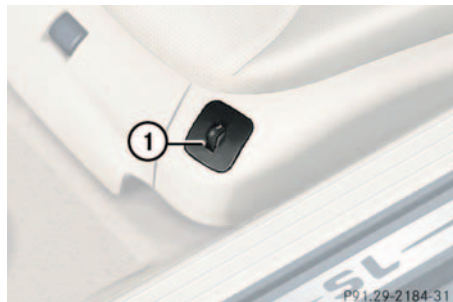

1 Thumb wheel

- ▶ Make sure the ignition is switched on.
All the lamps in the instrument cluster should light up.
- ▶ Set the lumbar support between 0 and 5.

Multicontour backrest*

You can adjust the backrest contour of the seat to support your spine.

The switches are located on the lower side of the seat.

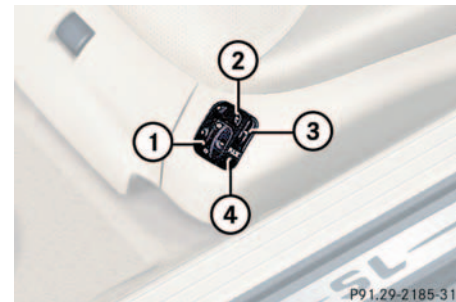



1 Lumbar region support
2 Shoulder region support
3 Backrest side cushions
4 Massage function (PULSE)



- ▶ Make sure the ignition is switched on.
All the lamps in the instrument cluster should light up.

Seats

Lumbar region support



- ▶ Press  or  on rocker switch **1**.

This selects the air cushion you wish to adjust.

- ▶ Press  or  on rocker switch **1**.

The air cushion inflates or deflates.

Shoulder region support

- ▶ Press  or  on switch **2**.
The air cushion inflates or deflates.

Backrest side cushions

- ▶ Press switch **3** to the right or left.
The lateral support increases or decreases.

Massage function (PULSE)

You can reduce muscle tension during long trips by periodically using the massage function.

- ▶ Press button **4**.

The indicator lamp on button **4** lights up. The air cushions in the lumbar region inflate and deflate rhythmically.



The massage function switches off automatically after approximately eight minutes. The indicator lamp extinguishes.

Moving the seats forward and backward

You can move the seats forward and back to facilitate loading and unloading.

Warning!



When moving the seats, be sure that no one can be caught by them. Never place hands under seat or near any moving parts during a seat adjustment procedure. To stop the seat from moving when potential danger exists:

- press the switch again
- move the seat adjustment switch on the door (▷ page 32)



To avoid damage to seats, make sure that there is nothing in the cup holder and that no bags are in the footwells or behind the seats during seat movement.

The switch is located on the top side of the seat.

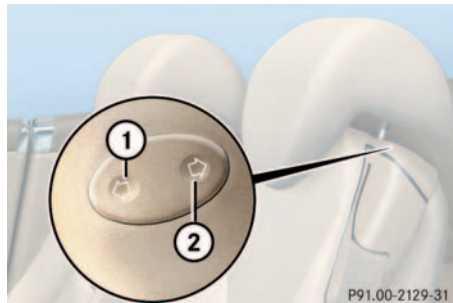

- 1 Seat forward
- 2 Seat backward

Moving the seat forward

- ▶ Press switch at 1.

Moving the seat backward

- ▶ Press switch at 2.

Seats

Seat ventilation*

The switch is located on the door. The blue indicator lamps on the switch show the ventilation level selected:

Level 3	Three indicator lamps on
Level 2	Two indicator lamps on
Level 1	One indicator lamp on
Ventilation off	No indicator lamp on



1 Seat ventilation switch

- ▶ Make sure the ignition is switched on.

All the lamps in the instrument cluster light up.

Switching on the seat ventilation

- ▶ Press switch 1.

Three blue indicator lamps on the switch light up.

Switching off the seat ventilation

- ▶ Press switch 1 repeatedly until all indicator lamps go out.



In normal operation the seat ventilation will switch off automatically after about 30 minutes.



If one or all of the lamps blink on the seat ventilation* switch, there is insufficient voltage since too many electrical consumers are switched on. The seat ventilation* switches off automatically.

The seat ventilation* will switch back on again automatically as soon as sufficient voltage is available.

Seat heater

Vehicles without seat ventilation*

The switch is located on the door.



1 Normal heating

2 Rapid heating

- ▶ Make sure the ignition is switched on.
All the lamps in the instrument cluster light up.

Switching on the seat heater

- ▶ Press lower switch position **1**.
A red indicator lamp on the switch lights up.

Switching off the seat heater

- ▶ Press lower switch position **1** again.



The seat heater will be automatically switched off after approximately 30 minutes.

Rapid seat heating mode

- ▶ Press upper switch position **2**.
Both red indicator lamps on the switch light up.



The system switches over to normal heating mode after approximately five minutes. Only the right-hand indicator lamp remains lit.

Switching off rapid seat heating mode

- ▶ Press upper switch position **2** again.



If one or both of the lamps on the seat heater switch are blinking, there is insufficient voltage available since too many electrical consumers are turned on. The seat heater switches off automatically.

The seat heater will switch back on again automatically as soon as sufficient voltage is available.

Seats

Vehicles with seat ventilation*

The switch is located on the door. The red indicator lamps on the switch show the heater level selected:

Seat heater off	No indicator lamp on
Level 1	One indicator lamp on
Level 2	Two indicator lamps on



1 Seat heater switch

- ▶ Make sure the ignition is switched on.
All the lamps in the instrument cluster light up.

Switching on the seat heater

- ▶ Press upper switch position **1** twice.
A red indicator lamp on the switch lights up.

Switching off the seat heater

- ▶ Press upper switch position **1** again.



The seat heater will be automatically switched off after approximately 30 minutes.

Rapid seat heating

- ▶ Press upper switch position **1** once.
Both indicator lamps on the switch light up.



The system switches over to normal heating mode after approximately five minutes. Only the right-hand indicator lamp remains lit.

Switching off rapid seat heating mode

- ▶ Press upper switch position **1** twice.



If one or both of the lamps on the seat heater switch are blinking, there is insufficient voltage available since too many electrical consumers are turned on. The seat heater switches off automatically.

The seat heater will switch back on again automatically as soon as sufficient voltage is available.

Memory function



Prior to operating the vehicle, the driver should check and adjust the seat height, seat position fore and aft, and seat backrest angle if necessary, to ensure adequate control, reach and comfort. The head restraint should also be adjusted for proper height. Also see air-bag section (▷ page 53) for proper seat positioning.

In addition, adjust the steering wheel to ensure adequate control, reach, operation and comfort. Both the inside and outside rear view mirrors should be adjusted for adequate rear vision.

Fasten seat belts. Infants and small children should be seated in a properly secured restraint system that complies with U.S. Federal Motor Vehicle Safety Standard 213 and Canadian Motor Vehicle Safety Standard 213.

With the memory switch you can store up to three different settings per key and KEY-LESS-GO* card.

The following settings are saved for each stored position:

- Driver's seat and backrest position
- Steering wheel position
- Inside rear view mirror position
- Driver's side exterior rear view mirror position
- Passenger side exterior rear view mirror position

These key dependent memory settings can be deactivated if desired (▷ page 130).

Warning!



Do not activate the memory function while driving. Activating the memory function while driving could cause the driver to lose control of the vehicle.

The memory switch is located on the door.



M Memory button

1, 2, 3 Stored positions

- ▶ Be sure that the ignition is switched on or one door is open.

All the lamps in the instrument cluster light up when the ignition is switched on.

Memory function

Storing positions into memory

- ▶ Adjust the seats, steering wheel and rear view mirrors to the desired position (▷ page 32).
- ▶ Press memory button **M**.
- ▶ Release memory button and press a stored position button **1**, **2**, or **3** within three seconds.

All the settings are stored at the selected position.

Recalling positions from memory

- ▶ On memory switch, press and hold stored position button **1**, **2** or **3** until the seat, steering wheel and rear view mirrors have fully moved to the stored positions.



Releasing the button immediately stops movement to the stored positions.

Storing parking position

For easier parking you can adjust the passenger exterior rear view mirror so that you can see the right rear wheel as soon as you engage reverse gear **R**.



The mirror parking position feature (▷ page 131) must be activated and the passenger side exterior rear view mirror (▷ page 35) must be selected at the time in order for the system to recall the stored mirror position when reverse gear **R** is engaged.

The exterior rear view mirror returns to its stored driving position:

- 10 seconds after you put the gear selector lever in position **D**
- immediately once you exceed a speed of approx. 6 mph (10 km/h)
- immediately when you press the button for driver's side mirror

You can store a parking position for the passenger exterior rear view mirror for each key and each KEYLESS-GO* card using the memory switch.

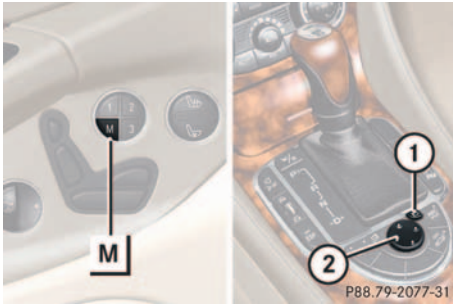

- 1 Passenger side exterior rear view mirror
- 2 Adjustment button

- ▶ Stop the vehicle.
- ▶ Switch ignition on (if not already on).
- ▶ Press button **1** in center console.

The passenger side exterior rear view mirror is selected.

- ▶ Adjust the exterior rear view mirror with button **2** so that you see the rear wheel and the road curb.
- ▶ Press memory button **M** on the door.
- ▶ Within three seconds press adjustment button **2** in the center console.

The parking position is stored if the mirror does not move.



If the mirror does move, repeat the above steps. After the setting is stored you can move the mirror again.

Lighting

Lighting

For notes on how to switch on the headlamps and use the turn signals, see the “Getting started” section (▷ page 43).

Exterior lamp switch

The exterior lamp switch is located on the dashboard to the left of the steering wheel.



- 0** Off
- AUTO** Automatic headlamp mode
- P** Parking lamps, license plate lamps and instrument panel lamps
- L** Low beam or high beam headlamps
- P ←** Standing lamps, right
- P** Standing lamps, left



If you remove the key and open the driver's door while the parking lamps or low beam headlamps are switched on, then

- a warning sounds
-  appears in the speedometer display field
- the message **Turn lamps off** appears in the tachometer display field



With the daytime running lamp mode activated and the engine running, the low beam headlamps cannot be switched off manually.

To activate the daytime running lamp mode, see “Setting daytime running lamp mode (USA only)” (▷ page 124).

Manual headlamp mode

The low beam headlamps and parking lamps can be switched on or off with the exterior lamp switch.

Automatic headlamp mode

The parking lamps, low beam headlamps and license plate lamps switch on and off automatically depending on the brightness of the ambient light.

Warning!



In automatic headlamp mode, the headlamps will not be automatically switched on under foggy conditions. To minimize risk to you and to others, activate headlamps by turning exterior lamp switch to .

The driver is responsible for the operation of the vehicle's lights at all times. The automatic headlamp feature is only an aid to the driver. Switch on the vehicle lights manually when driving or when traffic conditions require you to do so.

- ▶ Turn the exterior lamp switch to **AUTO**.



With the daytime running lamp mode activated, the low beam headlamps will not be switched off automatically.



Front fog lamps and rear fog lamp can not be switched on manually with exterior lamp switch in position **AUTO**. To activate the fog lamps turn exterior lamp switch to position .



If you drive in countries where vehicles drive on the other side of the road than the country where the vehicle is registered, you must have the headlamps modified for symmetrical low beams. Relevant information can be obtained at your authorized Mercedes-Benz Center.

Daytime running lamp mode

- ▶ Turn exterior lamp switch to position **0** or **AUTO**.

When the engine is running, the low beam headlamps are automatically switched on. In low ambient light conditions the parking lamps will also switch on.

Canada only:

When you shift from a driving position to position **N** or **P**, the low beam switches off (3 minutes delay).

For nighttime driving you should turn the exterior lamp switch to position  to permit activation of the high beam headlamps.

Lighting

USA only:

The high beam headlamps can also be activated when driving with the daytime running lamp mode activated and the exterior lamp switch in position **0**.

To activate the daytime running lamp mode, see "Setting daytime running lamp mode (USA only)" (▷ page 124).



See notes on the exterior lamp switch (▷ page 102).

Locator lighting and night security illumination

Locator lighting and night security illumination are described in the control system section, see "Setting locator lighting" (▷ page 125) and "Exterior lamps delayed switch-off" (▷ page 125).

Switching on front fog lamps

- ▶ Make sure that the low beam headlamps are switched on.
- ▶ Pull out exterior lamp switch to first stop.

The green indicator lamp **0** in the lamp switch lights up.

Switching on rear fog lamp

- ▶ Make sure that the low beam headlamps are switched on.
- ▶ Pull out exterior lamp switch to second stop.

The yellow indicator lamp **0** in the lamp switch lights up.

Combination switch

The combination switch is located on the left side of the steering column.

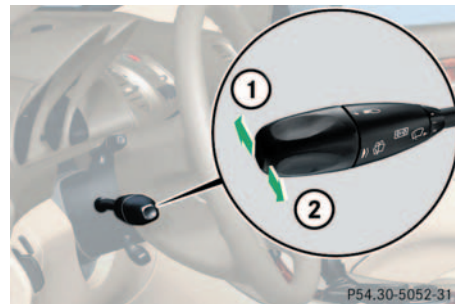

- 1 High beam
- 2 High beam flasher

Switching on high beams

- ▶ Turn the exterior lamp switch to  or to **AUTO** (▷ page 102).
- ▶ Push the combination switch in direction **1**.

The high beam symbol in the tachometer will light up.

High beam flasher

- ▶ Pull the combination switch briefly in direction **2**.

Hazard warning flasher

The hazard warning flasher can be activated with the ignition switched on or off. It is activated automatically when an airbag is deployed.

The switch is located above and between the center air vents.



1 Hazard warning flasher switch

Switching on the hazard warning flasher

- ▶ Press the hazard warning flasher switch.

All the turn signals will blink.



With the hazard warning flasher activated and the combination switch set for either left or right turn, only the respective left or right turn signals will operate.

Switching off the hazard warning flasher

- ▶ Press hazard warning flasher switch again.

Lighting

Interior lighting



- 1 Left reading lamp
- 2 Right reading lamp
- 3 Interior lighting on/off
- 4 Slide switch for interior lighting control

Automatic control

Activating

- ▶ Slide switch **4** to the left.

Interior lamps are switched on in darkness when you

- unlock the vehicle
- open a door
- remove the key from the starter switch
- open the trunk

In addition, the entry/exit lamps in the door trays will come on when you open a door.

The interior lamps are switched off following an adjustable time delay (▷ page 127).



If the door remains open, the interior lamps switch off automatically after approximately five minutes.

Deactivating

- ▶ Slide switch **4** to the right.

The interior lighting and the entry/exit lamps remain switched off in darkness, even when you

- unlock the vehicle
- open a door
- remove the key from the starter switch
- open the trunk

Manual control

Switching lamps on

- ▶ Press switch **3**.

The interior lighting switches on.

Switching lamps off

- ▶ Press switch **3** again.

The interior lighting switches off.



The setting selected for the interior lighting is used for the trunk lighting as well.

If you leave the trunk lid open for an extended period of time, the trunk lighting will switch off automatically after approximately ten minutes.

Courtesy lighting

For better orientation in the dark, courtesy lamps will illuminate the interior of your vehicle as follows:

With parking lamps switched on:

- the door handles
- the driver and passenger footwells

With key in starter switch position **1**:

- the door handles
- the center console



If you turn the key in the starter switch to position **0** and switch off the exterior headlamps, the door handle lamps will remain lit for approximately five minutes.

Instrument cluster

Instrument cluster

A full view illustration of the instrument cluster can be found in the “At a glance” section of this manual (▷ page 20).

The instrument cluster is activated when you:

- open a door
- turn on the ignition
- press the reset knob (▷ page 20)
- switch on the exterior lamps

Only opening a door will activate the instrument cluster for approximately 30 seconds.

You can change the instrument cluster settings in the Instrument cluster submenu of the control system (▷ page 122).

Instrument cluster illumination

Use the reset knob to adjust the illumination brightness for the instrument cluster and the switches on the center console.



The instrument cluster illumination is dimmed or brightened to suit ambient light conditions.

To brighten illumination

- ▶ Turn the reset knob in the instrument cluster (▷ page 20) clockwise.

The instrument cluster illumination will brighten.

To dim illumination

- ▶ Turn the reset knob in the instrument cluster (▷ page 20) counterclockwise.

The instrument cluster illumination will dim.



Coolant temperature gauge

Under normal driving conditions, the coolant temperature may rise to 248°F (120°C). The coolant temperature may rise to 266°F (130°C) at high outside temperatures or when driving in hilly terrain.

The engine should not be operated with the coolant temperature above 266°F (130°C). Doing so may cause serious engine damage which is not covered by the Mercedes-Benz Limited Warranty.

Trip odometer

- ▶ Make sure that you are viewing the trip odometer display (▷ page 110).

Press the  or  button on the multifunction steering wheel repeatedly until the trip odometer appears if it is not displayed.

- ▶ Press and hold reset knob **4** (▷ page 20) until the trip odometer is reset.

Tachometer

The red marking on the tachometer denotes excessive engine speed.



Avoid driving at excessive engine speeds, as it may result in serious engine damage that is not covered by the Mercedes-Benz Limited Warranty.

To help protect the engine, the fuel supply is interrupted if the engine is operated within the red marking.

SL 55 AMG

On the SL 55 AMG, there is no red marking denoting excessive engine speed.

To help protect the engine, the fuel supply is interrupted if the engine is operated at an excessive speed.

Outside temperature indicator

Warning!



The outside temperature indicator is not designed to serve as an Ice-Warning Device and is therefore unsuitable for that purpose.

Indicated temperatures just above the freezing point do not guarantee that the road surface is free of ice. The road may still be icy, especially in wooded areas or on bridges.

When moving the vehicle into colder ambient temperatures (e.g. when leaving your garage), you will notice a delay before the lower temperature is displayed.

A delay also occurs when ambient temperatures rise. This prevents inaccurate temperature indications caused by heat radiated from the engine during idling or slow driving.

Control system

Control system

The control system is activated as soon as the key in the starter switch is turned to position **1**. The control system enables you to

- call up information about your vehicle
- change vehicle settings

For example, you can use the control system to find out when your vehicle is next due for service, to set the language for messages in the instrument cluster display, and much more.

Warning!



A driver's attention to the road and traffic conditions must always be his/her primary focus when driving.

For your safety and the safety of others, selecting features through the multifunction steering wheel should only be done by the driver when traffic and road conditions permit it to be done safely.

Bear in mind that at a speed of just 30 mph (approximately 50 km/h), your vehicle is covering a distance of 44 feet (approximately 13.5 m) every second.

The control system relays information to the multifunction display.

Multifunction display

The multifunction display consists of the display fields in the speedometer and the tachometer. In its default state, the left display field shows the trip and main odometer, while the present outside temperature appears in the right display field. This default setting is referred to as the standard display.

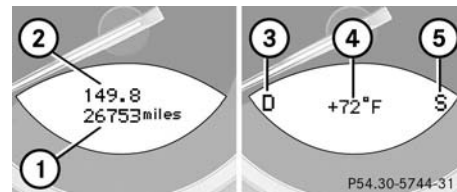

- 1 Main odometer
- 2 Trip odometer
- 3 Current gear selector lever position
- 4 Outside temperature
- 5 Automatic transmission program mode

Multifunction steering wheel

The displays in the multifunction display and the settings in the control system are controlled by the buttons on the multifunction steering wheel (▷ page 20).

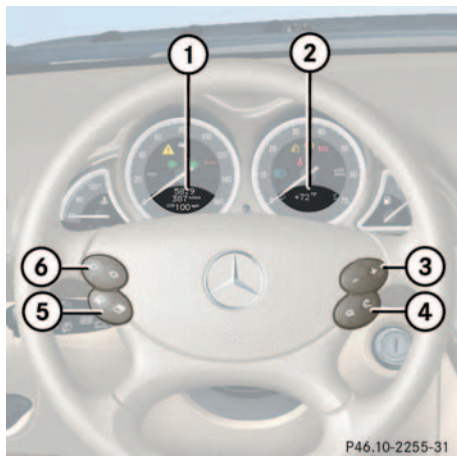

1 Left multifunction display in the speedometer

2 Right multifunction display in the tachometer

Operating the control system

3 Selecting the submenu or setting the volume

 down / to decrease

 up / to increase

4 Telephone*

 to take a call

 to end a call

5 Menu systems

 for next menu

 for previous menu

6 Moving within a menu

 for next display





 for previous display

Pressing any of the buttons on the multifunction steering wheel will alter what is shown in the multifunction display.

The information available in the multifunction display is arranged in menus, each containing a number of functions or sub-menus.

The individual functions are then found within the relevant menu (radio or CD operations under AUDIO, for example). These functions serve to call up relevant information or to customize the settings for your vehicle.

It is helpful to think of the menus, and the functions within each menu, as being arranged in a circular pattern.

- If you press button  or  repeatedly, you will pass through each menu one after the other.
- If you press button  or  repeatedly, you will pass through each function display, one after the other, in the current menu.

Control system

In the *Settings* menu, instead of functions you will find a number of submenus for calling up and changing settings. For instructions on using these submenus, see the “Settings menu” section (▷ page 119).

The number of menus available in the system depends on which optional equipment is installed in your vehicle.

The menus are described on the following pages.

Menus

This is what you will see when you scroll through the menus.

The table below provides an overview of the individual menus.

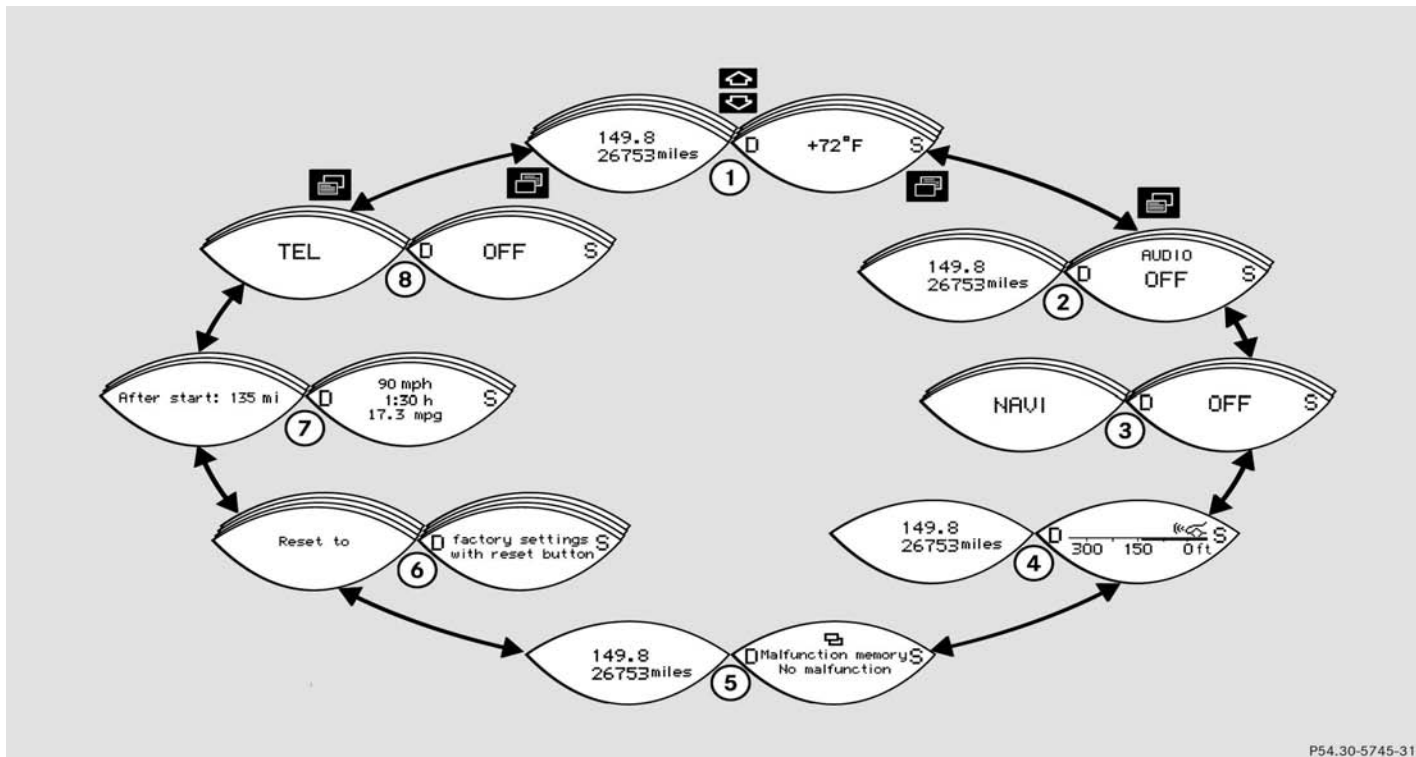

P54.30-5745-31

Control system

Menus, submenus and functions



	Menu 1 Standard display	Menu 2 AUDIO	Menu 3 NAVI	Menu 4 Distronic*	Menu 5 Malfunction memory	Menu 6 Settings	Menu 7 Trip computer	Menu 8 Telephone
Commands/submenus	Digital speedometer	Select radio station	Activate route guidance	Call up settings	Call up malfunction messages	Reset to factory settings	Fuel consumption statistics after start	Load phone book
	Call up FSS	Operate CD player				Instrument cluster submenu	Fuel consumption statistics since the last reset	
	Check tire pressure*					Lighting submenu	Call up range	
	Check engine oil level					Vehicle submenu Convenience submenu		



The headings used in the menu table are designed to facilitate navigation within the system and are not necessarily identical to those shown in the control system displays.

The first function displayed in each menu will automatically show you which part of the system you are in.

Standard display menu

You can select the functions in the standard display menu with button  or .

The following functions are available:

Function	Page
Call up digital speedometer	115
Call up FSS	242
Check tire pressure*	236
Check engine oil level	228

Display digital speedometer

- ▶ Press button  once.

The current vehicle speed is shown in the right display field.

AUDIO menu

The functions in the **AUDIO** menu operate the audio equipment which you currently have turned on.



If no audio equipment is currently turned on the message **AUDIO off** is shown in the right display.

The following functions are available:

Function	Page
Select radio station	116
Operate CD player	116

Control system

Select radio station

- ▶ Turn on the radio. Refer to the separate operating instructions.
- ▶ Press button  or  repeatedly until you see the currently tuned station in the right display.

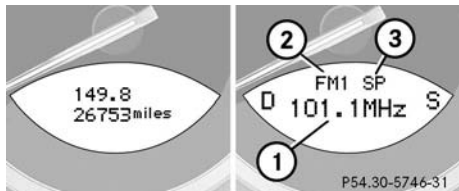

- 1 Station frequency
- 2 Waveband setting
- 3 Setting for station selection using memory

- ▶ Press button  or  repeatedly until the desired station is found.

The type of search depends on the setting for the station tuning (▶ page 128):



- Memory: the next stored station is selected (SP)
- Station search



You can only store new stations using the designated feature on the radio. Refer to the separate operating instructions.

You can also operate the radio in the usual manner.

Operate the CD player

- ▶ Turn on the radio and select the CD player. Refer to the separate operating instructions.
- ▶ Press button  or  repeatedly until the settings for the CD currently being played are shown in the right display field.

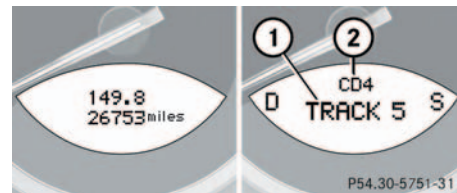



- 1 Current track
- 2 Current CD (for CD changer)

- ▶ Press button  or  repeatedly until the desired track is selected.

NAVI menu

The NAVI menu contains the functions needed to operate your navigation system.

- ▶ Press button  or  repeatedly until you see the message NAVI in the left display.

The message shown in the right display field depends on the status of the navigation system:

- If the navigation system is off, the message NAVI OFF is shown in the display.
- If the navigation system is on, the message NAVI READY is shown in the display.



Please refer to the COMAND manual for instructions on how to activate the route guidance system.

Distronic* menu

Use the Distronic menu to display the current settings for your Distronic system.

What information is shown in the left display field depends on whether the Distronic system is active or inactive.

Please refer to the “Driving systems” section of this manual (▶ page 171) for instructions on how to activate Distronic.

- ▶ Press button  or  repeatedly until you see one of the following two pictures in the display.

Distronic deactivated

When Distronic is deactivated you will see the standard display in the left display field.

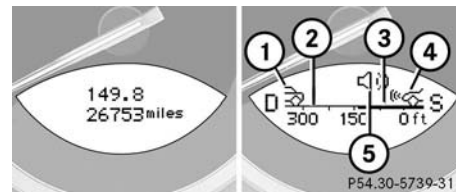

- 1 Vehicle ahead, if detected
- 2 Actual distance to vehicle ahead
- 3 Should-be distance to vehicle ahead
- 4 Your vehicle
- 5 Symbol for activated distance warning function

Control system

Distronic activated

When DISTRONIC is activated the DTR symbol and the set speed are seen in the left display.

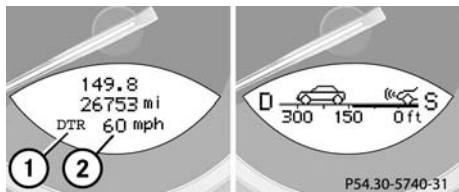

- 1 Symbol for activated DISTRONIC
- 2 Set speed



Malfunction memory menu

Use the malfunction memory menu to scan malfunction and warning messages that may be stored in the system. What information is shown in the display fields depends on whether malfunctions have actually occurred.

Warning!



Malfunction and warning messages are only indicated for certain systems and are intentionally not very detailed. The malfunction and warning messages are simply a reminder with respect to the operation of certain systems and do not replace the owner's and/or driver's responsibility to maintain the vehicle's operating safety by having all required maintenance and safety checks performed on the vehicle and by bringing the vehicle to an authorized Mercedes-Benz Center to address the malfunction and warning messages (▷ page 257).

- ▶ Press button  or  repeatedly until you see the message Malfunction memory in the right display.

No malfunction messages



If no malfunctions have occurred, the message in the right display is: Malfunction memory, no malfunctions.

Malfunctions have occurred

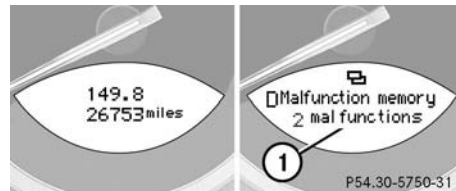
If malfunctions have occurred, you will see the number of malfunctions in the right display:



- 1 Number of malfunctions

- ▶ Press button  or .

The stored messages will now be displayed in order. See the “Practical hints” section for malfunction and warning messages (▷ page 257).



Should any malfunctions occur while driving, the number of malfunctions will reappear in the right display field when the key in the starter switch is turned to position **0** or removed from the starter switch.



The message memory will be cleared when you turn the key in the starter switch to position **1** or **2**. You will then only see Priority 1 malfunctions (▷ page 257).

Settings menu

In the Settings menu there are two functions:

- The function **Reset to factory settings using reset button**, with which you can reset all the settings to those set at the factory.
 - A collection of submenus with which you can make individual settings for your vehicle.
- ▶ Press button  or  repeatedly until the **Settings...** menu is seen in the left display.

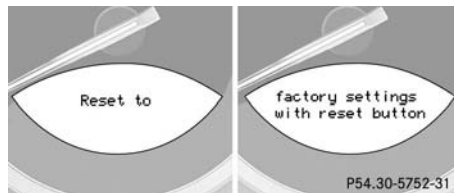

The following settings and submenus are available:

Function	Page
Resetting all settings	120
Submenus in the Settings menu	120
Resetting the functions of a submenu	120
Instrument cluster submenu	122
Lighting submenu	124
Vehicle submenu	127
Convenience submenu	129

Control system

Resetting all settings

You can reset all the functions of all submenus to the factory settings.

- ▶ Press the reset knob in the instrument cluster for approximately three seconds.

In the right display you will see the request to press the reset knob again to confirm.

- ▶ Press the reset knob again.

The functions of all the submenus will reset to factory settings.



The settings you have changed will not be reset unless you confirm the action by pressing the reset knob a second time.

Submenus in the Settings menu

- ▶ Press button or .

In the right display you see the collection of submenus.

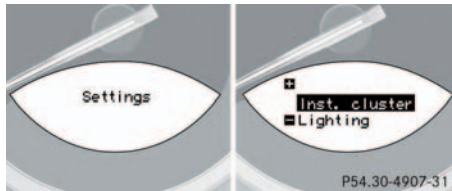

- ▶ Press button .

The selection marker moves to the next submenu.

The submenus are arranged by hierarchy. Scroll down with the button, scroll up with the button.

Move within the submenus with the or button to the individual functions.

The settings themselves are made with button or .

Resetting the functions of a submenu

For each submenu you can reset all the functions to the factory settings.

- ▶ Move to a function in the submenu.
- ▶ Press the reset knob in the instrument cluster for approximately three seconds.

In the right display you will see the request to press the reset knob again to confirm.

- ▶ Press the reset knob again.

All functions of the submenu will reset to factory settings.

The table below shows what settings can be changed within the various menus. Detailed instructions on making individual settings can be found on the following pages.

Instrument cluster	Lighting	Vehicle	Convenience
Select time display mode	Set daytime running lamp mode (USA only)	Set station selection mode (radio)	Activate easy-entry/exit feature
Select temperature display mode	Set locator lighting	Set automatic locking	Set key dependency
Select speedometer display mode	Exterior lamps delayed switch-off	Tire pressure display*	Set parking position for exterior rear view mirror
Select language	Interior lighting delayed switch-off		

Control system

Instrument cluster submenu

Access the Inst. cluster menu via the Settings menu. Use the Inst. cluster submenu to change the instrument cluster display settings. The following functions are available:

Function	Page
Select time display mode	122
Select temperature display mode	122
Select speedometer display mode	123
Select language	123

Selecting time display mode

- ▶ Move the selection marker with the **+** or **-** button to the Inst. cluster submenu.
- ▶ Press button **▲** or **▼** repeatedly until you see this message in the left display: Clock.

The selection marker is on the current setting.

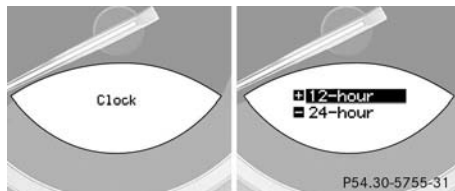

- ▶ Press **+** or **-** to set the 12-hour or 24-hour time display mode.

Selecting temperature display mode

- ▶ Move the selection marker with button **+** or **-** to the Inst. cluster submenu.
- ▶ Press button **▲** or **▼** repeatedly until you see this message in the left display: Temp. indicator.

The selection marker is on the current setting.

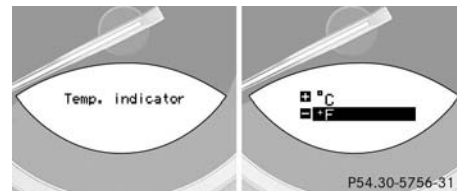

- ▶ Press **+** or **-** to set temperature unit to degrees Celsius (°C) or degrees Fahrenheit (°F).

Selecting speedometer display mode (Canada only)

- ▶ Move the selection marker with button **+** or **-** to the Inst. cluster submenu.
- ▶ Press button **↶** or **↷** repeatedly until you see this message in the left display: Speedometer.

The selection marker is on the current setting.



- ▶ Press **+** or **-** to set the speedometer units to Kilometres or Miles.

Selecting language

- ▶ Move the selection marker with button **+** or **-** to the Inst. cluster submenu.
- ▶ Press button **↶** or **↷** repeatedly until you see this message in the left display: Text.

The selection marker is on the current setting.

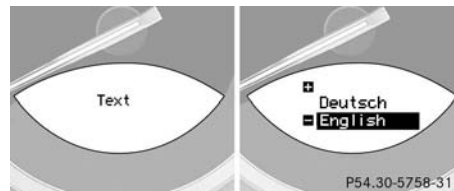

- ▶ Press **+** or **-** to select the language to be used for the multifunction display messages.

Available languages:

- German
- English
- Italian
- French
- Spanish

Control system

Lighting submenu

Access the Lighting submenu via the Settings menu. Use the Lighting submenu to change the lamp and lighting settings on your vehicle. The following functions are available:

Function	Page
Set daytime running lamp mode (USA only)	124
Set locator lighting	125
Exterior lamps delayed switch-off	125
Interior lighting delayed switch-off	127

Setting daytime running lamp mode (USA only)

- ▶ Move the selection marker with button **+** or **-** to the Lighting submenu.
- ▶ Press button **↕** or **↕** repeatedly until you see this message in the left display: Light circuit Headlamp mode.

The selection marker is on the current setting.

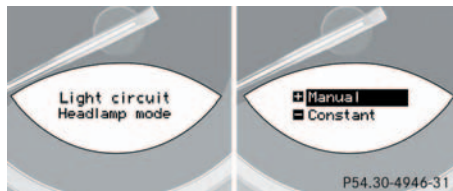

- ▶ Press **+** or **-** to select manual or daytime running lamp (constant) mode. This function is not available in countries where daytime running lamps are mandatory.

With daytime running lamp mode selected and the exterior lamp switch at position **0**, the following lamps will come on automatically when the engine is turned on:

- Parking lamps and low beam headlamps
- License plate lamps



If you turn the exterior lamp switch to another position, the corresponding lamp(s) will switch on.

For safety reasons, resetting the Lighting submenu to factory settings (▶ page 111) will not reset the daytime running lamp mode.

In the right display you will then see the message: Cannot be fully reset to factory settings while driv.!

Setting locator lighting

During darkness, the following lamps will come on when the exterior lamp switch is in position **AUTO**, the locator lighting feature is activated, and the vehicle is unlocked by remote control:

- the parking lamps
- the tail lamps
- the license plate lamps
- the front fog lamps

To activate locator lighting:

- ▶ Make sure that the locator lighting feature is set to **ON** (see below).
- ▶ Turn the exterior lamp switch to position **AUTO**.

The locator lighting switches off when the driver's door is opened. It switches off automatically after a period of approximately 40 seconds.

- ▶ Move the selection marker with button **+** or **-** to the **Lighting** sub-menu

- ▶ Press button **↶** or **↷** repeatedly until you see this message in the left display: **Locator lighting**.

The selection marker is on the current setting.



- ▶ Press **+** or **-** to select the desired setting.

The locator lighting will be switched on or off.

Setting night security illumination (Exterior lamps delayed switch-off)

Use the **Headlamps delayed switch-off** function to set whether and for how long you would like the exterior lamps to illuminate during darkness after all doors are closed. When the delayed switch-off feature is activated and the exterior lamp switch is in position **AUTO**, the following lamps will remain lit after you remove the key from the starter switch:

- the parking lamps
- the tail lamps
- the license plate lamps
- the front fog lamps

To activate night security illumination:

- ▶ Select delayed switch-off period (see below).
- ▶ Turn the exterior lamp switch to position **AUTO**.

Control system



You can reactivate this function within ten minutes by opening a door.

If you do not open a door after removing the key, the lamps will automatically switch off after 60 seconds.

To select delayed switch-off period:

- ▶ Move the selection marker with button **+** or **-** to the Lighting sub-menu.
- ▶ Press button **▲** or **▼** repeatedly until you see this message in the left display: Headlamps delayed switch-off.

The selection marker is on the current setting.

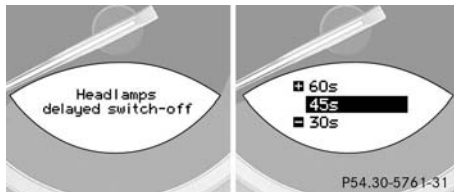

- ▶ Press **+** or **-** to select the desired lamp-on period.

You can select:

- 0 s, the delayed switch-off feature is deactivated
- 15 s, 30 s, 45 s or 60 s, the delayed switch-off feature is activated

You can temporarily deactivate the delayed switch-off feature:

- ▶ Before leaving the vehicle turn the key in the starter switch to position **0**.
- ▶ Then turn it to position **2** and back to **0**.

The delayed switch-off feature is deactivated. It will reactivate as soon as you reinsert the key in the starter switch.

For vehicles with KEYLESS-GO*:

- ▶ Press the KEYLESS-GO start/stop button on the gear selector (▷ page 30).

Interior lighting delayed switch-off

Use this function to set whether and for how long you would like the interior lighting to remain lit during darkness after the key is removed from the starter switch.

- ▶ Move the selection marker with button **+** or **-** to the Lighting sub-menu.
- ▶ Press button **↶** or **↷** repeatedly until you see this message in the left display: Int. lighting delayed switch-off.

The selection marker is on the current setting.

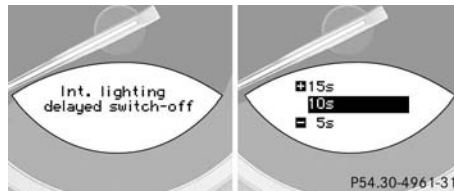

- ▶ Press **+** or **-** to select the desired lamp-on time period. You can select:
 - 0 s, the delayed switch-off feature is deactivated
 - 5 s, 10 s, 15 s or 20 s, the delayed switch-off feature is activated.

Vehicle submenu

Access the Vehicle submenu via the Settings menu. Use the Vehicle submenu to make general vehicle settings. The following functions are available:

Function	Page
Set station selection mode (radio)	128
Set automatic locking	128
Tire pressure display*	129

Control system

Setting station selection mode

Use the **Press button in audio mode** function to select the manual or memory station selection mode for the radio (▷ page 116).

- ▶ Move the selection marker with the **+** or **-** button to the **Vehicle** submenu.
- ▶ Press button **▲** or **▼** repeatedly until you see this message in the left display: **Press button in audio mode**.

The selection marker is on the current setting.

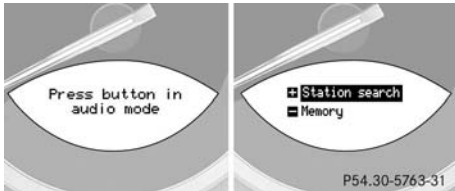

- ▶ Press **+** or **-** to select the desired station selection mode. You can select:
 - **Memory**, selects next stored station
 - **Station search**

Setting automatic locking

Use this function to activate or deactivate the automatic central locking. With the automatic central locking system activated, the vehicle is centrally locked at vehicle speeds of approximately 9 mph (15 km/h).

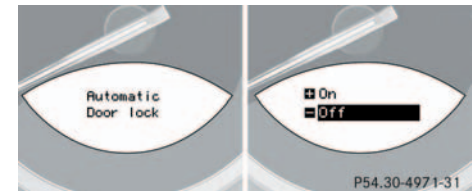

- ▶ Move the selection marker with the **+** or **-** button to the **Vehicle** submenu.
- ▶ Press button **▲** or **▼** repeatedly until you see this message in the left display: **Automatic door lock**.
- ▶ The selection marker is on the current setting.



- ▶ Press **+** or **-** to switch **Automatic Door Lock On or Off**.

Tire pressure display*

Use this function to set the unit for the tire pressure display.

- ▶ Move the selection marker with the **+** or **-** button to the Vehicle submenu.
- ▶ Press button  or  repeatedly until you see this message in the left display: Tire press. display.

The selection marker is on the current setting.



- ▶ Press **+** or **-** to select the desired tire pressure unit.

Convenience submenu

Access the Convenience submenu via the Settings menu. Use the Convenience submenu to change the settings for a number of convenience features. The following functions are available:

Function	Page
Activate easy-entry/exit feature	129
Set key dependency	130
Set parking position for exterior rear view mirror	131

Activating easy-entry/exit feature

Use this function to activate and deactivate the easy-entry/exit feature. When the feature is activated, the steering wheel and driver's seat will move back to facilitate exiting the vehicle when you

- remove the key from the starter switch
- open the driver's door

Warning!



You must make sure that no one can become trapped or injured by the moving steering wheel and the driver's seat when the easy-entry/exit feature is in operation and the driver's door is being opened or the key is removed from the starter switch. Do not leave children unattended in the vehicle, or with access to an unlocked vehicle. Unsupervised use of vehicle equipment may cause an accident and/or serious personal injury.

Do not leave children unattended in the vehicle, or with access to an unlocked vehicle. Children could open the driver's door and unintentionally activate the easy-entry/exit feature, which could result in an accident and/or serious personal injury.

Control system

After entering the vehicle, the steering wheel and seat will move into the position stored in memory when

- the driver's door is closed
- you put the key in the starter switch and
- press the appropriate stored position button on the memory switch (▷ page 99)



To cancel seat/steering wheel movement, press one of the following:

- the seat adjustment switch (▷ page 32)
 - the steering column switch (▷ page 34)
 - the memory switch (▷ page 99)
- ▶ Move the selection marker with button **+** or **-** to the Convenience sub-menu.

- ▶ Press button or repeatedly until you see this message in the left display: Easy-entry feature Activate.

The selection marker is on the current setting.



- ▶ Press **+** or **-** to change the easy-entry/exit setting.

The following settings are available for the easy-entry/exit feature:

Off The easy-entry/exit feature is deactivated

Steer. column Only the steering column is moved

Steer.col.+seat Both the steering column and the seat are moved

Setting key dependency

Use this function to set whether the memory settings for the seats, the steering wheel and the mirrors should be stored separately for each key (▷ page 99).

- ▶ Move the selection marker with button **+** or **-** to the Convenience sub-menu.

- ▶ Press button or repeatedly until you see this message in the left display: Key-dependent.

The selection marker is on the current setting.

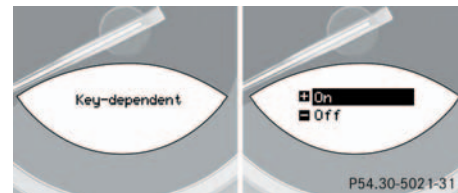

- ▶ Press **+** or **-** to set key dependency to On or Off.

Setting parking position for exterior rear view mirror

You can store a parking position for the passenger exterior rear view mirror using the memory switch (▷ page 100).

The exterior rear view mirror will return to its previous position when you

- shift out of reverse (after 10 seconds)
- exceed the speed of 6 mph (10 km/h), regardless of which gear is engaged
- press the driver's side mirror button (immediately) (▷ page 35)
- ▶ Move the selection marker with button **+** or **-** to the Convenience sub-menu.
- ▶ Press button **↶** or **↷** repeatedly until you see this message in the left display: Mirror setting when parking.

The selection marker is on the current setting.



- ▶ Press **+** or **-** to switch function On or Off.



The mirror parking position feature must be activated and the passenger side exterior rear view mirror (▷ page 35) must be selected at the time in order for the system to recall the stored mirror position when reverse gear **R** is engaged.

Trip computer menu

Use the trip computer menu to call up statistical data on your vehicle. The following information is available:





Function	Page
Fuel consumption statistics after start	132
Fuel consumption statistics since last reset	132
Call up range (distance to empty)	133



The last function called up will reappear the next time you enter the trip computer menu.

Control system

Fuel consumption statistics after start

- ▶ Press button  or  repeatedly until you see the first function of the Trip computer menu.
- ▶ Press button  or  repeatedly until you see this message in the left display: After start.

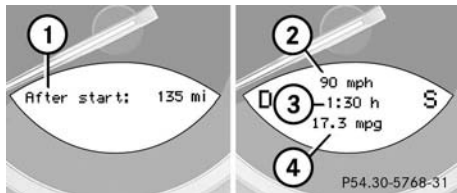





- 1 Distance driven since start
- 2 Average speed since start
- 3 Time elapsed since start
- 4 Average fuel consumption since start



All statistics stored since the last engine start will be reset approximately four hours after the key in the starter switch is turned to position **0** or removed from the starter switch.

Resetting will not occur if you turn the key back to position **1** or **2** within this time period.



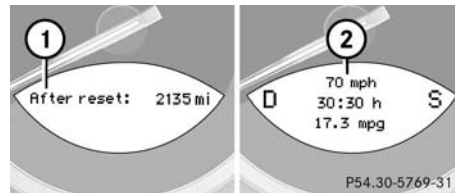

Fuel consumption since last reset

- ▶ Press button  or  repeatedly until you see the first function of the Trip computer menu.
- ▶ Press button  or  repeatedly until you see this message in the left display: From reset.







- 1 Distance driven since last reset
- 2 Average speed since last reset
- 3 Time elapsed since last reset
- 4 Average fuel consumption since last reset

Resetting fuel consumption statistics

- ▶ Press button  or  repeatedly until you see the first function of the Trip computer menu.
- ▶ Press button  or  repeatedly until you see the reading that you want to reset in the left display.
- ▶ Press and hold the reset knob in the instrument cluster (▶ page 21) until the value is reset to 0.

Call up range (distance to empty)

- ▶ Press button  or  repeatedly until you see the first function of the Trip computer menu.
- ▶ Press button  or  repeatedly until you see this message in the left display: Range.

In the right display you will see the calculated range based on the current fuel tank level.

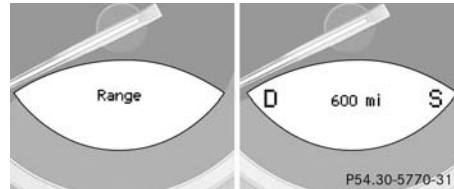
**TEL menu*****Warning!**

A driver's attention to the road must always be his/her primary focus when driving. For your safety and the safety of others, we recommend that you pull over to a safe location and stop before placing or taking a telephone call. If you choose to use the telephone while driving, please use the hands-free device and only use the telephone when weather, road, and traffic conditions permit.



Some jurisdictions prohibit the driver from using a cellular telephone while driving a vehicle.

Bear in mind that at a speed of just 30 mph (approximately 50 km/h), your vehicle is covering a distance of approximately 44 feet (approximately 13.5 m) every second.

Control system

Never operate radio transmitters equipped with a built-in or attached antenna (i.e. without being connected to an external antenna) from inside the vehicle while the engine is running. Doing so could lead to a malfunction of the vehicle's electronic system, possibly resulting in an accident and/or personal injury.

You can use the functions in the TEL menu to operate your telephone, provided it is connected to a hands-free system and switched on.

- ▶ Switch on the telephone and COMAND.
- ▶ Press button  or  on the steering wheel repeatedly until you see the TEL menu in the left display.

Which messages will appear in the right display field depends on whether your telephone is switched on or off:

- If the telephone is off, the message in the multifunction display is: TEL Off.

- If the telephone is on:

The telephone will then search for a network. During this time the right display is empty.

As soon as the telephone has found a network, READY is indicated in the right display.

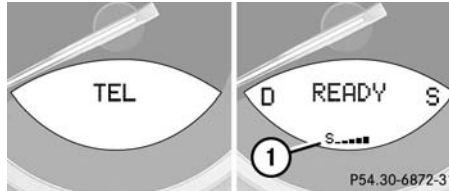

1 Signal strength

- This standby message indicates that your telephone is ready for use and you can operate it using the control system.

Rejecting a call

If you do not wish to receive the call, you can choose to reject it.

- ▶ Press button .

You have rejected the call. The caller receives a busy signal.

Answering a call

When your telephone is ready to receive calls, you can answer a call at any time. In the right display you will then see the message:

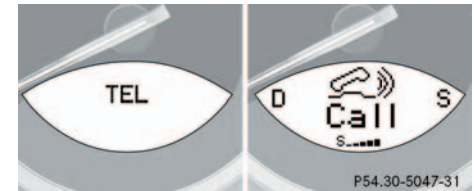

- ▶ Press button .

You have answered the call. In the right display you see the length of the call.



Ending a call

- ▶ Press button .



You have ended the call. In the right display you will again see the standby message.

Dialing a number from the phone book

If your telephone is ready to receive calls, you may select and dial a number from the phone book at any time.



- ▶ Press button  or  repeatedly until you see the TEL menu in the left display.

In the right display you will see the standby message.

- ▶ Press button  or .



The control system reads the phone book which is stored in the telephone. This may take up to 30 seconds. In the right display you will see the message Please wait!.

When the message Please wait! disappears, the phone book has been loaded.

- ▶ Press button  or  repeatedly until the desired name appears in the right display.

The stored names are displayed in increasing or decreasing alphabetical order.



If you press and hold  or  for longer than one second, the system scrolls rapidly through the list of names until you release the button again.

Cancel the quick search mode by pressing .

- ▶ Press button .

The system dials the selected phone number.

- If connection is successful, the name of the party you called and the duration of the call will appear in the display.

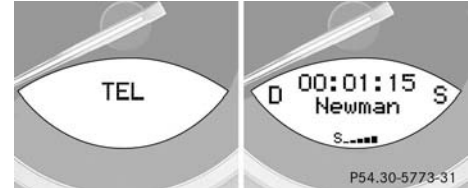

- If no connection is made, the control system stores the dialed number in the redial memory.

Control system

Redialing



The control system stores the most recently dialed phone numbers. This eliminates the need to search through your entire phone book.

- ▶ Press button  or  repeatedly until you see the TEL menu in the left display.

In the right display you will see the standby message.

- ▶ Press button  .

In the right display you see the first number in the redial memory.

- ▶ Press button  or  repeatedly until the desired name appears in the right display.

- ▶ Press button  .

The control system dials the selected phone number.

Automatic transmission

Information for driving with an automatic transmission is found in the “Getting started” section (▷ page 39).

Your transmission adapts its gear shifting process to your individual driving style by continually adjusting the shift points up or down. These shift point adjustments are performed based on current operating and driving conditions.

If the operating conditions change the automatic transmission reacts by adjusting its gear shift program.

The automatic transmission selects individual gears automatically, dependent upon

- the selector lever position **D** with gear ranges **4, 3, 2, 1** (▷ page 139)
- the selected shift program (**S/W**) (▷ page 141)
- the position of the accelerator pedal (▷ page 142)
- the vehicle speed

The current selector lever position and shift program (**S/W**) appear in the tachometer display (▷ page 110).

Warning!



It is dangerous to shift the selector lever out of **P** or **N** if the engine speed is higher than idle speed. If your foot is not firmly on the brake pedal, the vehicle could accelerate quickly forward or reverse. You could lose control of the vehicle and hit someone or something. Only shift into gear when the engine is idling normally and when your right foot is firmly on the brake pedal.

When the selector lever is in position **D**, you can influence transmission shifting by

- limiting the gear range
- changing gears yourself

Automatic transmission

One-touch gearshifting

Even with an automatic transmission you can change the gears yourself when the selector lever is in position **D**.

Downshifting

- ▶ Briefly press the selector lever to the left in the **D-** direction.

The transmission will shift from the current gear to the next lower gear. This action simultaneously limits the gear range of the transmission (▶ page 139).

Warning!



On slippery road surfaces, never downshift in order to obtain braking action. This could result in drive wheel slip and reduced vehicle control. Your vehicle's ABS will not prevent this type of loss of control.



To avoid overrevving the engine when the selector lever is moved to the **D-** direction, the transmission will not shift to a lower gear if the engine's revolutions per minute limit would be exceeded.

Upshifting

- ▶ Briefly press the selector lever to the right in the **D+** direction.

The transmission will shift from the current gear to the next higher gear as permitted by the shift program. This action simultaneously extends the gear range of the transmission.

Canceling gear range limit

- ▶ Press and hold the selector lever in the **D+** direction until **D** reappears in the tachometer display field.

The transmission will shift from the current gear range directly to gear range **D**.

Shifting into optimal gear range

- ▶ Press and hold the gear selector lever in the **D-** direction.

The transmission will automatically select the gear range suited for optimal acceleration and deceleration. This will involve shifting down one or more gears.

Gear ranges

With the selector lever in position **D**, you can limit the transmission's gear range by pressing the lever to the left (**D-**), and reverse the gear range limit by pressing the lever to the right (**D+**).

The selected gear range will appear in the tachometer display field. If you press on the accelerator when the engine has reached its rpm limit, the transmission will upshift beyond any gear range limit selected.

Gear range	Effect
4	The transmission shifts through fourth gear only.
3	The transmission shifts through third gear only. With this selection you can use the braking effect of the engine.

Gear range	Effect
2	The transmission shifts through second gear only. Allows the use of the engine's braking power when driving <ul style="list-style-type: none"> • on steep downgrades • in mountainous regions • under extreme operating conditions
1	The transmission operates only in first gear. For maximum use of the engine's braking effect on very steep or lengthy downgrades.

Automatic transmission

Gear selector lever position

	Effect
P Park position	<p>Selector position when the vehicle is parked. Only place selector lever in position P when vehicle is stopped. The park position is not intended to serve as a brake when the vehicle is parked. Rather, the driver should always set the parking brake in addition to placing the selector lever in position P to secure the vehicle.</p> <p>The key can only be removed from the starter switch with the selector lever in position P.</p>
R Reverse gear	<p>Place selector lever in position R only when vehicle is stopped.</p>

	Effect
N Neutral	<p>No power is transmitted from the engine to the drive axle. When the brakes are released, the vehicle can be moved freely (pushed or towed).</p> <p>To avoid damage to the transmission, never engage N while driving.</p> <p>If ESP is deactivated or malfunctioning: Only move selector lever to N if the vehicle is in danger of skidding (e.g. on icy roads).</p>
D Drive	<p>The transmission shifts automatically. All five forward gears are available.</p>



Coasting the vehicle, or driving for any other reason with selector lever in **N**, can result in transmission damage that is not covered by the Mercedes-Benz Limited Warranty.

Warning!



Getting out of your vehicle with the selector lever not fully engaged in position **P** is dangerous. Also, position **P** alone is not intended to or capable of preventing your vehicle from moving, possibly hitting people or objects.

Always set the parking brake in addition to shifting to position **P** (▷ page 47).

When parked on an incline, also turn the front wheels towards the road curb.

Warning!



When leaving the vehicle, always remove the key from the starter switch, take the KEY-LESS-GO* card (if so equipped) with you and lock the vehicle. Do not leave children unattended in the vehicle, or with access to an unlocked vehicle. Children could move the selector lever from position **P**, which could result in an accident and/or serious personal injury.

Program mode selector switch

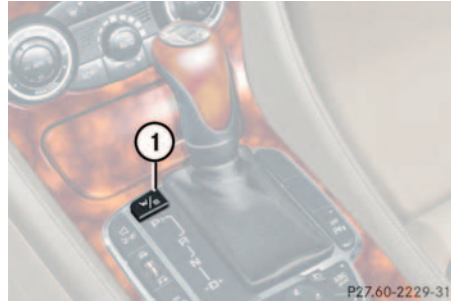

1 Program mode selector switch

S Standard For regular driving

W Winter For winter driving

- ▶ Press the program mode selector switch repeatedly until the letter of the desired shift program appears in the tachometer display field (▷ page 109).

Select **W** for winter driving:

- The vehicle starts out in second gear (both forward and reverse) for gentler starts. This does not apply if full throttle is applied or gear range **1** is selected.
- Traction and driving stability are improved on icy roads.
- Upshifts occur earlier even when you give more gas. The engine then operates at lower rpms and the wheels are less likely to spin.
- The power transmission ratio for selector lever position **R** changes depending on the program mode selected (**W** or **S**).

Automatic transmission

Accelerator position

Your driving style influences the transmission's shifting behavior:

Less throttle Earlier upshifting

More throttle Later upshifting

Kickdown

Use kickdown when you want maximum acceleration.

- ▶ Press the accelerator past the point of resistance.

The transmission shifts into a lower gear.

- ▶ Ease on the accelerator when you have reached the desired speed.

The transmission shifts up again.

Steering wheel gearshift control (Speedshift) and manual shift program SL 55 AMG

The SL 55 AMG can be driven in both the automatic and manual shift program modes. In the manual shift program mode you can change the gears yourself on the steering wheel or by using the selector lever.

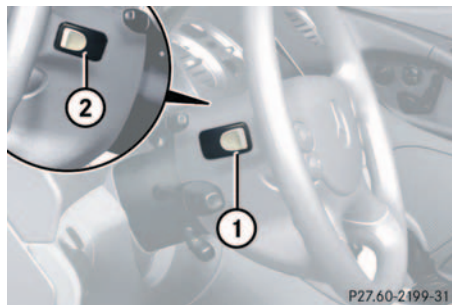

1 Left button: downshift

2 Right button: upshift

To do so, you must first select the manual shift program **M** on the program mode selector switch.



3 Program mode selector switch

S Regular For regular driving

W Winter For winter driving

MANUAL For manual gear shifting

The selected shift program (*S/W/M*) is indicated in the tachometer display field (▷ page 109).

Activating steering wheel gearshift control

- ▶ Press the program mode selector switch repeatedly until the **M** for manual shift program appears in the tachometer display field.

Automatic gear shifting is deactivated.

Upshifting

- ▶ Press the button located on the right side of the steering wheel.
- or
- ▶ Briefly press the selector lever to the right in the **D+** direction.

The transmission shifts to the next higher gear.

Warm up the engine smoothly. Do not place full load on the engine until the operating temperature has been reached. Shift into reverse gear only when the vehicle is stopped.

Downshifting

- ▶ Press the button located on the left side of the steering wheel.
- or
- ▶ Briefly press the selector lever to the right in the **D-** direction.

The transmission shifts to the next lower gear.

Warning!



On slippery road surfaces, never downshift in order to obtain braking action. This could result in drive wheel slip and reduced vehicle control. Your vehicle's ABS will not prevent this type of loss of control.

Deactivating steering wheel gearshift control

- ▶ Press the program mode selector switch repeatedly until **S** or **W** appears in the tachometer display field.



At each engine start, the transmission will go into the last shift program mode selected (**S** or **W**). Only program mode **M** is not stored and will not be recalled when engine is restarted.

Automatic transmission

Emergency operation (Limp Home Mode)

If vehicle acceleration worsens or the transmission no longer shifts, the transmission is most likely operating in limp home (emergency operation) mode. In this mode only 2nd gear and reverse gear can be activated.

- ▶ Stop the vehicle.
- ▶ Move selector lever to **P**.
- ▶ Turn off the engine.
- ▶ Wait at least ten seconds before re-starting.
- ▶ Restart the engine.
- ▶ Move selector lever to position **D** (for 2nd gear) or **R**.
- ▶ Have the transmission checked at an authorized Mercedes-Benz Center as soon as possible.

Good visibility

Information on the windshield wipers (▷ page 44) and for setting the rear view mirrors (▷ page 35) is found in the “Getting started” section.

Rear view mirror

Automatic antiglare rear view mirror

The reflection brightness of the exterior rear view mirror on the driver's side and the inside rear view mirror will respond automatically to glare when

- the ignition is switched on, and
- incoming light from headlamps falls on the sensor in the inside rear view mirror.

The rear view mirror will not react if

- reverse gear is engaged
- the interior lighting is turned on

Warning!



The automatic antiglare function does not react if incoming light is not aimed directly at sensors in the inside rear view mirror.

The inside rear view mirror and the exterior rear view mirror on the driver's side do not react, for example, if the wind screen is installed.

Glare can endanger you and others.

Warning!



Exercise care when using the passenger side exterior rear view mirror. The mirror surface is convex (outwardly curved surface for a wider field of view). Objects in mirror are closer than they appear. Check your inside rear view mirror or glance over your shoulder before changing lanes.

Warning!



In the case of an accident liquid electrolyte may escape from the mirror housing if the mirror glass breaks.

Electrolyte has an irritating effect. Do not allow the liquid to come into contact with eyes, skin, clothing, or respiratory system. In case it does, immediately flush affected area with water, and seek medical help if necessary.



Electrolyte drops coming into contact with the vehicle paint finish can be completely removed only while in the liquid state by applying plenty of water.

Good visibility

Headlamp cleaning system

The switch is located on the left side of the dashboard.



1 Headlamp washer switch

- ▶ Switch on ignition.
- ▶ Press switch 1.

Rear window defroster

For information on the rear window defroster (> page 153).

Sun visors

The sun visors protect you from sun glare while driving.

Warning!



Do not use the vanity mirror while driving. Keep the mirrors in the sun visors closed while vehicle is in motion. Reflected glare can endanger you and others.

- ▶ Swing sun visors down when you experience glare.

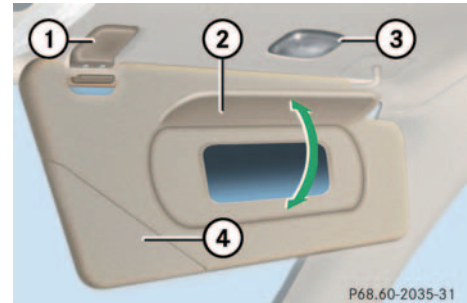

- 1 Mounting
- 2 Mirror cover
- 3 Mirror lamp
- 4 Holder for gas cards

- ▶ To use mirror, lift up cover 2.



If sunlight enters through a side window, disengage sun visor from mounting 1 and pivot to the side.

The mirror lamp 3 will switch off.

Automatic climate control

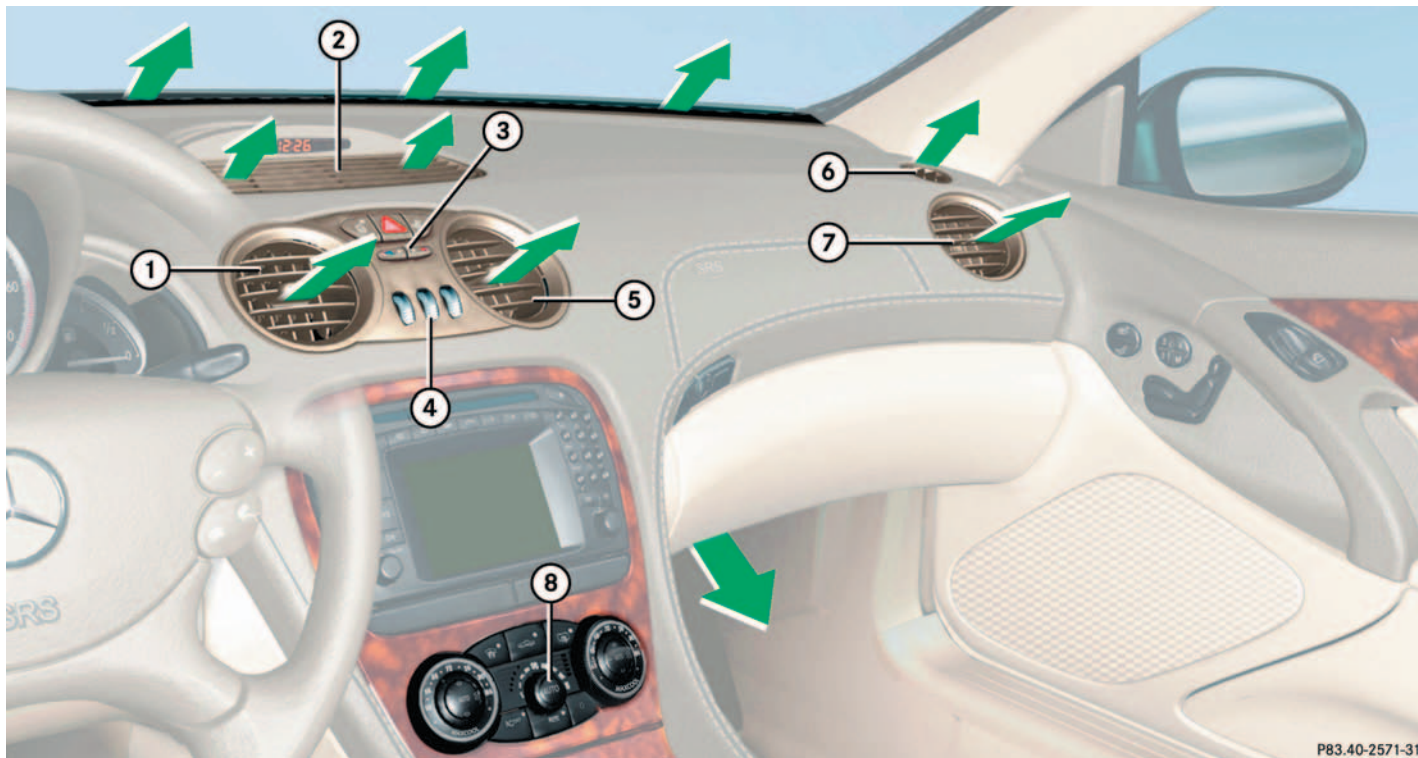

P83.40-2571-31

Automatic climate control

	Item
1	Center air vent, adjustable
2	Center air vent, fixed
3	Air temperature controls for center and side air vents
4	Air volume control for center and side air vents
5	Center air vent, adjustable
6	Side defroster vent
7	Side air vent, adjustable
8	Automatic climate control panel



For draft-free ventilation, move the sliders for the center air vents to the middle position.

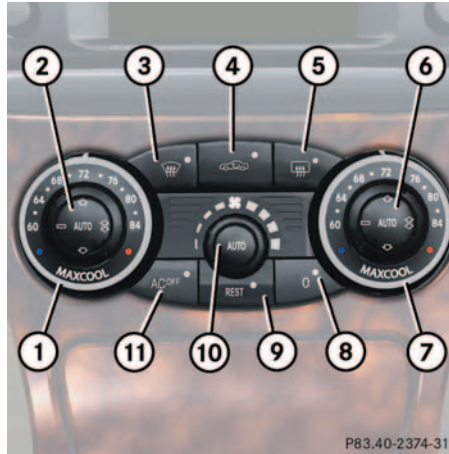

Automatic climate control panel

	Item
1	Temperature control, left
2	Air distribution, left (automatic or manual operation)
3	Defrosting
4	Air recirculation
5	Rear window defroster
6	Air distribution, right (automatic or manual operation)
7	Temperature control, right
8	Automatic climate control on/off (complete system)
9	Residual heat/ventilation
10	Air volume control (automatic, manual)
11	AC cooling on/off

The automatic climate control is operational whenever the engine is running. You can operate the climate control system in either the automatic or manual mode. The system cools or heats the interior depending on the selected interior temperature and the current outside temperature.

Nearly all dust particles, pollutants and odors are filtered out before outside air enters the passenger compartment through the air distribution system.

Warning!



Follow the recommended settings for heating and cooling given on the following pages. Otherwise the windows could fog up, impairing visibility and endangering you and others.



If the vehicle interior is hot, ventilate the interior before driving off.

Keep the air intake grille in front of the windshield free of snow and debris.

When the retractable hardtop is closed, do not obstruct air flow by placing objects on the air flow-through exhaust slots below the rear window.

Setting the temperature

Use the temperature controls **1** and **7** to separately adjust the air temperature on each side of the passenger compartment. You should raise or lower the temperature setting in small increments, preferably starting at 72°F (22°C).



When operating the climate control system in automatic mode, you will only rarely need to adjust the temperature, air volume and air distribution.

Increasing

- ▶ Turn the outer adjustment ring slightly to the right.

The automatic climate control system will correspondingly adjust the interior air temperature.

Decreasing

- ▶ Turn the outer adjustment ring slightly to the left.

The automatic climate control system will correspondingly adjust the interior air temperature.

Automatic climate control

Adjusting the temperature for center and side air vents

When outside temperatures are low, you can manually raise the air temperature for the center and side air vents. The controls **3** are located between the center air vents (▷ page 147).

Turning on warm air

- ▶ Press the left button (red).

The indicator lamp on the button lights up. Warm air will enter from the center and side air vents.

Turning off warm air

- ▶ Press the left button (red).

The indicator lamp on the button goes out. The air from the outlets will return to the temperature set in the system.

Turning on cooler air

- ▶ Press the right button (blue).

The indicator lamp on the button lights up. Cooler air will enter from the center and side air vents.

Turning off cooler air

- ▶ Press the right button (blue).

The indicator lamp on the button goes out. The air from the outlets will return to the temperature set in the system.

Adjusting air volume

Use the air volume control **10** (▷ page 148) for both automatic and manual air volume adjustment.

Adjusting manually

- ▶ Press the control knob.

The **AUTO** light on the control knob goes out. You can now select one of nine air volume settings.





Adjusting automatically

- ▶ Press the control knob.

The **AUTO** light on the control knob comes on. The airflow is adjusted automatically.

Adjusting air distribution

Use the air distribution controls **2** and **6** (▷ page 148) to separately adjust the air distribution on each side of the passenger compartment. The following symbols are found on the controls:

Symbol	Function
	Directs air through the center air vents
	Directs air to the windows
	Directs air into the entire vehicle interior
	Directs air to the footwells

Adjusting manually

- ▶ Press the control knob.



The **AUTO** light on the control knob goes out. The air distribution can be adjusted manually.

Adjusting automatically

- ▶ Press the control knob.

The **AUTO** light on the control knob comes on. The air distribution is adjusted automatically.

Windshield fogged on the outside

- ▶ Switch the windshield wipers on.
- ▶ Turn the air distribution control to  or .

Maximum cooling MAXCOOL

If the left and right air distribution controls as well as the airflow volume control are set to **AUTO** and there is a high need for cooling, the display MAXCOOL lights up on the left and right temperature controls.

This provides the fastest possible cooling of the vehicle interior (when retractable hards top is closed).

Defrosting



These settings should only be selected for a short time.

Activating

- ▶ Press button  (▷ page 148).

The indicator lamp on the button lights up.

Deactivating

- ▶ Press button  (▷ page 148).

The indicator lamp on the button goes out. Defrosting is turned off.

Automatic climate control

Air recirculation mode

Switch to air recirculation mode to prevent unpleasant odors from entering the vehicle from the outside. This setting cuts off the intake of outside air and recirculates the air in the passenger compartment.

Warning!



When the outside temperature is below 41°F (5°C), only switch to air recirculation mode for short periods to prevent window fogging.

Activating

- ▶ Press button  (▷ page 148).

The indicator lamp on the button lights up.



If you keep button  pressed, the side windows will close.

The air recirculation mode is activated automatically

- at high outside temperatures
- if the concentration of carbon monoxide and nitrogen oxide in the outside air increases, for example in a tunnel

If you have turned off the air conditioner (▷ page 155) or the outside temperature is below 41°F (5°C), the air recirculation mode will not switch on automatically.

Deactivating

- ▶ Press button  (▷ page 148).

The indicator lamp on the button goes out.



If you keep button  pressed, the side windows will return to their previous position.

The air recirculation mode is deactivated automatically

- after five minutes if the outside temperature is below approximately 41°F (5°C)
- after five minutes if the air conditioner is turned off
- after 30 minutes if the outside temperature is above approximately 41°F (5°C)

At outside temperatures above 79°F (26°C) the system will not automatically switch back to outside air. A quantity of outside air is added after approximately 30 minutes.

Rear window defroster

The rear window defroster uses a large amount of power. To keep the battery drain to a minimum, switch off the defroster as soon as the rear window is clear. The defroster is automatically deactivated after approximately 6 to 17 minutes of operation depending on the outside temperature.

Activating

- ▶ Press button  (> page 148).

The indicator lamp on the button lights up.

Deactivating

- ▶ Press button  (> page 148) again.
The indicator lamp on the button goes out.

Warning!



Any accumulation of snow and ice should be removed from the rear window before driving. Visibility could otherwise be impaired, endangering you and others.



The rear window defroster cannot be switched on when the retractable hardtop is open. The indicator lamp will start blinking if the hardtop is open.

- Close the retractable hardtop.

The rear window defroster can again be turned on.



If the rear window defroster switches off too soon and the indicator lamp starts blinking, this means that too many electrical consumers are operating simultaneously and there is insufficient voltage in the battery. The system responds automatically by deactivating the rear window defroster.

As soon as the battery has sufficient voltage, the rear window defroster automatically turns itself back on.

Automatic climate control

Residual heat and ventilation

With the engine switched off, it is possible to continue to heat or ventilate the interior for up to 30 minutes. This feature makes use of the residual heat produced by the engine.



How long the system will provide heating depends on the coolant temperature and the temperature set by the operator. The blower will run at speed setting **1** regardless of the air distribution control setting.

Activating

- ▶ Turn the key in the starter switch to position **1** or remove it from the starter switch.
- ▶ Press button **REST** (▷ page 148).

The indicator lamp on button **REST** comes on.

Deactivating

- ▶ Press button **REST** (▷ page 148).

The indicator lamp on button **REST** goes out.

The residual heat is automatically turned off:

- when the ignition is switched on
- after about 30 minutes
- if the battery voltage drops

Deactivating the automatic climate control system



This setting is only recommended when the retractable hardtop is open.

Deactivating

It is possible to completely deactivate the automatic climate control system.

- ▶ Press button **0** (▷ page 148).

The indicator lamp on button **0** comes on.

Reactivating

There are several ways to reactivate the automatic climate control system:

- ▶ Press any button on the automatic climate control panel (▷ page 148).

The indicator lamp on button **0** switches off.

or

- ▶ Turn one of the control knobs on the automatic climate control.

The indicator lamp on button **0** switches off.

Air conditioning

The air conditioning is operational while the engine is running and cools the interior air to the temperature set by the operator.



Condensation may drip out from underneath the vehicle. This is normal and not an indication of a malfunction.

Deactivating

It is possible to deactivate the air conditioning (cooling) function of the automatic climate control system. The air in the vehicle will then no longer be cooled or dehumidified.

- ▶ Press button **AC^{OFF}** (▷ page 148).

The indicator lamp on the button **AC^{OFF}** lights up.

Activating

Moist air can fog up the windows. You can dehumidify the air with the air conditioning.

- ▶ Press **AC^{OFF}** again (▷ page 148).

The indicator lamp on the button **AC^{OFF}** goes out.

The air conditioning uses the refrigerant R134A. This refrigerant is free of CFCs which are harmful to the ozone layer.



If the **AC^{OFF}** button on the automatic climate control panel starts to blink, this indicates that the air conditioning is losing refrigerant. The compressor has turned itself off. The air conditioning cannot be turned on again.

- Have the air conditioner checked at the nearest authorized Mercedes-Benz Center.

Automatic climate control

Ventilated storage compartments

The glove box and the armrest storage compartment have their own air vents that allow for cooling ventilation when the automatic climate control system is activated.



You should keep these air vents closed when outside temperatures are low.

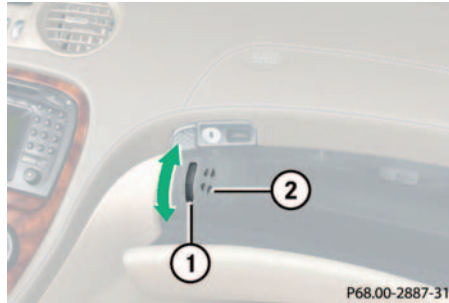

Glove box

- 1 Thumbwheel
- 2 Air vent

Opening the air vent

- ▶ Turn the wheel 1 upwards.

Closing the air vent

- ▶ Turn the wheel 1 downwards.

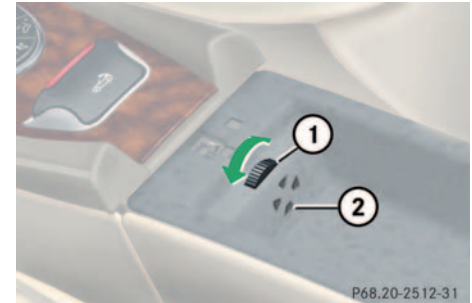

Storage box under the armrest

- 1 Thumbwheel
- 2 Air vent

Opening the air vent

- ▶ Turn the wheel 1 to the right.

Closing the air vent

- ▶ Turn the wheel 1 to the left.

Power windows

Opening and closing the windows

The side windows can be opened and closed electrically. The switches for all the side windows are on the driver's door. The switch for the passenger side is on the passenger door.

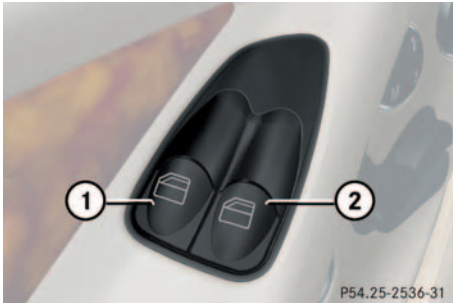

- 1 Left front and rear windows
- 2 Right front and rear windows

Warning!



When closing the windows, make sure that there is no danger of anyone being injured by the closing procedure.

The closing of the door windows can be immediately halted by releasing the switch, or, if the switch was pulled past the resistance point and released, by either pressing or pulling the respective switch.

If the window encounters an obstruction that blocks its path in a circumstance where you pulled the switch past the resistance point and released it to close the window, the automatic reversal function will stop the window and open it slightly.

If the window encounters an obstruction that blocks its path in a circumstance where you are closing the window by pulling the switch to its resistance point and holding it there, by pressing and holding button  on the SmartKey, or by pressing and holding the lock button (vehicles with KEYLESS-GO*) on the door handle, the automatic reversal function will not operate.

When leaving the vehicle, always remove the key from the starter switch, take the KEYLESS-GO* card (if so equipped) with you, and lock your vehicle. Do not leave children unattended in the vehicle, or with access to an unlocked vehicle. Unsupervised use of vehicle equipment can cause an accident and/or serious personal injury.

Power windows

Opening the front side windows

- ▶ Press switch **1** or **2**.

The window (left or right) will move downwards until you release the switch.

If the hardtop is open, the respective rear window will open automatically as soon as the front window is completely open.

Closing the front side windows

- ▶ Pull on switch **1** or **2**.

The window (left or right) will move upwards until you release the switch.

If you pull and hold the switch up when closing the window, and upward movement of the window is blocked by some obstruction including but not limited to arms, hands, fingers, etc., the automatic reversal will not operate.

Opening the rear side windows

- ▶ Open the front window.

If the hardtop is open, the respective rear window will open automatically as soon as the front window is completely open.

If the hardtop is closed:

- ▶ Press again on switch **1** or **2**.

The rear window will open completely.

Closing the rear side windows

- ▶ Close the front window.
- ▶ Pull again on switch **1** or **2**.

The rear window will close completely.

Fully opening the front side windows

- ▶ Press switch **1** or **2** past the point of resistance and release.

Fully closing the front side windows

- ▶ Pull on switch **1** or **2** past the point of resistance and release.

If the upward movement of the window is blocked during the closing procedure, the window will stop and open slightly.

Stopping the front side windows

- ▶ Press or pull respective switch again.

Synchronizing power windows

The side power windows must be resynchronized each time after the battery has been disconnected:

- ▶ Pull the power window switches until the side windows are closed and hold the switches for approximately one second.

Retractable hardtop

Opening and closing the retractable hardtop

For safety reasons, the retractable hardtop can only be opened and closed when the vehicle is standing still.

Warning!



Before operating the switch for the retractable hardtop, make sure that no persons are injured by the moving parts (retractable roof, roof frame, and trunk lid) due to inattention.

Hands must never be placed near the roof frame, upper windshield area, hardtop, shelf behind roll bars, or trunk lid while the retractable hardtop is being raised or lowered. Serious personal injury may occur.

If potential danger exists, release the retractable hardtop switch. This immediately interrupts the raising or lowering procedure. You then can operate the hardtop switch to raise or lower the hardtop away from the danger zone.

Warning!



When leaving the vehicle, always remove the key from starter switch, take the KEY-LESS-GO* card (if so equipped) with you, and lock your vehicle. Do not leave children unattended in the vehicle, or with access to an unlocked vehicle. Unsupervised use of vehicle equipment can cause an accident and/or serious personal injury.



Never sit or place heavy objects on the rear shelf. Doing so could cause damage to the retractable hardtop and the rear shelf.



When opening and closing the retractable roof, make sure that

- there is sufficient clearance for the hardtop to move up and the trunk lid to move back
- the luggage cover is extended and closed
- the trunk lid is closed
- no roof luggage carrier is installed
- the outside temperature is above +5°F (−15°C)

Otherwise the roof and trunk of the vehicle could be damaged.

Retractable hardtop

Luggage cover

The luggage cover is located in the trunk.

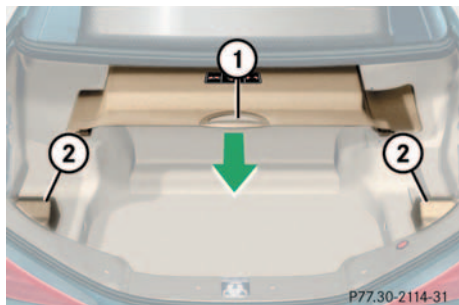

- 1 Handle
- 2 Holders

Closing luggage cover

- ▶ Pull out the luggage cover using the handle **1**.
- ▶ Hook the luggage cover into the left and right side holders **2**.

Opening luggage cover

- ▶ Unhook luggage cover from side holders.
- ▶ While holding onto the handle **1**, guide luggage cover back into its storage compartment.



To prevent damage to the hardtop or luggage/cargo when lowering the roof:

- load trunk only to the height of the luggage cover
- do not permit luggage/cargo to push up the closed luggage cover
- do not load anything on top of or in front of the luggage cover
- do not place anything on the shelf behind the roll bar

Opening the retractable hardtop with the switch



Hardtop switch

Before pulling on the hardtop switch, you must make sure that:

- the parking brake is engaged (▷ page 41)
- the luggage cover is closed, see Luggage cover
- the trunk lid is closed
- the ignition is switched on (key in starter switch position **2**)

- ▶ Pull up on the hardtop switch as indicated by the arrow until the hardtop is completely lowered into its trunk storage compartment and the indicator lamp in the hardtop switch goes out.

The multifunction display will briefly show the message `Hardtop open`.



Be sure that the roof is dry before you open it. Otherwise water may enter the trunk interior.

Closing the retractable hardtop with the switch



Before pressing the hardtop switch, you must make sure that:

- the parking brake is engaged (▷ page 41)
- the luggage cover is closed (▷ page 160)
- the trunk lid is closed
- the ignition is switched on (key in start-er switch position **2**)

- ▶ Press the hardtop switch as indicated by the arrow until the hardtop is completely closed and locked and the indicator lamp in the hardtop switch goes out.

The multifunction display will briefly show the message `Hardtop closed`.

Warning!



If the retractable hardtop is not fully opened or closed, a warning will sound after 15 seconds, pressure in the hardtop's hydraulic system will drop and the hardtop will lower.

Be sure to keep the hardtop switch pulled or pressed until the hardtop is fully opened or closed. The hydraulic pump will then shut off.

To prevent possible accidents, drive the vehicle only with the hardtop either completely closed and locked, or fully lowered into its storage compartment.

Retractable hardtop

Locking the retractable hardtop after raising/lowering

Warning!



The hardtop is not fully closed and locked or not fully opened and locked if:

- the indicator light in the hardtop switch remains lit
- the message *Hardtop in operation!* is shown in the multifunction display and the indicator lamp in the hardtop switch does not go out
- the indicator lamp blinks and a warning sounds for 10 seconds and the message *Lock hardtop* is shown in the multifunction display when starting to drive

If the retractable hardtop is not properly locked, lock it as described below.

Unlocked status noticed when stopped

- ▶ Switch on the ignition.
- ▶ To lock the hardtop in its fully closed position, press hardtop switch forward.

The message *Hardtop Closed* will be shown in the multifunction display.

or:

- ▶ To lock the hardtop in its fully opened position, pull up on the hardtop switch.

The message *Hardtop Open* will be shown in the multifunction display.

Unlocked status noticed while driving

Warning!



Stop the vehicle and lock the hardtop before continuing to drive. You could otherwise endanger yourself and others.

- ▶ Stop the vehicle.
- ▶ Leave the ignition switched on.

- ▶ To lock the hardtop in its fully closed position, press hardtop switch forward.

The message *Hardtop Closed* will be shown in the multifunction display.

or:

- ▶ To lock the hardtop in its fully opened position, pull up on the hardtop switch.

The message *Hardtop Open* will be shown in the multifunction display.

Warning!

If the retractable hardtop does not completely open or close, the roof hydraulics will lose pressure and the retractable hardtop is lowered

- after approximately seven minutes when the ignition is switched on
- after approximately 15 seconds when the ignition is switched off



Shortly before the hardtop is lowered, a warning will sound and the hardtop switch lamp will blink. In the speedometer display you will see , in the tachometer display you will see the message *being lowered!*

- Properly lock the retractable hardtop (> page 162) before continuing to drive

Opening the retractable hardtop with the key**Warning!**

Before operating the switch for the retractable hardtop make sure that no persons are injured by the moving parts (retractable roof, roof frame, and trunk lid) due to inattention.

Hands must never be placed near the roof frame, upper windshield area, hardtop, shelf behind roll bars, or trunk lid while the retractable hardtop is being raised or lowered. Serious personal injury may occur.

If potential danger exists, release the respective button on the SmartKey. This immediately interrupts the raising or lowering procedure. You then can operate  or  to raise or lower the hardtop away from the danger zone.



- ▶ Aim the transmitter eye at the door handle.
- ▶ Press and hold button  until the retractable hardtop is completely open.

The seat ventilation switches on. The rear side windows open. In the tachometer display you will see the message *Hardtop open.*

Retractable hardtop

Closing the retractable hardtop with the key

- ▶ Aim the transmitter eye at the door handle.
- ▶ Press and hold button  until the retractable hardtop is completely closed.

The retractable hardtop and the side windows close. In the tachometer display you will see the message **Hardtop closed**.

Warning!



If the retractable hardtop does not completely open or close a warning sounds and the retractable hardtop switch blinks. In the speedometer display you will see , in the tachometer display you will see the message **being lowered!**. After about 15 seconds the roof hydraulics lose pressure.

Properly lock the retractable hardtop (▷ page 162) before continuing to drive.

Problems when operating the retractable hardtop

Indicator lamp in the retractable hardtop switch is blinking

Several problems may cause the indicator lamp in the hardtop switch to blink when activated:

- The luggage cover in the trunk is not closed.
 - ▶ Close the luggage cover in the trunk.
- The trunk lid is open.
 - ▶ Close the trunk lid.
- The battery voltage is too low.
 - ▶ Start engine and let run while activating switch.

- The hardtop drive system has shut itself down. For safety reasons, no more than five consecutive attempts may be made to raise or lower the hardtop.

- ▶ After about ten minutes you may again attempt to open or close the retractable hardtop again.

If the indicator lamp in the retractable hardtop switch blinks when starting off or while driving and you hear a warning sound for a maximum of 10 seconds, the retractable hardtop is not locked.

- ▶ Properly lock the retractable hardtop (▷ page 162) before continuing to drive.

If the indicator lamp continues to blink after you have carried out the above actions, there is a malfunction.

- ▶ Have the retractable hardtop system checked at an authorized Mercedes-Benz Center.

Indicator lamp in the retractable hardtop switch lights when vehicle is stopped

If the indicator lamp in the retractable hardtop switch lights while the vehicle is standing still and the switch was not activated, then the retractable hardtop is not locked.

- ▶ Properly lock the retractable hardtop (▷ page 162) before continuing to drive.

The retractable hardtop will not lock

There is a malfunction in the retractable hardtop system.

- ▶ Notify an authorized Mercedes-Benz Center.

Wind screen

Warning!



The wind screen can restrict the driver's vision to the rear of the vehicle. To prevent a possible accident when visibility is limited (e.g. in darkness), the upper part of the wind screen should be folded back.

The wind screen deflects drafts away from the driver and passenger when the hardtop is lowered. It is stored in a separate storage bag.

Installing

- ▶ Leave the wind screen folded and place it on the roll bar.

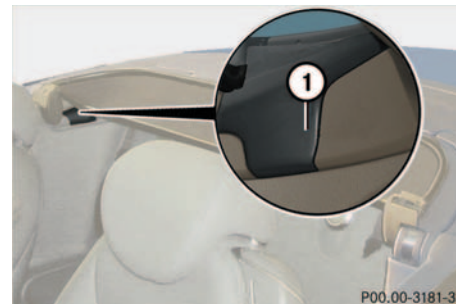

1 Guide tabs

- ▶ Slide the wind screen into the roll bar until the guide tabs on each side latch underneath the roll bar. Make sure that the fastening straps do not get caught.
- ▶ Raise the roll bar slightly (▷ page 61).

Retractable hardtop

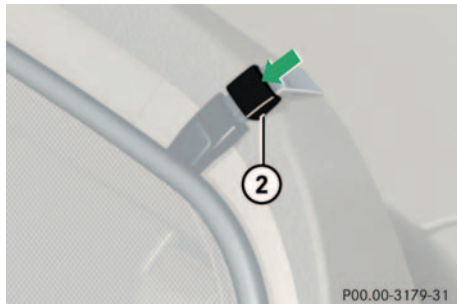

2 Close the fastening straps

- ▶ Guide the fastening straps around the top of the roll bar and close the buckles.
- ▶ Tighten the fastening straps if necessary.
- ▶ Lower the roll bar.
- ▶ Fold the upper section of the wind screen up towards the head restraints until it stops.

Removing

- ▶ Fold the upper section of the wind screen back down.
- ▶ Raise the roll bar slightly (▶ page 61).

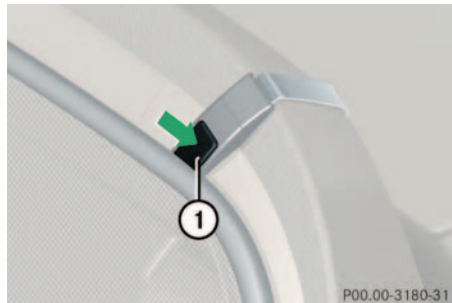

1 Release button

- ▶ Undo the buckles on the upper section of the roll bar by pressing the release button **1**.

- ▶ Lower the roll bar. Make sure that the fastening straps do not get caught.
- ▶ Pull the wind screen out towards the front of the vehicle. Be careful not to damage interior trim with the guide tabs.
- ▶ Place the wind screen back into the bag.

Sunshade for panorama roof*

The sunshade protects you from excessive sunlight coming in through the panorama roof.

Warning!



Do not operate the sunshade while driving. Adjusting the sunshade while driving could cause the driver to lose control of the vehicle.

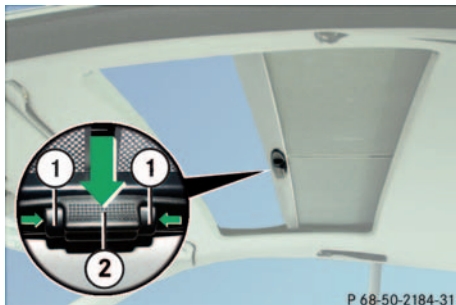

- 1 Stop buttons
- 2 Handle

Closing

- ▶ Using the handle **2**, slide the sunshade towards the front of the vehicle.

Opening

- ▶ Squeeze the stop buttons **1** and guide the sunshade towards the rear.

Driving systems

Driving systems

The driving systems of your vehicle are described on the following pages:

- Cruise control and DISTRONIC*, with which the vehicle can maintain a preset speed
- ABC with vehicle level control systems, with which you can change vehicle suspension characteristics
- Parktronic*, which assists the driver during parking maneuvers

The driving systems BAS, ABS, SBC, and ESP are described in the “Safety” section (▷ page 68).

Cruise control

The cruise control automatically maintains the speed you set for your vehicle.

Use of cruise control is recommended for driving at a constant speed for extended periods of time. You can set any speed over 20 mph (30 km/h).

The cruise control function is operated by means of the cruise control lever.

The cruise control lever is the uppermost lever found on the left-hand side of the steering column (▷ page 18).

Warning!



The cruise control is a convenience system designed to assist the driver during vehicle operation. The driver is and must always remain responsible for the vehicle speed and for safe brake operation.

Only use the cruise control if the road, traffic, and weather conditions make it advisable to travel at a steady speed.

- The use of cruise control can be dangerous on winding roads or in heavy traffic because conditions do not allow safe driving at a steady speed.
- The use of cruise control can be dangerous on slippery roads. Rapid changes in tire traction can result in wheel spin and loss of control.
- Deactivate the cruise control when driving in fog.

The “Resume” function should only be operated if the driver is fully aware of the previously set speed and wishes to resume this particular preset speed.

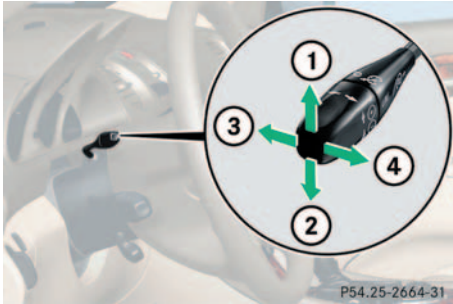

- 1 Set current or higher speed
- 2 Set current or lower speed
- 3 Cancel cruise control
- 4 Resume at previously set speed

Saving current speed

- ▶ Accelerate or decelerate to the desired speed.
- ▶ Briefly lift **1** or depress **2** the cruise control lever.

The current speed is set.

- ▶ Remove your foot from the accelerator pedal.

The cruise control is activated.



On uphill or downhill grades, the cruise control may not be able to maintain the set speed. Once the grade eases, the set speed will be resumed.

Canceling cruise control

There are several ways to cancel the cruise control:

- ▶ Step on the brake pedal.
- or
- ▶ Briefly push the cruise control lever to position **3**.

The cruise control will be canceled. The last speed set will be stored for later use.



Moving gear selector lever to position **N** while driving also cancels cruise control. However, the gear selector lever should not be moved to position **N** while driving except to coast when the vehicle is in danger of skidding (e.g. on icy roads).



The last stored speed is canceled when you turn off the engine.

Driving systems

Setting stored speed (“Resume” function)

Warning!



The speed stored in memory should only be set again if prevailing road conditions permit. Possible acceleration or deceleration differences arising from returning to the preset speed could cause an accident and/or serious injury to you and others.

- ▶ Briefly push the cruise control lever to position **4**.

The cruise control will resume the last previously set speed.

- ▶ Remove your foot from the accelerator pedal.

Setting a higher speed

- ▶ Lift the cruise control lever to position **1** and hold it up until the desired speed is reached.
- ▶ Release the cruise control lever.

The new speed is set.



Depressing the accelerator pedal does not deactivate the cruise control. After brief acceleration (e.g. for passing), the cruise control will resume the last speed set.

Setting a lower speed

- ▶ Depress the cruise control lever to position **2** and hold it down until the desired speed is reached.
- ▶ Release the cruise control lever.

The new speed is set.



When you use the cruise control lever to decelerate, the transmission will automatically downshift if the engine's braking power does not brake the vehicle sufficiently.

Fine adjustment in 1 mph (1 km/h) increments

Faster

- ▶ Briefly tip the cruise control lever in the direction of arrow **1**.

Slower

- ▶ Briefly tip the cruise control lever in the direction of arrow **2**.

Distronic*

When activated, the DISTRONIC adaptive cruise control system increases the driving convenience afforded by the cruise control during travel on expressways and other major roads.

- If the DISTRONIC distance sensor detects a slower moving vehicle directly ahead, your vehicle speed will be reduced so that you follow that vehicle at a preset distance.
- If there is no vehicle directly ahead of you, DISTRONIC will function in the same way as cruise control (▷ page 168).

Warning!

DISTRONIC adaptive cruise control is no substitute for active driving involvement. It does not react to stationary objects, nor recognize or predict the curvature and lane layout or the movement of vehicles ahead. DISTRONIC can only apply a maximum of 20% of the vehicle's braking power.

It is the driver's responsibility at all times to be attentive to road, weather and traffic conditions and to provide the steering, braking and other driving inputs necessary to retain control of the vehicle.

Warning!

DISTRONIC is a convenience system, its speed adjustment reduction capability is intended to make cruise control more effective and usable when traffic speeds vary. It is not however, intended to, nor does it, replace the need for extreme care. The responsibility for the vehicle speed and the distance to the vehicle ahead, including most importantly brake operation to assure safe stopping distance, always rests with the driver.

DISTRONIC cannot take street and traffic conditions into account.

Warning!

DISTRONIC requires familiarity with its operational characteristics. We strongly recommend that you review the following information carefully before operating the system.



For operation in the USA only: This device complies with Part 15 of the FCC Rules. Operation is subject to the following two conditions:

- This device may not cause harmful interference, and
- this device must accept any interference received, including interference that may cause undesired operation.

Any unauthorized modification to this device could void the user's authority to operate the equipment.

Driving systems

Warning!



Distronic cannot take street and traffic conditions into account. Only use Distronic if the weather and traffic conditions make it advisable to travel at a steady speed.

Warning!



Use of Distronic can be dangerous on slippery roads. Rapid changes in tire traction can result in wheel spin and loss of control. Distronic does not act upon adverse sight distance conditions. Do not use Distronic during conditions of fog and heavy rain, snow or sleet.

Warning!



Close attention to road and traffic conditions is imperative at all times, regardless of whether or not Distronic is activated.

Use of Distronic can be dangerous on winding roads or in heavy traffic because conditions do not allow safe driving at a steady speed.

Distronic will not react to stationary objects in the roadway (e.g. a stopped vehicle in a traffic jam or a disabled vehicle). Distronic will also not respond to oncoming vehicles.

Switch off Distronic:

- when changing from the left to the right lane if vehicles are moving more slowly in the left lane
- when entering a turn lane or highway off ramp
- in complex driving situations, such as in highway construction zones

In these situations, Distronic will continue to maintain the set speed unless deactivated.

Distronic is designed and intended only to maintain a set speed and keep a set distance from moving objects in front of it.

Warning!



The “Resume” function should only be operated if the driver is fully aware of the previously set speed and wishes to resume this particular preset speed.

Distronic displays in the speedometer dial

If Detricon detects a vehicle directly ahead, the DTR indicator lamp  in the speedometer dial lights up white.

If the distance to the vehicle ahead is too small for the DTR to be able to maintain the preset distance, the DTR warning lamp  in the speedometer lights up red.

If Detricon calculates that there is a danger of collision

- the DTR warning lamp  in the speedometer lights up red
- an intermittent warning sounds
- ▶ Immediately brake the vehicle to avoid a collision.

Under no circumstances should the driver await the intermittent warning sound before braking. See warning note to the right.

The intermittent warning sound ceases and the red DTR warning lamp  goes out when the necessary distance to the vehicle ahead is again established.



1 Red DTR warning lamp 

Warning!



An intermittent warning sounds and the DTR warning lamp (red) in the speedometer dial is illuminated if the Detricon system calculates that the distance to the vehicle ahead and your vehicle's current speed indicate that Detricon will not be capable of slowing the vehicle sufficiently to maintain the preset following distance, which creates a danger of a collision.

Immediately brake the vehicle to increase the distance to the vehicle in front of you. The warning sound is intended as a final caution that you have not interceded with your own braking inputs to avoid a potentially dangerous situation. Do not wait for the operation of the warning signal to intercede with your own braking, as that will result in potentially dangerous emergency braking which will not always result in an impact being avoided.

Tailgating increases the risk of an accident.

Warning!



The Distronic brakes your vehicle with a maximum of 6.5 ft/s^2 (2 m/s^2). This corresponds to about 20% of the maximum deceleration ability of your vehicle.



Distronic brakes the vehicle in an effort to restore the preset distance or to maintain the speed. The brake pedal is automatically applied as this happens which results in the brake pedal moving.

Keep driver's foot area clear at all times, including the area under the brake pedal. Objects stored in this area may impair pedal movement which could interfere with the braking ability of the Distronic system.

Do not place your foot under the brake pedal – your foot could become caught.

Distronic menu in the control system

In the Distronic menu you can read the current settings for Distronic. What appears in the left display field depends on whether the Distronic is turned on or off.

- ▶ Press button  or  repeatedly until you see one of the following displays.

Distronic deactivated

When Distronic is deactivated you will see the standard display in the left display field.

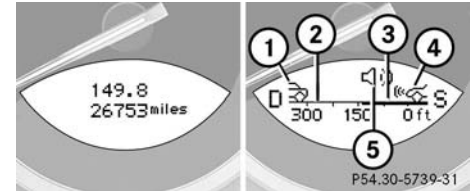

- 1 Vehicle ahead, if detected
- 2 Actual distance to vehicle ahead
- 3 Should-be distance to vehicle ahead
- 4 Your vehicle
- 5 Symbol for activated distance warning function

Distronic activated

When Disticronic is activated the DTR symbol and the set speed are seen in the left display.

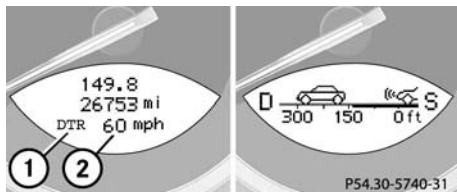

- 1 Symbol for activated Disticronic
- 2 Set speed

Cruise control lever

The Disticronic system is operated by means of the cruise control lever.

The cruise control lever is the uppermost lever found on the left-hand side of the steering column.

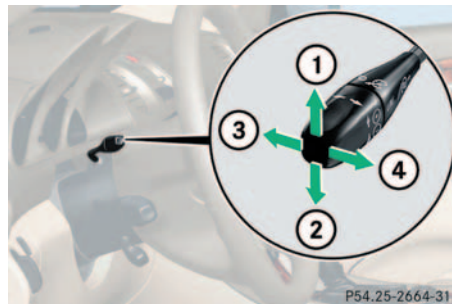

- 1 Set current or higher speed
- 2 Set current or lower speed
- 3 Deactivate Disticronic
- 4 Resume at previously set speed

Activating Disticronic

You can activate Disticronic if

- you are driving over 25 mph (Canada: 40 km/h)
- ESP is activated (▷ page 70)

When Disticronic is activated the speedometer display will show a message such as DTR 60 mph.

If Disticronic is deactivated, the speedometer display will show the message DTR --- mph.

In the following cases you cannot activate Disticronic:

- up to two minutes after starting the engine
- when you brake
- if you have set the parking brake
- if the gear selector lever is in position **P**, **R** or **N**.



1 Set speed

2 White DTR indicator lamp 



The vehicle speed displayed on the speedometer can briefly vary from the speed setting on the distronic system.

Setting the current speed

- ▶ Accelerate or decelerate to the desired speed.
- ▶ Briefly lift or depress the cruise control lever.

The current speed is set.

- ▶ Remove your foot from the accelerator pedal.



If you do not take your foot off of the accelerator completely, the following message will appear in the speedometer display field:

DTR override. The distance to a slower moving vehicle in front of you will not be set. Your vehicle speed will then be determined only by the accelerator pedal position.

Setting a higher speed

- ▶ Lift the cruise control lever to position 1 (▷ page 175) and hold it up until the desired speed is reached.
- ▶ Release the cruise control lever.

The new speed is set.



Depressing the accelerator pedal does not deactivate DISTRONIC. After brief acceleration (e.g. for passing), the cruise control will resume the last speed set.

Setting a lower speed

- ▶ Depress the cruise control lever to position **2** (▷ page 175) and hold it down until the desired speed is reached.
- ▶ Release the cruise control lever.

The new speed is set.



When you use the cruise control lever to decelerate, the transmission will automatically downshift if the rate of deceleration is too low.

Fine adjustment in 5 mph (Canada: 10 km/h) increments

Faster

- ▶ Briefly tip the cruise control lever in the direction of arrow **1** (▷ page 175).

Slower

- ▶ Briefly tip the cruise control lever in the direction of arrow **2** (▷ page 175).

Fine adjustment in 1 mph (Canada: 1 km/h) increments

Faster

- ▶ Briefly tip the cruise control lever in the direction of arrow **4** (▷ page 175).

or

- ▶ Pull and hold the cruise control lever in the direction of arrow **4** (▷ page 175) and hold it until you reach the desired speed.

Resetting stored speeds

Warning!



The speed stored in memory should only be set again if prevailing road conditions permit. Possible acceleration or deceleration differences arising from returning to the pre-set speed could endanger yourself and others.

- ▶ Briefly tip the cruise control lever in the direction of arrow **4** (▷ page 175).
Distronic is set to the last stored speed.
- ▶ Remove your foot from the accelerator pedal.

Driving systems

Deactivating Distronic

There are several ways to deactivate the Distronic system:

- ▶ Briefly tip the cruise control lever in the direction of arrow **3** (▷ page 175).

or

- ▶ Step on the brake pedal.

Distronic will be deactivated. The last speed set will be stored into memory.



The last stored speed is deleted when you turn off the engine.

Distronic deactivates automatically when

- you set the parking brake
- you drive slower than 25 mph (Canada: 40 km/h)
- ESP is active (▷ page 70) or you deactivate ESP
- You move the transmission selector lever into position **N**.

A signal will sound. The *DTR off* message appears in the speedometer display for approximately five seconds.

Warning!



Distronic switches off and releases the brakes when the vehicle decelerates below the minimum speed of 25 mph (40 km /h) by operation of the system. At that time the driver must apply the brakes in order to reduce vehicle speed further or bring it to a stop.

Setting the following distance in Distronic

You can set the specified following for Distronic by varying the time setting between 1.0 and 2.0 seconds. Using this time setting and the current speed of your vehicle, Distronic calculates and sets the required following distance to the vehicle ahead. The set distance will be shown in the speedometer display field.

The thumbwheel for making the time setting is located on the lower section of the center console.

Warning!



It is up to the driver to exercise discretion to select the appropriate setting given road conditions, traffic, driver's preferred driving style and applicable laws and driving recommendations for safe following distance.



- 1 Distance warning function on/off switch
- 2 Thumbwheel for setting distance

Increasing distance

Increasing the distance setting tells Distronic to maintain a greater following distance to the vehicle ahead.

- ▶ Turn thumbwheel **2** towards .

Decreasing distance

Decreasing the distance setting tells Distronic to maintain a smaller following distance to the vehicle ahead.

- ▶ Turn thumbwheel **2** towards .

Distance warning function

When Distronic is deactivated, this function will continue to warn you if you are following too close to the vehicle ahead:

- The DTR warning lamp  lights up red.
- An intermittent warning will sound if necessary.

If these warnings are issued, you must brake manually to maintain a safe distance and avoid a collision with the vehicle ahead.

Warning!



If the DTR warning lamp (red)  in the speedometer dial lights up while driving and/or an intermittent warning sounds, immediate attention on the part of the driver is required.

As required by the traffic situation, apply the brakes and navigate around a possible obstacle. However, do not drive by relying on the distance warning function, as this will result in an emergency braking application. Especially depending on road surface conditions and driver reaction, this will not always enable you to avoid a collision.



Complex driving situations are not always fully recognized by Distronic. This could result in wrong or missing distance warnings.

Activating

- ▶ Press switch **1**.

The indicator lamp on the switch lights up. A loudspeaker symbol appears in the speedometer display (▷ page 174).

Deactivating

- ▶ Press switch **1**.

The indicator lamp on the switch goes out. No loudspeaker symbol appears in the speedometer display.

Driving with Distronic

This section describes a number of driving situations where special precaution is required on the part of the driver. Be prepared to brake in such situations. This will deactivate the Distronic system.

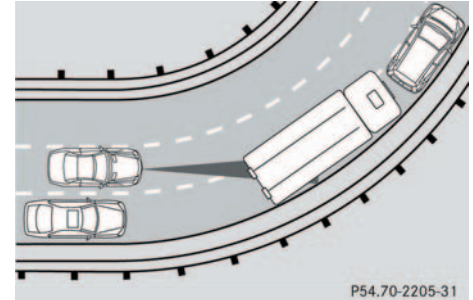
Turns and bends

In turns or bends, Distronic may not detect a moving vehicle in front, or it may detect one too soon. This may cause your vehicle to brake late or unexpectedly.

Warning!

Distronic works to maintain the speed selected by the driver unless a moving obstacle proceeding directly ahead of it in the same travel direction is detected (e.g. following another vehicle ahead of you at a distance set by Distronic). This means that:

- Your vehicle can pass another vehicle after you change lanes.
- While in a sharp turn or if the vehicle in front is in a sharp turn, Distronic could lose sight of a vehicle traveling in front of it. Your vehicle could then accelerate to the previously selected speed.

Distronic regulates only the distance between your vehicle and those directly ahead of it, but does not register stationary objects in the road, e.g.:

- a stopped vehicle in a traffic jam
- a disabled vehicle
- an oncoming vehicle

The driver must always be on the alert, observe all traffic and intercede as required by steering or braking the vehicle.

Warning!

Distronic should not be used in snowy or icy road conditions.

The most likely cause for a malfunctioning system is a dirty sensor (located behind the hood grill), especially at times of snow and ice or heavy rain. In such a case, Distronic will switch off, and the message **DISTRONIC - CLEAR SENSOR!** appears in the multifunction display.

For cleaning and care of the Distronic sensor, see “Cleaning the Distronic* system sensor cover” (▷ page 246).

Driving systems

Offset driving

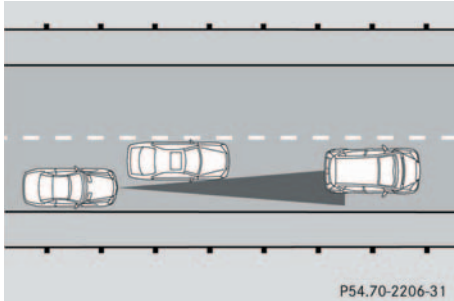

A vehicle traveling in your lane but offset from your direct line of travel may not be detected by DISTRONIC. There will be insufficient distance to the vehicle ahead.

Lane changing

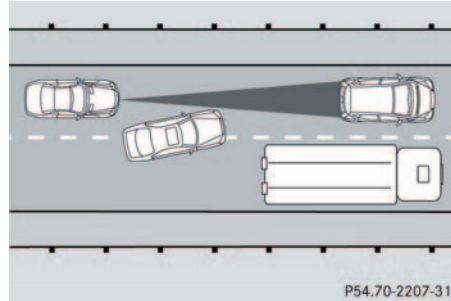

DISTRONIC has not yet detected the vehicle changing lanes. There will be insufficient distance to the vehicle ahead.

Narrow vehicles

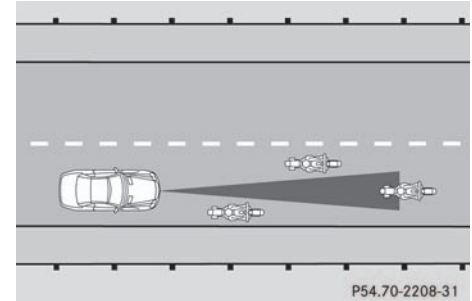

Because of its narrow profile, the vehicle traveling near the edge of the roadway has not yet been detected by DISTRONIC. There will be insufficient distance to the vehicle ahead.

Active Body Control (ABC)

The ABC system automatically selects the optimum suspension tuning and ride height for your vehicle.

Suspension tuning

The suspension tuning is set according to:

- Your driving style
- Road surface conditions
- The vehicle loading
- Your choice of suspension style, “sporty” or “regular”, which you select using the ABC switch.

The selected suspension style is stored in memory, even after the key is removed from the starter switch.

The ABC switch with the indicator lamp is located in the lower section of the center console.



- 1 ABC switch
- 2 Indicator lamp

- ▶ Start the engine.

Suspension for sporty driving style

The setting for sporty driving is selected when the indicator lamp **2** is illuminated.

- ▶ Press switch **1**.
- The indicator lamp **2** comes on.

Suspension for regular driving style

The setting for regular driving is selected when the indicator lamp **2** is off.

- ▶ Press switch **1**.
- The indicator lamp **2** goes out.

Driving systems

Vehicle level control

Your vehicle automatically adjusts its ride height to:

- reduce fuel consumption
- increase vehicle safety

The vehicle chassis ride height is raised or lowered according to the selected level setting and to the vehicle speed:

- With increasing speed, ride height is reduced by up to approximately one inch (25 mm).
- With decreasing speed, the ride height is again raised to the selected vehicle level.



These height adjustments are so small that you may not notice any change.

Select the level 1 and 2 settings only when required by current driving conditions.

Otherwise:

- Fuel consumption may increase.
- Handling may be impaired.

Warning!



To help avoid personal injury, keep hands and feet away from wheel housing area, and stay away from under the vehicle when lowering the vehicle chassis.

The following vehicle level settings can be selected when the vehicle is stationary:

Vehicle level when stationary	Use for	Height increase over normal	Automatic lowering	Indicator lamps (▷ page 185)
Normal	Normal operation	None	Max. approx. 0.5 in (12 mm)	Both lamps off
Level 1	Driving with snow chains (▷ page 240)	Max. 0.6 in (15 mm) ¹	Max. approx. 0.6 in (15 mm)	One lamp on
Level 2	Very rough road surface conditions	Max. 1.0 in (25 mm) ¹	Max. approx. 1.0 in (25 mm)	Both lamps on

¹ Dependent on loading

The switch and the indicator lamps are located in the lower section of the center console.

- ▶ Briefly press switch **3** to change from one level setting to the next.

At level 1, indicator lamp **2** is illuminated and at level 2 both indicator lamps are illuminated. When the vehicle is at level 2, pressing the switch will return the vehicle to normal level.



- 1 Indicator lamp 1
- 2 Indicator lamp 2
- 3 Vehicle level control switch



Pressing the switch twice in quick succession will cause the vehicle to immediately raise or lower to the new vehicle level as selected.

The selected vehicle level setting remains stored in memory even if the engine is turned off and restarted.

Driving systems

Parktronic system*

Warning!



Parktronic is a supplemental system. It is not intended to, nor does it replace, the need for extreme care. The responsibility during parking and other critical maneuvers always rests with the driver.

Special attention must be paid to objects with smooth surfaces or low silhouettes (e.g. trailer couplings, painted posts, or road curbs). Such objects may not be detected by the system and can damage the vehicle.

The operational function of the Parktronic can be affected by dirty sensors, especially at times of snow and ice. See Cleaning the Parktronic system sensors (▷ page 246).

Interference caused by other ultrasonic signals (e.g. working jackhammers or the air brakes of trucks) can cause the system to send erratic indications, and should be taken into consideration.

Warning!



Make sure that no persons or animals are in the area in which you are maneuvering. Otherwise you run the risk of causing injury.

The Parktronic system is an electronic aid designed to assist the driver during parking maneuvers. It visually and audibly indicates the relative distance between the vehicle and an obstacle.

The Parktronic system is automatically activated when you switch on the ignition and release the parking brake. The Parktronic system deactivates at speeds over 11 mph (18 km/h). At lower speeds the Parktronic system turns on again.

The Parktronic system monitors the surroundings of your vehicle with six sensors in the front bumper and four sensors in the rear bumper.

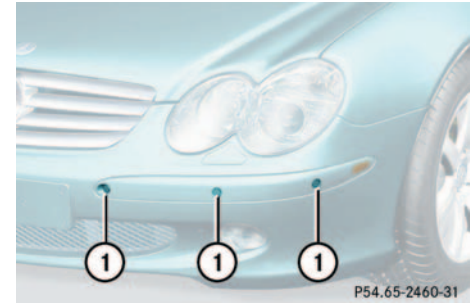

1 Sensors in the front bumper

Range of the sensors

To function properly, the sensors must be free of dirt, ice snow and slush. Clean the sensors regularly, being careful not to scratch or damage the sensors.

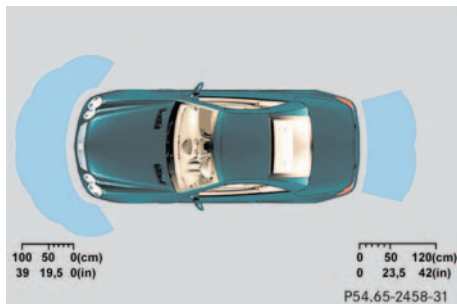

Front sensors

Center	approx. 40 in (100 cm)
Corners	approx. 48 in (120 cm)

Rear sensors

Center	approx. 48 in (120 cm)
Corners	approx. 32 in (80 cm)



During parking maneuvers, pay special attention to objects located above or below the height of the sensors (e.g. planters or trailer hitches). The Parktronic system will not detect such objects at close range and damage to your vehicle or the object may result.

Ultrasonic signals from outside sources (e.g. truck air brakes or jackhammers) may impair the operation of the Parktronic system.

Minimum distance

Center	approx. 8 in (20 cm)
Corners	approx. 6 in (15 cm)

If you encounter an obstacle in this range, all the warning lamps light up and you hear a warning signal. If the obstacle is closer than the minimum distance, the actual distance may no longer be indicated by the system.

Warning indicators

Visual signals indicate to the driver the relative distance between the sensors and an obstacle. The warning indicator for the front area is located above the center air vents in the dashboard. The warning indicator for the rear area is integrated in the rear trim.

Driving systems



Front area warning indicator

- 1 Left side of the vehicle
- 2 Right side of the vehicle

Each warning indicator is divided into six yellow and two red segments for either side of the vehicle. The Parktronic system is ready when the border around the indicator is illuminated.

The position of the gear selector lever determines which warning indicators will be activated.

Selector lever position	Warning indicator
D	Front area activated
R or N	Rear area activated
P	Neither activated

As your vehicle approaches an object, one or more segments will light up, depending on the distance. When the eighth segment lights, you have reached the minimum distance.

- Front area: An intermittent acoustic warning will sound as the seventh segment lights up and a constant acoustic warning lasting a maximum of three seconds will sound for the eighth segment.

- Rear area: An intermittent acoustic warning will sound when the first segment lights up. This signal quickens with each additional segment lit. When the eighth segment illuminates, the acoustic warning becomes a constant signal. The signal is canceled when the selector lever is placed in position **D** or **P**.

Switching the Parktronic system on/off

You can switch off the Parktronic system manually.

The Parktronic switch is located in the lower section of the center console.



- 1 Parktronic on/off switch
- 2 Indicator lamp

Switching off the Parktronic system

- ▶ Press switch **1**.

The indicator lamp **2** comes on.

Switching on the Parktronic system

- ▶ Press switch **1** again.

The indicator lamp **2** goes out.

Parktronic malfunction

There is a malfunction in the Parktronic system if the red segments of the Parktronic warning indicator light up and a warning sounds. The Parktronic system will switch itself off after 30 seconds and the indicator lamp on the Parktronic switch lights up.

- ▶ Have the Parktronic system checked by an authorized Mercedes-Benz Center as soon as possible.

If only the red segments of the Parktronic warning indicator light up and no warning sounds, then the sensors of the Parktronic system are dirty or malfunctioning. Malfunction may also be caused by interference from other radio or ultrasonic signals. The Parktronic system will switch itself off after 20 seconds.

- ▶ Clean Parktronic system sensors (▷ page 246).
- ▶ Switch on the ignition.
or
- ▶ Check Parktronic operation at another location to rule out interference from outside radio or ultrasonic signals.

Useful features

Useful features

Interior storage spaces

Warning!



To help avoid personal injury during a collision or sudden maneuver, exercise care when stowing objects in the vehicle. Put luggage or cargo in the trunk if possible. Do not pile luggage or cargo higher than the seat backs. Do not place anything on shelf behind roll bar.

Parcel nets cannot secure hard or heavy objects.

Warning!



Keep compartment lids closed. This will help to prevent stored objects from being thrown about and injuring vehicle occupants during an accident.

Glove box

An AUX socket to the audio system for portable audio devices is installed in the glove box.

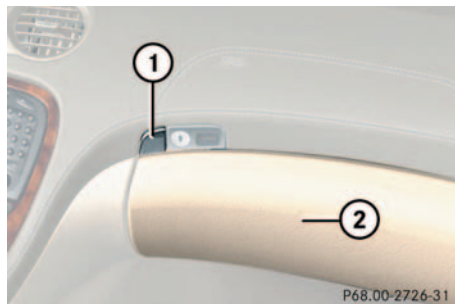

- 1 Button to open
- 2 Glove box

Opening the glove box

- ▶ Press button 1.

The glove box lid opens downward.

Closing the glove box

- ▶ Push lid up to close.

Cup holders



- 1 Left cup holder
- 2 Right cup holder

Opening

- ▶ Briefly press cup holder cover.

The cup holder opens automatically.

Warning!

When not in use, keep the cup holder closed. Place only containers that fit into the cup holder to prevent spills. Use lids on open containers and do not fill containers to a height where the contents, especially hot liquids, could spill during vehicle maneuvers.

Auxiliary cup holder

You can fasten the auxiliary cup holder onto the left front side of the passenger seat.

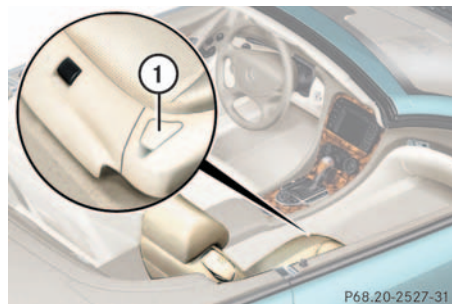
Inserting the auxiliary cup holder**1** Cover

- ▶ Pull up the cover and place it in a storage compartment.

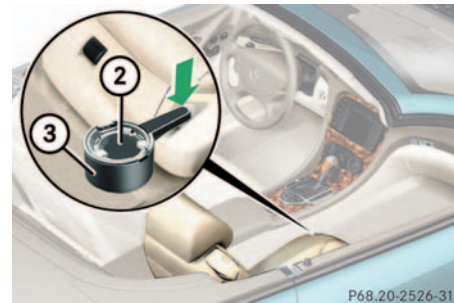
**2** Auxiliary cup holder**3** Insert

- ▶ Press the auxiliary cup holder **2** in the direction of the arrow until it snaps in place.

You can now place a larger container in the holder. For even larger containers you can take out the insert **3**. Make sure that the container does not press against the glove box.

Useful features

Warning!



When not in use, remove the auxiliary cup holder. Place only containers that fit into the auxiliary cup holder to prevent spills. Use lids on open containers and do not fill containers to a height where the contents, especially hot liquids, could spill during vehicle maneuvers.



When you move the seat forward, the auxiliary cup holder turns to the side.

When you move the seat back, turn the auxiliary cup holder back until it stops in its original position.

Removing the auxiliary cup holder

- ▶ Pull the auxiliary cup holder **2** (▷ page 191) up and out of the receptacle and place it in a storage compartment.
- ▶ Replace the cover **1** (▷ page 191) on the opening and press it down until it snaps in place.

Door storage compartments

Warning!



Keep the door storage compartments closed while vehicle is in motion. Failure to do so may cause the seat belt to catch at the rear and prevent proper positioning of the seat belt.

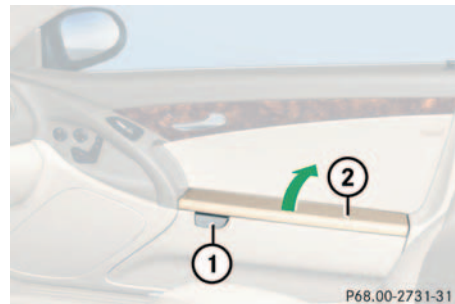

- 1** Release button
- 2** Lid

Opening

- ▶ Press the release button.
The lid opens upwards.

Armrest storage spaces

The buttons are located under the cushion of the armrest.

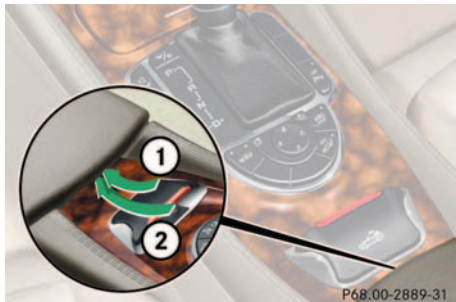

- 1 Button to open storage tray
- 2 Button to open storage compartment

Opening storage tray

- ▶ Press button **1** and lift up the armrest.

Opening storage compartment

- ▶ Press button **2** and lift the armrest.

Locking the storage spaces

The storage spaces are centrally locked when you lock the vehicle from the outside.

You can also lock the storage spaces separately, see “Locking the storage compartments separately” (▷ page 194).

Rear storage compartments

The CD changer is located in the left storage compartment.

For instructions on the CD changer, see separate COMAND Operator’s Manual.

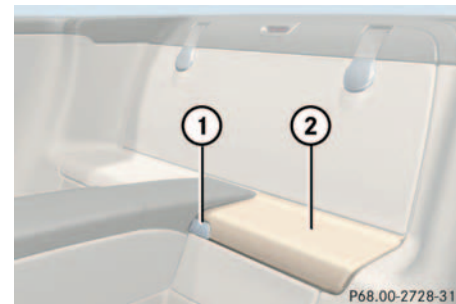

- 1 Release button
- 2 Lid

- ▶ Press the release button.
The lid opens upwards.

Useful features

Locking the storage compartments separately

You can lock the storage compartments separately, e.g. when the vehicle is in the shop for service.

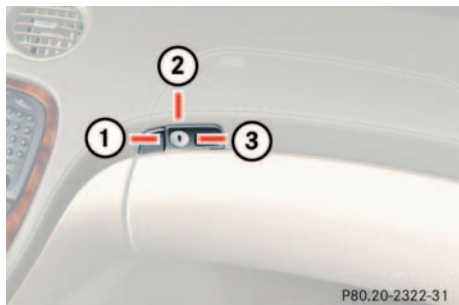

- 1 Separately unlock storage compartments
 - 2 Centrally lock/unlock storage compartments
 - 3 Separately lock storage compartments
- ▶ Slide mechanical key out of key housing (▷ page 290).

- ▶ Insert the mechanical key into the glove box lock and turn it to position **3**.

The following storage areas will be locked. They can then not be opened with the key or with the KEYLESS-GO* card:

- Glove box
- Armrest storage spaces
- Rear storage compartments



The separate locking status of these storage compartments can only be canceled by means of the mechanical key.

The storage compartments in the doors cannot be locked.

Unlocking the storage compartments separately

- ▶ Turn the mechanical key in the glove box lock to position **1**.

You can now open the storage compartments.

Parcel net in passenger footwell

Warning!



Do not place heavy or fragile objects, or objects having sharp edges, in the parcel net.

In an accident, during hard braking or sudden maneuvers, they could be thrown around inside the vehicle, and cause injury to vehicle occupants.

Parcel net in trunk

There are three nets available in the trunk to secure loads:

- a pocket net on each side of the right and left trunk side walls
- a trunk floor net
- ▶ Pull the trunk floor net from the trunk back wall towards the front over the luggage.
- ▶ Hang the hooks of the net on the eyes on the trunk floor.

Luggage compartment in the rear

Warning!



Secure all pieces of luggage in the rear with the luggage straps. Unsecured pieces of luggage can otherwise cause injury during a braking maneuver and can increase the risk of injury in an accident.

Never allow anyone to ride in the rear.

The luggage straps can only secure light luggage items. Carry heavy pieces of luggage in the trunk.

The rear compartment area is not designed or intended to accommodate occupants. Severe personal injury or death may result in an accident.

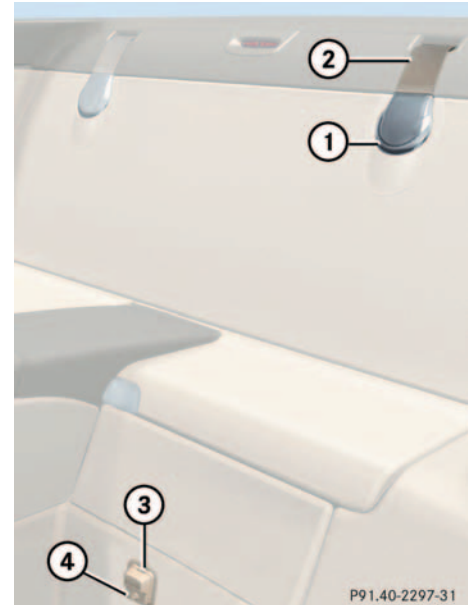

- 1 Holder
- 2 Strap
- 3 Latch
- 4 Release button

P91.40-2297-31

Useful features

- ▶ Pull the strap **2** out of the holder **1**.
- ▶ Secure the luggage with the strap so that it cannot move.
- ▶ Insert the strap in the latch **3**.

Releasing the strap

- ▶ Press the release button **4** and guide the strap back to the holder.

Warning!



The shelf below the rear window should not be used to carry objects. This will avoid such objects from being thrown about and injuring vehicle occupants during an accident or sudden maneuver.

The trunk is the preferred place to carry objects.

Ashtray



- 1** Cover plate
- 2** Sliding knob

Opening ashtray

- ▶ Briefly touch the cover plate **1**.
The ashtray opens automatically.

Removing the ashtray insert

Warning!



Remove ashtray only with vehicle standing still. Set the parking brake to secure vehicle from movement. Move gear selector lever to position **N**. With gear selector lever in position **N**, turn off the engine.

- ▶ Secure vehicle from movement by setting the parking brake. Move the selector lever to position **N**.

Now you have more room to take out the insert.

- ▶ Press the sliding knob **2** to the right. The insert will eject a short distance.

Replacing the ashtray insert

- ▶ Press the insert into the frame until it snaps into place.

Cigarette lighter

The lighter socket can be used to accommodate electrical accessories up to a maximum of 180 W.



1 Cigarette lighter

- ▶ Switch on the ignition.
- ▶ Push in the cigarette lighter 1.

The lighter will pop out automatically when hot.

Warning!



Never touch the heating element or sides of the lighter; they are extremely hot. Hold the knob only.

When leaving the vehicle always remove the key from the starter switch. Do not leave children unattended in the vehicle, or with access to an unlocked vehicle. Unsupervised use of vehicle equipment may cause serious personal injury.

Heated steering wheel* (Canada only—model SL 500)

The steering wheel heating warms up the leather area of the steering wheel.

The lever is on the lower left-hand side of the steering wheel.

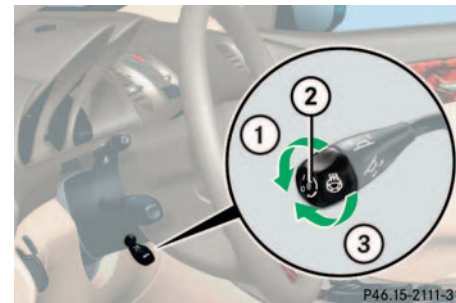

- 1 Switching on
- 2 Indicator lamp
- 3 Switching off

Useful features

Switching on

- ▶ Make sure that the ignition is switched on.
All the lamps in the instrument cluster should light up.
- ▶ Turn lever in the direction of arrow **1**.
The steering wheel is heated. Indicator lamp **2** lights up.

Switching off

- ▶ Turn lever in the direction of arrow **3**.
The steering wheel heating is turned off. Indicator lamp **2** goes out.



The steering wheel heating does not turn off automatically.

Easy-Pack load assist in the trunk

To facilitate trunk loading after opening the lid, use the Easy-Pack feature to raise the retracted hardtop from its storage position in the trunk.

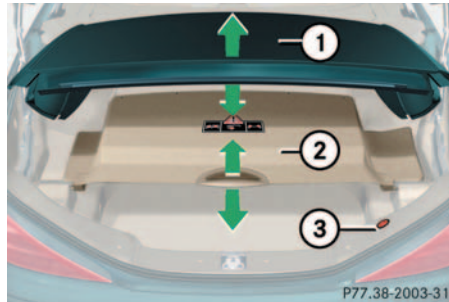

- 1** Retracted hardtop
- 2** Luggage cover
- 3** Easy-Pack button

Raising the hardtop

Warning!



To prevent injuries, make sure that there is no possibility of body parts getting caught in moving parts. If potential danger exists, press the switch again. This will immediately stop the movement of the hardtop.

The hardtop can only be raised when the luggage cover is closed and the trunk lid is completely opened.

- ▶ Press button **3**.

The hardtop rises a short distance. Button **3** lights up brightly. You can now open the luggage cover.

Lowering the hardtop

The hardtop can only be lowered when the luggage cover is closed and the trunk lid is completely opened.

- ▶ Close the luggage cover.
- ▶ Press button **3**.

The hardtop lowers. Button **3** is dimly lit.



Only close the trunk if the roof is completely lowered. Otherwise you could damage the hardtop.

If you begin to close the trunk lid before the hardtop is completely lowered, the button **3** will blink and a warning will sound.

Electrical outlet

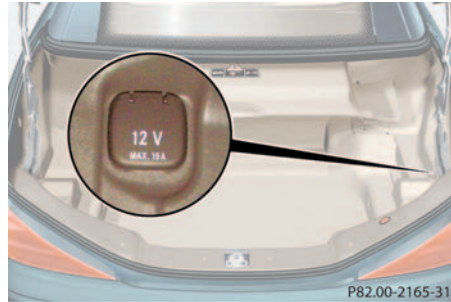

An electrical outlet is located on the right side of the trunk.

- ▶ Turn the key in the starter switch to position **1** or **2**.
- ▶ Flip up cover and insert electrical plug (cigar lighter type).



The electrical outlet can be used to accommodate electrical consumers (e.g. air pump, auxiliary lamps) up to a maximum of 180 W.

Telephone*

Warning!



Never operate radio transmitters equipped with a built-in or attached antenna (i.e. without being connected to an external antenna) from inside the vehicle while the engine is running. Doing so could lead to a malfunction of the vehicle's electronic system, possibly resulting in an accident and/or serious personal injury.

Radio transmitters, such as a portable telephone or a citizens band unit, should only be used inside the vehicle if they are connected to an antenna that is installed on the outside of the vehicle.

The external antenna must be approved by Mercedes-Benz. Please contact an authorized Mercedes-Benz Center for information on the installation of an approved external antenna. Refer to the radio transmitter operation instructions regarding use of an external antenna.

Warning!





Please do not forget that your primary responsibility is to drive the vehicle. A driver's attention to the road must always be his/her primary focus when driving. For your safety and the safety of others, we recommend that you pull over to a safe location and stop before placing or taking a telephone call.

If you choose to use the telephone¹ while driving, please use the hands-free device and only use the telephone when road, weather, and traffic conditions permit. Some jurisdictions prohibit the driver from using a cellular telephone while driving a vehicle.

Only operate the COMAND (Cockpit Management and Data System)¹ if road, weather, and traffic conditions permit.

¹ Observe all legal requirements

Bear in mind that at a speed of just 30 mph (approximately 50 km/h), your vehicle is covering a distance of approximately 44 feet (approximately 13.5 m) every second.

You can take and place telephone calls using the  and  buttons on the steering wheel. To carry out other telephone functions, use the control system (▷ page 133).

See separate instruction manual for instructions on how to operate the telephone.

Tele Aid



The initial activation of the Tele Aid system may only be performed by completing the subscriber agreement and placing an acquaintance call using the SOS button. Failure to complete either of these steps will result in a system that is not activated. If the system is not activated the indicator lamp in the SOS button stays on after turning key in starter switch to position **2**, or pressing KEYLESS-GO* start/stop button (if so equipped) twice to position **2** (▷ page 30) and the message *Tele Aid not activated* will be shown in the multifunction display for approx. 10 seconds.

If you have any questions regarding activation, please call the Response Center at 1-800-756-9018 (in the USA) or 1-888-923-8367 (in Canada).



The Tele Aid system



(Telematic Alarm Identification on Demand)

The Tele Aid system consists of three types of response:

- automatic and manual emergency
- roadside assistance and
- information.



The Tele Aid system is operational providing that the vehicle's battery is charged, properly connected, not damaged and cellular and GPS coverage is available.

The speaker volume of a Tele Aid call can be adjusted when using the volume control on the multifunction steering wheel. To raise, press button  and to lower, press button .

- ▶ To activate, press the SOS button, the Roadside Assistance button  or the Information button , depending on the type of response required.



The SOS button is located above the inside rear view mirror.



The Roadside Assistance button  and the Information button  are located below the center armrest cover.

Shortly after the completion of your Acquaintance Call, you will receive a user ID and password via first call mail. By visiting www.mbusa.com and selecting "Tele Aid" (USA only), you will have access to account information, remote door unlock, and more.



The Tele Aid system utilizes the cellular network for communication and the GPS (Global Positioning System) satellites for vehicle location. If either of these signals are unavailable, the Tele Aid system may not function and if this occurs, assistance must be summoned by other means.

System self-check

Initially, after turning the key in the starter switch to position 2, malfunctions are detected and indicated (the indicator lamps in the SOS button, the Roadside Assistance button  and the Information button  stay on longer than 10 seconds or do not come on). The message *Tele Aid - Visit workshop!* appears for approx. 10 seconds in the multifunction display.

Warning!



If the indicator lamps in the SOS button, in the Roadside Assistance button, and/or in the Information button do not come on during the system self-check, or if any of these indicators remain illuminated continuously in red and/or the message **TELE AID - VISIT WORKSHOP!** is displayed in the multifunction display after the system self-check, a malfunction in the system has been detected.

If a malfunction is indicated as outlined above, the system may not operate as expected. Have the system checked at the nearest Mercedes-Benz Center as soon as possible

Emergency calls

An emergency call is initiated automatically:

- following an accident in which the emergency tensioning devices (ETDs) or airbags deploy,
- if the anti-theft alarm or the tow-away alarm stays on for more than 20 seconds. See anti-theft alarm system (▷ page 75) and tow-away alarm (▷ page 77).

An emergency call can also be initiated manually by opening the cover next to the inside rear view mirror labeled SOS, then briefly pressing the button located under the cover. See below for instructions on initiating an emergency call manually.

Once the emergency call is in progress, the indicator lamp in the SOS button will begin to flash. The message **Emergency call - Connecting call** appears in the multifunction display. When the connection is established, the message **Emergency call - Call connected** appears in the multifunction display. All information relevant to the emergency, such as the location of the vehicle (determined by the GPS satellite location system), vehicle model, identification number and color are generated.

A voice connection between the Response Center and the occupants of the vehicle will be established automatically soon after the emergency call has been initiated. When a voice connection is established the audio system mutes and the message **Tele Aid Emergency call active** appears in the multifunction display. The Response Center will attempt to determine more precisely the nature of the accident provided they can speak to an occupant of the vehicle.

The Tele Aid system is available if:

- it has been activated and is operational. Activation requires a subscription for monitoring services, connection and cellular air time
- the relevant cellular phone network and GPS signals are available and pass the information on to the response center.



Location of the vehicle on a map is only possible if the vehicle is able to receive signals from the GPS satellite network and pass the information on to the response center.

Warning!



If the indicator lamp in the SOS button is illuminated continuously and there was no voice connection to the Response Center established, then the Tele Aid system could not initiate an emergency call (e.g. the relevant cellular phone network is not available). The message **Emergency call - Call failed** appears in the multifunction display for approx. 10 seconds.

Should this occur, assistance must be summoned by other means.

Initiating an emergency call manually

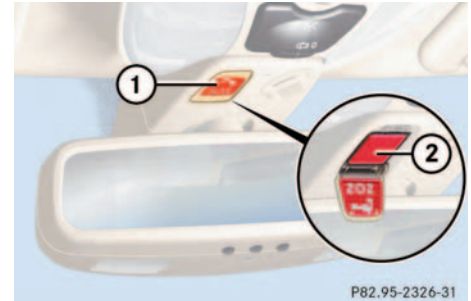

1 Cover

2 SOS button

- ▶ Briefly press on cover **1**.
The cover will open.
- ▶ Press the SOS button **2** briefly.
The indicator lamp in the SOS button **2** will flash until the emergency call is concluded.
- ▶ Wait for a voice connection to the Response Center.
- ▶ Close the cover **1** after the emergency call is concluded.

Warning!



If you feel at any way in jeopardy when in the vehicle (e.g. smoke or fire in the vehicle, vehicle in a dangerous road location), please do not wait for voice contact after you have pressed the emergency button. Carefully leave the vehicle and move to a safe location. The Response Center will automatically contact local emergency officials with the vehicle's approximate location if they receive an automatic SOS signal and cannot make voice contact with the vehicle occupants.

Roadside Assistance button

Located below the center armrest cover is the Roadside Assistance button

- ▶ Press and hold the button (for longer than 2 seconds)

A call to a Mercedes-Benz Roadside Assistance dispatcher will be initiated. The button will flash while the call is in progress. The message *Roadside assistance - Connecting call* will appear in the multifunction display.

When the connection is established, the message *Roadside assistance - Call connected* appears in the multifunction display. The Tele Aid system will transmit data generating the vehicle identification number, model, color and location (subject to availability of cellular and GPS signals).

A voice connection between the Roadside Assistance dispatcher and the occupants of the vehicle will be established. When a voice connection is established the audio system mutes and the message *Tele Aid Roadside assistance call active* appears in the multifunction display.



- ▶ Describe the nature of the need for assistance.

The Mercedes-Benz Roadside assistance dispatcher will either dispatch a qualified Mercedes-Benz technician or arrange to tow your vehicle to the nearest Mercedes-Benz Center. For services such as labor and /or towing, charges may apply. Refer to the Roadside Assistance manual for more information.

These programs are only available in the USA:

- Sign and Drive services: Services such as jump start, a few gallons of fuel or the replacement of a flat tire with the vehicle spare tire are obtainable,
- Remote Vehicle Diagnostics: This function permits the Mercedes-Benz Roadside Assistance dispatcher to download malfunction codes and actual vehicle data.



The indicator lamp in the Roadside Assistance button  remains illuminated in red for approx. 10 seconds during the system self-check after turning the key in the starter switch to position 2 (together with the SOS button and the Information button ).

See system self-check (▷ page 201) when the indicator lamp does not light up in red or stays on longer than approximately 10 seconds.

If the indicator lamp in the Roadside Assistance button  is illuminated continuously and there was no voice connection to the Response Center established, then the Tele Aid system could not initiate a Roadside Assistance call (e.g. the relevant cellular phone network is not available). The message `Roadside assistance - Call failed` appears in the multifunction display.

Roadside Assistance calls can be terminated using the  button on the multifunction steering wheel.

Information button

Located below the center armrest cover is the Information button .

- ▶ Press and hold the button (for longer than 2 seconds).

A call to the Customer Assistance Center will be initiated. The button will flash while the call is in progress. The message `Info - Connecting call` will appear in the multifunction display.

When the connection is established, the message `Info - Call connected` appears in the multifunction display. The Tele Aid system will transmit data generating the vehicle identification number, model, color and location (subject to availability of cellular and GPS signals).



A voice connection between the Customer Assistance Center representative and the occupants of the vehicle will be established. When a voice connection is established the audio system mutes and the message `Tele Aid - Info call active` appears in the multifunction display.

Useful features

Information regarding the operation of your vehicle, the nearest Mercedes-Benz Center or Mercedes-Benz USA products and services is available to you.

For more details concerning the Tele Aid system, please visit www.mbusa.com and use your ID and password (sent to you separately) to learn more (USA only).



The indicator lamp in the Information button  remains illuminated in red for approx. 10 seconds during the system self-check after turning key in the starter switch to position **2** (together with the SOS button and the Roadside Assistance button .

See system self-check (▷ page 201) when the indicator lamp does not light up in red or stays on longer than approximately 10 seconds.

If the indicator lamp in the Information button  is illuminated continuously and there was no voice connection to the Response Center established, then

the Tele Aid system could not initiate an Information call (e.g. the relevant cellular phone network is not available). The message *Info Call failed* appears in the multifunction display.

Information calls can be terminated using the  button on the multifunction steering wheel.



If the indicator lamps do not start flashing after pressing one of the buttons or remain illuminated (in red) at any time, the Tele Aid system has detected a fault or the service is not currently active, and may not initiate a call. Visit your Mercedes-Benz Center and have the system checked or contact the Response Center at 1-800-756-9018 (in the USA) or 1-888-923-8367 (in Canada) as soon as possible.

Upgrade Signals

The Tele Aid system processes calls using the following priority.

- Automatic emergency – First priority
- Manual emergency – Second priority
- Roadside assistance – Third priority
- Information – Fourth priority

Should a higher priority call be initiated while you are connected, an upgrade (alternating) tone will be heard, and the appropriate indicator lamp will flash. If certain information such as vehicle identification number or customer information is not available, the operator may need to retransmit.

During this time you will hear a beep and voice contact will be interrupted. Voice contact will resume once the retransmission is completed. Once a call is concluded, a beep will be heard and the appropriate indicator lamp will stop flashing. The COMAND system operation will resume.



If the indicator lamp continues to flash or the system does not reset, contact the Response Center at 1-800-756-9018 (in the USA) or 1-888-923-8367 (in Canada), or Mercedes-Benz Customer Assistance at 1-800-FOR-MERCEdes (1-800-367-6372) in the USA or Customer Service at 1-800-387-0100 in Canada.



The indicator lamp in the respective button flashes until the call is concluded. Calls can only be terminated by a Response Center or Customer Assistance representative except Roadside Assistance and Information calls, which can also be terminated by pressing button  on the multifunction steering wheel.



When a Tele Aid call has been initiated, the COMAND system audio is muted and the selected mode (radio or CD) pauses. The optional cellular phone (if installed) switches off. If you must use this phone, the vehicle must be parked. Disconnect the coiled cord and place the call. The navigation system (if engaged) will continue to run. The display in the instrument cluster is available for use and spoken commands are only available by pressing the RPT button on the COMAND unit. A pop-up window will appear in the COMAND display to indicate that a Tele Aid call is in progress.

Remote door unlock

In case you have locked your vehicle unintentionally (e.g. key inside vehicle), and the reserve key is not handy:

- ▶ Contact the Mercedes-Benz Response Center at 1-800-756-9018 (in the USA) or 1-888-923-8367 (in Canada).

You will be asked to provide your password which you provided when you completed the subscriber agreement.

- ▶ Then return to your vehicle and press trunk lock for minimum of 20 seconds until the SOS button is flashing.

The message **Emergency call - Call connected** appears in the multifunction display.

As an alternative, you may unlock the vehicle via Internet using the ID and password sent to you shortly after the completion of your Acquaintance Call.

The Response Center will then unlock your vehicle with the remote door unlocking feature.

Useful features



The remote door unlock feature is available if the relevant cellular phone network is available.

The SOS button will flash and the message "Emergency call Call connected" will appear in the multifunction display to indicate receipt of the door unlock command.

Once the vehicle is unlocked, a Response Center specialist will attempt to establish voice contact with the vehicle occupants.

If the trunk button was pressed for more than 20 seconds before door unlock authorization was received by the Response Center, you must wait 15 minutes before pressing the trunk button again.

Stolen vehicle tracking services

In the event your vehicle was stolen:

- ▶ Report the incident to the police
The police will issue a numbered incident report.
- ▶ Pass this number on to the Mercedes-Benz Response Center along with your password issued to you when you subscribed to the service.

The Response Center will then attempt to covertly contact the vehicle's Tele Aid system. Once the vehicle is located, the Response Center will contact the local law enforcement and you. The vehicle's location will only be provided to law enforcement.

Garage door opener

The built-in remote control is capable of operating up to three separately controlled objects.

You can program the signal transmitter keys.

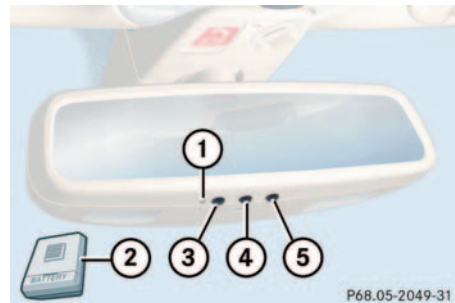

Remote control integrated into the inside rear view mirror

- 1 Indicator lamp
- 2 Hand-held remote control transmitter
- 3, 4, 5 Signal transmitter key

Warning!

When programming a garage door opener, the door moves up or down.

When programming or operating the remote control, make sure there is no possibility of anyone being injured by the moving door.



Certain types of garage door openers are incompatible with the integrated opener. If you should experience difficulties with programming the transmitter, contact your authorized Mercedes-Benz Center, or call Mercedes-Benz Customer Assistance Center (in the USA only) at 1-800-FOR-MERCEdes, or Customer Service (in Canada) at 1-800-387-0100.



For operation in the USA only: This device complies with Part 15 of the FCC Rules. Operation is subject to the following two conditions:

- This device may not cause harmful interference, and
- this device must accept any interference received, including interference that may cause undesired operation.

Any unauthorized modification to this device could void the user's authority to operate the equipment.

Programming or reprogramming the integrated remote control

- ▶ Turn key in starter switch to position **2**.
- ▶ Hold the end of the hand-held transmitter of the device you wish to train approximately 2 to 5 inches (5 cm to 12 cm) away from the surface of the in-

tegrated remote control located on the inside rear view mirror, keeping the indicator lamp in view.

- ▶ Using both hands, simultaneously press the hand-held transmitter button and the desired integrated remote control button. Do not release the buttons.

The indicator lamp on the integrated remote control will flash, first slowly and then rapidly. The rapid flashing lamp indicates successful programming of the new frequency signal.

- ▶ When the indicator lamp flashes rapidly, release both buttons.
- ▶ To program the remaining two buttons, repeat the steps.



If, after repeated attempts, you do not successfully program the integrated remote control device to learn the signal of the hand-held transmitter, the garage door opener could be equipped with the "rolling code feature".

Useful features

Rolling code programming

To train a garage door opener (or other rolling code devices) with the rolling code feature, follow these instructions after completing the “Programming” portion of this text. (A second person may make the following training procedures quicker and easier.)

- ▶ Locate training button on the garage door opener motor head unit.

Exact location and color of the button may vary by garage door opener brand. If there is difficulty locating the transmitting button, refer to garage door opener Operator’s Manual.

- ▶ Press “training” button on the garage door opener motor head unit.

The “training light” is activated.

You have 30 seconds time to initiate the following step.

- ▶ Firmly press and release the programmed integrated remote control transmit button.
- ▶ Press and release same button a second time to complete the training process.

Some garage door openers may require you to do this procedure a third time to complete the training.

- ▶ Confirm the garage door operation by pressing the programmed button on the integrated remote control transmitter.

Canadian programming

During programming, your hand-held transmitter may automatically stop transmitting.

- ▶ Continue to press and hold the integrated remote control transmitter button (refer to step two through four in the “Programming” portion) while you press and re-press (“cycle”) your hand-held transmitter every two seconds until the frequency signal has been learned.

Upon successful training, the indicator lamp will flash slowly and then rapidly after several seconds.

Operation of remote control

- ▶ Turn key in starter switch to position **2**.
- ▶ Select and press the appropriate button to activate the remote controlled device.

The integrated remote control transmitter continues to send the signal as long as the button is pressed – up to 20 seconds.

Erasing the remote control memory

- ▶ Turn key in starter switch to position **2**.
- ▶ Simultaneously hold down the left and right side buttons for approximately 20 seconds, or until the control lamp blinks rapidly.

The codes of all three channels are erased.



If you sell your vehicle, erase the codes of all three channels.

The first 1000 miles (1500 km)

Driving instructions

At the gas station

Engine compartment

Tires and wheels

Winter driving

Maintenance

Vehicle care



The first 1000 miles (1500 km)

In the “Operation” section you will find detailed information on operating, maintaining and caring for your vehicle.

The first 1000 miles (1500 km)

The more cautiously you treat your vehicle during the break-in period, the more satisfied you will be with its performance later on.

- Drive your vehicle during the first 1000 miles (1500 km) at varying but moderate vehicle and engine speeds.
- During this period, avoid heavy loads (full throttle driving) and excessive engine speeds (no more than $\frac{2}{3}$ of maximum rpm in each gear).
- Avoid accelerating by kickdown.
- Do not attempt to slow the vehicle down by shifting to a lower gear using the selector lever.
- Select positions **3**, **2** or **1** only when driving at moderate speeds (for hill driving).

After 1000 miles (1500 km), you may gradually increase vehicle and engine speeds to the permissible maximum.



Additional instructions for AMG vehicles:

- During the first 1000 miles (1500 km) do not exceed a speed of 85 mph (140 km/h).
- During this period, avoid engine speeds above 4500 rpm in each gear.

All of the above instructions, as may apply to your vehicle type, also apply when driving the first 1000 miles (1500 km) after the engine or the rear differential has been replaced.



Always obey applicable speed limits.

Driving instructions

Drive sensibly – save fuel

Fuel consumption, to a great extent, depends on driving habits and operating conditions.

To save fuel you should:

- keep tires at the recommended inflation pressures
- remove unnecessary loads
- allow engine to warm up under low load use
- avoid frequent acceleration and deceleration
- have all maintenance work performed at regular intervals by an authorized Mercedes-Benz Center

Fuel consumption is also increased by driving in cold weather, in stop-and-go traffic, on short trips and in hilly country.

Drinking and driving

Warning!



Drinking and driving and/ or taking drugs and driving are a very dangerous combination. Even a small amount of alcohol or drugs can affect your reflexes, perceptions and judgement.

The possibility of a serious or even fatal accident is sharply increased when you drink or take drugs and drive.

Please don't drink or take drugs and drive or allow anyone to drive after drinking or taking drugs.

Pedals

Warning!



Keep driver's foot area clear at all times. Objects stored in this area may impair pedal movement.

Driving instructions

Power assistance

Warning!



The brake system requires electrical energy for operation.

A malfunction in the vehicle's power supply or electrical system. In such a case, the red brake warning lamp (▷ page 253) and warning messages (▷ page 265) in the instrument cluster light up while driving. To brake, the driver must then apply significantly greater brake pedal pressure and depress the pedal much further to obtain the expected braking effect. If necessary, apply full pressure to the brake pedal. Brakes are only applied to the front wheels. Stopping distance is increased! If there is a malfunction in the SBC brake system, we recommend that the vehicle be transported with all wheels off the ground using flatbed or appropriate wheel lift/dolly equipment.

A tow bar must be used if circumstances do not permit the use of the recommended towing methods and the vehicle requires towing with all four wheels on the ground.

Towing the vehicle with all four wheels on the ground is only permissible for distances up to 30 miles (50 km) and at a speed not to exceed 30 mph (50 km/h). For more information, refer to "Towing the vehicle" (▷ page 325).

With the engine not running, there is no power assistance for the steering system. In this case, it is important to keep in mind that a considerably higher degree of effort is necessary to steer the vehicle.

Brakes

Warning!



After driving in heavy rain for some time without applying the brakes or through water deep enough to wet brake components, the first braking action may be somewhat reduced and increased pedal pressure may be necessary to obtain expected braking effect. Maintain a safe distance from vehicles in front.

Resting your foot on the brake pedal will cause excessive and premature wear of the brake pads.

It can also result in the brakes overheating thereby significantly reducing their effectiveness. It may not be possible to stop the vehicle in sufficient time to avoid an accident.

To help prevent brake disk corrosion after driving on wet road surfaces (particularly salted roads), it is advisable to brake the vehicle with considerable force prior to parking. The heat generated serves to dry the brakes.

If your brake system is normally only subjected to moderate loads, you should occasionally test the effectiveness of the brakes by applying above-normal braking pressure at higher speeds. This will also enhance the grip of the brake pads.



Be very careful not to endanger other road users when you apply the brakes.

Refer to the description of the Brake Assist System (BAS) (▷ page 69).

If the parking brake is released and the brake warning lamp in the instrument cluster stays on, there is a malfunction in the SBC brake system (▷ page 72) or the brake fluid level in the reservoir is too low.

Brake pad wear or a leak in the system may be the reason for low brake fluid in the reservoir.

Have the brake system inspected at an authorized Mercedes-Benz Center immediately.

All checks and service work on the brake system should be carried out by an authorized Mercedes-Benz Center.

Only install brake pads and brake fluid recommended by Mercedes-Benz.

Warning!



If other than recommended brake pads are installed, or other than recommended brake fluid is used, the braking properties of the vehicle can be degraded to an extent that safe braking is substantially impaired. This could result in an accident.

Be certain to read and observe the warning notices on brake pad replacement (▷ page 74).



When driving down long and steep grades, relieve the load on the brakes by shifting into a lower gear to use the engine's braking power. This helps prevent overheating of the brakes and reduces brake pad wear.

After hard braking, it is advisable to drive on for some time, rather than immediately parking, so the air stream will cool down the brakes faster.

Driving instructions

Driving off

Apply the brakes to test them briefly after driving off. Perform this procedure only when the road is clear of other traffic.

Warm up the engine smoothly. Do not place full load on the engine until the operating temperature has been reached.

When starting off on a slippery surface, do not allow one drive wheel to spin for an extended period with the ESP switched off. Doing so may cause serious damage to the drive train which is not covered by the Mercedes-Benz Limited Warranty.



Simultaneously depressing the accelerator pedal and applying the brake reduces engine performance and causes premature brake and drivetrain wear.

Parking

Warning!



Do not park this vehicle in areas where combustible materials such as grass, hay or leaves can come into contact with the hot exhaust system, as these materials could be ignited and cause a vehicle fire.

To reduce the risk of personal injury as a result of vehicle movement, before turning off the engine and leaving the vehicle always:

- Keep right foot on brake pedal.
- Firmly depress parking brake pedal.
- Move the selector lever to position **P**.
- Slowly release brake pedal.
- When parked on an incline, turn front wheels towards the road curb.
- Turn the key to starter switch position **0** and remove, or press KEYLESS-GO* start/stop button (vehicles with KEYLESS-GO*).

- take the key and the KEYLESS-GO* card (vehicles with KEYLESS-GO*) and lock vehicle when leaving



Set the parking brake whenever parking or leaving the vehicle. In addition, move selector lever to position **P**.

In addition, when parking on hills, turn front wheels towards the road curb.

Tires

Warning!



If you feel a sudden significant vibration or ride disturbance, or you suspect that possible damage to your vehicle has occurred, you should turn on the hazard warning flashers, carefully slow down, and drive with caution to an area which is a safe distance from the road.

Inspect the tires and the vehicle underbody for possible damage. If the vehicle or tires appear unsafe, have it towed to the nearest Mercedes-Benz Center or tire dealer for repairs.

Tread wear indicators (TWI) are required by law. These indicators are located in six places on the tread circumference and become visible at a tread depth of approximately $\frac{1}{16}$ in (1.5 mm), at which point the tire is considered worn and should be replaced.

The tread wear indicator appears as a solid band across the tread.

Warning!



Do not allow your tires to wear down too far. As tread depth approaches $\frac{1}{16}$ in (1.5 mm), the adhesion properties on a wet road are sharply reduced.

Depending upon the weather and/or road surface (conditions), the tire traction varies widely.

Specified tire pressures must be maintained. This applies particularly if the tires are subjected to extreme operating conditions (e.g. high speeds, heavy loads, high ambient temperatures).

Warning!



Do not drive with a flat tire. A flat tire affects the ability to steer or brake the vehicle. You may lose control of the vehicle. Continued driving with a flat tire or driving at high speed with a flat tire will cause excessive heat build-up and possibly a fire.

Hydroplaning

Depending on the depth of the water layer on the road, hydroplaning may occur, even at low speeds and with new tires. Reduce vehicle speed, avoid track grooves in the road and apply brakes cautiously in the rain.

Driving instructions

Tire traction

The safe speed on a wet, snow covered or icy road is always lower than on a dry road.

You should pay particular attention to the condition of the road whenever the outside temperatures are close to the freezing point.

Warning!



If ice has formed on the road, tire traction will be substantially reduced. Under such weather conditions, drive, steer and brake with extreme caution.

Mercedes-Benz recommends M+S rated radial-ply tires for the winter season for all four wheels to insure normal balanced handling characteristics. On packed snow, they can reduce your stopping distance as compared with summer tires. Stopping distance, however, is still considerably

greater than when the road is not covered with snow or ice. Exercise appropriate caution.

Tire speed rating

SL 500

Your vehicle is factory equipped with “W”-rated tires, which have a speed rating of 168 mph (270 km / h).

SL 500 with Sport Package* and SL 55 AMG

Your vehicle is factory equipped with “W”-rated tires, which have a speed rating of 168 mph (270 km / h) or “Y”-rated tires, which have a speed rating of 188 mph (300 km / h)

An electronic speed limiter prevents your vehicle from exceeding a speed of 155 mph (250 km / h).

Despite the tire rating, local speed limits should be obeyed. Use prudent driving speeds appropriate to prevailing conditions.

Warning!



Even when permitted by law, never operate a vehicle at speeds greater than the maximum speed rating of the tires.

Exceeding the maximum speed for which tires are rated can lead to sudden tire failure, causing loss of vehicle control and possibly resulting in an accident and/or personal injury and possible death, for you and for others.



Information on driving with snow chains (▷ page 240).



Information on tire speed rating for winter tires (▷ page 239).

Winter driving instructions

The most important rule for slippery or icy roads is to drive sensibly and to avoid abrupt acceleration, braking and steering maneuvers. Do not use the cruise control system under such conditions.

When the vehicle is in danger of skidding, move selector lever to position **N**. Try to keep the vehicle under control by corrective steering action.

Warning!



On slippery road surfaces, never downshift in order to obtain braking action. This could result in drive wheel slip and reduced vehicle control. Your vehicle's ABS will not prevent this type of control loss.

Road salts and chemicals can adversely affect braking efficiency. Increased pedal force may become necessary to produce the normal brake effect.

We therefore recommend depressing the brake pedal periodically when traveling at length on salt-strewn roads.

This can bring road salt impaired braking efficiency back to normal. Be very careful that you carry out these braking maneuvers without endangering any other road users.

If the vehicle is parked after being driven on salt-treated roads, the braking efficiency should be tested as soon as possible after driving is resumed while observing the safety rules in the previous paragraph.

Warning!



If the vehicle becomes stuck in snow, make sure that snow is kept clear of the exhaust pipe and from around the vehicle with the engine running. Otherwise, deadly carbon monoxide (CO) gases may enter vehicle interior resulting in unconsciousness and death.

To assure sufficient fresh air ventilation, open a window slightly on the side of the vehicle not facing the wind

Warning!



The outside temperature indicator is not designed to serve as an Ice-Warning Device and is therefore unsuitable for that purpose. Indicated temperatures just above the freezing point do not guarantee that the road surface is free of ice.

For more information on winter driving (▷ page 239).

Driving instructions

Standing water



Do not drive through flooded areas or water of unknown depth.

If you must drive through standing water, drive slowly to prevent water from entering the passenger compartment or the engine compartment. Water in these areas could cause damage to electrical components or wiring of the engine or transmission, or could result in water being ingested by the engine through the air intake, causing severe internal engine damage. Any such damage is not covered by the Mercedes-Benz Limited Warranty.

Passenger compartment

Warning!



Always fasten items being carried as securely as possible.

In an accident, during hard braking or sudden maneuvers, loose items will be thrown around inside the vehicle, and cause injury to vehicle occupants unless the items are securely fastened in the vehicle.

The trunk is the preferred place to carry objects.

Driving abroad

Abroad, there is a widely-spread Mercedes-Benz service network at your disposal. If you plan to drive into areas which are not listed in the index of your Mercedes-Benz Center directory, you should request pertinent information from your authorized Mercedes-Benz Center.

Control and operation of radio transmitters

COMAND, radio and telephone

Warning!



Please do not forget that your primary responsibility is to drive the vehicle safely. Only operate the COMAND (Cockpit Management and Data System), radio or telephone¹ if road, weather, and traffic conditions permit.

Bear in mind that at a speed of just 30 mph (approximately 50 km/h), your vehicle is covering a distance of approximately 44 feet (approximately 13.5 m) every second.

¹ Observe all legal requirements.

Telephones and two-way radios

Warning!



Never operate radio transmitters equipped with a built-in or attached antenna (i.e. without being connected to an external antenna) from inside the vehicle while the engine is running. Doing so could lead to a malfunction of the vehicle's electronic system, possibly resulting in an accident and/or personal injury.

Radio transmitters, such as a portable telephone or a citizens band unit should only be used inside the vehicle if they are connected to an antenna that is installed on the outside of the vehicle.

Refer to the radio transmitter operation instructions regarding use of an external antenna.

Catalytic converter

Your Mercedes-Benz is equipped with monolithic type catalytic converters, an important element in conjunction with the oxygen sensors to achieve substantial control of the pollutants in the exhaust emissions. Keep your vehicle in proper operating condition by following our recommended maintenance instructions as outlined in your Service Booklet.



To prevent damage to the catalytic converters, only use premium unleaded gasoline in this vehicle.

Any noticeable irregularities in engine operation should be repaired promptly. Otherwise, excessive unburned fuel may reach the catalytic converter causing it to overheat, which could start a fire.

Warning!



As with any vehicle, do not idle, park or operate this vehicle in areas where combustible materials such as grass, hay or leaves can come into contact with the hot exhaust system, as these materials could be ignited and cause a vehicle fire.

Driving instructions

Emission control

Certain systems of the engine serve to keep the toxic components of the exhaust gases within permissible limits required by law.

These systems, of course, will function properly only when maintained strictly according to factory specifications. Any adjustments on the engine should therefore be carried out only by qualified Mercedes-Benz Center authorized technicians. Engine adjustments should not be altered in any way. Moreover, the specified service jobs must be carried out regularly according to Mercedes-Benz servicing requirements. For details refer to the Service Booklet.

Warning!



Inhalation of exhaust gas is hazardous to your health. All exhaust gas contains carbon monoxide, and inhaling it can cause unconsciousness and lead to death.

Do not run the engine in confined areas (such as a garage) which are not properly ventilated. If you think that exhaust gas fumes are entering the vehicle while driving, have the cause determined and corrected immediately. If you must drive under these conditions, drive only with at least one window fully open at all times.

Coolant temperature

During severe operating conditions and stop-and-go city traffic, the coolant temperature may rise close to approx. 266°F (130°C).

The engine should not be operated with the coolant temperature over 248°F (120°C). Doing so may cause serious engine damage which is not covered by the Mercedes-Benz Limited Warranty.

Warning!



- Driving when your engine is badly overheated can cause some fluids, which may have leaked into the engine compartment, to catch fire. You could be seriously burned.
- Steam from an overheated engine can cause serious burns and can occur just by opening the engine hood. Stay away from the engine if you see or hear steam coming from it. Turn off the engine, get out of the vehicle and do not stand near the vehicle until it cools down.

At the gas station

Warning!



Gasoline is highly flammable and poisonous. It burns violently and can cause serious injury. Whenever you are around gasoline, avoid inhaling fumes and skin contact, extinguish all smoking materials. Never allow sparks, flame or smoking materials near gasoline!

The fuel filler flap is located on the right-hand side of the vehicle towards the rear. Locking/unlocking the vehicle with the remote control or the KEYLESS-GO* card automatically locks/unlocks the fuel filler flap.

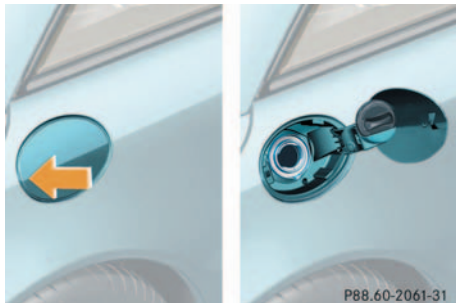

- ▶ Remove the key from the starter switch.
- ▶ Open the fuel filler flap by pushing at the point indicated by the arrow.
The fuel filler flap springs open.
- ▶ Turn the fuel cap to the left and hold on to it until possible pressure is released.
- ▶ Take off the cap and set it in the recess on the fuel filler flap.
- ▶ Only fill your tank until the filler nozzle unit cuts out – **do not top up or overfill.**

Warning!



Overfilling of the fuel tank may create pressure in the system which could cause a gas discharge. This could cause the gas to spray back out when removing the fuel pump nozzle, which could cause personal injury.

- ▶ Replace the fuel cap by turning it to the right.
You will hear when the fuel cap is tightened.
- ▶ Close the fuel filler flap.
You should hear the latch close shut.



Only use premium unleaded gasoline with a minimum Posted Octane Rating of 91 (average of 96 RON / 86 MON). Information on gasoline quality can normally be found on the fuel pump.

More information on gasoline can be found in the “Technical data” section (▷ page 344).



Leaving the engine running and the fuel cap open can cause the **CHECK ENGINE** lamp to illuminate.

More information can be found in the “Practical hints” section (▷ page 256).

At the gas station

Check regularly and before a long trip

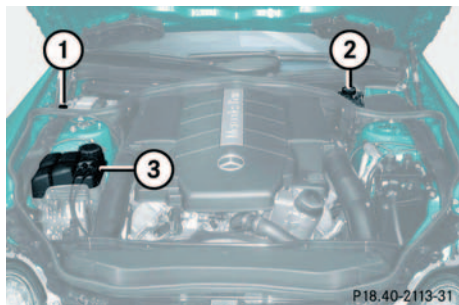

1 Windshield washer and headlamp cleaning system

More information on refilling the reservoir can be found in the “Operation” section on (▷ page 233).

2 Brake fluid

More information on brake fluid can be found in the “Technical data” section (▷ page 342).

3 Coolant level

More information on coolant can be found in the “Coolant” section on (▷ page 230).

Engine oil level

More information on engine oil can be found in the Checking engine oil level section on (▷ page 228).

Opening hood see (▷ page 227).

Vehicle lighting

Check function and cleanliness. More information on replacing light bulbs can be found in the “Practical hints” section (▷ page 295).

Exterior lamp switch see “Switching on headlamps” (▷ page 43).

Tire inflation pressure

More information on tire inflation pressure can be found in the “Tires and wheels” section (▷ page 234).

Engine compartment

Engine compartment

Hood

Warning!



Do not pull the release lever while the vehicle is in motion. Otherwise the hood could be forced open by passing air flow.

Opening

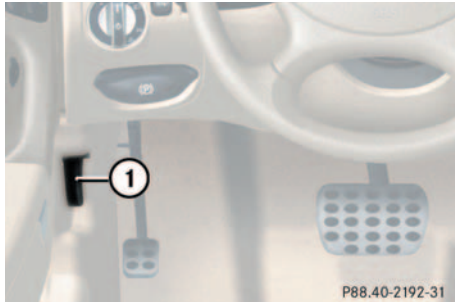

1 Hood release

- ▶ Pull lever **1** downwards.
The hood is unlocked.



To avoid damage to the windshield wipers or hood, never open the hood if the wiper arms are folded forward away from the windshield.



2 Lever for opening the hood

- ▶ Push lever **2** on the hood upwards.
- ▶ Pull up on the hood and then release it.

The hood will be automatically held open at shoulder height by gas-filled struts.

Warning!



To help prevent personal injury, stay clear of moving parts when the hood is open and the engine is running. Make sure the hood is properly closed before driving. When closing the hood, use extreme caution not to catch hands or fingers.

The radiator fan may continue to run for approximately 30 seconds or may even restart after the engine has been turned off. Stay clear of fan blades.

Engine compartment

Warning!



If you see flames or smoke coming from the engine compartment, or if the coolant temperature gauge indicates that the engine is overheated, do not open the hood. Move away from the vehicle and do not open the hood until the engine has cooled. If necessary, call the fire department.

Warning!



The engine is equipped with a transistorized ignition system. Because of the high voltage it is dangerous to touch any components (ignition coils, spark plug sockets, diagnostic socket) of the ignition system

- with the engine running
- while starting the engine
- if ignition is “on” and the engine is turned manually

Closing

Warning!



Be careful that you do not close the hood on anyone.

- ▶ Let the hood drop from a height of approximately 1¹/₂ ft (50 cm).

The hood will lock audibly.

- ▶ Check to make sure that the hood is fully closed.

If you can raise the hood at a point above the headlamps, then it is not properly closed. Open it again and let it drop with somewhat greater force.

Engine oil

The amount of oil your engine needs will depend on a number of factors, including driving style. Higher oil consumption can occur when

- the vehicle is new
- the vehicle is driven frequently at higher engine speeds

Engine oil consumption checks should only be made after the vehicle break-in period.

Checking engine oil level



When checking the oil level the vehicle must

- be parked on level ground
- be at normal operating temperature
- have been stationary for at least five minutes with the engine turned off

You can check the engine oil level on the multifunction display.

- ▶ Turn the key in the starter switch to position **2**.

The standard display (▶ page 110) should appear in the multifunction display fields.

- ▶ Press button  or  on the steering wheel until the following message is seen in the right display field:

Measurement correct only if veh.
level



After about three seconds this message is displayed: Engine oil level - Measuring now!

One of the following messages will subsequently appear in the indicator:

- Engine oil level OK
- Engine oil add 1.0 qt (1.0 liter)!
- Engine oil add 1.5 qt (1.5 liters)!
- Engine oil add 2.0 qt (2.0 liters)!

Adding engine oil

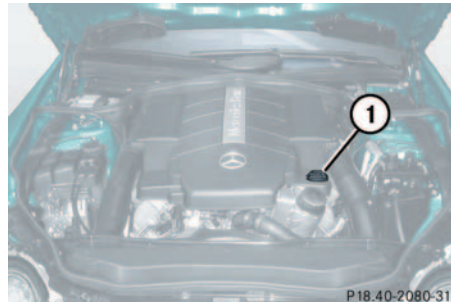

1 Filler neck

- ▶ Unscrew the cap from the filler neck **1**. Be careful not to overfill with oil.

Be careful not to spill any oil when adding. Avoid environmental damage caused by oil entering the ground or water.



Excessive oil must be siphoned or drained off. It could cause damage to the engine and catalytic converter not covered by the Mercedes-Benz Limited Warranty.

- ▶ Screw the cap back on the filler neck.

Engine compartment

Other display messages

If there is excessive engine oil with the engine at normal operating temperature, the following message will appear:

Engine oil level - Reduce oil level!

- ▶ Have excess oil siphoned.

If the key is not turned to position **2** in the starter switch:

Engine oil level - Switch on ignition!

- ▶ Switch on the ignition.

If you see the message:

Observe waiting time

- ▶ Wait five minutes before repeating check procedure.

If you see the message:

Engine oil level - Not while engine on

- ▶ Turn off the engine. If engine is at normal operating temperature, wait five minutes before checking oil. If the engine is not yet at normal operating temperature, you must wait 30 minutes before checking oil.

More information on engine oil can be found in the “Technical data” section (▶ page 343).

Transmission fluid level

The transmission fluid level does not need to be checked. If you notice transmission fluid loss or gear shifting malfunctions, have an authorized Mercedes-Benz Center check the automatic transmission.

Oil level in the ABC system

The oil level in the ABC system does not need to be checked. If there is visible oil loss or if malfunction messages appear in the display, have an authorized Mercedes-Benz Center check the ABC system.

Coolant

The engine coolant is a mixture of water and anticorrosion/antifreeze. To check the coolant level, the vehicle must be parked on level ground and the engine must be cool.

The coolant expansion tank is located on the passenger side of the engine compartment.

Warning!

In order to avoid any possibly serious burns:

- Use extreme caution when opening the hood if there are any signs of steam or coolant leaking from the cooling system, or if the coolant temperature gauge indicates that the coolant is overheated.
- Do not remove pressure cap on coolant reservoir if engine temperature is above 194°F (90°C). Allow engine to cool down before removing cap. The coolant reservoir contains hot fluid and is under pressure.
- Using a rag, slowly open the cap approximately $\frac{1}{2}$ turn to relieve excess pressure. If opened immediately, scalding hot fluid and steam will be blown out under pressure.
- Do not spill antifreeze on hot engine parts. Antifreeze contains ethylene glycol which may burn if it comes into contact with hot engine parts.

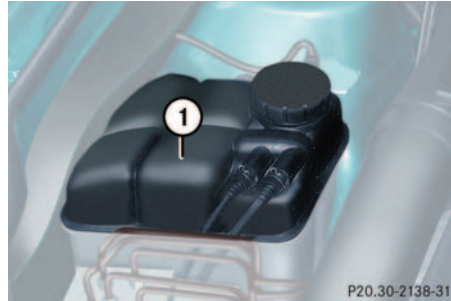
**1** Coolant expansion tank

- ▶ Using a rag, turn the cap slowly approximately one half turn to the left to release any excess pressure.
- ▶ Continue turning the cap to the left and remove it.

The coolant level is correct if the level

- for cold coolant: is up to the upper mark on the bracing rib of the coolant expansion tank (translucent)
- for warm coolant: is approx. 0.6 in (1.5 cm) higher
- ▶ Add coolant as required.

- ▶ Replace and tighten cap.

More information on coolant can be found in the “Technical data” section (▷ page 345).

Engine compartment

Battery

Your vehicle is equipped with two batteries:

- The starter battery (located in the engine compartment)
- The battery for electrical consumers (located in the trunk)

These batteries should always be sufficiently charged in order to achieve their rated service life.

If you use your vehicle mostly for short distance trips, you will need to have the battery charge checked more frequently.

When replacing batteries, always use batteries approved by Mercedes-Benz.

If you do not intend to operate your vehicle for an extended period of time, consult an authorized Mercedes-Benz Center about steps you need to observe.



Observe all safety instructions and precautions when handling automotive batteries.



Risk of explosion



Keep flames or sparks away from battery. Do not smoke.



Battery acid is caustic. Do not allow it to come into contact with skin, eyes or clothing.

In case it does, immediately flush affected area with clear water and seek medical help if necessary.



Wear eye protection.



Keep children away.



Follow the instructions in this Operator's Manual.

Batteries contain materials that can harm the environment if disposed of improperly. Recycling of batteries is the preferred method of disposal. Many states require sellers of batteries to accept old batteries for recycling.

Windshield washer system and headlamp cleaning system

Fluid for the windshield washer system and the headlamp cleaning system is supplied from the windshield washer reservoir. It has a capacity of approx. 7.4 US qt. (7 l).

During all seasons, add MB Windshield Washer Concentrate “S” to water. Pre-mix the windshield washer fluid in a suitable container.

- ▶ Refill the reservoir with MB Windshield Washer Concentrate and water (or commercially available pre-mixed windshield washer solvent / antifreeze, depending on ambient temperatures).

Always use washer solvent / antifreeze where temperatures may fall below freezing. Failure to do so could result in damage to the washer system / reservoir.

The windshield washer system on this vehicle is heated, so that a fluid mixture produced for temperatures of approximately 14°F (-10°C) should be sufficient.

Warning!



Washer solvent / antifreeze is highly flammable. Do not spill washer solvent / antifreeze on hot engine parts, because it may ignite. You could be seriously burned.

More information can be found in the “Technical data” section (▷ page 347).

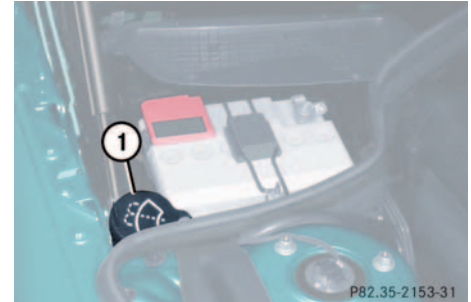

1 Washer fluid reservoir



Only use washer fluid which is suitable for plastic lenses. Improper washer fluid can damage the plastic lenses of the headlamps.

Tires and wheels

Tires and wheels

See your authorized Mercedes-Benz Center for information on tested and recommended rims and tires for summer and winter operation. They can also offer advice concerning tire service and purchase.

Warning!



Replace rims or tires with the same designation, manufacturer and type as shown on the original part. See your authorized Mercedes-Benz Center for further information. If incorrectly sized rims and tires are mounted:

- The wheel brakes or suspension components can be damaged.
- The correct operating clearance of the wheels and the tires is no longer guaranteed.

Warning!



Worn, old tires can cause accidents. If the tire tread is badly worn, or if the tires have sustained damage, replace them.

When replacing rims, only use genuine Mercedes-Benz wheel bolts specified for the particular rim type. Failure to do so can result in the bolts loosening and may lead to an accident.

Retread tires are not tested or recommended by Mercedes-Benz, since previous damage cannot always be recognized on retreads. Mercedes-Benz can therefore not assure the operating safety of the vehicle when such tires are used.

See your authorized Mercedes-Benz Center for information on tested and recommended rims and tires for summer and winter operation.

Important guidelines

- Only use sets of tires and rims of the same type and make.
- Tires must be of the correct size for the rim.
- Break in new tires for approximately 60 miles (100 km) at moderate speeds.
- Regularly check the tires and rims for damage.
- If vehicle is heavily loaded, check tire pressure and correct as required.
- Do not allow your tires to wear down too far. Adhesion properties on wet roads are sharply reduced at tread depths under $\frac{1}{8}$ in (3 mm).
- When replacing individual tires, you should mount new tires on the front wheels first (on vehicles with same-sized wheels all around).

Life of tires

The service life of a tire is dependent upon various factors including but not limited to:

- Driving style
- Tire pressure
- Distance driven

Warning!



Tires and spare tire should be replaced after six years, independently of the remaining tread.



Keep unmounted tires in a cool, dry place with as little exposure to light as possible. Protect tires from contact with oil, grease and gasoline.

Direction of rotation

Unidirectional tires offer added advantages, such as better aquaplaning performance. To benefit, however, you must ensure that the tires rotate in the direction specified.

An arrow on the sidewall indicates the intended direction of rotation of the tire.

Checking tire inflation pressure

Warning!



If the tire pressure repeatedly drops

- check the tires for punctures from foreign objects
- check to see whether air is leaking from the valves or from around the rim

Correct the tire pressure only when tires are cold.

If the tires are warm you should only correct the tire pressure if it is too low for current operating conditions.

A table on the fuel filler flap lists the specified tire inflation pressures for warm and cold tires as well as for various operating conditions.



The pressures listed for light loads are minimum values offering high driving comfort.

Increased inflation pressures listed for heavier loads may also be used for light loads. These higher pressures produce favorable handling characteristics. The ride of the vehicle, however, will be somewhat harder. Never exceed the maximum values or inflate tires below the minimum values listed in the fuel filler flap.

Tires and wheels

Regularly check your tire pressure at intervals of no more than 14 days.

Tire pressure changes by approximately 1.5 psi (0.1 bar) per 18°F (10°C) of air temperature change. Keep this in mind when checking tire pressure where the temperature is different from the outside temperature.

The tire temperature and with it the tire pressure is increased also while driving, depending on the driving speed and the tire load.

Checking tire pressure electronically*

The tire inflation pressure monitor only functions on wheels that are equipped with the proper electronic sensors. It monitors the tire inflation pressure, as selected by the driver, in all four tires. A warning is issued to alert you to a decrease in pressure in one or more of the tires.

Tire pressure inquiries are made using the multifunction display (▷ page 110). The present inflation pressures are displayed only after a few minutes travel time.

You can select the unit of measure used for the tire inflation pressure by changing the setting in the control system (▷ page 129).



Possible differences between the readings of a tire pressure gauge of an air hose, e.g. gas station equipment, and the vehicle's control system can occur. The readings issued by the control system are more precise.

- ▶ Switch on ignition.
- ▶ Press  button until the current inflation pressures for each tire appear in the tachometer display field.



Warning!



The tire inflation pressure monitor does not indicate a warning for wrongly selected inflation pressures. Always adjust tire inflation pressure according to the label on the fuel filler flap.

The tire inflation pressure monitor is not able to issue a warning due to a sudden loss of pressure (e.g. tire puncture caused by a foreign object). In the event of a sudden loss of pressure, bring the vehicle to a halt by carefully applying the brakes and avoiding abrupt steering maneuvers.

Warning!

Follow recommend tire pressures.

Do not overinflate tires. Overinflating tires can result in sudden deflation (blowout) because they are more likely to become punctured or damaged by road debris, potholes etc.

Do not underinflate tires. Underinflated tires wear unevenly, adversely affect handling and fuel economy, and are more likely to fail from being overheated.

Do not overload the tires by exceeding the specified vehicle capacity weight (as indicated by the label on the pillar in the driver's door opening). Overloading the tires can overheat them, possibly causing a blowout.



Operating radio transmission equipment (e.g. wireless headsets, two-way radios) in or near the vehicle could cause the tire inflation pressure monitor to malfunction.

Activating the tire inflation pressure monitor

You must activate the tire inflation pressure monitor in the following cases:

- if you have changed the tire pressure
 - if you have replaced the wheels or tires
 - if you have installed new wheels or tires
- ▶ Be sure that the tire pressure is correctly set.
- ▶ Press the  button until the inflation pressure of each tire appears in the right display field.



If transporting a deflated road wheel or additional wheel sensors in the vehicle, the tire inflation pressure monitor should not be reactivated until the deflated wheel or additional wheel sensors have been removed from the vehicle. Otherwise, the deflated wheel or additional sensors could confuse the tire inflation pressure monitor system and cause it to malfunction.

- ▶ Press the reset knob (▷ page 21).

The following message will appear in the speedometer display field:
Monitor current tire pressure?

- ▶ Press  button.

The following message will appear in the speedometer display field:
Tire pressure monitor activated!
Pressure display after driving several mins.

Tires and wheels

If you wish to cancel activation:

- ▶ Press  button.

If the following message appears in the speedometer display field:

Reactivate tire press. monit.

- ▶ Re-start the activation of the tire inflation pressure monitor.

If the following message appears in the speedometer display field:

Tire pressure
Check tires!

- ▶ Re-start the activation of the tire inflation pressure monitor.

Rotating wheels

Warning!



Rotate front and rear wheels only if they are of the same size.

On vehicles with the same wheel size all around, wheels can be rotated every 3000 to 6000 miles (5000 to 10000 km), or sooner if necessary, according to the degree of tire wear. The same direction of tire rotation must be retained.

Rotate the wheels before the characteristic tire wear pattern becomes visible (shoulder wear on front wheels and tread center wear on rear wheels).

Thoroughly clean the inner side of the wheels after each rotation. Check and ensure proper tire inflation pressure, activating the tire inflation pressure monitor if necessary.

Warning!



Have the tightening torque checked after changing a wheel. Wheels could become loose if not tightened with a torque of 96 ft.lb. (130 Nm).

Only use genuine Mercedes-Benz wheel bolts specified for your vehicle's rims.

Winter driving

Before the onset of winter have your vehicle winterized at an authorized Mercedes-Benz Center. This service includes:

- Check of anticorrosion and antifreeze concentration.
- Addition of cleaning concentrate to the water of the windshield and headlamp cleaning system. Add MB Concentrate “S” to a pre-mixed windshield washer solvent / antifreeze which is formulated for below freezing temperatures (▷ page 346).
- Battery test. Battery capacity drops with decreasing ambient temperature. A well charged battery helps to ensure that the engine can be started and the SBC brake system will be fully operational even at low ambient temperatures.
- Tire change. We recommend M+S rated radial-ply tires on all four wheels for the winter season.



When scraping ice or snow from the rear window, be careful not to damage the sealing strip or apertures along the side of the window.

Winter tires

Always use winter tires at temperatures below 39°F (4°C) and whenever wintry road conditions prevail. Use of winter tires is the only way to achieve the maximum effectiveness of the ABS and ESP in winter operation.

For safe handling, ensure that all winter tires mounted are of the same make and have the same tread design.

Warning!



Winter tires with a tread depth under 0.16 in (4 mm) must be replaced. They are no longer suitable for winter operation.

Always observe the speed rating of the winter tires installed on your vehicle. If the maximum speed for which your tires are rated is below the speed rating of your vehicle, you must place a notice to this effect where it will be seen by the driver. Such notices are available from your tire dealer or from any authorized Mercedes-Benz Center.

Winter driving

Warning!



If you use your spare tire when winter tires are fitted on the other wheels, be aware that the difference in tire characteristics may very well impair turning stability and that overall driving stability may be reduced. Adapt your driving style accordingly.

Have the spare tire replaced with a winter tire at the nearest authorized Mercedes-Benz Center.

Block heater (Canada only)

The engine is equipped with a block heater.

The electrical cable may be installed at your authorized Mercedes-Benz Center.

Snow chains

When driving with snow chains, always select setting 1 of the level control system (▷ page 184). Other settings may result in damage to your vehicle.

Snow chains should only be driven on snow-covered roads at speeds not to exceed 30 mph (50 km/h). Remove chains as soon as possible when driving on roads without snow.



When driving with snow chains, you may wish to deactivate the ESP (▷ page 71) before setting the vehicle in motion. This will improve the vehicle's traction.

Please observe the following guidelines when using snow chains:

- Use of snow chains is not permissible with all wheel/tire combinations.
- Chains should only be used on the rear wheels. Follow the manufacturer's mounting instructions.
- Only use snow chains that are approved by Mercedes-Benz. Your authorized Mercedes-Benz Center will be glad to advise you on this subject.



Use of snow chains is not permissible with tire sizes 285 / 35 R18.

Maintenance

We strongly recommend that you have your vehicle serviced by your authorized Mercedes-Benz Center, in accordance with the Service Booklet at the times called for by the FSS (Flexible Service System).



Failure to have the vehicle maintained in accordance with the Service Booklet at the designated times/mileage called for by the FSS may result in vehicle damage not covered by the Mercedes-Benz Limited Warranty.

FSS will notify you when your next service is due.

Approximately one month before your next service is due, one of the following messages will appear in the tachometer display field while you are driving or when you switch on the ignition (example service A):

- Service A in xx days
- Service A in xx miles (km)
- Service A Due now!

The type of service due is indicated in the speedometer display field:

-  Minor service (A)
-  Major service (B)



The interval between services depends on your driving habits. A gentle driving style, moderate engine speeds and the avoidance of short distance trips will lengthen the interval between services.

Clearing the service indicator

The service indicator is automatically cleared after 30 seconds. You can also clear it yourself.



1 Reset knob

- ▶ Press the reset knob **1**.

Service term exceeded

If you have exceeded the suggested service term, you will see the following message in the tachometer display field:





- Service A exceeded by xx days
- Service A exceeded by xx miles (km)

The Mercedes-Benz Center will reset the service indicator following a completed service.

Calling up the service indicator

- ▶ Switch ignition on.

The standard display of the control system appears (▷ page 110).





- ▶ Press button  or  on the steering wheel until the service symbol  or  appears in the speedometer display and the service deadline in the tachometer.

Resetting the service indicator

In the event that the service on your vehicle is not carried out by an authorized Mercedes-Benz Center, you can reset the service indicator yourself.

- ▶ Switch ignition on.

The standard display of the control system appears (▷ page 110).

- ▶ Press button  or  on the steering wheel until the service symbol  or  appears in the speedometer display and the service deadline in the tachometer.
- ▶ Press the reset knob for about four seconds.

This message appears in the tachometer:

Do you want to reset the service interval?

Confirm by using reset button

- ▶ To confirm, hold down the reset knob until you hear a signal.

The service indicator now displays the reset interval.



Only reset if the proper service has been performed. Resetting the system without performing proper service as called for by the FSS will cause the FSS to incorrectly determine the next service interval which will result in engine damage not covered by the Mercedes-Benz Limited Warranty.

If the battery supplying the vehicle's electrical consumers is disconnected, the days of disconnection will not be included in the count shown by the service indicator. To arrive at the true service deadline, you will need to subtract these days from the days shown in the service indicator.

Do not confuse the service indicator with the engine oil level indicator .

Vehicle care

Cleaning and care of the vehicle

Warning!



Many cleaning products can be hazardous. Some are poisonous, others are flammable. Always follow the instructions on the particular container. Always open your vehicle's doors or windows when cleaning the inside.

Never use fluids or solvents that are not designed for cleaning your vehicle.

While in operation, even while parked, your vehicle is subjected to varying external influences which, if gone unchecked, can attack the paintwork as well as the underbody and cause lasting damage.

Such damage is caused not only by extreme and varying climatic conditions, but also by:

- Air pollution
- Road salt
- Tar, gravel and stone chipping

To avoid paint damage, you should immediately remove:

- Grease and oil
- Fuel
- Coolant
- Brake fluid
- Bird droppings
- Insects
- Tree resins, etc.

Frequent washing reduces and /or eliminates the aggressiveness and potency of the above adverse influences.

More frequent washings are necessary to deal with unfavorable conditions:

- Near the ocean
- In industrial areas (smoke, exhaust emissions)
- During winter operation

You should check your vehicle from time to time for stone chipping or other damage. Any damage should be repaired as soon as possible to prevent corrosion.

In doing so, do not neglect the underbody of the vehicle. A prerequisite for a thorough check is a washing of the underbody followed by a thorough inspection. Damaged areas need to be re-undercoated.

Your vehicle has been treated at the factory with a wax-base rustproofing in the body cavities which will last for the lifetime of the vehicle. Post-production treatment is neither necessary nor recommended by Mercedes-Benz because of the possibility of incompatibility between materials used in the production process and others applied later.

We have selected car-care products and compiled recommendations which are specially matched to our vehicles and which always reflect the latest technology. You can obtain Mercedes-Benz approved car-care products at your authorized Mercedes-Benz Center.

Vehicle care

Scratches, corrosive deposits, corrosion or damage due to negligent or incorrect care cannot always be removed or repaired with the car-care products recommended here. In such cases it is best to seek aid at your authorized Mercedes-Benz Center.

The following topics deal with the cleaning and care of your vehicle and give important “how-to” information as well as references to Mercedes-Benz approved car-care products.

Additional information can be found in the “Vehicle Care Guide” booklet.

Power washer

When using a power washer for cleaning the vehicle, always observe manufacturer’s operating instructions.



Vehicles with KEYLESS-GO*:

If a door handle is hit by a strong jet of water, and a KEYLESS-GO* card is in close proximity, i.e. within approx. 3 ft. (approx. 1 m), the vehicle could be inadvertently locked or unlocked.



Never use a round nozzle to power wash tires. The intense jet of water can result in damage to the tire.

Always replace a damaged tire.

Always keep the jet of water moving across the surface. Do not aim directly at electrical parts, electrical connectors, seals, or other rubber parts.

Tar stains

Quickly remove tar stains before they dry and become more difficult to remove. A tar remover is recommended.

Paintwork, painted body components

Mercedes-Benz approved Paint Care should be applied when water drops on the paint surface do not “bead up”, normally every 3 to 5 months, depending on climate and washing detergent used.

Mercedes-Benz approved Paint Cleaner should be applied if the paint surface shows signs of dirt embedding (i.e. loss of gloss).

Do not apply any of these products or wax if your vehicle is parked in the sun or if the hood is still hot.

Use the appropriate MB-Touch-Up Stick for quick and provisional repairs of minor paint damage (i.e. chips from stones, vehicle doors, etc.).

Engine cleaning

Prior to cleaning the engine compartment make sure to protect electrical components and connectors from the intrusion of water and cleaning agents.

Corrosion protection, such as MB Anticorrosion Wax, should be applied to the engine compartment after every engine cleaning. Before applying, all control linkage bushings and joints should be lubricated. The poly-V-belt and all pulleys should be protected from any wax.

Vehicle washing

Do not use hot water or wash your vehicle in direct sunlight. Only use a mild car wash detergent, such as Mercedes-Benz approved Car Shampoo.

Thoroughly spray the vehicle with a diffused jet of water. Direct only a very weak spray towards the ventilation intake. Use plenty of water and rinse the sponge and chamois frequently.

Rinse with clear water and thoroughly dry with a chamois. Do not allow cleaning agents to dry on the finish.

Due to the width of the vehicle, fold in outside mirrors prior to running the vehicle through an automatic car wash to prevent damage to the mirrors.

In the winter, thoroughly remove all traces of road salt as soon as possible.

When washing the underbody, do not forget to clean the inner sides of the wheels.



Vehicles with KEYLESS-GO*:
If a door handle is hit by a strong jet of water, and a KEYLESS-GO* card is in close proximity, i.e. within approx 3 ft. (approx. 1 m), the vehicle could be inadvertently locked or unlocked.

Ornamental moldings

For regular cleaning and care of very dirty chrome-plated parts, use a chrome cleaner.

Headlamps, taillamps, turn signal lenses

Use a mild car wash detergent, such as Mercedes-Benz approved Car Shampoo, with plenty of water.

To prevent scratches, never apply strong force and only use a soft, non-scratchy cloth when cleaning the lenses. Do not attempt to wipe dirty lenses with a dry cloth or sponge.

Vehicle care

Cleaning the DISTRONIC* system sensor cover



DISTRONIC* system sensor cover

Use a mild car wash detergent, such as Mercedes-Benz approved Car Shampoo, with plenty of water to clean the sensor cover **1**.

To prevent scratches, never apply strong force and only use a soft, non-scratchy cloth when cleaning the sensor. Do not attempt to wipe dirty sensors with a dry cloth or sponge.



Restart the engine after cleaning the sensor **1**.

Cleaning the Parktronic* system sensors

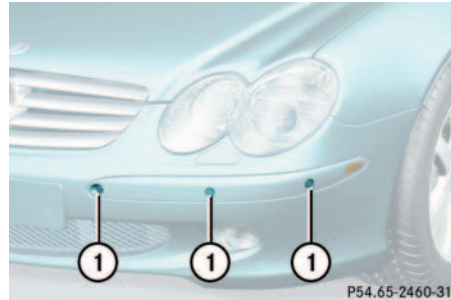

1 Parktronic* sensors

Use a mild car wash detergent, such as Mercedes-Benz approved Car Shampoo, with plenty of water.

When using a steam cleaner or power washer, aim nozzle only briefly from a minimum distance of 4 in. (10 cm) at sensors **1**.

To prevent scratches, never apply strong force and only use a soft, non-scratchy cloth when cleaning the sensors. Do not attempt to wipe dirty sensors with a dry cloth or sponge.

Wiper blades



Position of wiper blades when cleaning



To prevent damage to the hood or the wipers, the wiper arms **MUST BE** folded forward in the position shown above.

- ▶ Turn key in the starter switch to position **1**.

- ▶ Turn combination switch to position **1** (▷ page 44).
- ▶ Once the wiper arms are in the position shown above, turn key in starter switch to position **0**.



For safety reasons, remove key from starter switch before cleaning the wiper blades. Otherwise, the wiper motor can suddenly turn on and cause injury.

- ▶ Turn combination switch to position **0** (▷ page 44).
- ▶ Clean the wiper blade inserts with a clean cloth and detergent solution.



Fold the windshield wiper arms back onto the windshield before turning the key in the starter switch.

Window cleaning

Use a window cleaning solution on all glass surfaces. An automotive glass cleaner is recommended.



For safety reasons, switch off wipers and remove key from starter switch before cleaning the windshield, otherwise the wiper motor can suddenly turn on and cause injury.

Light alloy wheels

Mercedes-Benz approved Wheel Care should be used for regular cleaning of the light alloy wheels.

If possible, clean wheels once a week with Mercedes-Benz approved Wheel Care, using a soft bristle brush and a strong spray of water.

Follow instructions on container.



Only use acid-free cleaning materials. The acid could lead to corrosion.

Instrument cluster

Use a gentle dishwashing detergent or mild detergent for delicate fabrics as a washing solution. Wipe with a cloth moistened in lukewarm solution. Do not use scouring agents.

Vehicle care

Steering wheel and gear selector lever

Wipe with a damp cloth and dry thoroughly or clean with Mercedes-Benz approved Leather Care.

Cup holder

Use a gentle dishwashing detergent or mild detergent for delicate fabrics as a washing solution. Wipe with a cloth moistened in lukewarm solution. Do not use scouring agents.

Hard plastic trim items

Pour Mercedes-Benz approved Interior Care onto soft lint-free cloth and apply with light pressure.

Headliner and shelf below rear window

Clean with soft bristle brush, or use a dry-shampoo cleaner in case of excessive dirt.

Seat belts

The webbing must not be treated with chemical cleaning agents. Only use clear, lukewarm water and soap. Do not dry the webbing at temperatures above 176°F (80°C) or in direct sunlight.

Warning!



Do not bleach or dye seat belts as this may severely weaken them. In a crash, they may not be able to provide adequate protection.

Leather upholstery

Using aftermarket seat covers or wearing clothing that have the tendency to give off coloring (e.g. when wet, etc.) may cause the upholstery to become permanently discolored. By lining the seats with a proper intermediate cover, contact-discoloration will be prevented.

Wipe leather upholstery with a damp cloth and dry thoroughly or clean with Mercedes-Benz approved Leather Care.

Exercise particular care when cleaning perforated leather as its underside should not become wet.

Plastic and rubber parts

Do not use oil or wax on these parts.

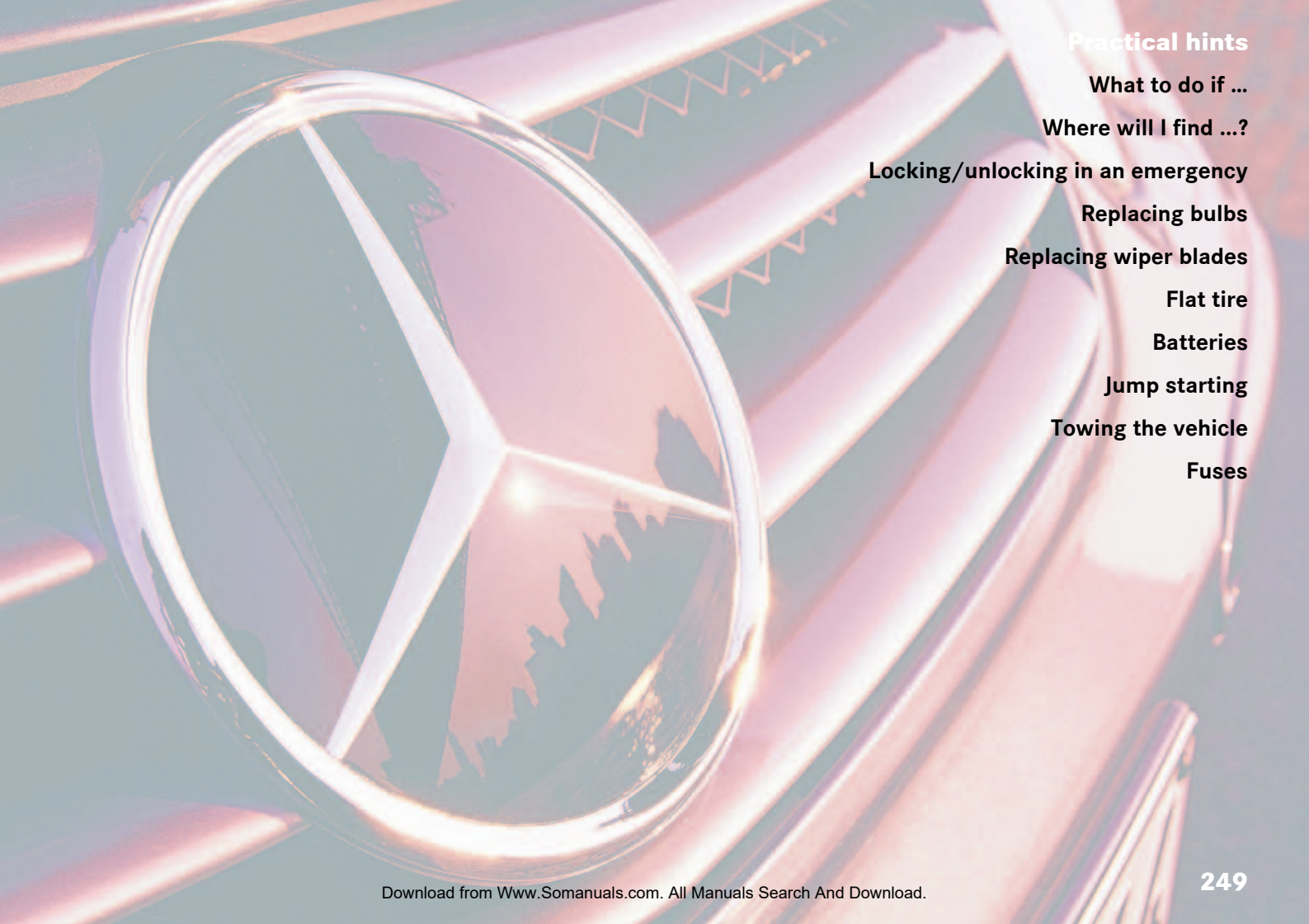

Practical hints

What to do if ...

Where will I find ...?

Locking/unlocking in an emergency

Replacing bulbs

Replacing wiper blades

Flat tire

Batteries

Jump starting



Towing the vehicle





Fuses

What to do if ...

What to do if ...

Lamps in instrument cluster

Problem	Possible cause	Suggested solution
 The yellow ABS/ESP warning lamp lights up while driving.	ESP is deactivated. Risk of accident! Adapt your speed and driving to the prevailing road conditions.	▶ Turn the ESP back on (▷ page 72). If the ESP cannot be turned back on, have the system checked at an authorized Mercedes-Benz Center as soon as possible.
 The yellow ABS/ESP warning lamp flashes while driving.	The ESP, ABS or traction control has come into operation because of detected traction loss in at least one tire. DISTRONIC* is deactivated.	▶ During take-off apply as little throttle as possible. ▶ While driving ease up on the accelerator. ▶ Adapt your speed and driving to the prevailing road and weather conditions. ▶ Do not deactivate the ESP (exceptions: ▷ page 71)). Failure to follow these instructions increases the risk of accidents.

Problem	Possible cause	Suggested solution
 <p>The yellow ABS malfunction indicator lamp comes on while driving.</p>	<p>The ABS has detected a malfunction and has switched off. The BAS and ESP are also switched off (see messages in display).</p> <p>The SBC brake system is still functioning normally but without ABS available.</p> <p>If the ABS control unit is malfunctioning, other systems such as Parktronic*, DISTRONIC*, or the automatic transmission may also be malfunctioning.</p>	<ul style="list-style-type: none"> ▶ Continue driving with added caution. Wheels may lock during hard braking, reducing steering capability. ▶ Have the system checked at an authorized Mercedes-Benz Center as soon as possible. <p>Failure to follow these instructions increases the risk of an accident.</p> <ul style="list-style-type: none"> ▶ Read and observe messages in the display (▷ page 257).
 <p>The red DTR indicator lamp lights up while driving.</p>	<p>You are too close to the vehicle in front of you to maintain selected speed.</p>	<ul style="list-style-type: none"> ▶ Apply the brakes immediately to increase the following distance.
 <p>The red DTR indicator lamp comes on while driving and you hear a warning sound.</p>	<ul style="list-style-type: none"> • You are gaining too rapidly on the vehicle ahead of you. • The distance warning system has recognized a stationary obstacle on your probable line of travel. 	<ul style="list-style-type: none"> ▶ Apply the brakes immediately. ▶ Carefully observe the traffic situation. You may need to brake or maneuver to avoid hitting an obstacle.
 <p>The white DTR indicator lamp lights up while driving.</p>	<p>The DISTRONIC* distance sensor has recognized a vehicle in front of you.</p>	



What to do if ...

Problem	Possible cause	Suggested solution
SRS The red SRS indicator lamp lights up while driving.	There is a malfunction in the restraint systems. The airbags or emergency tensioning device (ETD) could deploy unexpectedly or fail to activate in an accident.	► Drive with added caution to the nearest authorized Mercedes-Benz Center.

Warning!



In the event that a malfunction of the SRS is indicated as outlined above, the SRS may not be operational. For your safety, we strongly recommend that you visit an authorized Mercedes-Benz Center immediately to have the system checked; otherwise the SRS may not be activated when needed in an accident, which could result in serious or fatal injury, or it might deploy unexpectedly and unnecessarily which could also result in an accident and/or injury to you or to others.

Problem	Possible cause	Suggested solution
<p> (Canada only)  except Canada)</p> <p>The red brake warning lamp lights up while driving and you hear a warning sound.</p> <p>The red brake warning lamp lights up while driving</p>	<p>You are driving with the parking brake set, or there is a malfunction in the SBC brake system.</p> <p>There is insufficient brake fluid in the reservoir.</p>	<ul style="list-style-type: none"> ▶ Release the parking brake (▷ page 41). ▶ Read and observe messages in the display (▷ page 257). ▶ Risk of accident! Carefully stop the vehicle and notify an authorized Mercedes-Benz Center. Do not add brake fluid! This will not solve the problem.

Warning!





Driving with the brake warning lamp illuminated can result in an accident. Have your brake system checked immediately if the brake warning lamp stays on. Don't add brake fluid before checking the brake system.

Overfilling the brake fluid reservoir can result in spilling brake fluid on hot engine parts and the brake fluid catching fire. You can be seriously burned.



If you find that the brake fluid in the brake fluid reservoir has fallen to the minimum mark or below, have the brake system checked for brake pad thickness and leaks.

What to do if ...

Problem	Possible cause	Suggested solution
 <p>The red coolant warning lamp lights up when the engine is running.</p>	<p>There is insufficient coolant in the reservoir.</p> <p>If this warning lamp lights up frequently, there is a leak in the cooling system.</p> <p>If the coolant level is correct, the electric radiator fan may be broken.</p>	<ul style="list-style-type: none"> ▶ Immediately add coolant to prevent engine from overheating (▷ page 230). ▶ Have the cooling system checked. ▶ If the coolant temperature is below 257 °F (125 °C), you can continue driving to the nearest authorized Mercedes-Benz Center. ▶ Avoid high engine loads (e.g. driving uphill) and stop-and-go driving.
 <p>The red coolant warning lamp lights up while driving and you hear a warning sound.</p>	<p>The coolant temperature has exceeded 257 °F (125 °C).</p>	<ul style="list-style-type: none"> ▶ Stop as soon as possible and allow the engine and coolant to cool down.

Warning!





Driving when your engine is badly overheated can cause some fluids which may have leaked into the engine compartment to

catch fire. You could be seriously burned.

Steam from an overheated engine can cause serious burns and can occur just by opening the engine hood. Stay away from the engine if you see or hear steam coming from it.

Turn off the engine, get out of the vehicle and do not stand near the vehicle until it cools down.

Problem	Possible cause	Suggested solution
 The yellow roll bar warning lamp lights up or flickers when the engine is running.	The roll bar is not operational.	<ul style="list-style-type: none"> ▶ For safety reasons, always have the roll bar raised when driving with the retractable hardtop open. Attempt to raise the roll bar manually. ▶ Have the roll bar checked by an authorized Mercedes-Benz Center.
 The yellow fuel tank reserve warning lamp lights while driving.	The fuel level has gone below the reserve mark.	▶ Refuel at the next gas station (▷ page 225).
	The fuel cap is not closed tight.	▶ Check the fuel cap (▷ page 225).

Warning!



If the roll bar warning lamp does not light up, does not go out after a long time, flickers or lights up while driving as described above, then the roll bar system is not operating properly and may not activate in an accident. In this case, raise the roll bar manually (▷ page 61) before continuing to drive.

What to do if ...

Problem	Possible cause	Suggested solution
<p>CHECK ENGINE</p> <p>The yellow CHECK ENGINE malfunction indicator lamp comes on while driving.</p>	<p>There is a malfunction in:</p> <ul style="list-style-type: none"> • The fuel injection system • The ignition system • The emission control system • Systems which effect emissions <p>Such malfunctions may result in excessive emissions values and may switch the engine to its limp-home (emergency operation) mode.</p>	<p>▶ Have the vehicle checked as soon as possible by an authorized Mercedes-Benz Center.</p> <p>An on-board diagnostic connector is used by the service station to link the vehicle to the shop diagnostics system. It allows the accurate identification of system malfunctions through the readout of diagnostic trouble codes. It is located in the front left area of the footwell next to the parking brake.</p>
	<p>The fuel cap is not closed tightly.</p>	<p>▶ Check the fuel cap.</p>
	<p>Your gas tank is empty.</p>	<p>▶ After refuelling, start the engine three or four times in succession.</p> <p>The limp-home mode is canceled. You do not need to have your vehicle checked.</p>
<p> The red seat belt warning lamp lights up after starting the engine.</p>	<p>The warning lamp reminds you to fasten seat belts.</p>	<p>▶ Fasten your seat belt.</p>

Messages in the display

The control system shows warning and malfunction messages in the multifunction display.

Certain warning and malfunction messages are accompanied by an audible signal.

Address these messages accordingly and follow the additional instructions given in this Operator's Manual.

High priority messages appear in the multifunction display in red color.

Certain messages of high priority cannot be cleared from the multifunction display using the reset knob (▷ page 21) or a steering wheel button.

Other high priority messages and messages of less immediate priority (regular display colors) can be cleared from the multifunction display using the reset knob or one of the steering wheel buttons. These are then stored in the malfunction message memory (▷ page 118).

Warning!



All messages contain important information which should be taken note of and, where a malfunction is indicated, addressed as soon as possible at an authorized Mercedes-Benz Center.

Failure to repair condition noted may cause damage not covered by the Mercedes-Benz Limited Warranty, or result in property damage or personal injury.

Selecting the malfunction memory menu in the control system (▷ page 118) displays both cleared and uncleared messages.

Warning!



No messages will be displayed if either the instrument cluster or the multifunction display is inoperative.

Contact your nearest authorized Mercedes-Benz Center.



Turning the key in starter switch to position **2**, or pressing the KEY-LESS-GO* start/stop button (if so equipped) twice to position **2** causes all lamps as well as the multifunction display to come on. Ensure that they are all in working order before starting your journey.

On the pages that follow, you will find a compilation of all the messages that may appear in the display. High priority messages appear on a red background.

What to do if ...

Left display	Right display	Possible cause	Possible solution
ABC	Drive carefully!	The capability of the ABC system is restricted. This can impair handling.	<ul style="list-style-type: none"> ▶ Do not exceed a speed of 50 mph (80 km/h). ▶ Visit an authorized Mercedes-Benz Center as soon as possible.
		The vehicle is losing oil.	<ul style="list-style-type: none"> ▶ Stop your vehicle as soon as it is safe to do so.
Stop, car too low		The car is parked on an extremely uneven surface.	<ul style="list-style-type: none"> ▶ Press the vehicle level control button to select level 2 (▷ page 184).
		ABC is malfunctioning.	<ul style="list-style-type: none"> ▶ Stop and press the ABC button to select a higher vehicle level (▷ page 183). ▶ Do not turn steering wheel too far to avoid damaging the front fenders. ▶ Listen for scraping noises. ▶ Do not exceed a speed of 50 mph (80 km/h). ▶ Visit an authorized Mercedes-Benz Center as soon as possible.

Left display	Right display	Possible cause	Possible solution
ABC	Visit workshop!	The capability of the ABC system is restricted.	<ul style="list-style-type: none"> ▶ Do not exceed a speed of 50 mph (80 km/h). ▶ Visit an authorized Mercedes-Benz Center as soon as possible.
	Display defective Visit workshop!	The ABC display or the ABC system itself is malfunctioning.	▶ Visit an authorized Mercedes-Benz Center as soon as possible.
ABS	Defective! Visit workshop!	The ABS has detected a malfunction and has switched off. The ESP and BAS are also deactivated. The SBC brake system is still functioning normally but without ABS available.	<ul style="list-style-type: none"> ▶ Continue driving with added caution. ▶ Visit an authorized Mercedes-Benz Center as soon as possible. <p>Failure to follow these instructions increases the risk of accident.</p>
	Display defective Visit workshop!	ABS or the ABS display is malfunctioning.	<ul style="list-style-type: none"> ▶ Continue driving with added caution. ▶ Visit an authorized Mercedes-Benz Center as soon as possible. <p>Failure to follow these instructions increases the risk of accident.</p>



What to do if ...

Left display	Right display	Possible cause	Possible solution
BAS	Defective! Visit workshop!	The BAS has detected a malfunction and switched off. The ESP and ABS are also deactivated. The SBC brake system is still functioning normally but without ABS available.	<ul style="list-style-type: none"> ▶ Continue driving with added caution. ▶ Visit an authorized Mercedes-Benz Center as soon as possible. <p>Failure to follow these instructions increases the risk of accident.</p>
	Display defective Visit workshop!	BAS or the BAS display is malfunctioning.	<ul style="list-style-type: none"> ▶ Continue driving with added caution. ▶ Visit an authorized Mercedes-Benz Center as soon as possible. <p>Failure to follow these instructions increases the risk of accident.</p>

Left display	Right display	Possible cause	Possible solution
ESP	Defective! Visit workshop!	The ESP is deactivated because of a malfunction or an interrupted power supply. The SBC brake system is still functioning normally. The ABS may still be operational.	<ul style="list-style-type: none"> ▶ With the vehicle stationary, turn the steering wheel completely to the left and then to the right to synchronize the ESP. <p>If the ESP message does not go out:</p> <ul style="list-style-type: none"> ▶ Continue driving with added caution. ▶ Visit an authorized Mercedes-Benz Center as soon as possible. <p>Failure to follow these instructions increases the risk of accident.</p>
	Display defective Visit workshop!	ESP or the ESP display is malfunctioning.	<ul style="list-style-type: none"> ▶ Continue driving with added caution. ▶ Visit an authorized Mercedes-Benz Center as soon as possible. <p>Failure to follow these instructions increases the risk of accident.</p>



What to do if ...

Left display	Right display	Possible cause	Possible solution
Distronic	External fault Reactivate!	Distronic* is switched off and is temporarily unavailable.	▶ Try activating DISTRONIC* again later.
	Clear sensor! See Owner's Man.	Distronic* is switched off because the DISTRONIC* cover in the radiator grille is dirty.	▶ Clean the DISTRONIC* cover in the radiator grille (▷ page 246). ▶ Restart the vehicle.
	Visit workshop!	Distronic* is malfunctioning or the display is malfunctioning.	▶ Visit an authorized Mercedes-Benz Center as soon as possible.
P	Selector lever to P!	You have turned off the engine with the KEYLESS-GO* start/stop button* and opened the driver's door.	▶ Place the selector lever in position P .
Cruise Control	Visit workshop!	Cruise control or DISTRONIC* is malfunctioning.	▶ Have the cruise control or DISTRONIC* checked by an authorized Mercedes-Benz Center.

Left display	Right display	Possible cause	Possible solution
	Display defective	The instrument cluster display is malfunctioning.	<ul style="list-style-type: none"> ▶ Continue driving with added caution. ▶ Visit an authorized Mercedes-Benz Center as soon as possible.
	Visit workshop!	One or more main functions of the Tele Aid system are malfunctioning.	<ul style="list-style-type: none"> ▶ Have the Tele Aid system checked by an authorized Mercedes-Benz Center.
	Battery/Alternator Stop vehicle!	<p>The battery is malfunctioning.</p> <p>The SBC brake system requires electrical energy and therefore has only limited operation. Considerably greater brake pedal force is required and the stopping distance is increased.</p>	<ul style="list-style-type: none"> ▶ Stop the vehicle as soon as it is safe to do so. Adjust driving to be consistent with reduced braking responsiveness. ▶ Notify an authorized Mercedes-Benz Center.

What to do if ...



Left display	Right display	Possible cause	Possible solution
	Electric consumers offline!	The consumer battery has insufficient voltage and can no longer supply the convenience functions such as seat ventilation*.	The electrical consumers will come back online as soon as on-board voltage is sufficient.
	Battery/Alternator Stop vehicle!	<p>The battery was charged with a battery charger or jump started.</p> <p>The battery is no longer charging.</p> <p>Possible causes</p> <ul style="list-style-type: none"> • alternator malfunctioning • broken poly-V-belt <p>Do not forget that the brake system requires electrical energy and may be operating with restricted capability. Considerably greater brake pedal force is required and the stopping distance is increased.</p>	<p>▶ Have the battery checked at a service station.</p> <p>▶ Stop immediately and check the poly-V-belt.</p> <p>If it is broken</p> <p>▶ Do not continue to drive. Notify an authorized Mercedes-Benz Center.</p> <p>If it is in order</p> <p>▶ Drive immediately to the nearest authorized Mercedes-Benz Center. Adjust driving to be consistent with reduced braking responsiveness.</p>

Left display	Right display	Possible cause	Possible solution
	Brake lining wear! Visit workshop!	The brake pads have reached their wear limit.	▶ Have the brake pads replaced as soon as possible.
	Brake defective! Stop vehicle!	The SBC brake system is in emergency operation mode. Considerably greater brake pedal force is required and the stopping distance is increased. The maximum speed is limited to 55 mph (90 km/h).	▶ Do not drive any further. ▶ Stop the vehicle and notify an authorized Mercedes-Benz Center. ▶ Significantly greater force must be applied to the brake pedal. ▶ Call for roadside assistance.
	Reduced brake effect Start engine!	The battery has insufficient voltage and cannot supply sufficient power to the SBC brake system.	▶ Start the engine. As soon as the engine is running, the message disappears.



Brake pad thickness must be visually checked by a qualified technician at the intervals specified in the Service booklet.

What to do if ...

Left display	Right display	Possible cause	Possible solution
Except Canada:  Canada only: 	Reduced brake effect Visit workshop! Incr. braking dist. Visit workshop!	The SBC brake system is in emergency operation mode. Considerable brake pedal force is required and the stopping distance is increased.	<ul style="list-style-type: none"> ▶ Continue driving with added caution. ▶ Visit an authorized Mercedes-Benz Center immediately. Adjust driving to be consistent with reduced braking responsiveness.
	Brake fluid below min. level! Visit workshop!	There is insufficient brake fluid in the reservoir.	<ul style="list-style-type: none"> ▶ Risk of accident! Stop the vehicle and notify an authorized Mercedes-Benz Center. Do not add brake fluid! This will not solve the problem.



If you find that the brake fluid in the brake fluid reservoir has fallen to the minimum mark or below, have the brake system checked for brake pad thickness and leaks.

Warning!

Driving while these messages are displayed can result in an accident. Have your brake system checked immediately.

If there is a malfunction in the SBC brake system, we recommend that the vehicle be transported with all wheels off the ground using flatbed or appropriate wheel lift/dolly equipment. A tow bar must be used if circumstances do not permit the use of the recommended towing methods and the vehicle requires towing with all four wheels on the ground. Towing the vehicle with all four wheels on the ground is only permissible for distances up to 30 miles (50 km) and at a speed not to exceed 30 mph (50 km/h). For more information, refer to "Towing the vehicle" (▷ page 325).

If the SBC brake system enters its emergency operation mode, the driver must apply significantly greater brake pedal pressure and depress the pedal much further than normal to obtain braking effect.

If necessary, apply full pressure to the brake pedal. Brakes are only applied to the front wheels. Stopping distance is increased!



Low brake fluid in the reservoir may cause the braking system to fail!

If necessary, apply full pressure to the brake pedal. Brakes are only applied to the front wheels. Stopping distance is increased!

Low brake fluid in the reservoir may cause the braking system to fail!





Don't add brake fluid before checking the brake system. Overfilling the brake fluid reservoir can result in spilling brake fluid on hot engine parts and the brake fluid catching fire. You can be seriously burned.





What to do if ...

Left display	Right display	Possible cause	Possible solution
Except Canada: 	Service brake Visit workshop!	There are malfunctions, but the SBC brake system is operating normally.	<ul style="list-style-type: none"> ▶ Visit an authorized Mercedes-Benz Center as soon as possible.
Canada only: 	Incr. braking distance Start engine!	The battery has insufficient voltage and cannot supply sufficient power to the SBC brake system.	<ul style="list-style-type: none"> ▶ Start the engine. The message disappears when sufficient voltage is available.
	Brakes overheated! Drive carefully!	The brake system is overheated due to an excessive load on the brakes.	<ul style="list-style-type: none"> ▶ Relieve the load on the brake system. ▶ Drive more smoothly and think ahead to avoid unnecessary braking. ▶ When driving down steep grades, shift into a lower gear to use the engine's braking power (▷ page 139). ▶ Cautiously continue driving so that the air stream will cool down the brakes.



Left display	Right display	Possible cause	Possible solution
	Chip card Check battery!	The KEYLESS-GO* card batteries are discharged.	▶ Change the batteries (▷ page 294).
	Chip card not recognised!	The KEYLESS-GO* card is not recognized while the engine is running because <ul style="list-style-type: none"> • the card is not in the vehicle • there is strong radio-frequency interference 	▶ Stop the vehicle as soon as it is safe to do so. ▶ Search for the card or continue to operate the vehicle with the key. Otherwise the vehicle cannot be centrally locked nor can the engine be started again after the engine is stopped.
		The KEYLESS-GO* card is momentarily not recognized.	▶ Change the position of the card in the vehicle. ▶ Operate the vehicle with the key if necessary.
	Chip card still in vehicle!	A KEYLESS-GO* card left in the vehicle was recognized while locking the vehicle from the outside.	▶ Take the card out of the vehicle.
	KEYLESS-GO Visit workshop!	The KEYLESS-GO* system is malfunctioning.	▶ Visit an authorized Mercedes-Benz Center as soon as possible.

What to do if ...

Left display	Right display	Possible cause	Possible solution
	Chip card! Do not forget!	This display appears (for a maximum of 60 seconds) if the driver's door is opened with the engine shut off and no key in the starter switch. Message is only a reminder.	<ul style="list-style-type: none">▶ Insert key in the starter switch.▶ Take the KEYLESS-GO* card with you when leaving the vehicle.
	Function not available!	This display appears if button  or  on the multifunction steering wheel is pressed and the vehicle is not equipped with a telephone.	

Left display	Right display	Possible cause	Possible solution
	KEYLESS GO Check system	The KEYLESS-GO* system is malfunctioning.	▶ Visit an authorized Mercedes-Benz Center as soon as possible.
	Key Do not forget	This display appears (for a maximum of 60 seconds) if the driver's door is opened with the engine shut off and no key in the starter switch. Message is only a reminder.	▶ Insert key in the starter switch. ▶ Take the SmartKey with KEYLESS-GO* with you when leaving the vehicle.
	Entry position Do not drive!	Seat, mirrors and steering wheel have not yet moved into their preset driving positions.	▶ Wait until the seat, mirrors and steering wheel have moved to their driving positions. The message disappears.
Except Canada:  Canada only: 	Release parking brake!	You are driving with the parking brake set.	▶ Release the parking brake (▷ page 41).

What to do if ...

Left display	Right display	Possible cause	Possible solution
	Seat belt system Visit workshop!	The seat belt system is malfunctioning.	▶ Visit an authorized Mercedes-Benz Center as soon as possible.
	Close trunk lid!	This message will appear whenever the trunk lid is open.	▶ Close the trunk lid.
	Close trunk separator!	You are trying to open or close the roof even though the luggage cover in the trunk is not pulled out.	▶ Pull out the luggage cover and secure it (▷ page 160).
	Coolant Check level!	The coolant level is too low.	<ul style="list-style-type: none"> ▶ Add coolant (▷ page 230). ▶ If you have to add coolant frequently, have the cooling system checked by an authorized Mercedes-Benz Center.

Warning!



Do not spill antifreeze on hot engine parts. Antifreeze contains ethylene glycol which may burn if it comes into contact with hot engine parts. You can be seriously burned.



Do not ignore the low engine coolant level warning. Extended driving with this message and symbol displayed may cause serious engine damage not covered by the Mercedes-Benz Limited Warranty.

Do not drive without sufficient amount of coolant in the cooling system. The engine will overheat, causing major engine damage.

Left display	Right display	Possible cause	Possible solution
	Coolant Stop, engine off!	The coolant is too hot. The poly-V-belt could be broken.	<ul style="list-style-type: none"> ▶ Stop the vehicle. ▶ Only start the engine again after the message disappears. You could otherwise damage the engine. ▶ Stop immediately and check the poly-V-belt. ▶ If it is broken, do not drive any further. Notify an authorized Mercedes-Benz Center. If it is in order, drive immediately to the nearest authorized Mercedes-Benz Center.

Warning!





Driving when your engine is badly overheated can cause some fluids which may have leaked into the engine compartment to

catch fire. You could be seriously burned. Steam from an overheated engine can cause serious burns and can occur just by opening the engine hood. Stay away from the engine if you see or hear steam coming from it. Turn off the engine, get out of the vehicle

and do not stand near the vehicle until it cools down. The engine should not be operated with the coolant temperature above 266°F (130°C). Doing so may cause serious engine damage which is not covered by the Mercedes-Benz Limited Warranty.

What to do if ...

Left display	Right display	Possible cause	Possible solution
	Coolant Visit workshop!	The cooling fan for the coolant is malfunctioning.	<ul style="list-style-type: none"> ▶ Observe the coolant temperature gauge. ▶ Have the fan replaced as soon as possible.
	Low beam, left	The left low beam lamp is malfunctioning.	▶ Visit an authorized Mercedes-Benz Center as soon as possible.
	Low beam, right	The right low beam lamp is malfunctioning.	▶ Visit an authorized Mercedes-Benz Center as soon as possible.
	Display defective Visit workshop!	The display for the lights is malfunctioning.	▶ Visit an authorized Mercedes-Benz Center as soon as possible.
	Turn signal R, L Substitute lamp on!	The left rear turn signal lamp is malfunctioning. A backup bulb has been brought into use.	▶ Replace the bulb as soon as possible.
	Turn signal R, R Substitute lamp on!	The right rear turn signal lamp is malfunctioning. A backup bulb has been brought into use.	▶ Replace the bulb as soon as possible.

Left display	Right display	Possible cause	Possible solution
	L. turn sig. reflectr	The left turn signal in the side mirror is malfunctioning. This message will only appear if all light emitting diodes have stopped working.	► Have the LEDs replaced as soon as possible.
	R. turn sig. reflectr	The right turn signal in the side mirror is malfunctioning. This message will only appear if all light emitting diodes have stopped working.	► Have the LEDs replaced as soon as possible.
	Turn signal F, L Substitute lamp on!	The left front turn signal lamp is malfunctioning. A backup bulb has been brought into use.	► Replace the bulb as soon as possible.
	Turn signal F, R Substitute lamp on!	The right front turn signal lamp is malfunctioning. A backup bulb has been brought into use.	► Replace the bulb as soon as possible.
	Brake light! Visit workshop!	Brake lamp illumination is delayed or lamp is permanently on.	► Visit an authorized Mercedes-Benz Center as soon as possible.





What to do if ...

Left display	Right display	Possible cause	Possible solution
	Brake lamp, L Substitute lamp on!	The left brake lamp is malfunctioning. A backup bulb has been brought into use.	▶ Visit an authorized Mercedes-Benz Center as soon as possible.
	Brake lamp, R Substitute lamp on!	The right brake lamp is malfunctioning. A backup bulb has been brought into use.	▶ Visit an authorized Mercedes-Benz Center as soon as possible.
	3rd brake light	The high mounted brake lamp is malfunctioning.	▶ Visit an authorized Mercedes-Benz Center as soon as possible.
	High beam, left	The left high beam lamp is malfunctioning.	▶ Replace the bulb as soon as possible.
	High beam, right	The right high beam lamp is malfunctioning.	▶ Replace the bulb as soon as possible.
	Fr. left marker lamp	The front left side marker lamp is malfunctioning.	▶ Replace the bulb as soon as possible.
	Fr. rt marker lamp	The front right side marker lamp is malfunctioning.	▶ Replace the bulb as soon as possible.
	Re. left marker lamp	The rear left side marker lamp is malfunctioning.	▶ Replace the bulb as soon as possible.
	Re. rt marker lamp	The rear right side marker lamp is malfunctioning.	▶ Replace the bulb as soon as possible.

Left display	Right display	Possible cause	Possible solution
	Licence plate lamp, L	The left licence plate lamp is malfunctioning.	► Replace the bulb as soon as possible.
	Licence plate lamp, R	The right licence plate lamp is malfunctioning.	► Replace the bulb as soon as possible.
	Front foglamp, L	The left front fog lamp is malfunctioning.	► Replace the bulb as soon as possible.
	Front foglamp, R	The right front fog lamp is malfunctioning.	► Replace the bulb as soon as possible.
	Rear foglight, L	The left rear fog lamp is malfunctioning.	► Replace the bulb as soon as possible.
	Rear foglight, R	The right rear fog lamp is malfunctioning.	► Replace the bulb as soon as possible.
	Reverse lamp, L	The left backup lamp is malfunctioning.	► Replace the bulb as soon as possible.
	Reverse lamp, R	The right backup lamp is malfunctioning.	► Replace the bulb as soon as possible.

What to do if ...

Left display	Right display	Possible cause	Possible solution
	Tail lamp, L Substitute lamp on!	The left tail lamp is malfunctioning. A backup bulb has been brought into use.	▶ Visit an authorized Mercedes-Benz Center as soon as possible.
	Tail lamp, R Substitute lamp on!	The right tail lamp is malfunctioning. A backup bulb has been brought into use.	▶ Visit an authorized Mercedes-Benz Center as soon as possible.
	Fr. left parkg lamp Substitute lamp on!	The left front parking lamp is malfunctioning. A backup bulb has been brought into use.	▶ Replace the bulb as soon as possible.
	Fr. right parkg lamp Substitute lamp on!	The right front parking lamp is malfunctioning. A backup bulb has been brought into use.	▶ Replace the bulb as soon as possible.

Left display	Right display	Possible cause	Possible solution
	Light sensor Visit workshop!	The light sensor is malfunctioning. The headlamps switch on automatically.	<ul style="list-style-type: none"> ▶ In the control system, set lamp operation to manual (▷ page 124). ▶ Switch on headlamps using the exterior lamp switch.
	Visit workshop!	There may be a malfunction in the <ul style="list-style-type: none"> • fuel injection system • ignition system • exhaust system • fuel system 	▶ Have the engine checked as soon as possible by an authorized Mercedes-Benz Center (▷ page 256).
	Close hood!	You are driving with the hood open.	▶ Close the hood (▷ page 228).
	Engine oil level Stop, engine off!	There is no oil in the engine. There is a danger of engine damage.	<ul style="list-style-type: none"> ▶ Carefully bring the vehicle to a halt as soon as possible. ▶ Turn off the engine. ▶ Add engine oil.

What to do if ...

Left display	Right display	Possible cause	Possible solution
	Engine oil level Check level!	The engine oil level is too low.	▶ Check the engine oil level (▷ page 228) and add oil as required.
	Engine oil level Reduce oil level!	You have added too much engine oil. There is a risk of damaging the engine or the catalytic converter.	▶ Have oil siphoned. Observe all legal requirements with respect to its disposal.
	Engine oil Visit workshop!	The engine oil has dropped to a critical level.	▶ Check the engine oil level (▷ page 228) and add oil as required. ▶ If you must add engine oil frequently, have the engine checked for possible leaks.
		There is water in the oil.	▶ Have the oil checked.
	Engine oil level Visit workshop!	The measuring system is malfunctioning.	▶ Have the measuring system checked by an authorized Mercedes-Benz Center.

Left display	Right display	Possible cause	Possible solution
	Tire pressure Caution tire defect!	One or more tires is rapidly deflating.	<ul style="list-style-type: none"> ▶ Carefully bring the vehicle to a halt, avoiding abrupt steering and braking maneuvers. ▶ Change the wheel (▷ page 312).
	Tire pressure Check tires!	The tire pressure in one or more tires is already below the minimum value.	<ul style="list-style-type: none"> ▶ Carefully bring the vehicle to a halt, avoiding abrupt steering and braking maneuvers. ▶ Change the wheel (▷ page 312).
		The tire pressure in one or more tires is low.	▶ Check and correct tire pressure as required (▷ page 236).

Warning!



Do not drive with a flat tire. A flat tire affects the ability to steer or brake the vehicle. You may lose control of the vehicle.

Continued driving with a flat tire will cause excessive heat build-up and possibly a fire.

What to do if ...

Left display	Right display	Possible cause	Possible solution
Tire pressure control activated!	Pressure display after driving several mins.	The tire pressure is being checked.	
	Reactivate tire press. monit.	The tire inflation pressure monitor* is deactivated.	▶ Activate the tire inflation pressure monitor* (▷ page 237).
	Tire press. monit. currently inactive	The tire inflation pressure monitor* is unable to monitor the tire pressure due to: <ul style="list-style-type: none"> • the presence of several wheel sensors in the vehicle • excessive wheel sensor temperatures • a nearby radio interference source • unrecognized wheel sensors mounted 	▶ Check the tire pressure at the next service station.

Warning!



Do not drive with a flat tire. A flat tire affects the ability to steer or brake the vehicle.

You may lose control of the vehicle. Continued driving with a flat tire will cause excessive heat build-up and possibly a fire.

Left display	Right display	Possible cause	Possible solution
	Tire press. monit. Visit workshop!	The tire inflation pressure monitor is malfunctioning. A wheel without proper sensor was installed.	<ul style="list-style-type: none"> ▶ Have the tire inflation pressure monitor checked by an authorized Mercedes-Benz Center. ▶ Change the wheel.
	Tire pressure, RL Caution tire defect!	The left rear tire is rapidly deflating.	<ul style="list-style-type: none"> ▶ Carefully bring the vehicle to a halt, avoiding abrupt steering and braking maneuvers. ▶ Change the wheel (▷ page 312).
	Tire pressure, RL Check tires!	The left rear tire pressure is low.	<ul style="list-style-type: none"> ▶ Carefully bring the vehicle to a halt. ▶ Check the tire pressure. ▶ Change the wheel (▷ page 312).

Warning!



Do not drive with a flat tire. A flat tire affects the ability to steer or brake the vehicle. You may lose control of the vehicle.

Continued driving with a flat tire will cause excessive heat build-up and possibly a fire.

What to do if ...

Left display	Right display	Possible cause	Possible solution
	Tire pressure, RR Caution tire defect!	The right rear tire is rapidly deflating.	<ul style="list-style-type: none"> ▶ Carefully bring the vehicle to a halt, avoiding abrupt steering and braking maneuvers. ▶ Change the wheel (▷ page 312).
	Tire pressure, RR Check tires!	The right rear tire pressure is low.	<ul style="list-style-type: none"> ▶ Carefully bring the vehicle to a halt. ▶ Check the tire pressure. ▶ Change the wheel (▷ page 312).
	Tire pressure, FL Caution tire defect!	The left front tire is rapidly deflating.	<ul style="list-style-type: none"> ▶ Carefully bring the vehicle to a halt, avoiding abrupt steering and braking maneuvers. ▶ Change the wheel (▷ page 312).

Warning!



Do not drive with a flat tire. A flat tire affects

the ability to steer or brake the vehicle. You may lose control of the vehicle. Continued driving with a flat tire will cause excessive heat build-up and possibly a fire.

Left display	Right display	Possible cause	Possible solution
	Tire pressure, FL Check tires!	The left front tire pressure is low.	<ul style="list-style-type: none"> ▶ Carefully bring the vehicle to a halt. ▶ Check the tire pressure. ▶ Change the wheel (▷ page 312).
	Tire pressure, FR Caution tire defect!	The right front tire is rapidly deflating.	<ul style="list-style-type: none"> ▶ Carefully bring the vehicle to a halt, avoiding abrupt steering and braking maneuvers. ▶ Change the wheel (▷ page 312).
	Tire pressure, FR Check tires!	The right front tire pressure is low.	<ul style="list-style-type: none"> ▶ Carefully bring the vehicle to a halt. ▶ Change the wheel (▷ page 312).





Warning!





Do not drive with a flat tire. A flat tire affects

the ability to steer or brake the vehicle. You may lose control of the vehicle. Continued driving with a flat tire will cause excessive heat build-up and possibly a fire.

What to do if ...

Left display	Right display	Possible cause	Possible solution
	Remove key!	You have forgotten to remove the key.	▶ Remove the key from the starter switch.
	Replace key	The batteries in the key are dead.	▶ Change the batteries (▷ page 293).
	Automat. light on Remove key!		▶ Remove the key from the starter switch.
	Reserve fuel	The fuel level has dropped below the reserve mark.	▶ Refuel at the next gas station (▷ page 225).
		The fuel cap is not closed tightly.	▶ Check the fuel cap (▷ page 225).
	Door open!	You are attempting to drive with one or more doors open.	▶ Close the doors.
	Raise roll-over bar	The roll bar is malfunctioning.	▶ Raise the roll bar using the roll bar switch (▷ page 61). ▶ Have the roll bar checked by an authorized Mercedes-Benz Center.
	Display defective Visit workshop!	The displays for several systems have malfunctioned. Some systems themselves may also have malfunctioned.	▶ Have the electronic systems checked by an authorized Mercedes-Benz Center.

Left display	Right display	Possible cause	Possible solution
	Visit workshop!	The retractable hardtop is malfunctioning.	▶ Have the retractable hardtop checked by an authorized Mercedes-Benz Center.
	Lock hardtop	The roof is not properly locked.	▶ Push or pull on the retractable hardtop switch until the indicator lamp in the switch goes out and the roof is completely open or closed (▷ page 159).
	Display defective Visit workshop!	Certain electronic systems are unable to relay information to the control system. The following systems may have failed: <ul style="list-style-type: none"> • Coolant temperature gauge • Tachometer • Cruise control display 	▶ Have the electronic systems checked by an authorized Mercedes-Benz Center (▷ page 256).
	Washer fluid Check level!	The fluid level has dropped to about 1/3 of total reservoir capacity.	▶ Add washer fluid (▷ page 233).

Where will I find ...?

Where will I find ...?

First aid kit

The first aid kit is located in storage space under the passenger seat.

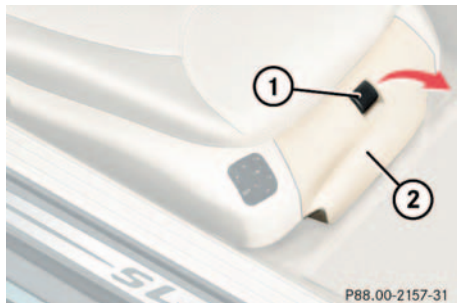

1 Handle

2 Lid

- ▶ Pull the handle **1** up.
- ▶ Fold the lid **2** down.

You can now remove the first-aid kit.



Check expiration dates and contents for completeness at least once a year and replace missing/expired items.

Vehicle tool kit

The vehicle tool kit is stored in the space underneath the trunk floor.

- ▶ Lift up the trunk floor cover.

You can now remove the tools and accessories.

The vehicle tool kit includes

- One pair of universal pliers
- Two open-end wrenches
- One hex-socket wrench
- One interchangeable slot/Phillips screwdriver
- One towing eye bolt
- One wheel wrench
- One alignment bolt
- One fuse extractor
- One fuse chart for the main fuse box
- Spare fuses

The jack is exclusively designed for lifting the vehicle during a wheel change. Always lower the vehicle on sufficient capacity jack stands before working under the vehicle.

Vehicles with spare wheel

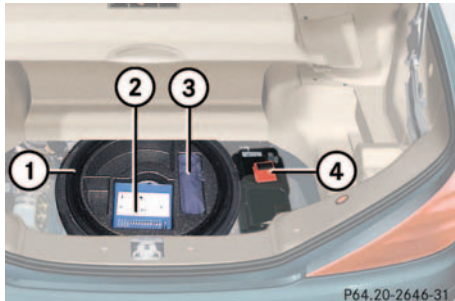

- 1 Spare wheel
- 2 Electric air pump
- 3 Vehicle tool kit
- 4 Battery for electrical consumers

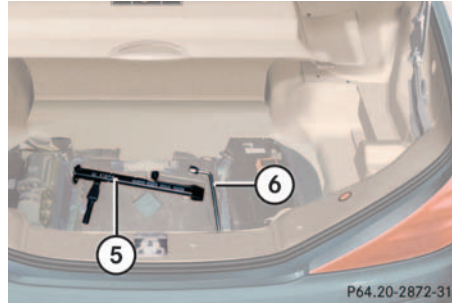

- 5 Jack (under spare wheel)
- 6 Wheel wrench (under spare wheel)

Vehicles with TIREFIT kit

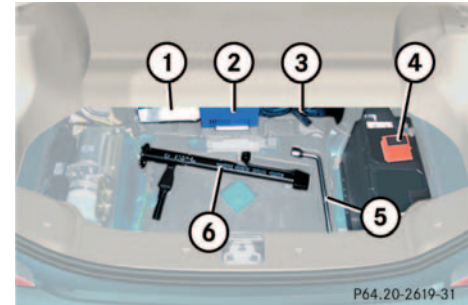

- 1 TIREFIT kit
- 2 Electric air pump
- 3 Vehicle tool kit
- 4 Battery for electrical consumers
- 5 Wheel wrench
- 6 Jack

Locking/unlocking in an emergency

Locking/unlocking in an emergency

Unlocking the vehicle

Unlocking the driver's door

If you are unable to unlock the driver's door using the key, open the door using the mechanical key.

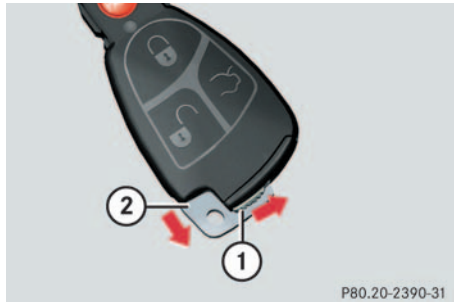

- 1 Mechanical key locking tab
- 2 Mechanical key

- ▶ Move locking tab **1** direction of arrow and slide the mechanical key out of the housing.

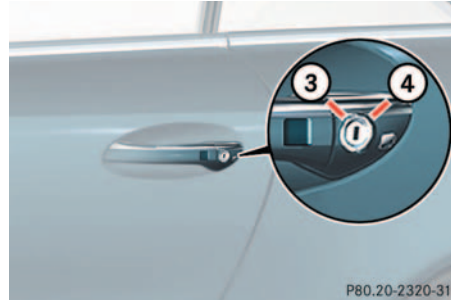



- 3 Unlocking
- 4 Locking

- ▶ Unlock the door with the mechanical key. To do so, push the mechanical key in the lock until it stops and turn it to the left.



Unlocking your vehicle with the mechanical key will trigger the anti-theft alarm system. To cancel the alarm, do one of the following:

- Press button  or  on the key.
- Insert the key in the starter switch.
- Press the KEYLESS-GO* start/stop button (▷ page 30).

Locking/unlocking in an emergency

Unlocking the trunk

If you are unable to unlock the trunk with the key, open the trunk with the mechanical key as follows:

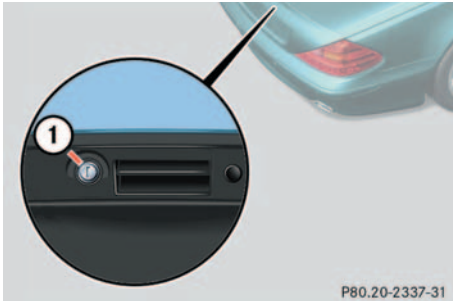

Trunk lid lock

1 Unlocking

- ▶ Insert the mechanical key into the trunk lid lock.
- ▶ Perform the following two steps simultaneously:
 - ▶ Turn the key counterclockwise to position 1.
 - ▶ Pull the trunk lid handle and lift lid.

Unlocking interior storage compartments

Locking storage areas in the passenger compartment include:

- the glove box
- the storage space under the armrest
- the rear storage compartments

If these cannot be unlocked by means of the key, the KEYLESS-GO* card or the central locking button, use the mechanical key to open the glove box.



The storage space under the armrest and the rear storage compartments can only be unlocked using the mechanical key at the glove box lock.

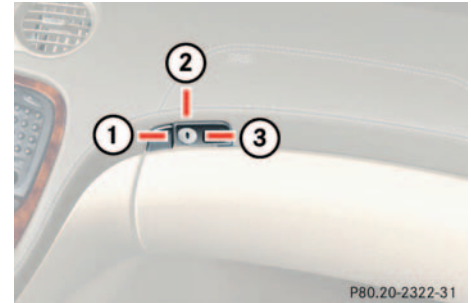

- 1 Separately unlock storage compartments
- 2 Centrally lock/unlock storage compartments
- 3 Separately lock storage compartments

- ▶ Slide mechanical key out of key housing (▷ page 290).
- ▶ Insert the mechanical key into the glove box lock and turn it to position 2. All storage compartments are now unlocked.

Locking/unlocking in an emergency

Locking the vehicle

If you are unable to lock the vehicle with the electronic key, lock it with the mechanical key as follows:

- ▶ Close the passenger door and the trunk.
- ▶ Press the central locking switch in the cockpit (▷ page 91).
- ▶ Check to see whether the locking knob on the passenger door is still visible. If necessary push it down manually.
- ▶ Lock the driver's door with the mechanical key.
- ▶ Lock the trunk if necessary with the mechanical key (▷ page 83).

Lowering the Easy Pack feature manually

If the Easy Pack feature does not fully lower the retractable hardtop into the trunk compartment and you are unable to close the trunk lid, follow the instructions below.

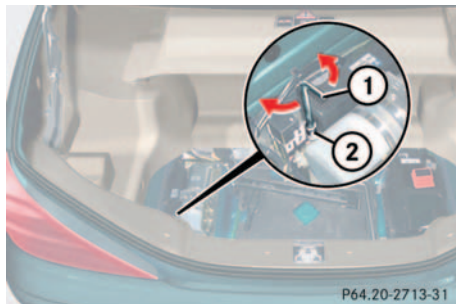

- 1 Hex-socket wrench
- 2 Locking screw

- ▶ Remove the trunk floor from the trunk.
- ▶ Lift up the lid located at the lower left side of the trunk.
- ▶ Have a second person lift and hold the retracted hardtop.

- ▶ Using the hex-socket wrench provided in the vehicle tool kit, carefully turn the locking screw **2** approximately one quarter turn.
- ▶ Hook luggage cover into holders (▷ page 160).
- ▶ Let go of the hardtop. It should gradually lower into the trunk.
- ▶ When top is completely lowered, return locking screw **2** to its original position.



Do not overtighten the screw.

- ▶ Close the lid.
- ▶ Replace the trunk floor.
- ▶ Visit an authorized Mercedes-Benz Center as soon as possible.

Locking/unlocking in an emergency

Changing batteries

If the batteries in the key or the KEY-LESS-GO* card are discharged, the vehicle can no longer be locked or unlocked. It is recommended to have the batteries replaced at an authorized Mercedes-Benz Center.

Warning!



Keep the batteries out of reach of children.
If a battery is swallowed, seek medical help immediately.

Batteries contain materials that can harm the environment if disposed of improperly. Recycling of batteries is the preferred method of disposal. Many states require sellers of batteries to accept old batteries for recycling.



When changing batteries, always replace both batteries. The required replacement batteries are available at any Mercedes-Benz Center.

Key

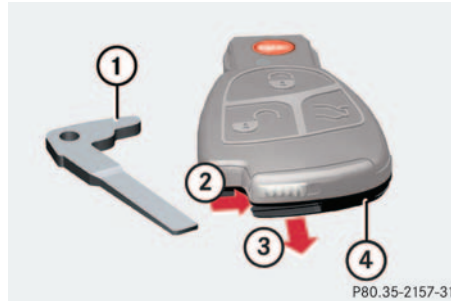

- 1 Mechanical key
- 2 Unlatching battery compartment
- 3 Pulling out battery compartment
- 4 Mechanical key locking tab

Replacement batteries: Lithium, type CR 2025 or equivalent.

- ▶ Remove the mechanical key 1 (▷ page 290).

- ▶ Insert the mechanical key in side opening and push gray slide in direction of arrow 2.

The battery compartment is unlatched.

- ▶ Pull the battery compartment out of the key housing in direction of arrow 3.
- ▶ Remove the batteries.

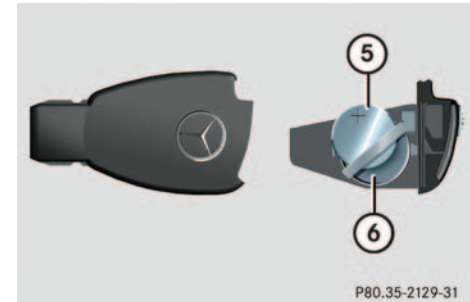

- 5 Battery
- 6 Contact spring

- ▶ Using a lint-free cloth, insert new batteries under the contact spring with the plus (+) side facing up.
- ▶ Return battery compartment into housing until locked in place.

Locking/unlocking in an emergency

KEYLESS-GO card*

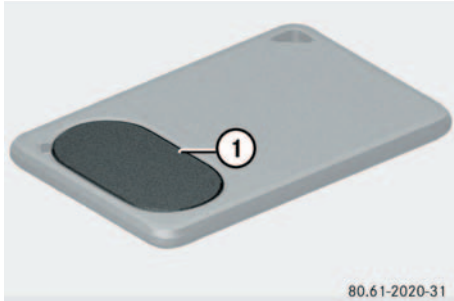

1 Battery cover

Replacement batteries: Lithium, type CR 2025 or equivalent.

- ▶ Pry open the cover **1**.
- ▶ Remove the batteries.
- ▶ Install new batteries as indicated by the “+” and “-” markings in the KEYLESS-GO card.
- ▶ Replace battery cover **1**.

Replacing bulbs

Bulbs

Safe vehicle operation depends on proper exterior lighting and signaling. It is therefore essential that all bulbs and lamp assemblies are in good working order at all times.

Correct headlamp adjustment is extremely important. Have headlamps checked and readjusted at regular intervals and when a bulb has been replaced. See your authorized Mercedes-Benz Center for headlamp adjustment



If the headlamps are fogged up on the inside as a result of high humidity, driving the vehicle a distance should clear up the fogging.



Backup bulbs will be brought into use when the following lamps malfunction:

- Turn signal lamps
- Brake lamps
- Parking lamps
- Tail lamps

Replacing bulbs

Front lamps

Lamp	Type
1 Additional turn signal	LED
2 Turn signal lamp	1156 A
3 Low beam ¹	Xenon D2S-35 W
4 High beam	H7 (55 W)
Parking and standing lamps	W 5 W
5 Fog lamp	HB4/9006 (55 W)
6 Side marker lamp	W 5 W

¹ Vehicles with Bi-Xenon* headlamps: Low beam and high beam use the same D2S-35W lamp. Do not replace the Xenon and Bi-Xenon* bulbs yourself. See your authorized Mercedes-Benz Center.

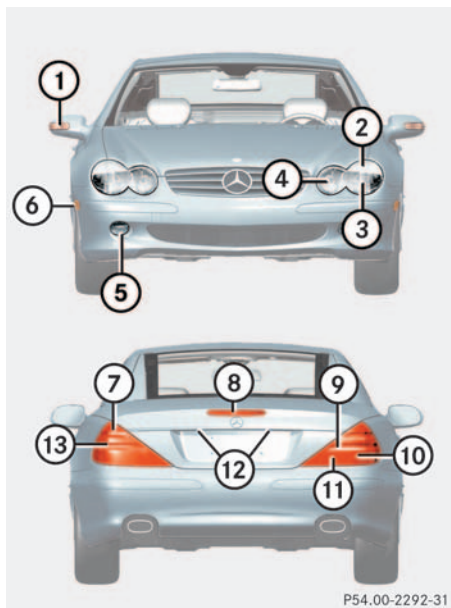

Rear lamps

Lamp	Type
7 Rear fog lamp, driver's side; replacement	P 21 W 1156/32 cp
8 High mounted brake lamp	LED
9 Backup lamp; replacement	P 21 W 1156/32 cp
10 Tail, parking and standing lamp, side marker	LED
11 Tail, parking and standing lamp, brake lamp	LED
12 License plate lamps	C 5 W
13 Turn signal lamp; replacement	P 21 W 1156/32 cp

Warning!

Bulbs and bulb sockets can be very hot. Allow the lamp to cool down before changing a bulb.

Keep bulbs out of reach of children.

Halogen lamps contain pressurized gas. A bulb can explode if you:

- touch or move it when hot,
- drop the bulb,
- scratch the bulb.

Wear eye and hand protection.

Because of high voltage in Xenon lamps, it is dangerous to replace the bulb or repair the lamp and its components. We recommend that you have such work done by a qualified technician.

Notes on bulb replacement

- Only use 12 volt bulbs of the same type and with the specified watt rating.
- Switch lights off before changing a bulb to prevent short circuits.
- Always use a clean lint-free cloth when handling bulbs.
- Your hands should be dry and free of oil and grease.
- If the newly installed bulb does not light up, visit an authorized Mercedes-Benz Center.

Have the LEDs and bulbs for the following lamps replaced by an authorized Mercedes-Benz Center:

- the additional turn signals in the exterior rear view mirrors
- the high mounted brake lamp
- the brake lamps
- the parking lamps and the side marker lamps in the tail lamp assemblies
- the rear fog lamps
- the low beam (Xenon or Bi-Xenon*) lamps
- the front fog lamps

Replacing bulbs

Replacing bulbs for front lamps

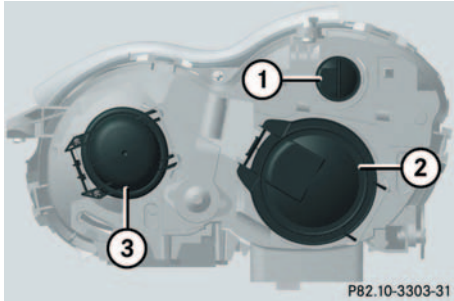

- 1 Bulb socket for turn signal lamp
- 2 Low beam lamp cover (Xenon or Bi-Xenon* lamp). **Do not remove.**
- 3 High beam lamp cover

Warning!



Do not remove the cover for the Xenon or Bi-Xenon* headlamp. Because of high voltage in Xenon and Bi-Xenon* lamps, it is dangerous to replace the bulb or repair the lamp and its components. We recommend that you have such work done by a qualified technician.

Replacing front turn signal bulb

- ▶ Switch off the lights.
- ▶ Open the hood (▷ page 227).
- ▶ Twist bulb socket **1** counterclockwise and pull out.
- ▶ Push bulb into socket, turn counterclockwise and remove.
- ▶ Insert new bulb in socket, push and twist clockwise.
- ▶ Reinsert bulb socket in lamp and twist clockwise.

Replacing high beam bulbs

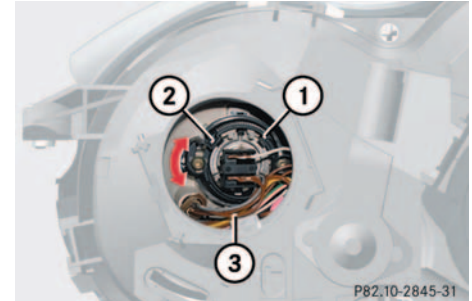

- 1 High beam bulbs
- 2 Locking mechanism
- 3 Parking and standing lamps

- ▶ Switch off the lights.
- ▶ Open the hood (▷ page 227).
- ▶ Press ends of headlamp cover tab together and remove cover.
- ▶ Pull electrical connector off.
- ▶ Turn the locking mechanism **2** counterclockwise and take out the bulb.
- ▶ Insert the new bulb so that the base locates in the recess on the holder.

- ▶ Turn the locking mechanism **2** clockwise.
- ▶ Plug the connector onto the bulb.
- ▶ Align headlamp cover and click into place.

Replacing parking and standing lamp bulbs

- ▶ Switch off the lights.
- ▶ Open the hood (▷ page 227).
- ▶ Press ends of headlamp cover tab together and remove cover.
- ▶ Pull out the bulb socket with the bulb.
- ▶ Pull the bulb out of the bulb socket.
- ▶ Insert a new bulb in the socket.
- ▶ Reinstall the bulb socket.
- ▶ Align headlamp cover and click into place.



Have the headlamp adjustment checked regularly.

Replacing side marker lamp

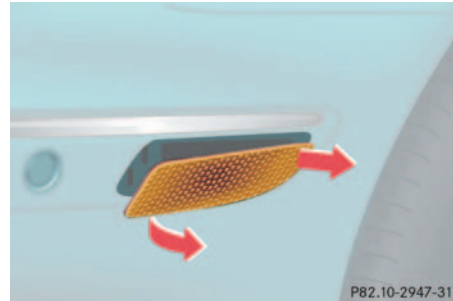

- ▶ Switch off the lights.
- ▶ Carefully slide lamp towards rear.
- ▶ Remove front end first.
- ▶ Twist bulb socket counterclockwise and pull out.
- ▶ Pull bulb out of the bulb socket.
- ▶ Insert new bulb in socket.
- ▶ Reinstall bulb socket, push in, and twist clockwise.
- ▶ To reinstall lamp, set rear end in bumper and let front end snap into place.

Replacing bulbs for rear lamps

Tail lamp assemblies

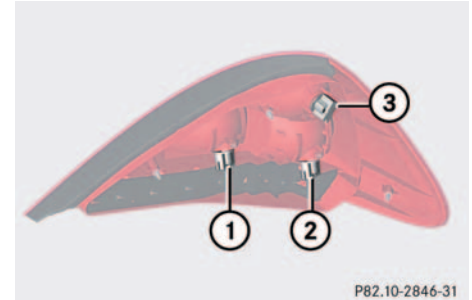

- 1 Backup lamp
 - 2 Turn signal lamp
 - 3 Driver's side: Rear fog lamp
Passenger's side: Substitute lamp
- ▶ Switch off the lights.
 - ▶ Open the trunk lid (▷ page 83).
 - ▶ Fold trim to side and remove.
 - ▶ Twist bulb socket counterclockwise and pull out.



Replacing bulbs

- ▷▷▶ Gently push bulb into socket, turn counterclockwise and remove.
- ▶ Insert new bulb and reinstall bulb socket.
The bulb socket should audibly click into place.
- ▶ Reinstall trim.

License plate lamp

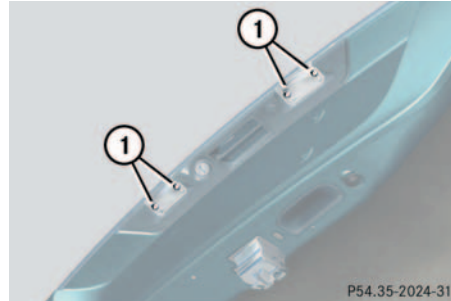

1 Screws

- ▶ Switch off the lights.
- ▶ Loosen both screws and remove lamp.
- ▶ Replace the bulb and reinstall lamp.
- ▶ Retighten the screws.

Replacing wiper blades



To avoid damage to the hood, the wiper arms should only be folded forward when in the vertical position.



Removing

- ▶ Turn key in starter switch to position **1**.
- ▶ Turn combination switch to wiper setting **2** (▷ page 44).
- ▶ With wiper arm in the vertical position (see above), turn key in starter switch to position **0**.

Warning!



For safety reasons, remove key from starter switch before replacing a wiper blade, otherwise the motor could suddenly turn on and cause injury.

- ▶ Fold wiper arm forward.
You should hear it snap into place.
- ▶ Turn wiper blade at a right angle to the wiper arm.

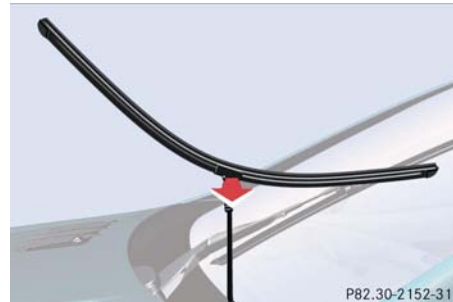

- ▶ Slide the wiper blade sideways out of the retainer.

Installing

- ▶ Slide wiper blade onto wiper arm.
- ▶ Rotate wiper blade into position parallel to wiper arm.
- ▶ Fold wiper arm back so that blade rests on windshield.



Never open the hood when the wiper arm is folded forward.

Do not allow the wiper arms to contact the windshield glass without a wiper blade inserted.

For your convenience, we recommend that you have this work carried out by an authorized Mercedes-Benz Center.

Flat tire

Flat tire

Your vehicle is equipped with a TIREFIT kit (SL 55 AMG only) or a spare wheel (SL 500 only).

You can identify which TIREFIT kit (SL 55 AMG only) you have as follows:

- The TIREFIT container of kit 1 is a squeeze container.
- The TIREFIT container of kit 2 is a rigid container.

Preparing the vehicle

- ▶ Park the vehicle as far as possible from moving traffic on a hard surface.
- ▶ Turn on the hazard warning flashers.
- ▶ Engage the steering wheel lock in the straight ahead position and set the parking brake.
- ▶ Move the selector lever to **P**.
- ▶ Have any passenger exit the vehicle at a safe distance from the roadway.

Sealing tires with TIREFIT kit 1

Warning!



Keep TIREFIT away from sparks, open flame or heat source.
Do not smoke.

Small tire punctures, particularly those in the tread, can be sealed with TIREFIT. TIREFIT can be used in ambient temperatures down to -4°F (-20°C).

The TIREFIT kit stored in the trunk contains the TIREFIT container, a filler hose, a valve stem tool, a valve, and a sticker.

Warning!



TIREFIT is a limited repair device. TIREFIT cannot be used for cuts or punctures larger than approx. 0.16 in (4 mm) and tire damage caused by driving with extremely low tire pressure, or on a flat tire, or a damaged wheel.

Do not drive the vehicle under such circumstances.

Contact your nearest Mercedes-Benz Center for assistance or call Roadside Assistance.

- ▶ Foreign objects (e.g. screws or nails) should not be removed from the tire.
- ▶ Attach the sticker where it will be easily seen by the driver on the instrument cluster.

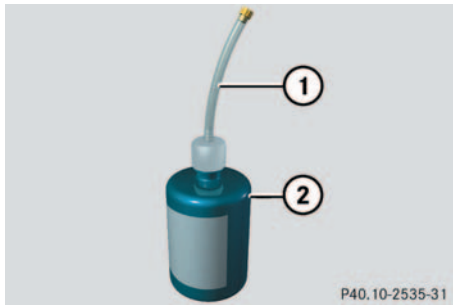

- 1 Filler hose
- 2 TIREFIT container

- ▶ Shake contents of TIREFIT container **1**.
- ▶ Screw hose **1** on to TIREFIT container **2**.

TIREFIT is now ready for use.

Warning!



Take care not to allow the contents of TIREFIT to come in contact with hair, eyes or clothing. TIREFIT is harmful if inhaled, swallowed or absorbed through the skin - causes skin, eye and respiratory irritation.

Any contact with eyes or skin should be flushed immediately with plenty of water.

If clothing comes in contact with TIREFIT, change clothing as soon as possible.

In case of allergic reaction or rash, consult a physician immediately.

Warning!



Keep TIREFIT out of reach of children.
 If swallowed, rinse mouth immediately with plenty of water and drink plenty of water.
 Do not induce vomiting!
 Consult a physician immediately.
 Keep away from open flame or heat source.

Flat tire

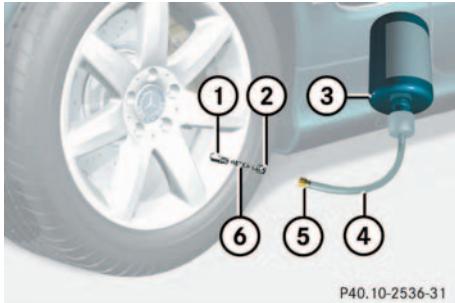

- 1 Valve stem
- 2 Valve stem tool
- 3 TIREFIT container
- 4 Filler hose
- 5 Filler hose plug
- 6 Tire valve core

- ▶ Unscrew the valve cap from valve 1.

- ▶ Remove tire valve core **6** from valve stem **1** using valve stem tool **2**. Keep tire valve **6** clean and dry.
- ▶ Remove plug **5** from end of hose **4**.
- ▶ Push hose **4** onto valve stem **1**.
- ▶ Hold TIREFIT container **3** upside down (hose down) and squeeze firmly several times until entire contents of the container are in tire.
- ▶ Pull hose **4** off and screw tire valve **6** tightly into the valve stem **1** using the valve stem tool **2**.



If the removed tire valve core is dirty, use the spare tire valve core stored with the valve stem tool.

- ▶ Reinstall valve cap on valve stem **1**.
- ▶ Install plug **5** onto end of hose **4**.



If sealant has leaked out, let it dry. You can then peel it off.

- ▶ Drive the vehicle back and forth very slowly approximately 30 ft (10 m).
This distributes the TIREFIT sealant material inside the tire.
- ▶ Take the electric air pump out of the trunk.

Warning!



Observe safety instructions on air pump label.

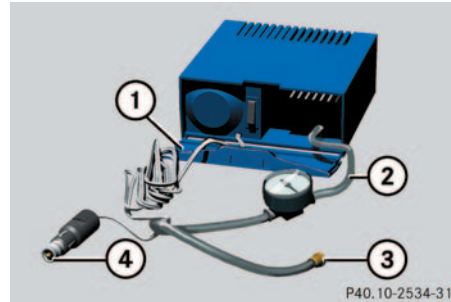

- 1 Flap
- 2 Air hose with pressure gauge and vent screw
- 3 Union nut
- 4 Electrical plug

- ▶ Open flap **1** on air pump.
- ▶ Pull out electrical plug **4** and air hose with the pressure gauge **2**.
- ▶ Screw the air hose **2** onto the tire valve.
- ▶ Insert electrical plug **4** into vehicle cigar lighter socket.

- ▶ Turn the key in the ignition to position **1** (▷ page 29).
or
- ▶ Press the KEYLESS-GO* start/stop button on the selector lever once. Do not depress brake pedal.
- ▶ Press **I** on the electric air pump switch.

The electric air pump should now switch on and inflate the tire.

After 5 minutes, the pressure gauge must display at least 26 psi (1.8 bar). The air hose and the union nut can become hot during inflation. Please exercise appropriate caution.

- ▶ If this tire pressure is not attained, turn off the electric air pump, detach the air hose from the tire valve, and again drive vehicle back and forth very slowly approximately 30 ft (10 m).

This serves to better distribute the TIREFIT sealant material inside the tire.

- ▶ Inflate the tire again.

Flat tire



Do not operate the electric air pump longer than eight minutes without interruption. Otherwise it may overheat.

You may operate the air pump again after it has cooled off.

- ▶ Press **0** on the electric air pump switch.
 - ▶ Turn the key in the ignition to position **0**.
- or
- ▶ Press KEYLESS-GO* start/stop button on the selector lever twice. Do not depress brake pedal.

The electric air pump should now be switched off.

Warning!



If a tire pressure of 26 psi (1.8 bar) is not attained, tire is too severely damaged for TIREFIT to provide a reliable tire repair.

In this case, TIREFIT cannot properly seal the tire.

Do not drive the vehicle.

Contact the nearest Mercedes-Benz Center or call Roadside Assistance.

- ▶ Detach the electric air pump.
The air hose may still be hot. Please exercise appropriate caution.
- ▶ Store the electrical plug and the air hose behind the flap and place the air pump back in the trunk.
- ▶ Close the trunk lid.
- ▶ Drive away immediately.

The TIREFIT sealant will distribute itself evenly inside the tire.

Warning!



Do not exceed vehicle speed of 50 mph (80 km/h). A TIREFIT repair is not designed to operate at higher speeds.

The sticker must be attached on the instrument cluster where it will be easily seen by the driver.

Vehicle handling characteristics may change. Adapt your driving accordingly.

- ▶ After driving vehicle for an initial 10 minutes, check tire pressure using the pressure gauge on the air pump.

Warning!

If tire pressure has fallen below 20 psi (1.3 bar) do not continue to drive the vehicle.

Park your vehicle safely away from the roadway and contact the nearest authorized Mercedes-Benz Center or Roadside Assistance.

If tire pressure is at least 20 psi (1.3 bar), inflate tire to correct pressure (see label on fuel filler flap), and drive vehicle to nearest tire repair facility to have tire repaired or replaced.

Recommended duration of use:
300 miles (500 km) at 50 mph (80 km/h) with the recommended tire pressure.

Warning!

Follow recommend tire pressures.

Do not overinflate tires. Overinflating tires can result in sudden deflation (blowout) because they are more likely to become punctured or damaged by road debris, potholes etc.

Do not underinflate tires. Underinflated tires wear unevenly, adversely affect handling and fuel economy, and are more likely to fail from being overheated.

Do not overload the tires by exceeding the specified vehicle capacity weight (as indicated by the label on the pillar in the driver's door opening). Overloading the tires can overheat them, possibly causing a blowout.

- ▶ Visit an authorized Mercedes-Benz Center as soon as possible to obtain a new TIREFIT kit.
- ▶ Bring used TIREFIT materials to an authorized Mercedes-Benz Center for proper disposal.

Warning!

Do not exceed vehicle speed of 50 mph (80 km/h). A TIREFIT repair is not designed to operate at higher speeds.

The sticker must be attached on the instrument cluster where it will be easily seen by the driver.

Vehicle handling characteristics may change. Adapt your driving accordingly.

- ▶ Replace your TIREFIT kit every four years. Kits are available at your authorized Mercedes-Benz Center.

Flat tire

Sealing tires with TIREFIT kit 2

Warning!



Keep TIREFIT away from sparks, open flame or heat source.

Do not smoke.

Small tire punctures, particularly those in the tread, can be sealed with TIREFIT. TIREFIT can be used in ambient temperatures down to -4°F (-20°C).

Warning!



TIREFIT is a limited repair device. TIREFIT cannot be used for cuts or punctures larger than approx. 0.16 in (4 mm) and tire damage caused by driving with extremely low tire pressure, or on a flat tire, or a damaged wheel.

Do not drive the vehicle under such circumstances.

Contact your nearest Mercedes-Benz Center for assistance or call Roadside Assistance.

- ▶ Foreign objects (e.g. screws or nails) should not be removed from the tire.
- ▶ Take TIREFIT, the sticker, and the electric air pump out of the trunk.
- ▶ Attach the sticker where it will be easily seen by the driver on the instrument cluster.

Warning!



Take care not to allow the contents of TIREFIT to come in contact with hair, eyes or clothing. TIREFIT is harmful if inhaled, swallowed or absorbed through the skin - causes skin, eye and respiratory irritation.

Any contact with eyes or skin should be flushed immediately with plenty of water.

If clothing comes in contact with TIREFIT, change clothing as soon as possible.

In case of allergic reaction or rash, consult a physician immediately.

Warning!



Keep TIREFIT out of reach of children. If swallowed, rinse mouth immediately with plenty of water and drink plenty of water.

Do not induce vomiting!

Consult a physician immediately.

Keep away from open flame or heat source.

i

If sealant has leaked out, let it dry. You can then peel it off.

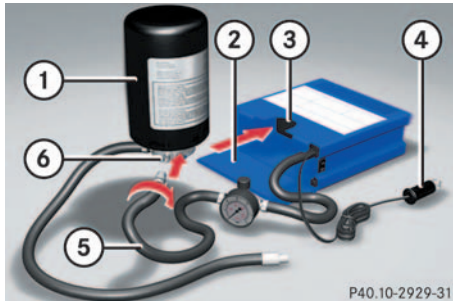

- 1 TIREFIT container
- 2 Flap
- 3 Notch
- 4 Electrical plug
- 5 Air hose
- 6 Flange

- ▶ Open flap 2 on the electric air pump.
- ▶ Pull plug 4 and air hose 5 out of the pump housing.

- ▶ Screw the air pump's air hose 5 onto flange 6 of the TIREFIT container.
- ▶ Stick TIREFIT container 1 upside down into notch 3 of the electric air pump.

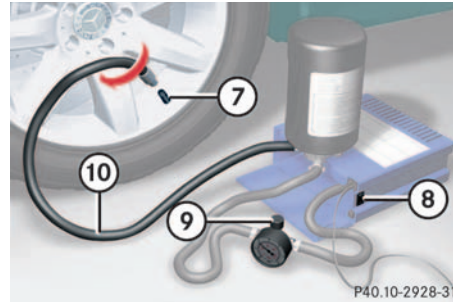

- 7 Tire valve
- 8 Electric air pump switch
- 9 Air hose with pressure gauge and vent screw
- 10 Filler hose

Warning!



Observe safety instructions on air pump label.

- ▶ Unscrew the valve cap from tire valve 7.
- ▶ Screw filler hose 10 onto tire valve 7.
- ▶ Insert electrical plug 4 into vehicle cigarette lighter socket.
- ▶ Turn the key in the ignition to position 1 (▷ page 29).
- or
- ▶ Press the KEYLESS-GO* start/stop button (▷ page 30) on the selector lever once. Do not depress brake pedal.
- ▶ Press I on electric air pump switch 8.

The electric air pump should now switch on and inflate the tire.

!

Do not operate the electric air pump longer than eight minutes without interruption. Otherwise it may overheat.

You may operate the air pump again after it has cooled off.

Flat tire

After 5 minutes, the pressure gauge must display at least 26 psi (1.8 bar). The air hose can become hot during inflation. Please exercise appropriate caution.

- ▶ If this tire pressure is not attained, turn off the electric air pump, detach the filler hose from the tire valve, and drive vehicle back and forth very slowly approximately 30 ft (10 m).

This serves to better distribute the TIREFIT sealant material inside the tire.

- ▶ Unscrew the air pump's air hose **5** from flange **6** of the TIREFIT container.
- ▶ Inflate the tire again.

Warning!



If a tire pressure of 26 psi (1.8 bar) is not attained, tire is too severely damaged for TIREFIT to provide a reliable tire repair.

In this case, TIREFIT cannot properly seal the tire.

Do not drive the vehicle.

Contact the nearest Mercedes-Benz Center or call Roadside Assistance.

- ▶ After attaining a tire pressure of 26 psi (1.8 bar), press **0** on electric air pump switch **8**.

The electric air pump should now be switched off.

- ▶ Turn the key in the ignition to position **0** (▷ page 29).
or
- ▶ Press the KEYLESS-GO* start/stop button (▷ page 30) on the selector lever once. Do not depress brake pedal.

- ▶ Detach the electric air pump.

The air hose may still be hot. Please exercise appropriate caution.

- ▶ Store the electrical plug and the air hose behind the flap and place the air pump back in the trunk.
- ▶ Close the trunk lid.
- ▶ Drive away immediately.

The TIREFIT sealant will distribute itself evenly inside the tire.

Warning!



Do not exceed vehicle speed of 50 mph (80 km/h). A TIREFIT repair is not designed to operate at higher speeds.

The sticker must be attached on the instrument cluster where it will be easily seen by the driver.

Vehicle handling characteristics may change. Adapt your driving accordingly.

- ▶ After driving vehicle for an initial 10 minutes, check tire pressure using the pressure gauge on the air pump.

Warning!



If tire pressure has fallen below 20 psi (1.3 bar) do not continue to drive the vehicle.

Park your vehicle safely away from the roadway and contact the nearest authorized Mercedes-Benz Center or Roadside Assistance.

If tire pressure is at least 20 psi (1.3 bar), inflate tire to correct pressure (see label on fuel filler flap), and drive vehicle to nearest tire repair facility to have tire repaired or replaced.

Recommended duration of use:
300 miles (500 km) at 50 mph (80 km/h) with the recommended tire pressure.

Warning!



Follow recommend inflation pressures.

Do not overinflate tires. Overinflating tires can result in sudden deflation (blowout) because they are more likely to become punctured or damaged by road debris, potholes etc.

Do not underinflate tires. Underinflated tires wear unevenly, adversely affect handling and fuel economy, and are more likely to fail from being overheated.

Do not overload the tires by exceeding the specified vehicle capacity weight (as indicated by the label on the pillar in the driver's door opening). Overloading the tires can overheat them, possibly causing a blowout.

- ▶ Visit an authorized Mercedes-Benz Center as soon as possible to obtain a new TIREFIT kit.
- ▶ Bring used TIREFIT materials to an authorized Mercedes-Benz Center for proper disposal.

Warning!



Do not exceed vehicle speed of 50 mph (80 km/h). A TIREFIT repair is not designed to operate at higher speeds.

The sticker must be attached on the instrument cluster where it will be easily seen by the driver.

Vehicle handling characteristics may change. Adapt your driving accordingly.

- ▶ Replace your TIREFIT container every four years. Replacement containers are available at your authorized Mercedes-Benz Center.

Flat tire

Mounting the spare wheel

Warning!



The dimensions of the spare wheel are different from those of the road wheels. As a result, the vehicle handling characteristics change when driving with a mounted spare wheel. Adapt your driving style accordingly.

The spare wheel is for temporary use only. When driving with spare wheel mounted, ensure proper tire pressure and do not exceed vehicle speed of 50 mph (80 km/h).

Drive to the nearest Mercedes-Benz Center as soon as possible to have the spare wheel replaced with a regular road wheel.

Never operate the vehicle with more than one spare wheel mounted.

Preparing the vehicle

Prepare the vehicle as described above (▷ page 302).

- ▶ Turn spare wheel bracket counter-clockwise to loosen.
- ▶ Take the wheel out of the trunk.

Lifting the vehicle

- ▶ Prevent the vehicle from rolling away by blocking wheels with wheel chocks (not included) or other sizable objects.

When changing wheel on a level surface:

- ▶ Place one chock in front of and one behind the wheel that is diagonally opposite to the wheel being changed.

When changing wheel on a hill:

- ▶ Place chocks on the downhill side blocking both wheels of the other axle.

- ▶ Take the vehicle tool kit and the jack out of the storage compartment under the trunk floor (▷ page 289).

Warning!



The jack is designed exclusively for jacking up the vehicle at the jack tubes built into both sides of the vehicle. To help avoid personal injury, use the jack only to lift the vehicle during a wheel change. Never get beneath the vehicle while it is supported by the jack. Keep hands and feet away from the area under the lifted vehicle. Always firmly set parking brake and block wheels before raising vehicle with jack.

Do not disengage parking brake while the vehicle is raised. Be certain that the jack is always vertical (plumb line) when in use, especially on hills. Always try to use the jack on level surface. Be sure that the jack arm is fully inserted in the jack tube. Always lower the vehicle onto sufficient capacity jack-stands before working under the vehicle.

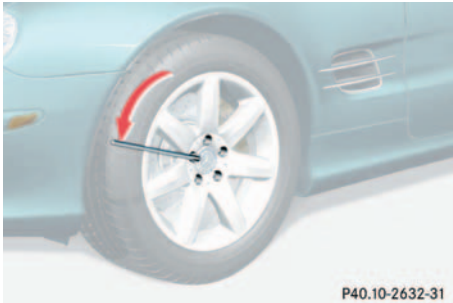

- ▶ On wheel to be changed, loosen but do not yet remove the wheel bolts (approximately one full turn with wrench).

The jack support tubes are located behind the front wheel housings and in front of the rear wheel housings.

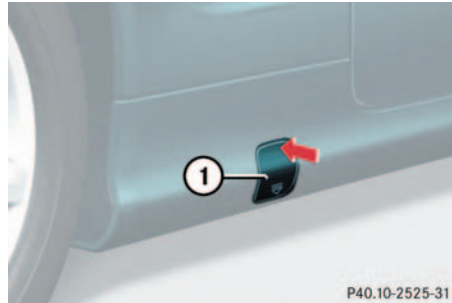

- ▶ **1** Jack support tube cover (except SL 55 AMG and vehicles with Sport Package*)
- ▶ Open cover **1** by pressing at point indicated by arrow.
- ▶ Remove cover **1**, taking care not to damage the locking tabs.

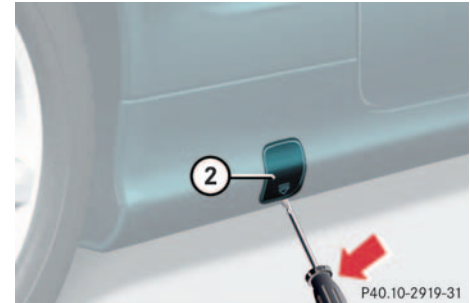

- ▶ **2** Jack support tube hole (SL 55 AMG and vehicles with Sport Package* only)
- ▶ Insert a flat blade screwdriver in the opening of cover **2** and pry it out.
- ▶ Remove cover **2**, taking care not to damage the locking tabs.

Flat tire



- 1 Jack arm
- 2 Jack support tube hole
- 3 Crank

- ▶ Insert jack arm **1** fully into the tube hole **2** up to the stop.

Warning!



Insert the jack arm fully into the jack support tube hole up to the stop. Otherwise the vehicle may fall from the jack and cause personal injury or damage to the vehicle.

- ▶ Keeping jack in this position, turn crank **3** clockwise until the jack base meets the ground. Make sure the jack is vertical (plumb line).
- ▶ Continue to turn the crank until the tire is a maximum of 1.2 in (3 cm) from the ground.

Removing the wheel

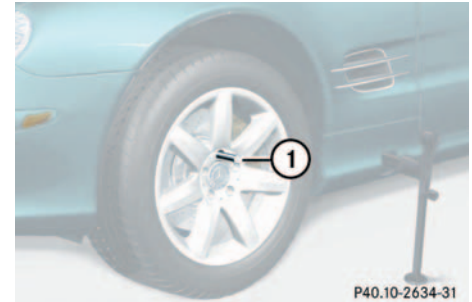

1 Alignment bolt

- ▶ Unscrew upper-most wheel bolt and remove.
- ▶ Replace this wheel bolt with the alignment bolt **1** supplied in the tool kit.
- ▶ Remove the remaining bolts.



Do not place wheel bolts in sand or dirt. This could result in damage to the bolt and wheel hub threads.

- ▶ Remove the wheel.

Mounting the new wheel

Warning!



Inflate spare wheel tire only after the wheel is properly mounted.

Inflate the spare wheel tire using the electric pump (▷ page 316) before lowering the vehicle.

- ▶ Clean contact surfaces of wheel and wheel hub.
- ▶ Guide the spare wheel onto the alignment bolt and push it on.
- ▶ Insert wheel bolts and tighten them slightly.

Warning!



Always replace wheel bolts that are damaged or rusted.

Never apply oil or grease to wheel bolts.

Damaged wheel hub threads should be repaired immediately. Do not continue to drive under these circumstances! Contact an authorized Mercedes-Benz Center or call Roadside Assistance.

Incorrect mounting bolts or improperly tightened mounting bolts can cause the wheel to come off. This could cause an accident. Be sure to use the correct mounting bolts.

Warning!



Only use genuine equipment Mercedes-Benz wheel bolts. They are identified by the Mercedes star. Other wheel bolts may come loose.

Do not tighten the wheel bolts when the vehicle is raised. Otherwise the vehicle could tip over.

- ▶ Unscrew the alignment bolt, install last wheel bolt and tighten slightly.

Flat tire

Inflating the spare tire



Do not lower the vehicle before inflating the spare wheel tire. Otherwise the rim may be damaged.

- ▶ Take the electric air pump out of the trunk (▶ page 289).

Warning!



Observe instructions on air pump label.

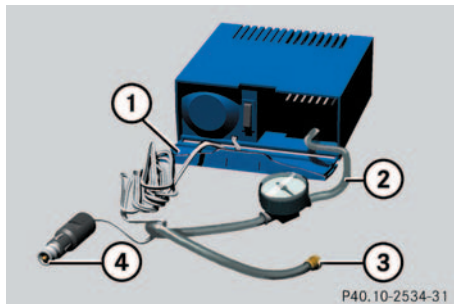

- 1 Flap
- 2 Air hose with pressure gauge and vent screw
- 3 Union nut
- 4 Electrical plug

- ▶ Open flap **1** on air pump.
- ▶ Pull out the electrical plug **4** and air hose with the pressure gauge **2**.
- ▶ Remove the valve cap from the tire valve.
- ▶ Screw the air hose **2** onto the tire valve.
- ▶ Insert electrical plug **4** into vehicle cigar lighter socket.

- ▶ Turn the key in the ignition to position **1**.
or
- ▶ Press the KEYLESS-GO* start/stop button on the selector lever once without depressing the brake pedal.
- ▶ Press **1** on the electric air pump switch.
The electric air pump should now switch on and inflate the tire.
- ▶ Inflate the tire to approx. 36 psi (2.5 bar).

This takes about five minutes for the spare tire. The air hose **2** and the union nut **3** can become hot duration inflation. Exercise proper caution to avoid burning yourself when using the equipment.



Do not operate the air pump longer than eight minutes without interruption. Otherwise it may overheat.

You may operate the air pump again after it has cooled off.

- ▶ Press **0** on the electric air pump switch.
- ▶ Turn the key in the ignition to position **0**.
- or
- ▶ Press KEYLESS-GO* start/stop button on the selector lever twice without depressing the brake pedal.

The electric air pump should now be switched off.

- ▶ If the tire pressure is above 36 psi (2.5 bar), release excess tire pressure using the vent screw.

Warning!



Follow recommend inflation pressures.

Do not overinflate tires. Overinflating tires can result in sudden deflation (blowout) because they are more likely to become punctured or damaged by road debris, potholes etc.

Do not underinflate tires. Underinflated tires wear unevenly, adversely affect handling and fuel economy, and are more likely to fail from being overheated.

- ▶ Detach the electric air pump.
- ▶ Stow the electrical plug and the air hose behind the flap and place the air pump back in the trunk.



The flat tire may be transported in the trunk when the retractable hardtop is lowered. Use the protective sheet provided with the spare wheel. Do not activate the tire inflation pressure monitor until the deflated tire has been removed from the vehicle.

Flat tire

Lowering the vehicle

- ▶ Lower vehicle by turning crank counterclockwise until the full weight of the vehicle is resting on the ground.
- ▶ Pull the jack out of the jack support tube.

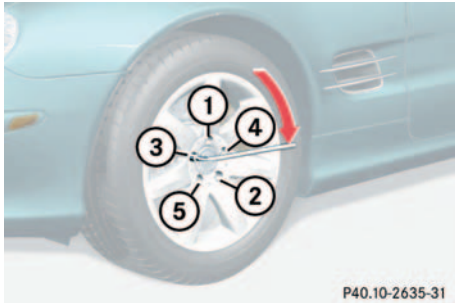

1 - 5 Wheel bolts

- ▶ Tighten the five wheel bolts evenly, following the diagonal sequence illustrated (1 to 5), until all bolts are tight. Observe a tightening torque of 96 ft lb (130 Nm).

Warning!



Have the tightening torque checked after changing a wheel. The wheels could come loose if they are not tightened to a torque of 96 ft lb (130 Nm).

- ▶ Before storing the jack in the trunk, crank back to storage position and fold in the arm.

Replacing jack support tube cover

- ▶ Slide tongue of cover under the upper edge of the tube opening.
- ▶ Applying even pressure, press cover until it snaps into place. Be careful not to damage the locking tabs or clamp the plastic retaining strap.

Batteries

Your vehicle is equipped with two batteries:

- The starter battery (located in the engine compartment)
- The battery for electrical consumers (located in the trunk)



Starter battery in the engine compartment

- 1 Positive terminal
- 2 Negative terminal

Warning!



Failure to follow these instructions can result in severe injury or death.

Never lean over batteries while connecting, you might get injured.

Battery fluid contains sulfuric acid. Do not allow this fluid to come in contact with eyes, skin or clothing. In case it does, immediately flush affected area with water and seek medical help if necessary.

A battery will also produce hydrogen gas, which is flammable and explosive. Keep flames or sparks away from battery, avoid improper connection of jumper cables, smoking, etc.



Never loosen or detach battery terminal clamps while the engine is running or the key is in the starter switch. Otherwise the alternator and other electronic components could be severely damaged.

Have the starter battery checked regularly by an authorized Mercedes-Benz Center

Refer to Service Booklet for maintenance intervals or contact your authorized Mercedes-Benz Center for further information.

Warning!



Do not place metal objects on the battery as this could result in a short circuit.

Use leak-proof batteries only to avoid the risk of acid burns in the event of an accident.

Warning!



The brake system requires electrical power to operate.

A malfunction in the vehicle's power supply or electrical system may impair brake system operation and switch it into its limp-home (emergency operation) mode.

The same applies if battery is disconnected. To brake, the driver must then apply significantly greater brake pedal pressure and depress the pedal much further to obtain the expected braking effect. If necessary, apply full pressure to the brake pedal. Brakes are only applied to the front wheels. Stopping distance is increased! Adjust your driving style accordingly. SBC brake system (> page 72).

Warning!



With a disconnected battery

- you will no longer be able to turn the key in the starter switch and pressing the KEYLESS-GO* start/stop button (if so equipped) on the selector lever will have no effect
- the selector lever will remain locked in position **P**

Disconnecting the batteries



To avoid damage to electrical components, always disconnect the battery for electrical consumers (in trunk) first. This applies even if you only wish to charge the starter battery. Otherwise the electronics of the vehicle can be damaged.

Disconnecting the battery for electrical consumers

- ▶ Unhook the luggage cover in the trunk.

- ▶ Remove the trunk floor.

The battery for electrical consumers is located in the right hand area of the trunk (> page 289).

- ▶ Use the 10 mm open-end wrench from the vehicle tool kit to disconnect the battery negative lead.
- ▶ Remove the cover from the positive terminal.
- ▶ Disconnect the battery positive lead.

Disconnecting the starter battery

- ▶ Use the 10 mm open-end wrench from the vehicle tool kit to disconnect the battery negative lead.
- ▶ Remove the cover from the positive terminal.
- ▶ Disconnect the battery positive lead.

Removing the batteries

Removing the battery for electrical consumers

- ▶ Remove the screws securing the battery in the trunk.
- ▶ Remove the battery support and bracket. Take out the battery.

Removing the starter battery

- ▶ Remove the screws securing the starter battery in the engine compartment.
- ▶ Lift the retaining bracket and remove the battery.

Charging and reinstalling batteries

- ▶ Charge batteries in accordance with the instructions of the battery charger manufacturer.
- ▶ Reinstall the charged battery. Follow the previously described steps in reverse order.

Warning!



Never charge a battery while still installed in the vehicle. Gases may escape during charging and cause explosions that may result in paint damage, corrosion or personal injury.

Reconnecting the batteries



To avoid damage to electrical components, always reconnect the starter battery (in engine compartment) first.

Reconnecting the starter battery

- ▶ Turn off all electrical consumers.
- ▶ Connect the positive lead and fasten its cover.
- ▶ Connect the negative lead.



Never invert the terminal connections!



The battery, its filler caps, and the vent tube must always be securely installed when the vehicle is in operation.

Batteries

Reconnecting the battery for electrical consumers

- ▶ Turn off all electrical consumers.
- ▶ Connect the positive lead and fasten its cover.
- ▶ Connect the negative lead.
- ▶ Reinstall the trunk floor.
- ▶ Rehook trunk luggage cover into holders.



Never invert the terminal connections!



The following procedures must be carried out following any interruption of battery power (e.g. due to reconnection):

- Resynchronize the ESP (▷ page 261).
- Resynchronize side windows (▷ page 158).

Jump starting

Warning!



Failure to follow these directions will cause damage to the electronic components, and can lead to a battery explosion and severe injury or death.

Never lean over batteries while connecting or jump starting, you might get injured.

Battery fluid contains sulfuric acid. Do not allow this fluid to come in contact with eyes, skin or clothing. In case it does, immediately flush affected area with water, and seek medical help if necessary.

A battery will also produce hydrogen gas, which is flammable and very explosive. Keep flames or sparks away from battery, avoid improper connection of jumper cables, smoking etc.

Read all instructions before proceeding.

If the starter battery is discharged, the engine can be started with jumper cables and the battery of another vehicle.

Observe the following:

- Jump starting should only be performed when the engine and catalytic converter are cold.
- Do not start the engine if the battery is frozen. Let the battery thaw out first.
- Only use 12V batteries to jump start your vehicle. Jump starting with a more powerful battery could damage the vehicle's electrical system, which will not be covered by the Mercedes-Benz Limited Warranty.
- Only use jumper cables with sufficient cross section and insulated terminal clamps.

Always make sure that the jumper cables are not on or near pulleys, fans, or other parts that move when the engine is started or running.



Jump starting may only be performed on the battery installed in the engine compartment.

Avoid repeated and lengthy starting attempts.

Do not attempt to start the engine using a battery quick charge unit.

If the engine does not run after several unsuccessful starting attempts, have it checked at the nearest authorized Mercedes-Benz Center.

Excessive unburned fuel generated by repeated failed starting attempts may damage the catalytic converter and may present a fire risk.

Make sure the jumper cables do not have loose or missing insulation.

Make sure the cable clamps do not touch any other metal part while the other end is still attached to a battery.

Jump starting

Warning!



Never lean over the battery while connecting or jump starting.

Warning!



Keep flames or sparks away from battery. Do not smoke.

Observe all safety instructions and precautions when handling automotive batteries (▷ page 232).

The starter battery is located in the engine compartment.

- ▶ Make sure that the two vehicles do not touch.
- ▶ Turn off the engine.
- ▶ Turn off all electrical consumers.
- ▶ Apply parking brake.
- ▶ Shift selector lever to position **P**.

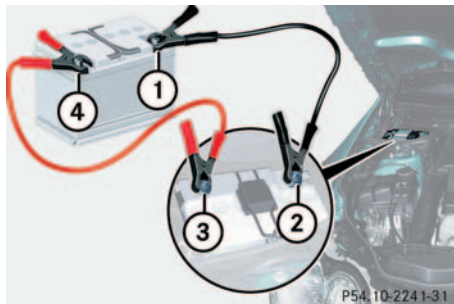

- 1 Negative terminal of charged battery
- 2 Negative terminal of discharged battery
- 3 Positive terminal of discharged battery
- 4 Positive terminal of charged battery

- ▶ Remove the red cover from positive terminal on both vehicles (▷ page 319).
- ▶ Connect the positive terminals **3** and **4** of the batteries with the jumper cables. Start with the charged battery.
- ▶ Start the engine of the vehicle with the charged battery and run at idle speed.

- ▶ Connect the negative terminals **1** and **2** of the batteries with the jumper cables. Start with the charged battery.

- ▶ Start the engine of the disabled vehicle.

Now you can again turn on the electrical consumers. Do not turn on the lights under any circumstances.

- ▶ Remove the jumper cables first from the negative terminals **1** and **2** of the batteries and then from the positive terminals **3** and **4**.
- ▶ Have the battery checked at the nearest Mercedes-Benz Center.



The vehicle cannot be started via tow-start.

Towing the vehicle

Mercedes-Benz recommends that the vehicle be transported with all wheels off the ground using flatbed or appropriate wheel lift/dolly equipment.



Use flatbed or wheel lift/dolly equipment with key in starter switch turned to position **0**.

Do not tow with sling-type equipment. Towing with sling-type equipment over bumpy roads will damage radiator and supports.

To prevent damage during transport, do not tie down vehicle by its chassis or suspension parts.

Switch off the tow-away alarm and the automatic central locking.

When circumstances do not permit the recommended towing methods, the vehicle may be towed with all wheels on the ground or front wheels raised only so far as necessary to have the vehicle moved to a safe location where the recommended towing methods can be employed.



If the vehicle is towed with the front axle raised, the engine must be shut off (key in starter switch position **0** or **1**). Otherwise, the ESP will immediately be engaged and will apply the rear wheel brakes.

When towing the vehicle with all wheels on the ground, the selector lever must be in position **N** and the key must be in starter switch position **2**.

When towing the vehicle with all wheels on the ground or the front axle raised, the vehicle may be towed only for distances up to 30 miles (50 km) and at a speed not to exceed 30 mph (50 km/h).



To be certain to avoid a possibility of damage to the transmission, however, we recommend the drive shaft be disconnected at the rear axle drive flange for any towing beyond a short tow to a nearby garage.

Towing the vehicle

Warning!



If circumstances require towing the vehicle with all wheels on the ground, always tow with a tow bar if:

- the engine will not run
- there is a malfunction in the SBC brake system
- there is a malfunction in the power supply or in the vehicle's electrical system

as that will be necessary to adequately control the towed vehicle.

Prior to towing the vehicle with all wheels on the ground, make certain that the key is in starter switch position **2**.

If the key is left in the starter switch position **0** for an extended period of time, it can no longer be turned in the switch. In this case, the steering is locked. To unlock, remove key from starter switch and reinsert.



To signal turns while being towed with the hazard warning flasher in use, turn key in starter switch to position **2** and activate the combination switch for the left or right turn signal in the usual manner – only the selected turn signal will operate.

Upon canceling the turn signal, the hazard warning flasher will operate again.

Warning!



The brake system requires electrical power to operate.

A malfunction in the vehicle's power supply or electrical system may impair brake system operation and switch it into its limp-home (emergency operation) mode. To brake, the driver must then apply significantly greater brake pedal pressure and depress the pedal much further to obtain the expected braking effect. If necessary, apply full pressure to the brake pedal. Brakes are only applied to the front wheels. Stopping distance is increased! Adapt your driving style accordingly. SBC brake system (> page 72).

With the engine not running, there is no power assistance for the steering system. In this case, it is important to keep in mind that a considerably higher degree of effort is necessary to steer the vehicle. Adapt your driving accordingly.



When towing the vehicle with all wheels on the ground, please note the following:

With the automatic central locking activated and the key in starter switch position **2**, or KEYLESS-GO* start/stop button (if so equipped) in position **2**, the vehicle doors lock if the left front wheel as well as the right rear wheel are turning at vehicle speeds of approx. 9 mph (15 km/h) or more.

To prevent the vehicle door locks from locking, deactivate the automatic central locking (▷ page 91).

Towing of the vehicle should only be done using the properly installed towing eye bolt. Never attach tow cable, tow rope or tow rod to the vehicle chassis, frame or suspension parts.



The selector lever will remain locked in position **P** and the key will not turn in the starter switch if the battery is disconnected or discharged. See notes on the battery (▷ page 319) or on jump starting (▷ page 323).

Installing towing eye bolt

Front of vehicle

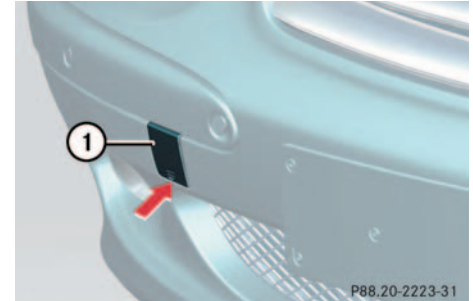

1 Cover on right side of front bumper.

To remove cover:

- ▶ Press mark on cover in direction of arrow.
- ▶ Lift cover off to reveal threaded hole for towing eye bolt.

Towing the vehicle

The towing eye bolt is supplied with the tool kit (located in the storage compartment under the trunk floor).

- ▶ Screw towing eye bolt in to its stop and tighten with lug wrench.

To reinstall cover:

- ▶ Fit cover and snap into place.

Rear of vehicle

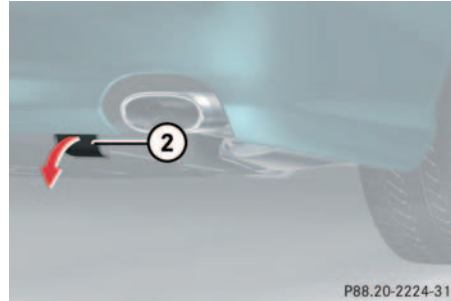

2 Cover on right side of rear bumper

To remove cover:

- ▶ Pull cover in the direction of arrow.
- ▶ Fold cover down to reveal threaded hole for the towing eye bolt.

The towing eye bolt is supplied with the tool kit (located in the storage compartment under the trunk floor).

- ▶ Screw towing eye bolt in to its stop and tighten with lug wrench.

To reinstall cover:

- ▶ Fit cover and snap into place.

Fuses



Only install fuses that have been tested and approved by Mercedes-Benz and that have the specified amperage rating.

Never attempt to repair or bridge a blown fuse. Have the cause determined and remedied by an authorized Mercedes-Benz Center.

Main fuse box

The main fuse box is in the engine compartment on the driver's side in front of the bulkhead (wall separating the engine and passenger compartments).

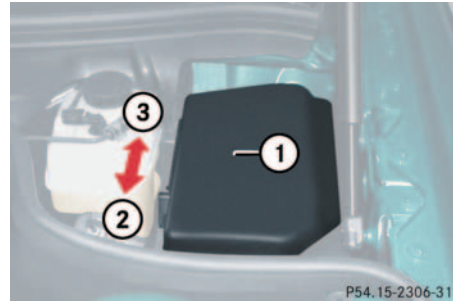

- 1 Main fuse box
- 2 Unlocking
- 3 Locking

Opening

- ▶ Move slide to position **3** and lift cover.

Closing

- ▶ Hook cover onto tabs and close.
- ▶ Move slide to position **2**.



The fuse box cover must be properly positioned with the slide at the  symbol to prevent moisture or dirt from entering the fuse box and possibly impairing fuse operation.

Fuse chart

The fuse chart is found in the vehicle tool kit in the trunk. The amperages of the fuses are also given there.

Spare fuses

Spare fuses are found in the vehicle tool kit in the trunk.

Fuse extractor

The fuse extractor is found in the vehicle tool kit in the trunk.



Technical data

Spare parts service

Warranty coverage

Identification labels

Layout of poly-V-belt drive

Engine

Rims and tires

Electrical system

Main dimensions

Weights

Fuels, coolants, lubricants, etc.

Consumer information

Spare parts service

The “Technical data” section provides the necessary technical data for your vehicle.

Spare parts service

All authorized Mercedes-Benz Centers maintain a stock of original spare parts required for maintenance and repair work. In addition, strategically located parts distribution centers provide quick and reliable parts service.

More than 300 000 different spare parts for Mercedes-Benz models are available.

Mercedes-Benz original spare parts are subjected to stringent quality inspections. Each part has been specifically developed, manufactured or selected for and adapted to Mercedes-Benz vehicles.

Therefore, Mercedes-Benz original spare parts should be installed.



The use of non-genuine parts and accessories not authorized by Mercedes-Benz could damage the vehicle, which is not covered by the Mercedes-Benz Limited Warranty, or could compromise the vehicle’s durability or safety.

Warranty coverage

Your vehicle is covered under the terms of the “warranties” printed in the Service and Warranty Information booklet. Your authorized Mercedes-Benz Center will exchange or repair any defective parts originally installed in the vehicle in accordance with the terms of the following warranties:

- New Vehicle Limited Warranty
- Emission System Warranty
- Emission Performance Warranty
- California, Maine, Massachusetts, and Vermont Emission Control Systems Warranty

Replacement parts and accessories are covered by the Mercedes-Benz Spare Parts and Accessories warranties, copies of which are available at any Mercedes-Benz Center.

Loss of Service and Warranty Information Booklet

Should you lose your Service and Warranty Information booklet, have your authorized Mercedes-Benz Center arrange for a replacement. It will be mailed to you.

Identification labels

Identification labels



1 Certification label
(above driver's door lock latch)

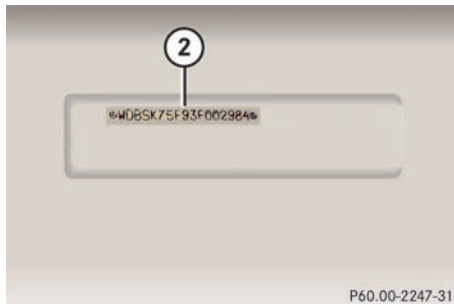

2 Vehicle Identification Number (VIN)
(below right rear storage compartment)

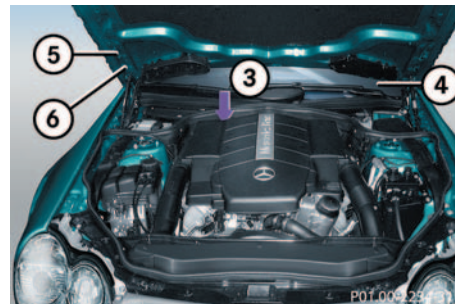

3 Engine number (engraved on engine)
4 VIN, visible (lower edge of windshield)
5 Emission control label
6 Information label, California version
Vacuum line routing for emission control system

When ordering spare parts, please specify vehicle identification and engine numbers.

Layout of poly-V-belt drive

SL 500

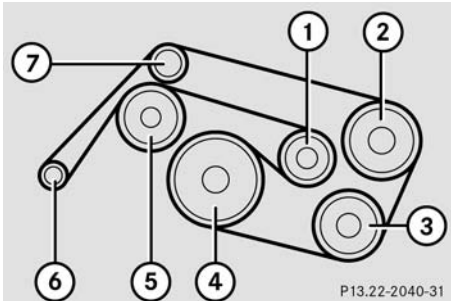

- 1 Automatic belt tensioner
- 2 Power steering pump
- 3 Air conditioner compressor
- 4 Crankshaft
- 5 Coolant pump
- 6 Generator (alternator)
- 7 Idler pulley

SL 55 AMG

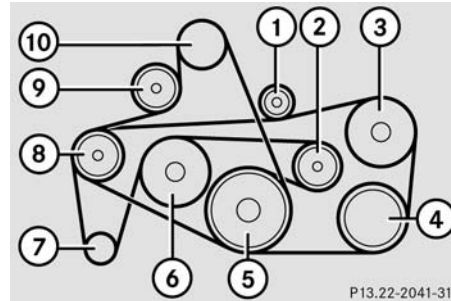

The SL 55 AMG has two poly-V-belts.

- 1 Idler pulley
- 2 Automatic belt tensioner
- 3 Power steering pump
- 4 Air conditioner compressor
- 5 Crankshaft
- 6 Coolant pump
- 7 Generator (alternator)
- 8 Idler pulley
- 9 Automatic belt tensioner
- 10 Super charger

Engine Engine

Model	SL 500 (230.475 ⁽¹⁾)	SL 55 AMG (230.474 ⁽¹⁾)
Engine	113	113
Mode of operation	4-stroke engine, gasoline injection	4-stroke engine, gasoline injection
No. of cylinders	8	8
Bore	3.82 in (97.00 mm)	3.82 in (97.00 mm)
Stroke	3.31 in (84.00 mm)	3.60 in (92.00 mm)
Total piston displacement	302.9 cu.in. (4966 cm ³)	331.8 cu.in. (5439 cm ³)
Compression ratio	10:1	9:1
Output acc. to SAE J 1349	302 hp / 5 600 rpm (225 kW / 5 600 rpm)	493 hp / 6 100 rpm (368 kW / 6 100 rpm)
Maximum torque acc. to SAE J 1349	339 ft.lb / 2 700 rpm (460 Nm / 2 700 rpm)	516 ft.lb / 2 750-4 000 rpm (700 Nm / 2 750-4 000 rpm)
Maximum engine speed	6 000 rpm	6 500 rpm
Firing order	1-5-4-2-6-3-7-8	1-5-4-2-6-3-7-8
Poly-V-belt	7 ft 10 in (2 390 mm)	8 ft 1 in / 4 ft 3 in (2 462 mm / 1 289 mm)

¹ The quoted data apply only to the standard vehicle. See an authorized Mercedes-Benz Center for the corresponding data of all special bodies and special equipment.

Rims and tires

Only use tires and rims which have been specifically developed for your vehicle and tested and approved by Mercedes-Benz. Other tires and rims can have detrimental effects, such as

- poor handling characteristics
- increased noise
- increased fuel consumption



Moreover, tires and rims not approved by Mercedes-Benz may, under load, exhibit dimensional variations and different tire deformation characteristics that could cause them to come into contact with the vehicle body or axle parts. Damage to the tires or the vehicle may be the result.



Further information on tires and rims is available at any authorized Mercedes-Benz Center. A tire inflation pressure table is located on the fuel filler cap of the vehicle. The tire pressure should be checked regularly and should only be adjusted on cold tires. Follow tire manufacturer's maintenance recommendation included with vehicle.

Same size tires

	SL 500	SL 55 AMG
Rims (light alloy)	8 ¹ / ₂ J x17	8 ¹ / ₂ J x18
Wheel offset	1.38 in (35 mm)	1.18 in (30 mm)
Summer tires (radial-ply tires)	255/45 R17 98W	-
Winter tires (radial-ply tires)	255/45 R17 98V M+S	255/40 R18 95V M+S

Rims and tires

Mixed size tires

	SL 500 (Sport Package*)	SL 55 AMG
Front axle:		
Rims (light alloy)	8 ¹ / ₂ J x18	8 ¹ / ₂ J x18
Wheel offset	1.18 in (30 mm)	1.18 in (30 mm)
Summer tires (radial-ply tires)	255/40 R18 95W or 255/40 R18 95Y	255/40 R18 95W or 255/40 R18 95Y
Rear axle:		
Rims (light alloy)	9 ¹ / ₂ Jx18	9 ¹ / ₂ Jx18
Wheel offset	1.30 in (33 mm)	1.30 in (33 mm)
Summer tires (radial-ply tires)	285/35 R18 97W ¹ or 285/35 R18 97Y ¹	285/35 R18 97W ¹ or 285/35 R18 97Y ¹

¹ Must not be used with snow chains.

Spare wheel

	SL 500
Rim	6B x17 ET25
Wheel offset	0.98 in (25 mm)
Collapsible tire	185/60-17-93P ¹

¹ Must not be used with snow chains.



The SL 55 AMG is not equipped with a spare wheel. TIREFIT (▷ page 302).

Electrical system

Model	SL 500	SL 55 AMG
Generator (alternator)	14 V/150 A	14 V/180 A
Starter motor	12 V/1.7 kW	12 V/1.7 kW
Battery		
Starter battery	12 V/35 Ah	12 V/35 Ah
Battery for electrical consumers	12 V/70 Ah	12 V/70 Ah
Spark plugs	Bosch F 8 DPER NGK PFR 5 R-11	NGK IL FR 6 A
Electrode gap	0.039 in (1.0 mm)	0.039 in (1.0 mm)
Tightening torque	15 – 22 ft.lb (20 – 30 Nm)	15 – 22 ft.lb (20 – 30 Nm)

Main dimensions**Main dimensions**

Model	SL 500	SL 55 AMG
Overall vehicle length	178.4 in (4531 mm)	178.4 in (4531 mm)
Overall vehicle length when opening/ closing hardtop	185.4 in (4709 mm)	185.4 in (4709 mm)
Overall vehicle width	71.9 in (1827 mm)	71.9 in (1827 mm)
Overall vehicle height	51.1 in (1295 mm)	51.1 in (1295 mm)
Overall vehicle height when opening/ closing hardtop	65.9 in (1674 mm)	65.9 in (1674 mm)
Wheelbase	100.8 in (2560 mm)	100.8 in (2560 mm)
Track, front	61.4 in (1559 mm)	61.8 in (1569 mm)
Track, rear	60.9 in (1547 mm)	61.1 in (1551 mm)

Weights

Roof load max.	110 lb (50 kg)
Trunk load max.	220 lb (100 kg)

Fuels, coolants, lubricants, etc.

Fuels, coolants, lubricants, etc.

Capacities

Vehicle components and their respective lubricants must match. Therefore only use brands tested and recommended by us.

Please refer to the Factory Approved Service Products pamphlet, or inquire at your Mercedes-Benz Center.

	Model	Capacity	Fuels, coolants, lubricants etc.
Engine with oil filter	SL 500	7.9 US qt (7.5 l)	Recommended engine oils
	SL 55 AMG	9.0 US qt (8.5 l)	
Automatic transmission		9.1 US qt (8.6 l)	MB Automatic Transmission Oil ¹
Rear axle		1.5 US qt (1.4 l)	Hypoid gear oil SAE 85 W 90
Hydraulic system for active body control (ABC)		approx. 5.3 US qt (5.0 l)	MB Hydraulic Fluid
Power steering		approx. 1.1 US qt (1.0 l)	MB Power Steering Fluid (Pentosin CHF 11S)
Front wheel hubs		approx. 3.0 oz (85 g) each	High temperature roller bearing grease
Brake system		1.1 US qt (1.05 l)	MB Brake Fluid (DOT 4+)
Cooling system	SL 500	approx. 12.2 US qt (11.6 l)	MB 325.0 Anticorrosion / Antifreeze
	SL 55 AMG	approx. 13.7 US qt (13 l)	
Fuel tank including a reserve of		21.1 US gal (80.0 l) 2.6 US gal (10.0 l)	Premium unleaded gasoline: Posted Octane 91 (Avg. of 96 RON / 86 MON)
Air conditioning system			R-134a refrigerant and special PAG lubricant oil (never R-12)

¹ MB part no. 001 989 21 03 10

	Model	Capacity	Fuels, coolants, lubricants etc.
Hydraulic system for retractable hardtop		0.42 US qt (0.4 l)	MB Hydraulic Fluid
Windshield washer and headlamp cleaning system		7.4 US qt (7 l)	MB Windshield Washer Concentrate ¹

¹ Use MB Windshield Washer Concentrate “S” and water for temperatures above freezing or MB Windshield Washer Concentrate “S” and commercially available pre-mixed windshield washer solvent/antifreeze for temperatures below freezing. Follow suggested mixing ratios (> page 346).

Engine oils

Engine oils are specifically tested for their suitability in our engines. Therefore, only use engine oils recommended by Mercedes-Benz. Information on recommended brands is available in the Factory Approved Service Products pamphlet, or at your authorized Mercedes-Benz Center.

Please follow FSS recommendations for scheduled oil changes. Failure to do so could result in engine damage not covered by the Mercedes-Benz Limited Warranty.

Engine oil additives

Do not blend oil additives with engine oil. They may be harmful to the engine operation.

Damage or malfunctions resulting from blending oil additives are not covered by the Mercedes-Benz Limited Warranty.

Air conditioner refrigerant

R-134a (HFC) refrigerant and special PAG lubricating oil are used in the air conditioning system.

Never use R-12 (CFC) or mineral-based lubricating oil, otherwise damage to the system will occur.

Brake fluid

During vehicle operation, the boiling point of the brake fluid is continuously reduced through the absorption of moisture from the atmosphere. Under extremely strenuous operating conditions, this moisture content can lead to the formation of bubbles in the system, thus reducing the system’s efficiency.

Therefore, the brake fluid must be replaced every two years, preferably in the spring.

Only brake fluid approved by Mercedes-Benz is recommended. Your authorized Mercedes-Benz Center will provide you with additional information.

Premium unleaded gasoline



To maintain the engine's durability and performance, premium unleaded gasoline must be used. If premium unleaded is not available and low octane fuel is used, follow these precautions:

- have the fuel tank only partially filled with unleaded regular and fill up with premium unleaded as soon as possible
- avoid full throttle driving and abrupt acceleration
- do not exceed an engine speed of 3000 rpm if the vehicle is loaded with a light load such as two persons and no luggage
- do not exceed $\frac{2}{3}$ of maximum accelerator pedal position if the vehicle is fully loaded or operating in mountainous terrain

Fuel requirements

Only use Premium unleaded meeting ASTM standard D 439:

- The octane number (posted at the pump) must be 91 min. It is an average of both the Research (R) octane number and the Motor (M) octane number: $(R+M) / 2$. This is also known as the ANTI-KNOCK INDEX.

Unleaded gasoline containing oxygenates such as Ethanol, IPA, IBA and TBA can be used provided the ratio of any one of these oxygenates to gasoline does not exceed 10%; MTBE not to exceed 15%.

The ratio of Methanol to gasoline must not exceed 3% plus additional cosolvents.

Using mixtures of Ethanol and Methanol is not allowed. Gasohol, which contains 10% Ethanol and 90% unleaded gasoline, can be used.

These blends must also meet all other fuel requirements, such as resistance to spark knock, boiling range, vapor pressure, etc.

Gasoline additives

A major concern among engine manufacturers is carbon build-up caused by gasoline. Mercedes-Benz recommends only the use of quality gasoline containing additives that prevent the build up of carbon deposits.

After an extended period of using fuels without such additives carbon deposits can build up, especially on the intake valves and in the combustion area, leading to engine performance problems such as:

- warm-up hesitation
- unstable idle
- knocking/pinging
- misfire
- power loss

Do not blend other specific fuel additives with fuel. This only results in unnecessary cost and may be harmful to the engine operation.

Damage or malfunctions resulting from poor fuel quality or from blending specific fuel additives are not covered by the Mercedes-Benz Limited Warranty.

Coolants

The engine coolant is a mixture of water and anticorrosion / antifreeze, which provides:

- corrosion protection
- freeze protection
- boiling protection (by increasing the boiling point)

The cooling system was filled at the factory with a coolant providing freeze protection to approximately -22°F (-30°C) and corrosion protection.

If the antifreeze mixture is effective to -22°F (-30°C), the boiling point of the coolant in the pressurized cooling system is reached at approximately 266°F (130°C).

The coolant solution must be used year round to provide the necessary corrosion protection and increase in the boil-over protection. You should have it replaced every 15 years or 150 000 miles (250 000 km), whichever comes first.

Coolant system design and coolant used stipulate the replacement interval. The above replacement interval is only applicable if MB 325.0 anticorrosion/antifreeze solution or other Mercedes-Benz approved products of equal specification (see Factory Approved Service Products pamphlet) are used to renew the coolant concentration or bring it back up to the proper level.

To provide important corrosion protection, the solution must be at least 45% anticorrosion/antifreeze (equivalent to freeze protection to approx. - 22°F [-30°C]). If you use a solution that is more than 55% anticorrosion/antifreeze (freeze protection to approx. - 49°F [-45°C]), the engine temperature will increase due to the lower

heat transfer capability of the solution. Therefore, do not use more than this amount of anticorrosion/antifreeze.

If the coolant level is low, water and MB 325.0 Anticorrosion /Antifreeze should be used to bring it up to the proper level (have cooling system checked for signs of leakage). Please make sure that the mixture is in accordance with label instructions.

The water in the cooling system must meet minimum requirements, which are usually satisfied by normal drinking water. If you are not sure about the water quality, consult your authorized Mercedes-Benz Center.

Fuels, coolants, lubricants, etc.

Anticorrosion/antifreeze

Your vehicle contains a number of aluminum parts. The use of aluminum components in motor vehicle engines necessitates that anticorrosion/antifreeze coolant used in such engines be specifically formulated to protect the aluminum

parts. (Failure to use such anticorrosion/antifreeze coolant will result in a significantly shortened service life.)

Therefore, the following product is strongly recommended for use in your vehicle: Mercedes-Benz 325.0 Anticorrosion/Antifreeze Agent.

Before the start of the winter season (or once a year in hot southern regions), you should have the anticorrosion/antifreeze concentration checked. The coolant is also regularly checked each time you bring your vehicle to your authorized Mercedes-Benz Center for service.

Anticorrosion/antifreeze quantity

Model	Approx. freeze protection	
	- 35°F (- 37°C)	- 49°F (- 45°C)
SL 500	6.1 US qt (5.8 l)	6.8 US qt (6.4 l)
SL 55 AMG	6.9 US qt (6.5 l)	7.6 US qt (7.2 l)

Windshield and headlamp washer system

Both the windshield and headlamp washer systems are supplied from the windshield washer fluid reservoir.

The windshield and headlamp washer fluid reservoir has a capacity of approx.

7.4 US qt. (7 l).

- ▶ Refill the reservoir with MB Windshield Washer Concentrate and water (or concentrate and commercially available premixed windshield washer solvent / antifreeze, depending on ambient temperatures).

Warning!



Washer solvent/antifreeze is highly flammable. Do not spill washer solvent/antifreeze on hot engine parts because it may ignite. You could be seriously burned.

Windshield and headlamp washer fluid mixing ratio

For temperatures above freezing use MB Windshield Washer Concentrate “S” and water:

- 1 part “S” to 100 parts water
(40 ml “S” to 4 l water)

For temperatures below freezing use MB Windshield Washer Concentrate “S” and commercially available premixed windshield washer solvent / antifreeze:

- 1 part “S” to 100 parts solvent
(40 ml “S” to 4 l solvent).

Consumer information

Consumer information

This has been prepared as required of all manufacturers of passenger cars under Title 49, Code of U.S. Federal Regulations, Part 575 pursuant to the “National Traffic and Motor Vehicle Safety Act of 1966”.

Uniform tire quality grading

Quality grades can be found, where applicable, on the tire sidewall between tread shoulder and maximum section width. For example:

Tread wear	Traction	Temperature
200	AA	A

All passenger car tires must conform to federal safety requirements in addition to these grades.

Treadwear

The treadwear grade is a comparative rating based on the wear rate of the tire when tested under controlled conditions on a specified government test course. For example, a tire graded 150 would wear one and one-half (1½) times as well on the government course as a tire graded 100. The relative performance of tires depends upon the actual conditions of their use, however, and may depart significantly from the norm due to variations in driving habits, service practices and differences in road characteristics and climate.

Traction

The traction grades, from highest to lowest are AA, A, B, and C. Those grades represent the tire’s ability to stop on wet pavement as measured under controlled conditions on specified government test surfaces of asphalt and concrete. A tire marked C may have poor traction performance.

Warning!



The traction grade assigned to this tire is based on straightahead braking traction tests, and does not include acceleration, cornering, hydroplaning, or peak traction characteristics.

Temperature

The temperature grades are A (the highest), B, and C, representing the tire's resistance to the generation of heat and its ability to dissipate heat when tested under controlled conditions on a specified indoor laboratory test wheel. Sustained high temperature can cause the material of the tire to degenerate and reduce tire life, and excessive temperature can lead to sudden tire failure. The grade C corresponds to a level of performance which all passenger car tires must meet under the Federal Motor Vehicle Safety Standard No. 109. Grades B and A represent higher levels of performance on the laboratory test wheel than the minimum required by law.

Warning!



The temperature grade for this tire is established for a tire that is properly inflated and not overloaded. Excessive speed, underinflation, or excessive loading, either separately or in combination, can cause excessive heat build-up and possible tire failure.

ABS

(Antilock Brake System)

Prevents the wheels from locking up during braking so that the vehicle can continue to be steered.

ABC

(Active Body Control)

Active, computer-controlled system that hydraulically adjusts the suspension at all four wheels in response to various driving situations.

Alignment bolt

Metal pin with thread. The alignment bolt, or centering bolt, is an aid used when changing a tire to align the wheel with the wheel hub.

BabySmart™ airbag deactivation system

This system detects if a special system compatible child restraint seat is installed on the front passenger seat. The system will automatically deactivate the passenger front airbag when such a seat is properly installed (indicator lamp  on the glove box lights up). See your authorized Mercedes-Benz Center for availability.

BabySmart™ compatible child seats

Special restraint system for children. The sensor system for the passenger seat prevents deployment of the passenger side airbag if a BabySmart™ compatible child seat is installed.

BAS

(Brake Assist System)

System for potentially reducing braking distances in emergency braking situations. The system is activated when it senses an emergency based on how fast the brake is applied.

Bi-Xenon headlamps*

Headlamps which use an electric arc as the light source and produce a more intense light than filament headlamps. Bi-Xenon headlamps produce low beam and high beam.

CAC

(Customer Assistance Center)

Mercedes-Benz customer service center, which can help you with any questions about your vehicle and provide assistance in the event of a breakdown.

CAN system

(Controller Area Network)

Data bus network serving to control vehicle functions such as door locking or windshield wiping depending on vehicle settings and/or ambient conditions.

Cockpit

All instruments, switches, buttons and indicator/warning lamps in the passenger compartment needed for vehicle operation and monitoring.

Collapsible tire

An especially compact spare tire that must be inflated with a provided air pump before using. It should only be used to bring the vehicle to the nearest service station.

COMAND

(Cockpit Management and Data System)

Information and operating center for vehicle sound and communications systems, including the radio and CD changer, as well as for other optional equipment (e.g. telephone).

Control system

The control system is used to call up vehicle information and to change component settings. Information and messages appear in the multifunction display. The driver uses the buttons on

the multifunction steering wheel to navigate through the system and to adjust settings.

Cruise control

Driving convenience system for automatically maintaining the vehicle speed set by the driver.

Distronic*

A driving convenience cruise control system which helps the driver maintain a pre-selected speed:

- If there is no vehicle directly ahead, the system operates in the same way as conventional cruise control.
- If a slower moving vehicle is ahead, Distronic* will reduce your vehicle speed to the extent permitted by reduced throttle and up to 20% braking power to maintain the preset minimum following distance.

DTR

(->Distronic*)

Engine number

The number set by the manufacturer and placed on the cylinder block to uniquely identify each engine produced.

ESP

(Electronic Stability Program)
Improves vehicle handling and directional stability.

ETD

(Emergency Tensioning Device)
Device which deploys in certain frontal and rear collisions exceeding the system's threshold to tighten the seat belts.
->SRS

FSS

(Flexible Service System)
Service indicator in the multifunction display that informs the driver when the next vehicle maintenance service is due.

Gear range

Number of gears which are available to the automatic transmission for shifting. The automatic gear shifting process can be adapted to specific operating conditions using the selector lever.

GPS

(Global Positioning System)

Satellite-based system for relaying geographic location information to and from vehicles equipped with special receivers. Employs CD digital maps for navigation.

Head-thorax airbag

Installed in the doors, these airbags protect occupants during side impact collisions exceeding a preset threshold. Unlike normal side airbags, head-thorax airbags are also designed to provide protection for the head area.

Instrument cluster

The displays and indicator/warning lamps in the driver's field of vision, including the tachometer, speedometer, engine temperature and fuel gauge.

KEYLESS-GO*

System for entering and operating the vehicle without the use of a key.

Kickdown

Depressing the accelerator past the point of resistance shifts the transmission down to the lowest possible gear. This very quickly accelerates the vehicle and should not be used for normal acceleration needs.

Voice control system*

Voice control system for car phones, portable cell phones and audio systems (radio, CD, etc.).

Lock button

Button on the door which indicates whether the door is locked or unlocked. Pushing the lock button down on an individual door from inside will lock that door.

Memory function

Used to store three individual seat, steering wheel and mirror positions for each key and, if so equipped, KEYLESS-GO* feature.

Menu

The control system displays are arranged in menus. Each menu contains a number of commands for particular systems. In the Audio menu, for example, you will find the commands *Select radio station* or *Operate CD player*. Using commands you can directly change the settings for your vehicle.

MON

The Motor Octane Number for gasoline as determined by a standardized method. It is an indication of a gasoline's ability to resist undesired detonation (knocking). The average of both the MON (Motor Octane Number) and RON (Research Octane Number) is posted at the pump, also known as ANTI-KNOCK INDEX.

Multifunction display

Two display fields in the instrument cluster used to present information provided by the control system.

Multifunction steering wheel

Steering wheel with buttons for operating the control system.

Overspeed range

Engine speeds within the red marking of the tachometer dial. Avoid this engine speed range, as it may result in serious engine damage that is not covered by the Mercedes-Benz Limited Warranty.

Parktronic*

System which uses visual and acoustic signals to assist the driver during parking maneuvers.

Poly-V-belt drive

Drives engine-components (alternator, AC compressor, etc.) from the engine.

Power train

Collective term designating all components used to generate and transmit motive power to the drive axles, including

- engine
- clutch/torque converter
- transmission
- transfer case
- drive shaft
- differential
- axle shafts/axles

Program mode selector switch

Used to switch the automatic transmission between standard operation (S) and winter operation (W).

SL 55 AMG with steering wheel gear-shift control and manual shift program: in addition to S and W (for regular S or winter W operation, see above), you can use MANUAL for manual shift program

Remote Vehicle Diagnostics

Transmission of vehicle data and current location to the Mercedes-Benz Customer Assistance Center for subscribers to Tele Aid service.

REST

(Residual Engine Heat Utilization)
Feature that uses the engine heat stored in the coolant to heat the vehicle interior for a short time after the engine has been turned off.

Retractable hardtop

Hardtop roof that can be opened and closed at the push of a button and stored in the trunk.

Roll bar

Occupant protection system which consists of tubular steel sheathed in plastic. The roll bar is lowered into the car body during normal driving conditions and raised automatically. It may also be manually raised and lowered by operating a button during critical driving situations.

RON

The Research Octane Number for gasoline as determined by a standardized method. It is an indication of a gasoline's ability to resist undesired detonation (knocking). The average of both the MON (Motor Octane Number) and RON (Research Octane Number) is posted at the pump, also known as ANTI-KNOCK INDEX.

SBC

(Sensotronic Brake Control)
Electronically controlled hydraulic braking system for increased braking safety and comfort.

Shift lock

When the vehicle is parked, this lock prevents the transmission selector lever from being inadvertently moved out of position **P** without key turned and brake pedal depressed.

SRS

(Supplemental Restraint System)
Seat belts, emergency tensioning device and airbags. Though independent systems, they are closely interfaced to provide effective occupant protection.

Tele Aid System

(Telematic Alarm Identification on De-mand)
The Tele Aid system consists of three types of response: automatic and manual emergency, roadside assistance and information. Tele Aid is initially activated by completing a subscriber agreement and placing an acquaintance call.
The Tele Aid system is operational providing that the vehicle's battery is charged, properly connected, not damaged and cellular and GPS coverage is available.

Tightening torque

Force times lever arm (e.g. a lug wrench) with which threaded fasteners such as wheel bolts are tightened.

TIREFIT

Accessory for emergency and temporary tire repair. The TIREFIT kit consists of a container with sealant material, a filler hose, a valve stem tool, a valve insert, and an air compressor.

Tire speed rating

Part of tire designation; indicates the speed range for which a tire is approved.

Traction

Force exerted by the vehicle on the road via the tires.

Vehicle level control

The ground clearance of the vehicle is automatically controlled according to a selected setting and speed. The driver can choose manually within a range of ground clearance, for example on very rough roads.

VIN

(Vehicle Identification Number)

The number set by the manufacturer and placed on the body to uniquely identify each vehicle produced.

Wind screen

Screen for deflecting wind from the vehicle interior when the hardtop is lowered.

Xenon headlamps

Headlamps which use an electric arc as the light source and produce a more intense light than filament headlamps.

- A**
- ABC 183, 351
 - Messages in display 258
 - Oil level 230
 - Setting vehicle level 184
 - ABC switch 24
 - ABS 68, 351
 - Malfunction indicator lamp 21, 251
 - Messages in display 259
 - Warning lamp 70, 251
 - ABS/ESP
 - Warning lamp 250
 - ABS/ESP warning lamp 21
 - Activating
 - Air circulation mode 152
 - Air conditioning (cooling) 155
 - Anti-theft alarm system 76
 - Central locking (control system) 128
 - Distance warning function* 180
 - Distrionic* 175
 - Easy-entry/exit feature 129
 - Electric air pump 316
 - ESP 72
 - Exterior lamps 102
 - Hazard warning flasher 105
 - High beams 104
 - Ignition 29
 - Immobilizer 48, 75
 - Parktronic* 189
 - Rear window defroster 153
 - Residual heat 154
 - Seat heater 97, 98
 - Seat ventilation* 96
 - Steering wheel gearshift control (SL 55 AMG Kompressor) 143
 - Tow-away alarm 77
 - Windshield wipers 44
 - Active Body Control (ABC) switch 24
 - Adjusting
 - Air distribution 151
 - Air volume 150
 - Backrest tilt 33
 - Exterior rear view mirrors 35
 - Head restraint height 33
 - Head restraint tilt 34
 - Inside rear view mirror 35
 - Lumbar support 93
 - Mirrors 35
 - Multicontour backrest* 93
 - Seat cushion depth 33
 - Seat cushion tilt 33
 - Seat height 33
 - Seat in the lumbar region 94
 - Seat in the shoulder region 94
 - Seats 32
 - Steering wheel 34
 - Air conditioner (cooling)
 - Turning off 155
 - Turning on 155
 - Air conditioner refrigerant 343
 - Air pressure see Tire inflation pressure
 - Air pump, electric 289
 - Turning on 316
 - Air recirculation mode 152
 - Air volume adjustment 150
 - Airbags 53
 - Children 54
 - Front 57
 - Head-thorax 57, 58
 - Kneebag 57
 - Passenger 57
 - Alarm
 - Audible 67, 75
 - Canceling 76
 - Visual 75
 - Alignment bolt 351
 - Alignment bolt (vehicle tool kit) 288, 314
 - Anticorrosion/antifreeze 342, 346

- Anti-theft alarm system 75
 - Arming 76
 - Canceling the alarm 76
 - Disarming 76
- Anti-theft systems
 - Anti-theft alarm system 75
 - Tow-away alarm 77
- Aquaplaning see Hydroplanning 219
- Armrest
 - Storage space 193
- Ashtray 23, 196
- ATF (automatic transmission fluid) 230
- Automatic climate control 23, 147
 - Center air vents 23
 - Deactivating 154
 - Residual heat utilization 154
 - Side air vents 23
 - Temperature sensor 25
- Automatic transmission 137
 - Emergency operation (Limp Home Mode) 144
 - Gear ranges 139
 - Gear shifting malfunctions 144
 - Kickdown 142
 - Manual shift program mode (SL 55 AMG Kompressor) 142
 - Manual shifting 138
 - One-touch gearshifting 138
 - Program mode selector switch 24, 141
 - Selector lever 24
 - Selector lever position 137
 - Transmission fluid 230
 - Winter program mode 141
- Auxiliary cup holder 191
 - Inserting 191
 - Removing 192
- B**
- BabySmart™ airbag deactivation system 64, 351
- BabySmart™ compatible child seats 351
- Backrest supports
 - Lumbar region 94
 - Shoulder region 94
- Backrest tilt 33
- Backup lamp bulbs 296
- Backup lamps 299
- BAS 68, 69, 351
 - Messages in display 260
- Batteries, electronic key
 - Changing 293
 - Check lamp 81
 - Checking 82
- Batteries, KEYLESS-GO* card
 - Changing 294
 - Check lamp 87
 - Checking 87
- Batteries, vehicle 232
 - Charging 321
 - Disconnecting 320
 - For electrical consumers 232, 289, 319
 - For starter 232, 319
 - Messages in display 263, 264
 - Reconnecting 321
 - Removing 321
 - Service 319
- Bi-Xenon headlamps 351
- Block heater 240
- Brake fluid 226, 342, 343
- Brake lamp bulb, high mounted 296
- Brake lamp bulbs, left and right 296
- Brake pads
 - Message in display 265

- Brakes 216
 - Warning lamp 253
- Break-in period 214
- Bulbs, replacing
 - Backup lamps 299
 - Brake lamps 296
 - Front lamps 295, 298
 - License plate lamps 300
 - Parking lamps 299
 - Rear fog lamp 299
 - Standing lamps 299
 - Tail lamp assemblies 299
 - Turn signal lamps, front 298
 - Turn signal lamps, rear 299
- C**
- CAC (Customer Assistance Center) 351
- CAN System 351
- Capacities
 - Fuels, coolants, lubricants etc. 342
- Catalytic converter 223
- CD player
 - Operating 116
- Center air vents 23
- Center console
 - Lower part 24
 - Upper part 23
- Centigrade
 - Setting temperature units 122
- Central locking
 - Automatic 91
 - Central locking switch 92
 - Switching on/off (control system) 128
 - Unlocking from inside 92
- Central locking switch 23
- Central unlocking switch 23
- Changing
 - Batteries (key) 293
 - Batteries (KEYLESS-GO* card) 294
 - Key setting 81
 - KEYLESS-GO* card setting 86
 - Vehicle level 185
- Charging
 - Vehicle batteries 321
- CHECK ENGINE malfunction indicator lamp 21, 256
- Checking
 - Batteries (KEYLESS-GO* card) 87
 - Coolant level 230
 - Oil level 226, 228
 - Tire inflate pressure 226
 - Vehicle lighting 226
- Vehicle lock status (KEYLESS-GO* card) 87
- Child safety
 - Airbags 54
 - Automatic child seat recognition 64
 - Infant and child restraint systems 52
- Cigarette lighter 23, 197
- Cleaning
 - Headlamps 146
 - Windshield 44
- Clock 19
- Closing
 - Glove box 190
 - Hood 228
 - Retractable hardtop (electronic key) 164
 - Retractable hardtop (switch) 161
 - Side windows 158
 - Side windows (KEYLESS-GO*) 88
 - Sunshade* 167
 - Trunk lid 83, 91
- Cockpit 352
- Collapsible tire 352
- COMAND 23
- COMAND* 352
- COMAND*, radio and telephone 222

- Combination switch 19, 43, 104
- Consumer information 348
- Control system 110, 113, 352
 - AUDIO menu 115
 - Convenience submenu 129
 - Distronic* menu 117
 - Functions 111
 - Instrument cluster submenu 122
 - Lighting submenu 124
 - Malfunction memory menu 118
 - Menus 111
 - Multifunction display 110
 - Multifunction steering wheel 111
 - NAVI menu 117
 - Standard display menu 110, 115
 - Submenus 114
 - TEL* menu 133
 - Trip computer menu 131
 - Vehicle submenu 127
- Coolant 345
 - Adding 231
 - Anticorrosion/antifreeze quantity 346
 - Checking level 230
 - Messages in display 272, 273, 274
 - Temperature 224
- Temperature gauge 108
- Temperature warning lamp 21
- Warning lamp 254
- Cooling see Air conditioner
- Courtesy lighting 107
- Cruise control 168, 262, 352
 - Canceling 169
 - Driving downhill 169
 - Driving uphill 169
 - Fine adjustment 170
 - Setting 170
 - Setting a higher speed 170
 - Setting a lower speed 170
 - Setting speed 169, 170
- Cruise control lever 19, 168
 - For cruise control 168
 - For DISTRONIC* 175
- Cup holder 23, 190
 - Opening 190
- Customer Assistance Center 351
- D**
- Daytime running lamp mode 103
 - Setting 124
- Deactivating
 - Air conditioning (cooling) 155
 - Air recirculation mode 152
- Alarm 76
- Anti-theft alarm system 76
- Automatic climate control 154
- Central locking (control system) 128
- Cruise control 169
- Distance warning function* 180
- Distronic* 178
- Engine with KEYLESS-GO* 49
- Engine with the key 48
- ESP 71
- Exterior lamps 102
- Hazard warning flasher 105
- Headlamps 48, 102
- Immobilizer 75
- Interior light delayed switch-off 127
- Parktronic* 189
- Rear window defroster 153
- Residual heat 154
- Seat heater 97, 98
- Seat ventilation* 96
- Steering wheel gearshift control (SL 55 AMG Kompressor) 143
- Tow-away alarm 77
- Deep water see Standing water
- Defrosting 151

- Delayed switch-off
 - Exterior lamps 125
 - Interior lighting 127
- Digital clock 19
- Direction of rotation (tires) 235
- Displays
 - Distronic* 173
 - Messages 287
 - Parktronic* 187
 - Service indicator 241
- Distance to empty (range)
 - Calling up 133
- Distance warning function* 179
 - Activating 180
 - Deactivating 180
 - DTR* warning lamp 179
 - Intermittent warning sound 179
 - Symbol 117, 174
- Distance warning function* switch 24
- Distronic indicator lamp* 21
- Distronic* 171, 352
 - Activating 175
 - Calling up settings 117, 174
 - Cleaning sensors 246
 - Cover 246
 - Cruise control lever 175
- Deactivating 178
- Deceleration 174
- Decreasing time interval 179
- Displays 173
- Distance warning function 179
- Distance warning function switch 24
- Driving hints 180
- DTR warning lamp 173
- Fine adjustment 177
- Increasing time interval 179
- Intermittent signal tone 173
- Messages in display 262
- Setting a higher speed 176
- Setting a slower speed 177
- Setting distance 24
- Setting speed 176
- Setting stored speed 177
- Warning and indicator lamps 173
- Distronic* warning lamp 21
- Door control panel 19, 26
- Door handle 26
- Doors
 - Message in display 286
 - Opening 89
 - Opening from inside vehicle 89
 - Storage compartments 192
- Downhill driving
 - Cruise control 169
- Drink holder see Cup holder
- Drinking and driving 215
- Drive sensibly - save fuel 215
- Driving 37, 42
- Driving abroad 222
- Driving hints
 - Distronic* 180
 - SBC brake system 74
- Driving instructions 215
- Driving off 218
- Driving safety systems 68
 - ABS 68
 - BAS 69
 - ESP 70
- Driving systems 168
 - ABC 183
 - Cruise control 168
 - Distronic* 171
 - Parktronic* 186
 - Vehicle level control 184
- DTR* see Distronic*

E

- Easy-entry/exit 129
 - Interrupting movement 130
 - Message in display 271
- Easy-Pack 198
 - Lowering manually 292
- Electric air pump 316
- Electrical consumer battery 232
- Electrical outlet 199
- Electronic Stability Program see ESP
- Emergency call system*
 - Initiating emergency call 203
 - Requirements 201
- Emergency engine shut-down 50
- Emergency operation (Limp Home Mode) 144
- Emergency operations
 - Locking the vehicle 292
 - Lowering Easy-Pack 292
 - Unlocking interior storage compartments 291
 - Unlocking the trunk 291
 - Unlocking the vehicle 290
- Emission control 224
- Emission control label 334

Engine

- Compartment 227
- Starting with KEYLESS-GO* 40
- Starting with the key 40
- Turning off with KEYLESS-GO* 49
- Turning off with the key 48
- Engine number 352
- Engine oil 228, 343
 - Adding 229
 - Additives 343
 - Checking level 228
 - Consumption 228
 - Filler neck 229
 - Messages in display 280
- Engine oil level see Oil level 226
- ESP 68, 70, 352
 - Messages in display 261
 - Switching off 71
 - Switching on 72
- ESP control switch 24
- ESP/ABS warning lamp 21
- ETD (emergency tensioning device) 52, 60, 352

F

- Fahrenheit
 - Setting temperature units 122
- Fastening the seat belts 37
- Fine adjustment
 - Cruise control 170
 - Distronic* 177
- First aid kit 288
- Flat tire 302
 - Spare wheel 312
 - TIREFIT kit 302, 308
- Flexible Service System (FSS) 241
- Fog lamp, rear 104, 296
 - Replacing bulb 299
- Fog lamps, front 104
 - Replacing bulbs 296
- Front airbags 57
- Front lamps 296
 - Replacing bulbs 298
- FSS (Flexible Service System) 241, 352

Fuel 225
 Additives 344
 Fuel requirements 344
 Fuel reserve warning lamp 21, 255
 Gasoline additives 344
 Premium unleaded gasoline 225,
 342, 344
 Fuel consumption statistics
 After start 132
 Since reset 132
 Fuel filler flap 225
 Locking 225
 Opening 225
 Unlocking 225
 Fuel requirements 344
 Fuel reserve tank
 Message in display 286
 Fuel tank
 Filler flap 225
 Fuels, coolants, lubricants etc. -
 capacities 342
 Functions (control system) 111
 Fuse chart 288, 329

Fuses 329
 Fuse chart 288, 329
 Fuse extractor 288, 329
 Main fuse box 329
 Spare fuses 288, 329

G

Garage door opener 25, 208
 Gasoline see Fuel
 Gear range
 Automatic transmission 139
 Indicator 21
 Limiting 139
 Shifting into optimal 138
 Glove box 19, 190
 Closing 190
 Opening 190
 GPS 353

H

Hands-free microphone 25
 Hardtop open/close control 24
 Hardtop see Retractable hardtop
 Hardtop switch 160
 Hazard warning flasher 105
 Hazard warning flasher switch 23

Head restraints
 Adjusting height 33
 Adjusting tilt 34
 Headlamp switch-off delay see Delayed
 switch-off, exterior lamps
 Headlamps
 Automatic mode 103
 Headlamp cleaning system 146, 233
 Manual mode 103
 Refilling washer fluid 233
 Head-thorax airbag 65, 353
 Heated steering wheel* 197
 Height adjustments
 Head restraints 33
 Seats 33
 Steering column 35
 Vehicle level 184
 High beam flasher 105
 High beam headlamp indicator 21
 High beam headlamps 43, 102, 296
 Replacing bulbs 298
 Switching on 104
 Hood 227
 Messages in display 279
 Horn 19
 Hydroplaning 219

I

- Ignition 29, 31
 - Switching on 29
- Immobilizer 75
 - Activating 48, 75
 - Deactivating 75
- Indicator lamps see Lamps, indicator and warning
- Infant and child restraint systems 62
- Instrument cluster 20, 108, 353
 - Select language 123
- Instrument lighting 108
- Interior lighting 106
 - Automatic control 106
 - Delayed switch-off 127
 - Manual operation 107
- Interior lighting control 25
- Interior storage spaces 190
 - Locking storage compartments 194
 - Unlocking storage compartments 194, 291
- Intermittent wiping 44

J

- Jack 289

K

- Key
 - Opening retractable hardtop 163
- Key dependent memory 130
- Key positions 29
- Key, electronic
 - Battery check lamp 81
 - Changing the batteries 293
 - Checking the batteries 82
 - Closing retractable hardtop 164
 - Factory setting 81
 - Global locking 81
 - Global unlocking 81
 - Individual setting 81
 - Messages in display 286
 - Positions in starter switch 29
 - Remote controls 80
 - Reprogramming 81
 - Starting the engine 40
 - Turning off the engine 48
 - Unlocking 28
- Key, Mechanical 290
- KEYLESS-GO* 353
 - Key positions 30
 - Starting the engine 40
 - Turning off the engine 49
- KEYLESS-GO* card 84
 - Changing the batteries 294
 - Checking the batteries 87
 - Checking vehicle lock status 87
 - Factory setting 86
 - Global locking 86
 - Global unlocking 86
 - Locking 88
 - Loss of 89
 - Messages in display 269
 - Reprogramming 86
 - Unlocking 30, 84
- KEYLESS-GO* start/stop button 23, 30, 40
- Keys 80
 - Loss of 84
- Kickdown 142, 353
- Kilometers/miles in speedometer 123
- Kneebag 57

- L**
- Labels, identification 334
 - Lamp bulbs, exterior 295
 - Lamps, exterior
 - Delayed switch-off 125
 - Exterior lamp switch 19, 43
 - Front 296
 - Headlamps 245
 - Light sensor 279
 - Messages in display 274
 - Replacing bulbs for rear 296, 299
 - Switching off 102
 - Switching on 102
 - Lamps, indicator and warning
 - ABS 21, 69, 70, 251
 - ABS/ESP 250
 - Airbag Off 57
 - Brakes 253
 - CHECK ENGINE 256
 - Coolant 254
 - Distronic* 173
 - DTR* 173
 - Engine diagnostics 256
 - Fuel reserve 255
 - SBC 72
 - Seat belts 256
 - Service indicator 241
 - SRS 52
 - Turn signals 21
 - Language
 - Multifunction display 123
 - License plate lamps 124, 296
 - Replacing bulbs 300
 - Light sensor 279
 - Lighter see Cigarette lighter
 - Lighting
 - Instruments 108
 - Interior 106
 - Settings (control system) 124
 - Trunk 107
 - Lock buttons 28, 30
 - Door handle (KEYLESS-GO*) 50
 - Trunk (KEYLESS-GO*) 88
 - Locking 47
 - Automatic while driving 91
 - Centrally from inside 92
 - Fuel filler flap 225
 - Global (electronic key) 81
 - Global (KEYLESS-GO* card) 86
 - Storage compartments 194
 - Trunk separately 83
 - Vehicle in an emergency 292
 - Low beam headlamps 102, 296
 - Replacing bulbs 298
 - Lowering
 - Easy-Pack manually 292
 - Roll bar 62
 - Luggage compartment, rear 195
 - Luggage cover 160
 - Message in display 272
 - Opening/closing 160
 - Lumbar support adjustment 93
- M**
- Main fuse box 329
 - Maintenance 241
 - Malfunction memory 118
 - Calling up 118
 - Clearing 119
 - MANUAL
 - Shift program mode
 - (SL 55 AMG Kompressor) 142

- Manual operations
 - Interior lighting control 107
 - Locking the vehicle 292
 - Lowering Easy-Pack 292
 - Unlocking interior storage compartments 291
 - Unlocking the driver's door 290
 - Unlocking the trunk 291
- Massage function 94
- Maximum cooling MAXCOOL 151
- Memory function 353
 - Storing exterior rear view mirror parking position 100
 - Storing key dependent settings 130
- Menus 111, 353
 - AUDIO 115
 - Distronic* 117
 - Malfunction memory 118
 - NAVI 117
 - Standard display 115
 - TEL* 133
 - Trip computer 131
- Microphone
 - Hands-free microphone 25
- Miles/kilometers in speedometer 123
- Minimum distance 187
- Mirrors 35
 - Adjusting inside rear view mirror 35
 - Automatic antiglare for inside mirror 145
 - Exterior rear view mirror parking position 131
 - Exterior rear view mirrors 35
 - Storing exterior mirror parking position 100
- Misfiring 45
- MON 225, 353
- Mph or km/h in speedometer 123
- Multicontour backrest* 93
- Multifunction display 110, 354
 - Left display field 21
 - Right display field 21
 - Selecting language 123
 - Standard display 110
- Multifunction display messages
 - ABC 258
 - ABS 259
 - BAS 260
 - Battery 263, 264
 - Brake pads 265
 - Coolant 273
 - Coolant level 272, 274
- Display 287
- Distronic* 262
- Doors 286
- Easy-entry/exit feature 271
- Engine oil level 280
- ESP 261
- Fuel reserve tank 286
- Hood 279
- Key 286
- KEYLESS-GO* card 269
- Lamps 274
- Luggage cover 272
- Parking brake 271
- Retractable hardtop 287
- Roll bar 286
- SBC brake system 265, 266, 268
- Seat belts 272
- Tele Aid 263
- Telephone* 270
- Tires 281
- Trunk lid 272
- Washer fluid 287
- Multifunction steering wheel 22, 111, 354
 - Buttons 111

- N**
 Navigation system
 Operating 117
 Night security illumination 125
- O**
 Octane number 355
 Odometer, main 21
 Oil
 Adding 229
 Checking level 228
 Consumption 228
 Dipstick 228
 Filler neck 229
 Oil level
 Checking 226
 One-touch shifting 138
 Opening
 Ashtray 196
 Cup holders 190
 Doors from the inside 89
 Fuel filler flap 225
 Glove box 190
 Hood 227
 Luggage cover 160
 Retractable hardtop (key) 163
 Retractable hardtop (switch) 160
- Side windows 158
 Storage space in the armrest 193
 Storage space in the center console 193
 Sunshade* 167
 Trunk from inside vehicle 89
 Trunk lid 83
- Operating**
 CD player 116
 Navigation system 117
 Radio 116
 Telephone* 133
- Operator's Manual 8
 Overhead control panel 25
 Overspeed range 109, 354
- P**
 Panic alarm 67
 Panic button on SmartKey 67
 Panorama roof*
 Sunshade* 166
 Sunshade* closing 167
 Sunshade* opening 167
 Parcel net in passenger footwell 194
 Parcel net in trunk 195
 Parctronic* deactivation switch 24
 Parking 218
 Parking assistance (Parktronic*) 186
 Parking brake
 Engaging 47
 Message in display 271
 Releasing 41
 Parking brake pedal 19
 Parking lamps 296
 Replacing the bulbs 299
 Switching on 102
 Parking position
 Exterior rear view mirrors 100, 131
 Parktronic* 24, 186, 354
 Activating 189
 Cleaning sensors 246
 Deactivating 189
 Malfunctioning 189
 Minimum distance 187
 Range 187
 Rear sensors 187
 Sensors 246
 Warning indicators 19, 187
 Passenger side
 Front airbag 57
 Head-thorax airbag 58
 Parcel net in footwell 194
 Pedals 215

Phone book* 135
 Loading 135
 Quick search 135
 Phone number*
 Dialing 135
 Redialing 136
 Pliers, universal (vehicle tool kit) 288
 Poly-V-belt drive 354
 Layout 335
 Power assistance 216
 Power train 354
 Power windows 157
 Side windows 157
 Problems while driving 45
 Product information 7
 Program mode selector switch 354
 Automatic transmission 24, 141
 PULSE function (Massage function) 94

Q

Quick search
 Phone book* 135

R

Radio
 Select station 116
 Station search 116
 Station selection setting 128
 Radio transmitters, control and operation 222
 Range (distance to empty)
 Calling up 133
 Reading lamp 25
 Rear lamps see Tail lamps
 Rear luggage compartment 195
 Rear view mirrors see Mirrors
 Rear window defroster 146, 153
 Redial memory 136
 Regular checks 226
 Regular driving style 183
 Remote controls
 Electronic key 80
 Remote Vehicle Diagnostics 354
 Replacing
 Backup lamp bulbs 299
 Brake lamp bulbs 296
 Bulbs 295
 Front lamp bulbs 298
 Front turn signal bulbs 298
 Fuses 329
 High beam bulbs 298
 License plate lamp bulbs 300
 Low beam bulbs 298
 Rear fog lamp bulb 299
 Rear lamp bulbs 296, 299
 Rear turn signal bulbs 299
 Wiper blades 301
 Reset knob 21
 Resetting
 All functions (control system) 120
 Fuel consumption statistics 132
 Service indicator (FSS) 242
 Trip odometer 109
 Residual heat utilization 154
 Restraint systems 52
 Airbags 52
 Child seat recognition 52
 Child seats 52
 Emergency tensioning device (ETD) 52, 60
 Seat belt force limiter 60
 Seat belts 52, 58

- Retractable hardtop 354
 - Closing (electronic key) 164
 - Closing (switch) 161
 - Locking after raising/lowering 162
 - Message in display 287
 - Opening (key) 163
 - Opening (switch) 160
 - Problems when operating 164
- Roll bar 61, 354
 - Installing wind screen 165
 - Lowering 62
 - Message in display 286
 - Raising 62
 - Warning lamp 21
- Roll bar buttons 24
- RON 225, 355
- Roof see Retractable hardtop
- S**
- SBC brake system 68, 72, 355
 - Activation 73
 - Deactivation 74
 - Driving hints 74
 - Messages in display 265, 266, 268
 - Self-check 74
 - Warning lamp 72
- Screwdriver (vehicle tool kit) 288
- Seat belt force limiter 60
- Seat belts 37, 52, 58
 - Message in display 272
 - Warning lamp 256
- Seat cushion depth 33
- Seat heater
 - Switching off 97
 - Switching on 97
- Seat ventilation*
 - Switching off 96
 - Switching on 96
- Seats
 - Adjusting backrest tilt 33
 - Adjusting cushion depth 33
 - Adjusting height 33
 - Adjusting lumbar support 94
 - Adjusting shoulder support 94
 - Heater 97
 - Massage function 94
 - Moving 95
- Selector lever 24
 - Lock 39, 355
 - Position (automatic transmission) 137
- Service
 - Batteries 319
 - Calling up the service indicator 242
 - Major service (Service B) 241
 - Minor service (Service A) 241
 - Overdue 241
 - Types 241
 - When due 241
- Service indicator 241
 - Clearing 241
- Service life (tires) 235
- Service System see FSS 241
- Setting
 - Convenience functions 129
 - Cruise control 170
 - Daytime running lamp mode 124
 - Distronic* time interval 179
 - Exterior rear view mirror parking position 131
 - Individual vehicle 119
 - Instrument lighting 108
 - Interior lighting delayed switch-off 127
 - Key dependent memory 130
 - Lamps and lighting (control system) 124

- Locator lighting 125
- Miles/kilometers in
 - speedometer 123
- Multifunction display language 123
- Night security illumination 125
- Radio station 116
- Speedometer display mode 123
- Station selection mode 128
- Suspension tuning 183
- Temperature (interior) 149
- Temperature indicator 122
- Time display mode 122
- Tire inflation pressure 129
- Units
 - Speedometer 123
 - Temperature 122
 - Tire inflation pressure 129
- Vehicle level control 184
- Setting speed
 - Cruise control 169, 170
 - Distronic* 176, 177
- Settings
 - Calling up DISTRONIC* 117, 174
 - Convenience functions 129
 - Factory (electronic key) 81
 - Individual (electronic key) 81
 - Resetting all (control system) 120
- Settings menu
 - Individual vehicle settings 119
 - Submenus 120
- Shifting
 - into optimal gear range 138
- Shifting gears
 - On steering wheel (SL 55 AMG) 142
- Shoulder support
 - Seat adjustment 94
- Side air vents 23
- Side marker lamps 296, 299
- Side windows 157
 - Automatic opening 158
 - Closing 158
 - Closing (KEYLESS-GO*) 88
 - Opening 158
 - Opening fully 158
 - Stopping 158
 - Synchronizing power windows 158
- SL 500
 - Spare wheel 338
 - Tires 338
- SL 55 AMG Kompressor
 - Tires 338
- SL 55 AMG Kompressor
 - MANUAL shift program mode 142
 - Steering wheel gearshift control 143
- Snow chains 240
- Spare fuses 288, 329
- Spare tire see Spare wheel 302
- Spare wheel* 289, 312
 - Inflating tire 316
 - Tire inflation pressure 316
- Speed settings
 - Cruise control 170
 - Distronic* 177
- Speedometer 21
 - Setting units 123
- Sporty driving style 183
- SRS 355
 - Indicator lamp 252
- Standing lamps 102, 296
 - Replacing bulbs 299
- Standing water
 - Driving instructions 222

- Starter battery 232, 319
- Starter switch 19, 29
- Starting difficulties 41
- Starting position 29
- Starting the engine
 - With KEYLESS-GO* 40
 - With the key 40
- Steering column
 - Height adjustment 35
 - Length adjustment 34
- Steering wheel 34
 - Adjusting 34
 - Buttons 22
 - Heating* 197
 - Height adjustment 35
 - Shifting gears (SL 55 AMG) 142
- Steering wheel adjustment stalk 19
- Steering wheel gearshift control
 - Activating 143
 - Deactivating 143
- Storage spaces
 - Armrest 193
 - Cup holder 190
 - Glove box 190
 - In door 192
 - In rear 193
- Locking 194
- Locking compartments
 - separately 194
- Rear 193
- Storage tray 193
- Unlocking 194
- Unlocking compartments
 - separately 194
- Ventilated compartments 156
- Submenus 114
 - Convenience 129
 - Instrument cluster 122
 - Lighting 124
 - Selecting 120
 - Settings menus 120
 - Vehicle 127
- Sun blind see Sunshade
- Sun visors 146
- Sunshade* 166
 - Closing 167
 - Opening 167
- Suspension tuning
 - For regular driving style 183
 - For sporty driving style 183
 - Setting 183
- Switching off
 - ABC 24
- Switching on
 - ABC 24
 - Front fog lamps 104
 - Rear fog lamp 104
- Switching on headlamps 43
- Symbol
 - Distance warning function* 117, 174
- Synchronizing
 - Power windows 158
- T**
- Tachometer 21, 109
 - Displaying gear range 139
- Tail lamps 296, 299
- Technical data 332
 - Electrical system 339
 - Main dimensions 340
 - Rims and tires 337
 - Weights 341
 - Windshield and headlamp washer system 347

- Tele Aid 200
 - Emergency calls 202
 - Information 205
 - Initiating an emergency call manually 203
 - Messages in display 263
 - Roadside assistance 204
 - SOS button 25, 203
 - Tele Aid system 201
- Tele Aid System 355
- Telephone* 22, 199
 - Answering a call 134
 - Dialing 135
 - Ending a call 135
 - Hands-free microphone 25
 - Loading phone book* 135
 - Messages in display 270
 - Operating 133
 - Redialing 136
 - Signal strength 134
- Telephones and two-way radios 223
- Temperature
 - Outside temperature indicator 109
 - Sensor 25
 - Setting interior temperature 149
 - Setting units in display 122
 - Tires 236
- Tightening torque 318, 355
- Tilt
 - Head restraint 34
- Time display mode
 - Setting 122
- Tire inflation pressure 305, 310
 - Checking 226, 235
 - Setting units 129
- Tire speed rating 220, 355
- Tire traction 220
- TIREFIT 355
- TIREFIT kit 289, 302, 308
- TIREFIT kit 1
 - Instructions for use 302
- TIREFIT kit 2
 - Instructions for use 308
- Tires 234, 348
 - Direction of rotation 235
 - Driving instructions 219
 - Messages in display 281
 - Retreads 234
 - Rims and tires 337
 - Rotating 238
 - Service life 235
 - SL 500 338
 - SL 55 AMG Kompressor 338
 - Temperature 236, 349
 - Tread depth 239
 - Wear pattern 238
 - Winter 239
- Tools 288
- Tow-away alarm 24, 77
 - Arming 77
 - Disarming 77
 - Disarming for transport 77
- Tow-away alarm switch 24
- Towing eye bolt (vehicle tool kit) 288
 - Installing 327
- Towing the vehicle 325
- Traction 141, 355
- Transmission see Automatic transmission
 - Fluid level 230

- Trip computer 131
 - Trip odometer 21
 - Resetting 109
 - Trunk
 - Closing the lid 91
 - Easy-Pack load assist 198
 - Lighting 107
 - Lock button (KEYLESS-GO*) 88
 - Locking separately 83
 - Message in display 272
 - Opening from inside vehicle 89
 - Opening the lid 83
 - Parcel net 195
 - Trunk lid lock 291
 - Unlocking (KEYLESS-GO*) 88
 - Unlocking in an emergency 291
 - Unlocking separately 82
 - Trunk lid 82
 - Trunk lid emergency release 90
 - Trunk lighting 107
 - Turn signals 19, 43
 - Additional in mirrors 296
 - Front bulbs 296
 - Indicator lamps 21
 - Rear bulbs 296
- U**
- Units
 - Setting speedometer units 123
 - Setting temperature units 122
 - Setting tire inflation pressure units 129
 - Unlocking 28
 - Centrally from inside 92
 - Driver's door in an emergency 290
 - Fuel filler flap 225
 - Global (KEYLESS-GO* card) 86
 - Interior storage compartments 291
 - Storage compartments 194
 - Trunk 82, 89
 - Trunk (KEYLESS-GO*) 88
 - Trunk in an emergency 291
 - Vehicle in an emergency 290
 - With the electronic key 28
 - With the KEYLESS-GO* card 30, 84
 - Uphill driving
 - Cruise control 169
- V**
- Vehicle
 - Individual settings 119
 - Locking 23
 - Locking in an emergency 292
 - Minimum distance (Parktronic*) 187
 - Towing 325
 - Unlocking 23
 - Unlocking in an emergency 290
 - Vehicle level 184, 356
 - Changing 185
 - Setting 185
 - Automatic 185
 - Manual 185
 - Vehicle level control 356
 - Vehicle level control switch 24
 - Vehicle lighting
 - Checking 226
 - Vehicle lock status
 - Checking (KEYLESS-GO*) 87
 - Vehicle tool kit 288
 - Alignment bolt 288
 - Fuse chart 288
 - Fuse extractor 288
 - Hex-socket wrench 288
 - Open-end wrench 288
 - Screwdriver 288
 - Spare fuses 288
 - Universal pliers 288
 - Wheel wrench 288
 - Ventilation and residual heat 154

VIN (vehicle identification number) 334, 356
Voice control system* 19
 Hands-free microphone 25
Voice control system+ 353

W

Warning lamps see Lamps, indicator and warning
Warning sounds
 Distance warning function* 179
 Distronic* 173
Warranty coverage 333
Washing the vehicle 245
Wear pattern (tires) 238
Wheel change 312
 Tightening torque 318
Wind screen 165, 356
 Installing 165
 Removing 166
Windows see Side windows
Windshield
 Refilling washer fluid 233
 Washer fluid 45, 233
 Washer system 233
 Windshield and headlamp washer system 347

Windshield washer fluid 45
 Filler neck 233
 Message in display 287
 Mixing ratio 347
 Refilling 233
Windshield wipers 19, 44
 Fast wiper speed 44
 Intermittent wiping 44
 Replacing wiper blades 301
 Wiping with windshield washer fluid 45
Winter driving
 Snow chains 240
 Tires 239
 Transmission program mode 141
Winter driving instructions 221
Winter tires 239
Wrench, hex-socket (vehicle tool kit) 288, 292
Wrench, open-end (vehicle tool kit) 288
Wrench, wheel (vehicle tool kit) 288, 289

X

Xenon headlamps 356
 Bi-Xenon 351

Service and Literature

Your authorized Mercedes-Benz Center has trained technicians and original Mercedes-Benz parts to service your vehicle properly. For expert advice and quality service, see your authorized Mercedes-Benz Center.

If you are interested in obtaining service literature for your vehicle, please contact your authorized Mercedes-Benz Center. We consider this the best way for you to obtain accurate information for your vehicle.

For further information you can find us on the Mercedes-Benz web-site www.mbusa.com or www.mercedes-benz.ca.

Warning



To help avoid personal injury, be extremely careful when performing any service work or repairs. Improper or incomplete service or the use of incorrect or inappropriate parts or materials may damage the vehicle or its equipment, which may in turn result in personal injury.

If you have any question about carrying out some service, turn to the advice of an authorized Mercedes-Benz Center.

We reserve the right to modify the technical details of the vehicle as given in the data and illustrations of this Operator's Manual. Reprinting, translation and copying, even of excerpts, is not permitted without our prior authorization in writing.

Title illustration no. P00.00-2865-26

Press time 10/07/02

GSP/SIP

Printed in Germany

Free Manuals Download Website

<http://myh66.com>

<http://usermanuals.us>

<http://www.somanuals.com>

<http://www.4manuals.cc>

<http://www.manual-lib.com>

<http://www.404manual.com>

<http://www.luxmanual.com>

<http://aubethermostatmanual.com>

Golf course search by state

<http://golfingnear.com>

Email search by domain

<http://emailbydomain.com>

Auto manuals search

<http://auto.somanuals.com>

TV manuals search

<http://tv.somanuals.com>