



Mercedes-Benz

SL

Operator's Manual

Symbols

Trademarks:

- Bluetooth® is a registered trademark of Bluetooth SIG Inc.
- ESP® is a registered trademark of Daimler.
- HomeLink® is a registered trademark of Prince, a Johnson Controls Company.
- SIRIUS and related marks are trademarks of SIRIUS XM Radio Inc.

The following symbols are found in this Operator's Manual:

Warning!

Warning notices draw your attention to hazards that may endanger your health or life, or the health or life of others.

 Highlights hazards that may result in damage to your vehicle.

 Helpful hints or further information you may find useful.

▶ This symbol points to instructions for you to follow.

▶ A number of these symbols appearing in succession indicates a multiple-step procedure.

▷ page This symbol tells you where to look for further information on a topic.

▷▷ This continuation symbol marks a warning or procedure which is continued on the next page.

Display Text in displays, such as the control system, are printed in the type shown here.

Our company and staff congratulate you on the purchase of your new Mercedes-Benz.

Your selection of our product is a demonstration of your trust in our company name. Furthermore, it exemplifies your desire to own an automobile that will be as easy as possible to operate and will provide years of service.

Your Mercedes-Benz represents the efforts of many skilled engineers and craftsmen. To help assure your driving pleasure, and also the safety of you and your passengers, we ask you to make a small investment of time:

- Please read this manual carefully, then return it to your vehicle where it will be handy for your reference.
- Please follow the recommendations contained in this manual. They are designed to acquaint you with the operation of your Mercedes-Benz.
- Please pay attention to the warnings and cautions contained in this manual. They are designed to help improve the safety of the vehicle operator and occupants.

We extend our best wishes for many miles of safe, pleasurable driving.

Mercedes-Benz USA, LLC

A Daimler Company



Index 4

Introduction 19

At a glance 25

Safety and security 37

Controls in detail 67

Operation 177

Practical hints 223

Technical data 293

- A**
- ABC (Active Body Control)** 142
 Messages in the multifunction display 231
- ABS (Antilock Brake System)** 55
 Indicator lamp 255
 Messages in the multifunction display 227
- Accessory weight** 205
- Accidents** 101
 Air bags 39
 Distance warning function 140
 Emergency calls (Tele Aid) 168
- Active Bi-Xenon headlamps**
 see Headlamps
- Active Body Control**
 see ABC
- Additives**
 Engine oil 306
 Gasoline 307
- Address change** 20
- Advanced Tire Pressure Monitoring System (Advanced TPMS)** 190
 Messages in the multifunction display 234, 253
- Air bags** 39
 Emergency call upon deployment .. 168
 Front, driver and passenger 41
 Head-thorax 42
 Knee bag 42
 Messages in the multifunction display 229
 OCS (Occupant Classification System) 43
 Passenger front air bag off indicator lamp 33, 43, 266
 Safety guidelines 40
- Air conditioning refrigerant and lubricant** 306
- Air distribution** 153
- Air pressure**
 see Tire inflation pressure
- Air pressure (tires)** 205
- Air pump (electric)** 280
- Air recirculation mode** 154
- AIRSCARF neck-level heating** 84
- Air vents** 151
- Air volume** 153
- Alarm system**
 see Anti-theft systems
- Alignment bolt (vehicle tool kit)** 224, 279
- Alternator**
 Messages in the multifunction display 247
- Alternator (Technical data)**
 see Vehicle specification
- AMG menu** 116
- Anticorrosion/antifreeze** 308
- Antilock Brake System**
 see ABS
- Anti-theft systems** 63
 Anti-theft alarm system 63
 Immobilizer 63
 Tow-away alarm 64
- Aquaplaning**
 see Hydroplaning
- Armrest**
 Storage compartment 162
- Ashtray** 166
- Aspect ratio (tires)** 205
- Audio/DVD menu** 119
- Auto-dimming rear view mirrors** 86
- Automatic central locking** 73, 126
- Automatic headlamp mode** 90
- Automatic interior lighting control** 94
- Automatic locking when driving** 126
- Automatic shift program** 106
- Automatic transmission** 103
 Automatic shift program 106
 Gear range indicator 106
 Gear ranges 106
 Gear selector lever 103
 Hill-start assist system 142
 Kickdown 105
 Kickdown (manual shift program) .. 111
 Manual shift program 109
 One-touch gearshifting 108
 Program mode indicator 107
 Program mode selector dial (SL 63 AMG) 107, 109

Program mode selector switch (automatic shift program)	106, 107
Program mode selector switch (manual shift program)	109
Shifting procedure	104
Steering wheel gearshift control	108
Transmission position indicator	104
Transmission positions	104
AUX socket	161
Axle oils	304

B

Backrest	
see Seats	
Backup lamps	
Messages in the multifunction display	249
Replacing bulbs	272
Bar (air pressure unit)	205
BAS (Brake Assist System)	56
Batteries, SmartKey	
Checking condition	71
Replacing	269
Battery, Vehicle	283
Charging	285
Jump starting	285
Messages in the multifunction display	247
Bead (tire)	205
Beverage holders	
see Cup holders	
Brake Assist System	
see BAS	
Brake fluid	
Checking level	185
Messages in the multifunction display	239
Brake lamps	
Cleaning lenses	218
Brake pads	
Messages in the multifunction display	238
Brakes	210
High-performance brake system	211
Parking brake	102
Warning lamp	255

Break-in period	178
Bulbs	
see Replacing bulbs	

C

CAC (Customer Assistance Center) ...	22
California retail buyers and lessees, important notice for	20
Calls (phone)	129
Can holders	
see Cup holders	
Capacities and recommended fuel/lubricants	303
Carpets, cleaning	220
Central locking	
Automatic	73, 126
KEYLESS-GO	69
Locking/unlocking from inside	73
SmartKey	68
Central locking/unlocking switch	73
Certification label	294
Children in the vehicle	
Air bags	39
Indicator lamp, passenger front air bag off	43
Infant and child restraint systems	52
OCS (Occupant Classification System)	43
Safety notes	51
Child safety	
see Children in the vehicle	
Chrome-plated exhaust tip, cleaning	221
Cigarette lighter	166
Climate control system	
Air conditioning	150
Air conditioning refrigerant	306
Air distribution	153
Air recirculation mode	154
Air vents	151
Air volume	153
Automatic mode	150
Deactivating system	149
Front defroster	153
Maximum cooling MAX COOL	153
Residual heat and ventilation	154
Temperature	151

- Clock** 28
 - Cockpit** 28
 - Cold tire inflation pressure** 205
 - Collapsible tire (spare wheel)** 303
 - COMAND system**
 - see separate COMAND system
 - operating instructions
 - Combination switch** 92
 - Control system** 113
 - Multifunction display 114
 - Multifunction steering wheel 113
 - Resetting to factory settings 121
 - Control system menus** 115
 - AMG 116
 - Audio/DVD 119
 - Distronic 120
 - Navigation 120
 - Settings 121
 - Standard display 116
 - Telephone 129
 - Trip computer 128
 - Vehicle status message memory ... 120
 - Control system submenus**
 - Convenience 127
 - Instrument cluster 122
 - Lighting 124
 - Vehicle 126
 - Convenience submenu**
 - Easy-entry/exit feature 127
 - Fold-in function for exterior rear view mirrors 127
 - Coolant**
 - Anticorrosion/antifreeze 308
 - Capacities 304
 - Checking level 184
 - Messages in the multifunction display 244
 - Temperature gauge 112
 - Warning lamp 263
 - Corner-illuminating lamps** 93
 - Replacing bulbs 272
 - Cruise control** 130
 - Activating 131
 - Canceling 132
 - Changing the set speed 132
 - Last stored speed 132
 - Lever 131
 - Messages in the multifunction display 232
 - Resume function 132
 - Setting current speed 131
 - Cup holders** 164
 - Curb weight** 205
 - Customer Assistance Center (CAC)** ... 22
 - Customer Relations Department** 22
- D**
- Dashboard**
 - see Instrument cluster
 - Data recording** 22
 - Daytime running lamp mode** 90
 - Switching on or off 124
 - Deep water**
 - see Standing water
 - Defogging (windshield)** 153
 - Defroster**
 - Front (Climate control system) 153
 - Rear window 155
 - Delayed shut-off**
 - Exterior lamps 125
 - Interior lighting 126
 - Department of Transportation**
 - see DOT
 - Difficulties**
 - While driving 101
 - With starting 99
 - Digital clock**
 - see Clock
 - Digital speedometer** 116
 - Dimensions (vehicle)**
 - see Vehicle specification
 - Direction of rotation (tires)** 197
 - Displays**
 - Digital speedometer 116
 - Distronic 135
 - Maintenance service indicator 214
 - Messages in the multifunction display 226
 - Multifunction display 114
 - Outside temperature 116
 - Symbol messages 237
 - Text messages 227
 - Trip computer 128

- Vehicle status message memory ... 120
 - Vehicle system settings 121
 - Distronic** 133
 - Cleaning system sensor cover 218
 - Control system 120
 - Distance warning function 140
 - Driving with 139
 - Menu 135
 - Messages in the multifunction display 232
 - Resume function 138
 - Sensor cover 218
 - Speed settings 137
 - Warning and indicator lamps 135, 262
 - Door control panel** 35
 - Doors**
 - Locking/unlocking (KEYLESS-GO) ... 69
 - Locking/unlocking (SmartKey) 68
 - Messages in the multifunction display 241
 - Opening from inside 72
 - Remote door unlock (Tele Aid) 171
 - Unlocking (Mechanical key) 267
 - DOT (Department of Transportation)** 205
 - Drinking and driving** 209
 - Driving**
 - Abroad 212
 - Hydroplaning 212
 - Instructions 98, 209
 - In winter 208
 - Problems 101
 - RACE START (SL 63 AMG) 141
 - Safety systems 54
 - Systems 130
 - Through standing water 212
 - With DISTRONIC 139
 - Driving and parking**
 - Safety notes 98
 - Driving off** 100, 212
 - Driving safety systems** 54
 - ABS 55
 - BAS 56
 - ESP® 56
 - ETS 57
 - Driving systems**
 - Active Body Control (ABC) 142
 - Cruise control 130
 - Distronic 133
 - Hill-start assist system 142
 - Parktronic system 144
 - RACE START (SL 63 AMG) 141
 - Driving tips, automatic transmission** 105
- E**
- Easy-entry/exit feature** 85, 127
 - Messages in the multifunction display 243
 - Electrical system**
 - Improper work on or modifications 21
 - Power outlet 166
 - Electrical system (Technical data)**
 - see Vehicle specification
 - Electronic Stability Program**
 - see ESP®
 - Emergency, in case of**
 - First aid kit 224
 - Flat tire 276
 - Hazard warning flasher 92
 - Roadside Assistance 20, 169
 - Towing the vehicle 287
 - Emergency calls**
 - Tele Aid 168
 - Emergency engine shutdown** 292
 - Emergency operations**
 - Remote door unlock (Tele Aid) 171
 - Trunk lid, emergency release 77
 - Emergency Tensioning Device**
 - see ETD
 - Emission control** 213
 - Information label 295
 - System warranties 19
 - Engine**
 - Break-in recommendations 178
 - Cleaning 217
 - Compartment 180
 - Malfunction indicator lamp 31, 32, 263
 - Messages in the multifunction display 244

- Number 295
 - Starting 98
 - Turning off 102
 - Engine (Technical data)**
see Vehicle specification
 - Engine coolant**
see Coolant
 - Engine oil**
Adding 183
 - Additives 306
 - Checking level 181
 - Consumption 181
 - Messages in the multifunction
display 247
 - Oil dipstick 182
 - Recommended engine oils and oil
filter 305
 - ESP® (Electronic Stability
Program)** 56
 - ETS 57
 - Messages in the multifunction
display 228
 - Warning lamp 259, 260
 - ETD (Emergency Tensioning
Device)** 49
 - Safety guidelines 40
 - ETS (Electronic Traction System)** 57
 - Express operation**
Power windows 96
 - Exterior lamp switch** 89
 - Exterior rear view mirrors** 86
 - Fold-in function 88
 - Parking position 87
 - Power-folding 88
 - Switching fold-in function on or
off 127
 - Exterior view of vehicle** 26
- F**
- Fastening the seat belts** 48
 - First aid kit** 224
 - Flat tire** 276
 - Lowering the vehicle 282
 - Mounting the spare wheel 277
 - Preparing the vehicle 277
 - Spare wheel 276, 303
 - Floormats** 175
- Fluids**
ABC fluid 184, 304
 - Automatic transmission fluid 304
 - Brake fluid 304
 - Capacities 303
 - Engine coolant 304
 - Engine oil 304
 - Hydraulic fluid 305
 - Power steering fluid 304
 - Washer and headlamp cleaning
system 305
 - Fog lamps** 91
 - Messages in the multifunction
display 250, 252
 - Fold-in function for exterior rear
view mirrors** 88
 - Front air bags**
see Air bags
 - Front lamps**
see Headlamps
 - Fuel** 178
 - Additives 307
 - Capacity, fuel tank 305
 - Drive sensibly-safe fuel 209
 - Fuel consumption statistics 128
 - Fuel filler flap and cap 179
 - Fuel tank reserve warning
lamp 31, 32, 262
 - Premium unleaded gasoline 306
 - Refueling 178
 - Requirements 307
 - Fuel filler flap** 179
 - Fuels, coolants, lubricants etc.** 303
 - Fuel tank**
Capacity 305
 - Fuel filler flap and cap 179
 - Refueling 178
 - Fuses** 291
- G**
- Garage door opener** 35, 172
 - Gasoline**
see Fuel
 - GAWR (Gross Axle Weight Rating)** ... 206
 - Gear range** 106
 - Indicator 106

- Limiting 108
 - Shifting into optimal 109
 - Gear selector lever** 103
 - Cleaning 220
 - Gearshift pattern 103
 - Lock 99, 103
 - Messages in the multifunction display 234
 - Shifting procedure 104
 - Transmission position indicator 104
 - Transmission positions 104
 - Generator**
 - see Alternator
 - Global locking/unlocking**
 - see Key, SmartKey
 - Glove box** 161
 - Gross Axle Weight Rating**
 - see GAWR
 - Gross Vehicle Weight**
 - see GVW
 - Gross Vehicle Weight Rating**
 - see GVWR
 - GVW (Gross Vehicle Weight)** 206
 - GVWR (Gross Vehicle Weight Rating)** 206
- H**
- Hard plastic trim items, cleaning** 220
 - Hazard warning flasher** 92
 - Headlamp cleaning system** 93
 - Headlamps**
 - Active Bi-Xenon headlamps 89
 - Automatic headlamp mode 90
 - Bi-Xenon 89, 272
 - Cleaning lenses 218
 - Cleaning system 93
 - Daytime running lamp mode 90
 - Delayed shut-off 125
 - High-beam flasher 92
 - High-beam headlamps 92
 - Low-beam headlamps 90
 - Messages in the multifunction display 249
 - Replacing bulbs 271
 - Switch 89
 - Headliner, cleaning and care of** 220
 - Head restraints** 80
 - Adjustment 80
 - Head-thorax air bags** 42
 - Height adjustment**
 - Seats 80
 - High-beam flasher** 92
 - High-beam headlamps** 92, 272
 - Indicator lamp 31, 32
 - Replacing bulbs 272
 - High-performance brake system** 211
 - Hill-start assist system** 142
 - Hood** 180
 - Messages in the multifunction display 241
 - Horn** 28
 - Hydroplaning** 212
- I**
- Identification labels** 294
 - Identification number, vehicle (VIN)** 295
 - Ignition** 78, 79, 99
 - Immobilizer** 63
 - Indicator lamps**
 - see Lamps, indicator and warning
 - Infant and child restraint systems**
 - see Children in the vehicle
 - Inflation pressure**
 - see Tires, Inflation pressure
 - Inside door handle** 35, 72
 - Instrument cluster** 30, 111
 - Illumination 112
 - Lamps 254
 - Multifunction display 114
 - Instrument lighting**
 - see Instrument cluster, Illumination
 - Instrument panel**
 - see Instrument cluster
 - Instruments and controls**
 - see Cockpit
 - Interior lighting** 94
 - Delayed shut-off 126
 - Reading lamps 94
 - Interior rear view mirror** 86
 - Auto-dimming rear view mirrors 86
 - Interior storage spaces**
 - see Storage compartments

Intermittent wiping	95
Rain sensor	95

J

Jack	225
Jump starting	285

K**Key, Mechanical**

Loss of	72
Replacing	72
Unlocking/locking manually	267
Valet locking	77

Key, SmartKey

Battery check lamp	71
Checking batteries	71
Factory setting	69, 71
Global locking (KEYLESS- GO)	71
Global locking (SmartKey)	69
Global unlocking (KEYLESS- GO)	71
Global unlocking (SmartKey)	69
Important notes on KEYLESS-GO	70
Locking/unlocking	68
Loss of	72
Messages in the multifunction display	242
Opening, trunk	73
Remote control	68
Replacing	72
Replacing batteries	269
Restoring to factory setting	69, 71
Selective setting	69, 71
Starter switch positions	78

KEYLESS-GO

Starter switch positions	79
--------------------------------	----

Kickdown	105
-----------------------	-----

Kickdown (manual shift program) ...	111
--	-----

Kilopascal (air pressure unit)	206
---	-----

Knee bag	42
-----------------------	----

L**Labels**

Certification	294
Emission control information	295
Tire and Loading Information placard	193
Tire inflation pressure	188

Lamps, exterior

Exterior lamp switch	89
Front	272
Messages in the multifunction display	249
Rear	272
Switching on/off	89

Lamps, indicator and warning

ABS	31, 32, 255
Brakes	30, 255
Coolant	263
Distance warning lamp	135, 140, 262
Engine malfunction	31, 32, 263
ESP®	30, 259, 260
ESP® OFF	31, 32, 259, 261
Fog lamps	91
Fuel tank reserve	31, 32, 262
High-beam headlamps	31, 32, 92
Instrument cluster	30, 254
Low tire pressure/TPMS malfunction telltale	265
Passenger front air bag off	33, 43, 266
Roll bar	258
Seat belt telltale	31, 32, 48, 256
SPORT handling mode	31
SRS	31, 32, 38, 257
Turn signals	30
Language, selecting	123

- License plate lamps**
 - Messages in the multifunction display 251
 - Replacing bulbs 272
 - Light alloy wheels, cleaning** 220
 - Lighter**
 - see Cigarette lighter
 - Lighting** 89
 - Daytime running lamp mode 90
 - Exterior 89
 - Interior 94
 - Limp-home mode** 111
 - Load assist** 164
 - Load index (tires)** 201, 206
 - Locator lighting** 125
 - Lock button**
 - Outside door handle (KEYLESS-GO) 71
 - Locking the vehicle**
 - KEYLESS-GO 69
 - Manually 269
 - SmartKey 68
 - Loss of**
 - Key 72
 - Service and Warranty Information booklet 294
 - Low-beam headlamps** 90
 - Exterior lamp switch 89
 - Switching on 90
 - Lubricants** 303
 - Luggage cover** 158
 - Lumbar support** 81
- M**
- Maintenance** 20
 - Maintenance System**
 - Service indicator display 214
 - Service indicator message 214
 - Service term exceeded 214
 - Manual headlamp mode (Low-beam headlamps)** 90
 - Manual shift program** 109
 - Maximum engine speed**
 - see Vehicle specification
 - Maximum loaded vehicle weight** 206
 - Maximum load rating (tires)** 206
 - Maximum permissible tire inflation pressure** 206
 - Mechanical key**
 - see Key, Mechanical
 - Media interface** 162
 - Memory function** 88
 - Menus**
 - see Control system menus
 - Mirrors** 86
 - Auto-dimming rear view mirrors 86
 - Exterior rear view mirror parking position 87
 - Exterior rear view mirrors 86
 - Interior rear view mirror 86
 - Memory function 88
 - Power-folding exterior rear view mirrors 88
 - Vanity mirror 165
 - MOExtended system** 283
 - MOExtended tires** 283, 300
 - MON (Motor Octane Number)** 307
 - Motor Octane Number**
 - see MON
 - Multicontour seat** 82
 - Multifunction display** 114
 - Symbol messages 237
 - Text messages 227
 - Vehicle status messages 226
 - Multifunction display messages**
 - ABC (Active Body Control) 231
 - ABS 227
 - Active headlamps 249
 - Advanced TPMS 234, 253
 - Air bags 229
 - Alternator 247
 - Automatic transmission 234
 - Battery 247
 - Brake fluid 239
 - Brake pads 238
 - Check engine 244
 - Coolant 244
 - Corner-illuminating lamps 252
 - Cruise control 232
 - Distronic 232
 - Doors 241
 - Easy-entry/exit feature 243
 - Engine oil 247
 - Engine service 244

ESP®	228
Fog lamps	250, 252
Gas cap	249
Gear selector lever	234
High-beam lamps	251
Hood	241
License plate lamps	251
Light sensor	251
Low-beam lamps	251
Parking brake	239
Parking lamps	251
Passenger front air bag	229
Reserve fuel	249
Retractable hardtop	241
Reverse lamp	249
Roll bar	51, 240
Side marker lamps	250
SmartKey	242
SmartKey with KEYLESS-GO	242
SRS	240
Tail lamps	252
Tele Aid	240
Tire inflation pressure	234, 253
Tire pressure monitor	234
Tires	234, 253
Trunk	241
Turn signals	253
Washer fluid	243
Multifunction steering wheel	
Adjustment	84
Buttons	113
Cleaning	220
Easy-entry/exit feature	85, 127
Gearshift control	108
Memory function	88
Overview	27
N	
Navigation menu	120
Navigation system	
see Separate operating instructions	
Nets, parcel	161
Night security illumination	125
Normal occupant weight	206
Number, vehicle identification (VIN)	295

O**Occupant Classification System**

see OCS (Occupant Classification System)

Occupant distribution 206

Occupant safety

Air bags	39
Children and air bags	39
Children in the vehicle	51
Fastening the seat belts	48
Infant and child restraint systems	52
Introduction	38
OCS (Occupant Classification System)	43
Passenger front air bag off indicator lamp	43, 266
Roll bar	51
Seat belts	40, 46

OCS (Occupant Classification System)

..... 43

 Self-test 45 |

Odometer 115 |

Oil, oil level

see Engine oil

On-board computer

see Control system

One-touch gearshifting 108

Operating safety 21

Ornamental moldings, cleaning 218

Overhead control panel 35

P

Paintwork, cleaning 216

Paintwork code 295 |

Panic alarm 54 |

Panorama roof

 Sunshade 160 |

Parcel nets 161 |

Parking 101 |

 Parktronic system 144 |

Parking and standing lamp

 Replacing bulbs 272 |

Parking brake 102 |

 Messages in the multifunction display 239 |

- Parking position**
 - Exterior rear view mirrors 87
 - Transmission position 104
 - Parktronic system**
 - Cleaning system sensors 218
 - Malfuction 147
 - Minimum distance 146
 - Sensor range 145
 - Switching on/off 147
 - System sensors 145
 - Warning indicators 28, 146
 - Parts service** 294
 - PASS AIR BAG OFF indicator lamp**
 - see Passenger front air bag off indicator lamp
 - Passenger front air bag** 41
 - Messages in the multifunction display 229
 - Passenger front air bag off indicator lamp** 33, 43, 266
 - Passenger safety**
 - see Occupant safety
 - Pedals** 209
 - Phone**
 - see Telephone
 - Plastic parts, cleaning** 220
 - Power assistance** 210
 - Power closing assist for trunk lid** 78
 - Power outlet** 166
 - Power seats**
 - see Seats
 - Power washer** 216
 - Power windows** 96
 - Cleaning 219
 - Door windows 97
 - Operation 96
 - Rear side windows 97
 - Synchronizing 98
 - Practical hints** 224
 - Problems**
 - While driving 101
 - With vehicle 22
 - With wipers 96
 - Product information** 19
 - Production options weight** 206
 - Program mode selector dial (SL 63 AMG)**
 - Automatic shift program 107
 - Manual shift program 109
 - Program mode selector switch**
 - Automatic shift program 106, 107
 - Manual shift program 109
 - Proximity key**
 - see Key, SmartKey
 - PSI (air pressure unit)** 206
- R**
- RACE START (SL 63 AMG)** 141
 - RACETIMER** 117
 - Radio**
 - Selecting stations 119
 - Radio transmitters** 213
 - Rain sensor**
 - see Intermittent wiping
 - Rear axle oil** 304
 - Rear fog lamp**
 - see Fog lamps
 - Rear lamps**
 - see Tail lamps
 - Rear window defroster** 155
 - Recommended tire inflation pressure** 187, 206
 - Refrigerant, air conditioning** 306
 - Refueling** 178
 - Regular checks** 180
 - Reminder, Seat belt**
 - see Seat belts, Telltale
 - Remote control**
 - see Key, SmartKey
 - Remote door unlock (Tele Aid)** 171
 - Replacing**
 - Key 72
 - Replacing bulbs** 271
 - Reporting safety defects** 22
 - Research Octane Number**
 - see RON
 - Reserve fuel**
 - Messages in the multifunction display 249
 - Warning lamp 31, 32, 262

- Reset button** 30, 112
- Restraint systems**
see Occupant safety
- Retractable hardtop** 155
Locking 157
Luggage cover 158
Messages in the multifunction display 241
Sunshade 160
Wind screen 157
- Rims** 206, 299
- Roadside Assistance** 20, 169
- Roll bar** 51
Lowering 51
Messages in the multifunction display 240
Raising 51
Warning lamp 258
- RON (Research Octane Number)** 307
- Roof**
see Retractable hardtop
- Rubber parts, cleaning** 220
- Run-flat tires**
see MOExtended tires
- S**
- Safety**
Driving safety systems 54
Occupant safety 38
Reporting defects 22
- Safety belts**
see Seat belts
- Seat belt force limiter** 49
- Seat belts** 46
Automatic comfort-fit feature 49
Children in the vehicle 51
Cleaning 220
Fastening 48
Proper use of 47
Safety guidelines 40
Safety notes 46
Telltale
..... 31, 32, 48, 256
- Seat heating** 83
- Seating capacity** 194
- Seats** 80
Adjustment 80
- Easy-entry/exit feature 85
Heating 83
Memory function 88
Multicontour seat 82
Ventilation 82
- Selective setting**
see Key, SmartKey
- Selector lever**
see Gear selector lever
- Self-test**
OCS (Occupant Classification System) 45
Tele Aid 167
- Service**
see Maintenance
- Service, parts** 294
- Service and warranty information** 19
- Service intervals**
see Maintenance System, Service indicator message
- Service life (tires)** 198
- Settings**
Factory setting (KEYLESS-GO) 71
Factory setting (SmartKey) 69
Memory function 88
Menu 121
Selective setting (KEYLESS-GO) 71
Selective setting (SmartKey) 69
- Side marker lamps**
Cleaning lenses 218
Messages in the multifunction display 250
- Sidewall (tires)** 207
- Side windows**
see Power windows
- SmartKey**
see Key, SmartKey
- SmartKey with KEYLESS-GO**
see Key, SmartKey
- Snow chains** 208
- Snow tires**
see Winter tires
- Spare wheel** 299
Mounting 277
Storage location 225
- Speedometer** 135

- Speed settings**
 - Cruise control 131
 - DISTRONIC 137
 - Resume function 132, 138
 - SRS**
 - Indicator lamp 31, 32
 - SRS (Supplemental Restraint System)**
 - Indicator lamp 38, 257
 - Messages in the multifunction display 240
 - Standing water, driving through** 212
 - Starter switch positions**
 - KEYLESS-GO 79
 - SmartKey 78
 - Starting difficulties (engine)** 99
 - Starting the engine** 98
 - Steering column**
 - see Multifunction steering wheel, Adjustment
 - Steering wheel**
 - see Multifunction steering wheel
 - Steering wheel gearshift control** 108
 - Stolen Vehicle Recovery Services** ... 172
 - Storage compartments** 161
 - Storing tires** 198
 - Sunshade** 160
 - Sun visors** 165
- T**
- Tachometer** 113
 - Overspeed range 113
 - Tail lamps**
 - Cleaning lenses 218
 - Messages in the multifunction display 252
 - Tar stains** 216
 - Technical data**
 - Air conditioning refrigerant 306
 - Brake fluid 306
 - Capacities fuels, coolants, lubricants etc. 303
 - Coolant 307
 - Engine oil additives 306
 - Engine oils 305
 - Fuel requirements 307
 - Gasoline additives 307
 - Identification labels 294
 - Premium unleaded gasoline 306
 - Rims and tires 299
 - Spare wheel 303
 - Vehicle specification SL 550 296
 - Vehicle specification SL 600 296
 - Vehicle specification SL 63 AMG ... 297
 - Vehicle specification SL 65 AMG ... 298
 - Washer and headlamp cleaning system 305, 309
 - Technical data (dimensions)**
 - see Vehicle specification
 - Technical data (electrical system)**
 - see Vehicle specification
 - Technical data (engine)**
 - see Vehicle specification
 - Technical data (weights)**
 - see Vehicle specification
 - Tele Aid** 167
 - Emergency calls 168
 - Information button 170
 - Initiating an emergency call manually 168
 - Messages in the multifunction display 240
 - Remote door unlock 171
 - Roadside Assistance button 169
 - Search & Send 171
 - SOS button 168
 - Stolen Vehicle Recovery Services .. 172
 - System self-test 167
 - Telephone** 27
 - Answering/ending a call 129
 - Hands-free microphone 35
 - Menu 129
 - Operation 129
 - Phone book 130
 - Redialing 130
 - Temperature**
 - Coolant 112
 - Interior temperature 151
 - Outside 116
 - Tightening torque**
 - Wheels 282
 - TIN (Tire Identification Number)** 207
 - Tire and Loading Information placard** 193
 - Tire and loading terminology** 205

- Tire Identification Number**
 - see TIN
- Tire inflation pressure**
 - Checking 189
 - Important notes on 188
 - Label on the inside of fuel filler flap 188
 - Placard on driver's door B-pillar 193
- Tire labeling** 200
- Tire load rating** 206
- Tire ply composition and material used** 207
- Tires** 186, 299
 - Advanced Tire Pressure Monitoring System (Advanced TPMS) 190
 - Air pressure 187
 - Care and maintenance 197
 - Cleaning 198
 - Direction of rotation, spinning 197
 - Important notes on tire inflation pressure 188
 - Inflation pressure 189
 - Information placard 193
 - Inspection 198
 - Labeling 200
 - Load index 201, 206
 - Load rating 206
 - Messages in the multifunction display 234, 253
 - MOExtended 300
 - Ply composition and material used 207
 - Problems under-/overinflation 189
 - Retreads 186
 - Rims and tires (technical data) 299
 - Rotation 200
 - Service life 198
 - Sizes 299
 - Snow chains 208
 - Speed rating 202, 207
 - Storing 198
 - Temperature 188, 200
 - Terminology 205
 - Tire Identification Number 207
 - TPMS low tire pressure/malfunction
 - telltale 31, 32, 265
 - Traction 199, 207
 - Tread 207
 - Tread depth 198, 207
 - Treadwear 199
 - Treadwear indicators 198, 207
 - Vehicle maximum load on 207
 - Wear pattern 200
 - Winter tires 207, 299
- Tire speed rating** 202, 207
- Total load limit** 207
- Tow-away alarm** 64
- Towing**
 - Towing eye bolt 288
 - Vehicle 287
- Towing eye bolt** 288
- Traction** 199, 207
- Transmission**
 - see Automatic transmission
- Transmission fluid level** 184
- Transmission gear selector lever**
 - see Gear selector lever
- Transmission positions** 104
- Traveling abroad** 212
- Tread (tires)** 207
- Tread depth (tires)** 198, 207
- Treadwear** 199
- Treadwear indicators (tires)** 198, 207
- Trip computer menu** 128
- Trip odometer, resetting** 113
- Trunk**
 - Closing 75
 - Load assist 164
 - Messages in the multifunction display 241
 - Opening 73
 - Opening/closing system 74, 76
 - Trunk lid emergency release 77
 - Unlocking manually 268
 - Valet locking 77
- Turning off the engine** 102
- Turn signals** 92
 - Cleaning lenses 218
 - Indicator lamps 30

Messages in the multifunction display	253
Replacing bulbs	272

U

Uniform Tire Quality Grading

Standards	199, 207
------------------------	----------

Units

Selecting digital speedometer display mode	123
Selecting speedometer/odometer display mode	123

Unleaded gasoline, premium	306
---	-----

Unlocking the vehicle

KEYLESS-GO	69
Manually	267
SmartKey	68

Upholstery, cleaning	221
-----------------------------------	-----

Useful features	164
------------------------------	-----

V

Valet locking	77
----------------------------	----

Vehicle

Battery	283
Care	215
Control system	113
Identification Number (VIN)	294
Locking/unlocking	68
Lowering (wheel change)	282
Modifications and alterations, Operating safety	21
Towing	287
Unlocking/locking manually	267

Vehicle dimensions

see Vehicle specification

Vehicle Identification Number

(VIN)	294
--------------------	-----

Vehicle jack

see Jack

Vehicle lighting	89
-------------------------------	----

Vehicle loading

Load limit	195
Terminology	205

Vehicle maximum load on the tire ...	207
---	-----

Vehicle specification

SL 550	296
SL 600	296
SL 63 AMG	297
SL 65 AMG	298

Vehicle status message memory ...	120
--	-----

Vehicle tool kit	224
-------------------------------	-----

Vehicle washing

see Vehicle care

Vehicle weights

see Vehicle specification

W

Warning lamps

see Lamps, Indicator and warning

Warning sounds

Distance warning function	140
DISTRONIC	135
Driver's or passenger's seat belt	48
Parking brake	239
Parktronic system	147
Seat belt telltale	256

Warranty coverage	294
--------------------------------	-----

Washer and headlamp cleaning

system	309
---------------------	-----

Washer fluid

Messages in the multifunction display	243
Mixing ratio	309
Refilling	185

Washing the vehicle	215
----------------------------------	-----

Wear pattern (tires)	200
-----------------------------------	-----

Weights (vehicle)

see Vehicle specification

Wheel

Changing	276
Removing	279
Spare	276
Tightening torque	282

Wheels, sizes	299
----------------------------	-----

Wheels, Tires and	186
--------------------------------	-----

Windows

see Power windows

Windows, cleaning	219
--------------------------------	-----

Wind screen	157
--------------------------	-----

Windshield

Cleaning wiper blades	219
Defogging	153
Washer fluid	309
Wipers	95

Windshield wipers

Replacing wiper blades	275
------------------------------	-----

Winter driving

Instructions	208
Snow chains	208
Tires	207

Winter tires 207, 299**Wood trims, cleaning** 221

Product Information

Please observe the following in your own best interest:

We recommend using Genuine Mercedes-Benz Parts as well as conversion parts and accessories explicitly approved by us for your vehicle model.

We have tested these parts to determine their reliability, safety and special suitability for Mercedes-Benz vehicles.

We are unable to make an assessment for other products and therefore cannot be held responsible for them, even if in individual cases an official approval or authorization by governmental or other agencies should exist. Use of such parts and accessories could adversely affect the safety, performance or reliability of your vehicle. Please do not use them.

Genuine Mercedes-Benz Parts and pre-approved conversion parts and accessories are available at any authorized Mercedes-Benz Center. In addition, you will receive comprehensive information on permissible technical modifications and expert installations.

Operator's Manual

Notes

This Operator's Manual contains a great deal of useful information. We urge you to read it carefully and familiarize yourself with the vehicle before driving.

For your own safety and longer service life of the vehicle, we urge you to follow the instructions and warnings contained in this Operator's Manual. Ignoring them could result in damage to the vehicle or personal injury to you or others. Vehicle damage caused by failure to follow instructions is not covered by the Mercedes-Benz Limited Warranty.

We continuously strive to improve our product and ask for your understanding that we reserve the right to make changes in design and equipment. Therefore, information, illustrations, and descriptions in this Operator's Manual might differ from your vehicle.

Vehicle equipment

Your vehicle may have some or all of the equipment described in this manual. Therefore, you may find explanations for optional equipment not installed in your vehicle. If you have any questions about operating particular equipment, any authorized Mercedes-Benz Center will be glad to demonstrate the proper procedures.

Optional equipment is also described in this manual, including operating instructions wherever necessary. Since they are special-order items, the descriptions and illustrations herein may vary slightly from the actual equipment of your vehicle.

If there are any equipment details that are not shown or described in this Operator's Manual, any authorized Mercedes-Benz Center will be glad to inform you of correct care and operating procedures. The Operator's Manual and Maintenance Booklet are important documents and should be kept with the vehicle.

Service and warranty information

The Service and Warranty Information booklet contains detailed information about the warranties covering your Mercedes-Benz, including:

- New Vehicle Limited Warranty
- Emission System Warranty
- Emission Performance Warranty
- California, Connecticut, Maine, Massachusetts, New York, Pennsylvania,

Rhode Island, and Vermont Emission Control System Warranty

- State Warranty Enforcement Laws (Lemon Laws)

Important notice for California retail buyers and lessees of Mercedes-Benz automobiles

Under California law you may be entitled to a replacement of your vehicle or a refund of the purchase price or lease price, if after a reasonable number of repair attempts Mercedes-Benz USA, LLC and/or its authorized repair or service facilities fail to fix one or more substantial defects or malfunctions in the vehicle that are covered by its express warranty. During the period of 18 months from original delivery of the vehicle or the accumulation of 18 000 miles (approximately 29 000 km) on the odometer of the vehicle, whichever occurs first, a reasonable number of repair attempts is presumed for a retail buyer or lessee if one or more of the following occurs:

- (1) the same substantial defect or malfunction results in a condition that is likely to cause death or serious bodily injury if the vehicle is driven, that defect or malfunction has been subject to repair two or more times, and you have directly notified Mercedes-Benz USA, LLC in writing of the need for its repair,
- (2) the same substantial defect or malfunction of a less serious nature than category (1) has been subject to repair four or more times and you have directly notified us in writing of the need for its repair, or
- (3) the vehicle is out of service by reason of repair of the same or different substantial defects or malfunctions for a cumulative total of more than 30 calendar days.

Written notification should not be sent to a dealer, it should be addressed to

Mercedes-Benz USA, LLC
Customer Assistance Center
One Mercedes Drive
Montvale, NJ 07645-0350

Maintenance

The Maintenance Booklet describes all the necessary maintenance work which should be performed at regular intervals.

Always have the Maintenance Booklet with you when you take the vehicle to an authorized Mercedes-Benz Center for service. The service advisor will record each service in the booklet for you.

Roadside Assistance

The Mercedes-Benz Roadside Assistance Program provides factory-trained technical help in the event of a breakdown. Calls to the toll-free Roadside Assistance number

1-800-FOR-MERCedes (1-800-367-6372)
(in the USA) 1-800-387-0100 (in Canada)

will be answered by Mercedes-Benz Customer Assistance Representatives 24 hours a day, 365 days a year.

For additional information refer to the Mercedes-Benz Roadside Assistance Program brochure (in the USA) or the Roadside Assistance section of the Service and Warranty Information Booklet (in Canada) in your vehicle literature portfolio.

Change of address or ownership

If you change your address, be sure to send in the "Change of Address Notice" found in the Service and Warranty Information Booklet, or simply call the Mercedes-Benz Customer Assistance Center (in the USA) at 1-800-FOR-MERCedes (1-800-367-6372), or Customer Service (in Canada) at 1-800-387-0100. This will assist us in

contacting you in a timely manner should the need arise.

If you sell your Mercedes, please leave all literature with the vehicle to make it available to the next operator.

If you bought this vehicle used, be sure to send in the “Notice of Purchase of Used Car” found in the Service and Warranty Information Booklet, or call the Mercedes-Benz Customer Assistance Center (in the USA) at 1-800-FOR-MERcedes (1-800-367-6372), or Customer Service (in Canada) at 1-800-387-0100.

Operating your vehicle outside the USA or Canada

If you plan to operate your vehicle in foreign countries, please be aware that:

- Service facilities or replacement parts may not be readily available.
- Unleaded gasoline for vehicles with catalytic converters may not be available; the use of leaded fuels will damage the catalysts.
- Gasoline may have a considerably lower octane rating, and improper fuel can cause engine damage.

Certain Mercedes-Benz models are available for delivery in Europe under our European Delivery Program. For details, consult an authorized Mercedes-Benz Center or write to:

In the USA:

Mercedes-Benz USA, LLC
European Delivery Department
One Mercedes Drive
Montvale, NJ 07645-0350

In Canada:

Mercedes-Benz Canada, Inc.
European Delivery Department
98 Vanderhoof Avenue
Toronto, Ontario M4G 4C9

Operating safety

Warning!

Work improperly carried out on electronic components and associated software could cause them to cease functioning. Because the vehicle's electronic components are interconnected, any modifications made may produce an undesired effect on other systems. Electronic malfunctions could seriously impair the operating safety of your vehicle.

Contact an authorized Mercedes-Benz Center for repairs or modifications to electronic components.

Other improper work or modifications on the vehicle could also have a negative impact on the operating safety of the vehicle.

Some safety systems only function while the engine is running. You should therefore never turn off the engine while driving.

Warning!

Heavy blows against the vehicle underbody or tires/wheels may cause serious damage and impair the operating safety of your vehicle. Such blows can be caused, for example, by running over an obstacle, road debris or a pothole. If you feel a sudden significant vibration or ride disturbance, or you suspect that damage to your vehicle as occurred:

- turn on your hazard warning flashers
- slow down carefully
- drive with caution to an area which is a safe distance from the road

Inspect the vehicle underbody and tires/wheels for possible damage. If the vehicle appears unsafe, have it towed to the nearest authorized Mercedes-Benz Center or other qualified maintenance or repair facility for further inspection or repairs.

Proper use of the vehicle

Proper use of the vehicle requires that you are familiar with the following information and rules:

- the safety precautions in this manual
- the “Technical data” section in this manual
- traffic rules and regulations
- motor vehicle laws and safety standards

Warning!

Various warning labels are attached to your vehicle. These warning labels are intended to make you and others aware of various risks. Do not remove any of these warning labels unless explicitly instructed to do so by information on the label itself. Removing warning labels may cause you and others to be unaware of certain risks which may result in an accident and/or personal injury.

Problems with your vehicle

If you should experience a problem with your vehicle, particularly one that you believe may affect its safe operation, we urge you to contact an authorized Mercedes-Benz Center immediately to have the problem diagnosed and corrected if required. If the matter is not handled to your satisfaction, please discuss the problem with the Mercedes-Benz Center management or, if necessary, contact us at one of the following addresses:

In the USA:

Customer Assistance Center
Mercedes-Benz USA, LLC
One Mercedes Drive
Montvale, NJ 07645-0350

In Canada:

Customer Relations Department
Mercedes-Benz Canada, Inc.
98 Vanderhoof Avenue
Toronto, Ontario M4G 4C9

Reporting safety defects

For the USA only:

The following text is published as required of manufacturers under Title 49, Code of U.S. Federal Regulations, Part 575 pursuant to the “National Traffic and Motor Vehicle Safety Act of 1966”.

Reporting safety defects

If you believe that your vehicle has a defect which could cause a crash or could cause injury or death, you should immediately inform the National Highway Traffic Safety Administration (NHTSA) in addition to notifying Mercedes-Benz USA, LLC.

If NHTSA receives similar complaints, it may open an investigation, and if it finds that a safety defect exists in a group of vehicles, it may order a recall and remedy campaign. However, NHTSA cannot become involved in individual problems between you, your dealer, or Mercedes-Benz USA, LLC.

To contact NHTSA, you may call the Vehicle Safety Hotline toll-free at 1-888-327-4236 (TTY: 1-800-424-9153); go to **www.safercar.gov**; or write to: Administrator, NHTSA Headquarters, 1200 New Jersey Avenue, SE, West Building, Washington, DC 20590.

You can also obtain other information about motor vehicle safety from **www.safercar.gov**.

Vehicle data recording

Information regarding electronic recording devices

(Including notice pursuant to California Code § 9951)

Please note that your vehicle is equipped with devices that can record vehicle systems data and, if equipped with the Tele Aid system, may transmit some data in certain accidents.

This information helps, for example, to diagnose vehicle systems after a collision and to continuously improve vehicle safety.

Daimler may access the information and share it with others

- for safety research or vehicle diagnosis purposes
- with the consent of the vehicle owner or lessee
- in response to an official request by law enforcement or other government agency
- for use in dispute resolution involving Daimler, its affiliates or sales/service organization and/or
- as otherwise required or permitted by law

Please check the Tele Aid subscription service agreement for details regarding the information that may be recorded or transmitted via that system.

Exterior view	26
Multifunction steering wheel	27
Cockpit	28
Instrument cluster	30
Center console	33
Overhead control panel	35
Door control panel	35



Exterior view

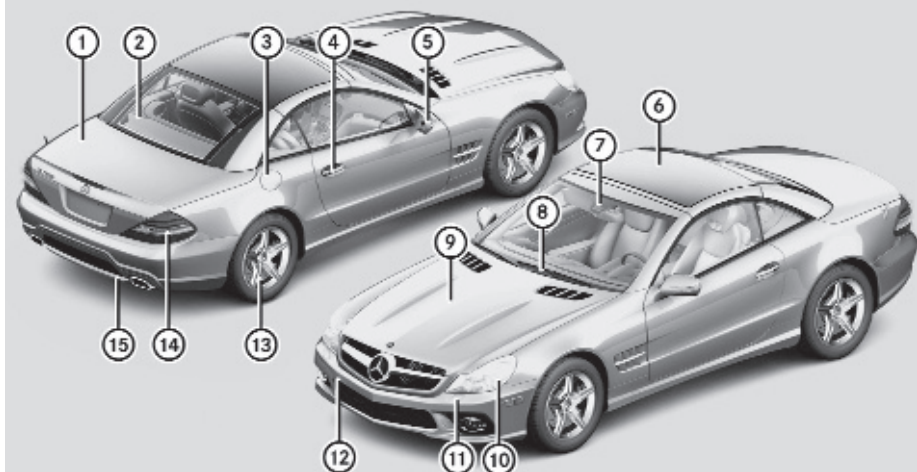

P00.00-1346-31

i This Operator's Manual describes all features, standard or optional, potentially available for your vehicle at the time of purchase. Please be aware that your vehicle might not be equipped with all features described in this manual.





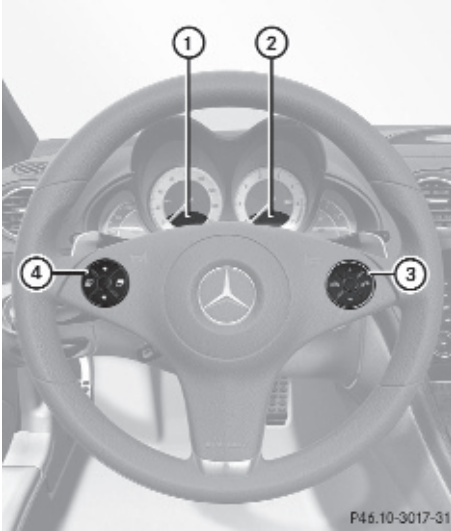

	Function	Page
①	Trunk: Locking and unlocking Opening and closing Valet locking	68 73, 75 77
②	Rear window defroster	155
③	Fuel filler flap	178
④	Doors: Locking and unlocking	68, 267
⑤	Exterior rear view mirrors	86
⑥	Retractable hardtop	155
⑦	Windshield: Wiping with washer fluid Cleaning	96 219
⑧	Wipers	95





	Function	Page
	Wiper blades, replacing Wiper blades, cleaning	275 219
⑨	Hood	180
⑩	Front lamps	271
⑪	Headlamp cleaning system	93
⑫	Front towing eye	288
⑬	Tires and wheels Rims and tires	186 299
⑭	Rear lamps	271
⑮	Rear towing eye	288

Multifunction steering wheel



P46.10-3017-31

	Function	Page
①	Left multifunction display	114
②	Right multifunction display	114
③	Press button  : to end a call to reject an incoming call Press button  : to answer a call to dial ¹ to redial ¹ Press button  or  : to select submenus in the Settings menu to set values to operate the RACETIMER ² to set the volume	129 129 129 129 129 122 117
④	Press button  or  to select next/previous menu.	113

Function	Page
Press button  or  briefly: to move within a menu to select previous or next track, scene or stored station within Audio/DVD menu	119
to switch to the phone book and select a name or number within Telephone menu	129
Press and hold button  or  : to select previous or next track with quick search or to select previous or next station in station list or wave band within Audio/DVD menu	119
to start the quick search in the phone book within Telephone menu	129

¹ Function only available in telephone menu.

² AMG vehicles only.

Cockpit

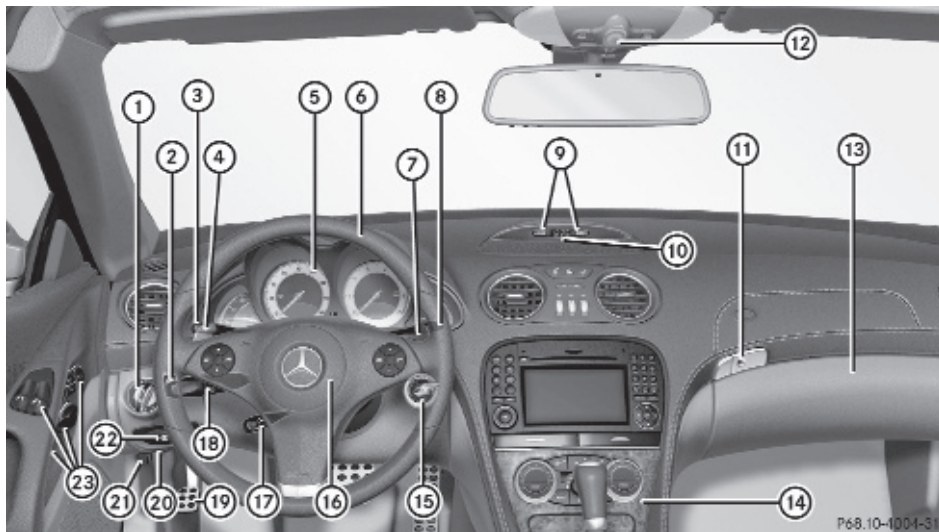

P68.10-1004-31

	Function	Page
①	Exterior lamp switch	89
②	Headlamp cleaning button	93
③	Cruise control lever: Cruise control	131
	DISTRONIC	136
④	Left steering wheel gearshift control	108
⑤	Instrument cluster	30, 111
⑥	Multifunction steering wheel	27, 113
⑦	Right steering wheel gearshift control	108
⑧	Lever for Voice Control System ³	
⑨	Front Parktronic warning indicators	146
⑩	Digital clock	

	Function	Page
⑪	Storage compartments (locking/unlocking)	161
⑫	Overhead control panel	35
⑬	Glove box	161
⑭	Center console	33
⑮	Starter switch	78
⑯	Horn	
⑰	Steering wheel adjustment	85
⑱	Combination switch: Turn signals	92
	Wipers	95
	High beam	92
⑲	Parking brake pedal	102
⑳	On-board diagnostics (OBD) socket	
㉑	Hood lock release	180

³ See separate operating instructions.







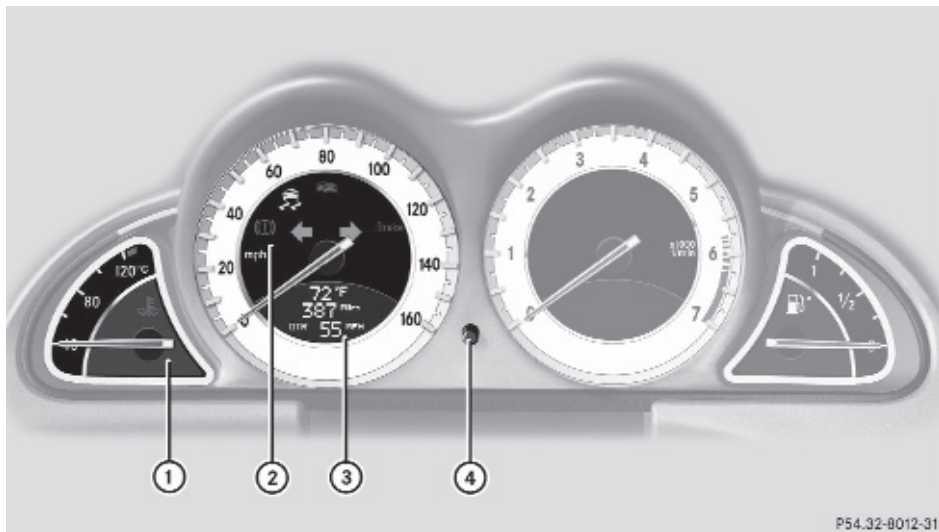

	Function	Page
②②	Parking brake release	102
②③	Door control panel	35

Instrument cluster

At a glance



P54.32-0012-31

Function	Page
① Coolant temperature gauge  Coolant temperature warning lamp	112 263
② Speedometer with:  Left turn signal indicator lamp  Brake warning lamp, Canada only  ABS/ESP [®] warning lamp (Version 1) ⁴  ABS/ESP [®] warning lamp (Version 2) ⁴  Distronic indicator lamp (white) or distance warning lamp (red) ⁵  BRAKE Brake warning lamp, USA only  Right turn signal indicator lamp	255 258 260 135, 262 255

Function	Page
③ Left multifunction display with: Outside temperature indicator or digital speedometer (depending on selected setting in the control system) Main odometer Set speed for cruise control or Distronic	116, 122 114 130, 136
④ Reset button for: Trip odometer Settings Adjusting instrument cluster illumination	113 121 112

⁴ Depending on vehicle production date.

⁵ Vehicles without Distronic: Warning/indicator lamp without function. It illuminates when the ignition is switched on. It should go out when the engine is running.

Version 1 (depending on vehicle production date)

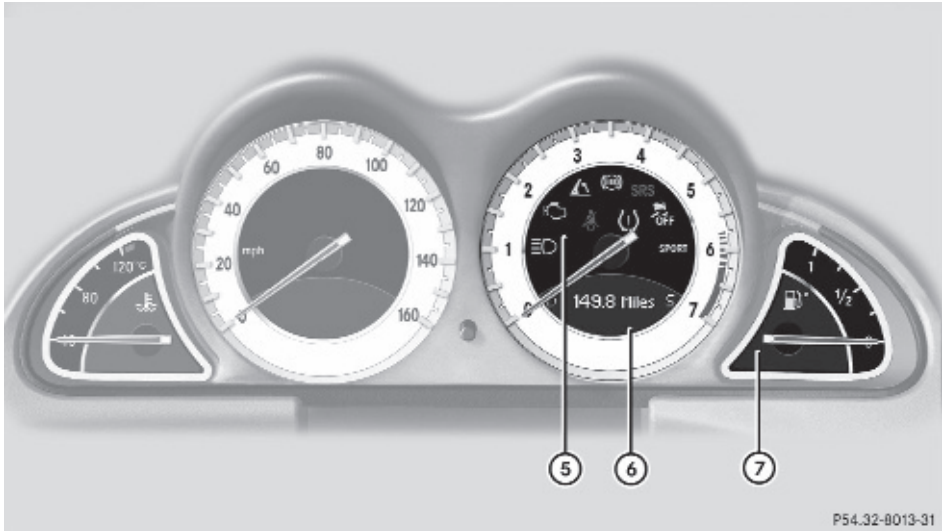

P54.32-8013-31

	Function	Page		Function	Page		
⑤	Tachometer with:		⑥	Low tire pressure telltale, Canada only	190, 265		
	High-beam headlamp indicator lamp	92		SPORT handling mode warning lamp, SL 63 AMG only	58, 258		
	Engine malfunction indicator lamp	263		Right multifunction display with:	Trip odometer	113	
	Seat belt telltale	48, 256			Transmission position indicator	104	
	Roll bar warning lamp	258			Gear range indicator	106	
	Antilock Brake System (ABS) indicator lamp	55, 255			Transmission program mode indicator	106	
	Supplemental Restraint System (SRS) indicator lamp	38, 257			⑦	Fuel gauge with:	
	ESP® OFF warning lamp	258				Fuel tank reserve warning lamp (the arrow indicates that the fuel filler flap is on the right-hand side)	262
	Combination low tire pressure/TPMS malfunction telltale, USA only	190, 265					

Version 2 (depending on vehicle production date)

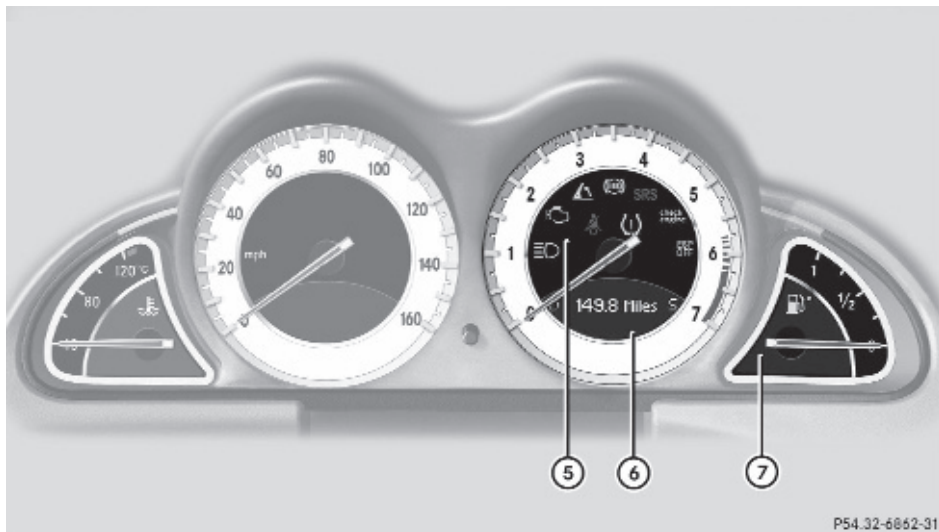

P54.32-6052-31

Function	Page
⑤ Tachometer with:	
High-beam headlamp indicator lamp	92
Engine malfunction indicator lamp, Canada only	263
Seat belt telltale	48, 256
Roll bar warning lamp	258
Antilock Brake System (ABS) indicator lamp	55, 255
Supplemental Restraint System (SRS) indicator lamp	38, 257
Engine malfunction indicator lamp, USA only	263
Combination low tire pressure/TPMS malfunction telltale, USA only	190, 265
Low tire pressure telltale, Canada only	190, 265

Function	Page
ESP® OFF warning lamp, SL 63 AMG only	58, 261
⑥ Right multifunction display with:	
Trip odometer	113
Transmission position indicator	104
Gear range indicator	106
Transmission program mode indicator	106
⑦ Fuel gauge with:	
Fuel tank reserve warning lamp (the arrow indicates that the fuel filler flap is on the right-hand side)	262

Center console

Upper part

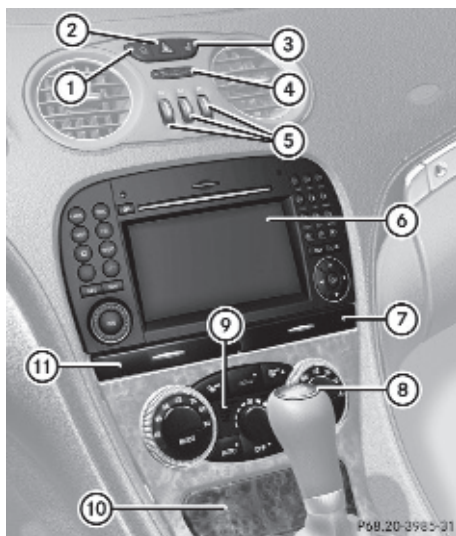

	Function	Page
①	Central locking switch Alarm system indicator lamp	73 63
②	Hazard warning flasher switch	92
③	Central unlocking switch	73
④	Passenger front air bag off indicator lamp	43, 266
⑤	Center and side air vent adjustment	151
⑥	COMAND system, see separate operating instructions	
⑦	Cup holder	164
⑧	KEYLESS-GO start/stop button	79
⑨	Automatic climate control panel	148

	Function	Page
⑩	Ashtray Cigarette lighter	166 166
⑪	Cup holder	164

Lower part

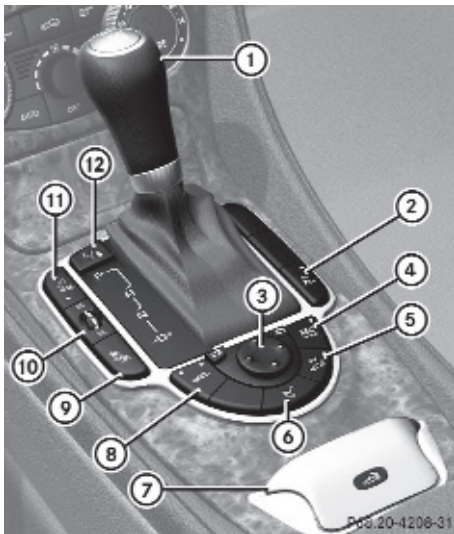

	Function	Page
⑩	Thumbwheel for setting following distance for DISTRONIC ⁶	133, 138
⑪	Distance warning function switch ⁶	133, 141
⑫	Program mode selector switch ⁶	106

	Function	Page
①	Gear selector lever	103
②	Parktronic system deactivation switch	147
③	Exterior rear view mirror adjustment	86
④	ABC suspension tuning button	143
⑤	Tow-away alarm switch	64
⑥	Power-folding exterior rear view mirrors, Canada only	88
⑦	Retractable hardtop switch	155
	Roll bar buttons	51
⑧	ABC vehicle level control button	142
⑨	Electronic Stability Program (ESP [®]) switch ⁶	56

⁶ Layout in SL 63 AMG differs.

Overhead control panel

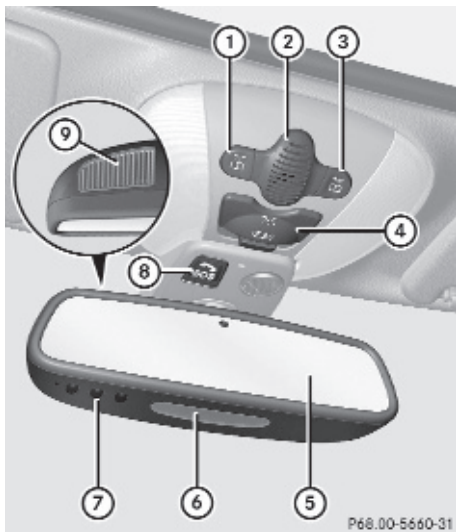

P68.00-5660-31

	Function	Page
①	Left reading lamp switch	94
②	Temperature sensor for automatic climate control	
③	Right reading lamp switch	94
④	Automatic interior lighting control	94
⑤	Interior rear view mirror	86
⑥	Reading lamp	94
⑦	Garage door opener	172
⑧	SOS button (Tele Aid system)	168
⑨	Hands-free microphone for Tele Aid (emergency call system) and telephone	167

Door control panel

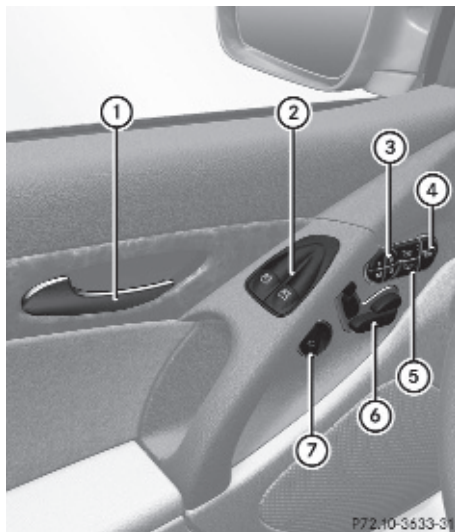

P72.10-3633-31

	Function	Page
①	Inside door handle	72
②	Power window switch	96
③	Memory function	88
④	AIRSCARF switch	84
⑤	Seat heating switch	83
	Seat ventilation switch	82
⑥	Seat adjustment switch	81
⑦	Remote trunk opening switch	74
	Remote trunk opening/closing switch	74, 75

Vehicle equipment	38
Occupant safety	38
Panic alarm	54
Driving safety systems	54
Anti-theft systems	63



Vehicle equipment

- i** This Operator's Manual describes all features, standard or optional, potentially available for your vehicle at the time of purchase. Please be aware that your vehicle might not be equipped with all features described in this manual.

Occupant safety

Introduction

In this section you will learn the most important facts about the restraint system components of the vehicle.

The restraint systems are:

- Seat belts
- Child restraints

Additional protection potential is provided by:

- Supplemental Restraint System (SRS) with
 - Air bags
 - Air bag control unit (with crash sensors)
 - Emergency Intensioning Device (ETD) for seat belts
 - Seat belt force limiter
- Roll bar
- Air bag system components with
 - Passenger front air bag off indicator lamp
 - Passenger seat with Occupant Classification System (OCS)

Although the systems are independent, their protective functions work in conjunction with each other.

Warning!

Modifications to or work improperly conducted on restraint system components or their wiring, as well as tampering with interconnected electronic systems, can lead to the restraint systems no longer functioning as intended.

Air bags or Emergency Tensioning Devices (ETDs), for example, could deploy inadvertently or fail to deploy in accidents although the deceleration threshold for air bag deployment is exceeded. Therefore, never modify the restraint systems. Do not tamper with electronic components or their software.

- i** See "Children in the vehicle" (▷ page 51) for information on
- infants and children traveling with you in the vehicle
 - restraint systems for infants and children

SRS indicator lamp

The SRS system conducts a self-test when the ignition is switched on and in regular intervals while the engine is running. This facilitates detection of system malfunctions.

The SRS indicator lamp **SRS** in the instrument cluster comes on when the ignition is switched on. It goes out no later than a few seconds after the engine has been started.

The SRS components are in operational readiness when the SRS indicator lamp **SRS** is not lit while the engine is running.

Warning!

The SRS self-check has detected a malfunction when the SRS indicator lamp **SRS**

- does not come on at all
- fails to go out after approximately 4 seconds after the engine was started
- comes on after the engine was started or while driving

For your safety, we strongly recommend that you contact an authorized Mercedes-Benz Center immediately to have the system checked. Otherwise the SRS may not be activated when needed in an accident, which

could result in serious or fatal injury. The SRS might also deploy unexpectedly and unnecessarily which could also result in injury as well.

In addition, improper work on the SRS creates a risk of rendering the SRS inoperative or causing unintended air bag deployment. Work on the SRS must therefore only be performed by qualified technicians. Contact an authorized Mercedes-Benz Center.

If it is necessary to modify an air bag system to accommodate a person with disabilities, contact an authorized Mercedes-Benz Center. USA only: Call our Customer Assistance Center at 1-800-FOR-MERCEdes (1-800-367-6372) for details.

Air bags

Warning!

Air bags are designed to reduce the potential of injury and fatality in certain

- frontal impacts (front air bags and driver's side knee bag)
- side impacts (head-thorax air bags)

However, no system available today can completely eliminate injuries and fatalities.

Deployment of the air bags temporarily releases a small amount of dust from the air bags. This dust, however, is neither harmful to your health, nor does it indicate a fire in the vehicle. The dust might cause some temporary breathing difficulty for people with asthma or other breathing trouble. To avoid this, you may wish to get out of the vehicle as soon as it is safe to do so. If you have any breathing difficulty but cannot get out of the vehicle after the air bag inflates, then get fresh air by opening a window or door.

Warning!

To reduce the risk of injury when the front air bags inflate, it is very important for the driver

and passenger to always be in a properly seated position and to wear their seat belts.

For maximum protection in the event of a collision always be in normal seated position with your back against the seat backrest. Fasten your seat belt and make sure it is properly positioned on your body.

Since the air bag inflates with considerable speed and force, a proper seating position and correct positioning of the hands on the steering wheel will help to keep you at a safe distance from the air bag. Occupants who are not wearing their seat belt, are not seated properly or are too close to the air bag can be seriously injured or killed by an air bag as it inflates with great force instantaneously:

- Sit with the seat belt properly fastened in a position that is as upright as possible with your back against the seat backrest.
- Move the driver's seat as far back as possible, still permitting proper operation of vehicle controls. The distance from the center of the driver's chest to the center of the air bag cover on the steering wheel must be at least 10 inches (25 cm) or more. You should be able to accomplish this by adjusting the seat and steering wheel. If you have any difficulties, please contact an authorized Mercedes-Benz Center.
- Do not lean your head or chest close to the steering wheel or dashboard.
- Keep hands on the outside of the steering wheel rim. Placing hands and arms inside the rim can increase the risk and potential severity of hand/arm injury when the driver front air bag inflates.
- Adjust the passenger seat as far as possible rearward from the dashboard when the seat is occupied.
- Occupants, especially children, should never place their bodies or lean their heads in the area of the door where the head-thorax air bag inflates. This could result in serious injuries or death should the head-

thorax air bag be deployed. Always sit as upright as possible, wear the seat belt properly and use an appropriately sized infant restraint, toddler restraint, or booster seat recommended for the size and weight of the child.

Failure to follow these instructions can result in severe injuries to you or other occupants. If you sell your vehicle, it is important that you make the buyer aware of this safety information. Be sure to give the buyer this Operator's Manual.

Warning!

There is a possibility of a head-thorax air bag-related injury if occupants, especially children, are not properly seated or restrained when next to a head-thorax air bag which needs to deploy rapidly in a side impact in order to do its job.

To help avoid the possibility of injury, please follow these guidelines:

- (1) Occupants, especially children, should never place their bodies or lean their heads in the area of the door where the head-thorax air bag inflates. This could result in serious injuries or death should the head-thorax air bag be deployed.
- (2) Always sit as upright as possible, wear the seat belt properly, and for children 12 years old and under, use an appropriately sized infant restraint, toddler restraint, or booster seat recommended for the size and weight of the child.
- (3) Always wear seat belts properly.

If you believe that, even with the use of these guidelines, it would be safer for your passenger seat occupants to have the passenger side head-thorax air bag deactivated, then deactivation can be carried out upon your written request at an

authorized Mercedes-Benz Center at an additional cost.

Please contact an authorized Mercedes-Benz Center or call the Customer Assistance Center (in the USA) at 1-800-FOR-MERCEDES (1-800-367-6372), or Customer Service (in Canada) at 1-800-387-0100 for details.

Air bags are designed to deploy only in certain frontal impacts (front air bags and driver's side knee bag) and in side impacts (head-thorax air bags) if the system determines the need for air bag deployment. Only in the event of such a situation will they provide their supplemental protection.

The driver and passenger should always wear their seat belts. Otherwise it is not possible for the air bags to provide their supplemental protection.

In case of other types of impacts and impacts below air bag deployment thresholds, air bags will not deploy. The driver and passenger will then be protected to the extent possible by a properly fastened seat belt. A properly fastened seat belt is also needed to provide the best possible protection in a rollover.

Air bags are not a substitute for seat belts. Always wear your seat belt, regardless of whether or not your vehicle is equipped with air bags.

It is important to your safety and that of your passenger to have deployed air bags replaced and to have any malfunctioning air bags repaired. This will help to make sure the air bags will continue to provide supplemental crash protection for occupants.

Safety guidelines for the seat belt, Emergency Tensioning Device (ETD) and air bag

Warning!

- Damaged seat belts or seat belts that have been subjected to stress in an accident must be replaced. Their anchoring points must also be checked. Only use seat belts

installed or supplied by an authorized Mercedes-Benz Center.

- Air bags and pyrotechnic Emergency Tensioning Devices (ETDs) contain perchlorate material, which may require special handling and regard for the environment. Check with your local government's disposal guidelines. California residents, see www.dtsc.ca.gov/HazardousWaste/Perchlorate/index.cfm.
- Air bags and ETDs are designed to function on a one-time-only basis. An air bag or ETD that has deployed must be replaced.
- Do not pass seat belts over sharp edges. They could tear.
- Do not make any modification that could change the effectiveness of the seat belts.
- Do not bleach or dye seat belts as this may severely weaken them. In a crash they may not be able to provide adequate protection.
- No modifications of any kind may be made to any components or wiring of the SRS.
- Do no change or remove any component or part of the SRS.
- Do not install additional trim material, seat covers, badges, etc. over the steering wheel hub, passenger front air bag cover, outboard sides of the seat backrests, door trim panels, or door frame trims.
- Do not install additional electrical/ electronic equipment on or near SRS components and wiring.
- Keep area between air bags and occupants free of objects (e.g. packages, purses, umbrellas, etc.).
- Air bag system components will be hot after an air bag has inflated. Do not touch them.
- Never place your feet on the instrument panel, dashboard, or on the seat. Always keep both feet on the floor in front of the seat.

- Improper repair work on the SRS creates a risk of rendering the SRS inoperative or causing unintended air bag deployment. Work on the SRS must therefore only be performed by qualified technicians. Contact an authorized Mercedes-Benz Center.
- For your protection and the protection of others, when scrapping the air bag unit or ETD, our safety instructions must be followed. These instructions are available from any authorized Mercedes-Benz Center.
- Given the considerable deployment speed, required inflation volume, and the material of the air bags, there is the possibility of abrasions or other, potentially more serious injuries resulting from air bag deployment.

If you sell your vehicle, we strongly recommend that you inform the subsequent owner that the vehicle is equipped with SRS. Also refer them to the applicable section in the Operator's Manual.

Front air bags

 **Observe Safety notes, see page 39.**

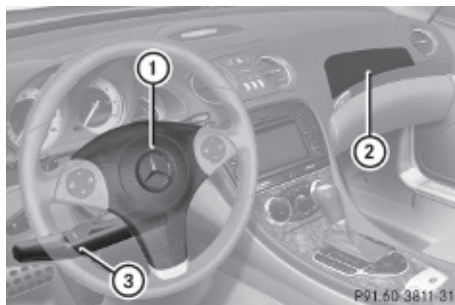

Driver's front air bag ① and passenger front air bag ② are designed to provide increased protection for the driver and passenger against the risk of injuries to the head and thorax.

Driver and passenger front air bag and driver's side knee bag are deployed

- in the event of certain frontal impacts
- if the system determines that air bag deployment can offer additional protection to that provided by the seat belt
- depending on whether the respective seat belt is in use
- independently of the head-thorax air bags

The front air bags in this vehicle have been designed to inflate in two stages. This allows the air bags to have different rates of inflation. The rate of inflation is based on the vehicle deceleration rate as assessed by the air bag control unit.

The passenger front air bag deployment is additionally influenced by the passenger's weight category as identified by the Occupant Classification System (OCS) (▷ page 43).

The lighter the passenger-side occupant, the higher the vehicle deceleration rate required for second stage inflation of the passenger front air bag.

The air bags will not deploy in impacts which do not exceed the system's preset deployment thresholds. You will then be protected by the fastened seat belts.

The front air bags will not deploy in the event of a rollover unless the vehicle's rate of longitudinal deceleration or acceleration exceeds the preset deployment threshold for the front air bags.

The passenger air bag will only be deployed if

- the system, based on OCS weight sensor readings, detects that the passenger seat is occupied
- the  indicator lamp in the center console is not lit (▷ page 43)
- the impact exceeds a preset deployment threshold

Knee bag

Knee bag ③ is designed to provide increased protection for the driver against the risk of injuries to the knees, thighs and lower legs.

Knee bag ③ is located on the driver side lower instrument panel. It is designed to operate together with the driver front air bag in certain frontal impacts if the system determines that air bag deployment can offer additional protection to that provided by the seat belt. Knee bag ③ operates best in conjunction with a properly positioned and fastened seat belt.

Head-thorax air bags

 **Observe Safety notes, see page 39.**

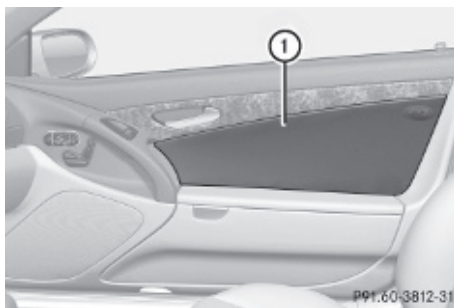

Head-thorax air bags ① are designed to provide increased protection for the head and thorax but not for the arms.

Head-thorax air bags ① are deployed

- on the impacted side of the vehicle
- in instances with a high rate of lateral vehicle deceleration or acceleration
- if the system determines that air bag deployment can offer additional protection to that provided by the seat belt
- depending on whether the seat belt is in use
- independently of the front air bags
- independently of the ETDs

The passenger head-thorax air bag ① will only deploy if the OCS senses that the

passenger seat is occupied and the impact exceeds a preset deployment threshold.

Head-thorax air bags ① are not deployed in side impacts which do not exceed the system's deployment threshold.

Occupant Classification System

The Occupant Classification System (OCS) activates or deactivates the passenger front air bag automatically. The respective status is based on the classified occupant weight category determined by weight sensor readings from the passenger seat.

The system does not deactivate the passenger head-thorax air bag and the Emergency Tensioning Devices (ETDs).

To be classified correctly, the passenger must sit

- with the seat belt properly fastened
- in a position that is as upright as possible with the back against the seat backrest
- with the feet on the floor

If the occupant's weight is transferred to another object in the vehicle (e.g. by leaning on armrests), the OCS may not be able to properly approximate the occupant's weight category.

If your seat, including the trim cover and cushion, needs to be serviced in any way, take the vehicle to an authorized Mercedes-Benz Center.

Only seat accessories approved by Mercedes-Benz may be used.

Both the driver and the passenger should always use the  indicator lamp as an indication of whether or not the passenger is properly positioned.

Warning!



If the  indicator lamp illuminates when an adult or someone larger than a small individual is in the passenger seat, have the passenger reposition himself or herself in the

seat until the  indicator lamp goes out.



In the event of a collision, the air bag control unit will not allow passenger front air bag deployment when the OCS has classified the passenger seat occupant as weighting as much as or less than a typical 12-month-old child in a standard child restraint or if the passenger seat is classified as being empty. When the OCS senses that the passenger seat occupant is classified as being up to or less than the weight of a typical 12-month-old child in a standard child restraint, the



 indicator lamp will illuminate when the engine is started and remain illuminated, indicating that the passenger front air bag is deactivated.

When the OCS senses that the passenger seat is classified as being empty, the  indicator lamp will illuminate when the engine is started and remain illuminated, indicating that the passenger front air bag is deactivated.

When the OCS senses that the passenger seat occupant is classified as being heavier than the weight of a typical 12-month-old child seated in a standard child restraint or as being a small individual (such as a young teenager or a small adult), the  indicator lamp will illuminate for approximately 6 seconds when the engine is started and then, depending on occupant weight sensor readings from the seat, remain illuminated or go out. With the  indicator lamp illuminated, the passenger front air bag is deactivated. With the  indicator lamp out, the passenger front air bag is activated.

When the OCS senses that the passenger seat occupant is classified as an adult or someone larger than a small individual, the  indicator lamp will illuminate for approximately 6 seconds when the engine is started and then goes out, indicating that the passenger front air bag is activated.

If the   indicator lamp is illuminated, the passenger front air bag is deactivated and will not be deployed.

If the   indicator lamp is not illuminated, the passenger front air bag is activated and will be deployed

- in the event of certain frontal impacts
- if impact exceeds a preset deployment threshold
- independently of the head-thorax air bag

If the passenger front air bag is deployed, the rate of inflation will be influenced by

- the rate of relevant vehicle deceleration as assessed by the air bag control unit
- the passenger's weight category as identified by the OCS

For more information on air bag display messages in the multifunction display, see (▷ page 229).

Warning!

Children 12 years old and under must be seated and properly secured in an appropriate infant restraint, toddler restraint, or booster seat recommended for the size and weight of the child.

The infant or child restraint must be properly secured with the vehicle's seat belt fully in accordance with the child seat manufacturer's instructions.

Occupants, especially children, should always sit as upright as possible, wear the seat belt properly and use an appropriately sized infant restraint, toddler restraint, or booster seat recommended for the size and weight of the child.



Children can be killed or seriously injured by an inflating air bag. Note the following important information:



- Your vehicle is equipped with air bag technology designed to deactivate the passenger front air bag in your vehicle when the system senses the weight of a

typical 12-month-old child or less along with the weight of a standard appropriate child restraint on the passenger seat.





- A child in a rear-facing child restraint on the passenger seat will be seriously injured or even killed if the passenger front air bag inflates in a collision which could occur under some circumstances, even with the air bag technology installed in your vehicle.

- If you install a rear-facing child restraint on the passenger seat, make sure the

  indicator lamp is illuminated, indicating that the passenger front air bag is deactivated.

Should the   indicator lamp not illuminate or go out while the restraint is installed, please check installation. Periodically check the

  indicator lamp while driving to make sure the

  indicator lamp is illuminated. If the   indicator lamp goes out or remains out, do not transport a child on the passenger seat until the system has been repaired.

A child in a rear-facing child restraint on the passenger seat will be seriously injured or even killed if the passenger front air bag inflates.

- If you place a child in a forward-facing child restraint on the passenger seat, move the seat as far back as possible, use the proper child restraint recommended for the age, size and weight of the child, and secure child restraint with the vehicle's seat belt according to the child seat manufacturer's instructions. For children larger than the typical 12-month-old child, the passenger front air bag may or may not be activated.

Deployment of the driver front air bag does not mean that the passenger front air bag also should have deployed.



The OCS may have determined

- that the seat was empty or occupied by the weight up to or less than that of a typical 12-month-old child seated in a standard



child restraint – both of which are instances where the system suppresses deployment of the passenger front air bag even though the impact met the criteria and was of sufficient severity to deploy the driver front air bag

- that the seat was occupied by a small individual (such as a young teenager or a small adult) or a child who weighs more than the weight of a typical 12-month-old child in a standard child restraint – both of which are instances where the system may suppress deployment of the passenger front air bag even though the impact met the criteria and was of sufficient severity to deploy the driver front air bag



   indicator lamp ① will be illuminated, except with the SmartKey removed from the starter switch or with the starter switch in position **0**.





Warning!



If the red SRS indicator lamp  in the instrument cluster and the   indicator lamp are lit at the same time, there is a malfunction in the OCS. The passenger front air bag will be deactivated in this case. Have the system checked by qualified technicians as soon as possible. Contact an authorized Mercedes-Benz Center. Only have the seat repaired or replaced at an authorized Mercedes-Benz Center.

In order to ensure proper operation of the air bag system and OCS:



- Sit with the seat belt properly fastened in a position that is as upright as possible with your back against the seat backrest.
- While seated, an occupant should not position him/herself in such a way as to cause the occupant's weight to be lifted from the seat bottom as this may result in the OCS being unable to correctly approximate the occupant's weight category.
- Read and observe all warnings in this chapter.

OCS Self-test

After turning the SmartKey in the starter switch to position **1** or **2** or pressing the KEYLESS-GO start/stop button once or twice, the   indicator lamp illuminates. If an adult occupant is properly sitting on the passenger seat and the system classifies the occupant as an adult, the   indicator lamp will illuminate and go out after approximately 6 seconds.

If the seat is not occupied and the system classifies the passenger seat as being empty, the   indicator lamp will illuminate and not go out.

Warning!

If the   indicator lamp does not illuminate, the system is not functioning. You must contact an authorized Mercedes-Benz Center before seating any child on the passenger seat.

For more information, see the “Practical hints” section (▷ page 266).

Warning!

Never place anything between seat cushion and child seat (e.g. pillow), since it reduces the effectiveness of the OCS. The bottom and back of the child seat must make full contact

with the passenger seat cushion and backrest.

If necessary, adjust the tilt of the passenger seat backrest.

An incorrectly mounted child seat could cause injuries to the child in case of an accident, instead of increasing protection for the child.

Follow the manufacturer's instructions for installation of child seats.

Seat belts

Safety notes

The use of seat belts and infant and child restraint systems is required by law in all 50 states, the District of Columbia, the U.S. territories and all Canadian provinces.

Even where this is not the case, all vehicle occupants should have their seat belts fastened whenever the vehicle is in motion.

- i** See "Children in the vehicle" (▷ page 51) for information on
 - infants and children traveling with you in the vehicle
 - restraint systems for infants and children

Warning!

Always fasten your seat belt before driving off. Always make sure your passenger is properly restrained. You and your passenger should always wear seat belts.

Failure to wear and properly fasten and position your seat belt greatly increases your risk of injuries and their likely severity in an accident.

If you are ever in an accident, your injuries can be considerably more severe without your seat belt properly buckled. Without your seat belt buckled, you are much more likely to hit the interior of the vehicle or be ejected from it. You can be seriously injured or killed.

In the same crash, the possibility of injury or death is lessened if you are properly wearing

your seat belt. The air bags can only protect as intended if the occupants are properly wearing their seat belts.

Warning!

Never ride in a moving vehicle with the seat backrest in an excessively reclined position as this can be dangerous. You could slide under the seat belt in a collision. If you slide under it, the seat belt would apply force at the abdomen or neck. That could cause serious or even fatal injuries. The seat backrest and seat belt provide the best restraint when the wearer is in a position that is as upright as possible and the seat belt is properly positioned on the body.

Warning!

Never let more people ride in the vehicle than there are seat belts available. Make sure everyone riding in the vehicle is correctly restrained with a separate seat belt. Never use a seat belt for more than one person at a time.

Warning!

Keep the door storage compartments closed while vehicle is in motion. Failure to do so may cause the seat belt to catch at the rear and prevent proper positioning of the seat belt.

Warning!

Damaged seat belts or seat belts that have been subjected to stress in an accident must be replaced. Also, the seat belt anchoring points must be checked.

Only use seat belts which have been approved by Mercedes-Benz.

Do not make any modifications to the seat belts. This can lead to unintended activation of the ETDs or to their failure to activate when necessary.

Do not bleach or dye seat belts as this may severely weaken them. In a crash they may not be able to provide adequate protection.

Have all work carried out only by qualified technicians. Contact an authorized Mercedes-Benz Center.

Proper use of seat belts

Warning!

USE SEAT BELTS PROPERLY

- Seat belts can only protect when used properly. Never wear seat belts in any other way than as described in this section, as that could result in serious injuries in case of an accident.
- Each occupant should wear their seat belt at all times, because seat belts help reduce the likelihood of and potential severity of injuries in accidents, including rollovers. The integrated restraint system includes SRS (driver front air bag, driver side knee bag, passenger front air bag, head-thorax air bags), Emergency Tensioning Devices (ETDs) and seat belt force limiters. The system is designed to enhance the protection offered to properly belted occupants in certain frontal (front air bags, driver's side knee bag and ETDs) and side (head-thorax air bags and ETDs) impacts which exceed preset deployment thresholds.
- Never wear the shoulder belt under your arm, against your neck or off your shoulder. In a frontal crash, your body would move too far forward. That would increase the chance of head and neck injuries. The seat belt would also apply too much force to the ribs or abdomen, which could severely injure internal organs such as your liver or spleen. Adjust the seat belt so that the shoulder section is located as close as possible to the middle of the shoulder. It should not touch the neck. Never pass the shoulder portion of the seat belt under your arm.
- Position the lap belt as low as possible on your hips and not across the abdomen. If

the lap belt is positioned across your abdomen, it could cause serious injuries in a crash.

- Never wear seat belts over rigid or breakable objects in or on your clothing, such as eyeglasses, pens, keys etc., as these might cause injuries.
- Make sure the seat belt is always fitted snugly. Take special care of this when wearing loose clothing.
- Never use a seat belt for more than one person at a time. Do not fasten a seat belt around a person and another person or other objects at the same time.
- Seat belts should not be worn twisted. In a crash, you would not have the full width of the seat belt to distribute impact forces. The twisted seat belt against your body could cause injuries.
- Pregnant women should also always use a lap/shoulder belt. The lap belt portion should be positioned as low as possible on the hips to avoid any possible pressure on the abdomen.
- Place the seat backrest in a position that is as upright as possible.
- Check your seat belt during travel to make sure it is properly positioned.
- Never place your feet on the instrument panel, dashboard, or on the seat. Always keep both feet on the floor in front of the seat.
- When using a seat belt to secure infant restraints, toddler restraints, or children in booster seats, always follow the child seat manufacturer's instructions.

Warning!

Do not pass seat belts over sharp edges. They could tear.

Do not allow the seat belt to get caught in the door or in the seat adjustment mechanism. This could damage the seat belt.

Never attempt to make modifications to seat belts. This could impair the effectiveness of the seat belts.

Fastening the seat belts

Warning!

Children 12 years old and under must be seated and properly secured in an appropriately sized infant restraint, toddler restraint, or booster seat recommended for the size and weight of the child. For additional information, see section “Children in the vehicle”.

A child’s risk of serious or fatal injuries is significantly increased if the child restraints are not properly secured in the vehicle and/or the child is not properly secured in the child restraint.

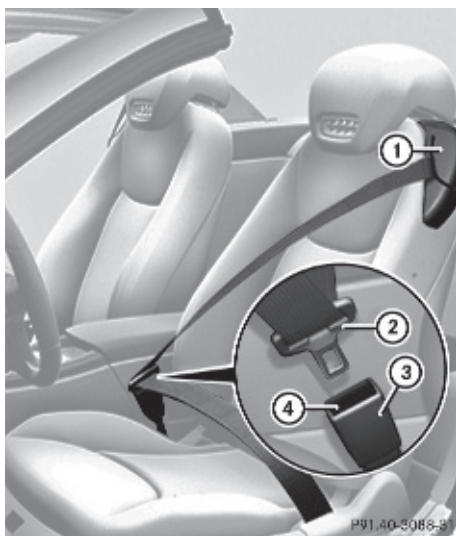

- ▶ With a smooth motion, pull the seat belt out of seat belt housing ①.
- ▶ Place the shoulder portion of the seat belt across the top of your shoulder and the lap portion across your hips.

- ▶ Push latch plate ② into buckle ③ until it clicks.
- ▶ If necessary, tighten the lap portion to a snug fit by pulling shoulder portion up.

The passenger lap/shoulder belt has a special seat belt retractor to secure child restraints properly. For more information on special seat belt retractors, see “Infant and child restraint systems” (▷ page 52).

To release the seat belt with seat belt release button ④, see (▷ page 48).

Releasing the seat belts

- ▶ Press seat belt release button ④ (▷ page 48).
Allow the retractor to completely rewind the seat belt by guiding latch plate ② (▷ page 48).

! Make sure the seat belt retracts completely. Otherwise the seat belt and/or latch plate could get caught or pinched in the door or in the seat mechanism. This can damage the seat belt and impair its effectiveness, and/or cause damage to the door and/or door trim panel. Such damage is not covered by the Mercedes-Benz Limited Warranty.



Damaged seat belts must be replaced. Contact an authorized Mercedes-Benz Center.

Enhanced seat belt reminder system

When the engine is started, the seat belt telltale  will always illuminate for 6 seconds to remind you and your passenger to fasten your seat belts.

If the driver’s seat belt is not fastened when the engine is started, an additional warning chime will sound. The warning chime goes out after approximately 6 seconds or once the driver’s seat belt is fastened.

If after these 6 seconds the driver's or the passenger's seat belt (with the passenger seat occupied) is not fastened with both doors closed,

- the seat belt telltale  remains illuminated for as long as either the driver's or passenger's seat belt is not fastened.
- and if the vehicle speed once exceeds 15 mph (25 km/h), the seat belt telltale  starts flashing and a warning chime sounds with increasing intensity for a maximum of 60 seconds or until the driver's and passenger's seat belt are fastened.

If you and/or your passenger release the seat belt during driving, the seat belt telltale  starts flashing and the warning chime sounds as described before.

If the driver's or the passenger's seat belt remains unfastened after 60 seconds, the warning chime stops sounding, the seat belt telltale  stops flashing but continues to be illuminated.

After a vehicle standstill, the warning chime is reactivated and the seat belt telltale  is flashing again if the vehicle speed once exceeds 15 mph (25 km/h).

The seat belt telltale  will only go out if both the driver's and the passenger's seat belt (with the passenger seat occupied) are fastened, or the vehicle is standing still and a door is opened.

For more information, see "Practical hints" (▷ page 256).

Emergency Tensioning Device (ETD), seat belt force limiter

The seat belts are equipped with ETDs and seat belt force limiters.

The ETDs are designed to activate in the following cases:

- in frontal or rear-end impacts exceeding the system's preset deployment threshold
- if the restraint systems are operational and functioning correctly, see "SRS indicator lamp" (▷ page 38)
- in certain vehicle rollovers if the system determines an additional degree of protection

The ETDs will only activate if the seat belts are fastened (latch plate properly inserted into buckle).

In an impact, the ETDs remove slack from the seat belts in such a way that the seat belts fit more snugly against the body. Seat belt force limiters, when activated, are employed to help reduce the peak force exerted by the seat belts on occupants during a crash.

-  The ETDs do not correct an incorrect seat position or incorrectly worn seat belts. The ETDs do not pull occupants back toward the seat backrest.

Warning!

Pyrotechnic ETDs that were activated must be replaced.

For your safety, when disposing of the pyrotechnic ETDs always follow our safety instructions. These are available at any authorized Mercedes-Benz Center.

Automatic comfort-fit feature seat belt

The automatic comfort-fit feature reduces the retracting force of the seat belts when they are in normal use.

Correct driver seat adjustment

Warning!

In order to avoid possible loss of vehicle control the following must be done before the vehicle is put into motion:

- seat adjustment
- head restraint adjustment
- steering wheel adjustment
- rear view mirror adjustment
- fastening of seat belts

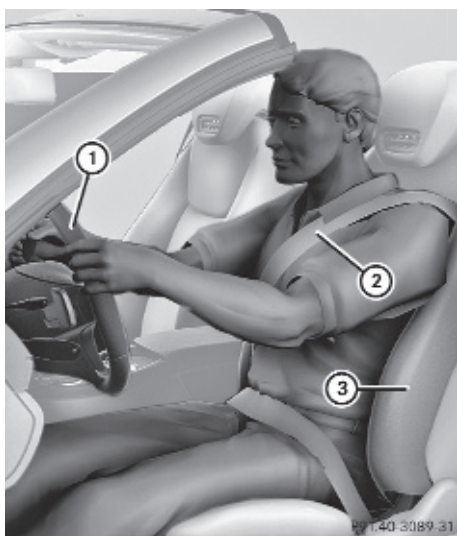

Steering wheel

Observe Safety notes, see page 84.

- Position steering wheel ① properly (> page 85).

Make sure:

- You can reach the steering wheel with your arms slightly bent at the elbows.
- You can move your legs freely.
- All displays (including malfunction and indicator lamps) on the instrument cluster are clearly visible.

Seat belt

Observe Safety notes, see page 46.

- Fasten and position your seat belt ② correctly (> page 48).

Make sure:

- The seat belt is always fitted snugly.
- Adjust the seat belt so that the shoulder section is located as close as possible to the middle of the shoulder.
- Place the lap portion of the seat belt as low as possible on your hips.

Seat and head restraint

Observe Safety notes, see page 80.

- Position seat ③ and head restraint properly. See (> page 81) for seat and head restraint adjustment.

Observe the following points:

- Always be in a properly seated position.
- The position should be as far rearward from the front air bag in the steering wheel as possible, while still permitting proper operation of vehicle controls.
- Adjust the seat to a comfortable seating position that still allows you to reach the accelerator/brake pedal safely.
- The seat must be adjusted so that you can correctly fasten and position your seat belt.
- The seat backrest must be in a position that is as nearly upright as possible.
- Adjust the seat cushion so that the front edge of the seat cushion lightly supports your legs.
- Adjust the head restraint so that it is as close to the head as possible and the center of the head restraint supports the back of the head at eye level.
- Never place hands under the seat or near any moving parts while the seat is being adjusted.

Roll bar

Warning!

This vehicle is a two occupant vehicle. The rear storage area is not equipped to properly seat or restrain occupants and therefore is not permitted for use by any persons.

Make sure that the roll bar's path of motion is clear and no persons are injured by the moving roll bar. Raising or lowering of the roll bar could injure someone in its proximity.

For your own safety, we recommend to drive with the roll bar raised if the outside temperature is below +5°F (-15°C).

- !** If the outside temperature falls below +5°F (-15°C), the roll bar must be raised manually using the buttons provided to avoid damaging the hydraulics.

The roll bar raises automatically in an accident or in a critical driving situation.

- i** When the roll bar is raised automatically, you will hear a ratcheting sound.

You can also raise and lower the roll bar manually using the buttons provided.

The buttons for the roll bar are on the center console under the retractable hardtop switch.

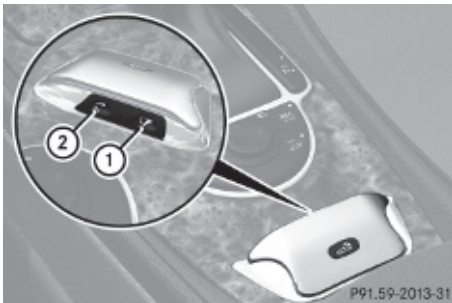

The roll bar can be moved manually when the ignition is switched on.

Warning!

If the yellow roll bar warning lamp  in the instrument cluster does not go out after starting the engine, or if it comes on while

driving, the roll bar system is not operating properly and may not activate in an accident. At the same time, the message **Raise Roll-over Bar** appears in the multifunction display. In this case, raise the roll bar manually before continuing to drive.

For safety reasons, drive only with the roll bar raised until the malfunction is repaired. Have your vehicle checked at an authorized Mercedes-Benz Center.

- ▶ **Raising:** Lift the switch for the retractable hardtop.
- ▶ Press and hold button **①** until the roll bar is raised.

- ▶ **Lowering:** Lift the switch for the retractable hardtop.

If the roll bar was raised manually:

- ▶ Press and hold button **②** until the roll bar is lowered.

If the roll bar was raised automatically:

- ▶ Press and hold button **①** until you hear the roll bar lock into place.
- ▶ Press and hold button **②** until the roll bar is lowered.

- i** If you have raised the roll bar manually using the button, the roll bar will automatically be lowered and then raised again when you close and open the retractable hardtop.

Children in the vehicle

Safety notes

If an infant or child is traveling with you in the vehicle:

- ▶ Secure the child using an infant or child restraint appropriate to the age and size of the child.
- ▶ Make sure the infant or child is properly secured at all times while the vehicle is in motion.

⚠ Warning!

When leaving the vehicle, always remove the SmartKey from the starter switch. Always take the SmartKey with you and lock the vehicle. Do not leave children unattended in the vehicle, even if they are secured in a child restraint system, or with access to an unlocked vehicle. A child's unsupervised access to a vehicle could result in an accident and/or serious personal injury. The children could

- injure themselves on parts of the vehicle
- be seriously or fatally injured through excessive exposure to extreme heat or cold
- injure themselves or cause an accident with vehicle equipment that can be operated even if the SmartKey is removed from the starter switch or removed from the vehicle, such as seat adjustment, steering wheel adjustment, or the memory function

If children open a door, they could injure other persons or get out of the vehicle and injure themselves or be injured by following traffic.

Do not expose the child restraint system to direct sunlight. The child restraint system's metal parts, for example, could become very hot, and the child could be burned by these parts.

⚠ Warning!

Do not carry heavy or hard objects in the passenger compartment unless they are firmly secured in place.

Unsecured or improperly positioned cargo increases a child's risk of injury in the event of

- strong braking maneuvers
- sudden changes of direction
- an accident

Infant and child restraint systems**⚠ Observe Safety notes, see page 51.**

We recommend all infants and children be properly restrained at all times while the vehicle is in motion.

The passenger lap/shoulder belt has a special seat belt retractor for secure fastening of child restraints.

To fasten a child restraint, follow the child restraint manufacturer's instructions for mounting.

To activate the special seat belt retractor:

- ▶ Pull the shoulder belt out completely and let it retract.

During seat belt retraction, a ratcheting sound can be heard to indicate that the special seat belt retractor is activated. The seat belt is now locked.

- ▶ Push down on child restraint to take up any slack.

To deactivate the special seat belt retractor:

- ▶ Release the seat belt buckle and let the seat belt retract completely. The seat belt can then again be used in the usual manner.

⚠ Warning!

Never release the seat belt buckle while the vehicle is in motion, since the special seat belt retractor will be deactivated.

The use of infant or child restraints is required by law in all 50 states, the District of Columbia, the U.S. territories and all Canadian provinces.

Infants and small children should be seated in an appropriate infant or child restraint system. They must be properly secured by a lap/shoulder belt in accordance with the manufacturer's instructions for the child restraint. All infant or child restraint systems must comply with U.S. Federal Motor Vehicle Safety Standards 213 and 225 and Canadian Motor Vehicle Safety Standards 213 and 210.2.

A statement by the child restraint manufacturer of compliance with these standards can be found on the instruction label on the restraint and in the instruction manual provided with the restraint.

When using any infant restraint, toddler restraint, or booster seat, make sure to carefully read and follow all manufacturer's instructions for installation and use.

Please read and observe warning labels affixed to the inside of the vehicle and to infant or child restraints.

Warning!

Children 12 years old and under must be seated and properly secured in an appropriate infant restraint, toddler restraint, or booster seat recommended for the size and weight of the child.

The infant or child restraint must be properly secured with the vehicle's seat belt fully in accordance with the child seat manufacturer's instructions.

Occupants, especially children, should always sit as upright as possible, wear the seat belt properly and use an appropriately sized infant restraint, toddler restraint, or booster seat recommended for the size and weight of the child.

Children can be killed or seriously injured by an inflating air bag. Note the following important information:

- Your vehicle is equipped with air bag technology designed to deactivate the passenger front air bag in your vehicle when the system senses the weight of a typical 12-month-old child or less along with the weight of a standard appropriate child restraint on the passenger seat.
- A child in a rear-facing child restraint on the passenger seat will be seriously injured or even killed if the passenger front air bag inflates in a collision which could occur under some circumstances, even with the air bag technology installed in your vehicle.

- If you install a rear-facing child restraint on the passenger seat, make sure the





indicator lamp is illuminated, indicating that the passenger front air bag is deactivated. Should the



indicator lamp not illuminate or go out while the restraint is installed, please check installation. Periodically check the



indicator lamp while driving to make sure the  indicator lamp is illuminated. If the  indicator lamp goes out or remains out, do not transport a child on the passenger seat until the system has been repaired.

A child in a rear-facing child restraint on the passenger seat will be seriously injured or even killed if the passenger front air bag inflates.

- If you place a child in a forward-facing child restraint on the passenger seat, move the seat as far back as possible, use the proper child restraint recommended for the age, size and weight of the child, and secure child restraint with the vehicle's seat belt according to the child seat manufacturer's instructions. For children larger than the typical 12-month-old child, the passenger front air bag may or may not be activated.

Warning!

Infants and small children should never share a seat belt with another occupant. During an accident, they could be crushed between the occupant and seat belt.

A child's risk of serious or fatal injuries is significantly increased if the child restraints are not properly secured in the vehicle and/or the child is not properly secured in the child restraint.

Children too big for a toddler restraint must ride in seats using regular seat belts. Position shoulder belt across chest and shoulder, not face or neck. A booster seat may be necessary to achieve proper seat belt positioning for children over 41 lb (18 kg) until

they reach a height where a lap/shoulder belt fits properly without a booster.

When the child restraint is not in use, remove it from the vehicle or secure it with the seat belt to prevent the child restraint from becoming a projectile in the event of an accident.

Panic alarm



Example illustration: SmartKey with KEYLESS-GO

- ▶ **Activating:** Press and hold **PANIC** button ① for at least 1 second. An audible alarm and flashing exterior lamps will operate.
 - ▶ **Deactivating:** Press **PANIC** button ① again.
- or
- ▶ Insert the SmartKey into the starter switch.
 - ▶ Press the KEYLESS-GO start/stop button. The SmartKey with KEYLESS-GO must be inside the vehicle.

i USA only:
This device complies with Part 15 of the FCC Rules. Operation is subject to the following two conditions:

1. This device may not cause harmful interference, and
2. this device must accept any interference received, including

interference that may cause undesired operation.

Any unauthorized modification to this device could void the user's authority to operate the equipment.

i Canada only:

This device complies with RSS-210 of Industry Canada. Operation is subject to the following two conditions:

1. This device may not cause interference, and
2. this device must accept any interference received, including interference that may cause undesired operation of the device.

Any unauthorized modification to this device could void the user's authority to operate the equipment.

Driving safety systems

Introduction

This section contains information about the following driving safety systems:

- ABS (Antilock Brake System)
- BAS (Brake Assist System)
- ESP® (Electronic Stability Program)
- Electro-hydraulic brake system

i In winter operation, the maximum effectiveness of most of the driving systems described in this section is only achieved with winter tires, or snow chains as required.

Safety notes

Warning!

The following factors increase the risk of accidents:

- Excessive speed, especially in turns
- Wet and slippery road surfaces
- Following another vehicle too closely

The driving safety systems described in this section cannot reduce these risks or prevent the natural laws of physics from acting on the vehicle. They cannot increase braking or steering efficiency beyond that afforded by the condition of the vehicle brakes and tires or the traction afforded.

Only a safe, attentive, and skillful driver can prevent accidents.

The capabilities of a vehicle equipped with the driving safety systems described in this section must never be exploited in a reckless or dangerous manner which could jeopardize the user's safety or the safety of others.

Always adjust your driving style to the prevailing road and weather conditions and keep a safe distance to other road users and objects on the street.

If a driving system malfunctions, other driving safety systems may also switch off. Observe indicator and warning lamps that may come on as well as messages in the multifunction display that may appear.

ABS

 **Observe Safety notes, see page 55.**

Warning!

Do not pump the brake pedal. Use firm, steady brake pedal pressure instead. Pumping the brake pedal defeats the purpose of the ABS and significantly reduces braking effectiveness.



The Antilock Brake System (ABS) regulates the brake pressure so that the wheels do not lock during braking. This allows you to maintain the ability to steer your vehicle.

The ABS is functional above a speed of approximately 5 mph (8 km/h) independent of road surface conditions.

On slippery road surfaces, the ABS will respond even to light brake pressure.



The ABS indicator lamp  in the instrument cluster comes on when you switch on the ignition. It goes out when the engine is running.

Braking

If the ABS activates during braking, the ABS/ESP[®] warning lamp  or ⁷ in the instrument cluster flashes. Because of the electro-hydraulic brake system, you will not feel any pulsation in the brake pedal.

► Keep firm and steady pressure on the brake pedal.

Continuous, steady brake pedal pressure yields the advantages provided by the ABS, namely braking power and the ability to steer the vehicle.

The ABS/ESP[®] warning lamp  or ⁷ flashes whenever the ABS is activated. It can be an indication for hazardous road conditions and functions as a reminder to take extra care while driving.

Emergency brake maneuver

► Keep continuous full pressure on the brake pedal.

Warning!

If the ABS malfunctions, other driving safety systems such as the BAS or the ESP[®] are also switched off. Observe indicator and warning lamps that may come on as well as messages in the multifunction display that may appear.

⁷ Depending on vehicle production date.

If the ABS malfunctions, the wheels may lock during hard braking, reducing steering capability and extending the braking distance.

BAS

 **Observe Safety notes, see page 55.**

The Brake Assist System (BAS) operates in emergency situations. If you apply the brakes very quickly, the BAS provides full brake boost automatically, thereby potentially reducing the braking distance.

- ▶ Apply continuous full braking pressure until the emergency braking situation is over. The ABS will prevent the wheels from locking.

When you release the brake pedal, the brakes function again as normal. The BAS is then deactivated.

 **Warning!**

If the BAS malfunctions, the brake system still functions, but without the additional brake boost available that the BAS would normally provide in an emergency braking maneuver. Therefore, the braking distance may increase.



ESP®



 **Observe Safety notes, see page 55.**

The Electronic Stability Program (ESP®) is operational as soon as the engine is running. It monitors the vehicle's traction (force of adhesive friction between the tires and the road surface) and handling.



The ESP® recognizes that the vehicle deviates from the direction of travel as intended by the driver. By applying brakes to individual wheels and by limiting the engine output, the ESP® works to stabilize the vehicle. The ESP® is especially useful while driving off and on wet or slippery road surfaces. The ESP®

also stabilizes the vehicle during braking and steering maneuvers.

The ABS/ESP® warning lamp  or ⁸ in the instrument cluster comes on when you switch on the ignition. It goes out when the engine is running.

The ABS/ESP® warning lamp  or ⁸ in the instrument cluster flashes when the ESP® is engaged.

 **Warning!**

Never switch off the ESP® when you see the ABS/ESP® warning lamp  or ⁹ flashing in the instrument cluster. In this case proceed as follows:

- When driving off, apply as little throttle as possible.
- While driving, ease up on the accelerator pedal.
- Adapt your speed and driving style to the prevailing road conditions.

Failure to observe these guidelines could cause the vehicle to skid. The ESP® cannot prevent accidents resulting from excessive speed.

 Because the ESP® operates automatically, the engine and ignition must be shut off (SmartKey in starter switch position **0** or **1** or KEYLESS-GO start/stop button in position **0** or **1**) when the parking brake is being tested on a brake test dynamometer or when the vehicle is being towed with the front axle raised.

Active braking action through the ESP® may otherwise seriously damage the brake system which is not covered by the Mercedes-Benz Limited Warranty.

 The ESP® will only function properly if you use wheels of the recommended tire size

⁸ Depending on vehicle production date.

⁹ Depending on vehicle production date.

as specified in the “Technical data” section of this Operator’s Manual.

- ① The DISTRONIC system and cruise control switch off automatically when the ESP® engages.

Electronic Traction System (ETS)

⚠ Observe Safety notes, see page 55.

The ETS (Electronic Traction System) is a component of the ESP®. The ETS improves the vehicle’s ability to utilize available traction, especially under slippery road conditions by applying the brakes to a spinning wheel.

When you switch off the ESP®, the ETS is still enabled.

Switching the ESP® off or on (except SL 63 AMG)

⚠ Warning!

The ESP® should not be switched off during normal driving other than in the circumstances described below. Disabling the system will reduce vehicle stability in driving maneuvers.

Do not switch off the ESP® when a spare wheel is mounted.

To improve the vehicle’s traction, switch off the ESP®. This allows the drive wheels to spin and thus cut into surfaces for better grip, for example

- when driving with snow chains
- in deep snow
- in sand or gravel



⚠ Warning!

Switch on the ESP® immediately if the aforementioned circumstances do not apply anymore. Otherwise the ESP® will not

stabilize the vehicle when it is starting to skid or a wheel is spinning.

When you switch off the ESP®,

- the ESP® will not stabilize the vehicle
- the engine output is not limited, which allows the drive wheels to spin and thus cut into surfaces for better grip
- the ETS will still apply the brakes to a spinning wheel
- the ESP® continues to operate when you are braking
- the cruise control or the DISTRONIC system cannot be activated
- the cruise control or the DISTRONIC system switch off if activated

- ① When the ESP® is switched off and one or more drive wheels are spinning, the ABS/ESP® warning lamp  or ⁸ in the instrument cluster flashes. However, the ESP® will then not stabilize the vehicle.

Depending on vehicle production date, the symbol on the ESP® switch may differ.



Version 1

- **Switching off:** With the engine running, press ESP® switch ① until the ESP® OFF

⁸ Depending on vehicle production date.



warning lamp  in the instrument cluster comes on.

The ESP® is switched off.

- **Switching on:** Press ESP® switch  until the ESP® OFF warning lamp  in the instrument cluster goes out. You are now again in normal driving mode with the ESP® switched on.

Warning!

When the ESP® OFF warning lamp  is illuminated continuously, the ESP® is switched off.

When the ABS/ESP® warning lamp  and the ESP® OFF warning lamp  are illuminated continuously, the ESP® is not operational due to a malfunction.

When the ESP® is switched off or not operational, vehicle stability in standard driving maneuvers is reduced.

Adapt your speed and driving to the prevailing road conditions and to the non-operating status of the ESP®.





Version 2

- **Switching off:** With the engine running, press ESP® switch  until the ABS/ESP®

warning lamp  in the instrument cluster comes on.

The ESP® is switched off.

- **Switching on:** Press ESP® switch  until the ABS/ESP® warning lamp  in the instrument cluster goes out. You are now again in normal driving mode with the ESP® switched on.

Warning!

When the ABS/ESP® warning lamp  is illuminated continuously, the ESP® is switched off or is not operational due to a malfunction. Vehicle stability in standard driving maneuvers is reduced.

Adapt your speed and driving to the prevailing road conditions and to the non-operating status of the ESP®.

- ! Avoid spinning of a drive wheel for an extended period with the ESP® switched off. This may cause serious damage to the drivetrain which is not covered by the Mercedes-Benz Limited Warranty.

SL 63 AMG

Switching the SPORT handling mode on or off

Warning!

The SPORT handling mode should not be switched on during normal driving.

Switching the SPORT handling mode on will result in the following:

- no restriction to engine torque
- system-supported traction control is limited

The SPORT handling mode is designed for driving on closed tracks when the vehicle's natural oversteer and understeer characteristics are desired and requires a highly skilled and experienced driver able to handle these critical driving situations.

You could lose control of your vehicle and cause an accident.

Please be aware of these limits when you switch on the SPORT handling mode.

Do not switch on the SPORT handling mode when a spare wheel is mounted.

To improve the vehicle's traction, switch on the SPORT handling mode. This allows the drive wheels to spin and thus cut into surfaces for better grip, for example

- when driving with snow chains
- in deep snow
- in sand or gravel



Warning!

Switch off the SPORT handling mode and switch on the ESP[®] immediately if the aforementioned circumstances do not apply anymore. Otherwise the SPORT handling mode will only stabilize the vehicle to a limited extent when it is starting to skid or a wheel is spinning.

When you switch on the SPORT handling mode

- the ESP[®] stabilizes the vehicle only to a limited extent
- the engine output is limited, but only to the extent that allows the drive wheels to spin and thus cut into surfaces for better grip
- the ETS will still apply the brakes to a spinning wheel
- the ESP[®] continues to operate when you are braking hard
- the cruise control or the DISTRONIC system cannot be activated
- the cruise control or the DISTRONIC system switch off if activated

- i** When the SPORT handling mode is switched on and one or more drive wheels are spinning, the ABS/ESP[®] warning lamp

 or ⁸ in the instrument cluster flashes. However, the ESP[®] will then stabilize the vehicle only to a limited extent.

Depending on vehicle production date, the symbol on the ESP[®] switch may differ.

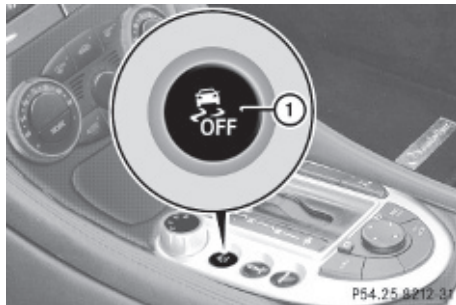



Version 1

- **Switching on:** With the engine running, press ESP[®] switch **1** briefly. The SPORT handling mode warning lamp **SPORT** in the instrument cluster comes on. The message SPORT handling mode appears in the multifunction display.
- **Switching off:** With the engine running, press ESP[®] switch **1** briefly. The SPORT handling mode warning lamp **SPORT** in the instrument cluster goes out.

⁸ Depending on vehicle production date.



Version 2

- ▶ **Switching on:** With the engine running, press ESP[®] switch ① briefly. The ABS/ESP[®] warning lamp  in the instrument cluster comes on. The message ESP-SPORT appears in the multifunction display.
- ▶ **Switching off:** With the engine running, press ESP[®] SPORT switch ① briefly. The ABS/ESP[®] warning lamp  in the instrument cluster goes out. The message ESP-ON appears in the multifunction display.

The SPORT handling mode switches off automatically when you turn off the engine. When starting the engine, the ESP[®] is activated automatically.

Switching the ESP[®] off or on

Warning!

The ESP[®] should not be switched off during normal driving.

Disabling of the system will result in the following:

- no restriction to engine torque
- loss of system-supported traction control

“ESP[®] OFF” is designed for driving on closed tracks when the vehicle’s natural oversteer and understeer characteristics are desired and requires a highly skilled and experienced

driver able to handle these critical driving situations.

You could lose control of your vehicle and cause an accident.

Please be aware of these limits when you switch off the ESP[®].

Do not switch off the ESP[®] when a spare wheel is mounted.

To improve the vehicle’s traction, switch off the ESP[®]. This allows the drive wheels to spin and thus cut into surfaces for better grip, for example



- when driving with snow chains
- in deep snow
- in sand or gravel

Warning!

Switch on the ESP[®] immediately if the aforementioned circumstances do not apply anymore. Otherwise the ESP[®] will not stabilize the vehicle when it is starting to skid or a wheel is spinning.

When you switch off the ESP[®],

- the ESP[®] will not stabilize the vehicle
- the engine output is not limited, which allows the drive wheels to spin and thus cut into surfaces for better grip
- the ETS will still apply the brakes to a spinning wheel
- the ESP[®] continues to operate when you are braking hard
- the cruise control or the Distronic system cannot be activated
- the cruise control or the Distronic system switch off if activated

- i** When the ESP[®] is switched off and one or more drive wheels are spinning, the ABS/ESP[®] warning lamp  or ⁸ in the



⁸ Depending on vehicle production date.

instrument cluster does not flash. The ESP® will then not stabilize the vehicle.

Depending on vehicle production date, the symbol on the ESP® switch may differ.





Version 1

- ▶ **Switching off:** With the engine running, press ESP® switch ① until the ESP® OFF warning lamp  in the instrument cluster comes on. The message ESP-OFF appears in the multifunction display.
- ▶ **Switching on:** With the engine running, press ESP® switch ① until the ESP® OFF warning lamp  in the instrument cluster goes out. The message ESP-ON appears in the multifunction display.

Warning!

When the ESP® OFF warning lamp  is on, the ESP® is switched off.





When the ABS/ESP® warning lamp  and the ESP® OFF warning lamp  are illuminated continuously, the ESP® is not operational due to a malfunction

When the ESP® is switched off or not operational due to a malfunction, vehicle stability in standard driving maneuvers is reduced.



Adapt your speed and driving to the prevailing road conditions and to the non-operating status of the ESP®.



Version 2

- ▶ **Switching off:** With the engine running, press ESP® switch ① until the ABS/ESP® warning lamp  and the ESP® OFF warning lamp  in the instrument cluster come on. The message ESP-OFF appears in the multifunction display.
- ▶ **Switching on:** With the engine running, press ESP® switch ① briefly. The ABS/ESP® warning lamp  and the ESP® OFF warning lamp  in the instrument cluster go out. The message ESP-ON appears in the multifunction display.

Warning!

When the ABS/ESP® warning lamp  and the ESP® OFF warning lamp  are illuminated continuously, the ESP® is switched off. Vehicle stability in standard driving maneuvers is reduced.



Adapt your speed and driving to the prevailing road conditions and to the non-operating status of the ESP®.

- ▶ **!** Avoid spinning of a drive wheel for an extended period with the ESP® switched off. This may cause serious damage to the drivetrain which is not covered by the Mercedes-Benz Limited Warranty.

Electro-hydraulic brake system

The electro-hydraulic brake system combines a hydraulic brake circuit with electronically controlled brake servo assistance. You have increased braking safety and improved braking comfort.

Warning!

Never ignore a brake malfunction indicated in the speedometer display, for example by the  (USA only) or  (Canada only) indicator lamp. Refer to the “Practical hints” section. Also read and observe the messages in the instrument cluster multifunction display.

For information on warning and indicator lamps, see the “Practical hints” section (▷ page 255). For information on the messages that may appear in the multifunction display, see the “Practical hints” section (▷ page 227) and (▷ page 237).

Warning!

The electro-hydraulic brake system requires electrical power to operate.

A malfunction in the vehicle’s power supply or electrical system may impair brake system operation and switch it into its emergency operation mode. In such a case, the red brake warning lamp comes on and warning messages appear in the multifunction display while driving. To brake, the driver must then apply significantly greater brake pedal pressure and depress the pedal much further to obtain the expected braking effect. If necessary, apply full pressure to the brake pedal. Brakes are only applied to the front wheels. Stopping distance is increased!

If there is a malfunction in the electro-hydraulic brake system, we recommend that the vehicle be transported with all wheels off the ground using flatbed or appropriate wheel lift/dolly equipment.

A tow bar must be used if circumstances do not permit the use of the recommended

towing methods and the vehicle requires towing with all four wheels on the ground. Towing the vehicle with all four wheels on the ground is only permissible for distances up to 30 miles (50 km) and at a speed not to exceed 30 mph (50 km/h). For more information, see the “Towing the vehicle” section in this Operator’s Manual.

The electro-hydraulic brake system is activated automatically when you

- unlock the vehicle with the SmartKey or with KEYLESS-GO
- open the driver’s or passenger door
- turn the SmartKey in the starter switch to position **1**
- press the start/stop button on the gear selector lever once (vehicles with KEYLESS-GO)
- depress the brake pedal
- release the parking brake

If the electro-hydraulic brake system is activated as the brake pedal is first depressed, you may feel a reduced pedal resistance and longer pedal travel than normal. When releasing the pedal, you may also feel the brake pedal pulsate and you may hear a sound which is caused by the activation of the electro-hydraulic brake system pump. This is normal and not an indication of a malfunction. Pedal travel returns to normal when you release the brake pedal and the sound soon ceases.

If you experience the above while driving and the red brake warning lamp illuminates and/or warning messages appear in the multifunction display, the brake system is malfunctioning. Follow the instructions of the warning message(s) and have the brake system checked immediately.

Warning!

Have brake pad replacement and other work on the electro-hydraulic brake system carried

out by qualified technicians only. Contact an authorized Mercedes-Benz Center for further information.

The electro-hydraulic brake system must be deactivated prior to working on the system. High pressure is intermittently built up in the system as part of its automatic self-test.

In addition, the system is automatically activated when the vehicle is unlocked by remote control, when the driver or passenger door is opened, when the SmartKey in the starter switch is turned to position **1** or the KEYLESS-GO start/stop button is pressed once, when the brake pedal is depressed or when the parking brake is released. Failure to deactivate the system prior to maintenance will cause brake pistons to extend and brake fluid to leak, which may result in injuries (contusions and acid burns). Extended brake pistons may also cause injury.

The electro-hydraulic brake system switches off automatically

- approximately 2 minutes after you turned the SmartKey in the starter switch to position **0** or removed the SmartKey
- approximately 2 minutes after you pressed the KEYLESS-GO start/stop button to turn off the engine or power supply and opened the driver's door (with driver's door open, the starter switch is set to position **0**, same as SmartKey removed from starter switch)
- approximately 20 seconds after you locked the vehicle from outside

For more information on your vehicle's brakes, see the "Driving instructions" section (▷ page 210).

Anti-theft systems

Immobilizer

The immobilizer prevents unauthorized persons from starting your vehicle.

When leaving the vehicle, always take the SmartKey with you and lock the vehicle. The engine can be started by anyone with a valid SmartKey that is left inside the vehicle.

Activating

- ▶ **With SmartKey:** Remove the SmartKey from the starter switch.
- ▶ **With KEYLESS-GO:** Turn off the engine and open the driver's door.

Deactivating

- ▶ Switch on the ignition.
- ▶ **i** Starting the engine will also deactivate the immobilizer.
In the event that the engine cannot be started (yet the vehicle's battery is charged), the system is not operational. Contact an authorized Mercedes-Benz Center or call 1-800-FOR-MERCEDES (in the USA) or 1-800-387-0100 (in Canada).

Anti-theft alarm system

Once the alarm system has been armed, a visual and audible alarm is triggered when someone opens

- a door
- the trunk
- the hood
- a storage compartment in the rear
- the glove box
- the storage compartment under the armrest

The alarm will stay on even if the activating element, a door, for example, is closed immediately.

The alarm system will also be triggered when

- the vehicle is raised (tow-away alarm)
- the vehicle is opened with the mechanical key

- a door is opened from the inside
- the trunk is opened with the emergency release button

To cancel the alarm after it has been triggered, see “Canceling the alarm” (▷ page 65).

- i** If the alarm stays on for more than 30 seconds, the Tele Aid system initiates a call to the Customer Assistance Center automatically. The Tele Aid system will initiate the call provided that
 - you have subscribed to the Tele Aid service
 - the Tele Aid service has been activated properly
 - the necessary mobile phone, power supply and GPS coverage are available



- ▶ **Arming:** Lock the vehicle with the SmartKey or with KEYLESS-GO. The turn signal lamps flash three times and an acoustic warning sounds three times to indicate that the vehicle is locked. Indicator lamp ① flashes to indicate that the alarm system is armed.
- i** If the turn signal lamps do not flash three times and the acoustic warning does not sound three times, a door or the trunk may not be properly closed.

Close the respective element.

- ▶ **Disarming:** Unlock the vehicle with the SmartKey or with KEYLESS-GO. The turn signal lamps flash once and an acoustic warning sounds once to indicate that the alarm system is disarmed.

- i** Unless you open a door or the trunk within approximately 40 seconds after unlocking the vehicle:
 - The vehicle will be locked again.
 - The anti-theft alarm system will be rearmed.

Tow-away alarm

Once the tow-away alarm is armed, a visual and audible alarm will be triggered when someone attempts to raise the vehicle.

To cancel the alarm after it has been triggered, see “Canceling the alarm” (▷ page 65).

- i** If the alarm stays on for more than 30 seconds, a call to the Customer Assistance Center is initiated automatically by the Tele Aid system provided that you have subscribed to the Tele Aid service and that it has been activated properly, and that the necessary mobile phone, power supply and GPS coverage are available.

- ▶ **Arming:** Lock the vehicle with the SmartKey or with KEYLESS-GO. The tow-away alarm is armed after about 30 seconds automatically.
- ▶ **Disarming:** Unlock the vehicle with the SmartKey or with KEYLESS-GO. The tow-away alarm remains disarmed until you lock the vehicle again.

Disabling tow-away alarm

To prevent triggering the tow-away alarm, disable the tow-away alarm feature before towing the vehicle, or when parking on a

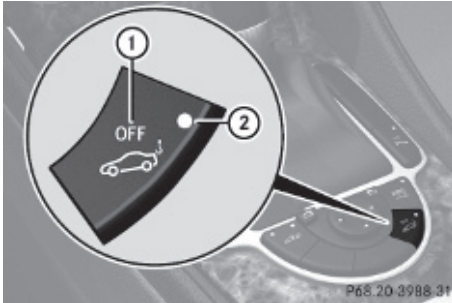

surface subject to movement, such as a ferry or auto train.



- ▶ Remove the SmartKey from the starter switch.
 - ▶ Press tow-away alarm switch ①.
Indicator lamp ② comes on briefly.
 - ▶ Exit and lock the vehicle.
- The tow-away alarm remains disabled until you lock the vehicle again.

Canceling the alarm

To cancel the alarm, do one of the following:

- ▶ Insert the SmartKey into the starter switch.
- ▶ Press button  or  on the SmartKey.

In vehicles with KEYLESS-GO:

- ▶ Grasp an outside door handle.
The SmartKey must be within 3 ft (1 m) of the vehicle.
- ▶ Press the KEYLESS-GO start/stop button.
The SmartKey must be inside the vehicle.

Vehicle equipment	68
Locking and unlocking	68
Starter switch positions	78
Seats	80
Multifunction steering wheel	84
Mirrors	86
Memory function	88
Lighting	89
Wipers	95
Power windows	96
Driving and parking	98
Automatic transmission	103
Instrument cluster	111
Control system	113
Driving systems	130
Climate control system	148
Rear window defroster	155
Retractable hardtop	155
Loading and storing	161
Useful features	164



Vehicle equipment

i This Operator's Manual describes all features, standard or optional, potentially available for your vehicle at the time of purchase. Please be aware that your vehicle might not be equipped with all features described in this manual.

Locking and unlocking

Notes

⚠ Observe Safety notes, see page 51.

When unlocking or locking the vehicle with the SmartKey an acoustic signal sounds. The acoustic signal is activated at the factory. If you wish to deactivate the feature, or adjust its signal volume, contact an authorized Mercedes-Benz Center.

When unlocking the vehicle, all turn signal lamps flash once. An acoustic signal sounds once, and the locking knobs in the doors move up. The anti-theft alarm system is disarmed.

When locking the vehicle, all turn signal lamps flash three times. An acoustic signal sounds three times, and the locking knobs in the doors move down. The anti-theft alarm system is armed.

All doors and the trunk must be closed.

If you cannot lock or unlock the vehicle with the SmartKey, the batteries in the SmartKey are discharged, the SmartKey is malfunctioning, or the vehicle battery is drained.

- ▶ Check the batteries in the SmartKey (▷ page 71) and replace them if necessary.
- ▶ Use the mechanical key to unlock the driver's door and the trunk (▷ page 267).

▶ Use the mechanical key to lock the vehicle (▷ page 269).

▶ Have the vehicle battery and the vehicle battery connections checked at an authorized Mercedes-Benz Center.

If the SmartKey is malfunctioning, contact Roadside Assistance or an authorized Mercedes-Benz Center.

SmartKey



Your vehicle comes supplied with two SmartKeys, each with remote control and a removable mechanical key.

The SmartKey centrally locks and unlocks

- the doors
- the trunk lid
- the fuel filler flap
- the glove box
- the storage compartment under the armrest
- the rear storage compartments



Example illustration: SmartKey with KEYLESS-GO

- ①  Lock button
- ②  Unlock button for trunk lid
- ③  Unlock button

When you open a door, the windows on that side lowers slightly. Once you close the door, the windows move up again.

! A window will not work if it is blocked with ice or if the vehicle battery is discharged. If

you cannot shut a door, do not force it or you could damage the door or the window. Fix whatever is affecting the window before trying to shut the door.

i USA only:

This device complies with Part 15 of the FCC Rules. Operation is subject to the following two conditions:

1. This device may not cause harmful interference, and
2. this device must accept any interference received, including interference that may cause undesired operation.

Any unauthorized modification to this device could void the user's authority to operate the equipment.

i Canada only:

This device complies with RSS-210 of Industry Canada. Operation is subject to the following two conditions:

1. This device may not cause interference, and
2. this device must accept any interference received, including interference that may cause undesired operation of the device.

Any unauthorized modification to this device could void the user's authority to operate the equipment.

Factory setting

► **Global unlocking:** Press button .



Unless you open a door or the trunk within approximately 40 seconds after unlocking the vehicle:

- The vehicle will be locked again.
- The anti-theft alarm system will be rearmed.

► **Global locking:** Press button .

Selective setting

If you frequently travel alone, you may wish to reprogramm the SmartKey. Pressing button  will then only unlock the driver's door, interior lockable storage compartments, and the fuel filler flap.

► **Switching on/off:** Press and hold buttons  and  simultaneously for approximately 6 seconds until the battery check lamp (▷ page 71) flashes twice.

The SmartKey will then function as follows:

► **Unlocking driver's door and fuel filler flap:** Press button  once.

► **Global unlocking:** Press button  twice.

► **Global locking:** Press button .

KEYLESS-GO

Vehicles equipped with KEYLESS-GO come with two SmartKeys with KEYLESS-GO, each with remote control and a removable mechanical key.

The KEYLESS-GO function is integrated into the SmartKey. The validity of the SmartKey is checked every time you grasp an outside door handle.

When the SmartKey is valid, your vehicle unlocks

- the doors
- the trunk lid
- the fuel filler flap
- the glove box
- the storage compartment under the armrest
- the rear storage compartments

When you open a door, the windows on that side lowers slightly. Once you close the door, the windows move up again.

! A window will not work if it is blocked with ice or if the vehicle battery is discharged. If

you cannot shut a door, do not force it or you could damage the door or the window. Fix whatever is affecting the window before trying to shut the door.

i USA only:

This device complies with Part 15 of the FCC Rules. Operation is subject to the following two conditions:

1. This device may not cause harmful interference, and
2. this device must accept any interference received, including interference that may cause undesired operation.

Any unauthorized modification to this device could void the user's authority to operate the equipment.

i Canada only:

This device complies with RSS-210 of Industry Canada. Operation is subject to the following two conditions:

1. This device may not cause interference, and
2. this device must accept any interference received, including interference that may cause undesired operation of the device.

Any unauthorized modification to this device could void the user's authority to operate the equipment.

- electronic items such as a mobile phone or another SmartKey
- metallic objects such as coins or metal foil

Doing so could impair the function of the KEYLESS-GO system.

- To lock or unlock the vehicle, the SmartKey must be located outside the vehicle within approximately 3 ft (1 m) of a door or the trunk.
 - When the vehicle has been parked for more than 72 hours, the KEYLESS-GO function is deactivated. Pull an outside door handle and switch on the ignition once to activate the KEYLESS-GO function.
 - If the SmartKey is positioned farther away from the vehicle, the system may no longer recognize the SmartKey. The vehicle cannot be locked or the engine started via the KEYLESS-GO system.
 - If the SmartKey is removed from the vehicle while the engine is running (e.g. if a passenger exits the vehicle with the SmartKey), the message **Key Not Detected** appears in the multifunction display while driving off.
- Find the SmartKey or change its present location immediately (e.g. place it on the passenger seat or insert it in shirt pocket).

- If you have started the engine with the KEYLESS-GO start/stop button, you can only turn it off again with this button, even if you have put the SmartKey in the starter switch in the meantime.
- This does not apply if, after starting, the automatic transmission is still in park position **P** and the SmartKey is then inserted in the starter switch. The SmartKey will then have priority over the KEYLESS-GO function and the vehicle's electrical system will operate according to the position of the SmartKey in the starter switch, even stopping the engine.

Important notes on using KEYLESS-GO

- You can also use the SmartKey with KEYLESS-GO like a normal SmartKey (> page 68).
- You can combine KEYLESS-GO functions with normal SmartKey functions (e.g. unlocking with KEYLESS-GO and locking with button ).
- Always carry the SmartKey with you.
- Never store the SmartKey together with

- The vehicle could be inadvertently unlocked if the SmartKey is within 3 ft (1 m) of the vehicle and
 - an outside door handle is splashed with water or
 - you attempt to clean an outside door handle
- Remember that the engine can be started by anyone with a SmartKey that is left inside the vehicle. If you leave the SmartKey behind when exiting and locking the vehicle, the message Key Detected In Vehicle appears in the multifunction display.

Factory setting

- ▶ **Global unlocking:** Grasp an outside door handle.

Unless you open a door or the trunk within approximately 40 seconds after unlocking the vehicle:

- The vehicle will be locked again.
- The anti-theft alarm system will be rearmed.

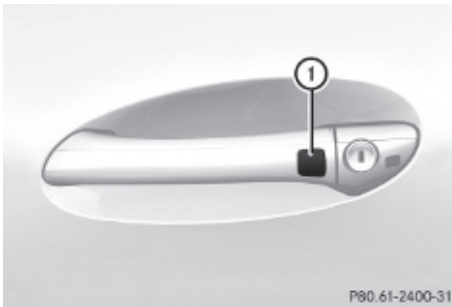



- ▶ **Global locking:** Press lock button ① on an outside door handle.

Selective setting

If you frequently travel alone, you may wish to reprogram the SmartKey. Grasping the driver's outside door handle will then only

unlock the driver's door, interior lockable storage compartments, and the fuel filler flap.

- ▶ **Switching on/off:** Press and hold buttons  and  simultaneously for approximately 6 seconds until the battery check lamp (▷ page 71) flashes twice.



KEYLESS-GO will then function as follows:

- ▶ **Unlocking driver's door and fuel filler flap:** Grasp the driver's outside door handle.
- ▶ **Global unlocking:** Grasp the outside door handle on the passenger side.
- ▶ **Global locking:** Press lock button ① on an outside door handle.

Checking SmartKey batteries



Example illustration: SmartKey with KEYLESS-GO



- ▶ Press button  or  on the SmartKey. Battery check lamp ① comes on briefly to indicate that the SmartKey batteries are in order.

If the battery check lamp does not come on briefly during check, the SmartKey batteries are discharged.

- ▶ Replace the batteries (▷ page 269).

i You can obtain the required batteries at any authorized Mercedes-Benz Center.

i If the batteries are checked within signal range of the vehicle, pressing button

 or  will lock or unlock the vehicle accordingly.

Loss of the SmartKey

If you lose your SmartKey or mechanical key, you should do the following:

- ▶ Have the SmartKey deactivated by an authorized Mercedes-Benz Center.
- ▶ Report the loss of the SmartKey or the mechanical key to your car insurance company immediately.
- ▶ Have the mechanical lock replaced if necessary.

Any authorized Mercedes-Benz Center will be glad to supply you with a replacement. For information on replacing the SmartKey, see “Replacing the SmartKey” (▷ page 72).

Replacing the SmartKey

Only you, or someone authorized by you can order a replacement key from any Mercedes-Benz Center. In order to do so, the Mercedes-Benz Center will require proof of identity and vehicle ownership with original documents, including the following:

If you are the current owner of the vehicle:

- the vehicle’s current state registration
- a current identity card, passport, or drivers license

If you are an authorized person:

- the vehicle’s current state registration
- a current identity card, passport, or drivers license for the authorized individual
- signed and dated authorization from the owner of the vehicle for which the key is being requested

i Duplicated or photocopied documentation will not be accepted.

Activating the key

Once you, or an authorized person, has provided the appropriate documents, the Mercedes-Benz Center will need to synchronize the key to your vehicle before it can be used. In order to do so, the Mercedes-Benz Center need access to your vehicle.

Opening the doors from the inside

You can open a locked door from the inside. Open door only when conditions are safe to do so.

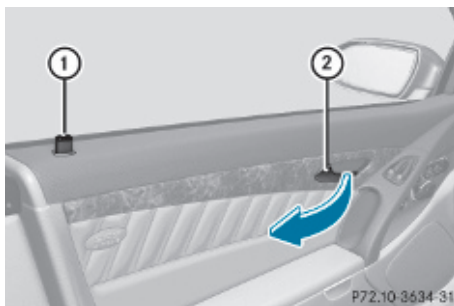

Example illustration driver’s door

If the vehicle has previously been locked with the SmartKey or with KEYLESS-GO, opening a door from the inside will trigger the anti-theft alarm system.

To cancel the alarm, see (▷ page 65).

- ▶ Pull on inside door handle (2) on the respective door.

If the door was locked, locking knob (1) will move up.

When you open a door, the windows on that side lowers slightly. Once you close the door, the windows move up again.

! A window will not work if it is blocked with ice or if the vehicle battery is discharged. If you cannot shut a door, do not force it or you could damage the door or the window. Fix whatever is affecting the window before trying to shut the door.

Automatic central locking

You can switch the automatic central locking on or off using the control system (▷ page 126).

The doors and the trunk lock automatically when the vehicle is set into motion.

You can open a locked door from the inside. Open door only when conditions are safe to do so.

The doors are designed to unlock automatically after an accident if the force of the impact exceeds a preset threshold.

The vehicle locks automatically when the ignition is switched on and the wheels are turning at a vehicle speed of above 9 mph (15 km/h). You could therefore lock yourself out when the vehicle is pushed or towed or is on a test stand.

Locking and unlocking from the inside

 **Observe Safety notes, see page 51.**

You can lock or unlock the vehicle from the inside using the central locking or unlocking switch. This can be useful, for example, if you want to lock the vehicle before starting to drive.

The central locking or unlocking switch does not lock or unlock the fuel filler flap or the interior storage compartments, such as the glove box.



► **Locking:** Press central locking switch ①. When all doors are closed, the vehicle locks.

► **Unlocking:** Press central unlocking switch ②.

You can open a locked door from the inside. Open door only when conditions are safe to do so.

If the vehicle was previously locked with the central locking switch

- and the SmartKey is set to factory settings, the complete vehicle is unlocked when a door is opened from the inside
- and the SmartKey is set to selective settings, only the door opened from inside is unlocked

If the vehicle has been locked centrally with the SmartKey or with KEYLESS-GO, it will not unlock using the central unlocking switch.

Opening the trunk

 **Warning!**

Make sure the trunk is closed when the engine is running and while driving. Among other dangers, deadly carbon monoxide (CO) gases may enter vehicle interior resulting in unconsciousness and death.

! When you open the trunk, the trunk lid swings open upwards. Always make sure there is sufficient overhead clearance.

You can open the trunk when the vehicle is stationary and the retractable hardtop is fully opened or closed.

A minimum height clearance of 6.2 ft (1.88 m) is required to open the trunk lid.

i To facilitate trunk loading and unloading when the hardtop is retracted, you can raise the hardtop from its storage position in the trunk using the load assist feature (▷ page 164). You may also unhook the luggage cover.

Remember to re-secure the luggage cover after loading/unloading the trunk. Otherwise you will not be able to lower the retractable hardtop.

Opening the trunk from the outside

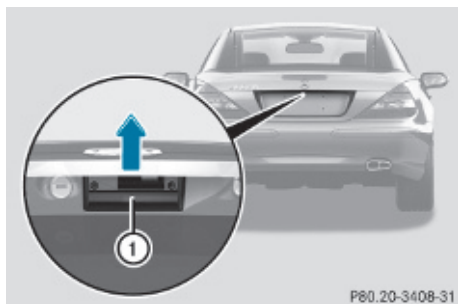

Vehicles without trunk opening/closing system

▶ Press button  on the SmartKey.

or

▶ Pull on handle ①.

In vehicles without KEYLESS-GO: The vehicle must be unlocked.

If the trunk does not open, it is still locked separately (▶ page 77).

Vehicles with trunk opening/closing system

▶ Press and hold button  on the SmartKey until trunk unlocks and begins to open.

or

▶ Pull on handle ①.

In vehicles without KEYLESS-GO: The vehicle must be unlocked.

If the trunk does not open, it is still locked separately (▶ page 77).

▶ **Stopping the opening procedure:** Press button  on the SmartKey or pull the trunk lid handle.

Opening the trunk from the inside

Vehicles without trunk opening/closing system

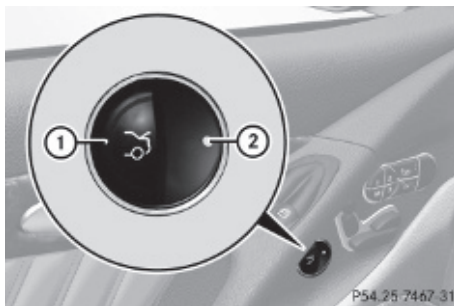

- ▶ Pull remote trunk opening switch ① until the trunk unlocks and opens slightly. Indicator lamp ② comes on and remains lit until the trunk is closed.
- ▶ Lift the trunk lid.

Vehicles with trunk opening/closing system

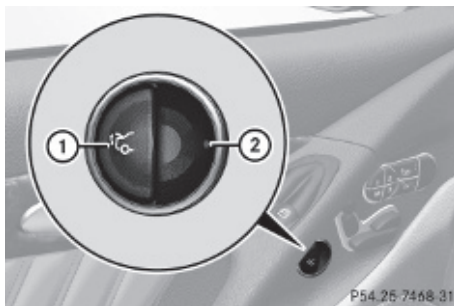

- ▶ Pull and hold remote trunk opening/closing switch ① until the trunk unlocks and begins to open. Indicator lamp ② comes on and remains lit until the trunk is closed.
- ▶ Release remote trunk opening switch ①.
- ▶ **To interrupt the opening procedure:** Press or pull remote trunk opening/closing switch ①.

Closing the trunk

Warning!

Make sure the trunk is closed when the engine is running and while driving. Among other dangers, deadly carbon monoxide (CO) gases may enter vehicle interior resulting in unconsciousness and death.

Warning!

To prevent possible personal injury, always keep hands and fingers away from the trunk opening when closing the trunk lid. Be especially careful when small children are around.

Observe Safety notes, see page 51.

Do not leave the SmartKey in the open trunk. You may lock yourself out.

If the vehicle was previously locked centrally with the SmartKey or KEYLESS-GO, the trunk lid will lock automatically when closed. All turn signal lamps flash three times and an acoustic signal sounds three times to confirm locking.

- i** When the hardtop is retracted, it must be completely lowered in the trunk before the trunk can be closed (▷ page 155).

Closing the trunk from the outside manually

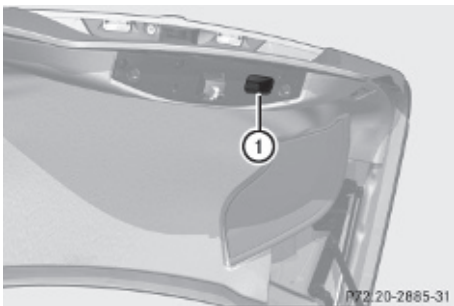

- ▶ Lower trunk lid by pulling on handle ① firmly.
- ▶ Close trunk with hands placed flat on trunk lid.

The power closing assist automatically ensures that the trunk lid is pulled completely close (▷ page 78).

Closing the trunk from the inside automatically

Warning!

Maintain sight of the area around the rear of the vehicle while operating the trunk lid with the door mounted switch. Monitor the closing procedure carefully to make sure no one is in danger of being injured.

To interrupt the closing procedure, release the door mounted remote trunk opening/closing switch again.

Even with the SmartKey removed from the starter switch or the SmartKey with KEYLESS-GO removed from the vehicle, the remote trunk opening/closing switch can be operated. Therefore, do not leave children unattended in the vehicle, or with access to an unlocked vehicle. A child's unsupervised access to a vehicle could result in an accident and/or serious personal injury.

In vehicles with trunk opening/closing system you can close the trunk from the inside using the remote trunk opening/closing switch.

If the trunk lid comes into contact with an object while closing, the closing procedure is stopped and the trunk lid reopens slightly. This will happen only while the trunk is in its upper motion sequence. Check if luggage has been piled too high, for example.

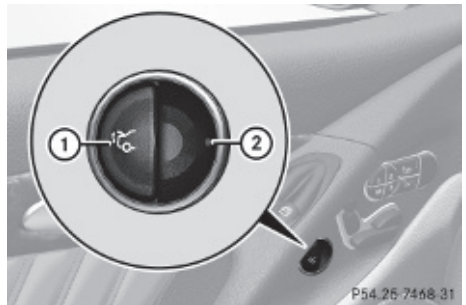

- ▶ Press and hold remote trunk opening/closing switch ① until the trunk is closed. Indicator lamp ② in the switch goes out when the trunk is closed.
- ▶ **Interrupting the closing procedure:** Release remote trunk opening/closing switch ①.

Closing the trunk from the outside automatically

Warning!

Monitor the closing procedure carefully to make sure no one is in danger of being injured. To prevent possible personal injury, always keep hands and fingers away from the trunk opening when closing the trunk lid. Be especially careful when small children are around. To stop the closing procedure, do one of the following:

- Press button  on the SmartKey.
- Press the remote trunk opening/closing switch (on the driver's door).
- Press the trunk closing switch.
- Press the KEYLESS-GO locking/closing switch.
- Pull the trunk lid handle.

Even with the SmartKey removed from the starter switch or the SmartKey with KEYLESS-GO removed from the vehicle, the remote trunk opening/closing switch can be operated. Therefore, do not leave children unattended in the vehicle, or with access to an unlocked vehicle. A child's unsupervised access to a vehicle could result in an accident and/or serious personal injury.

In vehicles with trunk opening/closing system you can close the trunk from the outside using the trunk closing switch.

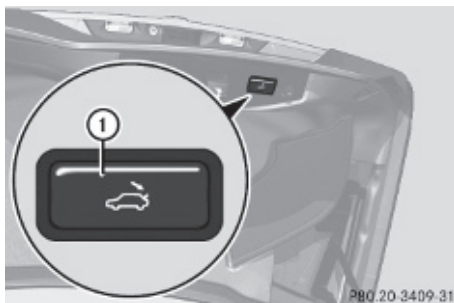

Vehicles without KEYLESS-GO

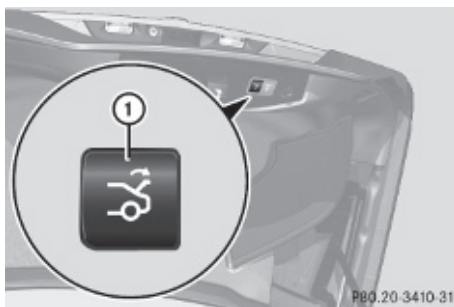

Vehicles with KEYLESS-GO

- ▶ Press trunk closing switch ① briefly.

Closing the trunk and locking vehicle from outside

This section applies to vehicles with trunk opening/closing system and KEYLESS-GO only. You can close the trunk and lock the vehicle simultaneously from the outside using the KEYLESS-GO locking/closing switch.

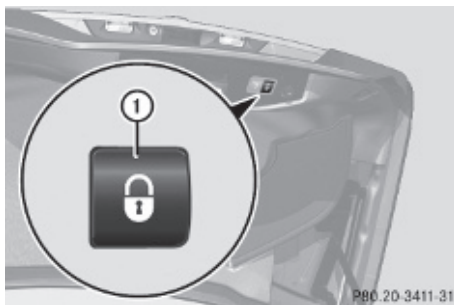

- ▶ Make sure you have the SmartKey with KEYLESS-GO with you.
- ▶ Press KEYLESS-GO locking/closing switch ① briefly.

With all doors closed:

- The locking knobs in the doors move down.
- The trunk lid starts to close automatically.
- All turn signal lamps flash three times once the trunk has closed completely.
- An acoustic signal sounds three times once the trunk has closed completely.
- The anti-theft alarm system is armed.

Trunk lid emergency release

The trunk lid can be opened from inside the trunk with the emergency release button.



- ▶ Briefly press emergency release button ①.
The trunk lid unlocks and opens slightly.
- ▶ Push up the trunk lid to fully open.

The emergency release button unlocks the trunk while the vehicle is standing still or in motion.

Illumination of the emergency release button:

- The button flashes for 30 minutes after opening the trunk.
- The button flashes for 60 minutes after closing the trunk.

The emergency release button does not unlock the trunk, if the vehicle battery is discharged or disconnected.

Valet locking

You can lock the trunk separately with the mechanical key. This denies unauthorized access to the trunk, e.g. when you valet park the vehicle.

- ▶ Leave only the SmartKey less its mechanical key with the vehicle.

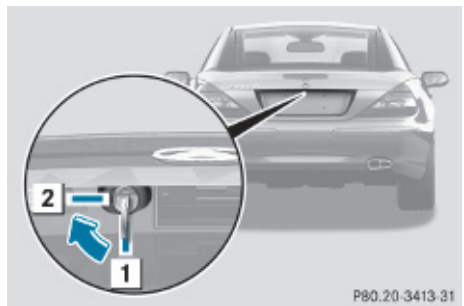

- ▶ **Valet locking:** Close the trunk.
- ▶ Remove the mechanical key from the SmartKey (> page 267).
- ▶ Insert the mechanical key in the trunk lid lock.
- ▶ Turn the mechanical key clockwise to position 2 and remove the mechanical key in that position to lock the trunk.

The trunk remains locked even when the vehicle is centrally unlocked.

You can then only open the trunk with the mechanical key.

- ▶ **Canceling:** Insert the mechanical key in the trunk lid lock.
- ▶ Turn the mechanical key counterclockwise to neutral position 1 and remove the mechanical key in that position to unlock the trunk.

You can now open the trunk.

Power closing assist for trunk lid

It is not necessary to slam the trunk lid closed. An electrical power-assisted mechanism draws the trunk lid closed quietly and automatically once the trunk lid has been latched. When the electrical power-assisted mechanism has stopped, the trunk can be reopened.

Warning!

To prevent possible personal injury, always keep hands and fingers away from the trunk opening when closing the trunk lid. Be especially careful when small children are around.

In case of danger, pull the inside or outside door handle, or press the trunk lid lock.

To prevent personal injury, never actuate the closing assist mechanism by tampering with the door or trunk lid latch.

Warning!

Make sure the trunk is closed when the engine is running and while driving. Among other dangers, deadly carbon monoxide (CO) gases may enter vehicle interior resulting in unconsciousness and death.

- ▶ Press the trunk lid gently into its lock.

Starter switch positions

SmartKey

 **Observe Safety notes, see page 51.**

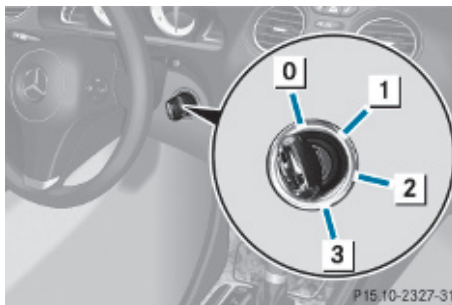

Starter switch

- 0** For removing SmartKey (gear selector lever must be in park position **P**)
- 1** Power supply for some electrical consumers, e.g. wipers
- 2** Ignition (power supply for all electrical consumers) and driving position
- 3** Starting position

When you switch on the ignition, all lamps in the instrument cluster come on. The high-beam headlamp indicator lamp and turn signal indicator lamps will only come on if activated. If a lamp in the instrument cluster fails to come on when the ignition is switched on, have it checked and replaced if necessary. If a lamp in the instrument cluster remains on after starting the engine or comes on while driving, refer to “Lamps in instrument cluster” (> page 254).

- ▶ Always remove the SmartKey from the starter switch when the engine is not in operation.
This will help to prevent accelerated vehicle battery discharge or a completely discharged vehicle battery.

If the SmartKey cannot be turned in the starter switch, the vehicle battery may not be sufficiently charged.

- ▶ Check the vehicle battery and charge it if necessary (> page 285).

or

- ▶ Get a jump start (▷ page 285).

KEYLESS-GO

 **Observe Safety notes, see page 5 1.**

Vehicles equipped with the KEYLESS-GO feature are supplied with a SmartKey with integrated KEYLESS-GO function.

The SmartKey must be present in the vehicle.

Pressing the KEYLESS-GO start/stop button without depressing the brake pedal corresponds to the various starter switch positions (▷ page 78).

Pressing the KEYLESS-GO start/stop button with the brake pedal firmly depressed will start the engine (▷ page 98).

The function of the SmartKey overrules the KEYLESS-GO function.

- ▶ Make sure the automatic transmission is in park position **P**.
- ▶ Do not depress the brake pedal.

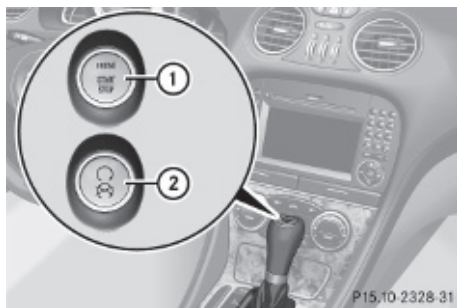

KEYLESS-GO start/stop button

- ① USA only
- ② Canada only

Position 0

Before you press the KEYLESS-GO start/stop button, the vehicle's on-board electronics have status **0** (as with SmartKey removed).

Position 1

- ▶ Press the KEYLESS-GO start/stop button once.
This supplies power for some electrical consumers, e.g. wipers.

- i** When you now press the KEYLESS-GO start/stop button
 - once more, the ignition (position **2**) is switched on
 - twice more the power supply is again switched off

Ignition (or position 2)

- ▶ Press the KEYLESS-GO start/stop button twice.
This supplies power for all electrical consumers.

When you switch on the ignition, all lamps in the instrument cluster come on. The high-beam headlamp indicator lamp and turn signal indicator lamps will only come on if activated. If a lamp in the instrument cluster fails to come on when the ignition is switched on, have it checked and replaced if necessary. If a lamp in the instrument cluster remains on after starting the engine or comes on while driving, refer to "Lamps in instrument cluster" (▷ page 254).

- i** When you now press the KEYLESS-GO start/stop button once, the power supply is again switched off.

Seats

Safety notes

Warning!

In order to avoid possible loss of vehicle control the following must be done before the vehicle is put into motion:

- seat adjustment
- head restraint adjustment
- steering wheel adjustment
- rear view mirror adjustment
- fastening of seat belts

Warning!

Do not adjust the driver's seat while driving. Adjusting the seat while driving could cause the driver to lose control of the vehicle.

Never ride in a moving vehicle with the seat backrest in an excessively reclined position as this can be dangerous. You could slide under the seat belt in a collision. If you slide under it, the seat belt would apply force at the abdomen or neck. That could cause serious or fatal injuries. The seat backrest and seat belts provide the best restraint when the wearer is in a position that is as upright as possible and seat belts are properly positioned on the body.

Warning!

Your seat must be adjusted so that you can correctly fasten your seat belt.

Observe the following points:

- Adjust the seat backrest until your arms are slightly angled when holding the steering wheel.
- Adjust the seat to a comfortable seating position that still allows you to reach the accelerator/brake pedal safely. The position should be as far back as possible with the driver still able to operate the controls properly.

- Adjust the head restraint so that it is as close to the head as possible. The center of the head restraint must support the back of the head at eye level.
- Never place hands under the seat or near any moving parts while a seat is being adjusted.

Failure to do so could result in an accident and/or serious personal injury.

Warning!

The power seats can be operated at any time. Therefore, do not leave children unattended in the vehicle, or with access to an unlocked vehicle. A child's unsupervised access to a vehicle could result in an accident and/or serious personal injury.

Warning!

Children 12 years old and under must be seated and properly secured in an appropriately sized infant restraint, toddler restraint, or booster seat recommended for the size and weight of the child. For additional information, see section "Children in the vehicle".

A child's risk of serious or fatal injuries is significantly increased if the child restraints are not properly secured in the vehicle and/or the child is not properly secured in the child restraint.

Warning!

For your protection, drive only with properly positioned head restraints.

Adjust the head restraint so that it is as close to the head as possible and the center of the head restraint supports the back of the head at eye level. This will reduce the potential for injury to the head and neck in the event of an accident or similar situation.

Do not drive the vehicle without the seat head restraints. Head restraints are intended to help reduce injuries during an accident.

Seat adjustment

- ⚠ When moving the seats, make sure there are no items in the footwell or behind the seats. Otherwise, you could damage the seats and/or the items.

Power seats

- i The memory function (▷ page 88) lets you store the settings for the seat position together with the settings for the steering wheel and the exterior rear view mirrors.

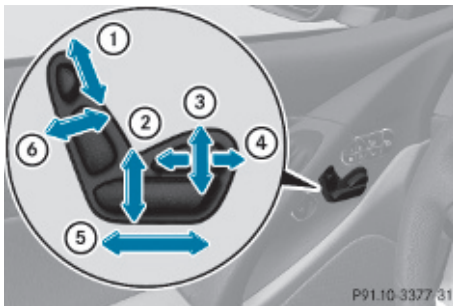

- ▶ **Seat fore and aft adjustment:** Press the switch forward or backward in direction of arrow ⑤.
- i When moving the seat fore or aft, the head restraints may readjust automatically.
- ▶ **Seat height:** Press the switch up or down in direction of arrow ②.
- ▶ **Seat cushion tilt:** Press the switch up or down in direction of arrow ③ until your upper legs are lightly supported.
- ▶ **Seat cushion depth:** Press the switch forward or backward in direction of arrow ④ until your legs are supported comfortably.
- ▶ **Seat backrest tilt:** Press the switch forward or backward in direction of arrow ①.
- ▶ **Head restraint height:** Press the switch up or down in direction of arrow ⑥.

Moving the seats forward and backward

You can move the seats forward and backward to facilitate loading and unloading.

⚠ Warning!

When moving the seats, make sure no one can be caught by them. Never place hands under seat or near any moving parts during a seat adjustment procedure. To stop the seat from moving when potential danger exists:

- Press the switch once more.
- Move the seat adjustment switch on the door.

- ⚠ When moving the seats, make sure there are no items in the footwell or behind the seats. Otherwise, you could damage the seats and/or the items.

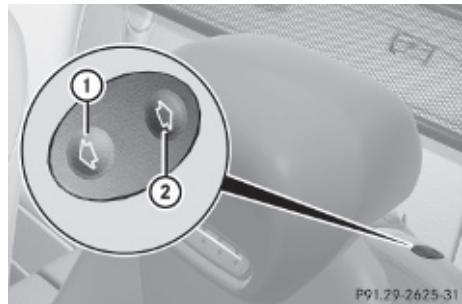

- ▶ **Moving the seat forward:** Press switch at ① and release. The seat moves forward automatically.
- ▶ **Moving the seat backward:** Press switch at ② and release. The seat moves backwards to its previous position automatically.

Lumbar support

You can adjust the contour of the seat's lumbar support to help enhance support to your spine.

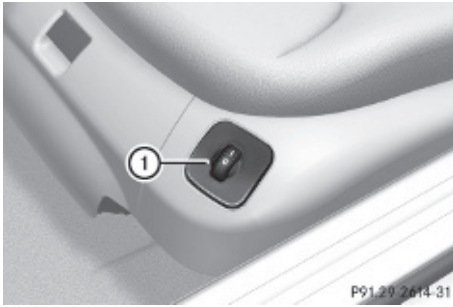

- ▶ Switch on the ignition.
- ▶ Set the lumbar support with thumbwheel ① between 0 and 5.

Multicontour seat

The multicontour seat backrest has inflatable air cushions built into the seat backrest to provide additional lumbar and side support.

The seat backrest cushion height and curvature can be continuously varied with switches on the lower left side (driver's seat) or the lower right side (passenger seat) of the seat when the ignition is switched on.

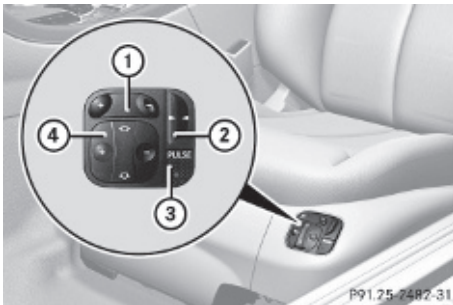

- ▶ Switch on the ignition.
- ▶ **Shoulder region support:** Press or on switch ①. The air cushion inflates or deflates.
- ▶ **Lumbar region support:** Press or on rocker switch ④. This selects the air cushion you wish to adjust.

- ▶ Press or on rocker switch ④. The air cushion inflates or deflates.
- ▶ **Side bolsters adjustment:** Press switch ② to the right or left. The lateral support increases or decreases.

Massage function (PULSE)

You can reduce muscle tension during long trips by periodically using the massage function.

- ▶ Press button ③. The indicator lamp in the button comes on. The air cushions in the lumbar region inflate and deflate rhythmically.
- ▶ **i** The massage function switches off automatically after approximately 8 minutes. The indicator lamp goes out.

Seat ventilation

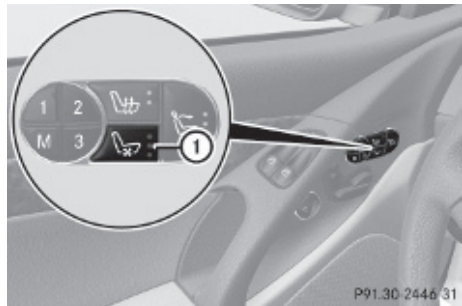

The blue indicator lamps in seat ventilation switch ① come on to show which ventilation level you have selected.

- ▶ **i** The seat ventilation for the driver's seat can be activated using the summer opening feature (▶ page 157).
- ▶ Switch on the ignition.
- ▶ **Switching on:** Press seat ventilation switch ①. Three blue indicator lamps in seat ventilation switch ① come on.

- ▶ Press seat ventilation switch ① repeatedly until the desired ventilation level is set.
- ▶ **Switching off:** Press seat ventilation switch ① repeatedly until all indicator lamps go out.

If one or more of the indicator lamps in the seat ventilation switch ① are flashing, there is insufficient voltage available since too many electrical consumers are turned on. The seat ventilation switches off automatically. The seat ventilation will switch back on again automatically as soon as sufficient voltage is available.

Seat heating

The seat heating will switch back on again automatically as soon as sufficient voltage is available.

Vehicles without seat ventilation

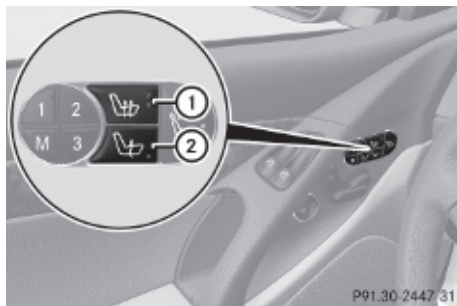

- ① Rapid heating
- ② Normal heating

The red indicator lamps in the switch come on to show which heating level you have selected.

The seat heating switches from level 2 (rapid seat heating) to level 1 (normal seat heating) after approximately 5 minutes.

The seat heating automatically switches off after approximately 30 minutes.

- ▶ Switch on the ignition.
- ▶ **Switching on seat heating:** Press lower switch position ②. A red indicator lamp in the switch comes on.
- ▶ **Switching off seat heating:** Press lower switch position ② once more.
- ▶ **Switching on rapid seat heating:** Press upper switch position ①. Both red indicator lamps in the switch come on.
- ▶ **Switching off rapid seat heating:** Press upper switch position ① once more.

If one or both of the indicator lamps in the seat heating switch are flashing, there is insufficient voltage available since too many electrical consumers are turned on. The seat heating switches off automatically.

The seat heating will switch back on again automatically as soon as sufficient voltage is available.

Vehicles with seat ventilation



The red indicator lamps in the switch come on to show which heating level you have selected.

The seat heating switches from level 2 (rapid seat heating) to level 1 (normal seat heating) after approximately 8 minutes.

The seat heating automatically switches off after approximately 30 minutes.

- ▶ Switch on the ignition.
- ▶ **Switching on seat heating:** Press switch ①.
Both red indicator lamps in switch ① come on.
- ▶ **Switching off seat heating:** Press switch ① repeatedly until all red indicator lamps go out.

If one or both of the indicator lamps in the seat heating switch are flashing, there is insufficient voltage available since too many electrical consumers are turned on. The seat heating switches off automatically.

The seat heating will switch back on again automatically as soon as sufficient voltage is available.

AIRSCARF neck-level heating

The AIRSCARF neck-level heating provides the area surrounding the occupants' necks with a heated air stream flowing from openings in the head restraints.

Warning!

When switching on the AIRSCARF neck-level heating, the air streaming from the openings may be very hot. When in close proximity to the openings, you could be seriously burned. To help avoid serious personal injuries, switch the AIRSCARF to a lower heating level.



- ▶ Switch on the ignition.
- ▶ **Switching on:** Press AIRSCARF switch ① for the desired side.
All three indicator lamps on respective AIRSCARF switch ① come on. After a preheating time of approximately 10 seconds, the blower starts.
- ▶ Press AIRSCARF switch ① repeatedly until the desired AIRSCARF heating level for the corresponding seat is reached.
- ▶ **Switching off:** Press AIRSCARF switch ① repeatedly until all indicator lamps on AIRSCARF switch ① go out.

After switching off the AIRSCARF neck-level heating, the AIRSCARF fan continues to operate for approximately 7 seconds to cool down the heater elements.

Multifunction steering wheel

Safety notes

Warning!

Do not adjust the steering wheel while driving. Adjusting the steering wheel while driving could cause the driver to lose control of the vehicle.

The electrical steering wheel adjustment feature can be operated at any time. Therefore, do not leave children unattended in the vehicle, or with access to an unlocked vehicle. A child's unsupervised access to a vehicle could result in an accident and/or serious personal injury.

Make sure

- you can reach the steering wheel with your arms slightly bent at the elbows
- you can move your legs freely
- all displays (including malfunction and indicator lamps) on the instrument cluster are clearly visible

Steering wheel adjustment

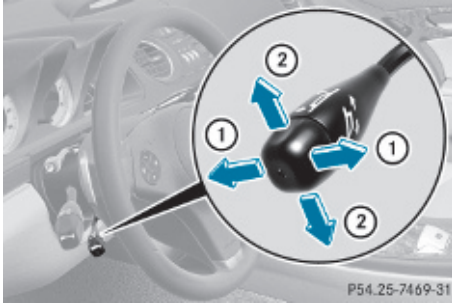

► **Adjusting steering wheel in or out:** Move stalk in direction of arrows ①.

► **Adjusting steering wheel up or down:** Move stalk in direction of arrows ②.

i The memory function (► page 88) lets you store the settings for the steering wheel together with the settings for the seat position and the exterior rear view mirrors.

Easy-entry/exit feature

This feature allows the driver an easier entry into and exit from the vehicle. When entering and exiting the vehicle, the steering wheel is in its uppermost position.

The easy-entry/exit feature can be activated or deactivated in the Convenience submenu of the control system (► page 127).

⚠ Warning!

You must make sure no one can become trapped or injured by the moving steering wheel when the easy-entry/exit feature is activated.

To stop steering wheel movement do one of the following:

- Move steering wheel adjustment stalk.
- Press one of the memory position buttons.
- Press memory button **M**.

Do not leave children unattended in the vehicle, or with access to an unlocked vehicle. Children could open the driver's door and unintentionally activate the easy-entry/exit feature, which could result in an accident and/or serious personal injury.

With the easy-entry/exit feature activated, the steering wheel will return to its last set position when you close the driver's door with the ignition switched on. The steering wheel will also return to its last set position when you insert the SmartKey into the starter switch or press the KEYLESS-GO start/stop button once with the driver's door closed.

i The last set steering wheel position is stored when the ignition is switched off or the position is stored in memory (► page 89).

With the easy-entry/exit feature activated, the steering wheel tilts upwards when you remove the SmartKey from the starter switch. The steering wheel also tilts upwards when you open the driver's door with the SmartKey in starter switch position **0** or **1** or the KEYLESS-GO start/stop button in position **1**.

i When the current position for the steering wheel is in the uppermost tilt position, the steering wheel will no longer be able to move upward when the easy-entry/exit feature is activated.

The adjustment procedure is briefly interrupted when the engine is started.

⚠ Warning!

Let the system complete the adjustment procedure before setting the vehicle in motion. All steering wheel adjustment must be completed before setting the vehicle in motion. Driving off with the steering wheel still adjusting could cause the driver to lose control of the vehicle.

Crash-responsive exit aid

When you open the driver's door after an accident has occurred, the steering column moves up. The position of the SmartKey in the starter switch is insignificant. This function facilitates exiting as well as rescue of vehicle occupants.

The crash-responsive exit aid can only be triggered when the easy-entry/exit feature is activated via the control system.

Mirrors

Notes

Adjust the interior and exterior rear view mirrors before driving so that you have a good view of the road and traffic conditions.

Interior rear view mirror

- ▶ Adjust the interior rear view mirror manually.

Exterior rear view mirrors

Warning!

Exercise care when using the passenger-side exterior rear view mirror. The mirror surface is convex (outwardly curved surface for a wider field of view). Objects in mirror are closer than they appear. Check your interior rear view mirror and glance over your shoulder before changing lanes.

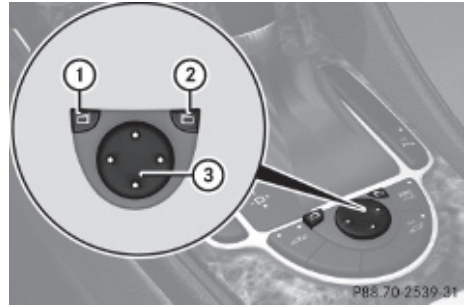

- i** You can store the settings for the exterior rear view mirror position with the memory function (▶ page 88).

- ▶ Switch on the ignition.
- ▶ Press button ① for the driver's side exterior rear view mirror or button ② for the passenger-side exterior rear view mirror.
- ▶ Press adjustment button ③ up, down, left or right according to the desired setting.
- !** If an exterior rear view mirror was forcibly hit from the front, manually snap it back into place.

- i** At low ambient temperatures, the exterior rear view mirrors will be heated automatically.

Auto-dimming rear view mirrors

The exterior rear view mirror on the driver's side and the interior rear view mirror will respond automatically to glare when the ignition is switched on and incoming light from headlamps falls on the sensor in the interior rear view mirror.

The rear view mirrors will not react if the automatic transmission is set to reverse gear **R** or the interior lighting is switched on.

Warning!

The auto dimming function does not react if incoming light is not aimed directly at sensors in the interior rear view mirror.

The interior rear view mirror and the exterior rear view mirror on the driver's side do not react, for example, if the wind screen is installed.

Light hitting the mirror(s) at certain angles (incident light) could blind you. As a result, you may not be able to observe traffic conditions and could cause an accident.

Exterior rear view mirror parking position

To assist during parking maneuvers, you can set the passenger-side exterior rear view mirror so that you can see the rear wheel and the road curb.

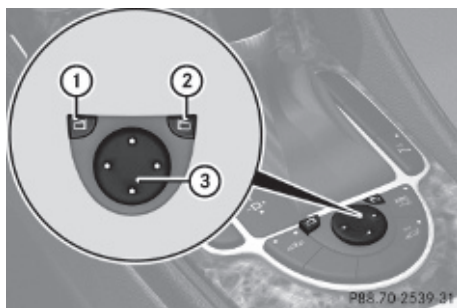
Setting and storing the parking position

- ▶ Switch on the ignition.
- ▶ Press button ②, to select the passenger-side exterior rear view mirror.
- ▶ Shift the automatic transmission into reverse gear **R**.
The passenger-side exterior rear view mirror moves to the preset parking position.
- ▶ Adjust the passenger-side exterior rear view mirror with adjustment button ③ so

that you see the rear wheel and the road curb.

The exterior rear view mirror parking position is stored.

You can also store the parking position using the memory button **M** (▷ page 89).

- ▶ Switch on the ignition.
- ▶ Press button ②, to select the passenger-side exterior rear view mirror.
- ▶ Adjust the passenger-side exterior rear view mirror with adjustment button ③ so that you see the rear wheel and the road curb.
- ▶ Press memory button **M** and within 3 seconds, press one of the arrows of adjustment button ③.
The parking position is stored if the exterior rear view mirror does not move.

i If the exterior rear view mirror does move, repeat the above steps. After the setting is stored, you can move the exterior rear view mirror again.

Calling up the parking position

- ▶ Switch on the ignition.
- ▶ Press button ②, to select the passenger-side exterior rear view mirror.
- ▶ Shift the automatic transmission into reverse gear **R**.
The passenger-side exterior rear view mirror moves to the stored parking position.

The passenger-side exterior rear view mirror returns to its previously stored driving position

- 10 seconds after you have put the gear selector lever out of reverse gear **R**
- immediately once your vehicle exceeds a speed of approximately 6 mph (10 km/h)
- immediately when you press button ① to select the driver's side exterior rear view mirror

Power-folding exterior rear view mirrors

This feature is only available in Canada vehicles.

! Before you drive the vehicle through an automatic car wash, fold in the exterior rear view mirrors. Otherwise they may get damaged.

Folding in and out automatically

The function must be activated in the Convenience submenu (▷ page 127).

The exterior rear view mirrors fold in automatically as soon as the vehicle is locked from the outside.

The exterior rear view mirrors fold out automatically as soon as the vehicle is unlocked and the driver's or front passenger door is subsequently opened.

Synchronizing

The power-folding rear view mirrors may have to be synchronized after the vehicle battery has been disconnected or discharged. If the exterior rear view mirrors do not fold properly upon locking or unlocking the vehicle, do the following:

- ▶ Make sure the power-folding function in the control system is activated (▷ page 127).
- ▶ Fold each exterior rear view mirror out completely (▷ page 88).

When the exterior rear view mirrors fold properly upon locking the vehicle, the exterior mirrors are synchronized. Otherwise repeat the above steps.

Folding in and out manually

The exterior rear view mirrors can vibrate if they are not folded out completely.

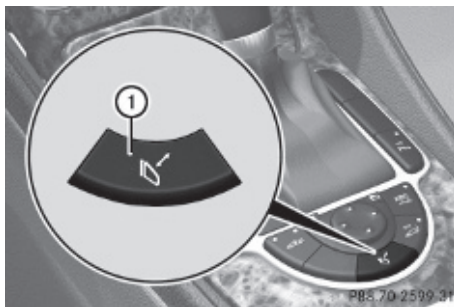

▶ **Folding in:** Briefly press button ①. Both exterior rear view mirrors fold in.

i At speeds above approximately 60 mph (100 km/h), you will not be able to fold the exterior mirrors in.

Memory function

Notes

With the memory function you can store up to three different configurations per front seat.

Each memory position button on the driver's side can store all of the following settings:

- Seat position and lumbar support
- Steering wheel position
- Exterior rear view mirrors' position

⚠ Warning!

Do not activate the memory function while driving. Activating the memory function while driving could cause the driver to lose control of the vehicle.

Each memory position button on the passenger side can store all of the following settings:

- Seat position and lumbar support
- Multicontour seat: previously saved settings



Storing positions into memory

- ▶ Adjust the seats.
- ▶ On the driver's side, also adjust the steering wheel and exterior rear view mirrors to the desired positions.
- ▶ Press memory button **M** once and within 3 seconds press memory position button **1**, **2** or **3**.

When the settings are stored to the selected position, an acknowledgement signal sounds.

Recalling positions from memory

- ▶ Press and hold desired memory position button **1**, **2** or **3** until the seat has moved to the stored position completely. On the driver's side, also wait for the steering wheel and exterior rear view mirrors to move to the stored position.

- i** Releasing the memory position button stops movement to the stored positions immediately.

Lighting

Notes

- i** If you drive in countries with left-hand driving, you must have the headlamps modified for symmetrical low beams.

Relevant information can be obtained at any authorized Mercedes-Benz Center.

- i** The active Bi-Xenon headlamps increase usable illumination over conventional headlamps because they follow the curvature of the road ahead. The beams of the active Bi-Xenon headlamps shift to either side according to the vehicle's steering angle and speed.

Exterior lamp switch

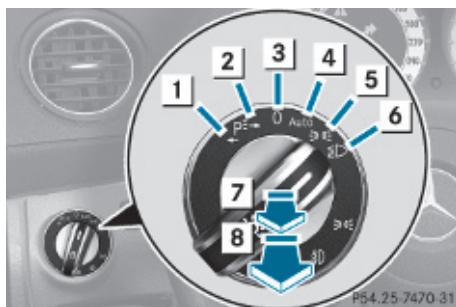

- 1** Standing lamps, left
- 2** Standing lamps, right
- 3** **0** Off
- 4** **AUTO** Automatic headlamp mode
Daytime running lamp mode
- 5** Parking lamps (also tail lamps, license plate lamps, side marker lamps and instrument panel lamps)
- 6** Low-beam headlamps or high-beam headlamps
- 7** Front fog lamps
- 8** Rear fog lamp

- i** The exterior lamps (except standing lamps or parking lamps) go out automatically when you remove the SmartKey from the starter switch or open the driver's door with the ignition switched off.

When the parking lamps or the rear fog lamp are switched on and you remove the

SmartKey from the starter switch and open the driver's door, an acoustic signal sounds.



In addition the message **Lights Are Still On** appears in the multifunction display.

Switch off the parking lamps or the rear fog lamp manually.

- ❗ Failure to switch off the parking lamps when leaving the vehicle may result in a discharged battery.

Low-beam headlamps

The low-beam headlamps can be switched on and off with the exterior lamp switch.

- ▶ Switch on the ignition.
- ▶ **Switching on:** Turn the exterior lamp switch to position .
 - The following lamps come on:
 - Low-beam headlamps
 - Tail lamps
 - Parking lamps
 - License plate lamps
 - Side marker lamps
 - Instrument panel lamps
 - Green indicator lamp  in the exterior lamp switch
- ▶ **Switching off:** Turn the exterior lamp switch to position .

Automatic headlamp mode



The following lamps come on and go out automatically depending on the brightness of the ambient light:

- Low-beam headlamps
- Tail lamps
- Parking lamps
- License plate lamps
- Side marker lamps

Warning!

If the exterior lamp switch is set to **AUTO**, the headlamps will not automatically come on under foggy conditions.

To minimize risk to you and to others, activate headlamps by turning exterior lamp switch to  when driving or when traffic and/or ambient lighting conditions require you to do so.

In low ambient lighting conditions, only switch from position **AUTO** to  with the vehicle at a standstill in a safe location. Switching from **AUTO** to  will briefly switch off the headlamps. Doing so while driving in low ambient lighting conditions may result in an accident.

The automatic headlamp feature is only an aid to the driver. The driver is responsible for the operation of the vehicle's lights at all times.

- ▶ **Switching on:** Turn the exterior lamp switch to position **AUTO**.

The following lamps come on and go out depending on the brightness of the ambient light with the SmartKey in starter switch position **1** or the KEYLESS-GO start/stop button pressed once:

- Tail lamps
- Parking lamps
- License plate lamps
- Side marker lamps



When the engine is running, the low-beam headlamps will also come on and turn off automatically.

Canada only: High-beam headlamps are only available with the exterior lamp switch in position .

Daytime running lamp mode

In Canada, the daytime running lamp mode is mandatory and therefore in a constant mode. In the USA, the daytime running lamp mode is deactivated by default.

► Activate the daytime running lamp mode using the control system, see “Switching daytime running lamp mode on or off (USA only)” (▷ page 124).

► Turn the exterior lamp switch to position  or .



When the engine is running, the low-beam headlamps come on.

In low ambient lighting conditions, the following lamps will come on additionally:

- Tail lamps
- Parking lamps
- License plate lamps
- Side marker lamps

With the daytime running lamp mode activated and the engine running, you cannot switch off the low-beam headlamps manually.



Canada only

With the exterior lamp switch in position  or , you cannot switch on the high-beam headlamps.

The high-beam flasher is available at all times.

► For nighttime driving turn the exterior lamp switch to position  to permit activation of the high-beam headlamps.



When the engine is running, and you

- shift from a driving position to neutral position **N** or park position **P** with the vehicle at a standstill, the low-beam headlamps will go out with a delay of 3 minutes
- turn the exterior lamp switch to position , the low-beam headlamps, the tail and parking lamps, the license plate lamps and the side marker lamps come on
- turn the exterior lamp switch to position , the manual headlamp mode has priority over the daytime running lamp mode

The corresponding exterior lamps come on (▷ page 89).

USA only



You can only switch on the high-beam headlamps in low ambient lighting conditions. The high-beam flasher is available at all times.



When the engine is running, and you turn the exterior lamp switch to position  or , the manual headlamp mode has priority over the daytime running lamp mode. The corresponding exterior lamps come on (▷ page 89).

Fog lamps





Fog lamps cannot be switched on with the exterior lamp switch in position .

Warning!

In low ambient lighting or foggy conditions, only switch from position  to  with the vehicle at a standstill in a safe location.

Switching from  to  will briefly switch off the headlamps. Doing so while driving in low ambient lighting conditions may result in an accident.

Fog lamps will operate with the parking lamps and/or the low-beam headlamps on. Fog lamps should only be used in conjunction with low-beam headlamps. Consult your State or Province Motor Vehicle Regulations regarding permissible lamp operation.

- Switch on the ignition.
- Turn the exterior lamp switch to position  or  (▷ page 89).
- **Switching on front fog lamps:** Pull out the exterior lamp switch to first stop. The green indicator lamp  in the exterior lamp switch comes on.
- **Switching on rear fog lamp:** Pull out the exterior lamp switch to second stop. The rear fog lamp, the front fog lamps, the green  and the yellow indicator lamp  in the exterior lamp switch come on.
- **Switching off front fog lamps/rear fog lamp:** Push in the exterior lamp switch to its stop.

Locator lighting and night security illumination

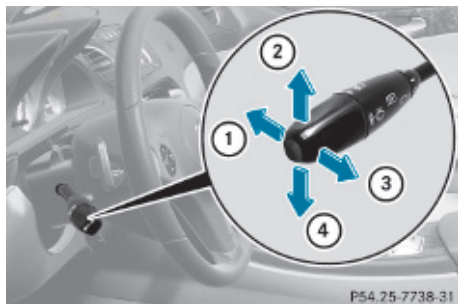

Locator lighting and night security illumination are described in the “Control system” section, see “Switching locator lighting on or off” (▷ page 125) and “Switching night security illumination (Headlamps delayed shut-off feature) on or off” (▷ page 125).

Combination switch



Turn signals

- ▶ Press the combination switch in direction of arrow ② or ④.

The corresponding turn signal indicator lamp  or  in the instrument cluster flashes.

The combination switch resets automatically after major steering wheel movements.

To signal minor directional changes:

- ▶ Press the combination switch only to the point of resistance in direction of arrow ② or ④ and release.

The corresponding turn signal lamps will flash three times.

High beam

- ▶ Turn the exterior lamp switch to position  (▷ page 89).

- ▶ **Switching on:** Push the combination switch in direction of arrow ①.

The high-beam headlamp indicator lamp  in the instrument cluster comes on.

- ▶ **Switching off:** Pull the combination switch in direction of arrow ③ to its original position.

i Also note the information on high-beam headlamps with activated automatic headlamp mode (▷ page 90) or the daytime running lamp mode (▷ page 90).

High-beam flasher

- ▶ **Switching on:** Pull the combination switch briefly in direction of arrow ③.

Hazard warning flasher

The hazard warning flasher can be switched on at all times, even with the SmartKey removed from the starter switch.

The hazard warning flasher comes on automatically when an air bag deploys.

The hazard warning flasher switch is located on the upper part of the center console.



- ▶ **Switching on:** Press hazard warning flasher switch ①.
All turn signal lamps are flashing.
- ❗ With the hazard warning flasher activated and the combination switch set for either left or right turn, only the respective left or right turn signals will operate when the ignition is switched on.
- ▶ **Switching off:** Press hazard warning flasher switch ① again.
- ❗ If the hazard warning flasher has been activated automatically, press hazard warning flasher switch ① to switch it off.

Headlamp cleaning system



- ▶ Switch on the ignition.
 - ▶ Press headlamp cleaning button ①.
The headlamps are cleaned with a high-pressure water jet.
- The headlamps will be cleaned automatically when you have
- switched on the headlamps
and
 - the windshield wipers have wiped the windshield with washer fluid fifteen times
- The counter resets when you switch off the ignition.
- For information on filling up the washer reservoir, see “Washer system and headlamp cleaning system” (▷ page 185).

Corner-illuminating lamps

The corner-illuminating lamps improve illumination of the area in the direction into which you are turning.

The corner-illuminating lamps will only operate in low ambient lighting conditions. If you are driving faster than 25 mph (40 km/h) the corner-illuminating function is not available.

Switching on

- ▶ Make sure the engine is running.
 - ▶ Turn the exterior lamp switch to position  or **AUTO** (▷ page 89).
- or
- ▶ Activate the daytime running lamp mode (▷ page 90).
 - ▶ Switch on the left or right turn signal, depending on whether you are turning left or right.
- The respective corner-illuminating lamp comes on. If you have switched on the turn signal for one side but turn the steering wheel in the other direction, the corner-illuminating lamp comes on on the side of the turn signal.

or

- ▶ Turn steering wheel in desired direction.
- Driving forward: The corner-illuminating lamp on the side of your steering direction comes on.
- Driving in reverse: The corner-illuminating lamp opposite to your steering direction comes on.

The corner-illuminating lamps will come on automatically depending on the steering angle, even if you did not switch on either turn signal. If the corner-illuminating lamps came on automatically, they will also go out automatically depending on the steering angle and vehicle speed.

The corner-illuminating lamps temporarily come on on both sides of the vehicle if you turn the steering wheel in one direction and

then again in the other direction shortly thereafter.

The corner-illuminating lamp remains lit for a short time only. It then goes out automatically.

Switching off

► Switch off the left or right turn signal.

or

► Steer straight ahead.





The corner-illuminating lamp goes out.

i There may be a brief delay before the corner-illuminating lamps go out.

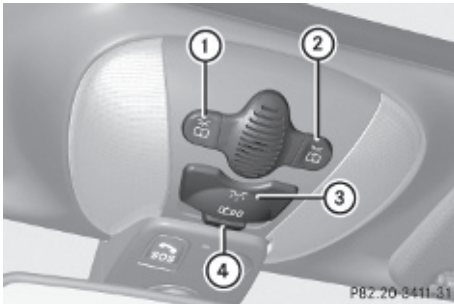
Interior lighting

The interior lighting controls are located in the overhead control panel.



- ①  Left reading lamp on/off
- ②  Right reading lamp on/off
- ③  Interior lighting on/off
- ④  Slide switch for automatic control

Automatic control

► **Activating:** Slide switch ④ to the left.

The interior lighting and the entry/exit lamps come on in darkness, when you

- unlock the vehicle
- remove the SmartKey from the starter switch (Interior Lighting Delayed Switch-off must be switched on (► page 126))

- open a door
- open the trunk

The interior lighting goes out after a short time.

i If a door remains open, the interior lamps go out automatically after approximately 5 minutes.

► **Deactivating:** Slide switch ④ to the right.

Manual control

! An interior lamp switched on manually does not go out automatically.

Leaving an interior lamp switched on for an extended period of time with the engine turned off could result in a discharged battery.

► **Switching interior lighting on/off:** Press switch .

► **Switching reading lamps on/off:** Press respective switch .

Courtesy lighting

For better orientation in the dark, courtesy lamps will illuminate the interior of your vehicle as follows:

With parking lamps switched on:

- the door handles
- the driver and passenger footwells

With SmartKey in starter switch position **1**:

- the door handles
- the center console

i If you turn the SmartKey in the starter switch to position **0** and switch off the headlamps, the door handle lamps will remain lit for approximately 5 minutes.

Wipers

Notes

- ❗ Do not operate the wipers when the windshield is dry. Dust that accumulates on a windshield might scratch the glass and/or damage the wiper blades when wiping occurs on a dry windshield. If it is necessary to operate the wipers in dry weather conditions, always operate the wipers with washer fluid.

Windshield wipers

- ▶ Observe notes on page (▷ page 95).

Switching on/off

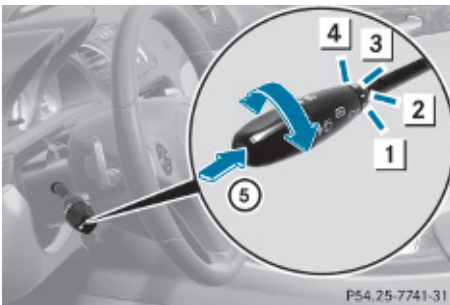

Combination switch

- 1 0 Windshield wipers off
- 2 I Intermittent wiping
- 3 II Slow continuous wiping
- 4 III Fast continuous wiping
- 5 Single wipe/ Wiping with washer fluid

- ▶ Switch on the ignition.
- ▶ Turn the combination switch to the desired position, depending on the intensity of the rain.

Intermittent wiping

Only switch on intermittent wiping under wet weather conditions or in the presence of precipitation.

When you select intermittent wiping, the rain sensor is activated. The rain sensor sets a suitable wiping interval depending on the wetness of the sensor surface automatically.

- ❗ Do not leave windshield wipers on an intermittent setting when the vehicle is taken to an automatic car wash or during windshield cleaning. Windshield wipers will operate in the presence of water sprayed on the windshield, and windshield wipers may be damaged as a result.

- ❗ If you have set intermittent wiping, dirt on the surface of the rain sensor or optical effects may cause the windshield wipers to wipe in an undesired fashion. This could then damage the windshield wiper blades or scratch the windshield. You should therefore switch off the windshield wipers when weather conditions are dry.

Intermittent wiping interval is dependent on the wetness of the windshield. After the initial wipe, pauses between wipes are controlled by the rain sensor automatically.

- ▶ Turn the combination switch to position I. Intermittent wiping is interrupted when the vehicle is at a standstill and a door is opened. This protects persons getting into or out of the vehicle from being sprayed.

Intermittent wiping will be continued when all doors are closed and

- the automatic transmission is in drive position **D** or reverse gear **R** or
- the wiper setting is changed using the combination switch

Single wipe

- ▶ Press the combination switch briefly in direction of arrow ⑤ to the resistance point. The windshield wipers wipe one time without washer fluid.

Wiping with washer fluid

- ▶ Press the combination switch in direction of arrow ⑤ past the resistance point. The windshield wipers operate with washer fluid.

i To prevent smears on the windshield or noisy/chattering wiper blades, wipe with washer fluid every now and then even when it is raining.

For information on filling up the washer reservoir, see “Washer system and headlamp cleaning system” (▷ page 185).

For information on cleaning the headlamps with washer fluid, see “Headlamp cleaning system” (▷ page 93).

Problems with wipers

! If anything blocks the windshield wipers (leaves, snow, etc.), switch them off immediately.

For safety reasons, do the following before attempting to remove any blockage:

- Stop the vehicle in a safe location.
- Remove the SmartKey from the starter switch.
or
- Turn off the engine by pressing the KEYLESS-GO start/stop button and open the driver’s door (with the driver’s door open, starter switch is in position **0**, same as with SmartKey removed from starter switch).
- Engage the parking brake.
- Remove blockage.
- Turn the windshield wipers on again.

If the windshield wipers fail to function at all with the combination switch in position **I**,

- set the combination switch to the next higher wiper speed
- have the windshield wipers checked at the nearest authorized Mercedes-Benz Center

Power windows

Opening and closing

The windows are opened and closed electrically. The switches for all windows are located on the driver’s door. The switch for operating the passenger-side windows is located on the passenger door.

 **Observe Safety notes, see page 51.**

Warning!

When closing the windows, make sure there is no danger of anyone being harmed by the closing procedure.

The door windows are equipped with the express operation and automatic reversal function. If in express operation mode a door window encounters an obstruction that blocks its path, the automatic reversal function will stop the door window and open it slightly.

The door windows operate differently when the switch is pulled and held. See the “Closing when a door window is blocked” section for details.

The closing of the door windows can be immediately halted by releasing the switch or, if the switch was pulled past the resistance point and released, by pressing or pulling the respective switch.

The closing of the rear side windows can be immediately halted by releasing the switch.

If a window encounters an obstruction that blocks its path in a circumstance where you are closing the windows by pressing and

holding button  on the SmartKey or by pressing and holding the lock button (vehicles with KEYLESS-GO) on an outside door handle, the automatic reversal function will not operate.

- i** You can also open or close the windows using the SmartKey, see “Summer opening feature” (▷ page 156) and “Convenience closing feature” (▷ page 156).
- i** After switching off the ignition or removing the SmartKey from the starter switch, you can operate the windows until you open a door. If no door was opened you can operate the windows for up to 5 minutes.



Door windows

- i** When you open the door windows while the hardtop is open, the rear side windows will also open automatically.
- ▶ Switch on the ignition.
- ▶ **Opening/closing:** Press or pull and hold switch ① or ② to the resistance point. The corresponding door window moves downward or upward until you release the switch.

- ▶ **Express operation:** Press or pull switch ① or ② past the resistance point and release. The corresponding door window opens or closes completely.
- ▶ **Stopping during express operation:** Press or pull the respective switch again.

Closing when a door window is blocked

Warning!

Make sure that nobody can become trapped and be seriously or even fatally injured when closing a door window with greater force or without automatic reversal function.

If the upward movement of a door window is blocked during the closing procedure, the door window will stop and open slightly.

- ▶ Immediately after the door window has stopped because it was blocked, pull and hold the respective switch upward until the door window is fully closed. The door window closes with greater force.

If the door window is blocked again and opens slightly:

- ▶ Immediately after the door window was blocked, pull and hold the respective switch upward until the door window is fully closed. The door window closes without automatic reversal function.

Warning!

Pulling and holding the switch to close the door window immediately after it had been blocked two times will cause the door window to close without any reversal function for as long as you hold the switch.

Opening and closing the rear side windows

- ▶ **Opening:** Open the door window.
- ▶ Press switch ① or ② again. The corresponding rear side window will open completely.

- ▶ **Closing:** Close the door window.
- ▶ Pull and hold switch ① or ②.
The corresponding rear side window moves upward until you release the switch.

Closing with KEYLESS-GO

When locking the vehicle, you can simultaneously close the windows.

- ▶ Press and hold the lock button on an outside door handle (▷ page 71) until the windows are completely closed.
- ▶ Release the lock button on the outside door handle to interrupt the closing procedure.

Synchronizing power windows

The windows must be synchronized after the battery has been disconnected or if the windows cannot be fully closed (express operation).

Each window must be synchronized separately.

- ▶ Close all doors.
- ▶ Switch on the ignition.
- ▶ Pull and hold switch ① or ② (▷ page 97) until the respective window is closed. The window opens again slightly.
- ▶ Pull and hold the respective switch once more immediately until the window is closed completely.
- ▶ Hold the respective switch for approximately 1 second. The window is synchronized.

Driving and parking

Safety notes

Warning!

Make sure absolutely no objects are obstructing the pedals' range of movement. Keep the driver's footwell clear of all obstacles. If there are any floor mats or

carpets in the footwell, make sure the pedals still have sufficient clearance.

During sudden driving or braking maneuvers the objects could get caught between or under the pedals. You could then no longer brake or accelerate. This could lead to accidents and injury.

Warning!

With the engine not running, there is no power assistance for the brake and steering systems. In this case, it is important to keep in mind that a considerably higher degree of effort is necessary to brake and steer the vehicle. Adapt your driving accordingly.

Starting the engine

Warning!

Inhalation of exhaust gas is hazardous to your health. All exhaust gas contains carbon monoxide (CO), and inhaling it can cause unconsciousness and possible death.

Do not run the engine in confined areas (such as a garage) which are not properly ventilated. If you think that exhaust gas fumes are entering the vehicle while driving, have the cause determined and corrected immediately. If you must drive under these conditions, drive only with at least one window fully open at all times.

Automatic transmission

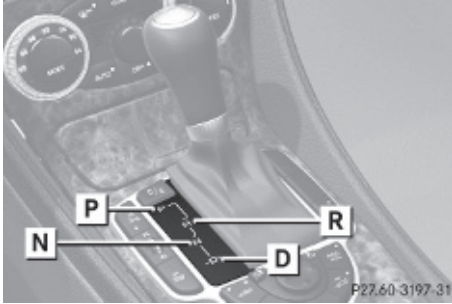

Gearshift pattern for automatic transmission

- P** Park position with gear selector lever lock
- R** Reverse gear
- N** Neutral position
- D** Drive position

For more information, see “Automatic transmission” (▷ page 103).

- ▶ Make sure the automatic transmission is in park position **P**.

With SmartKey

- ▶ Do not depress the accelerator pedal.
- ▶ Turn the SmartKey in the starter switch to position **3** (▷ page 78) and release it. The engine starts automatically.

With KEYLESS-GO

Warning!

As long as the SmartKey is in your vehicle, the vehicle can be started. Therefore, never leave children unattended in the vehicle, as they could otherwise accidentally start the engine.

When leaving the vehicle, always take the SmartKey with you and lock the vehicle. Do not leave children unattended in the vehicle, or with access to an unlocked vehicle. A child's unsupervised access to a vehicle could result in an accident and/or serious personal injury.

You can start your vehicle without the SmartKey in the starter switch using the KEYLESS-GO start/stop button.

The SmartKey must be located in the vehicle.

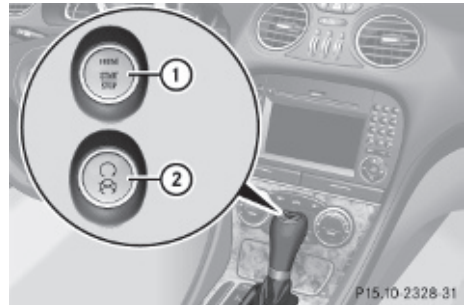

KEYLESS-GO start/stop button

- ① USA only
- ② Canada only

- ▶ Depress the brake pedal during the starting procedure.
- ▶ Do not depress the accelerator pedal.
- ▶ Press the KEYLESS-GO start/stop button once. The engine starts automatically.

Starting difficulties

- Remember that extended starting attempts can drain the battery.

The engine does not start. You can hear the starter.

There could be a malfunction in the engine electronics or in the fuel supply system.

Carry out the following steps:

- ▶ If you are starting the engine with the SmartKey: Turn the SmartKey in the starter

switch to position **0** and repeat the starting procedure.

- ▶ If you are starting the engine with KEYLESS-GO: Close any doors that may be open to allow for better detection of the SmartKey.

or

- ▶ Start the engine with the SmartKey as radio signals from another source may be interfering with the KEYLESS-GO function.
- ▶ Repeat the starting procedure.

If the engine does not start after several starting attempts:

- ▶ Contact an authorized Mercedes-Benz Center or call Roadside Assistance.

The engine does not start. You cannot hear the starter.

The battery may not be charged sufficiently.

- ▶ Get a jump start (▷ page 285).

If the engine will not start despite a jump start:

- ▶ Contact an authorized Mercedes-Benz Center or call Roadside Assistance.

The starter has been exposed to excessive temperatures.

- ▶ Let the starter cool for about 2 minutes.
- ▶ Repeat the starting procedure.

If the engine does not start after several starting attempts:

- ▶ Contact an authorized Mercedes-Benz Center or call Roadside Assistance.

Driving off

Warning!

On slippery road surfaces, never downshift in order to obtain braking action. This could result in drive wheel slip and reduced vehicle control. Your vehicle's ABS will not prevent this type of loss of control.

- ❗ Do not run a cold engine at high engine speeds. Running a cold engine at high engine speeds may shorten the service life of the engine. This is not covered by the Mercedes-Benz Limited Warranty.

SL 63 AMG: At engine temperatures below 68°F (20°C), the engine's maximum speed is restricted in order to protect it from damage. Avoid driving your vehicle at full speed when the engine is cold to prevent premature engine wear and/or diminished comfort.

- ❗ If an acoustic warning sounds and the message **Release Parking Brake** appears in the multifunction display when driving off, you have forgotten to release the parking brake.

Release the parking brake.

- ❗ Avoid spinning of a drive wheel. This may cause serious damage to the drivetrain which is not covered by the Mercedes-Benz Limited Warranty.

- ❗ Simultaneously depressing the accelerator pedal and applying the brakes reduces engine performance and causes premature brake and drivetrain wear which is not covered by the Mercedes-Benz Limited Warranty.

- i Once the vehicle is in motion, the automatic central locking function engages and the locking knobs in the doors move down.

The automatic central locking function can be switched off (▷ page 126).

Automatic transmission

Warning!

It is dangerous to shift the automatic transmission out of park position **P** or neutral position **N** if the engine speed is higher than idle speed. If your foot is not firmly on the brake pedal, the vehicle could accelerate

quickly forward or in reverse. You could lose control of the vehicle and hit someone or something. Only shift into gear when the engine is idling normally and when your right foot is firmly on the brake pedal.

! Only shift the automatic transmission into reverse gear **R** or park position **P** when the vehicle is stopped. Otherwise the automatic transmission could be damaged.

- ▶ Depress the brake pedal.
The gear selector lever lock is released.
- ▶ Shift the automatic transmission into drive position **D** or reverse gear **R**.

i Shifting the automatic transmission out of park position **P** is only possible with the brake pedal depressed.

Only depressing the brake pedal releases the gear selector lever lock.

- ▶ Wait for the gear selection process to complete before setting the vehicle in motion.
- ▶ If engaged, release the parking brake.
- ▶ Release the brake pedal.
- ▶ Carefully depress the accelerator pedal.

After a cold start, the automatic transmission shifts at a higher engine speed. This allows the catalytic converter to reach its operating temperature earlier.

For more information on driving, see “Driving instructions” (▷ page 209).

Problems while driving

The engine runs erratically and misfires

- An ignition cable may be damaged.
- The engine electronics may not be operating properly.
- Unburned gasoline may have entered the catalytic converter and damaged it.

- ▶ Give very little gas.
- ▶ Have the problem checked at an authorized Mercedes-Benz Center as soon as possible.

The coolant temperature is above 248°F (120°C)

The coolant is too hot and is no longer cooling the engine.

- ▶ Stop the vehicle in a safe location as soon as possible.
- ▶ Turn off the engine immediately.
- ▶ Allow the engine and coolant to cool off.
- ▶ Check the coolant level and add coolant if necessary (▷ page 184).

In case of accident

If the vehicle is leaking fuel:

- ▶ Do not start the engine under any circumstances.
- ▶ Exit the vehicle at a safe distance from the roadway.
- ▶ Notify local fire and/or police authorities.

If the extent of the damage cannot be determined:

- ▶ Contact an authorized Mercedes-Benz Center or call Roadside Assistance.

If no damage on major assemblies, fuel system, and engine mount can be determined:

- ▶ Start the engine in the usual manner.

Parking

Warning!

Do not park this vehicle in areas where combustible materials such as grass, hay or leaves can come into contact with the hot exhaust system. These materials could be ignited and cause a vehicle fire.

Vehicle movement may result in serious personal injury or damage to the vehicle or vehicle drivetrain. Therefore, always do the following before turning off the engine and leaving the vehicle:

- Keep right foot on the brake pedal.
- Engage the parking brake.
- Shift the automatic transmission into park position **P**.
- Slowly release the brake pedal.
- When parked on an incline, always turn the front wheels towards the road curb.
- Turn the SmartKey in the starter switch to position **0** and remove the SmartKey from the starter switch, or press the KEYLESS-GO start/stop button.
- Take the SmartKey with you and lock the vehicle when leaving.

Parking brake





Warning!

Engaging the parking brake while the vehicle is in motion can cause the rear wheels to lock up. You could lose control of the vehicle and cause an accident. In addition, the vehicle's brake lights do not light up when the parking brake is engaged.

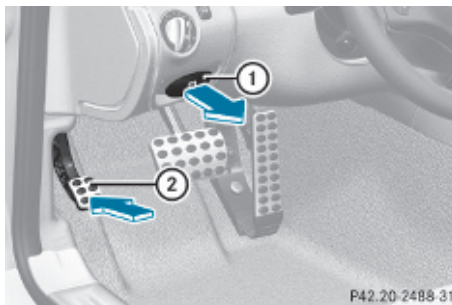
Warning!

When leaving the vehicle, always remove the SmartKey from the starter switch, take it with you, and lock the vehicle. Do not leave children unattended in the vehicle, or with access to an unlocked vehicle. Children could release the parking brake and/or shift the automatic transmission out of park position **P**, either of which could result in an accident and/or serious personal injury.



- ▶ **Releasing:** Pull on release handle ①. When the ignition is switched on or the engine is running, the brake warning lamp  (USA only) or  (Canada only) in the instrument cluster goes out.
- ▶ **Engaging:** Step on parking brake pedal ② firmly. When the engine is running, the brake warning lamp  (USA only) or  (Canada only) in the instrument cluster comes on.

Turning off the engine

Warning!

Do not turn off the engine before the vehicle has come to a complete stop. With the engine not running, there is no power assistance for the brake and steering systems. In this case, it is important to keep in mind that a considerably higher degree of effort is necessary to brake and steer the vehicle.

- ▶ Shift the automatic transmission into park position **P**.
- ▶ Engage the parking brake.
- ▶  Always engage the parking brake in addition to shifting the automatic transmission into park position **P**.

With SmartKey

- ▶ Turn the SmartKey in the starter switch to position **0**.

- ▶ Remove the SmartKey from the starter switch.

The SmartKey can only be removed from the starter switch with the automatic transmission in park position **P**.

With KEYLESS-GO

- ▶ Press the KEYLESS-GO start/stop button. With the driver's door closed, the starter switch is now in position **1**. With the driver's door opened, the starter switch is set to position **0**, same as the SmartKey removed from the starter switch (▷ page 78).

If an acoustic warning sounds, you have tried to turn off the engine with the KEYLESS-GO start/stop button while the automatic transmission was not in park position **P**.

Read and observe messages that may appear in the multifunction display (▷ page 234).

Automatic transmission

Introduction

For information on driving with an automatic transmission, see "Driving and parking" (▷ page 98).

Warning!

Make sure absolutely no objects are obstructing the pedals' range of movement. Keep the driver's footwell clear of all obstacles. If there are any floor mats or carpets in the footwell, make sure the pedals still have sufficient clearance.

During sudden driving or braking maneuvers the objects could get caught between or under the pedals. You could then no longer brake or accelerate. This could lead to accidents and injury.

-  Allow the engine to warm up under low load use. Do not place full load on the engine until the operating temperature has been reached.

Avoid spinning of a drive wheel for an extended period when driving off on slippery road surfaces.

This may cause serious damage to the engine and the drivetrain which is not covered by the Mercedes-Benz Limited Warranty.

-  During the brief warm-up, transmission upshifting is delayed. This allows the catalytic converter to heat up more quickly to operating temperature.

Gear selector lever

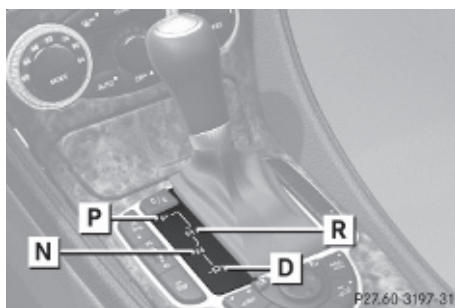

Gearshift pattern for automatic transmission

- P** Park position with gear selector lever lock
- R** Reverse gear
- N** Neutral position
- D** Drive position

Warning!

It is dangerous to shift the automatic transmission out of park position **P** or neutral position **N** if the engine speed is higher than idle speed. If your foot is not firmly on the brake pedal, the vehicle could accelerate quickly forward or in reverse. You could lose control of the vehicle and hit someone or something. Only shift into gear when the engine is idling normally and when your right foot is firmly on the brake pedal.

-  Only shift the automatic transmission into reverse gear **R** or park position **P** when the

vehicle is stopped. Otherwise the automatic transmission could be damaged.

- ❶ Shifting the automatic transmission out of park position **P** is only possible with the brake pedal depressed.

Only depressing the brake pedal releases the gear selector lever lock.

- ❶ The current gear selector lever position corresponds with the current transmission position.

The current transmission position **P**, **R**, **N**, or **D** appears in the right multifunction display (▷ page 104).

There are additional indicators on the cover of the shifting gate showing the current gear selector lever position.

The indicators come on when you insert the SmartKey into the starter switch, and go out when you remove the SmartKey from the starter switch.

Shifting procedure

The automatic transmission selects individual gears automatically, depending on

- the selected gear range (▷ page 106)
- the selected program mode:

C/S (▷ page 106)

or

M (vehicles with AMG Sport Package, SL 63 AMG and SL 65 AMG only)

(▷ page 109)

- the position of the accelerator pedal
- the vehicle speed

With drive position **D** selected, you can influence transmission shifting by

- limiting the gear range
- extending the gear range
- changing the gears manually (vehicles with AMG Sport Package, SL 63 AMG and SL 65 AMG only)

SL 63 AMG: Double-clutching is active when downshifting in all program modes. Double-clutching reduces load-alteration effects and supports sporty driving. The degree to which you perceive double-clutching acoustically varies depending on the selected program mode.

Transmission positions

The current transmission position appears in the right multifunction display.

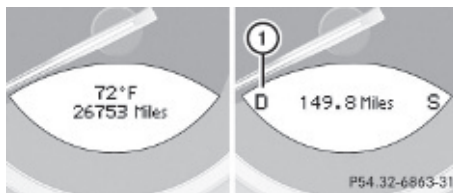

- ❶ Transmission position indicator

	Effect
P	<p>Park position</p> <p>Shift the automatic transmission into park position P only when the vehicle is stopped. The park position is not intended to serve as a brake when the vehicle is parked. Rather, the driver should always engage the parking brake in addition to shifting the automatic transmission into park position P to secure the vehicle.</p> <p>The SmartKey can only be removed from the starter switch with the gear selector lever in park position P. With the SmartKey removed from the starter switch, the gear selector lever is locked in park position P. If the vehicle's electrical system is malfunctioning, the gear selector lever could remain locked in park position P.</p> <p>► Have the vehicle's electrical system checked at an authorized Mercedes-Benz Center as soon as possible.</p>
R	<p>Reverse gear</p> <p>Shift the automatic transmission into reverse gear R only when the vehicle is stopped.</p>

	Effect
N	<p>Neutral position</p> <p>No power is transmitted from the engine to the drive axle. When the brakes are released, the vehicle can be moved freely (pushed or towed).</p> <p>To avoid damage to the transmission, never shift the automatic transmission into neutral position N while driving.</p> <p>Exception: If the ESP® is switched off or malfunctioning, shift the automatic transmission into neutral position N if the vehicle is in danger of skidding.</p> <p>! Coasting the vehicle, or driving for any other reason with the automatic transmission in neutral position N can result in transmission damage that is not covered by the Mercedes-Benz Limited Warranty.</p>
D	<p>Drive position</p> <p>The automatic transmission shifts automatically. All forward gears are available.</p>

Driving tips

Kickdown

Use the kickdown when you want maximum acceleration.

► **U.S. vehicles except AMG vehicles:**

Fully depress the accelerator pedal. Depending on the engine speed the automatic transmission shifts into a lower gear.

► **Canada vehicles and AMG vehicles:**

Depress the accelerator pedal past the point of resistance. Depending on the engine speed the automatic transmission shifts into a lower gear.

Working on the vehicle

Warning!

When working on the vehicle, engage the parking brake and shift the automatic transmission into park position **P**. Otherwise the vehicle could roll away which could result in an accident and/or serious personal injury.

Gear ranges

With the automatic transmission in drive position **D** and driving in automatic program mode **C** or **S**, you can limit or extend the gear range, see “One-touch gearshifting” (▷ page 108).

The current gear range appears in the right multifunction display.

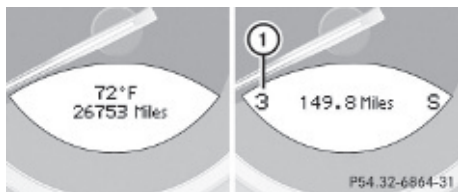

① Gear range indicator

	Effect
3	With this selection you can use the braking effect of the engine.
2	Allows the use of the engine's braking effect when driving <ul style="list-style-type: none"> • on steep downgrades • in mountainous regions • under extreme operating conditions
1	For maximum use of the engine's braking effect on very steep or lengthy downgrades.

Automatic shift program

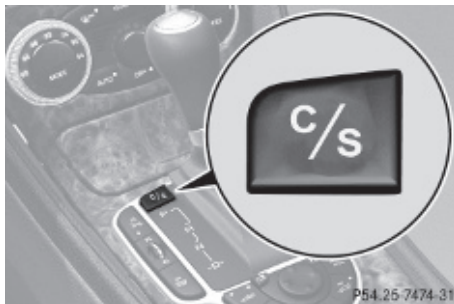

Program mode selector switch

C Comfort	For comfort driving
S Sport	For sporty driving



Program mode selector switch on vehicles with AMG Sport Package.

C Comfort	For comfort driving
S Sport	For sporty driving
M Manual	For manual gearshifting (▷ page 109)



Program mode selector dial on SL 63 AMG

C Comfort	For standard driving
S Sport	For sporty driving
S+ Sport Plus	For sporty driving with shorter shift times
M Manual	For manual gearshifting (▷ page 109)
RS RACE START	For optimum acceleration from a standing start

- i** Program mode **RS** cannot be selected while driving. For more information, see “RACE START (SL 63 AMG)” (▷ page 141).



Program mode selector switch on SL 65 AMG

C Comfort	For comfort driving
S Sport	For standard driving
M MANUAL	For manual gearshifting (▷ page 109)

The current program mode appears in the right multifunction display.

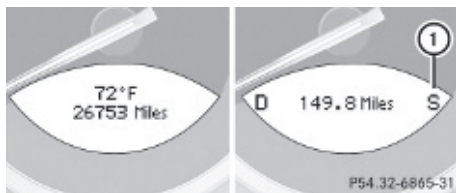

- ① Program mode indicator

- i** **SL 63 AMG:** In addition, the currently selected program mode is indicated in red on the program mode selector dial.

You should only change the program mode when the automatic transmission is in park position **P**.

Automatic program mode **S** will not be stored. When the engine is turned off with the automatic program mode **S** selected, the automatic transmission will go to the automatic program mode **C** when the engine is restarted.

SL 63 AMG: Automatic program mode **S+** will not be stored. When the engine is turned off with automatic program mode **S+** selected, the automatic transmission will go to automatic program mode **C** when the engine is restarted.

- ▶ **All models except SL 63 AMG:** Press the program mode selector switch repeatedly until the letter of the desired program mode appears in the right multifunction display.
- ▶ **SL 63 AMG:** Turn the program mode selector dial until the letter of the desired program mode appears in the right multifunction display.

Selecting program mode **C** means:

- The vehicle starts out more gentle, both forward and reverse, except when driving off with full throttle.
- Traction and driving stability are improved on icy roads.
- Upshifts occur earlier even when you give more gas. The engine then operates at lower revolutions and the wheels are less likely to spin.

Selecting program mode **S** means that upshifts occur later.

One-touch gearshifting

With the automatic transmission in drive position **D** and driving in automatic program mode **C** or **S**, you can limit or extend the gear range using the gear selector lever or the steering wheel gearshift control.

SL 63 AMG and SL 65 AMG: For information on using the gear selector lever or the steering wheel gearshift control in manual program mode **M**, see “Manual shift program” (▷ page 109).



Steering wheel gearshift control (example illustration)

- i** You cannot shift with the steering wheel gearshift control when the automatic transmission is in park position **P**, neutral position **N**, or reverse gear **R**.

Limiting gear range

Warning!

On slippery road surfaces, never downshift in order to obtain braking action. This could result in drive wheel slip and reduced vehicle control. Your vehicle's ABS will not prevent this type of loss of control.

- ▶ Briefly press the gear selector lever to the left in the **D-** direction.

or

- ▶ Briefly pull left gearshift control ①. The automatic transmission will shift into the next lower gear as permitted by the shift program. This action simultaneously limits the gear range of the automatic transmission.

- i** To avoid overrevving the engine when downshifting, the automatic transmission will not shift into a lower gear if the engine's maximum speed would be exceeded.

Extending gear range

- ▶ Briefly press the gear selector lever to the right in the **D+** direction.

or

- ▶ Briefly pull right gearshift control ②. The automatic transmission will shift into the next higher gear as permitted by the shift program. This action simultaneously extends the gear range of the automatic transmission.

- i** If you press on the accelerator pedal when the engine has reached the revolution limit of the current gear range, the automatic transmission will upshift beyond any gear range limit selected.

Canceling gear range limit

- ▶ Press and hold the gear selector lever to the right in the **D+** direction until **D**

reappears in the right multifunction display.

or

- ▶ Pull and hold right gearshift control ② until D reappears in the right multifunction display.

The automatic transmission will shift from the current gear range directly into drive position **D**.

Shifting into optimal gear range

- ▶ Press and hold the gear selector lever to the left in the **D**-direction.

or

- ▶ Pull and hold left gearshift control ①. The automatic transmission will select the gear range suited for optimal acceleration and deceleration automatically. This will involve shifting down one or more gears.

Manual shift program

The manual shift program is available on vehicles with AMG Sport Package, SL 63 AMG and SL 65 AMG only.

Manual program mode **M** differs with regard to spontaneity, response time, and shifting smoothness from automatic program modes **S** or **S+** (SL 63 AMG only).

In manual program mode **M**, system-controlled automatic gearshifting is switched off. You need to change the gears by manually upshifting or downshifting using the gear selector lever or the steering wheel gearshift control.



Program mode selector dial on SL 63 AMG

C Comfort	For standard driving
S Sport	For sporty driving
S+ Sport Plus	For sporty driving with shorter shift times
M Manual	For manual gearshifting
RS RACE START	For optimum acceleration from a standing start

- i** Program mode **RS** cannot be selected while driving. For more information, see “RACE START (SL 63 AMG)” (▷ page 141).
- i** **E 63 AMG:** In addition, the currently selected program mode is indicated in red on the program mode selector dial.
- i** **SL 63 AMG:** In addition, the currently selected program mode is indicated in red on the program mode selector dial.



Program mode selector switch on SL 65 AMG

C Comfort	For comfort driving
S Sport	For standard driving
M MANUAL	For manual gearshifting

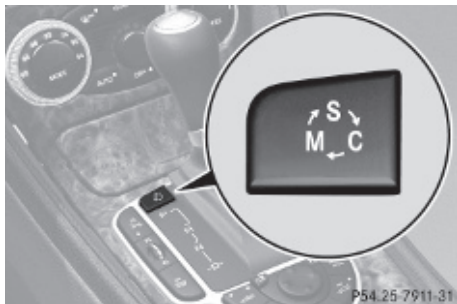

Program mode selector switch on vehicles with AMG Sport Package

C Comfort	For comfort driving
S Sport	For standard driving
M Manual	For manual gearshifting

The current program mode appears in the right multifunction display (▷ page 107).

For information on automatic program mode (**C** or **S**), see “Automatic shift program” (▷ page 106) and “One-touch gearshifting” (▷ page 108).

Activating manual shift program

- ▶ **All models except SL 63 AMG:** Press the program mode selector switch repeatedly until **M** appears in the right multifunction display.
- ▶ **SL 63 AMG:** Turn the program mode selector dial until **M** appears in the right multifunction display. The automatic transmission switches to manual program mode **M**. Automatic shifting is switched off. The gear range is not limited.

You can change the gears manually with drive position **D** selected. You can upshift or downshift through the gears in succession.

- ▶ **i** Manual program mode **M** will not be stored. When the engine is turned off with manual program mode **M** selected, the automatic transmission will go to automatic program mode **C** when the engine is restarted.

Upshifting

- ▶ **i** In manual program mode **M**, the automatic transmission will not upshift, even if the engine has reached its overrevving range. Shift up into the next gear before the engine has reached its overrevving range. Make absolutely certain that the engine speed does not reach the red marking on the tachometer. Otherwise the engine could be damaged which is not covered by the Mercedes-Benz Limited Warranty.

- ▶ Briefly press the gear selector lever to the right in the **D+** direction.

or

- ▶ Briefly pull right gearshift control ② (▷ page 108). The automatic transmission shifts into the next higher gear.

Upshift indicator

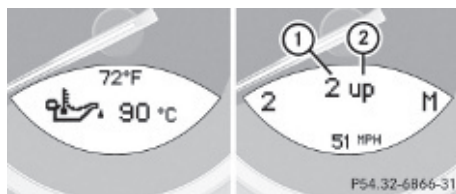

In manual program mode **M**, upshift indicator ② in the right multifunction display advises you to upshift before the engine reaches the overspeed range. In addition, symbol **^** may appear instead of manual program mode symbol **M** in the right multifunction display. Thus you can drive at

the maximum engine speed for each gear without overrevving the engine.

- ▶ Shift the automatic transmission from current gear ① into the next higher gear. The fuel supply will otherwise be interrupted to prevent the engine from overrevving.

Downshifting

Warning!

On slippery road surfaces, never downshift in order to obtain braking action. This could result in drive wheel slip and reduced vehicle control. Your vehicle's ABS will not prevent this type of loss of control.

- ▶ Briefly press the gear selector lever to the left in the **D**- direction.

or

- ▶ Briefly pull left gearshift control ① (> page 108). The automatic transmission shifts into the next lower gear.

i For maximum acceleration, press and hold the gear selector lever to the left in the **D**- direction or pull and hold the left gearshift control. Depending on the engine speed the automatic transmission selects the optimal gear for maximum acceleration.

i When you brake or stop, the automatic transmission shifts down into a gear from which you can easily accelerate or take off.

Kickdown

Using the kickdown while driving in manual program mode **M** is not possible.

Deactivating manual shift program

- ▶ **All models except SL 63 AMG:** Press the program mode selector switch repeatedly until **C** or **S** appears in the right multifunction display.

- ▶ **SL 63 AMG:** Turn the program mode selector dial until **C** or **S** appears in the right multifunction display.

or

- ▶ Restart the engine. The automatic transmission will go to automatic program mode **C**.

Manual program mode **M** is not stored.

Emergency operation (limp-home mode)

If vehicle acceleration becomes less responsive or sluggish or the automatic transmission no longer shifts, the automatic transmission is most likely operating in limp-home (emergency operation) mode. In this mode only second gear and reverse gear **R** can be selected.

- ▶ Stop the vehicle in a safe location.
- ▶ Shift the automatic transmission into park position **P**.
- ▶ Turn off the engine.
- ▶ Wait at least 10 seconds before restarting.
- ▶ Restart the engine.
- ▶ Shift the automatic transmission into drive position **D** (for second gear) or reverse gear **R**.
- ▶ Have the automatic transmission checked at an authorized Mercedes-Benz Center as soon as possible.

Instrument cluster

Introduction

For a full view illustration of the instrument cluster, see "Instrument cluster" (> page 30).

Warning!

No messages will be displayed if either the instrument cluster or the multifunction display is inoperative.

As a result, you will not be able to see information about your driving conditions, such as

- speed
- outside temperature
- warning/indicator lamps
- malfunction/warning messages
- failure of any systems

Driving characteristics may be impaired.

If you must continue to drive, do so with added caution. Contact an authorized Mercedes-Benz Center as soon as possible.

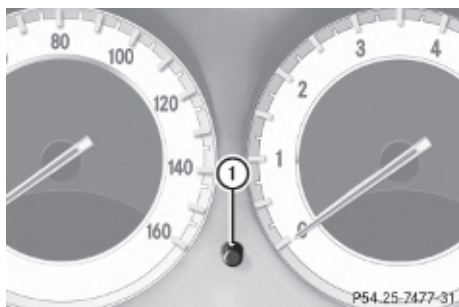

① Reset button

For information on changing the instrument cluster settings, e.g. the language, see (▷ page 122).

Activating the instrument cluster

The instrument cluster is activated when you

- open a door
- switch on the ignition
- press reset button ①
- switch on the exterior lamps

- ❗ Opening a door activates the instrument cluster illumination only for about 30 seconds.

Adjusting the instrument cluster illumination

Use reset button ① to adjust the illumination brightness for the instrument cluster and the switches on the center console.

- ▶ **To brighten illumination:** Turn reset button ① clockwise until the desired level of illumination is reached.
- ▶ **To dim illumination:** Turn reset button ① counterclockwise until the desired level of illumination is reached.

- ❗ The instrument cluster illumination is dimmed or brightened automatically to suit ambient light conditions.

Coolant temperature gauge

The coolant temperature gauge is located on the left side in the instrument cluster (▷ page 30).

⚠ Warning!

Driving when your engine is overheated can cause some fluids which may have leaked into the engine compartment to catch fire. You could be seriously burned.

Steam from an overheated engine can cause serious burns which can occur just by opening the engine hood. Stay away from the engine if you see or hear steam coming from it.

Stop the vehicle in a safe location away from other traffic. Turn off the engine, get out of the vehicle and do not stand near the vehicle until the engine has cooled down.

During severe operating conditions, e.g. stop-and-go traffic, the coolant temperature may rise close to 248°F (120°C).

- ❗ Excessive coolant temperature triggers a warning in the multifunction display and the red coolant temperature warning lamp  in the instrument cluster comes on.

The engine should not be operated with a coolant temperature above 248°F (120°C).

Doing so may cause serious engine damage which is not covered by the Mercedes-Benz Limited Warranty.

Resetting trip odometer

- ▶ Make sure you are viewing the standard display (▷ page 116) in the multifunction display.
- ▶ Press and hold the reset button in the instrument cluster (▷ page 111) until the trip odometer is reset.

Tachometer

The red marking on the tachometer (▷ page 30) denotes excessive engine speed.

! Avoid driving at excessive engine speeds, as it may result in serious engine damage that is not covered by the Mercedes-Benz Limited Warranty.

To help protect the engine, the fuel supply is interrupted if the engine is operated within the red marking.

Control system

Introduction

The control system is activated as soon as the starter switch is in position **1**.

The control system enables you to call up information about your vehicle and to change vehicle settings.

For example, you can use the control system to find out when your vehicle is next due for maintenance service, to set the language for messages in the instrument cluster display, and much more.

⚠ Warning!

A driver's attention to the road and traffic conditions must always be his/her primary focus when driving.

For your safety and the safety of others, selecting features through the multifunction steering wheel should only be done by the driver when traffic and road conditions permit it to be done safely.

Bear in mind that at a speed of just 30 mph (approximately 50 km/h), your vehicle is covering a distance of 44 feet (approximately 14 m) every second.







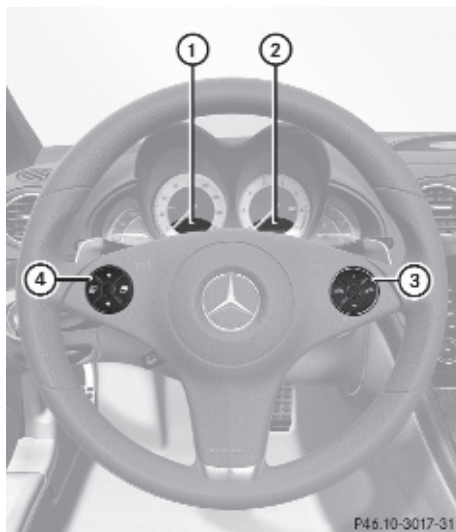



The control system relays information to the multifunction display.

Multifunction steering wheel

The displays in the multifunction display and the settings in the control system are controlled by using the buttons on the multifunction steering wheel.





- | | |
|---|---|
| ① | Left multifunction display in the speedometer |
| ② | Right multifunction display in the tachometer |



③	<p>Press button</p> <p> to end a call</p> <p> to reject an incoming call</p> <p> to answer a call</p> <p>to dial¹⁰</p> <p>to redial¹⁰</p>
	<p>Press button</p> <p> to select submenus in the</p> <p> Settings menu</p> <p>to set values</p> <p>to operate the RACETIMER¹¹</p> <p>to set the volume</p>
④	<p>Press button</p> <p> to select next or previous menu</p> <p></p>
	<p>Press button briefly</p> <p> to move within a menu</p> <p> Within Audio/DVD menu to select previous or next track, scene or stored station</p> <p>Within Telephone menu to switch to the phone book and select a name or number</p>
	<p>Press and hold button</p> <p> Within Audio/DVD menu to select previous or next track with quick search or to select previous or next station in station list or wave band</p> <p> Within Telephone menu to start the quick search in the phone book</p>

The information available in the multifunction display is arranged in menus and accompanying functions and submenus.

The individual functions are then found within the relevant menu (radio or CD operations under **Audio/DVD** menu, for example). These functions serve to call up relevant information or to customize the settings for your vehicle.

It is helpful to think of the menus, and the functions within each menu, as being arranged in a circular pattern.

► Press button  or  repeatedly to pass through each menu one after the other.

► Press button  or  repeatedly to pass through each function display, one after the other, in the current menu.

In the **Settings** menu, instead of functions, you will find a number of submenus for calling up and changing settings. For instructions on using these submenus, see “Settings menu” (▷ page 121).

The number of menus available in the system depends on which optional equipment is installed in your vehicle.

Multifunction display

The multifunction display consists of the display fields in the speedometer and the tachometer. In its default state, the left multifunction display shows the main odometer and the outside temperature, while the trip odometer appears in the right multifunction display. This default setting is referred to as the standard display.

Depending on the selected menu, pressing the buttons on the multifunction steering wheel will alter what appears in the multifunction display.

¹⁰ Function only available in telephone menu.

¹¹ AMG vehicles only.

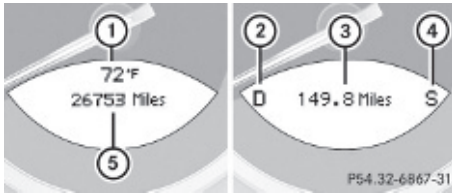

- ① Outside temperature indicator
- ② Transmission position/gear range indicator

- ③ Trip odometer
- ④ Automatic transmission program mode indicator
- ⑤ Main odometer

For more information on menus displayed in the multifunction display, see “Menus and submenus” (▷ page 115).

Menus and submenus

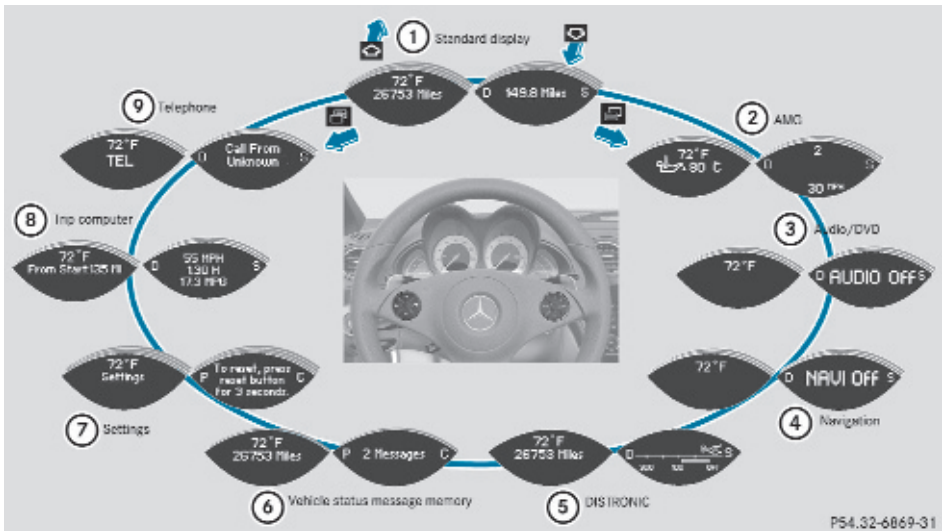

i The headings used in the menu table are designed to facilitate navigation within the system and are not necessarily identical to those shown in the multifunction display. The first function displayed in each menu will automatically show you which part of the system you are in.

	Function
①	Standard display menu (▷ page 116)
②	AMG ¹² menu (▷ page 116)
③	Audio/DVD menu (▷ page 119)
④	Navigation menu (▷ page 120)
⑤	Distronic menu (▷ page 120)

¹² AMG vehicles only.

	Function
⑥	Vehicle status message memory ¹³ menu (▷ page 120)
⑦	Settings menu (▷ page 121)
⑧	Trip computer menu (▷ page 128)
⑨	Telephone menu (▷ page 129)

Standard display menu

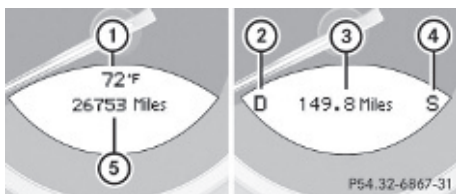

Standard display

- ① Outside temperature
- ② Transmission position
- ③ Trip odometer
- ④ Automatic transmission program mode
- ⑤ Main odometer

▶ If you see another display, press button or repeatedly until the standard display appears.

You can select whether the digital speedometer or the outside temperature appears in the left multifunction display (▷ page 124).

▶ Press button or to select the functions in the **Standard display** menu.

The following functions are available:

- Checking tire inflation pressure with the Advanced TPMS (▷ page 190)
- Calling up digital speedometer or outside temperature (▷ page 116)

- Calling up maintenance service indicator display (▷ page 214)
- Checking engine oil level (▷ page 182)

Calling up digital speedometer or outside temperature

If you have selected the digital speedometer for the standard display (▷ page 124), select the outside temperature display here.

Warning!

The outside temperature indicator is not designed to serve as an ice-warning device and is therefore unsuitable for that purpose. Indicated temperatures just above the freezing point do not guarantee that the road surface is free of ice. The road may still be icy, especially in wooded areas or on bridges.

- ▶ Press button or repeatedly until the digital speedometer or, depending on the chosen setting, the outside temperature appears in the right multifunction display.

AMG menu

This function is only available in AMG vehicles.

- ▶ Press button or repeatedly until the **AMG** menu appears in the multifunction display.

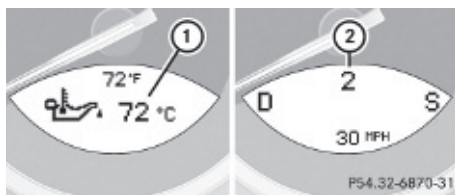



The main screen of the **AMG** menu shows you the engine oil temperature ① as well as the gear currently engaged ②.

¹³ The vehicle status message memory menu is only displayed if there is a message stored.



The engine oil temperature flashes if the engine oil temperature has not yet reached 80°C. During this time, avoid driving at full engine speed.

If the engine reaches the overspeed range in the manual shift program, the menu will be shown in red. In addition, you will see UP next to gear indicator ② as a reminder to upshift.

Use buttons  or  to select the following functions in the **AMG** menu:

- SETUP (▷ page 117)
- RACETIMER (▷ page 117)
- Overall analysis (▷ page 118)
- Lap analysis (▷ page 118)

SETUP

- ▶ Press button  or  repeatedly until the **AMG** menu appears in the multifunction display.
- ▶ Press button  repeatedly until the **SETUP** appears in the multifunction display.

or

- ▶ Tap the AMG button on the center console (SL 63 AMG only) (▷ page 144).

- i** You can store and call up automatic transmission program mode and suspension style settings with the AMG button on the center console (SL 63 AMG only). For more information, see (▷ page 144).

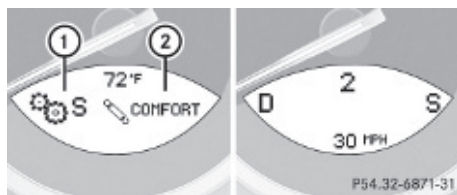



- ① Automatic transmission program mode indicator
- ② Suspension style indicator

RACETIMER

Warning!

The RACETIMER feature is only for use on roads and in conditions where high speed driving is permitted. Racing on public roads is prohibited under all circumstances. The driver is and must always remain responsible for following posted speed limits.

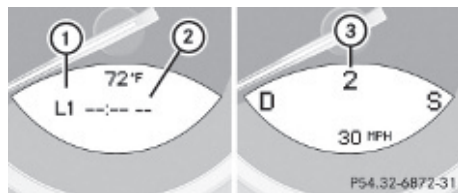

The RACETIMER allows you to time and save driving stretches.

- ▶ Press button  or  repeatedly until the **AMG** menu appears in the multifunction display.
- ▶ Press button  repeatedly until the RACETIMER appears in the multifunction display.



- ① Lap number
- ② RACETIMER
- ③ Gear indicator

You can start the RACETIMER when the engine is running or the starter switch is in position 2 (▷ page 78).

While the RACETIMER is being displayed, you cannot adjust the audio volume using buttons  or .

- ▶ **Starting:** Press button .

- ▶ **Displaying intermediate time:** Press button  while the timer is running. The intermediate time is shown for 5 seconds.



- ▶ **Stopping:** Press button .

When you stop the vehicle and turn the SmartKey to position 1 (▷ page 78) or, in vehicles with KEYLESS-GO, turn off the engine and do not open the driver's door, the

RACETIMER stops timing. Timing is resumed when you press button  after switching the ignition back on or restarting the engine.

Saving lap time and starting a new lap

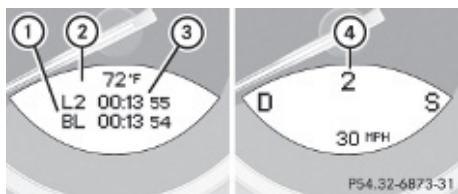

You can save up to nine laps.

- ▶ Press button  while the timer is running.
The intermediate time will be shown for 5 seconds.
- ▶ Press button  within 5 seconds.
The intermediate time shown will be saved as a lap time.
The RACETIMER begins timing the new lap.
The new lap begins to be timed as soon as the intermediate time is called up.





- ① Best lap time
- ② Lap number
- ③ RACETIMER
- ④ Gear indicator

Resetting current lap

- ▶ Press button  while the timer is running.
The timer stops.
 - ▶ Press button .
- The lap time is reset to "0".



Deleting all laps

It is not possible to delete a single saved lap. When you turn off the engine, the RACETIMER will be reset to "0" after 30 seconds. All laps are deleted.

- ▶ Press button  while the timer is running.
The timer stops.
 - ▶ Press the reset button in the instrument cluster twice (▷ page 112).
 - ▶ Press button .
- The timer starts. The saved laps are deleted.

Overall analysis

This function is only available if you have saved at least one lap and have stopped the RACETIMER.

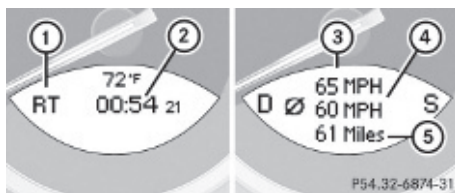

- ▶ Press button  or  repeatedly until the **AMG** menu appears in the multifunction display.
- ▶ Press button  repeatedly until the overall analysis appears in the multifunction display.



- ① Overall analysis of RACETIMER
- ② Overall driving time
- ③ Maximum speed
- ④ Average speed
- ⑤ Overall distance driven

Lap analysis

This function is only available if you have saved at least two laps and have stopped the RACETIMER.

- ▶ Press button  or  repeatedly until the **AMG** menu appears in the multifunction display.
- ▶ Press button  repeatedly until the lap analysis appears in the multifunction display.

Each lap is shown in its own submenu. The fastest lap is indicated by flashing symbol ①.

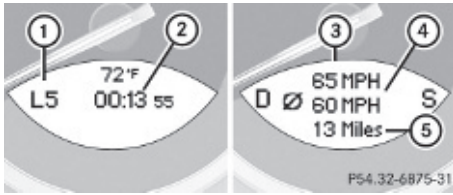

- ① Lap number
- ② Lap time
- ③ Maximum speed during lap
- ④ Average speed during lap
- ⑤ Lap length

▶ Press button or to see other lap analyses.

Audio/DVD menu

The functions in the **Audio/DVD** menu operate the audio or video equipment which you have currently switched on.

The following functions are available:

- Selecting radio station (▶ page 119)
- Operating audio devices/audio media (▶ page 119)
- Operating video DVD (▶ page 120)

If no audio equipment is currently switched on, the message **AUDIO Off** appears in the multifunction display.

Selecting radio station

i The SIRIUS XM Satellite Radio is treated as a radio application.

Additional optional satellite radio equipment and a subscription to a satellite radio service provider are required for satellite radio operation. Contact an authorized Mercedes-Benz Center for details and availability for your vehicle.

For more information, refer to separate COMAND system operating instructions.

- ▶ Switch on the COMAND system and select radio. Refer to separate COMAND system operating instructions.
- ▶ Press button or repeatedly until the currently tuned station appears in the multifunction display.

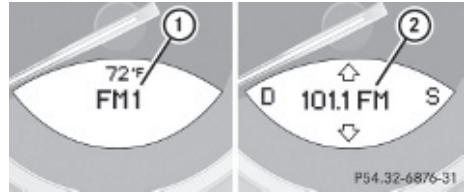

Example illustration

- ① Wave band setting and stored memory position
- ② Station frequency

- ▶ **Selecting next or previous stored station:** Press button or briefly to select a stored station.
- ▶ **Selecting next or previous station in the station list:** Press and hold button or to select a station.
- ▶ **Selecting next or previous station in wave band** (Only if no station list is available): Press and hold button or to select a station.

You can only store new stations using the corresponding feature on the radio. Refer to separate COMAND system operating instructions.

Operating audio devices/audio media

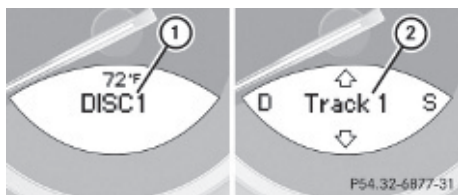

- ▶ Switch on the COMAND system and select the audio device or audio media. Refer to separate COMAND system operating instructions.
- ▶ Press button or repeatedly until the **Audio/DVD** menu appears in the multifunction display.



Example illustration



- ① Disc number
- ② Current track

► **Selecting next or previous track:** Press button  or  briefly.

► **Selecting a track from the track list (quick search):** Press and hold button  or .

The current track does not appear during Audio AUX mode operation.

Operating video DVD

- Switch on the COMAND system and select DVD-Video. Refer to separate COMAND system operating instructions.
- Press button  or  repeatedly until the **Audio/DVD** menu appears in the multifunction display.

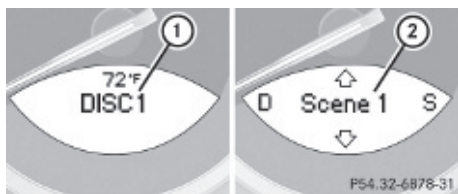



- ① Disc number
- ② Current scene

► Press button  or  to select a scene.

Navigation menu

The **Navigation** menu contains the functions needed to operate your navigation system.

► Press button  or  repeatedly until the **Navigation** menu appears in the multifunction display.

The message shown in the multifunction display depends on the status of the navigation system:

- With the COMAND system switched off, the message NAVI Off appears in the multifunction display.
- With the COMAND system switched on but route guidance not activated, the direction of travel and, if applicable, the name of the street currently traveled on appear in the multifunction display.
- With the COMAND system switched on and route guidance activated, the direction of travel and maneuver instructions appear in the multifunction display.

Please refer to separate COMAND system operating instructions for instructions on how to activate the route guidance system.

Distronic menu

Use the **Distronic** menu to display the current settings for your Distronic system. The information shown in the multifunction display depends on whether the Distronic system is activated or deactivated.

Please refer to the “Driving systems” section of this manual (► page 133) for instructions on how to activate Distronic.



Vehicle status message memory menu

Use the **Vehicle status message memory** menu to scan malfunction and warning messages that may be stored in the memory. Such messages appear in the multifunction display and are based on conditions or system status the vehicle's system has recorded.



The **Vehicle status message memory** menu only appears if messages have been stored.

Warning!

Malfunction and warning messages are only indicated for certain systems and are intentionally not very detailed. The malfunction and warning messages are simply a reminder with respect to the operation of certain systems. They do not replace the owner's and/or driver's responsibility to maintain the vehicle's operating safety. Have all required maintenance and safety checks performed on the vehicle. Bring the vehicle to an authorized Mercedes-Benz Center to address the malfunction and warning messages.

- ▶ Press button  or  repeatedly until the **Vehicle status message memory** menu appears in the multifunction display. If conditions have occurred causing status messages to be recorded, the number of messages appears in the right multifunction display.



- ▶ Press button  or .
- The stored messages will now be displayed in the order in which they have occurred. For malfunction and warning messages, see “Vehicle status messages in the multifunction display” (▷ page 226).

- i** After you have scrolled through all recorded status messages, the first recorded message appears again.

Should the vehicle's system record any conditions while driving, the number of messages will reappear in the multifunction display when the SmartKey in the starter switch is turned to position **0** or removed

from the starter switch. With KEYLESS-GO, the number of messages will reappear when you turn off the engine by pressing the KEYLESS-GO start/stop button and open the driver's door.

Except for high-priority messages, the vehicle status message memory will be cleared when you switch off the ignition.

Settings menu

Introduction

In the Settings menu there are two functions: The function To reset, press reset button for 3 seconds, with which you can reset all the settings to the original factory settings and a collection of submenus with which you can make individual settings for your vehicle.



The following settings and submenus are available in the Settings menu:

- Resetting to factory settings (▷ page 121)
- Submenus in the Settings menu (▷ page 122)
- Instrument cluster submenu (▷ page 122)
- Lighting submenu (▷ page 124)
- Vehicle submenu (▷ page 126)
- Convenience submenu (▷ page 127)

Resetting to factory settings

You can reset the settings of all submenus to the factory settings.

For safety reasons, the function Light Circuit Headlamp Mode in the Lighting submenu cannot be reset while driving.

- ▶ Press button  or  repeatedly until the Settings menu appears in the multifunction display.



- ▶ Press the reset button in the instrument cluster (▷ page 111) for approximately 3 seconds.
The request to press the reset button once more to confirm appears in the right multifunction display.

- ▶ Press the reset button once more.
The settings you have changed will not be reset unless you confirm the action by pressing the reset button a second time.

Submenus in the Settings menu

- ▶ Press button or repeatedly until the Settings menu appears in the multifunction display.
- ▶ Press button .
The collection of the submenus appears in the right multifunction display. There are more submenus than can be displayed simultaneously.



- ▶ Press button .
The selection marker moves to the next submenu.
- ▶ Scroll down with button , scroll up with button .
- ▶ With the selection marker on the desired submenu, use button to access the individual functions within that submenu.
- ▶ Once within the submenu, use button to move to the next function or button

to move to the previous function within that submenu.

- ▶ Use button or to change the settings of the respective function.

The following lists show what settings can be changed within the various menus. Detailed instructions on making individual settings can be found on the following pages.

Instrument cluster submenu

- Selecting speedometer/odometer display mode (▷ page 123) (Canada only)
- Selecting digital speedometer display mode (▷ page 123)
- Selecting language (▷ page 123)
- Selecting standard display (▷ page 124)

Lighting submenu

- Switching daytime running lamp mode on or off (USA only) (▷ page 124)
- Switching locator lighting on or off (▷ page 125)
- Switching night security illumination (Headlamps delayed shut-off feature) on or off (▷ page 125)
- Switching interior lighting delayed shut-off on or off (▷ page 126)

Vehicle submenu

- Switching automatic central locking on or off (▷ page 126)

Convenience submenu

- Activating easy-entry/exit feature (▷ page 127)







Instrument cluster submenu

Access the Instr. Cluster submenu via the Settings menu. Use the Instr. Cluster submenu to change the instrument cluster display settings.



The following functions are available:

- Selecting speedometer/odometer display mode (▷ page 123) (Canada only)
- Selecting digital speedometer display mode (▷ page 123)
- Selecting language (▷ page 123)
- Setting standard display (▷ page 124)



Selecting speedometer/odometer display mode (Canada only)





- ▶ Press button  or  repeatedly until the Settings menu appears in the multifunction display.
- ▶ Press button .
- ▶ Move the selection marker with button  or  to the Instr. Cluster submenu.
- ▶ Press button  or  repeatedly until the message Speedometer appears in the multifunction display. The selection marker is on the current setting.





- ▶ Press button  or  to set speedometer/odometer unit to Kilometers or Miles.

Selecting digital speedometer display mode



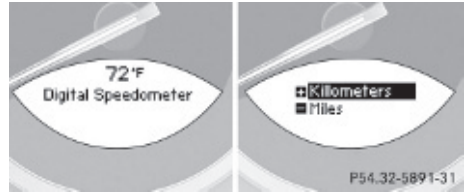



- ▶ Press button  or  repeatedly until the Settings menu appears in the multifunction display.
- ▶ Press button .

- ▶ Move the selection marker with button  or  to the Instr. Cluster submenu.
- ▶ Press button  or  repeatedly until the message Digital Speedometer appears in the multifunction display. The selection marker is on the current setting.





- ▶ Press button  or  to set digital speedometer unit to Kilometers or Miles.



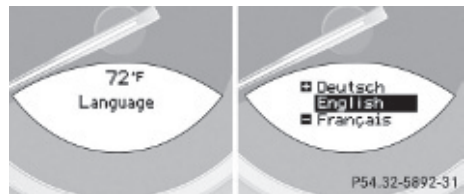



Selecting language

- ▶ Press button  or  repeatedly until the Settings menu appears in the multifunction display.
- ▶ Press button .
- ▶ Move the selection marker with button  or  to the Instr. Cluster submenu.
- ▶ Press button  or  repeatedly until the message Language appears in the multifunction display. The selection marker is on the current setting.





- ▶ Press button  or  to select the language to be used for the multifunction display messages.

Setting standard display

- ▶ Press button  or  repeatedly until the Settings menu appears in the multifunction display.
- ▶ Press button .
- ▶ Move the selection marker with button  or  to the Instr. Cluster submenu.
- ▶ Press button  or  repeatedly until the message Select Display appears in the multifunction display. The selection marker is on the current setting.



- ▶ Press button  or  to select the desired setting. The selected display appears in the left multifunction display. The other display now appears in the right multifunction display when scrolling through the **Standard display** menu (▷ page 116).

Lighting submenu







Access the Lighting submenu via the Settings menu. Use the Lighting submenu to change the lamp and lighting settings on your vehicle.

The following functions are available:



- Switching daytime running lamp mode on or off (USA only) (▷ page 124)
- Switching locator lighting on or off (▷ page 125)

- Switching night security illumination (Headlamps delayed shut-off feature) on or off (▷ page 125)
- Switching interior lighting delayed shut-off on or off (▷ page 126)

Switching daytime running lamp mode on or off (USA only)

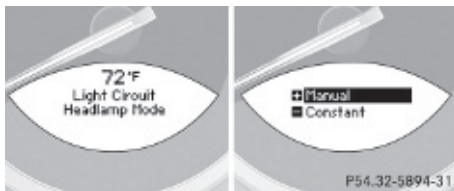
- ▶ Press button  or  repeatedly until the Settings menu appears in the multifunction display.
- ▶ Press button .
- ▶ Move the selection marker with button  or  to the Lighting submenu.
- ▶ Press button  or  repeatedly until the message Light Circuit Headlamp Mode appears in the multifunction display. The selection marker is on the current setting.



- ▶ Press button  or  to select manual operation (Manual) or daytime running lamp mode (Constant).

With daytime running lamp mode switched on and the exterior lamp switch in position  or **AUTO**, the low-beam headlamps are switched on when the engine is running.

In low ambient light conditions the following lamps will come on additionally:

- Parking lamps
- Tail lamps
- License plate lamps
- Side marker lamps

For more information on the daytime running lamp mode, see (▷ page 90).

For safety reasons, resetting all the functions of all submenus to the factory settings while driving (> page 121) will not deactivate the daytime running lamp mode.

The following message appears in the multifunction display:

Lighting Cannot be fully reset to factory settings while driving.

Switching locator lighting on or off







With the locator lighting feature activated and the exterior lamp switch in position **AUTO**, the following lamps will come on during darkness when the vehicle is unlocked using button

 on the SmartKey:



- Parking lamps
- Tail lamps
- License plate lamps
- Side marker lamps
- Front fog lamps

The locator lighting goes out when the driver's door is opened.

If you do not open the driver's door after unlocking the vehicle with the SmartKey, the lamps will go out automatically after approximately 40 seconds.

- ▶ Press button  or  repeatedly until the Settings menu appears in the multifunction display.
- ▶ Press button .
- ▶ Move the selection marker with button  or  to the Lighting submenu.
- ▶ Press button  or  repeatedly until the message **Locator Lighting** appears in the multifunction display. The selection marker is on the current setting.



- ▶ Press button  or  to switch the locator lighting function On or Off.
- ▶ Turn the exterior lamp switch to position **AUTO** when exiting the vehicle. The locator lighting feature is activated.







Switching night security illumination (Headlamps delayed shut-off feature) on or off

Use this function to set whether you would like the exterior lamps to remain on for 15 seconds during darkness after exiting the vehicle and closing all doors.

With the headlamps delayed shut-off feature activated and the exterior lamp switch in position **AUTO** before the engine is turned off, the following lamps will come on when the engine is turned off:

- Parking lamps
- Tail lamps
- License plate lamps
- Side marker lamps
- Front fog lamps

If, after turning off the engine, you do not open a door or do not close an opened door, the lamps will automatically go out after 60 seconds.

- ▶ Press button  or  repeatedly until the Settings menu appears in the multifunction display.
- ▶ Press button .
- ▶ Move the selection marker with button  or  to the Lighting submenu.
- ▶ Press button  or  repeatedly until the message **Headlamps Delayed Switch-off** appears in the multifunction display. The selection marker is on the current setting.



- ▶ Press button or to switch the headlamps delayed shut-off feature On or Off.
- ▶ Turn the exterior lamp switch to position **AUTO** before turning off the engine. The headlamps delayed shut-off feature is activated.

You can temporarily deactivate the headlamps delayed shut-off feature:

- ▶ Before exiting the vehicle, turn the SmartKey in the starter switch to position **0**.
- ▶ Then turn it to position **2** and back to position **0**. The headlamps delayed shut-off feature is deactivated. It will reactivate as soon as you start the engine.

Switching interior lighting delayed shut-off on or off

Use this function to set whether you would like the interior lighting to remain on for 10 seconds during darkness after you have removed the SmartKey from the starter switch.

- ▶ Press button or repeatedly until the Settings menu appears in the multifunction display.
- ▶ Press button .
- ▶ Move the selection marker with button or to the Lighting submenu.
- ▶ Press button or repeatedly until the message Interior Lighting Delayed Switch-off appears in the multifunction display. The selection marker is on the current setting.



- ▶ Press button or to switch the interior lighting delayed shut-off feature On or Off.

Vehicle submenu

Access the Vehicle submenu via the Settings menu. Use the Vehicle submenu to set the automatic central locking.

Switching automatic central locking on or off

Use this function to switch the automatic central locking on or off. With the automatic central locking activated, the vehicle is locked centrally at a vehicle speed of approximately 9 mph (15 km/h).

- ▶ Press button or repeatedly until the Settings menu appears in the multifunction display.
- ▶ Press button .
- ▶ Move the selection marker with button or to the Vehicle submenu.
- ▶ Press button or repeatedly until the message Automatic Door Lock appears in the multifunction display. The selection marker is on the current setting.



- ▶ Press button or to switch the automatic central locking On or Off.

Convenience submenu

Access the Convenience submenu via the Settings menu. Use the Convenience submenu to activate the easy-entry/exit feature (▷ page 127), or to set the fold-in function for exterior rear view mirrors (▷ page 127).

Activating easy-entry/exit feature

Use this function to activate and deactivate the easy-entry/exit feature (▷ page 85).







Warning!

You must make sure no one can become trapped or injured by the moving steering wheel when the easy-entry/exit feature is activated.



To stop steering wheel movement do one of the following:

- Move steering wheel adjustment stalk.
- Press one of the memory position buttons.
- Press memory button **M**.

Do not leave children unattended in the vehicle, or with access to an unlocked vehicle. Children could open the driver's door and unintentionally activate the easy-entry/exit feature, which could result in an accident and/or serious personal injury.

- ▶ Press button  or  repeatedly until the Settings menu appears in the multifunction display.
- ▶ Press button .
- ▶ Move the selection marker with button  or  to the Convenience submenu.
- ▶ Press button  or  repeatedly until the message Easy-entry Function appears in the multifunction display. The selection marker is on the current setting.



- ▶ Press button  or  to activate (On) or deactivate (Off) the easy-entry/exit feature.







Switching fold-in function for exterior rear view mirrors on or off

This feature is only available in Canada vehicles.

Use this function to set the exterior rear view mirrors to be folded in automatically when you lock your vehicle.

With this function set to On and the exterior rear view mirrors folded in using the button on the door control panel (▷ page 88), the exterior rear view mirrors will not fold out when you switch on the ignition. You will then have to fold out the exterior rear view mirrors using the button on the door control panel (▷ page 88).

Make sure both exterior rear view mirrors are folded out completely before driving off.

- ▶ Press button  or  repeatedly until the Settings menu appears in the multifunction display.
- ▶ Press button .
- ▶ Move the selection marker with button  or  to the Convenience submenu.
- ▶ Press button  or  repeatedly until the message Fold In Mirrors When Locking appears in the multifunction display. The selection marker is on the current setting.



- Press button or to switch the function On or Off.

Trip computer menu

Use the **Trip computer** menu to call up statistical data on your vehicle.

The following information is available:

- Fuel consumption statistics since start (▷ page 128)
- Fuel consumption statistics since last reset (▷ page 128)
- Resetting fuel consumption statistics (▷ page 128)
- Distance to empty (▷ page 129)

The last function called up will reappear the next time you enter the trip computer menu.

Fuel consumption statistics since start

- Press button or repeatedly until the first function of the **Trip computer** menu appears in the multifunction display.
- Press button or repeatedly until the message **From Start** appears in the left multifunction display.



- ① Distance driven since start
- ② Average speed since start

- ③ Time elapsed since start
- ④ Average fuel consumption since start

All statistics stored since the last engine start will be reset approximately 4 hours after the SmartKey in the starter switch is turned to position **0** or removed from the starter switch. Resetting will not occur if you turn the SmartKey back to position **1** or **2** within this time period.

Fuel consumption statistics since last reset

- Press button or repeatedly until the first function of the **Trip computer** menu appears in the multifunction display.
- Press button or repeatedly until the message **From Reset** appears in the left multifunction display.

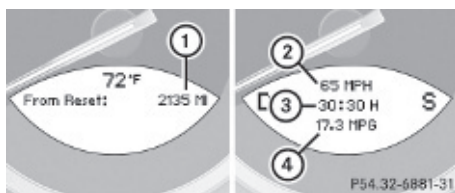





- ① Distance driven since last reset
- ② Average speed since last reset
- ③ Time elapsed since last reset
- ④ Average fuel consumption since last reset

Resetting fuel consumption statistics

- Press button or repeatedly until the first function of the **Trip computer** menu appears in the multifunction display.
- Press button or repeatedly until the reading that you want to reset appears in the multifunction display.
- Press and hold the reset button in the instrument cluster until the respective values are reset to 0.

The fuel consumption statistics reset automatically to 0 after 99 999 miles or 9 999 hours, whichever occurs first.

Distance to empty

- ▶ Press button  or  repeatedly until the first function of the **Trip computer** menu appears in the multifunction display.
- ▶ Press button  or  repeatedly until the message **Range:** appears in the left multifunction display.
The calculated remaining driving range based on the current fuel tank level appears in the right multifunction display. If only very little fuel is left in the tank, a vehicle at the fuel pump  appears instead of the remaining driving range.

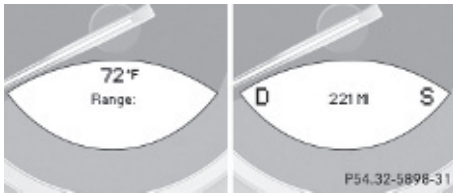



Telephone menu

Warning!

A driver's attention to the road must always be his/her primary focus when driving. For your safety and the safety of others, we recommend that you pull over to a safe location and stop before placing or taking a telephone call. If you choose to use the telephone while driving, please use the hands-free device and only use the telephone when weather, road and traffic conditions permit.

Some jurisdictions prohibit the driver from using a mobile phone while driving a vehicle. Bear in mind that at a speed of just 30 mph (approximately 50 km/h), your vehicle is covering a distance of 44 feet (approximately 14 m) every second.

You can connect your telephone to the COMAND system via Bluetooth[®], see separate COMAND system operating instructions.

- ▶ Switch on the COMAND system.
Refer to separate COMAND system operating instructions.
- ▶ Press button  or  repeatedly until the message **TEL** appears in the left multifunction display.
One of the following messages will appear in the multifunction display:
 - No Service: No network is available.
 - Bluetooth Ready: The telephone has not been connected to the COMAND system via Bluetooth[®] yet.
 - ▶ Connect the telephone to the COMAND system via Bluetooth[®].
 - Ready or name of the network provider (if available): The telephone has found a network and is ready for use. You can operate it using the control system.

Answering a call

When your telephone is ready to receive calls, you can answer a call at any time. In the right multifunction display you will then see the following message, or if available, the caller ID (number or name):







- ▶ Press button .
You have answered the call.



Ending a call or rejecting an incoming call

- ▶ Press button .

Dialing a number from the phone book

When your telephone is ready to receive calls, you may select and dial a number from the phone book. You can add new numbers to the phone book with the telephone, see separate operating instructions.

- ▶ Press button  or  repeatedly until the message TEL appears in the left multifunction display.
- ▶ Press button  or  repeatedly until the desired name appears in the right multifunction display.

If you press and hold button  or  for longer than 1 second, the system scrolls rapidly through the list of names until you release the button again. The stored names are displayed in alphabetical order.

- ▶ Press button . The control system dials the selected phone number.

If the connection is successful and this feature is supported by your network provider, the name of the party (if stored in your phone book) you are calling will appear in the multifunction display.

The control system stores the dialed number in the redial memory.





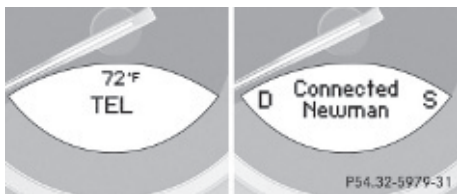

or

- ▶ Press button  if you do not want to make the call.



Redialing

The control system stores the most recently dialed phone numbers. This eliminates the need to search through your entire phone book.

- ▶ Press button  or  repeatedly until the message TEL appears in the left multifunction display.
- ▶ Press button . The first number in the redial memory appears in the right multifunction display.
- ▶ Press button  or  repeatedly until the desired number or name appears in the multifunction display.
- ▶ Press button . The control system dials the selected phone number.

Driving systems

Introduction

This section describes the following driving systems of your vehicle:

- Cruise control
- Distronic
- Distance warning function (only available with Distronic)
- Active Body Control (ABC)
- Parktronic system
- Hill-start assist system (SL 63 AMG)
- RACE START (SL 63 AMG)

The driving safety systems ABS, BAS, ESP® and the electro-hydraulic brake system are described in the “Safety and security” section (> page 54).

Cruise control

The cruise control maintains the speed you set for your vehicle automatically.

The use of the cruise control is recommended for driving at a constant speed for extended periods of time.

The currently set speed or last set speed (“Resume” function) appears in the left multifunction display:

- USA only: e.g. CC 55 MPH
- Canada only: e.g.  90 Km/h

Warning!

The cruise control is a convenience system designed to assist the driver during vehicle operation. The driver is and must always remain responsible for the vehicle’s speed and for safe brake operation.

Only use the cruise control if the road, traffic, and weather conditions make it advisable to travel at a constant speed.

- The use of the cruise control can be dangerous on winding roads or in heavy traffic because conditions do not allow safe driving at a constant speed.
- The use of the cruise control can be dangerous on slippery roads. Rapid changes in tire traction can result in wheel spin and loss of control.
- Deactivate the cruise control when driving in fog.

The “Resume” function should only be operated if the driver is fully aware of the previously set speed and wishes to resume this particular preset speed.

Warning!

The cruise control brakes automatically so that the set speed is not exceeded.

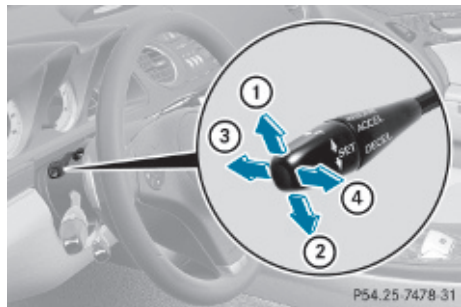

- ① Setting current or higher speed
- ② Setting current or lower speed
- ③ Canceling the cruise control
- ④ Activating the cruise control or resuming to last set speed

Activating cruise control

You can activate the cruise control at a vehicle speed above 20 mph (30 km/h).

You cannot activate the cruise control

- when you brake
- when you have engaged the parking brake
- when the automatic transmission is in park position **P**, reverse gear **R**, or neutral position **N**
- the ESP[®] is switched off or has switched off due to a malfunction

The vehicle speed displayed in the speedometer can briefly vary from the speed setting for the cruise control system.

Setting current speed

- ▶ Accelerate or decelerate to the desired speed.
- ▶ Briefly lift the cruise control lever in direction of arrow ① or press in direction of arrow ②.
- ▶ Remove your foot from the accelerator pedal.

- i** On uphill grades, the cruise control may not be able to maintain the set speed. Once

the grade eases, the set speed will be resumed.

On downhill grades, the cruise control maintains the set speed by braking with the vehicle's brake system. In addition, on longer downhill grades the automatic transmission will downshift automatically.

Canceling cruise control

► Depress the brake pedal.

or

► Briefly push the cruise control lever in direction of arrow ③.

The last set speed is stored for later use.

The last stored speed is deleted from memory when the engine is turned off.

The cruise control switches off automatically when you depress the brake pedal or you engage the parking brake.

The cruise control also switches off automatically when

- the vehicle speed falls below 20 mph (30 km/h)
- the ESP® is in operation
- the ESP® is switched off with the ESP® switch
- the ESP® has switched off due to a malfunction
- you shift the automatic transmission into neutral position **N** while driving

An acoustic warning will sound. Observe additional messages in the multifunction display that may appear.

Depressing the accelerator pedal does not deactivate the cruise control. After a brief acceleration (e.g. for passing), the cruise control will resume the last set speed.

Changing the set speed

Warning!

Keep in mind that it may take a brief moment until the vehicle has made the necessary adjustments.

Increase or decrease the set vehicle speed to a value that the prevailing road conditions and legal speed limits permit. Otherwise, sudden and unexpected acceleration or deceleration of the vehicle could cause an accident and/or serious injury to you and others.

When you use the cruise control lever to decelerate, the brake system will brake the vehicle automatically if the engine's braking power does not brake the vehicle sufficiently.

► **Increasing:** Lift the cruise control lever in direction of arrow ① and hold it up until the desired speed is reached.

► **Decreasing:** Press the cruise control lever in direction of arrow ② and hold it down until the desired speed is reached.

► Release the cruise control lever. The new speed is set and the vehicle will accelerate or decelerate.

Fine adjustment in 1 mph (Canada: 1 km/h) increments

► **Increasing:** Briefly tip the cruise control lever in direction of arrow ①.

► **Decreasing:** Briefly tip the cruise control lever in direction of arrow ②.

Setting stored speed (Resume function)

Warning!

The set speed stored in memory should only be set again if prevailing road conditions and legal speed limits permit. Possible acceleration or deceleration differences arising from returning to the preset speed could cause an accident and/or serious injury to you and others.

- ▶ Briefly pull the cruise control lever in direction of arrow ④.
If no speed is stored, the current speed is set and stored.
- ▶ Remove your foot from the accelerator pedal.

The last stored speed is deleted from memory when the engine is turned off.

Distronic

Safety notes

When activated, the DISTRONIC adaptive cruise control increases the driving convenience afforded by the cruise control while traveling on expressways and other major roadways.

- If the DISTRONIC distance sensor detects a slower moving vehicle directly ahead, your vehicle speed will be reduced so that you follow that vehicle at your preset following distance.
- If there is no vehicle directly ahead of you, the DISTRONIC will function in the same way as standard cruise control (▷ page 130).

Warning!

The DISTRONIC requires familiarity with its operational characteristics. We strongly recommend that you review the following information carefully before operating the system.

Warning!

The DISTRONIC is a convenience system. Its speed adjustment reduction capability is intended to make cruise control more effective and usable when traffic speeds vary. It is not however, intended to, nor does it, replace the need for extreme care.

The responsibility for the vehicle's speed, distance to the preceding vehicle and, most importantly, brake operation to ensure a safe stopping distance, always remains with the driver.

The DISTRONIC cannot take street and traffic conditions into account. Complex driving situations are not always fully recognized by the DISTRONIC. This could result in wrong or missing distance warnings.

Warning!

The DISTRONIC adaptive cruise control is not a substitute for active driving involvement. It does not react to pedestrians or on stationary objects, nor does it recognize or predict the lane curvature or the movement of preceding vehicles.

The DISTRONIC can only apply 20% of the maximum braking power of the vehicle.

It is the driver's responsibility at all times to be attentive to the road, weather and traffic conditions. Additionally, the driver must provide the steering, braking and other driving inputs necessary to remain in control of the vehicle.

High-frequency sources such as toll stations, speed measuring systems etc. can cause the DISTRONIC system to malfunction.

Warning!

The DISTRONIC cannot take road and traffic conditions into account. Only use the DISTRONIC if the road, weather and traffic conditions make it advisable to travel at a constant speed.

Warning!

Use of the DISTRONIC can be dangerous on slippery roads. Rapid changes in tire traction can result in wheel spin and loss of control.

The DISTRONIC does not function in adverse sight and distance conditions. Do not use the DISTRONIC during conditions of fog, heavy rain, snow or sleet.

⚠ Warning!

The DISTRONIC cannot take weather conditions into account. Switch off the DISTRONIC or do not switch it on if:

- roads are slippery or covered with snow or ice. The wheels could lose traction while braking or accelerating, and the vehicle could skid.
- the DISTRONIC system sensor cover is dirty or visibility is diminished due to snow, rain or fog, for example. The distance control system functionality could be impaired.

Always pay attention to surrounding traffic conditions even while the DISTRONIC is switched on. Otherwise, you may not be able to recognize dangerous situations until it is too late. This could cause an accident in which you and/or others could be injured.

⚠ Warning!

The "Resume" function should only be operated if the driver is fully aware of the previously set speed and wishes to resume this particular preset speed.

⚠ Warning!

Close attention to road and traffic conditions is imperative at all times, regardless of whether or not the DISTRONIC is activated.

Use of the DISTRONIC can be dangerous on winding roads or in heavy traffic because conditions do not allow safe driving at a constant speed.

The DISTRONIC will not react to stationary objects in the roadway (e.g. a stopped vehicle in a traffic jam or a disabled vehicle). The DISTRONIC will also not respond to oncoming vehicles.

Switch off the DISTRONIC

- when changing from the left to the right lane if vehicles are moving more slowly in the left lane
- when entering a turn lane or highway off ramp
- in complex driving situations, such as in highway construction zones

In these situations, the DISTRONIC will continue to maintain the set speed unless deactivated.

The DISTRONIC is designed and intended only to maintain a set speed and keep a set distance from moving objects in front of it.

i USA only:

This device has been approved by the FCC as a "Vehicular Radar System". The radar sensor is intended for use in an automotive radar system only. Removal, tampering, or altering of the device will void any warranties, and is not permitted by the FCC. Do not tamper with, alter, or use in any non-approved way.

Any unauthorized modification to this device could void the user's authority to operate the equipment.

i Canada only:

This device complies with RSS-210 of Industry Canada. Operation is subject to the following two conditions:

1. This device may not cause interference, and
2. this device must accept any interference received, including interference that may cause undesired operation of the device.

Removal, tampering, or altering of the device will void any warranties, and is not permitted. Do not tamper with, alter, or use in any non-approved way.

Any unauthorized modification to this device could void the user's authority to operate the equipment.

Distronic displays in the speedometer



When the Disticronic is activated, set speed ② and distance warning lamp ① appear in the speedometer.

The vehicle speed displayed on the speedometer can briefly vary from the speed setting on the Disticronic system.

When the Disticronic detects a vehicle directly ahead, the Disticronic indicator lamp  in the speedometer dial comes on white.

If the Disticronic calculates that there is a danger of collision, the distance warning lamp  in the speedometer comes on red and an intermittent warning sounds.

- ▶ Immediately apply the brakes to avoid a collision.
Under no circumstances should the driver await the intermittent warning sound before braking.
The intermittent warning sound ceases and the red distance warning lamp  goes out when the necessary distance to the vehicle ahead is established again.

Warning!

An intermittent warning sounds and the distance warning lamp (red)  in the speedometer dial is illuminated if the Disticronic system calculates that the distance

to the vehicle ahead and your vehicle's current speed indicate that the Disticronic will not be capable of slowing the vehicle sufficiently to maintain the preset following distance, which creates a danger of a collision.

Immediately brake the vehicle to increase your distance to the preceding vehicle. The warning sound is intended as a final caution in which you should intercede with your own braking inputs to avoid a potentially dangerous situation. Do not wait for the operation of the warning signal to intercede with your own braking. This will result in potentially dangerous emergency braking which will not always result in an impact being avoided.

Tailgating increases the risk of an accident.

Warning!

The Disticronic brakes your vehicle with a maximum deceleration of 6.5 ft/s^2 (2 m/s^2). This corresponds to approximately 20% of the maximum deceleration of your vehicle.



The Disticronic brakes the vehicle in an effort to restore the preset distance or to maintain the set speed.

Distronic menu in the control system

The information shown in the multifunction display depends on whether the Disticronic system and/or the distance warning function are activated or deactivated.

- ▶  To activate or deactivate the Disticronic system, see (> page 136) or see (> page 138).

To activate or deactivate the Distance warning function, see (> page 141).

- ▶ Press button  or  repeatedly until one of the following two displays appears in the multifunction display.

Distronic deactivated

When the DISTRONIC is deactivated, you will see the standard display in the left multifunction display.

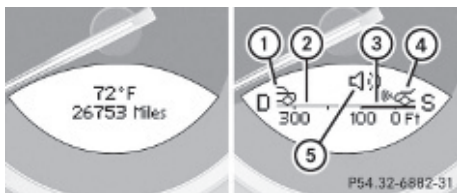

- ① Preceding vehicle, if detected
- ② Actual distance to the preceding vehicle
- ③ Preset distance threshold to the preceding vehicle
- ④ Your vehicle
- ⑤ Symbol for activated distance warning function (▷ page 140)

Distronic activated

When the DISTRONIC is activated, DTR symbol ① and set speed ② appear in the left multifunction display.



Cruise control lever

The DISTRONIC system is operated by means of the cruise control lever.

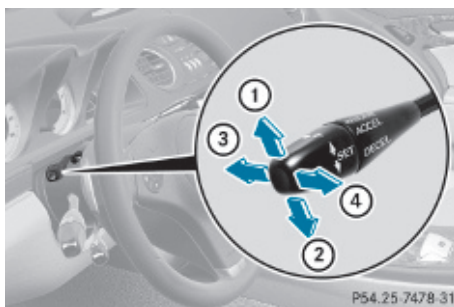

- ① Setting current or higher speed
- ② Setting current or lower speed
- ③ Deactivating the DISTRONIC
- ④ Activating the DISTRONIC, resuming to the last set speed or increasing speed in 1 mph (Canada: 1 km/h) increments

Activating DISTRONIC

You can activate the DISTRONIC when the vehicle speed is between 20 mph (30 km/h) and 110 mph (180 km/h).

When the DISTRONIC is activated, the left multifunction display will show a message such as DTR 55 MPH (Canada: DTR 90 Km/h).

If the DISTRONIC is not activated after the cruise control lever is pulled in direction of arrow ④ (▷ page 136), you will see the message DTR --- MPH (Canada: DTR --- Km/h) in the left multifunction display.

In the following cases you cannot activate the DISTRONIC:

- up to 2 minutes after starting the engine
- when you brake
- when you have engaged the parking brake
- when the automatic transmission is in park position **P**, reverse gear **R**, or neutral position **N**
- when the ESP® is switched off or has switched off due to a malfunction



- ① White DISTRONIC indicator lamp 
- ② Set speed

The vehicle speed displayed on the speedometer can briefly vary from the speed setting on the DISTRONIC system.

Setting the current speed

- ▶ Accelerate or decelerate to the desired speed.
 - ▶ Briefly lift the cruise control lever in direction of arrow ① or depress in direction of arrow ② (▷ page 136).
 - ▶ Remove your foot from the accelerator pedal.
- i** If you do not take your foot off of the accelerator pedal and continue to accelerate past the set speed, the following message will appear in the multifunction display:
- DTR Override
- The distance to a slower moving vehicle in front of you will not be set. Your vehicle speed will then be determined only by the accelerator pedal position.

Changing the set speed

Warning!

Keep in mind that it may take a brief moment until the vehicle has made the necessary adjustments.

Increase or decrease the set vehicle speed to a value that the prevailing road conditions and legal speed limits permit. Otherwise, sudden and unexpected acceleration or deceleration of the vehicle could cause an accident and/or serious injury to you and others.

You can increase the set speed in 5 mph (Canada: 10 km/h) increments or with fine adjustment in 1 mph (Canada: 1 km/h) increments. Decreasing the set speed is possible in 5 mph (Canada: 10 km/h) increments.

When you use the cruise control lever to decelerate, the brake system will brake the vehicle automatically if the engine's braking power does not brake the vehicle sufficiently.

Adjustment in 5 mph (Canada: 10 km/h) increments

- ▶ **Increasing:** Briefly lift the cruise control lever up in direction of arrow ① (▷ page 136).
- ▶ **Decreasing:** Briefly press the cruise control lever down in direction of arrow ② (▷ page 136).

The new speed is set and the vehicle will accelerate or decelerate. Keep in mind that it may take a brief moment until the vehicle has reached the set speed.

Fine adjustment in 1 mph (Canada: 1 km/h) increments

- ▶ **Increasing:** Briefly pull the cruise control lever in direction of arrow ④ (▷ page 136).

Setting stored speed (Resume function)

⚠ Warning!

The set speed stored in memory should only be set again if prevailing road conditions and legal speed limits permit. Possible acceleration or deceleration differences arising from returning to the preset speed could cause an accident and/or serious injury to you and others.

- ▶ Briefly pull the cruise control lever in direction of arrow ④ (▷ page 136).
If no speed is stored, the current speed is set and stored.
- ▶ Remove your foot from the accelerator pedal.

Deactivating Distronic

- ▶ Depress the brake pedal.
- or

- ▶ Briefly push the cruise control lever in direction of arrow ③ (▷ page 136).
The following message appears briefly in the multifunction display: DTR Off
The last set speed is stored for later use.

The last stored speed is deleted from memory when the engine is turned off.

The Distronic switches off automatically when you depress the brake pedal or you engage the parking brake.

The Distronic switches off automatically and an acoustic warning will sound when

- the vehicle speed falls below 20 mph (30 km/h)
- the ESP® is in operation
- the ESP® is switched off with the ESP® switch
- the ESP® has switched off due to a malfunction
- you shift the automatic transmission into neutral position **N** while driving

Observe additional messages in the multifunction display that may appear.

⚠ Warning!

Distronic switches off and releases the brakes when the vehicle decelerates below the minimum speed of 20 mph (30 km/h) by operation of the system. At that time the driver must apply the brakes in order to reduce vehicle speed further or bring it to a stop.

Depressing the accelerator pedal does not deactivate the Distronic. After a brief acceleration (e.g. for passing), the Distronic will resume the last set speed.

Setting the following distance in Distronic

You can set the specified following distance for Distronic by varying the time setting between 1.0 and 2.0 seconds. Using this time setting and the current speed of your vehicle, Distronic calculates and sets the required following distance to the preceding vehicle. The set distance will be shown in the right multifunction display.

⚠ Warning!

It is up to the driver to exercise discretion to select the appropriate setting given road conditions, traffic, driver's preferred driving style and applicable laws and driving recommendations for safe following distance.

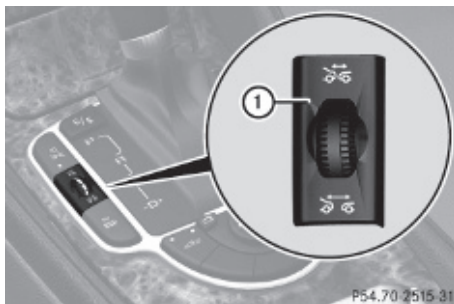

Example illustration (except SL 63 AMG)
SL 63 AMG:

The thumbwheel for adjusting the following distance is located on the right side of the center console.

► **Increasing distance:** Turn thumbwheel ① towards .

Increasing the distance setting tells Distronic to maintain a greater following distance to the preceding vehicle.

► **Decreasing distance:** Turn thumbwheel ① towards .

Decreasing the distance setting tells Distronic to maintain a shorter following distance to the preceding vehicle.

Driving with Distronic

This section describes a number of driving situations where special precaution is required on the part of the driver. Be prepared to brake in such situations. Braking will deactivate the Distronic system.

Warning!

The Distronic works to maintain the speed selected by the driver unless a moving obstacle proceeding directly ahead of it in the same travel direction is detected (e.g. following another vehicle ahead of you at your set distance).

This means that:

- Your vehicle can pass another vehicle after you have changed lanes.
- While in a sharp turn or if the preceding vehicle is in a sharp turn, the Distronic could lose sight of the preceding vehicle. Your vehicle could then accelerate to the previously selected speed.

The Distronic regulates only the distance between your vehicle and those directly ahead of it, but does not register stationary objects in the road, e.g.:

- a stopped vehicle in a traffic jam
- a disabled vehicle
- an oncoming vehicle

The driver must always be alert, observe all traffic and intercede as required by means of steering or braking the vehicle.

Warning!

The Distronic should not be used in snowy or icy road conditions.

The most likely cause for a malfunctioning system is a dirty Distronic system sensor cover (located in the hood grille), especially at times of snow and ice or heavy rain.

In such a case, the Distronic will switch off, and the message **DISTRONIC Currently Unavailable - See Oper. Manual** appears in the multifunction display.

For cleaning and care of the Distronic system sensor cover, see (▷ page 218).

- **i** If the message **DISTRONIC Currently Unavailable - See Oper. Manual** disappears during driving, the dirt (e.g. slush) has dissolved; the Distronic is available again if you reactivate it (▷ page 136).

Turns and bends

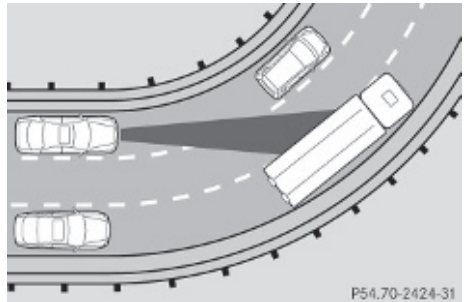

In turns or bends, the Distronic may not detect a moving vehicle in front, or it may

detect one too soon. This may cause your vehicle to brake late or unexpectedly.

Offset driving

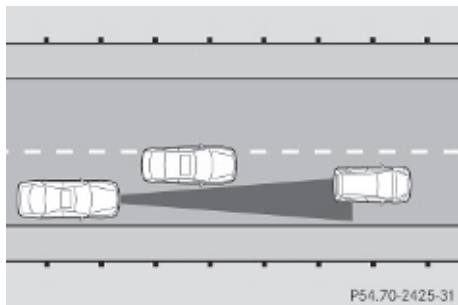

A vehicle traveling in your lane but offset from your direct line of travel may not be detected by the DISTRONIC. There will be insufficient distance to the preceding vehicle.

Lane changing

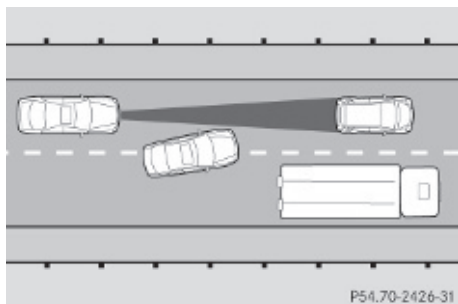

The DISTRONIC has not yet detected the vehicle changing lanes. There will be insufficient distance to the lane-changing vehicle.

Narrow vehicles

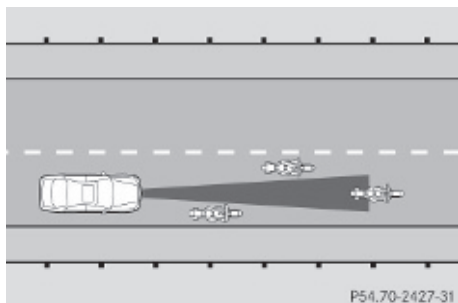

Because of their narrow profile, the vehicles traveling near the outer edges of the lane have not yet been detected by the DISTRONIC. There will be insufficient distance to the preceding vehicles.

Distance warning function

When the DISTRONIC is deactivated, this function will continue to warn you when recognizing a stationary obstacle or a slower vehicle moving in your vehicle's path and the danger of a collision exists:

- The distance warning lamp  in the speedometer comes on red.
- An intermittent warning will sound if necessary.

If these warnings are issued, you must apply the brakes to maintain a safe distance and avoid a collision with the preceding vehicle.

When depressing the brake pedal, the warning sound ceases. The warning sound will also cease when the distance to the preceding vehicle is sufficient again without applying the brakes. In this case, the distance warning lamp  will also go out.

Warning!

If the distance warning lamp (red)  in the speedometer comes on while driving and/or an intermittent warning sounds, immediate attention on the part of the driver is required. As required by the traffic situation, apply the brakes and navigate around a possible obstacle. However, do not drive by relying on the distance warning function, as this will result in an emergency braking application. This will not always enable you to avoid a collision, especially when traveling on varying road surface conditions and with varying driver reaction.

Complex driving situations are not always fully recognized by the distance warning function. This could result in wrong or missing distance warnings.

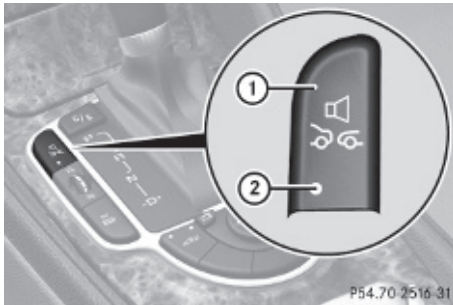

Example illustration (except SL 63 AMG)

SL 63 AMG:

The distance warning function on/off switch is located on the right side of the center console.

► **Activating/deactivating:** Press switch ①.

When the distance warning function is activated, indicator lamp ② in switch ① comes on. A loudspeaker symbol appears in the right multifunction display (▷ page 136).

RACE START (SL 63 AMG)

RACE START enables optimum acceleration from a standing start with suitable high-grip road surface conditions.

Warning!

RACE START is only available when the SPORT handling mode is switched on. The SPORT handling mode stabilizes the vehicle only to a limited extent if the vehicle starts to skid or when a wheel is spinning.

RACE START should be used only on closed tracks. Always adapt your speed and driving to the prevailing road and weather conditions.

Conditions for activation

RACE START can be activated when

- the doors are closed
- the engine is running and has reached its operating temperature of approximately

80°C. This is the case when the engine oil temperature indicator in the multifunction display stops flashing.

- the SPORT handling mode is switched on (▷ page 58)
- the multifunction steering wheel is in the straight-ahead position
- the vehicle is standing still and the brake pedal is depressed (left foot)
- the automatic transmission is in drive position **D**

Activating RACE START

- Depress the brake pedal with your left foot and keep it depressed.
- Turn the program mode selector dial clockwise (▷ page 107) until the **RS** lamp on the dial comes on.
The message RACE START Cancel: Paddle DOWN appears in the left multifunction display and the message RACE START Confirm: Paddle UP appears in the right multifunction display.

i When the activation conditions are not fulfilled anymore, RACE START is canceled. The message RACE START appears in the left multifunction display and the message Canceled appears in the right multifunction display.

- To cancel: Pull left steering wheel gearshift control (▷ page 108).

or

- To confirm: Pull right steering wheel gearshift control (▷ page 108).
The message RACE START appears in the left multifunction display and the message Available Depress Gas Pedal appears in the right multifunction display.

i If you do not depress the accelerator pedal within 2 seconds, RACE START is canceled. The message RACE START appears in the left multifunction display and the message Not Possible See

Operator's Manual appears in the right multifunction display.

- ▶ Depress the accelerator pedal fully. The engine speed rises to approximately 4000 rpm. The message RACE START appears in the left multifunction display and the message Release Brake To Start appears in the right multifunction display.

i If you do not release the brake pedal within 7 seconds, RACE START is canceled. The message RACE START appears in the left multifunction display and the message Canceled appears in the right multifunction display.

- ▶ Take your foot off the brake pedal while keeping the accelerator pedal depressed. The vehicle pulls away at maximum acceleration. The message RACE START appears in the left multifunction display and the message Active appears in the right multifunction display.

RACE START deactivates at a vehicle speed of approximately 50 km/h. The automatic transmission switches to program mode **S+**. The SPORT handling mode remains switched on.

RACE START is canceled immediately if you release the accelerator pedal while RACE START is active or when the activation conditions are not fulfilled anymore. The message RACE START appears in the left multifunction display and the message Not Possible See Operator's Manual appears in the right multifunction display.

i If RACE START is used repeatedly in a short period of time, it is only available again after having driven the vehicle a certain distance.

Hill-start assist system (SL 63 AMG)

On uphill grades, the hill-start assist system maintains the pressure in the brake system for approximately 1 second after you have released the brake pedal. Therefore, you can start off smoothly without the vehicle moving immediately after releasing the brake pedal.

Warning!

The hill-start assist system is not designed to function as a parking brake. It does not prevent the vehicle from moving when parked on an incline.

Always engage the parking brake in addition to shifting the automatic transmission into park position **P**.

- ▶ Depress the brake pedal.
- ▶ Shift the automatic transmission into drive position **D** or reverse gear **R**.
- ▶ Release the brake pedal.
- ▶ Carefully depress the accelerator pedal.

The hill-start assist system is inactive

- when starting off on a level road or downhill grades
- with the automatic transmission in neutral position **N**
- with the parking brake engaged
- if the ESP[®] has switched off due to a malfunction

ABC

The ABC system is an active, computer-controlled system that adjusts the suspension hydraulically at all four wheels in response to various driving situations. It selects the optimum suspension tuning and ride height for your vehicle automatically.

Vehicle level control

Your vehicle adjusts its ride height automatically to increase vehicle safety and to reduce fuel consumption.

The vehicle chassis ride height is raised or lowered according to the selected level setting and to the vehicle speed. With increasing speed, the ride height is reduced by up to approximately 0.5 in (12 mm). With decreasing speed, the ride height is again raised to the selected vehicle level.

These height adjustments are so small that you may not notice any change.

Setting the vehicle level

Warning!

To help avoid personal injury, keep hands and feet away from wheel housing area, and stay away from under the vehicle when lowering the vehicle chassis.

The following vehicle level settings can be selected when the vehicle is stationary and the engine is running:

Level	Use for	Indicator lamps
Normal	For driving on normal roads.	Both lamps are off.
Level 1	For driving on rough roads or with snow chains (▷ page 208).	One lamp is on.
Level 2	For driving on very rough road surface conditions.	Both lamps are on.

Select the level 1 and level 2 settings only when required by current driving conditions. Otherwise the fuel consumption may increase and/or the handling may be impaired.

- i** The selected setting remains stored in memory, even when the engine is turned off and restarted.

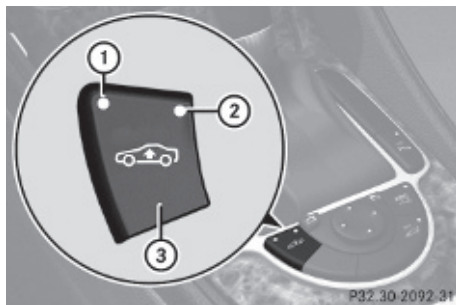

- ▶ Start the engine.
- ▶ Press vehicle level control button ③ briefly to change from one level setting to the next.
 - The normal level is selected if both indicator lamps are off.
 - At level 1, indicator lamp ① is on.
 - At level 2, both indicator lamps ① and ② are on.

When the vehicle is at level 2, pressing vehicle level control button ③ will return the vehicle to normal level.

- i** Pressing vehicle level control button ③ twice in quick succession will cause the vehicle to immediately raise or lower to the new vehicle level as selected.

Suspension tuning

The suspension tuning is set according to:

- your driving style
- road surface conditions
- your choice of suspension style
- the vehicle loading

You can set the following suspension styles:

- Regular (Comfort)
- Sporty
- i** The selected setting remains stored in memory, even when the engine is turned off and restarted.

Setting suspension tuning (except SL 63 AMG)

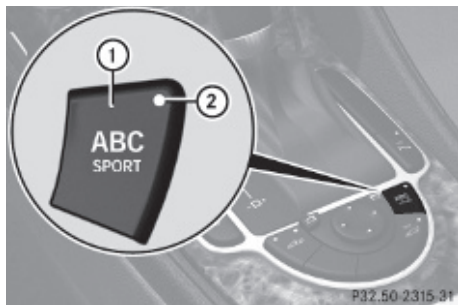

- ▶ Start the engine.

Suspension for sporty driving style

The setting for sporty driving is selected when indicator lamp ② is on.

- ▶ Press ABC suspension tuning button ①. Indicator lamp ② comes on.

Suspension for regular driving style

The setting for regular driving is selected when indicator lamp ② is off.

- ▶ Press ABC suspension tuning button ①. Indicator lamp ② goes out.

SL 65 AMG: You can display the current settings in the SETUP of the **AMG** menu (▶ page 117).

Setting suspension tuning (SL 63 AMG)

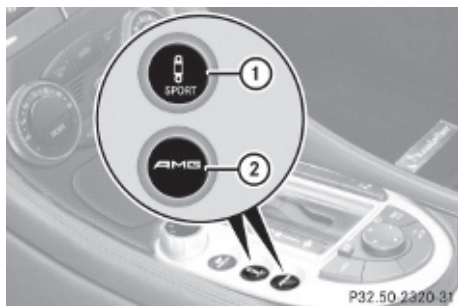

- ▶ Start the engine.

Suspension for sporty driving style

The suspension tuning for a sporty driving style is selected when ABC suspension tuning button ① comes on in red.

- ▶ Press ABC suspension tuning button ①. Button ① comes on in red.

Suspension for regular driving style

The suspension tuning for a regular driving style is selected when ABC suspension tuning button ① is not on in red.

- ▶ Press ABC suspension tuning button ①. The red illumination on button ① goes out.

Storing and calling up settings

When you have selected the suspension tuning and the program mode (▶ page 106), you can store, call up, and display the settings using AMG button ② when the engine is running. Pressing AMG button ② when the ignition is switched on, displays the current settings only.

You can also call up the settings via the control system (▶ page 117).

- ▶ **Storing:** Press and hold AMG button ② until an acoustic signal sounds. The current setting is stored and appears in the multifunction display.

- ▶ **Calling up and displaying:** Press AMG button ②. The stores suspension tuning and program mode are in effect and the settings appear in the multifunction display.

- ▶ **Displaying:** Tap AMG button ②. The stored and/or currently active settings appear in the multifunction display.

Parktronic system (Parking assist)

The Parktronic system is an electronic parking aid with ultrasonic sensors designed to assist the driver during parking maneuvers. The Parktronic system indicates the relative

distance between the vehicle and an obstacle visually and audibly.

The Parktronic system is activated automatically when

- you switch on the ignition and
- you release the parking brake and
- the automatic transmission is in drive position **D**, reverse gear **R**, or neutral position **N**

The Parktronic system deactivates at speeds above approximately 11 mph (18 km/h). At lower speeds, the Parktronic system activates again.

The Parktronic system also deactivates when you shift the automatic transmission into park position **P** or engage the parking brake. The Parktronic system monitors the surroundings of your vehicle with six sensors in the front bumper and four sensors in the rear bumper.

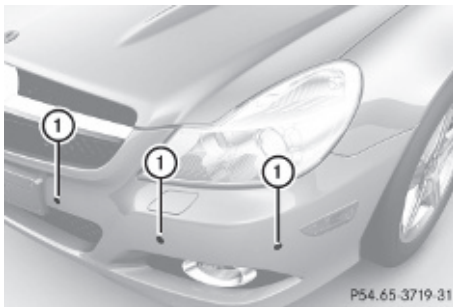

Example illustration, sensors in the front bumper

To function properly, sensors ① must be free of dirt, ice, snow and slush. Clean sensors ① regularly. Be careful not to scratch or damage sensors ①, see “Cleaning the driving systems sensors” (▷ page 218).

Warning!

The Parktronic is a supplemental system. It is not intended to, nor does it replace, the need for extreme care. The responsibility during

parking and other critical maneuvers always remains with the driver.

Warning!

Make sure no persons or animals are in or near the area in which you are parking/maneuvering. Otherwise, they could be injured.

- ❗ Special attention must be paid to objects with smooth surfaces or low silhouettes (e.g. trailer couplings, painted posts, elevated crossbars or road curbs). Such objects may not be detected by the system and can damage the vehicle.

During parking maneuvers, pay special attention to objects located above or below the height of the sensors (e.g. street curbs, painted posts, or trailer hitches etc.). The Parktronic system will not detect such objects at close range and damage to your vehicle or the object may result.

- ❗ Ultrasonic signals from outside sources (e.g. truck air brakes, car wash, or jackhammers) may impair the operation of the Parktronic system.

Range of the sensors

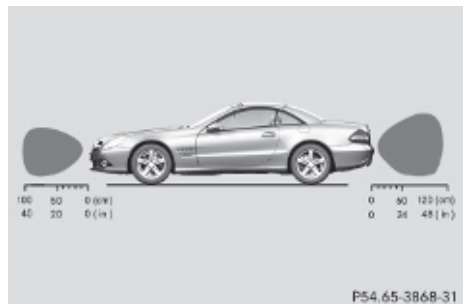

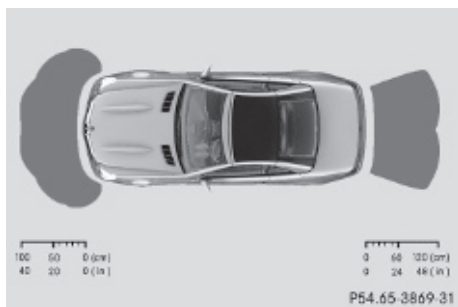

Front sensors

Center approx. 40 in (100 cm)

Corners approx. 24 in (60 cm)

Rear sensors

Center approx. 48 in (120 cm)

Corners approx. 32 in (80 cm)

Minimum distance

Center approx. 8 in (20 cm)

Corners approx. 6 in (15 cm)

If the Parktronic system detects an obstacle in this range, all the distance warning segments illuminate and you hear a warning signal. If the obstacle is closer than the minimum distance, the actual distance may no longer be indicated by the Parktronic system.

Warning indicators

Visual signals indicate the relative distance between the sensors and an obstacle.

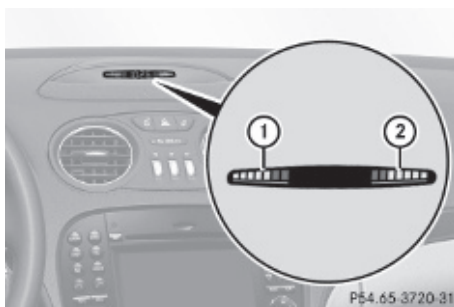

Front area warning indicators

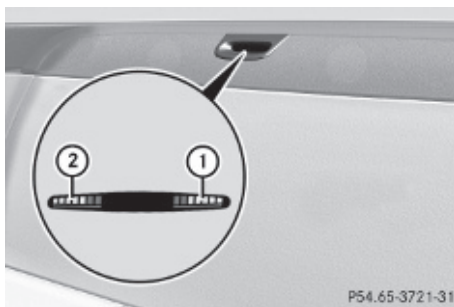

Rear area warning indicators

Each warning indicator is divided into six yellow and two red distance segments for left side ① and right side ② of the vehicle. The Parktronic system is ready to measure when the border around the indicator is illuminated. The current transmission position determines which warning indicator will be activated.

Current transmission position	Warning indicator
D	Front area activated
R or N	Front and rear area activated

As your vehicle approaches an object, one or more distance segments will illuminate, depending on the distance. When the eighth distance segment illuminates, you have reached the minimum distance.

- **Front area:** An intermittent acoustic warning will sound as the first red distance

segment illuminates and a constant acoustic warning lasting a maximum of 2 seconds will sound for the second red distance segment. The signal is canceled when the automatic transmission is shifted into park position **P** or the parking brake is engaged.

- **Rear area:** An intermittent acoustic warning will sound when the first distance segment illuminates. This signal quickens with each additional distance segment lit. When the eighth distance segment illuminates, the acoustic warning becomes a constant signal. The signal is canceled when the automatic transmission is shifted into drive position **D**, or park position **P**, or the parking brake is engaged.

Switching the Parktronic system on/off

The Parktronic system switches on automatically when the ignition is switched on.

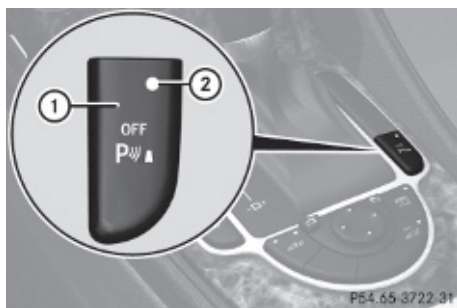

- ▶ **Switching off:** Press Parktronic switch ①. Indicator lamp ② comes on.
- ▶ **Switching on:** Press Parktronic switch ① again.

Parktronic system malfunction

There is a malfunction in the Parktronic system, if only the red distance segments illuminate and an acoustic warning sounds. The Parktronic system will switch off automatically after 20 seconds and indicator lamp ② in Parktronic switch ① comes on.

- ▶ Have the Parktronic system checked at an authorized Mercedes-Benz Center as soon as possible.

If only the red distance segments illuminate and no acoustic warning sounds, the Parktronic system sensors are dirty (e.g. dirt, ice, snow and slush). Another cause could be interference from other radio or ultrasonic signals (e.g. truck air brakes, car wash, or jackhammers). The Parktronic system will switch off automatically after 20 seconds and indicator lamp ② in Parktronic switch ① comes on.

- ▶ Switch off the ignition.
- ▶ Clean the Parktronic system sensors (> page 218).
- ▶ Switch on the ignition.
or
- ▶ Check the Parktronic system operation at another location to rule out interference from outside radio or ultrasonic signals.

Climate control system

Control panel

Automatic climate control

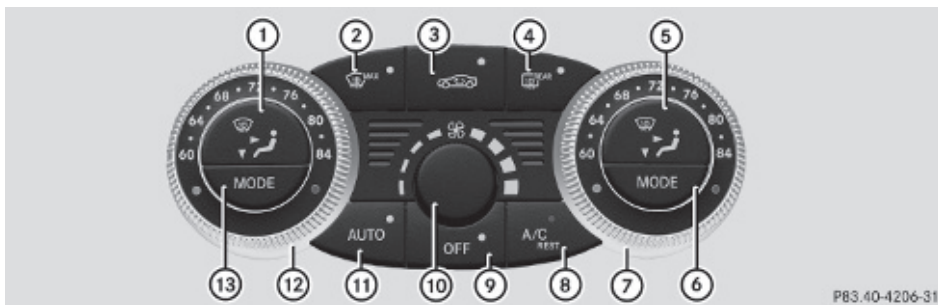

P83.40-4206-31

Function	Recommendation/Notes	
① Air distribution display, driver's side		
② Front defroster	i Keep this setting selected only until the windshield or the side windows are clear again.	(▷ page 153)
③ Air recirculation	i Only use this function for a short time, e.g. in a tunnel. Otherwise, the windows can fog up due to lack of fresh air.	(▷ page 154)
④ Rear window defroster		(▷ page 155)
⑤ Air distribution display, passenger side		
⑥ Air distribution, passenger side		(▷ page 153)
⑦ Temperature control, passenger side	i Set the temperature to 72°F (22°C).	(▷ page 151)
⑧ AC cooling on/off	i Switch on/off the air conditioning.	(▷ page 150)
Residual heat/ventilation	i With the engine turned off, it is possible to continue to heat or ventilate the interior.	(▷ page 154)
⑨ Climate control on/off	i Switch on/off the climate control system.	(▷ page 149)
⑩ Air volume control		(▷ page 153)

Function	Recommendation/Notes	
⑪ Air distribution and air volume (automatic mode)	i Switch on the automatic mode. The indicator lamp in button AUTO comes on.	(▷ page 150)
⑫ Temperature control, driver's side	i Set the temperature to 72°F (22°C).	(▷ page 151)
⑬ Air distribution, driver's side		(▷ page 153)

Notes on climate control system

The climate control system is operational whenever the engine is running. You can operate the climate control system in either the automatic or manual mode. The system cools or heats the interior depending on the selected interior temperature.

It can only function optimally when you are driving with the windows and the retractable hardtop closed.

Nearly all dust particles, pollutants and odors are filtered out before outside air enters the passenger compartment through the air distribution system.

Warning!

Severe conditions (e.g. strong air pollution) may require replacement of the filter before its scheduled replacement interval. A clogged filter will reduce the air volume to the interior and the windows could fog up, impairing visibility and endangering you and others. Have a clogged filter replaced as soon as possible at an authorized Mercedes-Benz Center.

The air conditioning will not engage (no cooling) if the **A/C** mode (▷ page 150) is deactivated.

Warning!

Follow the recommended settings for heating and cooling given on the following pages. Otherwise the windows could fog up,

impairing visibility and endangering you and others.

- ▶ Keep the air intake grille in front of the windshield free of snow and debris.

When the retractable hardtop is closed, do not obstruct air flow by placing objects on the air flow-through exhaust slots below the rear window.

- i** If the vehicle interior is hot, ventilate the interior before driving off. The climate control will then adjust the interior temperature to the set value much faster.

Deactivating the climate control system

Warning!

When the climate control system is deactivated, the outside air supply and circulation are also deactivated. Only choose this setting for a short time when the retractable hardtop is closed. Otherwise the windows could fog up, impairing visibility and endangering you and others.

- ▶ **Deactivating:** Press button **OFF**.
The indicator lamp in the button comes on.
- ▶ **Reactivating:** Press button **OFF**.
The indicator lamp in the button goes out. The previous settings are once again in effect.

or

- ▶ Turn temperature controls ⑦ or ⑫ (▷ page 148) clockwise or counterclockwise.
The indicator lamp in button **OFF** goes out.

or

- ▶ Press button **AUTO**.
The indicator lamp in button **AUTO** comes on. The air volume and air distribution are adjusted automatically.

or

- ▶ Press button **MAX**.
The indicator lamp in button **OFF** goes out.

Air conditioning

The air conditioning is operational while the engine is running and cools the interior air to the temperature set by the operator. In addition, the air conditioning dehumidifies the interior air and helps prevent window fogging.

Warning!

If you deactivate the air conditioning, the vehicle will not be cooled when weather conditions are warm. The windows can fog up more quickly. Window fogging may impair visibility and endanger you and others.

- i** Condensated water may drip out from underneath the vehicle. This is normal and not an indication of a malfunction.

The air conditioning uses the refrigerant R134a. This refrigerant is free of CFCs which are harmful to the ozone layer.

Deactivating

It is possible to deactivate the air conditioning. The interior air will then no longer be cooled or dehumidified.

- ▶ Press button **A/C REST**.
The indicator lamp in the button goes out. The cooling function switches off after a short delay.

Activating

Moist air can fog up the windows. You can dehumidify the interior air with the air conditioning.

- ▶ Press button **A/C REST**.
The indicator lamp in the button comes on.

Automatic mode

Air distribution and air volume can be adjusted automatically by the climate control system. You can also adjust the settings for air distribution and air volume manually.

When operating the climate control system in automatic mode, the interior air temperature, air volume and air distribution are adjusted automatically.

In automatic mode, cooling with dehumidification is switched on. This function can be switched off if necessary.

Warning!

If you deactivate the air conditioning, the vehicle will not be cooled when weather conditions are warm. The windows can fog up more quickly. Window fogging may impair visibility and endanger you and others.



- ▶ Set the desired temperature (▷ page 151).
 - ▶ **Activating:** Press button **AUTO**.
The indicator lamp in the button comes on. The air volume and air distribution are adjusted automatically.
 - ▶ **Deactivating:** Press button **AUTO**.
The indicator lamp in the button goes out. The blower will run at speed setting **3**. The air flows through the center and side air vents.
- or
- ▶ Press one button **MODE**.
The indicator lamp in button **AUTO** goes out. The climate control settings for the respective side of the passenger compartment is adjusted manually.

or

- ▶ Turn air volume control  clockwise or counterclockwise.
The indicator lamp in button **AUTO** goes out. Automatic air volume is switched off and is controlled according to the desired position. The automatic air distribution remains switched on.

Setting the temperature

You can adjust the air temperature on each side of the passenger compartment. You should raise or lower the temperature setting in small increments, preferably starting at 72°F (22°C).

- ▶ **Increasing/decreasing:** Turn temperature control  and/or  (▶ page 148) slightly clockwise or counterclockwise.

Adjusting air vents

Warning!

When operating the climate control, the air that enters the passenger compartment through the air vents can be very hot or very cold (depending on the set temperature). This may cause burns or frostbite to unprotected skin in the immediate area of the air vents.

Always keep sufficient distance between unprotected parts of the body and the air vents. If necessary, use the air distribution adjustment to direct the air to air vents in the vehicle interior that are not in the immediate area of unprotected skin.





For best possible performance of the climate control:

- ▶ Keep the air intake grille in front of the windshield free of snow, leaves, sticks, and any other debris.
- ▶ Always keep all air vents and grilles in the passenger compartment free from obstruction.

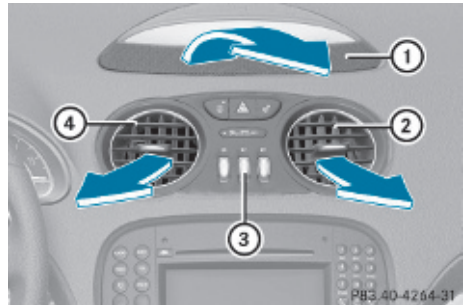
-  For draft-free ventilation, move the adjustable center and side air vents to the middle position.

Center air vents



- ① Cockpit air vent, fixed
 - ② Right center air vent, adjustable
 - ③ Thumbwheel for air volume control for center air vents
 - ④ Left center air vent, adjustable
- ▶ **Opening/closing adjustable center air vents:** Turn thumbwheel  upward to the first stop or downward. Center air vents  and  are open or closed.
 - ▶ **Opening/closing cockpit air vent:** Turn thumbwheel  upward all the way or downward. Cockpit air vent  is open or closed.

Side air vents

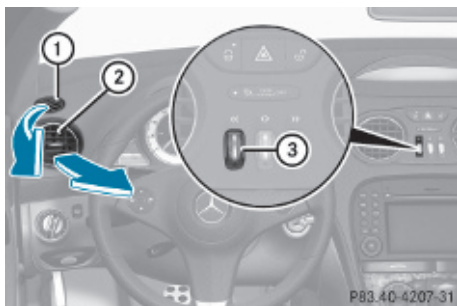

Example illustration driver's side

- ① Left side defroster air vent, fixed
- ② Left side air vent, adjustable
- ③ Thumbwheel for air volume control for adjustable left side air vent

► **Opening/closing:** Turn thumbwheel ③ upward or downward.

Ventilated glove box

The glove box can be ventilated, for instance to cool its contents, when the climate control system is activated. The level of airflow to the glove box depends on the airflow and air distribution settings. The temperature of the air is approximately the same as that of the air flowing from the center air vents.

❗ Close the glove box air vent when heating the vehicle interior. Activate the air conditioning (cooling function) when the outside temperature is high. Otherwise, temperature-sensitive items stored in the glove box could be damaged.

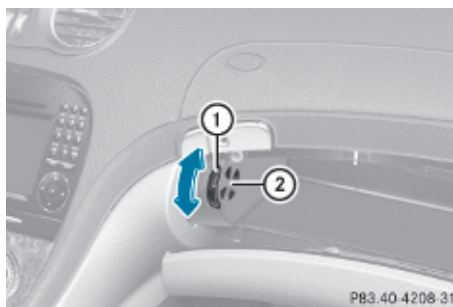

❗ You should keep air vent ② closed when outside temperatures are low.

- **Opening the air vent:** Make sure air vent ② is unobstructed.
- Turn thumbwheel ① upwards.
- **Closing the air vent:** Turn thumbwheel ① downwards.

AIRSCARF vent

⚠ Warning!

When switching on the AIRSCARF neck-level heating, the air streaming from the openings may be very hot. When in close proximity to the openings, you could be seriously burned. To help avoid serious personal injuries, switch the AIRSCARF to a lower heating level.







① AIRSCARF vent

You can switch on the AIRSCARF neck-level heating with the AIRSCARF switch (> page 84).

Adjusting air distribution

The air distribution can be adjusted separately on each side of the passenger compartment with buttons **MODE**.

The symbols on the controls represent the following functions:

Symbol	Function
	Directs air through the defroster air vents to the windshield and door windows
	Directs air through the center and side air vents
	Directs air to the footwells
	Directs air through the center, side air vents and to the footwells
	Directs air through the defroster air vents to the windshield, door windows and footwells

- ▶ Press one button **MODE** until the desired setting for the respective side of the passenger compartment appears in air distribution display ① or ⑤ (▷ page 148).

Adjusting air volume

- ▶ **Decreasing/increasing:** Turn air volume control ⑩ (▷ page 148) clockwise or counterclockwise.

Front defroster

You can use this setting to defrost the windshield, for example if it is iced up.

You can also defog the windshield and the door windows.

- ▶ **i** Keep this setting selected only until the windshield or the door windows are clear again.

- ▶ **Activating:** Press button .

The indicator lamp in the button comes on.

The climate control switches to the following functions automatically:

- cooling on to dehumidify
- most efficient blower speed and heating power, depending on outside temperature
- air flows onto the windshield and the door windows
- the air recirculation mode is switched off

- ▶ **Deactivating:** Press button  again.

The indicator lamp in the button goes out.

The previous settings are once again in effect.

The cooling remains switched on.

The air recirculation remains switched off.

or

- ▶ Press button **AUTO**.

The indicator lamp in button  goes out.

Air volume and air distribution are adjusted automatically.

or

- ▶ Turn temperature controls ⑦ and ⑫ (▷ page 148) clockwise or counterclockwise.

or

- ▶ Turn air volume control ⑩ (▷ page 148) clockwise or counterclockwise.

Windshield fogged on the outside

- ▶ Switch the windshield wipers on (▷ page 95).

- ▶ Press one button **MODE** until the setting ,  or  appears in air distribution display ① or ⑤ (▷ page 148).

Maximum cooling MAX COOL

MAX COOL is only available in U.S. vehicles.

MAX COOL is only operational when the engine is running.

If the air distribution controls as well as the air volume control are set to **AUTO** and there is a high need for cooling, MAX COOL is activated. "MAX COOL" appears in temperature controls ⑦ and ⑫ (▷ page 148).

This provides the fastest possible cooling of the vehicle interior (when retractable hardtop is closed).



Automatic climate control panel with MAX COOL activated

Air recirculation mode

Switch to air recirculation mode to prevent unpleasant odors from entering the vehicle from the outside (e.g. before driving through a tunnel). This setting cuts off the intake of outside air and recirculates the air in the passenger compartment.

Warning!

Fogged windows impair visibility, endangering you and others. If the windows begin to fog on the inside, switching off the air recirculation mode immediately should clear interior window fogging. If interior window fogging persists, make sure the air conditioning is activated, or press button



▶ **Activating:** Press button .
The indicator lamp in the button comes on.

i The air recirculation mode is activated automatically at high outside temperatures.

The indicator lamp in button  is not lit when the air recirculation mode is switched on automatically.

A quantity of outside air is added after approximately 30 minutes.

▶ **Deactivating:** Press button  again.
The indicator lamp in the button goes out.

i The manually selected air recirculation mode is deactivated automatically:

- after 5 minutes if the outside temperature is below approximately 41°F (5°C)
- after 5 minutes if the air conditioning is turned off
- after 30 minutes if the outside temperature is above approximately 41°F (5°C)

Residual heat and ventilation

With the engine turned off, it is possible to continue to heat or ventilate the interior for up to 30 minutes. This feature makes use of the residual heat produced by the engine.

i If you switch on the residual heat function when outside temperatures are high, only the ventilation will be switched on.

i How long the system will provide heating depends on the coolant temperature and the selected temperature. The blower will run at low speed regardless of the air distribution control setting.

▶ **Activating:** Switch off the ignition.

▶ Press button .
The indicator lamp in the button comes on.

▶ **Deactivating:** Press button .
The indicator lamp in the button goes out.

The residual heat is deactivated automatically:

- when the ignition is switched on
- after approximately 30 minutes
- if the battery voltage drops

Rear window defroster

Warning!

Any accumulation of snow and ice should be removed from the rear window before driving. Visibility could otherwise be impaired, endangering you and others.

The rear window defroster uses a large amount of power. To keep the battery drain to a minimum, switch off the defroster as soon as the rear window is clear. The defroster is switched off automatically after some time of operation depending on the outside temperature.

► Switch on the ignition.

► **Switching on:** Press button .

The indicator lamp in the button comes on.

! The rear window defroster cannot be switched on when the retractable hardtop is open. The indicator lamp will start flashing if the hardtop is open.

- Close the retractable hardtop.

The rear window defroster can then be switched on.

► **Switching off:** Press button  again.

The rear window defroster switches off when the battery voltage is too low. The indicator lamp in button  flashes. Too many electrical consumers may be operating simultaneously.

► Switch off consumers that are currently not needed if required.

Retractable hardtop

Safety notes

For safety reasons, the retractable hardtop can only be opened and closed when the vehicle is standing still.

 **Observe Safety notes, see page 51.**

Warning!

To prevent possible accidents, only drive the vehicle with the retractable hardtop either completely closed and locked, or fully lowered into its storage compartment.

If the retractable hardtop does not completely open or close, the roof hydraulics will lose pressure and the retractable hardtop is lowered

- after approximately 7 minutes when the ignition is switched on
- after approximately 15 seconds when the ignition is switched off



Shortly before the retractable hardtop is lowered, a warning will sound. In the multifunction display you will see  and the message **Retractable Roof Lowering**. Properly lock the retractable hardtop before continuing to drive. Otherwise, the unlocked hardtop could open while the vehicle is in motion and cause you to lose control of the vehicle. You or others could be injured as a result.

Warning!

Before operating the retractable hardtop, make sure there is no danger of anyone being injured by the moving parts (retractable hardtop, roof frame, and trunk lid).

Hands must never be placed near the roof frame, upper windshield area, hardtop, shelf behind roll bars, or trunk lid while the retractable hardtop is being raised or lowered. Serious personal injury may occur.

If potential danger exists, release the retractable hardtop switch or button  or

 on the SmartKey. This immediately interrupts the raising or lowering procedure. You then can operate the retractable hardtop switch or press button  or  on the SmartKey to raise or lower the retractable hardtop away from the danger zone

! Never sit or place heavy objects on the rear shelf. Doing so could cause damage to the retractable hardtop and the rear shelf.

! Please keep in mind that weather conditions can sometimes change rapidly. Make sure to close the retractable hardtop when leaving the vehicle. If water enters the vehicle interior, vehicle electronics could be damaged which is not covered by the Mercedes-Benz Limited Warranty.

! When opening and closing the retractable hardtop, make sure

- there is sufficient clearance for the retractable hardtop to move up and for the trunk lid to move back
- the luggage cover is installed, extended and closed
- the trunk is loaded only to the height of the luggage cover
- the luggage/cargo does not push up the closed luggage cover
- the trunk lid is closed
- the outside temperature is above +5°F (-15°C)

Otherwise the retractable hardtop and trunk as well as other parts of the vehicle could be damaged.

Opening and closing

With the retractable hardtop switch

 **Observe Safety notes, see page 155.**

- ▶ Engage the parking brake.
- ▶ Close the luggage cover (▷ page 158).

- ▶ Close the trunk lid.
- ▶ Switch on the ignition.

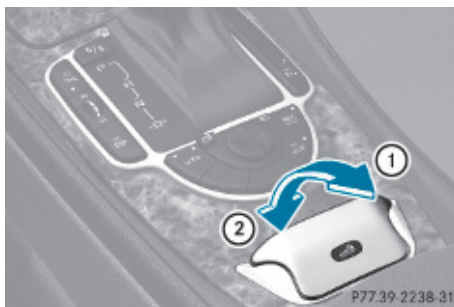

Retractable hardtop switch

Opening

i Make sure the retractable hardtop is dry before you open it. Otherwise water may enter the trunk interior.

- ▶ Pull up on the retractable hardtop switch as indicated by arrow ① until the retractable hardtop is completely lowered into its trunk storage compartment.

Closing

- ▶ Press down on the retractable hardtop switch as indicated by arrow ② until the retractable hardtop is completely closed and locked.



With the SmartKey

 **Observe Safety notes, see page 155.**





- ▶ Close the luggage cover (▷ page 158).
- ▶ Close the trunk lid.
- ▶ Aim the transmitter eye at an outside door handle.
The SmartKey must be in close proximity to the outside door handle.

Opening (Summer opening feature)

- ▶ **i** Make sure the retractable hardtop is dry before you open it. Otherwise water may enter the trunk interior.
- ▶ Press and hold button  until the retractable hardtop is completely open.
The seat ventilation for the driver's seat switches on and the rear side windows also open.
- ▶ Release button  to interrupt the opening procedure.
- ▶ Press and hold button  once more to open the door windows.

Closing (Convenience closing feature)

- ▶ Press and hold button  until the retractable hardtop is completely closed.
All currently open windows also close.
- ▶ Release button  to interrupt the closing procedure.

Locking

 **Observe Safety notes, see page 155.**

The retractable hardtop is not fully closed and locked or not fully opened and locked if

- the message  Retractable Roof In Operation appears in the multifunction display
- a warning sounds for 10 seconds when driving off or while driving

If the retractable hardtop is not properly locked, lock it as follows.

Unlocked status noticed when stopped

- ▶ Switch on the ignition.
 - ▶ To lock the retractable hardtop in its fully closed position, press down on the retractable hardtop switch (▷ page 156) until the retractable hardtop is fully closed.
- or
- ▶ To lock the retractable hardtop in its fully opened position, pull up on the retractable hardtop switch (▷ page 156) until the retractable hardtop is fully opened.

Unlocked status noticed while driving

Warning!

Stop the vehicle in a safe location or as soon as it is safe to do so and lock the retractable hardtop before continuing to drive. You could otherwise endanger yourself and others.

- ▶ Stop the vehicle in a safe location or as soon as it is safe to do so.
 - ▶ Leave the ignition switched on.
 - ▶ To lock the retractable hardtop in its fully closed position, press down on the retractable hardtop switch (▷ page 156) until the retractable hardtop is fully closed.
- or
- ▶ To lock the retractable hardtop in its fully opened position, pull up on the retractable hardtop switch (▷ page 156) until the retractable hardtop is fully opened.

Wind screen

Warning!

The wind screen can restrict the driver's vision to the rear of the vehicle. To prevent a possible accident when visibility is limited (e.g. in darkness), the upper part of the wind screen should be folded back.

The wind screen deflects drafts away from the driver and passenger when the retractable hardtop is lowered.

The wind screen is stored in the trunk.

Installing

- ▶ Leave the wind screen folded and place it on the roll bar.
- ▶ Make sure the fastening straps are unbuckled.

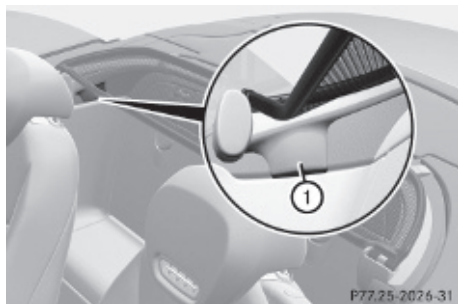

- ▶ Slide the wind screen into the roll bar until guide tabs ① on each side latch underneath the roll bar.

Make sure the fastening straps do not get caught.

i The fastening straps must be directed into the vehicle interior.

- ▶ Adjust the roll bar to a height (▷ page 51) that allows you to reach easily underneath it.

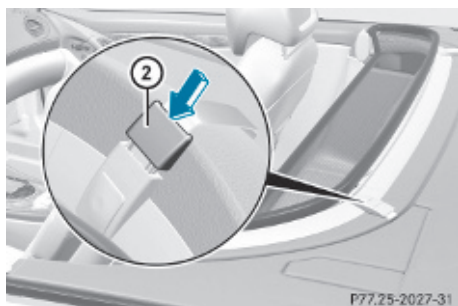

- ▶ Guide the fastening straps around the top of the roll bar and close buckles ②.
- ▶ Tighten the fastening straps if necessary.

- ▶ Lower the roll bar (▷ page 51).
- ▶ Fold the upper section of the wind screen up towards the head restraints until it stops.

Removing

- ▶ Fold the upper section of the wind screen back.
- ▶ Adjust the roll bar to a height (▷ page 51) that allows you to reach easily underneath it.

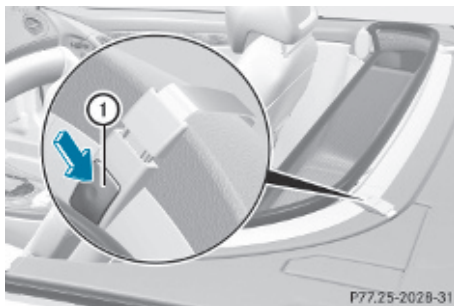

- ▶ Undo the buckles on the upper section of the roll bar by pressing release button ①.
- ▶ Lower the roll bar (▷ page 51).
Make sure the fastening straps do not get caught.
- ▶ Pull the wind screen out towards the front of the vehicle.

Be careful not to damage interior trim with the guide tabs.

- ▶ Store the wind screen in a safe place.

Luggage cover

The luggage cover covers luggage/cargo in the trunk.

! To prevent damage to the retractable hardtop or luggage/cargo when lowering the retractable hardtop:

- Load trunk only to the height of the luggage cover.
- Do not permit luggage/cargo to push up the closed luggage cover.
- Do not place anything on top of or in front of the luggage cover.
- Do not place anything on the shelf behind the roll bar.

Closing

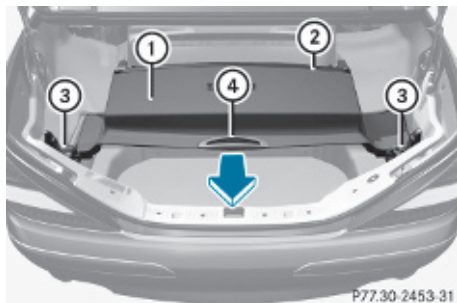

Closed luggage cover

- ① Luggage cover
- ② Zipper
- ③ Side holder
- ④ Handle

- ▶ Pull out luggage cover ① in direction of arrow using handle ④.
- ▶ Hook luggage cover ① into left and right side holders ③.

Opening

- ▶ Unhook luggage cover ① from side holders ③.
- ▶ While holding on to handle ④, guide luggage cover ① in the opposite direction of arrow.

Removing

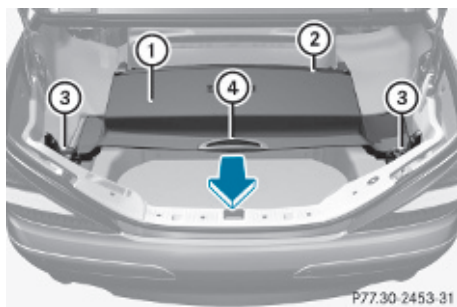

Closed luggage cover

- ① Luggage cover
- ② Zipper
- ③ Side holder
- ④ Handle

- ▶ Fold back the entire length of the zipper's cloth cover.
- ▶ Open zipper ② completely while the luggage cover is closed.
- ▶ Open luggage cover ①.



Opened luggage cover

- ⑤ Tensioning clasp
- ⑥ Retainer spring

⚠ Warning!

Only open the tensioning clasps when the luggage cover is opened. You could otherwise be injured.

- ▶ Open tensioning clasps ⑤ by pulling them downward.
- ▶ Unhook retainer springs ⑥ from holders and flip retainer springs all the way up.



- ⑦ Luggage cover
- ⑧ Cloth end
- ⑨ Cloth holder

- ▶ Carefully tilt luggage cover ⑦ in direction of arrow towards rear of trunk.
- ▶ Roll up front end of cloth ⑧ in the trunk towards the front and fasten it in place in front of cloth holder ⑨.
- ▶ Remove luggage cover ⑦ from the trunk.

Installing

- ! Before installing the luggage cover, make sure that the cloth end is in front of the cloth holder. Otherwise, it could be damaged.

- ▶ Carefully place luggage cover in trunk.

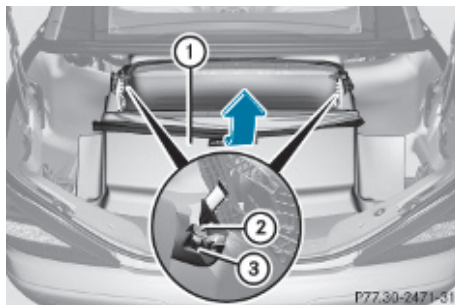

- ▶ Insert luggage cover ① into guide rails ③ on both sides using hooks ②.
- ▶ Tilt luggage cover ① forward in direction of arrow.
- ▶ Fold retainer springs of tensioning clasps downward and clip them into holders on both sides (▶ page 159).
- ▶ Close tensioning clasps on both sides by pressing them upward.
- ▶ Pull handle of luggage cover towards the rear.
- ▶ Clip eyelets onto side trim panels.
- ▶ Close the zipper completely.
- ▶ Fold back the zipper's cloth cover across the entire length of the luggage cover.

Sunshade for panorama roof

The sunshade protects you from excessive sunlight coming in through the panorama roof.

⚠ Warning!

Do not operate the sunshade while driving. Adjusting the sunshade while driving could cause the driver to lose control of the vehicle.

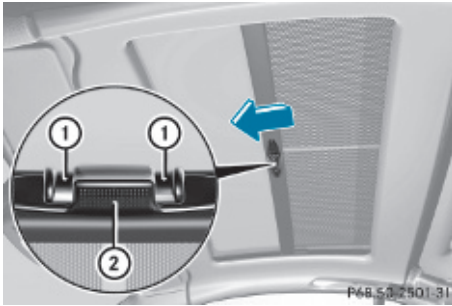

- ▶ **Opening:** Squeeze stop buttons ① and guide the sunshade towards the rear.
- ▶ **Closing:** Using handle ②, slide the sunshade towards the front of the vehicle.

Loading and storing

Parcel nets

⚠ Warning!

Parcel nets are intended for storing light-weight items only, such as road maps, mail, etc.

Heavy objects, objects with sharp edges, or fragile objects may not be transported in the parcel nets. In an accident, during hard braking, or sudden maneuvers, they could be thrown around inside the vehicle and cause injury to vehicle occupants.

Parcel nets cannot protect transported goods in the event of an accident.

A parcel net is located in the passenger footwell.

Two parcel nets are located in the trunk on each side of the right and left trunk side walls. In addition a trunk floor net is available to secure loads.

- ▶ Pull the trunk floor net from the trunk back wall towards the front over the luggage.
- ▶ Hang the hooks of the trunk floor net on the eyes on the trunk floor.

Front storage compartments

⚠ Warning!

To help avoid personal injury during a collision or sudden maneuver, exercise care when storing objects in the vehicle. Put luggage or cargo in the trunk if possible.

Do not pile luggage or cargo higher than the seat backrests.

Keep compartment lids closed. This will help to prevent stored objects from being thrown about and injuring vehicle occupants during

- braking
- vehicle maneuvers
- an accident

Glove box

Depending on vehicle equipment, an AUX socket is located in the glove box. For information on AUX operation, see separate COMAND system operating instructions.

The glove box can be ventilated (▷ page 152).

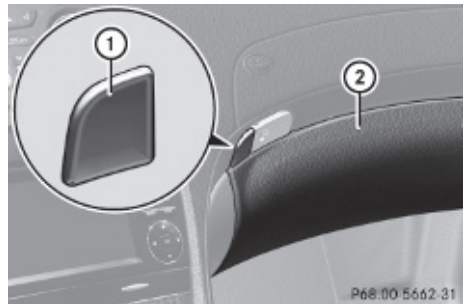

- ▶ **Opening:** Press glove box lid release ①.
- ▶ **Closing:** Push glove box lid ② upwards until it engages.

Locking/unlocking the storage compartments separately

The storage compartments are centrally locked when you lock the vehicle from the outside.

You can also lock the storage compartments separately, e.g. when the vehicle is in the shop for service.

The following storage compartments remain locked, even when the vehicle is unlocked with the SmartKey:

- Glove box
- Storage compartment under the armrest
- Rear storage compartments

The separate locking status of these storage compartments can only be canceled with the mechanical key.

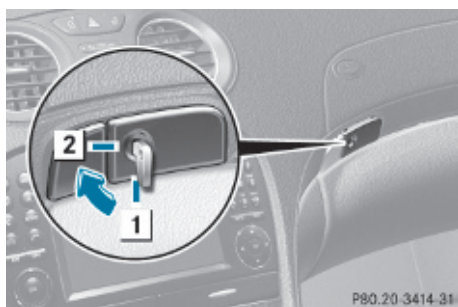



- 1 Separately unlocking storage compartments
- 2 Separately locking storage compartments

- i** If the glove box cannot be unlocked using the SmartKey, see “Unlocking the glove box” (▷ page 268).

Armrest storage compartment

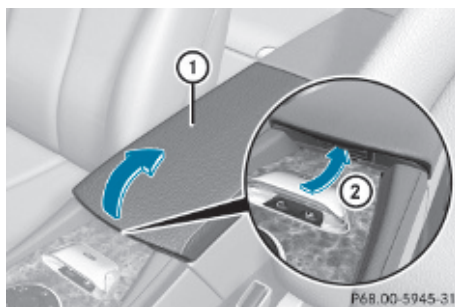
Depending on vehicle equipment, a media interface is located in the storage compartment. For information on media interface, see separate COMAND system operating instructions.



- i** The Roadside Assistance button  (▷ page 169) and the Information button  (▷ page 170) are located in the storage compartment.

- ▶ **Opening:** Press storage compartment release button ② and lift armrest ① in direction of arrow.
- ▶ **Closing:** Lower armrest ① until it engages.

Seat storage compartments

A storage compartment is located in the seat base of each seat.

The passenger seat storage compartment contains the first aid kit, see “First aid kit” (▷ page 224).

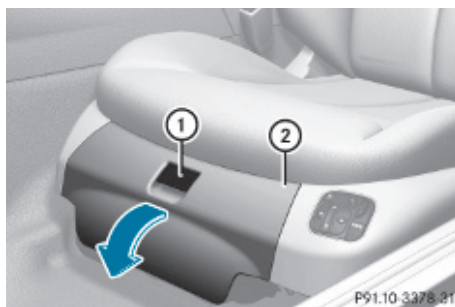

- ▶ **Opening:** Pull handle ① up.
- ▶ Fold storage compartment lid ② forward in direction of arrow.

Door storage compartments

Warning!

Keep the door storage compartments closed while vehicle is in motion. Failure to do so may cause the seat belt to catch at the rear and prevent proper positioning of the seat belt.

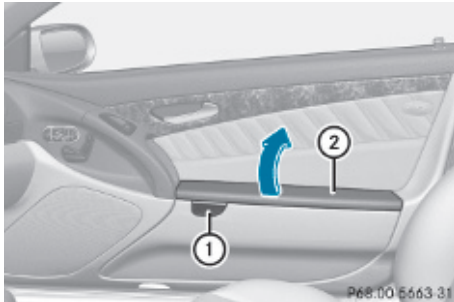

- ① Release button
- ② Storage compartment lid

► **Opening:** Press release button ①.

Rear storage compartments

Warning!

To help avoid personal injury during a collision or sudden maneuver, exercise care when storing objects in the vehicle. Put luggage or cargo in the trunk if possible.

Do not pile luggage or cargo higher than the seat backrests.

Keep compartment lids closed. This will help to prevent stored objects from being thrown about and injuring vehicle occupants during

- braking
- vehicle maneuvers
- an accident

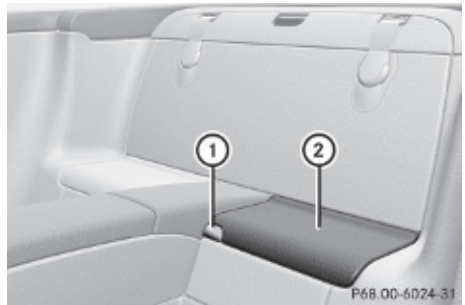

Driver's side rear storage compartment

- ① Release button
- ② Storage compartment lid

► **Opening:** Press release button ①.

Luggage compartment in the rear

Warning!

Secure all pieces of luggage in the rear with the luggage straps. Unsecured pieces of luggage can otherwise cause injury during a braking maneuver and can increase the risk of injury in an accident.

Never allow anyone to ride in the rear.

The luggage straps can only secure light luggage items. Carry heavy pieces of luggage in the trunk.

The rear compartment area is not designed or intended to accommodate occupants. Severe personal injury or death may be the result in an accident.

Warning!

The shelf below the rear window should not be used to carry objects. This will avoid such objects from being thrown about and injuring vehicle occupants during an accident or sudden maneuver.

The trunk is the preferred place to carry objects.

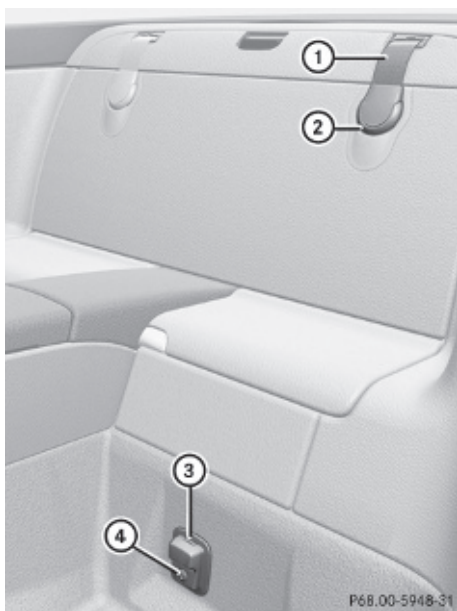

- ▶ **Securing luggage:** Pull strap ① out of holder ②.
- ▶ Secure the luggage with strap ① so that it cannot move.
- ▶ Insert strap ① into latch ③.
- ▶ **Releasing strap:** Press release button ④ and guide strap ① back to holder ②.

Load assist in the trunk

To facilitate trunk loading after opening the trunk lid, use the load assist feature to raise the retracted hardtop from its storage position in the trunk.

Warning!

To prevent injuries, make sure that there is no possibility of body parts getting caught in moving parts. If potential danger exists, press the switch again. This will immediately stop the movement of the hardtop.

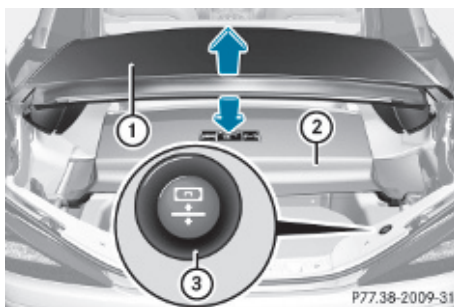

Hardtop ① can only be raised or lowered when luggage cover ② is closed and the trunk lid is completely opened.

- ▶ **Raising the hardtop:** Press load assist button ③.
Retracted hardtop ① rises a short distance. Load assist button ③ comes on brightly. You can now open luggage cover ②.
- ▶ **Lowering the hardtop:** Close luggage cover ②.
- ▶ Press load assist button ③.
Hardtop ① lowers. Load assist button ③ is dimly lit.
- ❗ Only close the trunk if the hardtop is completely lowered. Otherwise you could damage the hardtop.

If you begin to close the trunk lid before the hardtop is completely lowered, the load assist button will flash and a warning will sound.

Useful features

Cup holder

Warning!

In order to help prevent spilling liquids on vehicle occupants and/or vehicle equipment, only use containers that fit into the cup holder. Use lids on open containers and do not fill containers to a height where the contents, especially hot liquids, could spill

during braking, vehicle maneuvers, or in an accident. Liquids spilled on vehicle occupants may cause serious personal injury. Liquids spilled on vehicle equipment may cause damage not covered by the Mercedes-Benz Limited Warranty.

When not in use, keep the cup holder closed. An open cup holder may cause injury to you or others when contacted during braking, vehicle maneuvers, or in an accident.

Keep in mind that objects placed in the cup holder may come loose during braking, vehicle maneuvers, or in an accident and be thrown around in the vehicle interior. Objects thrown around in the vehicle interior may cause an accident and/or serious personal injury.

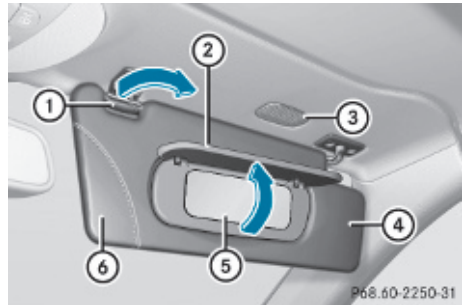

- ① Mounting
- ② Vanity mirror cover
- ③ Vanity mirror lamp
- ④ Sun visor
- ⑤ Vanity mirror
- ⑥ Holder, e.g. for gas cards

Glare through the windshield

- ▶ Flip sun visor ④ down when you experience glare.

Glare through a door window

- ▶ Close vanity mirror cover ② if opened.
- ▶ Disengage sun visor ④ from mounting ①.
- ▶ Pivot sun visor ④ to the side.

Vanity mirror

The vanity mirror lamp only functions when the sun visor is engaged in mounting ①.

- ▶ Flip sun visor ④ down.
- ▶ Lift up vanity mirror cover ②.
Vanity mirror lamp ③ comes on.



- ▶ **Opening:** Briefly press cup holder cover ① or ②.
- ▶ **Closing:** Press cup holder cover ① or ② until the cup holder engages.

Sun visors

Warning!

Do not use the vanity mirror while driving. Keep the vanity mirrors in the sun visors closed while vehicle is in motion. Reflected glare can endanger you and others.

Ashtray

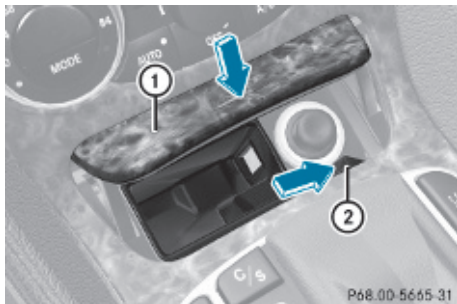

- ▶ **Opening:** Briefly touch cover plate ①.
- ▶ **Removing ashtray insert:** Secure vehicle from movement by engaging the parking brake.
- ▶ Shift the automatic transmission into neutral position **N**.
- ▶ Press sliding knob ② to the right. The ashtray insert will eject a short distance.
- ▶ **Reinstalling ashtray insert:** Press ashtray insert into the frame until it snaps into place.
- ▶ **Closing:** Push down cover plate ①.

Cigarette lighter

⚠ **Observe Safety notes, see page 51.**

⚠ **Warning!**

Never touch the heating element or sides of the lighter; they are extremely hot. Hold the knob only.

Make sure any children traveling with you do not injure themselves or start a fire with the hot cigarette lighter.

If the engine is off and the cigarette lighter is being used extensively, the vehicle battery may become discharged.

- ▶ Open the cover (▷ page 166).

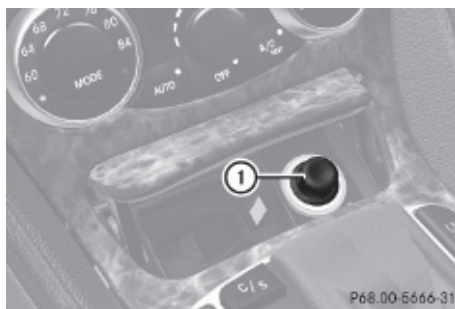

- ▶ Switch on the ignition.
- ▶ Push in cigarette lighter ①. Cigarette lighter ① will pop out automatically when hot.
- ▶ Take out cigarette lighter ①.
- ▶ Reinsert cigarette lighter ① in its socket after use.

Power outlet

The power outlet can be used to accommodate 12V DC electrical accessories (e.g. auxiliary lamps, mobile phone chargers) up to a maximum of 15 A (180 W).

- ▶ Switch on the ignition.

Power outlet in trunk

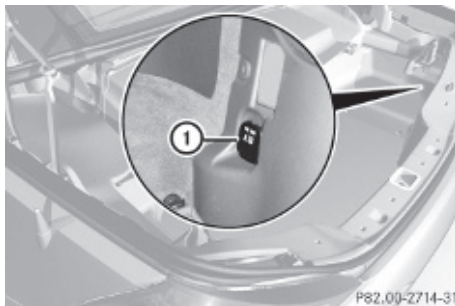

If the engine is off and power outlet ① is being used extensively, the vehicle battery may become discharged.

Tele Aid

! In order to activate the Tele Aid system, a subscriber agreement must be completed. To ensure your system is activated and operational, please press Information button  to perform the acquaintance call. Failure to complete either of these steps may result in a system that is not activated.

If you have any questions regarding activation, please call the Customer Assistance Center at 1-800-FOR-MERcedes (1-800-367-6372) (USA only) or 1-888-923-8367 (Canada only).

Shortly after the completion of your Tele Aid acquaintance call, you will receive a user ID and password in the mail. You may use this password to access the Tele Aid section in “Owner’s Online” at www.mbusa.com (USA only). The “My Tele Aid” section will give you access to account information, remote door unlock and more.

The Tele Aid system is available if

- it has been activated and is operational. Activation requires a subscription for monitoring services, connection and cellular air time
 - vehicle battery power is available
 - the relevant cellular phone network and GPS signals are available and pass the information on to the Customer Assistance Center
- i** Location of the vehicle on a map is only possible if the vehicle is able to receive signals from the GPS satellite network and pass the information on to the Customer Assistance Center.



The Tele Aid system

(Telematic Alarm Identification on Demand)

The Tele Aid system consists of three types of response:

- Automatic and manual emergency
- Roadside Assistance
- Information

To adjust the speaker volume during a Tele Aid call do the following:

▶ Press button  or  on the multifunction steering wheel.

or

▶ Use the adjustment button on your COMAND system.





Be sure to check “Owner’s Online” at www.mbusa.com (USA only) for more information and a description of all available features.

System self-test

The system performs a self-test after you have switched on the ignition.

Warning!

A malfunction in the system has been detected if any or all of the following conditions occur:

- The indicator lamp in the SOS button does not come on during the system self-test.
- The indicator lamp in Roadside Assistance button  does not come on during the system self-test.
- The indicator lamp in Information button  does not come on during the system self-test.
- The indicator lamp in the SOS button, Roadside Assistance button , or Information button  remains illuminated constantly in red after the system self-test.
- The message Tele Aid Inoperative appears in the multifunction display after the system self-test.

If a malfunction is indicated as outlined above, the system may not operate as expected. In case of an emergency, help will have to be summoned by other means.

Have the system checked at the nearest Mercedes-Benz Center or contact the Customer Assistance Center at 1-800-FOR-MERCEdes (1-800-367-6372) (USA only) or 1-888-923-8367 (Canada only) as soon as possible.

Emergency calls

! In order to activate the Tele Aid system, a subscriber agreement must be completed. To ensure your system is activated and operational, please press Information button  to perform the acquaintance call. Failure to complete either of these steps may result in a system that is not activated.

If you have any questions regarding activation, please call the Customer Assistance Center at 1-800-FOR-MERCEdes (1-800-367-6372) (USA only) or 1-888-923-8367 (Canada only).

An emergency call is initiated automatically following an accident in which the Emergency Tensioning Devices (ETDs) or air bags have deployed.

i An automatically initiated Tele Aid emergency call cannot be canceled.

An emergency call can also be initiated manually ([▷ page 168](#)).

Once the emergency call is in progress, the indicator lamp in the SOS button will begin to flash. The message **Connecting Call** appears in the multifunction display and the COMAND system is muted. When the connection is established, the message **Call Connected** appears in the multifunction display.

All information relevant to the emergency, such as the location of the vehicle

(determined by the GPS satellite location system), vehicle model, identification number and color are generated.

A voice connection between the Customer Assistance Center and the occupants of the vehicle will be established automatically soon after the emergency call has been initiated. The Customer Assistance Center will attempt to determine the nature of the emergency more precisely, provided they can speak to an occupant of the vehicle.

i If no vehicle occupant responds, an ambulance will be sent to the vehicle immediately.

Warning!

If the indicator lamp in the SOS button is flashing continuously and there was no voice connection to the Customer Assistance Center established, then the Tele Aid system could not initiate an emergency call (e.g. the relevant cellular phone network is not available).

The message **Call Failed** appears in the multifunction display for approximately 10 seconds.

Should this occur, assistance must be summoned by other means.

i The “911” emergency call system is a public service. Using it without due cause is a criminal offense.

Initiating an emergency call manually

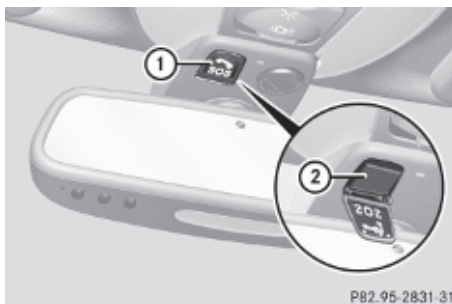

P82.95-2831-31

- ▶ Briefly press on cover ① to open.
- ▶ Press SOS button ② briefly.
The indicator lamp in SOS button ② will flash until the emergency call is concluded.
- ▶ Wait for a voice connection to the Customer Assistance Center.
- ▶ Close cover ① after the emergency call is concluded.

⚠ Warning!

If you feel at any way in jeopardy when in the vehicle (e.g. smoke or fire in the vehicle, vehicle in a dangerous road location), please do not wait for voice contact after you have pressed the emergency button. Carefully leave the vehicle and move to a safe location. The Customer Assistance Center will automatically contact local emergency officials with the vehicle's approximate location if they receive an automatic SOS signal and cannot make voice contact with the vehicle occupants.

- ▶ **Terminating calls:** Press button  on the multifunction steering wheel.
- or
- ▶ Press the respective button for ending a telephone call on the COMAND system.

Roadside Assistance button

- ▶ Open the storage compartment under the armrest (▷ page 162).

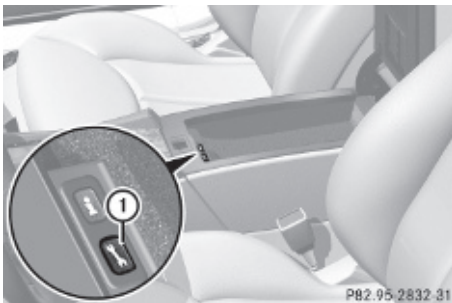

- ▶ Press and hold Roadside Assistance button ① for longer than 2 seconds. A call to a Mercedes-Benz Roadside Assistance dispatcher will be initiated. The indicator lamp in Roadside Assistance button ① will flash while the call is in progress. The message Connecting Call will appear in the multifunction display and the COMAND system is muted.

When the connection is established, the message Call Connected appears in the multifunction display. The Tele Aid system will transmit data generating the vehicle identification number, model, color and location (subject to availability of cellular and GPS signals).

- ⓘ The COMAND system display indicates that a Tele Aid call is in progress. While the call is connected you can change to the navigation menu by pressing the NAVI button on the COMAND system. Spoken commands are not available.

A voice connection between the Roadside Assistance dispatcher and the occupants of the vehicle will be established.

- ▶ Describe the nature of the need for assistance.

The Mercedes-Benz Roadside Assistance dispatcher will either dispatch a qualified Mercedes-Benz technician or arrange to tow your vehicle to the nearest authorized Mercedes-Benz Center. For services such as labor and/or towing, charges may apply. Refer to the Roadside Assistance manual for more information.

Sign and Drive services (USA only): Services such as a jump start, a few gallons of fuel or the replacement of a flat tire with the vehicle spare wheel are obtainable at no charge.

- ⓘ If the indicator lamp in Roadside Assistance button ① is flashing continuously and there was no voice connection to the Customer Assistance Center established, then the Tele Aid

system could not initiate a Roadside Assistance call (e.g. the relevant cellular phone network is not available). The message **Call Failed** appears in the multifunction display.

- ▶ **Terminating calls:** Press button  on the multifunction steering wheel.
- or
- ▶ Press the respective button for ending a telephone call on the COMAND system.

Information button

- ▶ Open the storage compartment under the armrest (▶ page 162).

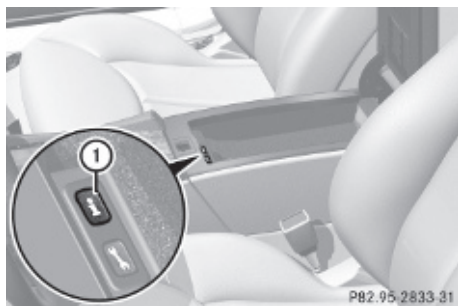

- ▶ Press and hold Information button ① for longer than 2 seconds. A call to the Customer Assistance Center will be initiated. The indicator lamp in Information button ① will flash while the call is in progress. The message **Connecting Call** will appear in the multifunction display and the COMAND system is muted.

When the connection is established, the message **Call Connected** appears in the multifunction display. The Tele Aid system will transmit data generating the vehicle identification number, model, color and location (subject to availability of cellular and GPS signals).

- ① The COMAND system display indicates that a Tele Aid call is in progress. While the call is connected you can change to the

navigation menu by pressing the NAVI button on the COMAND system. Spoken commands are not available.

A voice connection between the Customer Assistance Center representative and the occupants of the vehicle will be established. Information regarding the operation of your vehicle, the nearest authorized Mercedes-Benz Center or Mercedes-Benz USA products and services is available to you.

For more details concerning the Tele Aid system, please visit www.mbusa.com (USA only), log in to “Owner’s Online” and visit the “My Tele Aid” section to learn more.

- ① If the indicator lamp in Information button ① is flashing continuously and there was no voice connection to the Customer Assistance Center established, then the Tele Aid system could not initiate an Information call (e.g. the relevant cellular phone network is not available). The message **Call Failed** appears in the multifunction display.

- ▶ **Terminating calls:** Press button  on the multifunction steering wheel.
- or
- ▶ Press the respective button for ending a telephone call on the COMAND system.

Call priority

If other service calls such as a Roadside Assistance call or Information call are active, an emergency call is still possible. In this case, the emergency call will take priority and override all other active calls.

The indicator lamp in the respective button flashes until the call is concluded. Automatic initiated emergency calls can only be terminated by a Customer Assistance Center representative. All other calls can be terminated by pressing button  on the multifunction steering wheel or the respective button for ending a telephone call on the COMAND system.

- i** When a Tele Aid call has been initiated, the COMAND system audio is muted. The mobile phone is no longer connected to the COMAND system. If you must use this phone, we recommend that you use it only with the vehicle at a standstill in a safe location.



Destination Download to the COMAND system

- i** The components and operating principles of the COMAND system can be found in the separate COMAND system operating instructions.

Destination Download allows you access to a database of over 10 million points of interest (POIs) that can be downloaded to your vehicle's navigation system. If you know the destination, the address can be downloaded, or can be provided with points of interests near your location.

Route guidance

You will be prompted to confirm that route guidance to the entered address is to be started.

- ▶ Select Yes using button  or  on the COMAND system.
- ▶ Press button  on the COMAND system to confirm.

The system calculates the route and subsequently starts the route guidance to the defined address.

- i** If you select No, you can save the address to your address book.
- i** The Destination Download feature is available if the relevant mobile phone network is available and data connection is possible.

Search & Send

“Search & Send” is a navigation destination address entry service. For more information

on “Search & Send”, refer to separate COMAND system operating instructions.

Remote door unlock

In case you have locked your vehicle unintentionally (e.g. SmartKey inside vehicle), and the reserve SmartKey is not available:

- ▶ Contact the Customer Assistance Center at 1-800-FOR-MERCEdes (1-800-367-6372) (USA only) or 1-888-923-8367 (Canada only). You will be asked to provide your password.
- ▶ Then return to your vehicle at the time arranged with the Customer Assistance Center and pull the trunk recessed handle for a minimum of 20 seconds until the indicator lamp in the SOS button is flashing. The message *Connecting Call* appears in the multifunction display.

As an alternative, you may unlock the vehicle via Internet in the “My Tele Aid” section of “Owner’s Online”, using your ID and password (USA only).

- i** The remote door unlock feature is available if the relevant cellular phone network is available.

The SOS button will flash and the message *Call Connected* will appear in the multifunction display to indicate receipt of the door unlock command.

If the trunk recessed handle was pulled for more than 20 seconds before door unlock authorization was received by the Customer Assistance Center, you must wait 15 minutes before pulling the trunk recessed handle again.

Stolen Vehicle Recovery Services

In the event your vehicle was stolen:

- ▶ Report the incident to the police.
The police will issue a numbered incident report.
- ▶ Pass this number on to the Customer Assistance Center along with your password.
The Customer Assistance Center will then attempt to covertly contact the vehicle's Tele Aid system. Once the vehicle is located, the Customer Assistance Center will contact the local law enforcement and you. The vehicle's location will only be provided to law enforcement.

i If the anti-theft alarm or the tow-away alarm stays on for more than 30 seconds, a call to the Customer Assistance Center is initiated automatically by the Tele Aid system provided Tele Aid service was subscribed to and properly activated, and that necessary cellular service and GPS coverage are available. See "Anti-theft alarm system" (▶ page 63) and "Tow-away alarm" (▶ page 64).

Garage door opener

The integrated remote control can operate up to three separately controlled devices compatible with HomeLink® or some other systems.

Warning!

Before programming the integrated remote control to a garage door opener or gate operator, make sure people and objects are out of the way of the device to prevent potential harm or damage. When programming a garage door opener, the door moves up or down. When programming a gate operator, the gate opens or closes.

Do not use the integrated remote control with any garage door opener that lacks safety stop and reverse features as required by U.S.

federal safety standards (this includes any garage door opener model manufactured before April 1, 1982). A garage door that cannot detect an object - signaling the door to stop and reverse - does not meet current U.S. federal safety standards.

When programming a garage door opener, park vehicle outside the garage.

Do not run the engine while programming the integrated remote control. Inhalation of exhaust gas is hazardous to your health. All exhaust gas contains carbon monoxide (CO), and inhaling it can cause unconsciousness and possible death.

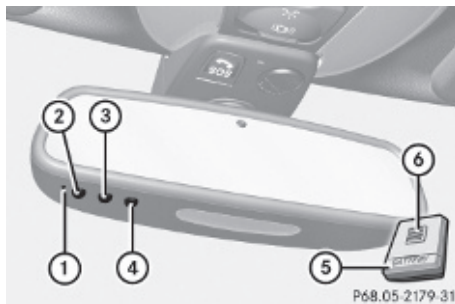

Interior rear view mirror with integrated remote control

Hand-held remote control ⑤ is not part of the vehicle equipment.

Programming the integrated remote control

- ▶ **Step 1:** Switch on the ignition.
- ▶ **Step 2:** If you have previously programmed a signal transmitter button and wish to retain its programming, proceed to step 3.
or
- ▶ If you are programming the integrated remote control for the first time, press and hold the two outer signal transmitter buttons ② and ④ and release them when indicator lamp ① begins to flash after approximately 20 seconds.

Do not hold the buttons for longer than 30 seconds.

This procedure erases any previous settings for all three channels and initializes the memory. If you later wish to program a second and/or third hand-held transmitter to the remaining two signal transmitter buttons, do not repeat this step and begin directly with step 3.

- ▶ **Step 3:** Hold the end of hand-held remote control ⑤ of the device you wish to train approximately 2 to 12 in (5 to 30 cm) away from the signal transmitter button (②, ③ or ④) to be programmed, while keeping indicator lamp ① in view.
- ▶ **Step 4:** Using both hands, simultaneously press hand-held remote control button ⑥ and the desired signal transmitter button (②, ③ or ④). Do not release the buttons until step 5 is completed. Indicator lamp ① will flash, first slowly and then rapidly.
 - ❗ Indicator lamp ① flashes immediately the first time the signal transmitter button is programmed. If this button has already been programmed, the indicator lamp will start flashing after 20 seconds.
- ▶ **Step 5:** After indicator lamp ① changes from a slow to a rapidly flashing light, release the hand-held remote control button and the signal transmitter button.
- ▶ **Step 6:** Press and hold the just-trained signal transmitter button (②, ③ or ④) and observe indicator lamp ①. If indicator lamp ① stays on constantly, programming is complete and your device should activate when the respective signal transmitter button (②, ③ or ④) is pressed and released.
 - ❗ If indicator lamp ① flashes rapidly for approximately 2 seconds and then turns to a constant light, continue with programming steps 8 through 12 as your

garage door opener may be equipped with the “rolling code” feature.

- ▶ **Step 7:** To program the remaining two signal transmitter buttons, repeat the steps above starting with step 3.

Rolling code programming

To train a garage door opener (or other rolling code devices) with the rolling code feature, follow these instructions after completing the “Programming” portion (steps 1 through 6) of this text. For your convenience and to complete the procedure faster, you might want to have someone assist you.

- ▶ **Step 8:** Locate the “training” button on the garage door opener motor head unit.

- ❗ Exact location and color of the button may vary by garage door opener brand. Depending on manufacturer, the “training” button may also be referred to as “learn” or “smart” button. If there is difficulty locating the transmitting button, refer to the garage door opener Operator’s Manual.

- ▶ **Step 9:** Press the “training” button on the garage door opener motor head unit. The “training light” is activated. You have 30 seconds to initiate the following two steps.
- ▶ **Step 10:** Return to the vehicle and firmly press, hold for 2 seconds and release the programmed signal transmitter button (②, ③ or ④).
- ▶ **Step 11:** Press, hold for 2 seconds and release same signal transmitter button a second time to complete the training process.

- ❗ Some garage door openers (or other rolling code equipped devices) may require you to press, hold for 2 seconds and release the same signal transmitter button a third time to complete the training process.

- ▶ **Step 12:** Confirm the garage door operation by pressing the programmed signal transmitter button (②, ③ or ④).
- ▶ **Step 13:** To program the remaining two signal transmitter buttons, repeat the steps above starting with step 3.

Gate operator/Canadian programming

Canadian radio-frequency laws require transmitter signals to “time-out” (or quit) after several seconds of transmission which may not be long enough for the integrated signal transmitter to pick up the signal during programming. Similar to this Canadian law, some U.S. gate operators are designed to “time-out” in the same manner.

If you live in Canada or if you are having difficulties programming a gate operator (regardless of where you live) by using the programming procedures, replace step 4 with the following:

- ▶ **Step 4:** Press and hold the signal transmitter button (②, ③ or ④). Do not release this button until it has been successfully trained.
- ▶ While still holding down the signal transmitter button (②, ③ or ④), “cycle” your hand-held remote control button ⑥ as follows: Press and hold button ⑥ for 2 seconds, then release it for 2 seconds, and again press and hold it for 2 seconds. Repeat this sequence on the hand-held remote control until the frequency signal has been learned.
Upon successful training, indicator lamp ① will flash slowly and then rapidly after several seconds.
- ▶ Proceed with programming step 5 and step 6 to complete.

- ① Upon completion of programming the integrated remote control, make sure you retain the hand-held remote control that came with the garage door opener, gate operator or other device. You may need it for use in other vehicles, for future programming of an integrated remote

control, or simply for continued use as a hand-held remote control to operate the respective device in other situations.

Reprogramming a single signal transmitter button

To program a device using a signal transmitter button previously trained, follow these steps:

- ▶ Switch on the ignition.
- ▶ Press and hold the desired signal transmitter button (②, ③ or ④). Do not release the button.
Indicator lamp ① will begin to flash after 20 seconds.
- ▶ Without releasing the signal transmitter button, proceed with programming starting with step 3.

Operation of integrated remote control

- ▶ Switch on the ignition.
- ▶ Select and press the appropriate integrated signal transmitter button (②, ③ or ④) to activate the remote controlled device.
The integrated remote control transmitter continues to send the signal as long as the button is pressed – up to 20 seconds.

Erasing the integrated remote control memory

- ① If you sell your vehicle, erase the codes of all three channels.
- ▶ Switch on the ignition.
- ▶ Simultaneously press and hold outer signal transmitter buttons ② and ④, for approximately 20 seconds, until indicator lamp ① flashes rapidly. Do not hold for longer than 30 seconds.
The codes of all three channels are erased.

Programming tips

If you are having difficulty programming the integrated remote control, here are some helpful tips:

- Check the frequency of hand-held remote control ⑤ (typically located on the reverse side of the remote). The integrated remote control is compatible with radio-frequency devices operating between 280-390 MHz.
- Put a new battery in hand-held remote control ⑤. This will increase the likelihood of the hand-held remote control sending a stronger and more accurate signal to the integrated remote control.
- While performing step 3, hold hand-held remote control ⑤ at different lengths and angles from the signal transmitter button (②, ③ or ④) you are programming. Attempt varying angles at the distance of 2 to 12 inches (5 to 30 cm) away or the same angle at varying distances.
- If another hand-held remote control is available for the same device, try the programming steps again using that other hand-held remote control. Make sure new batteries are in the hand-held remote control before beginning the procedure.
- Straighten the antenna wire from the garage door opener assembly. This may help improve transmitting and/or receiving signals.

- i** Certain types of garage door openers are incompatible with the integrated remote control. If you should experience further difficulties with programming the integrated remote control, contact an authorized Mercedes-Benz Center, or call the Mercedes-Benz Customer Assistance Center (USA only) at 1-800-FOR-MERcedes (1-800-367-6372), or the HomeLink® Hotline (USA only) at 1-800-355-3515, or the Customer Service (Canada only) at 1-800-387-0100.

i USA only:

This device complies with Part 15 of the FCC Rules. Operation is subject to the following two conditions:

1. This device may not cause harmful interference, and
2. this device must accept any interference received, including interference that may cause undesired operation.

Any unauthorized modification to this device could void the user's authority to operate the equipment.

i Canada only:

This device complies with RSS-210 of Industry Canada. Operation is subject to the following two conditions:

1. This device may not cause interference, and
2. this device must accept any interference received, including interference that may cause undesired operation of the device.

Any unauthorized modification to this device could void the user's authority to operate the equipment.

Floormats

⚠ Warning!

Whenever you are using floormats, make sure there is enough clearance and that the floormats are securely fastened.

Floormats should always be securely fastened using the fastening equipment.

Before driving off, check that the floormats are securely in place and adjust them if necessary. A loose floormat could slip and hinder proper functioning of the pedals.

Do not place several floormats on top of each other as this may impair pedal movement.

- ▶ Move the driver's seat or passenger seat as far to the rear as possible.

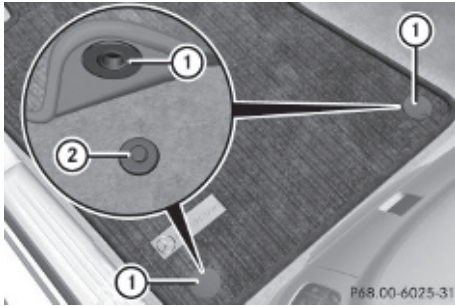

- ▶ **Removing:** Pull floormat off of retainer pins ②.
- ▶ **Installing:** Press floormat eyelets ① onto retainer pins ②.

Vehicle equipment	178
The first 1000 miles (1500 km)	178
At the gas station	178
Engine compartment	180
Tires and wheels	186
Winter driving	207
Driving instructions	209
Maintenance	213
Vehicle care	215



Vehicle equipment

- i** This Operator's Manual describes all features, standard or optional, potentially available for your vehicle at the time of purchase. Please be aware that your vehicle might not be equipped with all features described in this manual.

The first 1000 miles (1500 km)

The more cautiously you treat your vehicle during the break-in period, the more satisfied you will be with its performance later on.

- Drive your vehicle during the first 1 000 miles (1 500 km) at varying but moderate vehicle and engine speeds.
- During this period, avoid heavy loads (full throttle driving) and excessive engine speeds (no more than $\frac{2}{3}$ of maximum rpm in each gear).
- Select **C** as the preferred shift program (▷ page 106) for the first 1 000 miles (1 500 km).
- Avoid accelerating by kickdown.
- Do not attempt to slow the vehicle down by shifting to a lower gear using the gear selector lever.
- Select gear ranges **3**, **2** or **1** (▷ page 106) only when driving at moderate speeds (for hill driving).

After 1 000 miles (1 500 km) you may gradually increase vehicle and engine speeds to the permissible maximum.

- !** Additional instructions for AMG vehicles:
 - During the first 1 000 miles (1 500 km), do not exceed a speed of 85 mph (140 km/h).
 - During this period, avoid engine speeds above 4 500 rpm in each gear.
 - Shift gears in a timely manner.

All of the above instructions, as may apply to your vehicle type, also apply when driving the first 1 000 miles (1 500 km) after the engine or the rear differential has been replaced.

- i** Always obey applicable speed limits.

At the gas station

Refueling

Warning!

Gasoline is highly flammable and poisonous. It burns violently and can cause serious personal injury.

Never allow sparks, flames or smoking materials near gasoline!

Turn off the engine before refueling.

Whenever you are around gasoline, avoid inhaling fumes and any skin or clothing contact. Extinguish all smoking materials.

Direct skin contact with fuels and the inhalation of fuel vapors are damaging your health.

Warning!

Overfilling of the fuel tank may create pressure in the system which could cause a gas discharge. This could cause the gas to spray back out when removing the fuel pump nozzle, which could cause personal injury.

- !** Never refuel vehicles with gasoline engine with diesel fuel. Even small amounts of diesel fuel will damage the fuel system and engine. Damage resulting from the use of non-approved fuels or fuel additives or resulting from mixing gasoline with diesel fuel is not covered by the Mercedes-Benz Limited Warranty.

- !** If you have accidentally filled the tank with incorrect or non-approved fuel, do not switch on the ignition. Otherwise the incorrect or non-approved fuel will get into the fuel lines. The fuel system must be drained completely. Contact an authorized

Mercedes-Benz Center to have the fuel system drained completely.

! To prevent damage to the catalytic converters, only use premium unleaded gasoline in this vehicle.

Any noticeable irregularities in engine operation should be repaired promptly.

Otherwise, excessive unburned fuel may reach the catalytic converter, causing it to overheat and potentially start a fire.

i Only use premium unleaded gasoline with a minimum Posted Octane Rating of 91 (average of 96 RON/86 MON). Information on gasoline quality can normally be found on the fuel pump. Please contact gas station personnel in case labels on the pump cannot be found.

For more information on gasoline, see “Premium unleaded gasoline”

(▷ page 306), see “Fuel requirements” (▷ page 307), or contact an authorized Mercedes-Benz Center, or visit **www.mbusa.com** (USA only).



Locking/unlocking the vehicle with the SmartKey or KEYLESS-GO automatically locks/unlocks the fuel filler flap.

i In case the central locking system does not release the fuel filler flap, or the opening mechanism is clamping, contact Roadside Assistance or an authorized Mercedes-Benz Center.

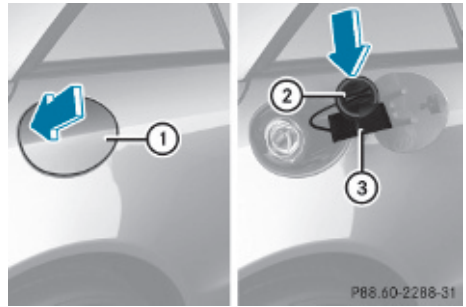
The fuel filler flap is located on the right-hand side of the vehicle towards the rear.



▶ Turn off the engine.

i Leaving the engine running and the fuel filler cap open can cause the yellow fuel tank reserve warning lamp to flash and the malfunction indicator lamp  (USA only¹⁴) or  (Canada only¹⁴) to illuminate.

For more information, see also “Practical hints” (▷ page 263).

▶ Remove the SmartKey from the starter switch.

KEYLESS-GO: Open the driver’s door. This puts the starter switch in position **0**, same as with the SmartKey removed from the starter switch. The driver’s door then can be closed again.

▶ **Opening:** Press fuel filler flap **①** at the point indicated by the arrow.

▶ Turn fuel filler cap **②** counterclockwise.

▶ Take off fuel filler cap **②**.

▶ Place fuel filler cap **②** in direction of arrow into holder **③**.

▶ Fully insert filler nozzle unit and refuel.

▶ Only fill your tank until the filler nozzle unit cuts out – **do not top off or overfill.**

▶ **Closing:** Turn fuel filler cap **②** clockwise until it audibly engages.

▶ Close fuel filler flap **①**.

¹⁴ Depending on vehicle production date, U.S. vehicles may be equipped with the Canada engine malfunction indicator lamp .

Check regularly and before a long trip

For information on quantities and requirements of operating agents, see “Fuels, coolants, lubricants, etc.” (▷ page 303).

Check the following:

- Engine oil level (▷ page 181)
- Tire inflation pressure (▷ page 189)
- Coolant level (▷ page 184)
- Vehicle lighting (▷ page 271)
- Washer system and headlamp cleaning system (▷ page 185)
- Brake fluid (▷ page 185)

Engine compartment**Hood****⚠ Warning!**

Do not pull the release lever while the vehicle is in motion. Otherwise the hood could be forced open by passing air flow.

This could cause the hood to come loose and injure you and/or others.

Opening**⚠ Warning!**

Do not open the hood when the engine is overheated. You could be seriously injured. Observe the coolant temperature gauge to determine whether the engine may be overheated. If you see flames or smoke coming from the engine compartment, move away from the vehicle. Wait until the engine has cooled. If necessary, call the fire department.

⚠ Warning!

You could be injured when the hood is open – even when the engine is turned off.

Parts of the engine can become very hot. To prevent burns, let the engine cool completely before touching any components on the

vehicle. Comply with all relevant safety precautions.

⚠ Warning!

To help prevent personal injury, stay clear of moving parts when the hood is open and the engine is running.

The radiator fan may continue to run for approximately 30 seconds or may even restart after the engine has been turned off. Stay clear of fan blades.

⚠ Warning!

The engine is equipped with a transistorized ignition system. Because of the high voltage it is dangerous to touch any components (ignition coils, spark plug sockets, diagnostic socket) of the ignition system

- with the engine running
- while starting the engine
- when the ignition is switched on and the engine is turned manually

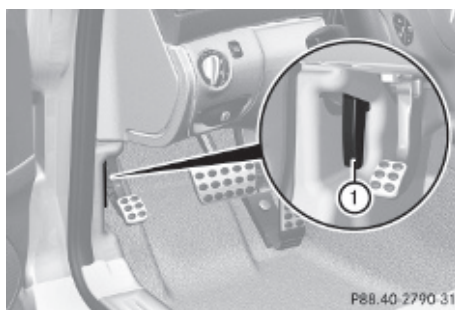

- ▶ Pull hood lock release lever ①. The hood is unlocked.

- ❗ Never open the hood if the wiper arms are folded forward away from the windshield. Otherwise the windshield wipers or the hood could be damaged.



- ▶ Push handle ② under the hood upwards.
- ▶ Pull up on the hood and then release it. The hood will be held open at shoulder height by gas-filled struts automatically.

Closing

Warning!

When closing the hood, use extreme caution not to catch hands or fingers. Be careful that you do not close the hood on anyone.

Make sure the hood is securely engaged before driving off. Do not continue driving if the hood can no longer engage after an accident, for example. The hood could otherwise come loose while the vehicle is in motion and injure you and/or others.

- ▶ Let the hood drop from a height of approximately 8 in (20 cm).
- ▶ Check to make sure the hood is fully closed.

If you can raise the hood at a point above the headlamps, then it is not properly closed. Open it again and let it drop with somewhat greater force.

Engine oil

The amount of oil your engine consumes will depend on a number of factors, including driving style. Increased oil consumption can occur when the vehicle is new or the vehicle is driven frequently at higher engine speeds.

Engine oil consumption checks should only be made after the vehicle break-in period.

! Do not use any special lubricant additives, as these may damage the drive assemblies. Using special additives not approved by Mercedes-Benz may cause damage not covered by the Mercedes-Benz Limited Warranty.

For further information contact an authorized Mercedes-Benz Center.

Notes on checking engine oil level

When checking the oil level the vehicle must be parked on level ground.

SL 550, SL 63 AMG: The vehicle must have been stationary for at least 5 minutes with the engine turned off.

SL 600, SL 65 AMG: With the engine at operating temperature, the vehicle must have been stationary for at least 5 minutes with the engine turned off.

With the engine not at operating temperature, the vehicle must have been stationary for at least 30 minutes with the engine turned off.

Checking engine oil level with the oil dipstick

On the SL 550 and SL 63 AMG you can check the engine oil level with the oil dipstick.

i In vehicles without an oil dipstick, the engine oil level is measured with the control system (> page 182).

- ▶ Open the hood (> page 180).

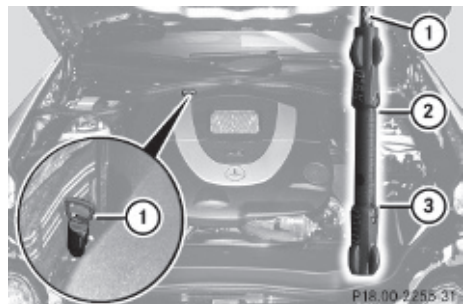

- ▶ Pull out oil dipstick ①.
- ▶ Wipe oil dipstick ① clean.
- ▶ Slowly insert oil dipstick ① fully into the dipstick guide tube.
- ▶ Pull out oil dipstick ① again after approximately 3 seconds to obtain accurate reading.

The oil level is correct when it is between lower (min) mark ③ and upper (max) mark ② of oil dipstick ①.

i SL 550 only:

The filling quantity between the upper and lower marks on the oil dipstick is approximately 2.1 US qt. (2.0 l).

i SL 63 AMG only:

The filling quantity between the upper and lower marks on the oil dipstick is approximately 1.6 US qt. (1.5 l).

- ▶ If necessary, add engine oil.

For more information on engine oil, see “Fuels, coolants, lubricants etc.” (▷ page 303).

For information on messages in the multifunction display concerning engine oil, see the “Practical hints” section (▷ page 247).



Checking engine oil level with the control system

On the SL 600 and SL 65 AMG you can check the engine oil level with the control system.

- i** In vehicles without engine oil measuring system, the engine oil level is measured with the oil dipstick (▷ page 181).

- ▶ Switch on the ignition.

The standard display appears in the multifunction display (▷ page 116).

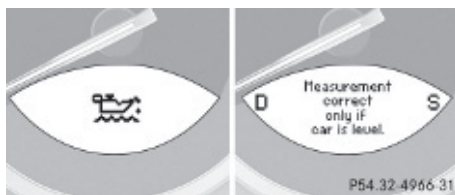

- ▶ Press button  or  on the multifunction steering wheel repeatedly until the following message appears in the multifunction displays:



- ▶ After about 3 seconds, the following message appears in the left multifunction display: Engine Oil Level Measuring Now.

One of the following messages will subsequently appear in the right multifunction display:

- Engine Oil Level OK
- Add 1.0 qt to reach max. oil level. (Canada: 1.0 liter)
- Add 1.5 qts to reach max. oil level. (Canada: 1.5 liters)
- Add 2.0 qts to reach max. oil level. (Canada: 2.0 liters)

- i** If you want to interrupt the checking procedure, press button  or  on the multifunction steering wheel.

- ▶ If necessary, add engine oil.

For more information on engine oil, see “Fuels, coolants, lubricants etc.” (▷ page 303).

Other display messages

If the ignition is not switched on, the following message appears in the multifunction display:

Turn ignition on to measure engine oil level.

- ▶ Switch on the ignition.

If you see the message:

Observe
Waiting Time

- ▶ If the engine is at operating temperature, wait 5 minutes before repeating check procedure.
- ▶ If the engine is not at operating temperature yet, you must wait 30 minutes before checking oil.

If you see the message:

Engine Oil Level
Not With
Engine Running

- ▶ Turn off the engine.
- ▶ If the engine is at operating temperature, wait 5 minutes before checking oil.
- ▶ If the engine is not at operating temperature yet, you must wait 30 minutes before checking oil.

If there is excess engine oil with the engine at normal operating temperature, the following message appears in the multifunction display:

Engine Oil Level
Reduce Oil Level

- ▶ Have excess oil siphoned or drained off. Contact an authorized Mercedes-Benz Center.

! Excess oil must be siphoned or drained off. It could cause damage to the engine and emission control system not covered by the Mercedes-Benz Limited Warranty.

For information on messages in the multifunction display concerning engine oil, see the “Practical hints” section (▶ page 249).

Adding engine oil

! Only use approved engine oils and oil filters required for vehicles with Maintenance System. For a listing of approved engine oils and oil filters, contact

an authorized Mercedes-Benz Center or visit www.mbusa.com (USA only).

The following will result in engine or emission control system damage not covered by the Mercedes-Benz Limited Warranty:

- Using engine oils and oil filters of specification other than those expressly required for the Maintenance System.
- Changing of oil and oil filter at change intervals longer than those called for by the Maintenance System.
- Using any oil additives.

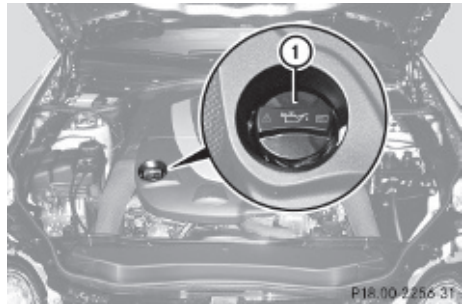

Example illustration: SL 550

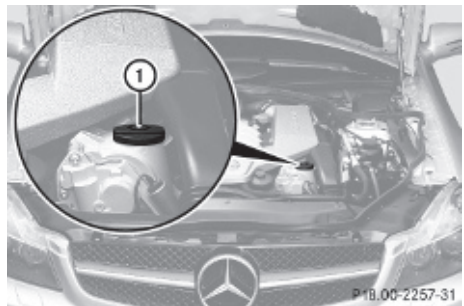

Example illustration: SL 63 AMG

- ▶ Unscrew filler cap ① from filler neck.
- ▶ Add engine oil as required. Be careful not to overfill with oil.

Be careful not to spill any oil when adding. Avoid environmental damage caused by oil entering the ground or water.

! Excess oil must be siphoned or drained off. It could cause damage to the engine and emission control system not covered by the Mercedes-Benz Limited Warranty.

► Screw filler cap ① back on filler neck.

For more information on engine oil, see the “Technical data” section (► page 303) and (► page 305).

Transmission fluid level

The transmission fluid level does not need to be checked. If you notice transmission fluid loss or gearshifting malfunctions, have an authorized Mercedes-Benz Center check the transmission.

Active Body Control (ABC) fluid level

Regular fluid level check is not required. If you notice fluid leaks or malfunction messages in the multifunction display, have an authorized Mercedes-Benz Center check the ABC system.

Coolant level

The engine coolant is a mixture of water and anticorrosion/antifreeze.

When checking the coolant level, the vehicle must be parked on level ground, and the coolant temperature must be below 158°F (70°C).

⚠ Warning!

In order to avoid any potentially serious burns:

- Use extreme caution when opening the hood if there are any signs of steam or coolant leaking from the cooling system, or if the coolant temperature gauge indicates that the coolant is overheated.
- Do not remove the cap on the coolant expansion tank if the coolant temperature is above 158°F (70°C). Allow the engine to

cool down before removing the cap. The coolant expansion tank contains hot fluid and is under pressure.

- Using a rag, slowly open the cap approximately $\frac{1}{2}$ turn counterclockwise to relieve excess pressure. If opened immediately, scalding hot fluid and steam will be blown out under pressure.
- Do not spill antifreeze on hot engine parts. Antifreeze contains ethylene glycol which may burn if it comes into contact with hot engine parts.

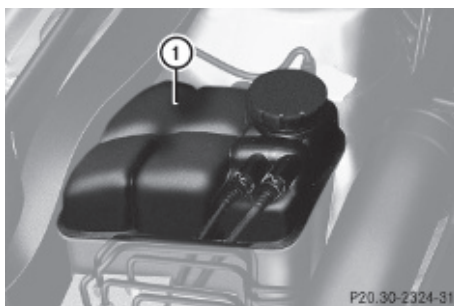

- Using a rag, slowly open cap approximately $\frac{1}{2}$ turn counterclockwise to relieve excess pressure.
- Continue turning the cap counterclockwise and remove it.

The coolant level is correct if the level

- for cold coolant: is up to the upper mark on the bracing rib of coolant expansion tank ① (translucent)
 - for warm coolant: is approximately 0.6 in (1.5 cm) higher
- Add coolant as required.
 - Screw cap back on and tighten it.

! SL 600 and SL 65 AMG: Only open the cap on the coolant expansion tank. Never open the cap between the two charge-air coolers. Otherwise, the engine could be damaged.

For more information on coolant, see the “Technical data” section (▷ page 304) and (▷ page 307).

Washer system and headlamp cleaning system

Warning!

Washer solvent/antifreeze is highly flammable. Do not spill washer solvent/antifreeze on hot engine parts, because it may ignite and burn. You could be seriously burned.

! Always use washer solvent/antifreeze where temperatures may fall below freezing point. Failure to do so could result in damage to the washer system/fluid reservoir.

! Only use washer fluid which is suitable for plastic lenses. Improper washer fluid can damage the plastic lenses of the headlamps.

! Do not use distilled or deionized water in the washer fluid reservoir. Otherwise, the washer fluid level sensor could be damaged.

Fluid for the washer system and the headlamp cleaning system is supplied from the washer fluid reservoir.

During all seasons, use MB Windshield Washer Concentrate “MB SummerFit”. Mix it with water or premixed washer solvent/antifreeze depending on the ambient temperature (▷ page 309).

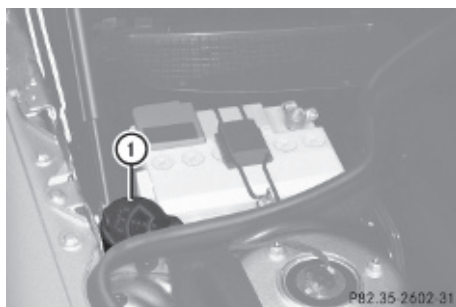

► **Opening washer fluid reservoir:** Pull tab ① upwards.

► Refill the washer fluid reservoir.

► **Closing washer fluid reservoir:** Press cap ① onto filler hole until it engages.

For more information, see “Washer system and headlamp cleaning system” (▷ page 305).

Brake fluid level

! If you find that the brake fluid in the brake fluid reservoir has fallen to the minimum mark or below, have the brake system checked for brake pad thickness and leaks immediately. Contact an authorized Mercedes-Benz Center immediately. Do not add brake fluid as this will not solve the problem. For more information, see “Practical hints”.

When checking the brake fluid level, the vehicle must be parked on level ground.

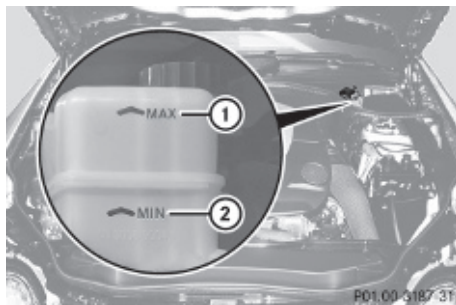

The brake fluid level is correct when it is between lower mark (MIN) ② and upper mark (MAX) ① of the brake fluid reservoir.

Tires and wheels

Safety notes

Contact an authorized Mercedes-Benz Center for information on tested and recommended rims and tires for summer and winter operation. They can also offer advice concerning tire service and purchase.

Warning!

Replace rims or tires with the same designation, manufacturer and type as shown on the original part. For further information contact an authorized Mercedes-Benz Center. If incorrectly sized rims and tires are mounted, the wheel brakes or suspension components can be damaged. Also, the operating clearance of the wheels and the tires may no longer be correct.

Warning!

Worn, old tires can cause accidents. If the tire tread is worn to minimum tread depth, or if the tires have sustained damage, replace them.

When replacing rims, only use genuine Mercedes-Benz wheel bolts specified for the particular rim type. Failure to do so can result in the bolts loosening and possibly an accident.

Retreaded tires are not tested or recommended by Mercedes-Benz, since previous damage cannot always be recognized on retreads. The operating safety of the vehicle cannot be assured when such tires are used.

Warning!

If you feel a sudden significant vibration or ride disturbance, or you suspect that possible damage to your vehicle has occurred, you

should turn on the hazard warning flashers, carefully slow down, and drive with caution to an area which is a safe distance from the road. Inspect the tires and the vehicle underbody for possible damage. If the vehicle or tires appear unsafe, have the vehicle towed to the nearest authorized Mercedes-Benz Center or tire dealer for repairs.

Warning!

Do not drive with a flat tire. A flat tire affects the ability to steer or brake the vehicle. You could lose control of the vehicle. Continued driving with a flat tire or driving at high speed with a flat tire will cause excessive heat build-up and possibly a fire.

Important guidelines

- Only use sets of tires and rims of the same type and make.
- Tires must be of the correct size for the rim.
- Break in new tires for approximately 60 miles (100 km) at moderate speeds.
- Regularly check the tires and rims for damage. Dented or bent rims can cause tire inflation pressure loss and damage to the tire beads.
- If the vehicle is heavily loaded, check tire inflation pressure and correct as required.
- Do not allow your tires to wear down too far. Adhesion properties on wet roads are sharply reduced at tread depths of less than $\frac{1}{8}$ in (3 mm).
- When replacing individual tires, you should mount new tires on the front wheels first (on vehicles with same-sized wheels all around).

Recommended tire inflation pressure

⚠ Warning!

Follow recommended tire inflation pressures. Do not underinflate tires. Underinflated tires wear excessively and/or unevenly, adversely affect handling and fuel economy, and are more likely to fail from being overheated.

Do not overinflate tires. Overinflated tires can adversely affect handling and ride comfort, wear unevenly, increase stopping distance, and result in sudden deflation (blowout) because they are more likely to become punctured or damaged by road debris, potholes etc.

Do not overload the tires by exceeding the specified load limit as indicated on the Tire and Loading Information placard on the driver's door B-pillar. Overloading the tires can overheat them, possibly causing a blowout. Overloading the tires can also result in handling or steering problems, or brake failure.

Your vehicle is equipped with the Tire and Loading Information placard located on the driver's door B-pillar (▷ page 193).

The tire inflation pressure should be checked regularly. Only adjust the tire inflation pressure on cold tires. The tires can be considered cold if the vehicle has been parked for at least 3 hours or driven less than 1 mile (1.6 km). Depending on the ambient temperature, the driving speed and the tire load, the tire temperature changes. When the tire temperature changes by 18°F (10°C), the tire inflation pressure will change by approximately 1.5 psi (0.1 bar). Keep this in mind when checking tire inflation pressure on warm tires and adjust the tire pressure only if the tire inflation pressure is too low for the current operating conditions. If you check the tire inflation pressure when the tires are warm, the reading will be higher than the cold reading. This is normal. Do not let air out to match the specified cold tire inflation

pressure. Otherwise, the tire will be underinflated.

Follow recommended cold tire inflation pressures listed on Tire and Loading Information placard on the driver's door B-pillar.

Keeping the tires properly inflated provides the best handling, tread life and riding comfort.

In addition to the Tire and Loading Information placard on the driver's door B-pillar, also consult the tire inflation pressure label on the inside of the filler flap for any additional information pertaining to special driving situations. For more information, see "Important notes on tire inflation pressure" (▷ page 188).

- ① Data shown on Tire and Loading Information placard example are for illustration purposes only. Tire data are specific to each vehicle and may vary from data shown in the following illustration. Refer to Tire and Loading Information placard on vehicle for actual data specific to your vehicle.

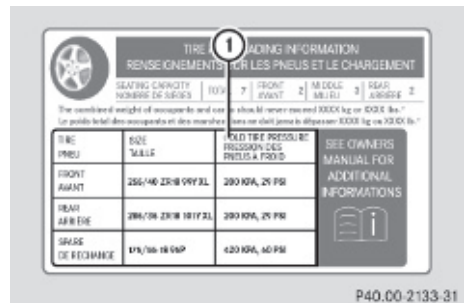

The Tire and Loading Information placard lists the recommended cold tire inflation pressures ① for maximum loaded vehicle weight. The tire inflation pressures listed apply to the tires installed as original equipment.

Important notes on tire inflation pressure

Warning!

If the tire inflation pressure drops repeatedly, check the tires for punctures from foreign objects and/or whether air is leaking from the valves or from around the rim.

Tire temperature and tire inflation pressure are also increased while driving, depending on the driving speed and the tire load.

If you will be driving your vehicle at high speeds of 100 mph (160 km/h) or higher, where it is legal and conditions allow, consult the tire inflation pressure label on the inside of the fuel filler flap on how to adjust the cold tire inflation pressure. If you do not adjust the tire inflation pressure, excessive heat can build up and result in sudden tire failure.

If you are not sure about the proper tire inflation pressure, contact an authorized Mercedes-Benz Center.

i Driving comfort may be reduced when the tire inflation pressure is adjusted to the value for speeds above 100 mph (160 km/h) as specified on the tire inflation pressure label located on the inside of the fuel filler flap.

Make sure to readjust the tire inflation pressure for normal driving speeds.

Supplemental tire inflation pressure information for different loading conditions of the vehicle can be found on the tire inflation pressure label. The tire inflation pressure label is located on the inside of the fuel filler flap.

For the tire inflation pressure for spare wheels such as Minispare wheels or spare wheels with collapsible tire refer to

- the yellow label on the spare wheel rim
- the “Technical data” section of this Operator’s Manual (▷ page 303)
- the Tire and Loading Information placard on the driver’s door B-pillar

Unless specified otherwise, the tire inflation pressures on the tire inflation pressure label are valid for all approved, factory-equipped tires.

i Data shown on tire inflation pressure label examples are for illustration purposes only. Tire inflation pressure data are specific to each vehicle and may vary from data shown in the following illustrations. Refer to the tire inflation pressure label on vehicle for actual data specific to your vehicle.

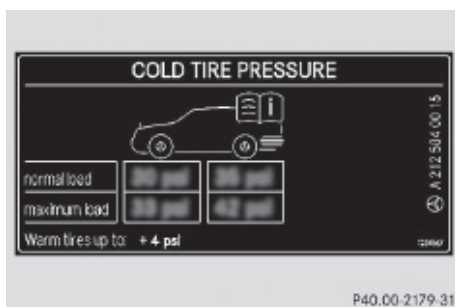

Example illustration: Tire inflation pressures for all approved, factory equipped tires

When a tire size is specified, the tire inflation pressure that follows applies to that particular tire size only.

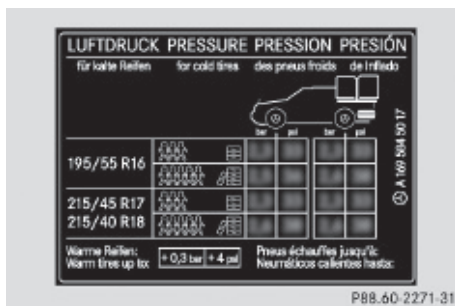

Example illustration: Tire inflation pressures for particular tire sizes

Some tire inflation pressure labels may only show the rim diameter instead of the entire tire size, e.g. **R 18** or **18"**.

The rim diameter is part of the tire size as specified on the tire sidewall (▷ page 201).

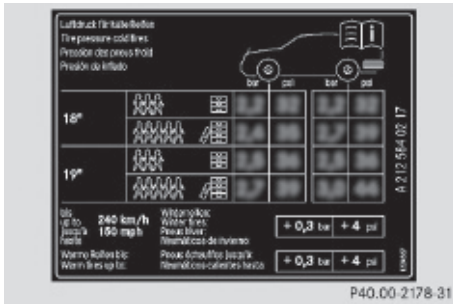

Example illustration: Tire inflation pressures specific to rim diameter

Potential problems associated with underinflated and overinflated tires

Underinflated tires

Warning!

Follow recommended tire inflation pressures. Do not underinflate tires. Underinflated tires wear excessively and/or unevenly, adversely affect handling and fuel economy, and are more likely to fail from being overheated.

Underinflated tires can

- cause excessive and uneven tire wear
- adversely affect fuel economy
- lead to tire failure from being overheated
- adversely affect handling characteristics

Overinflated tires

Warning!

Follow recommended tire inflation pressures. Do not overinflate tires. Overinflated tires can adversely affect handling and ride comfort, wear unevenly, increase stopping distance, and result in sudden deflation (blowout) because they are more likely to become punctured or damaged by road debris, potholes etc.

Overinflated tires can

- adversely affect handling characteristics
- cause uneven tire wear

- be more prone to damage from road hazards
- adversely affect ride comfort
- increase stopping distance

Checking tire inflation pressure

Safety notes

Warning!

Follow recommended tire inflation pressures. Do not underinflate tires. Underinflated tires wear excessively and/or unevenly, adversely affect handling and fuel economy, and are more likely to fail from being overheated.

Do not overinflate tires. Overinflated tires can adversely affect handling and ride comfort, wear unevenly, increase stopping distance, and result in sudden deflation (blowout) because they are more likely to become punctured or damaged by road debris, potholes etc.

Do not overload the tires by exceeding the specified load limit as indicated on the Tire and Loading Information placard on the driver's door B-pillar. Overloading the tires can overheat them, possibly causing a blowout. Overloading the tires can also result in handling or steering problems, or brake failure.

Check the tire inflation pressure at least once a month.

Check and adjust the tire inflation pressure when the tires are cold (> page 187).

Checking tire inflation pressure manually

Follow the steps below to achieve correct tire inflation pressure:

- ▶ Remove the cap from the valve on one tire.
- ▶ Firmly press a tire gauge onto the valve.
- ▶ Read the tire inflation pressure on the tire gauge and check against the recommended tire inflation pressure on the

Tire and Loading Information placard on the driver's door B-pillar (▷ page 194). If necessary, add air to achieve the recommended tire inflation pressure.

- ▶ If you have overfilled the tire, release tire inflation pressure by pushing the metal stem of the valve with e.g. a tip of a pen. Then recheck the tire inflation pressure with the tire gauge.
- ▶ Install the valve cap.
- ▶ Repeat this procedure for each tire.

Advanced Tire Pressure Monitoring System (Advanced TPMS)

Your vehicle is equipped with the Advanced Tire Pressure Monitoring System (Advanced TPMS). It measures the tire inflation pressure in the vehicle's tires and issues warnings in case of pressure loss in one or more of the tires.

The TPMS is equipped with a combination low tire pressure/TPMS malfunction telltale (USA) or a low tire pressure telltale (Canada) in the instrument cluster. Depending on how the telltale illuminates, it indicates a low tire pressure condition or a malfunction in the TPMS system itself:

- If the telltale illuminates continuously, one or more of your tires is significantly underinflated. There is no malfunction in the TPMS.
- USA only: If the telltale flashes for 60 seconds and then stays illuminated, the TPMS system itself is not operating properly.

The TPMS only functions on wheels that are equipped with the proper electronic sensors.

Warning!

The TPMS does not indicate a warning for wrongly selected inflation pressures. Always adjust tire inflation pressure according to the Tire and Loading Information placard or the

supplemental tire inflation pressure information on the inside of the fuel filler flap.

The TPMS is not able to issue a warning due to a sudden dramatic loss of pressure (e.g. tire blowout caused by a foreign object). In this case bring the vehicle to a halt by carefully applying the brakes and avoiding abrupt steering maneuvers.

Warning!

Each tire, including the spare (if provided), should be checked at least once a month when cold and inflated to the inflation pressure recommended by the vehicle manufacturer on the Tire and Loading Information placard on the driver's door B-pillar or the tire inflation pressure label on the inside of the fuel filler flap. If your vehicle has tires of a different size than the size indicated on the Tire and Loading Information placard or the tire inflation pressure label, you should determine the proper tire inflation pressure for those tires.

As an added safety feature, your vehicle has been equipped with a tire pressure monitoring system (TPMS) that illuminates a low tire pressure telltale when one or more of your tires are significantly underinflated.

Accordingly, when the low tire pressure telltale illuminates, you should stop and check your tires as soon as possible, and inflate them to the proper pressure. Driving on a significantly underinflated tire causes the tire to overheat and can lead to tire failure.

Underinflation also reduces fuel efficiency and tire tread life, and may affect the vehicle's handling and stopping ability. Please note that the TPMS is not a substitute for proper tire maintenance, and it is the driver's responsibility to maintain correct tire pressure, even if underinflation has not reached the level to trigger illumination of the TPMS low tire pressure telltale.

USA only:

Your vehicle has also been equipped with a TPMS malfunction indicator to indicate when

the system is not operating properly. The TPMS malfunction indicator is combined with the low tire pressure telltale. When the system detects a malfunction, the telltale will flash for approximately 1 minute and then remain continuously illuminated. This sequence will continue upon subsequent vehicle start-ups as long as the malfunction exists. When the malfunction indicator is illuminated, the system may not be able to detect or signal low tire pressure as intended.

TPMS malfunctions may occur for a variety of reasons, including the installation of incompatible replacement or alternate tires or wheels on the vehicle that prevent the TPMS from functioning properly. Always check the TPMS malfunction telltale after replacing one or more tires or wheels on your vehicle to ensure that the replacement or alternate tires and wheels allow the TPMS to continue to function properly.

i USA only:





If a condition causing the TPMS to malfunction develops, it may take up to 10 minutes for the system to signal a malfunction using the TPMS telltale flashing and illumination sequence.

The telltale extinguishes after a few minutes driving if the malfunction has been corrected.

Tire pressure inquiries are made using the multifunction display. The current tire inflation pressure for each tire appears in the multifunction display after a few minutes of driving.

i Possible differences between the readings of a tire pressure gauge of an air hose, e.g. gas station equipment, and the vehicle's control system can occur. The tire pressure displayed by the control system apply to sea level. In high-altitude locations, the reading on a tire pressure gauge will be higher than the reading issued by the vehicle's control system. Do not

reduce the tire inflation pressure under such circumstances.

- ▶ Switch on the ignition.
- ▶ Press button  or  on the multifunction steering wheel repeatedly until the standard display appears in the multifunction display (▷ page 116).
- ▶ Press button  or  until the current inflation pressure for each tire appears in the multifunction display.

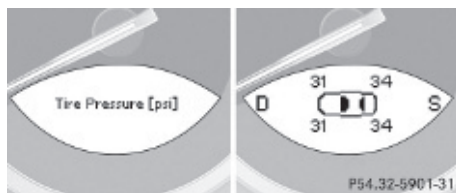

Example illustration

When the vehicle has been parked for longer than 20 minutes, the message Tire pressure displayed after driving for a few minutes. appears in the multifunction display.

The TPMS recognizes new wheels or sensors automatically after the learn-in phase. As long as the tire inflation pressure values cannot be allocated to the individual wheels, the message Tire Pressure Monitor Active Menu: R-Button appears. Despite this message, the tire inflation pressure values are monitored already.

- i** With a spare wheel mounted, the system may still indicate the tire inflation pressure of the removed road wheel for some minutes. If this happens, keep in mind that the indicated value where the spare wheel is mounted does not reflect the actual spare tire inflation pressure.
- i** Operating radio transmission equipment (e.g. wireless headsets, two-way radios) in or near the vehicle could cause the TPMS to malfunction.

i USA only:

This device complies with Part 15 of the FCC Rules. Operation is subject to the following two conditions:

1. This device may not cause harmful interference, and
2. this device must accept any interference received, including interference that may cause undesired.

Any unauthorized modification to this device could void the user's authority to operate the equipment.

i Canada only:

This device complies with RSS-210 of Industry Canada. Operation is subject to the following two conditions:

1. This device may not cause interference, and
2. this device must accept any interference received, including interference that may cause undesired operation of the device.

Any unauthorized modification to this device could void the user's authority to operate the equipment.

Tire inflation pressure warnings

If the system detects a significant loss of tire inflation pressure in one or more than one tire, a message appears in the multifunction display. In addition, an acoustic warning sounds and the low tire pressure telltale in the instrument cluster comes on.

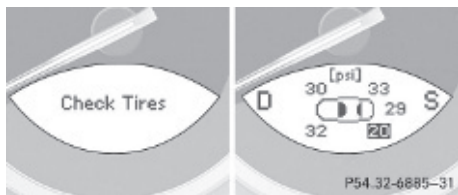

The respective tire is indicated by a red rectangle.

Restarting Advanced TPMS**Warning!**

It is the driver's responsibility to set the tire inflation pressure to the recommended cold tire inflation pressure. Underinflated tires affect the ability to steer or brake the vehicle. You might lose control over the vehicle.



When you restart the TPMS, the system sets new reference values for each tire.



The TPMS must be restarted when you have adjusted the tire inflation pressure to a new level (e.g. because of different load or driving conditions). The TPMS is then recalibrated to the current tire inflation pressures.

i Canada only:

The TPMS usually recognizes tire pressure adjustments and sets new reference values automatically. You can, however, restart the TPMS manually as described.

Restart the TPMS after adjusting the tire inflation pressure to the inflation pressure recommended for the vehicle operating condition. Tire inflation pressure should only be adjusted on cold tires. Observe the recommended tire inflation pressure on the Tire and Loading Information placard on the driver's door B-pillar. Some vehicles may have supplemental tire inflation pressure information for driving at high speeds or for vehicle loads less than the maximum loaded vehicle condition. If such information is provided, it can be found on the inside of the fuel filler flap.

- ▶ Using the Tire and Loading Information placard on the driver's door B-pillar (▷ page 194) or the supplemental tire inflation pressure information on the inside of the fuel filler flap, make sure the tire inflation pressure of all four tires is correct.
- ▶ Switch on the ignition.
- ▶ Press button  or  on the multifunction steering wheel repeatedly until the standard display appears in the multifunction display (▷ page 116).

- ▶ Press button  or  repeatedly until you see the current inflation pressures for each tire appear in the display or the following message appears in the multifunction display:

Tire pressure
displayed after
driving for
a few minutes.

- ▶ Press the reset button (▷ page 111).
The following message will appear in the multifunction display:
Restart tire
pressure monitor?

- ▶ **If you wish to confirm:** Press button .

The following message will appear in the multifunction display:
Tire Pressure Monitor
Restarted

After driving a few minutes the system verifies that the current tire inflation pressures are within the system's specified range. Afterwards the current tire inflation pressures are accepted as reference values and then monitored.

- ▶ **If you wish to cancel:** Press button .

- i** When the wheel positions have been changed, the inflation pressure of a tire may be displayed for the wrong position temporarily. After driving for a few minutes, the inflation pressure will be shown for the correct position.

Maximum tire inflation pressure

Warning!

Never exceed the maximum tire inflation pressure. Follow recommended tire inflation pressures.

Do not underinflate tires. Underinflated tires wear excessively and/or unevenly, adversely affect handling and fuel economy, and are more likely to fail from being overheated.

Do not overinflate tires. Overinflated tires can adversely affect handling and ride comfort, wear unevenly, increase stopping distance, and result in sudden deflation (blowout) because they are more likely to become punctured or damaged by road debris, potholes etc.

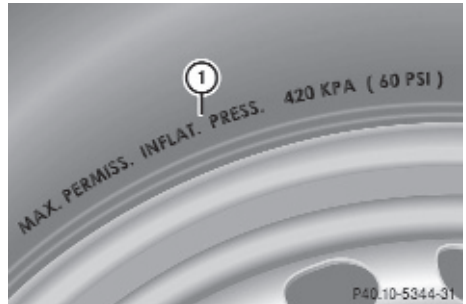

- i** For illustration purposes only. Actual data on tires are specific to each vehicle and may vary from data shown in above illustration.

This is the maximum permissible tire inflation pressure  for the tire.

Always follow the recommended tire inflation pressure (▷ page 187) for proper tire inflation.

Loading the vehicle

Two labels on your vehicle show how much weight it may properly carry.

- (1) The Tire and Loading Information placard can be found on the driver's door B-pillar. This placard tells you important information about the number of people that can be in the vehicle and the total weight that can be carried in the vehicle. It also contains information on the proper size and recommended tire inflation

pressures for the original equipment tires on your vehicle.

- (2) The certification label, also found on the driver's door B-pillar. It tells you about the gross weight capacity of your vehicle, called the Gross Vehicle Weight Rating (GVWR). The GVWR includes the weight of the vehicle, all occupants, fuel and cargo. The certification label also tells you about the front and rear axle weight capacity, called the Gross Axle Weight Rating (GAWR).

The GAWR is the total allowable weight that can be carried by a single axle (front or rear). Never exceed the GVWR or GAWR for either the front axle or rear axle.

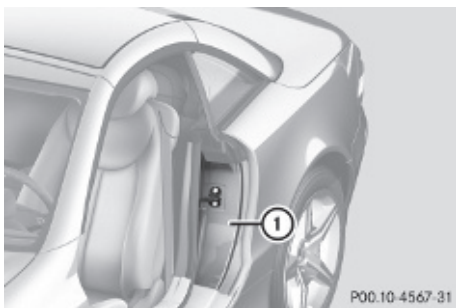

- ① Driver's door B-pillar

Following is a discussion on how to work with the information contained on the Tire and Loading Information placard with regards to loading your vehicle.

Tire and Loading Information

Warning!

Do not overload the tires by exceeding the specified load limit as indicated on the Tire and Loading Information placard on the driver's door B-pillar. Overloading the tires can overheat them, possibly causing a blowout. Overloading the tires can also result in handling or steering problems, or brake failure.

Tire and Loading Information placard

- i** Data shown on Tire and Loading Information placard example are for illustration purposes only. Load limit data are specific to each vehicle and may vary from data shown in the following illustration. Refer to Tire and Loading Information placard on vehicle for actual data specific to your vehicle.

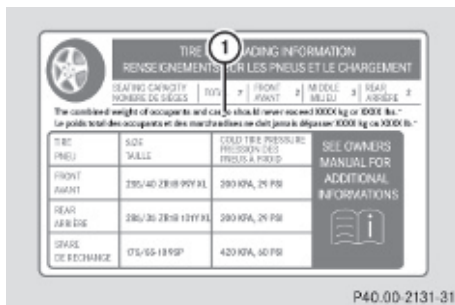

The Tire and Loading Information placard showing load limit information ① is located on the driver's door B-pillar (▷ page 194).

- Locate the statement “The combined weight of occupants and cargo should never exceed XXX kilograms or XXX lbs.” on the Tire and Loading Information placard.

The combined weight of all occupants, cargo/luggage and trailer tongue load (if applicable) should never exceed the weight referenced in that statement.

Seating capacity

- i** Data shown on Tire and Loading Information placard example are for illustration purposes only. Seating capacity data are specific to each vehicle and may vary from data shown in the following illustration. Refer to Tire and Loading Information placard on vehicle for actual data specific to your vehicle.

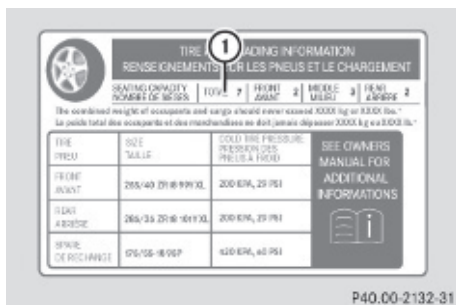

The seating capacity gives you important information on the number of occupants that can be in the vehicle. The Tire and Loading Information placard showing seating capacity ① is located on the driver's door B-pillar (▷ page 194).

Steps for determining correct load limit

The following steps have been developed as required of all manufacturers under Title 49, Code of U.S. Federal Regulations, Part 575 pursuant to the "National Traffic and Motor Vehicle Safety Act of 1966".

- ▶ **Step 1:** Locate the statement "The combined weight of occupants and cargo should never exceed XXX kg or XXX lbs." on your vehicle's Tire and Loading Information placard.
- ▶ **Step 2:** Determine the combined weight of the driver and passengers that will be riding in your vehicle.
- ▶ **Step 3:** Subtract the combined weight of the driver and passengers from XXX kilograms or XXX lbs.
- ▶ **Step 4:** The resulting figure equals the available amount of cargo and luggage load capacity. For example, if the "XXX" amount equals 1 400 lbs and there will be five 150 lbs passengers in your vehicle, the amount of available cargo and luggage load capacity is 650 lbs ($1\,400 - 750 (5 \times 150) = 650$ lbs).
- ▶ **Step 5:** Determine the combined weight of luggage and cargo being loaded on the vehicle. That weight may not safely exceed

the available cargo and luggage load capacity calculated in step 4.

- ▶ **Step 6 (if applicable):** If your vehicle will be towing a trailer, load from your trailer will be transferred to your vehicle. Consult this manual to determine how this reduces the available cargo and luggage load capacity of your vehicle (▷ page 196).

The following table shows examples on how to calculate total and cargo load capacities with varying seating configurations and number and size of occupants. The following examples use a load limit of 1 500 lbs. **This is for illustration purposes only.** Make sure you are using the actual load limit for your vehicle stated on the vehicle's Tire and Loading Information placard (▷ page 194).

		Example 1	Example 2
Step 1	Combined weight limit of occupants and cargo from Tire and Loading Information placard	1 500 lbs	1 500 lbs
Step 2	Number of occupants (driver and passengers)	1	2
	Occupants weight	Occupant 1: 175 lbs	Occupant 1: 175 lbs Occupant 2: 195 lbs
	Combined weight of all occupants	175 lbs	370 lbs
Step 3	Available cargo/luggage and trailer tongue weight (total load limit from Tire and Loading Information placard minus combined weight of all occupants)	1 500 lbs - 175 lbs = 1 325 lbs	1 500 lbs - 370 lbs = 1 130 lbs

The higher the weight of all occupants, the less cargo and luggage load capacity is available.

For more information, see “Trailer tongue load” (▷ page 196).

Certification label

Even after careful determination of the combined weight of all occupants, cargo and the trailer tongue load (if applicable) (▷ page 196) as to not exceed the permissible load limit, you must make sure your vehicle never exceeds the Gross Vehicle Weight Rating (GVWR) and the Gross Axle Weight Rating (GAWR) for either the front or rear axle. You can obtain the GVWR and GAWR from the certification label. The certification label can be found on the driver’s door B-pillar, see the “Technical data” section (▷ page 294).

Gross Vehicle Weight Rating (GVWR): The total weight of the vehicle, all occupants, all cargo, and the trailer tongue load (if applicable) must never exceed the GVWR.

Gross Axle Weight Rating (GAWR): The total allowable weight that can be carried by a single axle (front or rear).

To assure that your vehicle does not exceed the maximum permissible weight limits (GVWR and GAWR for front and rear axle), have the loaded vehicle (including driver, passengers and all cargo and, if applicable, trailer fully loaded) weighed on a suitable commercial scale.

Trailer tongue load

The tongue load of any trailer is an important weight to measure because it affects the load you can carry in your vehicle. If a trailer is towed, the tongue load must be added to the weight of all occupants riding and any cargo you are carrying in the vehicle. The tongue load typically is 10% of the trailer weight and everything loaded in it.

Your Mercedes-Benz has been designed primarily to carry passengers and their cargo. Mercedes-Benz does not recommend trailer towing with your vehicle.

Maximum tire load

Warning!

Do not overload the tires by exceeding the specified load limit as indicated on the Tire and Loading Information placard on the driver's door B-pillar. Overloading the tires can overheat them, possibly causing a blowout. Overloading the tires can also result in handling or steering problems, or brake failure.



- 1** For illustration purposes only. Actual data on tires are specific to each vehicle and may vary from data shown in above illustration.

The maximum tire load rating **1** is the maximum weight the tires are designed to support.

For more information on tire load rating, see (▷ page 202).

For information on calculating total and cargo load capacities, see (▷ page 195).

Direction of rotation

Unidirectional tires offer added advantages, such as better hydroplaning performance. To benefit, however, you must make sure the tires rotate in the direction specified.

An arrow on the sidewall indicates the intended direction of rotation of the tire.

Spare wheels may be mounted against the direction of rotation (spinning) even with a unidirectional tire for temporary use only until

the regular drive wheel has been repaired or replaced. Always observe and follow applicable temporary use restrictions and speed limitations indicated on the spare wheel.

MOExtended system

The MOExtended system allows you to continue driving your vehicle even if there is a total loss of pressure in one or more tires. You may only use the MOExtended system in conjunction with the Advanced TPMS (▷ page 190).

For information on driving in case of pressure loss in one or more tires (emergency mode), see the “Practical hints” section (▷ page 283).

Tire care and maintenance

Warning!

Regularly check the tires for damage. Damaged tires can cause tire inflation pressure loss. As a result, you could lose control of your vehicle.

Worn, old tires can cause accidents. If the tire tread is worn to minimum tread depth, or if the tires have sustained damage, replace them.

Check the tire inflation pressure at least once a month. For more information on checking tire inflation pressure, see “Recommended tire inflation pressure” (▷ page 187).

Tire inspection

Every time you check the tire inflation pressure, you should also inspect your tires for the following:

- excessive treadwear (▷ page 198)
- cord or fabric showing through the tire's rubber
- bumps, bulges, cuts, cracks or splits in the tread or side of the tire

Replace the tire if you find any of the above conditions.

Make sure you also inspect the spare tire periodically for condition and inflation. Spare tires will age and become worn over time even if never used, and thus should be inspected and replaced when necessary.

Life of tire

Warning!

Tires and spare tire should be replaced after 6 years, regardless of the remaining tread.

The service life of a tire is dependent upon varying factors including but not limited to:

- Driving style
- Tire inflation pressure
- Distance driven

Tread depth

Warning!

Although the applicable federal motor vehicle safety laws consider a tire to be worn when the treadwear indicators (TWI) become visible at approximately $\frac{1}{16}$ in (1.6 mm), we recommend that you do not allow your tires to wear down to that level. As tread depth approaches $\frac{1}{8}$ in (3 mm), the adhesion properties on a wet road are sharply reduced. Depending upon the weather and/or road surface (conditions), the tire traction varies widely.

Do not allow your tires to wear down too far. Adhesion properties on wet roads are sharply reduced at tread depths of less than $\frac{1}{8}$ in (3 mm).

Treadwear indicators (TWI) are required by law. These indicators are located in six places on the tread circumference and become visible at a tread depth of approximately $\frac{1}{16}$ in (1.6 mm), at which point the tire is considered worn and should be replaced.

The recommended minimum tire tread depth for summer tires is $\frac{1}{8}$ in (3 mm). The recommended minimum tire tread depth for winter tires is $\frac{1}{6}$ in (4 mm).

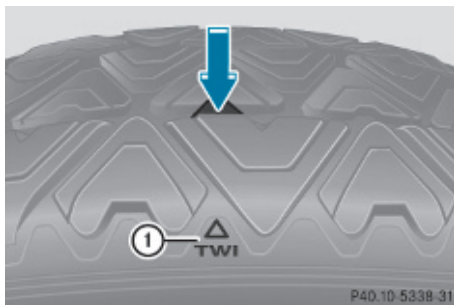

Treadwear indicator ① appears as a solid band across the tread.

Storing tires

- ❗ Keep unmounted tires in a cool, dry place with as little exposure to light as possible. Protect tires from contact with oil, grease and fuels.

Cleaning tires

- ❗ Never use a round nozzle to power wash tires. The intense jet of water can result in damage to the tire. Always replace a damaged tire.

Uniform Tire Quality Grading Standards

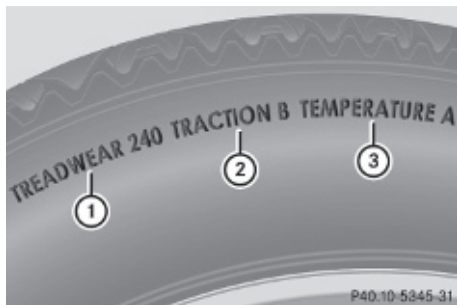

The Uniform Tire Quality Grading is a U.S. Government requirement designed to give drivers consistent and reliable information regarding tire performance. Tire manufacturers are required to grade tires based on three performance factors: treadwear ①, traction ②, and temperature resistance ③. Although not a Government of Canada requirement, all tires made for sale in North America have these grades branded on the sidewall.

i For illustration purposes only. Actual data on tires are specific to each vehicle and may vary from data shown in above illustration.

Quality grades can be found, where applicable, on the tire sidewall between tread shoulder and maximum section width. For example:

Treadwear	Traction	Temperature
200	AA	A

All passenger car tires must conform to federal safety requirements in addition to these grades.

Treadwear

The treadwear grade is a comparative rating based on the wear rate of the tire when tested under controlled conditions on a specified U.S. Government test course. For example, a

tire graded 150 would wear one and one-half ($1 \frac{1}{2}$) times as well on the government course as a tire graded 100.

The relative performance of tires depends upon the actual conditions of their use, however, and may depart significantly from the norm due to variations in driving habits, service practices and differences in road characteristics and climate.

Traction

Warning!

The traction grade assigned to this tire is based on straight-ahead braking traction tests, and does not include acceleration, cornering, hydroplaning, or peak traction characteristics.

The traction grades, from highest to lowest, are AA, A, B, and C. Those grades represent the tire's ability to stop on wet pavement as measured under controlled conditions on specified government test surfaces of asphalt and concrete. A tire marked C may have poor traction performance.

Warning!

If ice has formed on the road, tire traction will be substantially reduced. Under such weather conditions, drive, steer and brake with extreme caution.

The safe speed on a wet, snow covered or icy road is always lower than on a dry road.

You should pay particular attention to the condition of the road whenever the outside temperature is close to the freezing point.

Mercedes-Benz recommends winter tires (\triangleright page 207) with a minimum tread depth of approximately $\frac{1}{6}$ in (4 mm) on all four wheels for the winter season to ensure normal balanced handling characteristics. On packed snow, they can reduce your stopping distance compared to summer tires. Stopping distance, however, is still considerably greater than when the road is

not covered with snow or ice. Exercise appropriate caution.

! Avoid spinning of a drive wheel. This may cause serious damage to the drivetrain which is not covered by the Mercedes-Benz Limited Warranty.

Temperature

Warning!

The temperature grade for this tire is established for a tire that is properly inflated and not overloaded. Excessive speed, underinflation, or excessive loading, either separately or in combination, can cause excessive heat build-up and possible tire failure.

The temperature grades are A (the highest), B, and C, representing the tire's resistance to the generation of heat and its ability to dissipate heat when tested under controlled conditions on a specified indoor laboratory test wheel. Sustained high temperature can cause the material of the tire to degenerate and reduce tire life, and excessive temperature can lead to sudden tire failure. The grade C corresponds to a level of performance which all passenger car tires must meet under the Federal Motor Vehicle Safety Standard No. 109. Grades B and A represent higher levels of performance on the laboratory test wheel than the minimum required by law.

Rotating tires

Warning!

Rotate front and rear wheels only if the tires are of the same dimension.

If your vehicle is equipped with mixed-size tires (different tire dimensions front vs. rear), tire rotation is not possible.

Warning!

Have the tightening torque checked after changing a wheel. Wheels could become loose if not tightened with a torque of 96 lb-ft (130 Nm).

Only use genuine Mercedes-Benz wheel bolts specified for your vehicle's rims.

Tire rotation can be performed on vehicles with tires of the same dimension all around. If your vehicle is equipped with tires of the same dimension all around, tires can be rotated, observing a front-to-rear rotation pattern that will maintain the intended rotation (spinning) direction of the tire ([▷ page 197](#)).

In some cases, such as when your vehicle is equipped with mixed-size tires (different tire dimension front vs. rear), tire rotation is not possible.

If applicable to your vehicle's tire configuration, tires can be rotated according to the tire manufacturer's recommended intervals in the tire manufacturer's warranty pamphlet located in your vehicle literature portfolio. If none is available, tires should be rotated every 3 000 to 6 000 miles (5 000 to 10 000 km), or sooner if necessary, according to the degree of tire wear. The same rotation (spinning) direction must be maintained.

Rotate tires before the characteristic tire wear pattern becomes visible (shoulder wear on front tires and tread center wear on rear tires).

Thoroughly clean the mounting face of wheels and brake disks, i.e. the inner side of the wheels/tires, during each rotation. Check for and ensure proper tire inflation pressure.

For information on wheel change, see "Flat tire" ([▷ page 276](#)).

Tire labeling

Besides tire name (sales designation) and manufacturer name, a number of markings can be found on a tire.

Following are some explanations for the markings on your vehicle's tires:

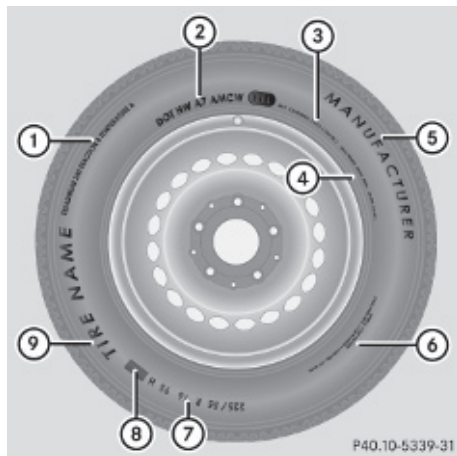

- ① Uniform Tire Quality Grading Standards (▷ page 199)
- ② DOT, Tire Identification Number (▷ page 204)
- ③ Maximum tire load (▷ page 197)
- ④ Maximum tire inflation pressure (▷ page 193)
- ⑤ Manufacturer
- ⑥ Tire ply material (▷ page 205)
- ⑦ Tire size designation, load and speed rating (▷ page 201)
- ⑧ Load identification (▷ page 204)
- ⑨ Tire name

i For illustration purposes only. Actual data on tires are specific to each vehicle and may vary from data shown in above illustration.

For more information, see “Rims and tires” (▷ page 299).

Tire size designation, load and speed rating

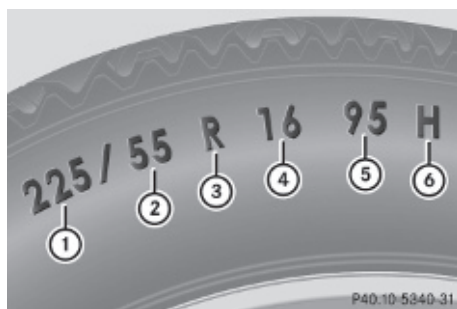

- ① Tire width
- ② Aspect ratio in %
- ③ Radial tire code
- ④ Rim diameter
- ⑤ Load index
- ⑥ Speed symbol

i For illustration purposes only. Actual data on tires are specific to each vehicle and may vary from data shown in above illustration.

General: Depending on the design standards used, the tire size molded into the sidewall may have no letter or a letter preceding the tire size designation.

No letter preceding the size designation (as illustrated above): Passenger car tire based on European design standards.

Letter “P” preceding the size designation: Passenger car tire based on U.S. design standards.

Letter “LT” preceding the size designation: Light Truck tire based on U.S. design standards.

Letter “T” preceding the size designation: Temporary spare tires which are high pressure compact spares designed for temporary emergency use only.

Tire width

Tire width ① indicates the nominal tire width in millimeters.

Aspect ratio

Aspect ratio ② is the dimensional relationship between tire section height and section width and is expressed in percentage. The aspect ratio is arrived at by dividing section height by section width.

Tire code

Tire code ③ indicates the tire construction type. The “R” stands for radial tire type. Letter “D” means diagonal or bias ply construction; letter “B” means belted-bias ply construction.

At the tire manufacturer’s option, any tire with a speed capability above 149 mph (240 km/h) can include a “ZR” in the size designation (for example: 245/40 ZR 18). For additional information, see “Tire speed rating” (▷ page 202).

Rim diameter

Rim diameter ④ is the diameter of the bead seat, not the diameter of the rim edge. The rim diameter is indicated in inches (in).

Load index

Warning!

The tire load rating must always be at least half of the GAWR of your vehicle. Otherwise, tire failure may be the result which may cause an accident and/or serious injury to you or others.

Always replace rims and tires with the same designation, manufacturer and type as shown on the original part.

Warning!

Do not overload the tires by exceeding the specified load limit as indicated on the Tire and Loading Information placard on the driver’s door B-pillar. Overloading the tires can overheat them, possibly causing a blowout. Overloading the tires can also result in handling or steering problems, or brake failure.

Load index ⑤ is a numerical code associated with the maximum load a tire can support.

For example, a load rating of 91 corresponds to a maximum load of 1356 lb (615 kg) the tire is designed to support. See also “Maximum tire load” (▷ page 197) where the maximum load associated with the load index is indicated in kilograms and lbs.

For additional information on the load index, see “Load identification” (▷ page 204).

Speed symbol

Warning!

Even when permitted by law, never operate a vehicle at speeds greater than the maximum speed rating of the tires.

Exceeding the maximum speed for which tires are rated can lead to sudden tire failure, causing loss of vehicle control and possibly resulting in an accident and/or serious personal injury and possible death, for you and for others.

Regardless of the tire speed rating, local speed limits should be obeyed. Use prudent driving speeds appropriate to prevailing conditions.

Speed symbol ⑥ indicates the approved maximum speed (tire speed rating) for the tire.

Summer tires

Index	Speed rating
Q	up to 100 mph (160 km/h)
R	up to 106 mph (170 km/h)
S	up to 112 mph (180 km/h)
T	up to 118 mph (190 km/h)
H	up to 130 mph (210 km/h)
V	up to 149 mph (240 km/h)
W	up to 168 mph (270 km/h)
Y	up to 186 mph (300 km/h)
ZR...Y	up to 186 mph (300 km/h)

Index	Speed rating
ZR...(..Y)	above 186 mph (300 km/h)
ZR	above 149 mph (240 km/h)

- At the tire manufacturer's option, any tire with a speed capability above 149 mph (240 km/h) can include a "ZR" in the size designation (for example: 245/40 ZR18). To determine the maximum speed capability of the tire, the service description for the tire must be referred to. The service description is comprised of load index ⑤ and speed symbol ⑥.

If your tire includes "ZR" in the size designation and no service description is given, the tire manufacturer must be consulted for the maximum speed capability.

If a service description is given, the speed capability is limited by the speed symbol in the service description. Example: 245/40 ZR18 97Y. In this example, "97Y" is the service description. The letter "Y" designates the speed rating and the speed capability of the tire is limited to 186 mph (300 km/h).

- Any tire with a speed capability above 186 mph (300 km/h) must include a "ZR" in the size designation AND the service description must be placed in parenthesis. Example: 275/40 ZR 18 (99Y). The "(Y)" speed symbol in parenthesis designates the maximum speed capability of the tire as being above 186 mph (300 km/h). Consult the tire manufacturer for the actual maximum permissible speed of the tire.

All-season and winter tires

Index	Speed rating
Q M+S ¹⁵	up to 100 mph (160 km/h)
T M+S ¹⁵	up to 118 mph (190 km/h)

Index	Speed rating
H M+S ¹⁵	up to 130 mph (210 km/h)
V M+S ¹⁵	up to 149 mph (240 km/h)

- Not all M+S rated tires provide special winter performance. Make sure the tires you use show M+S and the mountain/snowflake  marking on the tire sidewall. These tires meet specific snow traction performance requirements of the Rubber Manufacturers Association (RMA) and the Rubber Association of Canada (RAC) and have been designed specifically for use in snow conditions.

An electronic speed limiter prevents your vehicle from exceeding a speed of:

- 155 mph (250 km/h):
 - SL 550
 - SL 550 (Sport Package)
 - SL 600
 - SL 600 (Sport Package)
 - SL 63 AMG
 - SL 65 AMG
- 186 mph (300 km/h):
 - SL 63 AMG (Performance Package)
 - SL 65 AMG with increased top speed

The factory equipped tires on your vehicle may have a tire speed rating above the maximum speed permitted by the electronic speed limiter.

Make sure your tires have the required tire speed rating as specified for your vehicle in the "Technical data" section (▷ page 299), for example when purchasing new tires.

If you are uncertain about the correct reading of the information given on a tire's sidewall, any authorized Mercedes-Benz Center will be glad to assist you.

¹⁵ or M+S  for winter tires

Load identification



i For illustration purposes only. Actual data on tires are specific to each vehicle and may vary from data shown in above illustration.

In addition to the load index, special load identification ① may be molded into the tire sidewall following the letter designating the speed symbol ⑥ (▷ page 201).

- No specification given: absence of any text (like in above example) indicates a standard load (SL) tire.
- XL or Extra Load: designates an extra load (or reinforced) tire.
- Light Load: designates a light load tire.
- C, D, E: designates load range associated with the maximum load a tire can carry at a specified pressure.

DOT, Tire Identification Number (TIN)

U.S. tire regulations require each new tire manufacturer or tire retreader to mold a TIN into or onto a sidewall of each tire produced.

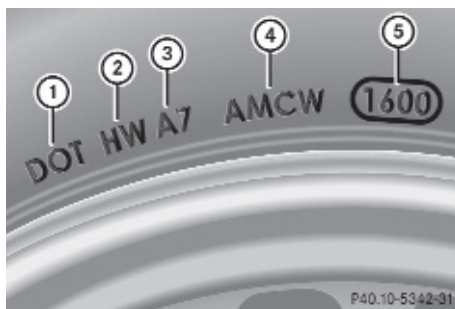

The TIN is a unique identifier. The TIN facilitates efforts by tire manufacturers to notify purchasers in recall situations or other safety matters concerning tires. It gives purchasers the means to easily identify such tires.

The TIN is comprised of “Manufacturer’s identification mark” ②, “Tire size” ③, “Tire type code” ④ and “Date of manufacture” ⑤.

i For illustration purposes only. Actual data on tires are specific to each vehicle and may vary from data shown in above illustration.

DOT (Department of Transportation)

Tire branding symbol ① denotes that the tire meets requirements of the U.S. Department of Transportation.

Manufacturer’s identification mark

Manufacturer’s identification mark ② denotes the tire manufacturer.

New tires have a mark with two symbols.

Retreaded tires have a mark with four symbols. For more information on retreaded tires, see (▷ page 186).

Tire size

Code ③ indicates the tire size.

Tire type code

Tire type code ④ may, at the option of the manufacturer, be used as a descriptive code for identifying significant characteristics of the tire.

Date of manufacture

The date of manufacture ⑤ identifies the week and year of manufacture.

The first two figures identify the week, starting with "01" to represent the first full week of the calendar year. The second two figures represent the year.

For example, "3208" represents the 32nd week of 2008.

Tire ply material

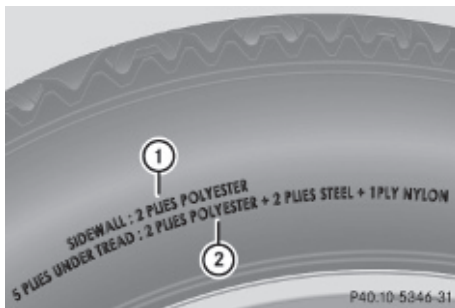

i For illustration purposes only. Actual data on tires are specific to each vehicle and may vary from data shown in above illustration.

This marking tells you about the type of cord and number of plies in the sidewall ① and under the tread ②.

Tire and loading terminology

Accessory weight

The combined weight (in excess of those standard items which may be replaced) of automatic transmission, power steering, power brakes, power windows, power seats,

radio, and heater, to the extent that these items are available as factory-installed equipment (whether installed or not).

Air pressure

The amount of air inside the tire pressing outward on each square inch of the tire. Air pressure is expressed in pounds per square inch (psi), kilopascal (kPa), or bar.

Aspect ratio

Dimensional relationship between tire section height and section width expressed in percentage.

Bar

Metric unit for air pressure. There are 14.5038 pounds per square inch (psi) to 1 bar; there are 100 kilopascals (kPa) to 1 bar.

Bead

The tire bead contains steel wires wrapped by steel cords that hold the tire onto the rim.

Cold tire inflation pressure

Tire inflation pressure when your vehicle has been sitting for at least 3 hours or driven no more than 1 mile (1.6 km).

Curb weight

The weight of a motor vehicle with standard equipment including the maximum capacity of fuel, oil, and coolant, and, if so equipped, air conditioning and additional optional equipment, but without passengers and cargo.

DOT (Department of Transportation)

A tire branding symbol which denotes the tire meets requirements of the U.S. Department of Transportation.

GAWR (Gross Axle Weight Rating)

The GAWR is the maximum permissible axle weight. The gross vehicle weight on each axle must never exceed the GAWR for the front and rear axle indicated on the certification label located on the driver's door B-pillar.

GVW (Gross Vehicle Weight)

The GVW comprises the weight of the vehicle including fuel, tools, spare wheel, installed accessories, passengers and cargo and, if applicable, trailer tongue load. The GVW must never exceed the GVWR indicated on the certification label located on the driver's door B-pillar.

GVWR (Gross Vehicle Weight Rating)

This is the maximum permissible vehicle weight of the fully loaded vehicle (weight of the vehicle including all options, passengers, fuel, and cargo and, if applicable, trailer tongue load). It is indicated on the certification label located on the driver's door B-pillar.

Kilopascal (kPa)

Metric unit for air pressure. There are 6.9 kPa to 1 psi; another metric unit for air pressure is bar. There are 100 kilopascals (kPa) to 1 bar.

Load index

Numerical code associated with the maximum load a tire can support.

Maximum load rating

The maximum load in kilograms and pounds that can be carried by the tire.

Maximum loaded vehicle weight

The sum of curb weight, accessory weight, total load limit, and production options weight.

Maximum permissible tire inflation pressure

This number is the greatest amount of air pressure that should ever be put in the tire.

Normal occupant weight

The number of occupants the vehicle is designed to seat, multiplied by 68 kilograms (150 lb).

Occupant distribution

The distribution of occupants in a vehicle at their designated seating positions.

Production options weight

The combined weight of those installed regular production options weighing over 5 lbs (2.3 kilograms) in excess of those standard items which they replace, not previously considered in curb weight or accessory weight, including heavy duty brakes, ride levelers, roof rack, heavy duty battery, and special trim.

PSI (Pounds per square inch)

A standard unit of measure for air pressure.

Recommended tire inflation pressure

The recommended tire inflation pressure for normal driving conditions is listed on the Tire and Loading Information placard located on the driver's door B-pillar. It provides best handling, tread life and riding comfort. Supplemental information pertaining to special driving situations can be found on the tire inflation pressure label on the inside of the fuel filler flap.

Rim

A metal support for a tire or a tire and tube assembly upon which the tire beads are seated.

Sidewall

The portion of a tire between the tread and the bead.

TIN (Tire Identification Number)

Unique identifier which facilitates efforts by tire manufacturers to notify purchasers in recall situations or other safety matters concerning tires and gives purchasers the means to easily identify such tires. The TIN is comprised of "Manufacturer's identification mark", "Tire size", "Tire type code" and "Date of manufacture".

Tire ply composition and material used

This indicates the number of plies or the number of layers of rubber-coated fabric in the tire tread and sidewall. Tire manufacturers also must indicate the ply materials in the tire and sidewall, which include steel, nylon, polyester, and others.

Tire speed rating

Part of tire designation (speed symbol); indicates the speed range for which a tire is approved.

Total load limit

Rated cargo and luggage load plus 68 kilograms (150 lb) times the vehicle's designated seating capacity.

Traction

The adhesive friction of a tire on a surface on which it moves. The amount of grip provided.

Tread

The portion of a tire that comes into contact with the road.

Treadwear indicators

Narrow bands, sometimes called "wear bars" that show across the tread of a tire when only $\frac{1}{16}$ in (1.6 mm) of tread remains.

Uniform Tire Quality Grading Standards

A tire information system that provides consumers with ratings for a tire's traction, temperature and treadwear. Ratings are determined by tire manufacturers using U.S. government testing procedures. The ratings are molded into the sidewall of the tire.

Vehicle maximum load on the tire

Load on an individual tire that is determined by distributing to each axle its share of the maximum loaded vehicle weight and dividing it by two.

Winter driving

General information

Have your vehicle winterized at an authorized Mercedes-Benz Center.

Winter tires

Warning!

Winter tires with a tread depth of less than $\frac{1}{8}$ in (4 mm) must be replaced. They are no longer suitable for winter operation.

Warning!

If you use your spare wheel when winter tires are fitted on the other wheels, be aware that the difference in tire characteristics may very well impair turning stability and that overall driving stability may be reduced. Adapt your driving style accordingly.

Have the spare wheel replaced by a regular road wheel with a winter tire at the nearest authorized Mercedes-Benz Center.

Always use winter tires at temperatures below 45°F (7°C) and whenever wintry road conditions prevail. Not all M+S rated tires provide special winter performance. Make sure the tires you use show the mountain/snowflake  marking on the tire sidewall. These tires meet specific snow traction performance requirements of the Rubber Manufacturers Association (RMA) and the Rubber Association of Canada (RAC) and have been designed specifically for use in snow conditions. Use of winter tires is the only way to achieve the maximum effectiveness of your vehicle's driving safety systems such as the ABS and the ESP® in winter operation.

For safe handling, make sure all mounted winter tires are of the same make and have the same tread design.

For information on winter tires for your vehicle model, see the "Technical data" section (▷ page 299).

Always observe the speed rating of the winter tires installed on your vehicle.

After installing winter tires:

- ▶ Check the tire inflation pressure and adjust it if necessary (▷ page 189).
- ▶ Restart the Advanced Tire Pressure Monitoring System (▷ page 190).

Snow chains

! When driving with snow chains, always select setting 1 of the vehicle level control. Other settings may result in damage to your vehicle.

! Some tire sizes do not leave adequate clearance for snow chains. To help avoid serious damage to your vehicle or tires, make sure the use of snow chains is permissible as specified in the "Technical data" section of this Operator's Manual.

Snow chains should only be driven on snow-covered roads at speeds not to exceed

30 mph (50 km/h). Remove chains as soon as possible when driving on roads without snow.

Observe the following guidelines when using snow chains:

- Use of snow chains is not permissible with all wheel/tire combinations (▷ page 299).
- Use snow chains in pairs and on rear wheels only. Follow the manufacturer's mounting instructions.

! If snow chains are mounted to the front wheels, they may scrape against the body or axle components. The tires or the vehicle could be damaged as a result.

- Only use snow chains that are approved by Mercedes-Benz. Any authorized Mercedes-Benz Center will be glad to advise you on this subject.
- Use of snow chains may be prohibited depending on location. Always check local and state laws before installing snow chains.
- Do not use snow chains on the spare wheel.

i When driving with snow chains, you may wish to switch off the ESP® (▷ page 56) before setting the vehicle in motion. This will improve the vehicle's traction.

Winter driving instructions

Warning!

If the vehicle becomes stuck in snow, make sure snow is kept clear of the exhaust pipe and from around the vehicle with the engine running. Otherwise, deadly carbon monoxide (CO) gases may enter vehicle interior resulting in unconsciousness and death.

To assure sufficient fresh air ventilation, open a window slightly on the side of the vehicle not facing the wind.

⚠ Warning!

The outside temperature indicator is not designed to serve as an ice-warning device and is therefore unsuitable for that purpose. Indicated temperatures just above the freezing point do not guarantee that the road surface is free of ice. The road may still be icy, especially in wooded areas or on bridges.

⚠ Warning!

On slippery road surfaces, never downshift in order to obtain braking action. This could result in drive wheel slip and reduced vehicle control. Your vehicle's ABS will not prevent this type of loss of control.

The most important rule for slippery or icy roads is to drive sensibly and to avoid abrupt acceleration, braking and steering maneuvers. Do not use the cruise control system under such conditions.

When the vehicle is in danger of skidding, shift the automatic transmission to neutral position **N**. Try to keep the vehicle under control by corrective steering action.

- ⓘ For information on driving with snow chains, see "Snow chains" (> page 208).

Road salts and chemicals can adversely affect braking efficiency. Increased pedal force may become necessary to produce the normal brake effect.

Depressing the brake pedal periodically when traveling at length on salt-strewn roads can bring road-salt-impaired braking efficiency back to normal.

If the vehicle is parked after being driven on salt-treated roads, the braking efficiency should be tested as soon as possible after driving is resumed.

⚠ Warning!

Make sure not to endanger any other road users when carrying out these braking maneuvers.

Driving instructions**Drive sensibly – save fuel**

To save fuel you should:

- Keep tires at the recommended inflation pressures.
- Remove unnecessary loads.
- Allow engine to warm up under low load use.
- Avoid frequent acceleration and deceleration.
- Have all maintenance work performed at the intervals specified in the Maintenance Booklet and as required by the Maintenance system. Contact an authorized Mercedes-Benz Center.

Fuel consumption is also increased by driving in cold weather, in stop-and-go traffic, on short trips and in mountainous areas.

Drinking and driving**⚠ Warning!**

Drinking and driving and/or taking drugs and driving are very dangerous combinations. Even a small amount of alcohol or drugs can affect your reflexes, perceptions and judgment.

The possibility of a serious or even fatal accident are greatly increased when you drink or take drugs and drive.

Do not drink or take drugs and drive or allow anyone to drive who has been drinking or taking drugs.

Pedals**⚠ Warning!**

Make sure absolutely no objects are obstructing the pedals' range of movement. Keep the driver's footwell clear of all obstacles. If there are any floor mats or

carpets in the footwell, make sure that the pedals still have sufficient clearance.

During sudden driving or braking maneuvers, the objects could get caught between the pedals. You could then no longer brake or accelerate. This could lead to accidents and injury.

Power assistance

Warning!

There is no power assistance for the steering and the brake when the engine is not running.

Steering and braking requires significantly more effort and you could lose control of the vehicle and cause an accident as a result.

Do not turn off the engine while the vehicle is in motion.

Warning!

The brake system requires electrical energy for operation.

A malfunction in the vehicle's power supply or electrical system may impair brake system operation and switch it into its emergency operation mode. In such a case, the red brake warning lamp and warning messages in the instrument cluster come on while driving. To brake, the driver must then apply significantly greater brake pedal pressure and depress the pedal much further to obtain the expected brake effect. If necessary, apply full pressure to the brake pedal. Brakes are only applied to the front wheels. Stopping distance is increased! If there is a malfunction in the electro-hydraulic brake system, we recommend that the vehicle be transported with all wheels off the ground using flatbed or appropriate wheel lift/dolly equipment.

Brakes

Downhill grades

 When driving down long and steep grades, relieve the load on the brakes by shifting into a lower gear to use the engine's braking power. This helps prevent overheating of the brakes and reduces wear.

When using the engine's braking power, a drive wheel may not spin for an extended period of time, e.g. on slippery road surfaces. This may cause serious damage to the drivetrain which is not covered by the Mercedes-Benz Limited Warranty.

Continuous or hard braking

Warning!

Resting your foot on the brake pedal will cause excessive and premature wear of the brake pads.

It can also result in the brakes overheating, thereby significantly reducing their effectiveness. It may not be possible to stop the vehicle in sufficient time to avoid an accident.

After hard braking, it is advisable to drive on for some time, rather than immediately park, so that the air stream will cool down the brakes faster.

Wet roads

Warning!

After driving in heavy rain for some time without applying the brakes or through water deep enough to wet brake components, the first braking action may be somewhat reduced and increased pedal pressure may be necessary to obtain expected brake effect. Maintain a safe distance from vehicles in front.

To help prevent brake disk corrosion after driving on wet or salt-covered roads, it is advisable to brake the vehicle with

considerable force prior to parking. The heat generated serves to dry the brakes.

Salt-covered roads

Warning!

A layer of salt on the brake discs and the brake linings may cause a delay in the braking effect, resulting in a significantly increased braking distance, which could lead to an accident.

To avoid this danger, you should:

- occasionally brake carefully when you are driving on salt-covered roads, so that any layer of salt that may have built up on the brake discs and the brake linings is removed without putting other road users at risk
- maintain a greater distance to the vehicle ahead and drive with particular care
- carefully apply the brakes at the end of a trip and immediately after commencing a new trip, so that salt residues are removed from the brake disc

Brake service

 The brake fluid level in the reservoir may be too low or the electro-hydraulic brake system may be malfunctioning if the brake warning lamp in the instrument cluster comes on and an acoustic warning sounds although the parking brake is released.

Observe additional messages in the multifunction display that may appear.

Brake pad wear or a leak in the system may be the reason for low brake fluid in the reservoir.

Have the brake system inspected immediately. Contact an authorized Mercedes-Benz Center.

All checks and service work on the brake system should be carried out by qualified technicians only. Contact an authorized Mercedes-Benz Center.

Only install brake pads and use brake fluid recommended by Mercedes-Benz.

Warning!

If other than recommended brake pads are installed, or other than recommended brake fluid is used, the braking properties of the vehicle can be degraded to an extent that safe braking is substantially impaired. This could result in an accident.

 Because the ESP® operates automatically, the engine and ignition must be shut off (SmartKey in starter switch position **0** or **1** or KEYLESS-GO start/stop button in position **0** or **1**) when the parking brake is being tested on a brake test dynamometer or when the vehicle is being towed with the front axle raised.

Active braking action through the ESP® may otherwise seriously damage the brake system which is not covered by the Mercedes-Benz Limited Warranty.

If your brake system is only subjected to moderate loads, you should occasionally test the effectiveness of the brakes by applying above-normal braking pressure at higher speeds. This will also enhance the grip of the brake pads.

Warning!

Make sure not to endanger any other road users when carrying out these braking maneuvers.

Refer to the description of the Brake Assist System (BAS) (> page 56).

High-performance brake system

The high-performance brake system is only available on SL 63 AMG and SL 65 AMG.

Warning!

New vehicle brake pads and disks, and replacement brake pads and disks may take several hundred miles of driving until they

provide optimum braking efficiency. Until that time, you may need to use increased brake pedal pressure while braking. Please be aware of this and adjust your driving and braking accordingly during this break-in period.

Excessive high-demand braking will cause correspondingly high brake wear. Please be attentive to the brake warning lamp in the instrument cluster and brake condition messages in the multifunction display.

Especially for high-performance driving, it is important to maintain and have the brake system checked regularly.

The high-performance brake system is designed to operate under the extremely high operating demands required to accommodate the performance capabilities of the vehicle.

The brakes may produce a squeaking-type noise depending on the

- vehicle speed
- brake force applied
- ambient conditions, e.g. temperature and humidity

As with any brake system, the wear of individual brake system components such as brake pads or disks strongly depends on your driving style and the conditions under which you operate the vehicle. Thus, a driving style calling for high-demand braking will cause your vehicle's brakes to wear more quickly.

Driving off

Warm up the engine smoothly. Do not place full load on the engine until the operating temperature has been reached.

- ⚠ When driving off on a slippery surface, do not allow a drive wheel to spin for an extended period with the ESP® switched off. Doing so may cause serious damage to the drivetrain which is not covered by the Mercedes-Benz Limited Warranty.

- ⚠ Simultaneously depressing the accelerator pedal and applying the brakes reduces engine performance and causes premature brake and drivetrain wear which is not covered by the Mercedes-Benz Limited Warranty.

Hydroplaning

Depending on the depth of the water layer on the road, hydroplaning may occur, even at low speeds and with new tires. In heavy rain or when conditions indicate possible hydroplaning:

- ▶ Reduce vehicle speed.
- ▶ Avoid track grooves in the road.
- ▶ Apply brakes cautiously.

Standing water

- ⚠ Do not drive through flooded areas. Before driving through water, determine its depth.

If you must drive through standing water, drive slowly to prevent water from entering the passenger compartment or the engine compartment. Water in these areas could cause damage to electrical components or wiring of the engine or transmission, or could result in water being ingested by the engine through the air intake causing severe internal engine damage. Any such damage is not covered by the Mercedes-Benz Limited Warranty.

Driving abroad

If you plan to drive the vehicle outside the U.S. or Canada, you should request dealer network information for your destination from any authorized Mercedes-Benz Center.

Control and operation of radio transmitter

Safety notes

Warning!

Please do not forget that your primary responsibility is to drive the vehicle. A driver's attention to the road must always be his/her primary focus when driving. For your safety and the safety of others, we recommend that you pull over to a safe location and stop before placing or taking a telephone call.

If you choose to use the telephone¹⁶ while driving, please use the hands-free device and only use the telephone when road, weather and traffic conditions permit. Some jurisdictions prohibit the driver from using a mobile telephone while driving a vehicle.

Only operate the COMAND¹⁶ (Cockpit Management and Data System) if road, weather and traffic conditions permit.

Otherwise, you may not be able to observe traffic conditions and could endanger yourself and others.

Bear in mind that at a speed of just 30 mph (approximately 50 km/h), your vehicle is covering a distance of 44 feet (approximately 14 m) every second.

Emission control

Certain systems of the engine serve to keep the toxic components of the exhaust gases within permissible limits required by law.

These systems will function properly only when maintained strictly according to factory specifications. Any adjustments on the engine should, therefore, be carried out only by qualified Mercedes-Benz Center authorized technicians.

Engine adjustments should not be altered in any way. Moreover, the specified service procedures must be carried out regularly

according to Mercedes-Benz servicing requirements. For details refer to the Maintenance Booklet.

Warning!

Inhalation of exhaust gas is hazardous to your health. All exhaust gas contains carbon monoxide (CO), and inhaling it can cause unconsciousness and possible death.

Do not run the engine in confined areas (such as a garage) which are not properly ventilated. If you think that exhaust gas fumes are entering the vehicle while driving, have the cause determined and corrected immediately. If you must drive under these conditions, drive only with at least one window fully open at all times.

Maintenance

Notes

The Maintenance System in your vehicle tracks the distance driven and the time elapsed since the last maintenance service. It calculates other maintenance service work required, and calls for the next maintenance service accordingly.

We strongly recommend that you have your vehicle serviced at an authorized Mercedes-Benz Center. Have it serviced in accordance with the Maintenance Booklet at the times called for by the maintenance service indicator.

-  Failure to have the vehicle maintained in accordance with the Maintenance Booklet and maintenance service indicator at the designated times/mileage will result in vehicle damage not covered by the Mercedes-Benz Limited Warranty.

¹⁶ Observe all legal requirements.

Maintenance service indicator message

Information on maintenance work and maintenance intervals are specified in the Maintenance Booklet. Contact an authorized Mercedes-Benz Center, or visit www.mbusa.com (USA only) for additional information.

The maintenance service indicator message will notify you when the next maintenance service is required.

Starting approximately 1 month before the next maintenance service is required, one of the following messages will appear in the right multifunction display. The messages will appear while you are driving or when you switch on the ignition (example service A):

Service A In XXXXX Miles (km)

Service A In XX Days

Service A Due Now



Clearing the maintenance service indicator message

The maintenance service indicator message is cleared automatically after approximately 30 seconds when you switch on the ignition or when reaching the service threshold while driving.

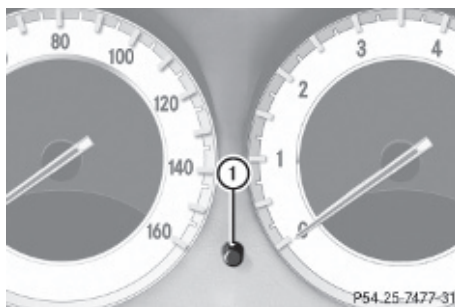

- ▶ **Clearing the maintenance service indicator message manually:** Press reset button ① on the instrument cluster. The standard display appears in the multifunction display.

Maintenance service term exceeded

If you have exceeded the suggested maintenance service term, you will see the following message in the right multifunction display:

Service A Exceeded By XXXX Miles (km)

Service A Exceeded By XXX Days



In addition, a signal sounds when the message appears.

Any authorized Mercedes-Benz Center will reset the maintenance service indicator following a completed maintenance service.





Calling up the maintenance service indicator display

- ① The menu overview can be found on (▷ page 115).

You can call up the maintenance service indicator display at any time to check when the next maintenance service is required.

- ▶ Switch on the ignition.
- ▶ Press button  or  on the multifunction steering wheel repeatedly

until the standard display (▷ page 116) appears in the multifunction display.

- ▶ Press button  or  on the multifunction steering wheel until the maintenance service indicator display with the service symbol  or  appears in the left multifunction display and the maintenance service deadline appears in the right multifunction display.

- i** If the battery was disconnected, the days of disconnection will not be included in the count shown by the maintenance service indicator. To arrive at the true maintenance service deadline, you will need to subtract these days from the days shown in the maintenance service indicator message or maintenance service indicator display.

Do not confuse the maintenance service indicator with the engine oil level indicator



Resetting the maintenance service indicator

In the event that the maintenance service on your vehicle is not carried out at an authorized Mercedes-Benz Center, you can have the maintenance service indicator reset.

The automotive maintenance facility carrying out the maintenance service will find the information for resetting the maintenance service indicator in the maintenance-relevant literature for your vehicle.

Such literature is available at any authorized Mercedes-Benz Center or directly from Mercedes-Benz.

- !** If the maintenance service indicator was reset inadvertently, have an authorized Mercedes-Benz Center correct it.

Only reset the maintenance service indicator if the proper maintenance service has been performed. Not following the proper maintenance service as described in the Maintenance Booklet will result in engine damage and/or other vehicle

damage not covered by the Mercedes-Benz Limited Warranty.

Vehicle care

Cleaning and care of the vehicle

Notes

Regular and proper care will help to maintain the value of your vehicle.

Warning!

Many cleaning products can be hazardous. Some are poisonous, others are flammable. Always follow the instructions on the particular container. Always open your vehicle's doors or windows when cleaning the inside.

Never use fluids or solvents that are not designed for cleaning your vehicle.

Always lock away cleaning products and keep them out of reach of children.

- !** When cleaning the vehicle, do not use scouring agents. Never apply strong force and only use a soft, wet cloth or sponge. Otherwise you may scratch or damage the surface to be cleaned.

While in operation, even while parked, your vehicle is subjected to varying external influences which, if gone unchecked, can attack the paintwork as well as the vehicle underbody and cause lasting damage.

Such damage is caused not only by extreme and varying climatic conditions, but also by:

- Air pollution
- Road salt
- Tar
- Gravel and stone chipping

To avoid paint damage, you should immediately remove:

- Grease and oil
- Fuel

- Coolant
- Brake fluid
- Bird droppings
- Insects
- Tree resins etc.

Frequent washing reduces and/or eliminates the aggressiveness and potency of the above adverse influences.

More frequent washings are necessary to deal with unfavorable conditions:

- near the ocean
- in industrial areas (smoke, exhaust emissions)
- during winter operation

You should check your vehicle from time to time for stone chipping or other damage. Any damage should be repaired as soon as possible to prevent corrosion.

In doing so, do not neglect the underbody of the vehicle. A prerequisite for a thorough check is a washing of the underbody followed by a thorough inspection. Damaged areas need to be re-undercoated.

Your vehicle has been treated at the factory with a wax-base rustproofing in the body cavities which will last for the lifetime of the vehicle. Post-production treatment is neither necessary nor recommended by Mercedes-Benz because of the possibility of incompatibility between materials used in the production process and others applied later.

We have selected vehicle-care products and compiled recommendations which are specially matched to our vehicles and which always reflect the latest technology. You can obtain Mercedes-Benz approved vehicle-care products at an authorized Mercedes-Benz Center.

Scratches, corrosive deposits, corrosion or damage due to negligent or incorrect care cannot always be removed or repaired with the vehicle-care products recommended

here. In such cases it is best to seek aid at an authorized Mercedes-Benz Center.

The following topics deal with the cleaning and care of your vehicle and give important “how-to” information as well as references to Mercedes-Benz approved vehicle-care products.

Power washer

! Follow the instructions provided by the power washer manufacturer on maintaining a distance between the vehicle and the nozzle of the power washer.

Never use a round nozzle to power-wash tires. The intense jet of water can result in damage to the tire.

Always replace a damaged tire.

Always keep the jet of water moving across the surface. Do not aim directly at electrical parts, electrical connectors, seals, or other rubber parts.

i Vehicles with KEYLESS-GO:

If a door handle is hit by a strong jet of water, and a SmartKey is within approximately 3 ft (1 m) of the vehicle, it could be inadvertently locked or unlocked.

Tar stains

Quickly remove tar stains before they dry and become more difficult to remove. A tar remover is recommended.

Paintwork, painted body components

! Affixing stickers, magnets, adhesive tape or similar materials to painted body components may damage the paintwork.

Mercedes-Benz approved Paint Care should be applied when water drops on the paint surface do not “bead up”. This should normally be done every 3 to 5 months, depending on the climate and washing detergent used.

Mercedes-Benz approved Paint Cleaner should be applied if the paint surface shows signs of embedded dirt (i.e. loss of gloss).

Do not apply any of these products or wax if your vehicle is parked in the sun or if the hood is still hot.

- ▶ Use the appropriate MB-Touch-Up Stick for quick and provisional repairs of minor paint damage (i.e. chips from stones, vehicle doors, etc.).

Vehicles with mat paint

Your vehicle is painted with mat clear-coat paint. Observe the following notes to avoid paint damage caused by improper treatment.

- i** Only use insect remover and car shampoo approved by Mercedes-Benz.

- !** Do not polish the vehicle. Polishing will brighten the paintwork.

Do not use paintwork cleaning agents, abrasives, polishing compounds, or wax for paintwork care. Such products are intended for use on high-polish surfaces. Using such products on mat paint causes severe damage, such as bright, spotted areas on the respective surface.

Have paintwork repairs performed at an authorized Mercedes-Benz Center.

Have stone chipping repairs as soon as possible.

Remove the following immediately if possible. Do not apply strong force.

- Soak insect remains with insect remover and rinse them off with water afterwards. Use a soft bristle toothbrush for remains that have not come off.
- Soak bird droppings with water and rinse them off with water afterwards. Use a soft bristle toothbrush for remains that have not come off.
- Remove tree resins, grease, oil, and gasoline with silicone remover.

- Dab off wax with silicone remover.
- Dab off tar splashes or tar stains with tar remover.

Engine cleaning

Prior to cleaning the engine compartment, make sure to protect electrical components and connectors from contact with water and cleaning agents.

Corrosion protection, such as MB Anticorrosion Wax should be applied to the engine compartment after every engine cleaning. Before applying, all control linkage bushings and joints should be lubricated. The poly-V-belt and all pulleys should be protected from any wax.

Vehicle washing

In the winter, thoroughly remove all traces of road salt as soon as possible.

When washing the vehicle underbody, do not forget to clean the inner sides of the wheels.

- i** Vehicles with KEYLESS-GO:
If a door handle is hit by a strong jet of water, and a SmartKey is within approximately 3 ft (1 m) of the vehicle, it could be inadvertently locked or unlocked.

Hand-wash

- ▶ Do not use hot water or wash your vehicle in direct sunlight.
- ▶ Only use a soft, wet cloth or sponge to clean the vehicle.
- ▶ Only use a mild vehicle wash detergent, such as Mercedes-Benz approved Car Shampoo.
- ▶ Thoroughly spray the vehicle with a diffused jet of water.
- ▶ Do not spray directly towards the ventilation intake.
- ▶ Use plenty of water and rinse the sponge and chamois frequently.
- ▶ Rinse with clean water and dry with a chamois thoroughly.

Do not allow cleaning agents to dry on the finish.

Automatic car wash

You can have your vehicle washed in an automatic car wash from the start. Brushless car washes are preferable.

► To protect the filter system, activate the air recirculation mode using button  on the climate control panel.

❗ Do not clean your vehicle in an automatic touchless car wash which uses caustic spray. Caustic spray will damage the paint or ornamental moldings.

If the vehicle is very dirty, prewash it before running it through the automatic car wash.

❗ Make sure the combination switch is set to wiper setting **0**. Otherwise, the rain sensor could activate and cause the wipers to move unintentionally. This may lead to vehicle damage.

Due to the width of the vehicle, fold in exterior rear view mirrors prior to running the vehicle through an automatic car wash to prevent damage to the mirrors.

► **When taking the vehicle through an automatic conveyor-type car wash:**
Make sure the automatic transmission remains in neutral position **N**.

When leaving the automatic car wash, make sure the mirrors are folded out.

After running the vehicle through an automatic car wash, wipe any wax off of the windshield and the wiper blade inserts. This will prevent smears and reduce wiping noise which can be caused by residual wax on the windshield.

Ornamental moldings

► For regular cleaning and care of ornamental moldings, use a damp cloth.

❗ Do not use chrome cleaner on ornamental moldings. Although ornamental moldings

may have chrome appearance, they could be made of anodized aluminum that will be damaged when cleaned with chrome cleaner. Instead, use a damp cloth to clean those ornamental moldings.

For very dirty ornamental moldings of which you are sure are chrome-plated, use a chrome cleaner. If in doubt whether an ornamental molding is chrome-plated, contact an authorized Mercedes-Benz Center.

Headlamps, brake lamps, tail lamps, side markers, turn signal lenses

► Use a mild vehicle wash detergent, such as Mercedes-Benz approved Car Shampoo, with plenty of water.

❗ Only use window cleaning solutions that are suitable for plastic lamp lenses. Window cleaning solutions which are not suitable may damage the plastic lamp lenses of the headlamps. Therefore, do not use abrasives, solvents or cleaners that contain solvents.

Cleaning the driving systems sensors

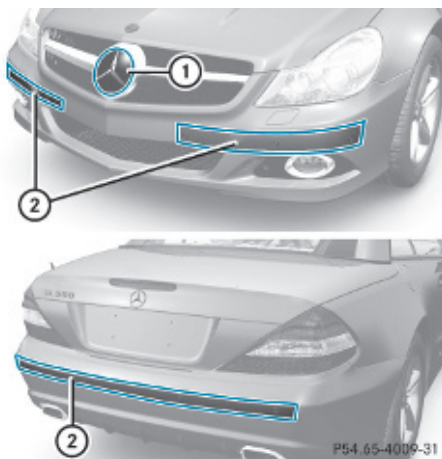

► Switch off the ignition.
► Clean Distronic system sensor cover (1) by hand.

To clean Distronic system sensor cover ① and the bumper area near sensors ② observe the following:

- Use a mild vehicle wash detergent, such as Mercedes-Benz approved Car Shampoo, with plenty of water.
- Use a soft, non-scratching cloth.

! If you use a power washer to clean the sensor covers, observe the following:

- Follow the instructions provided by the power washer manufacturer.
- Maintain a distance between the sensor covers and the nozzle of the power washer.

Cleaning the windows and the wiper blades

! The windshield wipers must be in a vertical position before folding them away from the windshield. They could otherwise damage the hood.

Never open the hood when the wiper arms are folded forward.

- ▶ Make sure the hood is fully closed.
- ▶ Switch on the ignition.
- ▶ Turn combination switch to wiper setting II (▷ page 95).
- ▶ With wiper arms in vertical position, switch off the ignition.

Warning!

For safety reasons, switch off wipers and remove SmartKey from starter switch before cleaning the windshield and/or the wiper blades. Vehicles with KEYLESS-GO: Make sure the vehicle's on-board electronics have status **0**. Otherwise, the wiper motor could suddenly turn on and cause injury.

! Do not pull on the wiper blade inserts. They could tear.

- ▶ Fold the wiper arms forward until they snap into place.
- ▶ Clean the windshield and the wiper blade inserts with a clean cloth and mild detergent solution.
- ▶ Use a soft, clean cloth and a mild window cleaning solution on all outside and inside glass surfaces.
An automotive glass cleaner is recommended.

! Fold the windshield wiper arms back onto the windshield before turning the SmartKey in the starter switch or pressing the KEYLESS-GO start/stop button.

Hold on to the wiper when folding the wiper arm back. If released, the force of the impact from the tensioning spring could crack the windshield.

! To clean the window interior, do not use a dry cloth, abrasives, solvents or cleaners containing solvents. Do not touch the inside of the windows with hard objects such as an ice scraper or ring. Doing so may damage the windows.

Rear window cleaning

Clean the rear window with the hardtop fully raised and closed.

Warning!

Do not clean the rear window with the hardtop in a position other than the fully raised and closed position. Otherwise, the hardtop may move unexpectedly which may result in personal injury to you or others.

- ▶ Use a soft, clean cloth and a mild window cleaning solution on all outside and inside glass surfaces.
An automotive glass cleaner is recommended.

Light alloy wheels

If possible, clean wheels once a week.

- ▶ Use Mercedes-Benz approved Wheel Care, a soft bristle brush and a strong spray of water for cleaning the light alloy wheels.

! Only use acid-free cleaning materials. Acid may cause corrosion or damage the clear coat.

! The vehicle should not be parked for an extended period of time immediately after it has been cleaned. This applies especially after the wheel rims have been cleaned with wheel rim cleaner. Wheel rim cleaners can lead to increased corrosion of the brake disks and brake pads. Non-approved wheel cleaners may also damage the wheel paint if the vehicle is not driven after cleaning.

Therefore, the vehicle's brake system should always be warmed-up before it is parked after cleaning. Drive your vehicle for several minutes to allow the brakes to dry. When applying Mercedes-Benz approved Tire Care and Mercedes-Benz approved Wheel Care products, take care not to spray them on the brake disks.

Plastic and rubber parts

- ▶ Use a gentle dishwashing detergent or mild detergent for delicate fabrics as a washing solution.
- ▶ Wipe with a cloth moistened in a lukewarm solution. The surface may temporarily change color. If this is the case, wait for it to dry.

Warning!

Do not use cleaners or cockpit care sprays containing solvents to clean the cockpit or the steering wheel. Cleaners containing solvents will make the surface porous and vehicle occupants could suffer serious injuries from plastic parts coming loose in the event of air bag deployment.

! Do not use oil, wax or scouring agents. Otherwise you may scratch or damage the surface.

Hard plastic trim items

- ▶ Use Mercedes-Benz approved Interior Care on a soft, lint-free cloth and apply with light pressure.

COMAND display

! You must switch off the COMAND display and allow it to cool prior to cleaning.

! Do not use any liquids or cleaning agents. These can damage or even destroy the COMAND display screen.

- ▶ Use a standard microfiber cloth and apply with light pressure.

Steering wheel and gear selector lever

- ▶ Wipe with a damp cloth and dry thoroughly or clean with Mercedes-Benz approved Leather Care.

Carpets

- ▶ Use Mercedes-Benz approved Carpet and Fabric Care for cleaning the carpets.

Headliner

- ▶ Use a soft bristle brush or a dry-shampoo cleaner in case of excessive dirt.

Seat belts

- ▶ Only use clear, lukewarm water and soap.

! The seat belts must not be treated with chemical cleaning agents. Do not dry the seat belts at temperatures above 176°F (80°C) or in direct sunlight.

Warning!

Do not bleach or dye seat belts as this may severely weaken them. In a crash they may not be able to provide adequate protection.

Upholstery

Using aftermarket seat covers or wearing clothing that have the tendency to give off coloring (e.g. when wet, etc.) may cause the upholstery to become permanently discolored. By lining the seats with a proper intermediate cover, contact-discoloration will be prevented.

Leather upholstery

Please note that leather upholstery is a natural product and is therefore subject to a natural aging process. Leather upholstery may also react to certain ambient influences such as high humidity or high temperature by showing wrinkles for example.

► Wipe leather upholstery with a damp cloth and dry thoroughly or clean with Mercedes-Benz approved Leather Care.

❗ To avoid damage to leather upholstery:

- Wipe with light pressure only.
- Do not clean with abrasive cleaning agents such as scouring milk or powder.
- Do not soak the leather upholstery.
As leather is a natural product, it could otherwise harden or become porous.
- Exercise particular care when cleaning perforated leather as its underside should not become wet.

Wood trims

► Only use water and a damp cloth to clean wood trims in your vehicle.

❗ Do not use solvents like tar remover or wheel cleaner nor polishes or waxes as these may be abrasive.

Chrome-plated exhaust tip

Regular cleaning and care of chrome-plated exhaust tips will help to maintain their shine and the classy appearance.

► Use Mercedes-Benz approved Chrome Polishing Paste each time the vehicle has been washed, especially during the winter.

❗ Do not use alkaline cleaners such as wheel cleaners as they could cause corrosion.

Vehicle equipment	224
Where will I find ...?	224
Vehicle status messages in the multifunction display	226
What to do if	254
Unlocking/locking manually	267
Replacing SmartKey batteries	269
Replacing bulbs	271
Replacing wiper blades	275
Flat tire	276
Battery	283
Jump starting	285
Towing the vehicle	287
Fuses	291



Vehicle equipment

i This Operator's Manual describes all features, standard or optional, potentially available for your vehicle at the time of purchase. Please be aware that your vehicle might not be equipped with all features described in this manual.

Where will I find ...?

First aid kit

! Always keep the storage compartment under the passenger seat closed while the vehicle is in motion.

i Check expiration dates and contents for completeness at least once a year and replace missing/expired items.

The first aid kit is located in the storage compartment under the passenger seat.



- ▶ Pull handle ① upward.
- ▶ Fold lid ② down.
- ▶ Remove the first aid kit.

Vehicle tool kit

The vehicle tool kit is located in the space underneath the trunk floor.

i Vehicles without spare wheel are not factory-equipped with the tools required for

a wheel change such as a jack or a wheel wrench. Some tools required for a wheel change are specific to your vehicle.

Contact an authorized Mercedes-Benz Center to obtain the tools approved for your vehicle.

The vehicle tool kit includes:

- 2 open-end wrenches¹⁷
- Alignment bolt¹⁷
- Electric air pump
- Fuse chart
- Hex-socket wrench
- Interchangeable slot/Phillips screwdriver
- Jack¹⁷
- Pair of universal pliers
- Protective wrap
- Towing eye bolt
- Wheel wrench
- Wheel wrench¹⁷

▶ **Removing:** Open the trunk (▷ page 73).

▶ Lift the trunk floor.

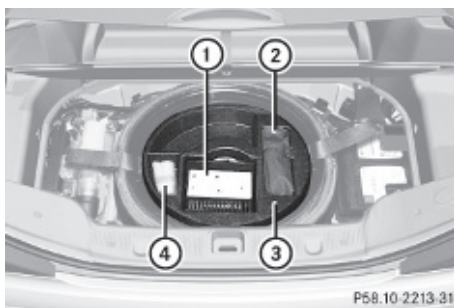

- ① Electric air pump
- ② Tool bag
- ③ Storage well casing
- ④ Protective wrap

i For transporting the damaged road wheel, use protective wrap ④ (if so equipped).

¹⁷ Vehicles with spare wheel only.

- ▶ **To access jack and wheel wrench:**
Remove storage well casing ③.
- ▶ Remove the spare wheel (▷ page 225).

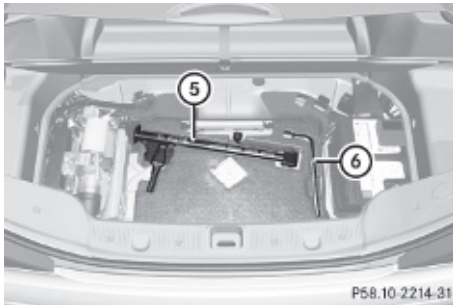

- ⑤ Jack
- ⑥ Wheel wrench

Jack

Warning!

Only use the jack supplied with your vehicle to lift the vehicle briefly for wheel changes. If you use the jack for any other purpose, you or others could be injured, as the jack is designed only for the purpose of changing a wheel.

When using the jack, observe the safety notes in the “Mounting the spare wheel” section and the notes on the jack.

Spare wheel

Observe Safety notes, see page 276.

The spare wheel is located in the space underneath the trunk floor.

- ▶ **Removing:** Open the trunk (▷ page 73).
- ▶ Lift the trunk floor.
- ▶ Remove the storage well casing (▷ page 224).

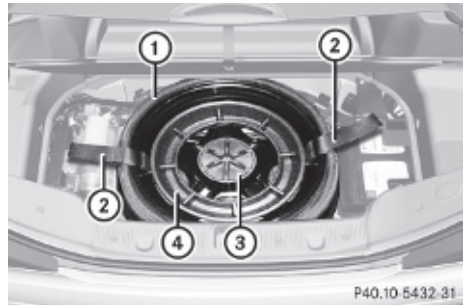

- ① Spare wheel
- ② Tensioning strap¹⁸
- ③ Retaining screw
- ④ Storage well casing base

- ▶ Remove storage well casing base ④.
- ▶ Remove retaining screw ③ by turning it counterclockwise.
- ▶ Remove spare wheel ①.

For information on mounting the spare wheel, see “Flat tire” (▷ page 276).

Storing the spare wheel after use

If you wish to store the spare wheel after use, carry out the following steps. Otherwise, the spare wheel may not fit into the spare wheel well.

- ❗ **Make sure the spare wheel is dry before storing it.**
- ▶ Unscrew the valve cap from the valve of the collapsible tire.
- ▶ Unscrew the valve insert from the valve using the valve extractor integrated in the valve cap.
- ▶ Allow the air to escape.
- ❗ **It may take a few minutes for the collapsible tire to deflate completely.**
- ▶ Use the valve extractor integrated in the valve cap to screw the valve insert back into the valve.

¹⁸ Vehicles with 19" spare wheel only.

- ▶ Screw the valve cap back onto the valve.
- ❗ Vehicles with 19" spare wheel only:
Before placing the spare wheel in the spare wheel well fasten tensioning straps, see "Compressing the collapsible tire" (▶ page 226).
- ▶ Place the spare wheel into the spare wheel well.
- ▶ Secure the spare wheel by turning retaining screw ③ clockwise.

Compressing the collapsible tire

This description applies to vehicles with 19" spare wheel only.

The collapsible tire on a 19" spare wheel must be compressed with two tensioning straps before you can store it in the spare wheel well.

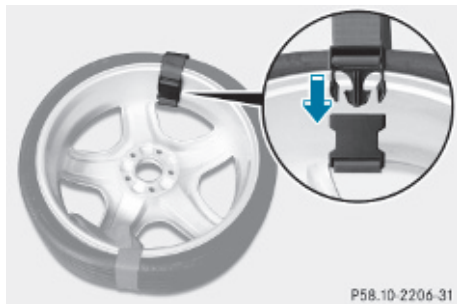

P58.10 2206 31

- ▶ Extend the tensioning strap by pulling the slider.
- ▶ Place tensioning strap around the spare wheel rim and collapsible tire with the buckle facing the inside of the rim.
- ▶ Close the buckle.
- ▶ Pull the loose end of the tensioning strap. The tensioning strap must be pulled as tight as possible.

Vehicle status messages in the multifunction display

Notes





Warning and malfunction messages appear in the multifunction display located in the instrument cluster.





Certain warning and malfunction messages are accompanied by an audible signal.

Address these messages accordingly and follow the additional instructions given in this Operator's Manual.

Selecting the **Vehicle status message memory** menu in the control system (▶ page 120) displays both cleared and uncleared messages.

High-priority messages appear in the multifunction display in red color.

Certain messages of high priority cannot be cleared from the multifunction display using the reset button (▶ page 112) or button , ,  or  on the multifunction steering wheel.

Other messages of high priority and messages of less immediate priority can be cleared from the multifunction display using the reset button or button , ,  or  on the multifunction steering wheel. They are then stored in the **Vehicle status message memory** menu (▶ page 120). Remember that clearing a message will only make the message disappear. Clearing a message will not correct the condition that caused the message to appear.

Warning!

All categories of messages contain important information which should be taken note of and, where a malfunction is indicated, addressed as soon as possible at an authorized Mercedes-Benz Center.

Failure to repair the condition noted may cause damage not covered by the Mercedes-

Benz Limited Warranty, or result in property damage or personal injury.

 **Warning!**

No messages will be displayed if either the instrument cluster or the multifunction display is inoperative.

As a result, you will not be able to see information about your driving conditions, such as

- speed
- outside temperature
- warning/indicator lamps

- malfunction/warning messages
- failure of any systems

Driving characteristics may be impaired.

If you must continue to drive, do so with added caution. Contact an authorized Mercedes-Benz Center as soon as possible.



On the pages that follow, you will find a compilation of the most important warning and malfunction messages that may appear. For your convenience the messages are divided into text messages (▷ page 227) and symbol messages (▷ page 237).

Text messages

Safety systems

Display messages		Possible causes/consequences and ► Solutions
ABS	ABS, ESP Inoperative See Oper. Manual.	The electro-hydraulic brake system is still functioning normally but due to a malfunction, the ABS, the BAS, the ESP®, and the hill-start assist system (SL 63 AMG only) are unavailable. ► Continue driving with added caution. Wheels may lock during hard braking, reducing steering capability. ► Have the system checked at an authorized Mercedes-Benz Center as soon as possible. Failure to follow these instructions increases the risk of an accident.
ABS	ABS, ESP Unavailable See Oper. Manual	The self-diagnosis may not be completed yet. The display will clear after driving a short distance at a vehicle speed of above 12 mph (20 km/h).

Display messages		Possible causes/consequences and ► Solutions
ABS	ABS, ESP Unavailable See Oper. Manual	<p>The electro-hydraulic brake system is still functioning normally but due to a malfunction, the ABS, the BAS, the ESP®, and the hill-start assist system (SL 63 AMG only) are unavailable.</p> <ul style="list-style-type: none"> ► Continue driving with added caution. Wheels may lock during hard braking, reducing steering capability. ► Have the system checked at an authorized Mercedes-Benz Center as soon as possible. <p>Failure to follow these instructions increases the risk of an accident.</p>
ESP	ESP Inoperative See Oper. Manual	<p>The electro-hydraulic brake system is still functioning normally but due to a malfunction the ESP®, and the hill-start assist system (SL 63 AMG only) are unavailable. The ABS may not be operational.</p> <ul style="list-style-type: none"> ► Continue driving with added caution. Wheels may lock during hard braking, reducing steering capability. ► Have the system checked at an authorized Mercedes-Benz Center as soon as possible. <p>Failure to follow these instructions increases the risk of an accident.</p>
ESP	ESP Unavailable See Oper. Manual	<p>The electro-hydraulic brake system still functions normally but due to insufficient power supply the ESP® and the hill-start assist system (SL 63 AMG only) are unavailable.</p> <ul style="list-style-type: none"> ► Synchronize the ESP®. With the vehicle stationary, turn the steering wheel completely to the left and then to the right. <p>! When synchronizing the ESP®, make sure you can turn the steering wheel in both directions as far as it will go without the wheels hitting any objects, e.g. a road curb.</p> <p>If the message in the multifunction display does not disappear:</p> <ul style="list-style-type: none"> ► Continue driving with added caution. Wheels may lock during hard braking, reducing steering capability. ► Have the system checked at an authorized Mercedes-Benz Center as soon as possible. <p>Failure to follow these instructions increases the risk of an accident.</p>

Display messages		Possible causes/consequences and ► Solutions
Front Passeng. Airbag	Enabled See Oper. Manual	<p>The passenger front air bag is activated while driving even though a child, small individual, or object below the system's weight threshold is on the passenger seat, or the passenger seat is empty. Objects on the seat or forces acting on the seat may make the system sense supplemental weight.</p> <ul style="list-style-type: none"> ► Stop the vehicle in a safe location as soon as possible. ► Engage the parking brake. ► Switch off the ignition. ► Open the passenger door. ► Remove child and child restraint from passenger seat. ► Make sure no objects which apply supplemental weight to the seat are present. The system may recognize such supplemental weight and sense that an occupant on the passenger seat is of a greater weight than actually present. ► Keep the seat unoccupied, close the passenger door and switch on the ignition. <p>Monitor the  indicator lamp (► page 45) and the multifunction display in the instrument cluster (► page 30) for the following:</p> <p>With the seat unoccupied and the ignition switched on,</p> <ul style="list-style-type: none"> • the  indicator lamp in the center console should illuminate and remain illuminated, indicating that the OCS (► page 43) has deactivated the passenger front air bag. • the message Front Passeng. Airbag Enabled See Oper. Manual or the message Front Passeng. Airbag Disabled See Oper. Manual should not appear in the multifunction display at any time the seat is unoccupied. Wait at least 60 seconds for the system to complete the necessary check cycles and to make sure neither message appears in the multifunction display. <p>If above conditions are met, you can occupy the passenger seat again. Depending on the passenger classification sensed by the OCS, the  indicator lamp will remain illuminated or go out.</p> <p>If above conditions are not met, the system is not working properly. Have the system checked at an authorized Mercedes-Benz Center as soon as possible.</p>

Warning!

If the  indicator lamp remains out even after performing the above corrective steps, do not have any children 12 years old and under and other small individuals use the passenger seat until the system has been repaired.

Display messages

Front Passeng. Airbag Disabled See Oper. Manual

Possible causes/consequences and ► Solutions

The passenger front air bag is deactivated while driving even though an adult or someone larger than a small individual is occupying the passenger seat. Forces acting on the seat may make the system sense a decrease in weight.

- Stop the vehicle in a safe location as soon as possible.
- Engage the parking brake.
- Switch off the ignition.
- Have the passenger vacate the seat and exit the vehicle.
- Keep the seat unoccupied, close the passenger door and switch on the ignition.

Monitor the  indicator lamp (► page 45) and the multifunction display in the instrument cluster (► page 30) for the following:

With the seat unoccupied and the ignition switched on,

- the  indicator lamp should illuminate and remain illuminated, indicating that the OCS (► page 43) has deactivated the passenger front air bag.
- the message Front Passeng. Airbag Enabled See Oper. Manual or the message Front Passeng. Airbag Disabled See Oper. Manual should not appear in the multifunction display at any time the seat is unoccupied. Wait at least 60 seconds for the system to complete the necessary check cycles and to make sure neither message appears in the multifunction display.

If above conditions are met, you can occupy the passenger seat again. Depending on the passenger classification sensed by the OCS, the  indicator lamp will remain illuminated or go out.

If above conditions are not met, the system is not working properly. Have the system checked at an authorized Mercedes-Benz Center as soon as possible.

Warning!

If the  indicator lamp remains illuminated with an adult occupant on the passenger seat even after performing the above corrective steps, do not have any passenger use the passenger seat until the system has been repaired.

Driving systems

Display messages		Possible causes/consequences and ► Solutions
ABC	Malfunction Stop Car	<p>You have started driving although the vehicle level is still too low.</p> <p>The vehicle is being raised. The ABC message goes out after a few seconds.</p> <ul style="list-style-type: none"> ► Stop the vehicle in a safe location or as soon as it is safe to do so. ► Wait until the message disappears from the multifunction display. You may then drive off.
ABC	Malfunction Stop Car	<p>The vehicle is losing oil.</p> <p>The ABC message appears continuously.</p> <ul style="list-style-type: none"> ► Stop the vehicle in a safe location or as soon as it is safe to do so. ► Engage the parking brake. ► Call Roadside Assistance. <p>or</p> <ul style="list-style-type: none"> ► Contact an authorized Mercedes-Benz Center.
ABC	Malfunction Stop Car	<p>The ABC is malfunctioning.</p> <ul style="list-style-type: none"> ► Stop the vehicle in a safe location and press the vehicle level control button to select a higher vehicle level (▷ page 142). <p>If the vehicle does not raise, observe the following when you continue to drive:</p> <ul style="list-style-type: none"> ► Do not turn steering wheel too far to avoid damaging the front fenders. ► Listen for scraping noises. ► Do not drive faster than 50 mph (80 km/h). ► Contact an authorized Mercedes-Benz Center as soon as possible.
ABC	Malfunction	<p>The capability of the ABC system is restricted. This can impair handling.</p> <ul style="list-style-type: none"> ► Do not drive faster than 50 mph (80 km/h). ► Contact an authorized Mercedes-Benz Center as soon as possible.

Display messages		Possible causes/consequences and ► Solutions
ABC	Vehicle Rising Please Wait	<p>The vehicle's level is too low while at a standstill. The vehicle will be raised.</p> <ul style="list-style-type: none"> ► Do not drive off. ► Wait until the message disappears from the multifunction display. You may then drive off.
Cruise Control And SPEEDTRONIC	Inoperative	<p>The cruise control is malfunctioning.</p> <ul style="list-style-type: none"> ► Have the cruise control checked at an authorized Mercedes-Benz Center.
- - - MPH	Cruise Control	<p>One of the activation conditions for the cruise control has not been fulfilled. You may have attempted to set a speed below 20 mph (30 km/h).</p> <ul style="list-style-type: none"> ► Drive faster than 20 mph (30 km/h) if the situation allows and set the speed. ► Check the activation conditions for cruise control (► page 131).
DTR - - - MPH		<p>One of the activation conditions for Distronic has not been fulfilled. You may have attempted to set a speed below 20 mph (30 km/h).</p> <ul style="list-style-type: none"> ► Drive faster than 20 mph (30 km/h) if the situation allows and set the speed. ► Check the activation conditions for Distronic (► page 136).
DISTRONIC	Inoperative	<p>The Distronic or the display are malfunctioning.</p> <ul style="list-style-type: none"> ► Contact an authorized Mercedes-Benz Center as soon as possible.
DTR	Override	<p>You have accelerated. The Distronic has switched off.</p> <ul style="list-style-type: none"> ► Stop accelerating.

Display messages		Possible causes/consequences and ► Solutions
DISTRONIC	Currently Unavailable. See Oper. Manual	<p>Distronic is deactivated because:</p> <ul style="list-style-type: none"> • The Distronic cover in the radiator grille is dirty. • The functionality is impaired by heavy precipitation or fog. • The system is overheated. <p>► If necessary, clean the Distronic cover in the area of the radiator grille (► page 218).</p> <p>► If necessary, wait until the system has cooled down.</p> <p>► Restart the vehicle.</p> <p>Distronic becomes operational again without the engine being restarted when</p> <ul style="list-style-type: none"> • dirt on the radiator grille has fallen off while driving (e.g. slush or snow) • the system recognizes full sensor availability (due to lessening rain or the road surface drying) • the message in the multifunction display disappears <p>You can then operate Distronic as usual again.</p>
DISTRONIC	Currently Unavailable. See Oper. Manual	<p>Distronic is deactivated because the functionality is impaired by external interferences, e.g. high-frequency sources such as toll stations, speed measuring systems etc.</p> <ul style="list-style-type: none"> ► Leave the area of the external interference. ► Activate Distronic again (► page 136) when the message in the multifunction display disappears. <p>Distronic is deactivated because the Distronic sensor has not sensed any other vehicles or objects, e.g. road sign or such, for a long time.</p> <ul style="list-style-type: none"> ► Activate Distronic again (► page 136) when the message in the multifunction display disappears.

Vehicle

Display messages		Possible causes/consequences and ► Solutions
P	Gear Selector Lever To P	You have attempted to start the engine with the KEYLESS-GO start/stop button while the automatic transmission was not in park position P . ► Shift the automatic transmission into park position P .
		You have attempted to turn off the engine with the KEYLESS-GO start/stop button while the automatic transmission was not in park position P . ► Shift the automatic transmission into park position P .
Close Rear	Side Windows	You are getting out of the vehicle and a rear side window is still open. ► Close the rear side window (> page 97).

Tires

Display messages		Possible causes/consequences and ► Solutions
Tire pressure	displayed after driving for a few minutes.	The tire inflation pressure is being checked by the Advanced TPMS. ► Drive the vehicle for a few minutes.
Tire Pressure Monitor	Inoperative	The Advanced TPMS is malfunctioning. ► Have the Advanced TPMS checked at an authorized Mercedes-Benz Center.
Tire Pressure Monitor	Inoperative No Wheel Sensors	There are wheels without appropriate wheel sensors mounted (e.g. winter tires). ► Have the Advanced TPMS checked at an authorized Mercedes-Benz Center. ► Have the appropriate wheel sensors installed at an authorized Mercedes-Benz Center.

Display messages		Possible causes/consequences and ► Solutions
Tire Pressure Monitor Wheel Sensor Missing		At least one sensor is defect (e.g. battery is empty). The respective tire is indicated by - - instead of the tire inflation pressure in the multifunction display. <ul style="list-style-type: none"> ► Have the Advanced TPMS checked at an authorized Mercedes-Benz Center. ► Have the wheel sensors installed at an authorized Mercedes-Benz Center.
		At least one wheel without appropriate wheel sensors is mounted (e.g. spare wheel). The respective tire is indicated by - - instead of the tire inflation pressure in the multifunction display. <ul style="list-style-type: none"> ► Have the Advanced TPMS checked at an authorized Mercedes-Benz Center. ► Have the wheel sensors installed at an authorized Mercedes-Benz Center.
Tire Pressure Monitor	Currently Unavailable	The Advanced TPMS cannot monitor the tire inflation pressure due to a nearby radio interference source or insufficient power supply. As soon as the causes of the malfunction have been rectified, the Advanced TPMS becomes active again automatically after a few minutes of driving.
Please correct the tire pressure.		The tire inflation pressure is too low in at least one tire. or The tire inflation pressures of the individual tires differ from each other significantly. The tire inflation pressure values are shown in the multifunction display. <ul style="list-style-type: none"> ► Check and correct tire inflation pressure as required (▷ page 189). ► Restart the Advanced TPMS (▷ page 192).
Caution Tire defect		At least one tire is deflating. The respective tire is indicated in the multifunction display. <ul style="list-style-type: none"> ► Carefully bring the vehicle to a halt, avoiding abrupt steering and braking maneuvers. ► If necessary, change the wheel (▷ page 276).

Display messages	Possible causes/consequences and ► Solutions
Check Tires	<p>The tire inflation pressure in at least one tire is significantly below the reference value.</p> <p>The respective tire is indicated in the multifunction display.</p> <ul style="list-style-type: none"> ► Carefully bring the vehicle to a halt, avoiding abrupt steering and braking maneuvers. ► Check and adjust tire inflation pressure as required. ► If necessary, change the wheel (► page 276).

 **Warning!**

Do not drive with a flat tire. A flat tire affects the ability to steer or brake the vehicle. You may lose control of the vehicle. Continued driving with a flat tire will cause excessive heat build-up and possibly a fire.

 **Warning!**



Follow recommended tire inflation pressures.

Do not underinflate tires. Underinflated tires wear excessively and/or unevenly, adversely affect handling and fuel economy, and are more likely to fail from being overheated.

Do not overinflate tires. Overinflated tires can adversely affect handling and ride comfort, wear unevenly, increase stopping distance, and result in sudden deflation (blowout) because they are more likely to become punctured or damaged by road debris, potholes etc.

Symbol messages

Brake

Display messages	Possible causes/consequences and ► Solutions
 <p>Reduced Brake Effect Depress brake pedal fully.</p>	<p>The electro-hydraulic brake system is in emergency operation mode. Considerably greater brake pedal force is required and the brake pedal travel is longer. The stopping distance is increased.</p> <p>The maximum speed is limited to 55 mph (90 km/h).</p> <ul style="list-style-type: none"> ► Stop the vehicle in a safe location or as soon as it is safe to do so. ► Engage the parking brake. ► Do not drive any further. ► Prevent the vehicle from rolling away by blocking the wheels with wheel chocks or other sizeable objects. ► Contact an authorized Mercedes-Benz Center or call Roadside Assistance.
<p>BRAKE (USA only)</p>  <p>(Canada only)</p> <p>Reduced Brake Effect Service Required</p>	<p>The electro-hydraulic brake system is in emergency operation mode. Considerably greater brake pedal force is required and the brake pedal travel is longer. The stopping distance is increased.</p> <ul style="list-style-type: none"> ► Stop the vehicle in a safe location or as soon as it is safe to do so. ► Engage the parking brake. ► Do not drive any further. ► Prevent the vehicle from rolling away by blocking the wheels with wheel chocks or other sizeable objects. ► Contact an authorized Mercedes-Benz Center or call Roadside Assistance.

 **Warning!**

Driving while one of the previous messages is displayed can result in an accident. Have your brake system checked immediately.

If the electro-hydraulic brake system enters its emergency operation mode, the driver must apply significantly greater brake pedal pressure and depress the pedal much further than normal to obtain braking effect.

If necessary, apply full pressure to the brake pedal. Brakes are only applied to the front wheels. Stopping distance is increased!

If there is a malfunction in the electro-hydraulic brake system, we recommend that the vehicle be transported with all wheels off the ground using flatbed or appropriate wheel lift/dolly equipment.

A tow bar must be used if circumstances do not permit the use of the recommended

towing methods and the vehicle requires towing with all four wheels on the ground.

Towing the vehicle with all four wheels on the ground is only permissible for distances up to

30 miles (50 km) and at a speed not to exceed 30 mph (50 km/h). For more information, see "Towing the vehicle".

Display messages **Possible causes/consequences and ► Solutions**



(USA only)



(Canada only)

Reduced Brake Effect Start Engine

The battery has insufficient voltage and cannot supply sufficient power to the electro-hydraulic brake system.

- Start the engine. The message disappears when sufficient voltage is available.

Warning!

Inhalation of exhaust gas is hazardous to your health. All exhaust gas contains carbon monoxide (CO), and inhaling it can cause

unconsciousness and lead to death. Do not run the engine in confined areas (such as a garage) which are not properly ventilated.

Display messages **Possible causes/consequences and ► Solutions**



Brake Wear

The brake pads have reached their wear limit.

- Have the brake pads replaced as soon as possible.

! Brake pad thickness must be visually inspected by a qualified technician at the intervals specified in the Maintenance Booklet.

Warning!

Have brake pad replacement and other work on the electro-hydraulic brake system carried out by qualified technicians only. Contact an authorized Mercedes-Benz Center for further information.

The electro-hydraulic brake system must be deactivated prior to working on the system. High pressure is intermittently built up in the system as part of its automatic self-test.

In addition, the system is automatically activated when the vehicle is unlocked by

remote control, when the driver or passenger door is opened, when the SmartKey in the starter switch is turned to position 1 or the KEYLESS-GO start/stop button is pressed once, when the brake pedal is depressed or when the parking brake is released. Failure to deactivate the system prior to maintenance will cause brake pistons to extend and brake fluid to leak, which may result in injuries (contusions and acid burns). Extended brake pistons may also cause injury.

Display messages	Possible causes/consequences and ► Solutions
<p>BRAKE (USA only)</p> <p> (Canada only)</p> <p>Check Brake Fluid Level</p>	<p>There is insufficient brake fluid in the reservoir. Risk of accident!</p> <ul style="list-style-type: none"> ► Stop the vehicle in a safe location or as soon as it is safe to do so. ► Do not drive any further. ► Contact an authorized Mercedes-Benz Center or call Roadside Assistance. <p>Do not add brake fluid! This will not solve the problem.</p>



 **Warning!**

Driving with the message Check Brake Fluid Level displayed can result in an accident. Have your brake system checked immediately.





Do not add brake fluid before checking the brake system. Overfilling the brake fluid

reservoir can result in spilling brake fluid on hot engine parts and the brake fluid catching fire. You can be seriously burned.

! If you find that the brake fluid in the brake fluid reservoir has fallen to the minimum mark or below, have the brake system checked for brake pad thickness and leaks.

Display messages	Possible causes/consequences and ► Solutions
<p>BRAKE (USA only)</p> <p> (Canada only)</p> <p>Brake Service Required</p>	<p>There are malfunctions, but the electro-hydraulic brake system is operating normally.</p> <ul style="list-style-type: none"> ► Contact an authorized Mercedes-Benz Center as soon as possible.
<p>BRAKE (USA only)</p> <p> (Canada only)</p> <p>Brakes Overheated Drive on, but with even greater care.</p>	<p>The brake system is overheated due to an excessive load on the brakes. Relieve the load on the brake system:</p> <ul style="list-style-type: none"> ► Drive more smoothly and think ahead to avoid unnecessary braking. ► When driving down steep grades, shift into a lower gear to use the engine's braking power (► page 108). ► Cautiously continue driving so that the air stream will cool down the brakes.
<p>BRAKE (USA only)</p> <p> (Canada only)</p> <p>Release Parking Brake</p>	<p>You are driving with the parking brake engaged.</p> <ul style="list-style-type: none"> ► Release the parking brake.

Safety systems

Display messages	Possible causes/consequences and ► Solutions
 <p>Raise Roll-over Bar</p>	<p>The roll bar is malfunctioning. For safety reasons, always have the roll bar raised when driving with the retractable hardtop open.</p> <ul style="list-style-type: none"> ► Attempt to raise the roll bar using the roll bar button (► page 51). ► Have the roll bar checked at an authorized Mercedes-Benz Center.
 <p>Raise Roll-over Bar</p>	<p>The roll bar was raised automatically and you have attempted to open or close the retractable hardtop.</p> <ul style="list-style-type: none"> ► Raise the roll bar manually until you hear the roll bar lock into place (► page 51). ► Open or close the retractable hardtop.
 <p>Tele Aid Inoperative</p>	<p>One or more main functions of the Tele Aid system are malfunctioning.</p> <ul style="list-style-type: none"> ► Have the Tele Aid system checked at an authorized Mercedes-Benz Center.
 <p>Restraint System Malfunction Service Required</p>	<p>There is a malfunction in the Supplemental Restraint System (SRS). The air bags or the Emergency Tensioning Devices (ETDs) could deploy unexpectedly or fail to activate in an accident.</p> <ul style="list-style-type: none"> ► Drive with added caution to the nearest authorized Mercedes-Benz Center and have the system checked immediately.







 **Warning!**









In the event a malfunction of the SRS is indicated as outlined above, the SRS may not be operational.





For your safety, we strongly recommend that you contact an authorized Mercedes-Benz

Center immediately to have the system checked. Otherwise the SRS may not be activated when needed in an accident, which could result in serious or fatal injury, or it might deploy unexpectedly and unnecessarily which could also result in injury.





Vehicle

Display messages		Possible causes/consequences and ► Solutions
		The trunk is open. ► Close the trunk (▷ page 75).
		You are driving with the hood open. ► Stop the vehicle in a safe location as soon as it is safe to do so. ► Close the hood (▷ page 181). There is otherwise danger of an accident.
		You are driving with the hood and the trunk open. ► Stop the vehicle in a safe location as soon as it is safe to do so. ► Close the hood (▷ page 181) or the trunk (▷ page 75). There is otherwise danger of an accident.
		You are driving with at least one door open. ► Close all doors.
	Check Doors	Vehicles with KEYLESS-GO: You are pressing the lock button on the door handle and at least one door is open. ► Close all doors.
	Retract. Roof Oper. Please Wait See Oper. Manual	The on-board voltage is too low. ► Repeat the opening or closing procedure. ► Start the engine. The hardtop drive system was shut down for safety reasons after multiple, consecutive attempts to raise or lower the hardtop. After about 10 minutes you can open or close the retractable hardtop. ► Switch on the ignition. ► Repeat the opening or closing procedure. ► If the retractable hardtop still does not open or close properly, have the hardtop system checked at an authorized Mercedes-Benz Center.
	Retractable Roof Lowering	The retractable hardtop is not completely opened or closed. The roof hydraulics will start to lose pressure. ► Make sure the retractable hardtop is completely opened or closed (▷ page 155).

Display messages	Possible causes/consequences and ► Solutions
 Retractable Roof Operation Only At Standstill	You have attempted to open the retractable hardtop while driving. <ul style="list-style-type: none"> ► Stop the vehicle in a safe location and try to open the hardtop again.
 Retractable Roof Not Opened/Closed Completely	You are driving with the retractable hardtop not properly locked. <ul style="list-style-type: none"> ► Stop the vehicle in a safe location. Observe the traffic situation around you. ► Pull or push on the retractable hardtop switch until the retractable hardtop is completely open or closed (► page 155). ► If the retractable hardtop still does not lock properly, have the hardtop system checked at an authorized Mercedes-Benz Center.
 Trunk Partition Open	You are trying to open or close the retractable hardtop even though the luggage cover in the trunk is not closed and/or properly engaged. <ul style="list-style-type: none"> ► Close the luggage cover and engage it into the side holders (► page 158).
 Key Detected In Vehicle	A SmartKey with KEYLESS-GO left in the vehicle was recognized while trying to lock the vehicle from the outside. <ul style="list-style-type: none"> ► Take the SmartKey out of the vehicle.
 Remove Key	You have forgotten to remove the SmartKey. <ul style="list-style-type: none"> ► Remove the SmartKey from the starter switch.
 Replace Key	The SmartKey is malfunctioning. <ul style="list-style-type: none"> ► Contact an authorized Mercedes-Benz Center.
 Change Key Batteries	The batteries in the SmartKey with KEYLESS-GO are discharged. <ul style="list-style-type: none"> ► Replace the batteries (► page 269).
 Key Not Detected (message appears in red)	The SmartKey with KEYLESS-GO is not detected while the engine is running because the SmartKey is not in the vehicle. <ul style="list-style-type: none"> ► Stop the vehicle as soon as it is safe to do so. ► Engage the parking brake. ► Search for the SmartKey. The vehicle cannot be locked centrally nor can the engine be started again after the engine is stopped.

Display messages	Possible causes/consequences and ► Solutions	
	Key Not Detected (message appears in red)	The SmartKey with KEYLESS-GO is not detected while the engine is running because there is strong radio-frequency interference. <ul style="list-style-type: none"> ► Stop the vehicle as soon as it is safe to do so. ► Engage the parking brake. ► Operate the vehicle with the SmartKey in the starter switch.
	Key Not Detected (message appears in white)	The SmartKey with KEYLESS-GO is momentarily not detected. <ul style="list-style-type: none"> ► Change the position of the SmartKey in the vehicle. ► Operate the vehicle with the SmartKey in the starter switch if necessary.
	Bluetooth Ready	The telephone has not yet been connected to the COMAND system via Bluetooth®. <ul style="list-style-type: none"> ► Connect the telephone to the COMAND system via Bluetooth®.
	Top Up Washer Fluid	The washer fluid in the washer fluid reservoir has fallen below the minimum level. <ul style="list-style-type: none"> ► Add washer fluid (► page 185).
	Entry Position Do Not Drive	The steering wheel has not yet moved into its stored driving position. <ul style="list-style-type: none"> ► Wait until the steering wheel has moved to its driving position. The message disappears.

Engine

Display messages	Possible causes/consequences and ► Solutions
 Engine Service or 	There may be a malfunction in <ul style="list-style-type: none"> • the fuel management system • the ignition system • the exhaust system • the fuel system ► Have the engine checked as soon as possible at an authorized Mercedes-Benz Center.
 Service Required	Certain electronic systems are unable to relay information to the control system. The coolant temperature display or the tachometer may have failed. ► Have the electronic systems checked at an authorized Mercedes-Benz Center.
 Top Up Coolant See Oper. Manual	The coolant level is too low. ► Add coolant (► page 184). ► If you have to add coolant frequently, have the cooling system checked at an authorized Mercedes-Benz Center.

 **Warning!**

Do not spill antifreeze on hot engine parts. Antifreeze contains ethylene glycol which may burn if it comes into contact with hot engine parts. You could be seriously burned.

! Do not ignore the low engine coolant level warning. Extended driving with the message and symbol displayed may cause serious engine damage not covered by the Mercedes-Benz Limited Warranty.

Do not drive without sufficient amount of coolant in the cooling system. The engine will overheat causing major engine damage.

Display messages		Possible causes/consequences and ► Solutions
	<p>Coolant Stop car, switch engine off.</p>	<p>The coolant is too hot.</p> <ul style="list-style-type: none"> ▶ Stop the vehicle immediately as soon as it is safe to do so. ▶ Turn off the engine immediately. ▶ Engage the parking brake. ▶ Only start the engine again after the message disappears. You could otherwise damage the engine. ▶ Observe the coolant temperature gauge in the instrument cluster. ▶ If the temperature rises again: Contact an authorized Mercedes-Benz Center immediately. <p>During severe operation conditions and stop-and-go city traffic, the coolant temperature may rise close to 248°F (120°C).</p>



 **Warning!**



Driving when your engine is overheated can cause some fluids which may have leaked into the engine compartment to catch fire. You could be seriously burned.

Steam from an overheated engine can cause serious burns which can occur just by opening the engine hood. Stay away from the engine if you see or hear steam coming from it.

Stop the vehicle in a safe location away from other traffic. Turn off the engine, get out of the vehicle and do not stand near the vehicle until the engine has cooled down.

- !** The engine should not be operated with the coolant temperature above 248°F (120°C). Doing so may cause serious damage which is not covered by the Mercedes-Benz Limited Warranty.

Display messages	Possible causes/consequences and ► Solutions
 <p data-bbox="232 177 347 319">Coolant Stop car, switch engine off.</p>	<p data-bbox="386 177 716 199">The poly-V-belt could be broken.</p> <ul style="list-style-type: none"> <li data-bbox="386 215 1002 239">► Stop the vehicle immediately as soon as it is safe to do so. <li data-bbox="386 247 739 271">► Turn off the engine immediately. <li data-bbox="386 279 632 303">► Check the poly-V-belt. <li data-bbox="386 311 1002 430">► If it is broken: Do not continue to drive. Otherwise the engine will overheat due to an inoperative water pump which may result in damage to the engine. Contact an authorized Mercedes-Benz Center. <li data-bbox="386 438 1002 558">► If it is intact: Do not continue to drive the vehicle with this message displayed. Doing so could result in serious engine damage that is not covered by the Mercedes-Benz Limited Warranty. <li data-bbox="386 566 1002 622">► Observe the coolant temperature gauge in the instrument cluster. <li data-bbox="386 630 968 686">► Drive to the nearest authorized Mercedes-Benz Center immediately.
	<p data-bbox="386 716 817 738">The radiator cooling fan is malfunctioning.</p> <ul style="list-style-type: none"> <li data-bbox="386 754 1002 810">► Observe the coolant temperature gauge in the instrument cluster. If the coolant temperature is below 248°F (120°C), you may continue driving to an authorized Mercedes-Benz Center. <li data-bbox="386 882 980 938">► Avoid placing heavy loads on the engine (e.g. by driving uphill) as well as stop-and-go traffic. <li data-bbox="386 946 845 970">► Have the fan replaced as soon as possible.

Display messages		Possible causes/consequences and ► Solutions
		<p>The battery is no longer charging.</p> <p>Possible causes:</p> <ul style="list-style-type: none"> • alternator malfunctioning • broken poly-V-belt • a malfunction in the electronic system <p>Do not forget that the brake system requires electrical energy and may be operating with restricted capability. Considerably greater brake pedal force is required and the stopping distance is increased.</p> <ul style="list-style-type: none"> ► Stop immediately in a safe location or as soon as it is safe to do so and check the poly-V-belt. ► If it is broken: Do not continue to drive. Otherwise the engine will overheat due to an inoperative water pump which may result in damage to the engine. Contact an authorized Mercedes-Benz Center. ► If it is intact: Drive to the nearest authorized Mercedes-Benz Center immediately. Adjust driving to be consistent with reduced braking responsiveness.
	<p>Battery/ Alternator Stop Car</p>	<p>The battery is defective.</p> <p>The electro-hydraulic brake system requires electrical energy and therefore has only limited operation. Considerably greater brake pedal force is required and the stopping distance is increased.</p> <ul style="list-style-type: none"> ► Stop the vehicle in a safe location or as soon as it is safe to do so. ► Adjust driving to be consistent with reduced braking responsiveness. ► Contact an authorized Mercedes-Benz Center.
	<p>Engine Oil Level Check Level</p>	<p>Vehicles with oil dipstick only:</p> <p>The engine oil has dropped to a critical level.</p> <ul style="list-style-type: none"> ► Check the engine oil level (► page 181) and add engine oil as required (► page 183). ► If you must add engine oil frequently, have the engine checked for possible leaks.

Display messages	Possible causes/consequences and ► Solutions
 <p>Add 1 qt engine oil at next refueling. (USA only) Add 1 liter engine oil at next refueling. (Canada only)</p>	<p>Vehicles with engine oil measuring system only: The engine oil level is too low.</p> <ul style="list-style-type: none"> ► Add engine oil (► page 183) and check the engine oil level (► page 181). ► If you must add engine oil frequently, have the engine checked for possible leaks.

If the message Add 1 qt (Canada: 1 liter) engine oil at next refueling or Engine Oil Level Check Level appears while the engine is running and at operating temperature, the engine oil level has dropped to approximately the minimum level.



The message will be stored in the vehicle status message memory after you have cleared it from the multifunction display.





Visually check for oil leaks. If there are no obvious oil leaks, drive to the nearest service

station to refill your engine oil to the required level.



For information on approved engine oils contact an authorized Mercedes-Benz Center or visit www.mbusa.com (USA only).





! Engine oil level warnings should not be ignored. Extended driving with the symbol displayed could result in serious engine damage that is not covered by the Mercedes-Benz Limited Warranty.





Display messages	Possible causes/consequences and ► Solutions
 <p>Engine Oil Level Cannot measure eng. oil level.</p>	<p>Vehicles with engine oil measuring system only: The measuring system is malfunctioning.</p> <ul style="list-style-type: none"> ► Have the measuring system checked at an authorized Mercedes-Benz Center.
 <p>Engine Oil Level Reduce Oil Level</p>	<p>Vehicles with engine oil measuring system only: You have added too much engine oil. There is a risk of damaging the engine or the catalytic converter.</p> <ul style="list-style-type: none"> ► Have oil siphoned or drained off. Observe all legal requirements with respect to its disposal.





Display messages		Possible causes/consequences and ► Solutions
	Engine Oil Level Stop car, switch engine off.	The engine oil level is too low. There is a danger of engine damage. <ul style="list-style-type: none"> ► Stop the vehicle in a safe location or as soon as it is safe to do so. ► Turn off the engine. ► Engage the parking brake. ► Add engine oil (► page 183) and check the engine oil level (► page 181).
		The fuel level is low. <ul style="list-style-type: none"> ► Refuel at the next gas station.
	Reserve Fuel	The fuel level has dropped below the reserve mark. <ul style="list-style-type: none"> ► Refuel at the next gas station.
	Fuel Cap Open	A loss of pressure has been detected in the fuel system. The fuel cap may not be closed properly or the fuel system may be leaking. <ul style="list-style-type: none"> ► Check the fuel cap (► page 178). ► If it is not closed properly: Close the fuel cap. ► If it is closed properly: Have the fuel system checked at an authorized Mercedes-Benz Center.



Lamps

Display messages		Possible causes/consequences and ► Solutions
	Active Headlamps Inoperative	The active Bi-Xenon headlamp system is malfunctioning. <ul style="list-style-type: none"> ► Contact an authorized Mercedes-Benz Center as soon as possible.
	Reverse Lamp Left or Reverse Lamp Right	The left or right backup lamp is malfunctioning. <ul style="list-style-type: none"> ► Replace the bulb as soon as possible (► page 271).



Display messages	Possible causes/consequences and ► Solutions
 <p>Brake Lamp Left Auxiliary Bulb On or Brake Lamp Right Auxiliary Bulb On</p>	<p>The left or right brake lamp is malfunctioning. A substitute bulb is being used.</p> <p>► Contact an authorized Mercedes-Benz Center as soon as possible.</p>
 <p>3rd Brake Lamp</p>	<p>The high-mounted brake lamp is malfunctioning. This message will only appear if all LEDs have stopped working.</p> <p>► Contact an authorized Mercedes-Benz Center as soon as possible.</p>
 <p>Front Foglamp Left or Front Foglamp Right</p>	<p>The left or right front fog lamp is malfunctioning.</p> <p>► Contact an authorized Mercedes-Benz Center as soon as possible.</p>
 <p>Marker Lamp Front Left or Marker Lamp Front Right</p>	<p>The front left side or right side marker lamp is malfunctioning.</p> <p>► Contact an authorized Mercedes-Benz Center as soon as possible.</p>
 <p>Marker Lamp Rear Left or Marker Lamp Rear Right</p>	<p>The rear left side or right side marker lamp is malfunctioning.</p> <p>► Contact an authorized Mercedes-Benz Center as soon as possible.</p>

Display messages		Possible causes/consequences and ► Solutions
	Parking Lamp Front Left Auxiliary Bulb On or Parking Lamp Front Right Auxiliary Bulb On	The left or right front parking lamp is malfunctioning. A substitute bulb is being used. ► Replace the bulb as soon as possible (▷ page 271).
	High Beam Left or High Beam Right	The left or right high-beam lamp is malfunctioning. ► Replace the bulb as soon as possible (▷ page 271).
	License Plate Lamp - Left or License Plate Lamp - Right	The left or right license plate lamp is malfunctioning. ► Replace the bulb as soon as possible (▷ page 271).
	AUTO Light Inoperative	The light sensor is malfunctioning. The headlamps come on automatically. ► Contact an authorized Mercedes-Benz Center as soon as possible. To switch off the headlamps (U.S. vehicles only): ► In the control system, set daytime running lamp mode to manual (▷ page 124). ► Switch off the headlamps using the exterior lamp switch (▷ page 89).
	Low Beam Left or Low Beam Right	The left or right low-beam lamp is malfunctioning. ► Contact an authorized Mercedes-Benz Center as soon as possible.

Display messages	Possible causes/consequences and ► Solutions
 <p>Rear Foglamp Left</p>	<p>The rear fog lamp is malfunctioning.</p> <p>► Contact an authorized Mercedes-Benz Center as soon as possible.</p>
 <p>Lights Are still On</p>	<p>You have removed the SmartKey from the starter switch, opened the driver's door and left the headlamps on or removed the SmartKey with KEYLESS-GO from the vehicle and left the headlamps on.</p> <p>► Turn the exterior lamp switch to 0 or AUTO (▷ page 89).</p> <p>or</p> <p>► With the rear fog lamp switched on: Push in the exterior lamp switch to its stop.</p>
 <p>Tail Lamp Left Auxiliary Bulb On or Tail Lamp Right Auxiliary Bulb On</p>	<p>The left or right tail lamp is malfunctioning. A substitute bulb is being used.</p> <p>► Contact an authorized Mercedes-Benz Center as soon as possible.</p>
 <p>Cornering Lamp Left or Cornering Lamp Right</p>	<p>The left or right corner-illuminating lamp is malfunctioning.</p> <p>► Replace the bulb as soon as possible (▷ page 271).</p>
 <p>Turn Signal Rear Left Auxiliary Bulb On or Turn Signal Rear Right Auxiliary Bulb On</p>	<p>The left or right rear turn signal lamp is malfunctioning. A substitute bulb is being used.</p> <p>► Replace the bulb as soon as possible (▷ page 271).</p>

Display messages		Possible causes/consequences and ► Solutions
	Turn Signal Front Left Auxiliary Bulb On or Turn Signal Front Right Auxiliary Bulb On	The left or right front turn signal lamp is malfunctioning. A substitute bulb is being used. ► Contact an authorized Mercedes-Benz Center as soon as possible.
	Turn Signal Left Mirror or Turn Signal Right Mirror	The turn signal in the left or right exterior rear view mirror is malfunctioning. This message will only appear if all LEDs have stopped working. ► Contact an authorized Mercedes-Benz Center as soon as possible.

Tires

Display messages		Possible causes/consequences and ► Solutions
	Please correct the tire pressure.	The tire inflation pressure is too low in at least one tire. or The tire inflation pressure of the individual tires differ from each other significantly. ► Check and correct tire inflation pressure as required (▷ page 189).
	Tire Pressure Caution Tire Defect	At least one tire is deflating. ► Carefully bring the vehicle to a halt, avoiding abrupt steering and braking maneuvers. ► If necessary, change the wheel (▷ page 276).

Display messages**Possible causes/consequences and ► Solutions**

Tire
Pressure
Check
Tires

The tire inflation pressure in at least one tire is significantly below the reference value.

- Carefully bring the vehicle to a halt, avoiding abrupt steering and braking maneuvers.
- Check and adjust tire inflation pressure as required.
- If necessary, change the wheel (► page 276).

Warning!

Do not drive with a flat tire. A flat tire affects the ability to steer or brake the vehicle. You may lose control of the vehicle. Continued driving with a flat tire will cause excessive heat build-up and possibly a fire.

Warning!

Follow recommended tire inflation pressures.

Do not underinflate tires. Underinflated tires wear excessively and/or unevenly, adversely affect handling and fuel economy, and are more likely to fail from being overheated.





Do not overinflate tires. Overinflated tires can adversely affect handling and ride comfort, wear unevenly, increase stopping distance, and result in sudden deflation (blowout) because they are more likely to become punctured or damaged by road debris, potholes etc.



What to do if ...**Lamps in instrument cluster****Notes**

If any of the following lamps in the instrument cluster fails to come on during the bulb self-check when switching on the ignition, have the respective bulb checked and replaced if necessary.

When you switch on the ignition, all lamps in the instrument cluster come on. The high-beam headlamp indicator lamp and turn signal indicator lamps will only come on if activated. If a lamp in the instrument cluster fails to come on when the ignition is switched on, have it checked and replaced if necessary.

Brake

Problem	Possible causes/consequences and ► Solutions
 The yellow ABS indicator lamp comes on while the engine is running.	<p>The ABS has detected a malfunction and switched off. The BAS, the ESP®, and the hill-start assist system (SL 63 AMG only) are also switched off.</p> <p>The electro-hydraulic brake system is still functioning normally but without the systems specified above available.</p> <p>If the ABS control unit is malfunctioning, other systems such as the navigation system or the automatic transmission may also be malfunctioning.</p> <ul style="list-style-type: none"> ► Continue driving with added caution. Wheels may lock during hard braking, reducing steering capability. ► Adjust driving to be consistent with reduced braking responsiveness. ► Read and observe messages that may appear in the multifunction display (► page 226). ► Have the system checked at an authorized Mercedes-Benz Center as soon as possible. <p>Failure to follow these instructions increases the risk of an accident.</p>
 The yellow ABS indicator lamp comes on while the engine is running.	<p>The ABS has switched off due to insufficient power supply. The battery might not be charged sufficiently.</p> <p>When the voltage is above the required value again, the ABS is operational again. The ABS indicator lamp should go out.</p> <ul style="list-style-type: none"> ► Continue driving with added caution. Wheels may lock during hard braking, reducing steering capability. ► Adjust driving to be consistent with reduced braking responsiveness. ► Read and observe messages that may appear in the multifunction display (► page 226). ► If the ABS indicator lamp does not go out: Have the alternator and the battery checked.
 (USA only)  (Canada only) The red brake warning lamp comes on while driving and an acoustic warning sounds.	<p>You are driving with the parking brake engaged.</p> <ul style="list-style-type: none"> ► Release the parking brake.

Problem	Possible causes/consequences and ► Solutions
 (USA only)  (Canada only) The red brake warning lamp comes on while the engine is running and an acoustic warning sounds.	There is a malfunction in the electro-hydraulic brake system. There is insufficient brake fluid in the reservoir. Risk of accident! ► Do not drive any further. Stop the vehicle in a safe location as soon as it is safe to do so. ► Engage the parking brake. ► Read and observe messages that may appear in the multifunction display (► page 226). ► Contact an authorized Mercedes-Benz Center. Do not add brake fluid! This will not solve the problem.

Warning!



Driving with the brake warning lamp illuminated can result in an accident. Have your brake system checked immediately if the brake warning lamp stays on. Do not add brake fluid before checking the brake system.



Overfilling the brake fluid reservoir can result in spilling brake fluid on hot engine parts and

the brake fluid catching fire. You can be seriously burned.

! If you find that the brake fluid in the brake fluid reservoir has fallen to the minimum mark or below, have the brake system checked for brake pad thickness and leaks.

Safety systems

Problem	Possible causes/consequences and ► Solutions
 The red seat belt telltale comes on for a maximum of 6 seconds after starting the engine.	The seat belt telltale reminds you and your passenger to fasten your seat belts before driving off. ► Fasten your seat belts. Regardless of whether the seat belts are fastened or not, the seat belt telltale always comes on and remains lit for 6 seconds after starting the engine.
 The red seat belt telltale comes on. In addition you hear a warning chime for a maximum of 6 seconds after starting the engine.	You have forgotten to fasten your seat belt. ► Fasten your seat belt. The warning chime stops sounding.

Problem	Possible causes/consequences and ► Solutions
 The red seat belt telltale comes on while the vehicle is standing still and the engine is running or while driving.	<p>You and/or your passenger have forgotten to fasten your seat belts.</p> <ul style="list-style-type: none"> ► Fasten your seat belts. The seat belt telltale goes out. <p>There are items placed on the passenger seat and therefore the system senses the passenger seat as being occupied.</p> <ul style="list-style-type: none"> ► Remove the items from the passenger seat and put them in a safe place. The seat belt telltale goes out.
 The red seat belt telltale flashes while driving. In addition, an intermittent warning chime sounds with increasing intensity.	<p>The vehicle's speed once exceeded 15 mph (25 km/h) and you and/or your passenger have forgotten to fasten your seat belts.</p> <ul style="list-style-type: none"> ► Fasten your seat belts. The seat belt telltale goes out and the warning chime stops sounding. <p>There are items placed on the passenger seat and therefore the system senses the passenger seat as being occupied.</p> <ul style="list-style-type: none"> ► Remove the items from the passenger seat and put them in a safe place. The seat belt telltale goes out and the warning chime stops sounding.

- i** After 60 seconds with an unfastened seat belt the warning chime stops sounding and the seat belt telltale illuminates continuously. The seat belt telltale will only go out if both, the driver and passenger's seat belt are fastened, or the vehicle is standing still and a door is opened.

Problem	Possible causes/consequences and ► Solutions
 The red SRS indicator lamp comes on while driving.	<p>There is a malfunction in the restraint systems. The air bags or Emergency Tensioning Devices (ETDs) could deploy unexpectedly or fail to activate in an accident.</p> <ul style="list-style-type: none"> ► Drive with added caution to the nearest authorized Mercedes-Benz Center.

Warning!

In the event a malfunction of the SRS is indicated as outlined above, the SRS may not be operational.

For your safety, we strongly recommend that you contact an authorized Mercedes-Benz

Center immediately to have the system checked. Otherwise the SRS may not be activated when needed in an accident, which could result in serious or fatal injury, or it might deploy unexpectedly and unnecessarily which could also result in injury.

Problem	Possible causes/consequences and ► Solutions
 The yellow roll bar warning lamp comes on when the engine is running.	<p>The roll bar system is malfunctioning.</p> <p>For safety reasons, always have the roll bar raised when driving with the retractable hardtop open.</p> <ul style="list-style-type: none"> ► Attempt to raise the roll bar manually (► page 51). ► Have the system checked at an authorized Mercedes-Benz Center as soon as possible.

Warning!



If the yellow roll bar warning lamp  in the instrument cluster does not go out after starting the engine, or if it comes on while driving, the roll bar system is not operating properly and may not activate in an accident. At the same time, the message Raise Roll-

over Bar appears in the multifunction display. In this case, raise the roll bar manually before continuing to drive.

For safety reasons, drive only with the roll bar raised until the malfunction is repaired. Have your vehicle checked at an authorized Mercedes-Benz Center.

Version 1



Depending on vehicle production date, the indicator and warning lamps in the instrument cluster differ. This section describes version 1 of the instrument cluster. Refer to the “Instrument cluster” section (► page 30) to determine which version your vehicle is equipped with.





Problem	Possible causes/consequences and ► Solutions
 The yellow ESP® OFF warning lamp comes on while the engine is running.	<p>The ESP® has been switched off. Risk of accident!</p> <p>When the ESP® is switched off it will not stabilize the vehicle if the system recognizes that the vehicle starts to skid or that a wheel is spinning.</p> <ul style="list-style-type: none"> ► Switch the ESP® back on. Exceptions: (► page 57). ► If leaving the ESP® switched off, adapt your speed and driving to the prevailing road and weather conditions. ► If the ESP® cannot be switched back on: Have the system checked at an authorized Mercedes-Benz Center as soon as possible.
SPORT SL 63 AMG only: The yellow SPORT handling mode warning lamp comes on while the engine is running.	<p>The SPORT handling mode is switched on Risk of accident!</p> <p>When the SPORT handling mode is switched on, it will only stabilize the vehicle to a limited extent if the system recognizes that the vehicle starts to skid or that a wheel is spinning.</p> <ul style="list-style-type: none"> ► Switch the SPORT handling mode off (► page 58).
  The yellow ESP® warning lamp and the yellow ESP OFF warning lamp come on while the engine is running.	<p>The ESP® is not operational due to a malfunction. Risk of accident!</p> <ul style="list-style-type: none"> ► Read and observe additional messages that may appear in the multifunction display. ► Continue driving with added caution. Wheels may lock during hard braking, reducing steering capability. ► Adapt your speed and driving to the prevailing road and weather conditions. ► Have the system checked at an authorized Mercedes-Benz Center as soon as possible.

Problem	Possible causes/consequences and ► Solutions
 The yellow ABS/ESP® warning lamp flashes while driving.	<p>The ABS, the ESP®, or the Electronic Traction System (ETS) has come into operation because of detected traction loss in at least one tire.</p> <ul style="list-style-type: none"> ► When driving off, apply as little throttle as possible. ► While driving, ease up on the accelerator pedal. ► Adapt your speed and driving to the prevailing road and weather conditions. ► Do not switch off the ESP®. <p>Exceptions: (► page 57).</p> <p>Failure to follow these instructions increases the risk of an accident.</p>



Version 2

Depending on vehicle production date, the indicator and warning lamps in the instrument cluster differ. This section describes version 2 of the instrument cluster. Refer to the “Instrument cluster” section (► page 30) to determine which version your vehicle is equipped with.



Problem	Possible causes/consequences and ► Solutions
 All models, except SL 63 AMG: The yellow ABS/ESP® warning lamp comes on while the engine is running.	<p>The ESP® has been switched off. Risk of accident!</p> <p>When the ESP® is switched off it will not stabilize the vehicle if the system recognizes that the vehicle starts to skid or that a wheel is spinning.</p> <ul style="list-style-type: none"> ► Switch the ESP® back on. <p>Exceptions: (► page 57).</p> <ul style="list-style-type: none"> ► If leaving the ESP® switched off, adapt your speed and driving to the prevailing road and weather conditions. ► If the ESP® cannot be switched back on: Have the system checked at an authorized Mercedes-Benz Center as soon as possible.
 SL 63 AMG only: The yellow ABS/ESP® warning lamp comes on while the engine is running.	<p>The SPORT handling mode is switched on. Risk of accident!</p> <p>When the SPORT handling mode is switched on, it will only stabilize the vehicle to a limited extent if the system recognizes that the vehicle starts to skid or that a wheel is spinning.</p> <ul style="list-style-type: none"> ► Switch the the SPORT handling mode off (► page 58). <p>The message ESP-ON appears in the multifunction display.</p>

Problem	Possible causes/consequences and ► Solutions
 SL 63 AMG only:  The yellow ABS/ESP® warning lamp and the yellow ESP OFF warning lamp come on while the engine is running.	<p>The ESP® has been switched off. Risk of accident!</p> <p>When the ESP® is switched off it will not stabilize the vehicle if the system recognizes that the vehicle starts to skid or that a wheel is spinning.</p> <ul style="list-style-type: none"> ► Switch the ESP® back on. Exceptions: (► page 60). ► If leaving the ESP® switched off, adapt your speed and driving to the prevailing road and weather conditions. ► If the ESP® cannot be switched back on: Have the system checked at an authorized Mercedes-Benz Center as soon as possible.
 The yellow ABS/ESP® warning lamp comes on while the engine is running.	<p>The ESP® is not operational due to a malfunction. Risk of accident!</p> <ul style="list-style-type: none"> ► Read and observe additional messages that may appear in the multifunction display. ► Continue driving with added caution. Wheels may lock during hard braking, reducing steering capability. ► Adapt your speed and driving to the prevailing road and weather conditions. ► Have the system checked at an authorized Mercedes-Benz Center as soon as possible.
 The yellow ESP® warning lamp flashes while driving. The yellow ABS/ESP® warning lamp flashes while driving.	<p>The ABS, the ESP®, or the Electronic Traction System (ETS) has come into operation because of detected traction loss in at least one tire.</p> <ul style="list-style-type: none"> ► When driving off, apply as little throttle as possible. ► While driving, ease up on the accelerator pedal. ► Adapt your speed and driving to the prevailing road and weather conditions. ► Do not deactivate the ESP®. Exceptions: (► page 57). <p>Failure to follow these instructions increases the risk of an accident.</p>





Driving systems

Problem	Possible causes/consequences and ► Solutions
 The white Distronic indicator lamp comes on while driving.	The Distronic distance sensor has recognized a preceding vehicle.
 The red distance warning lamp comes on while driving and an acoustic warning sounds.	<p>You are gaining too rapidly on the vehicle ahead of you or the distance warning system has recognized a stationary obstacle on your probable line of travel.</p> <ul style="list-style-type: none"> ► Apply the brakes immediately. ► Carefully observe the traffic situation. You may need to brake or maneuver to avoid hitting an obstacle.

Vehicle

Problem	Possible causes/consequences and ► Solutions
 The yellow fuel tank reserve warning lamp comes on when the engine is running.	<p>The fuel level has gone below the reserve mark.</p> <ul style="list-style-type: none"> ► Refuel at the next gas station.
 The yellow fuel tank reserve warning lamp comes on when the engine is running.	<p>The fuel cap is not closed properly.</p> <ul style="list-style-type: none"> ► Close the fuel cap.

Engine

Problem	Possible causes/consequences and ► Solutions
<p> (USA only¹⁹)  (Canada only¹⁹) The yellow engine malfunction indicator lamp comes on when the engine is running.</p>	<p>There may be a malfunction in</p> <ul style="list-style-type: none"> • the fuel management system • the ignition system • the emission control system • systems which affect emissions <p>Such malfunctions may result in excessive emissions values and may switch the engine to limp-home (emergency operation) mode.</p> <p>► Have the vehicle checked as soon as possible at an authorized Mercedes-Benz Center.</p> <p>i Some states may by law require you to visit a workshop as soon as the engine malfunction indicator lamp comes on. Check local requirements.</p>
<p> (USA only¹⁹)  (Canada only¹⁹) The yellow engine malfunction indicator lamp comes on when the engine is running.</p>	<p>A loss of pressure has been detected in the fuel system. The fuel cap may not be closed properly or the fuel system may be leaky.</p> <p>► Check the fuel cap (▷ page 178).</p> <p>► If it is not closed properly: Close the fuel cap.</p> <p>► If it is closed properly: Have the fuel system checked by an authorized Mercedes-Benz Center.</p>
<p> The red coolant temperature warning lamp comes on when the engine is running.</p>	<p>There is insufficient coolant in the reservoir.</p> <p>If this warning lamp comes on frequently, there is a leak in the cooling system.</p> <p>If the coolant level is correct, the electric radiator fan may be broken.</p> <ul style="list-style-type: none"> ► Immediately add coolant to prevent engine from overheating (▷ page 184). ► Have the cooling system checked. ► If the coolant temperature is below 248°F (120°C), you can continue driving to the nearest authorized Mercedes-Benz Center. ► Avoid high engine loads (e.g. driving uphill) and stop-and-go driving.

¹⁹ Depending on vehicle production date, U.S. vehicles may be equipped with the Canada engine malfunction indicator lamp .

Problem	Possible causes/consequences and ► Solutions
 <p>The red coolant temperature warning lamp comes on when the engine is running and an acoustic warning sounds.</p>	<p>The coolant temperature has exceeded 248°F (120°C).</p> <ul style="list-style-type: none"> ► Stop in a safe location as soon as possible and allow the engine and coolant to cool down.

 **Warning!**



Driving when your engine is overheated can cause some fluids which may have leaked into the engine compartment to catch fire. You could be seriously burned.

Steam from an overheated engine can cause serious burns which can occur just by opening the engine hood. Stay away from the engine if you see or hear steam coming from it.

Stop the vehicle in a safe location away from other traffic. Turn off the engine, get out of the vehicle and do not stand near the vehicle until the engine has cooled down.

 The engine should not be operated with the coolant temperature above 248°F (120°C). Doing so may cause serious damage which is not covered by the Mercedes-Benz Limited Warranty.

Tires

Problem	Possible causes/consequences and ► Solutions
<p> USA only: Combination low tire pressure telltale/TPMS malfunction telltale for the Advanced TPMS illuminates continuously.</p> <p>Canada only: Low tire pressure telltale for the Advanced TPMS illuminates continuously.</p>	<p>The Advanced TPMS detects a loss of pressure in at least one tire.</p> <ul style="list-style-type: none"> ► Carefully bring the vehicle to a halt, avoiding abrupt steering and braking maneuvers. Observe the traffic situation around you. ► Read and observe messages in the multifunction display (▷ page 226). <p>If the tire inflation pressure in the respective tire(s) has (have) been corrected, the combination low tire pressure/TPMS malfunction telltale goes out after a few minutes of driving.</p>
<p> USA only: Combination low tire pressure telltale/TPMS malfunction telltale for the Advanced TPMS flashes 60 seconds and then stays illuminated.</p>	<p>There is a malfunction in the Advanced TPMS.</p> <ul style="list-style-type: none"> ► Read and observe messages in the multifunction display (▷ page 226). ► Have the TPMS checked at an authorized Mercedes-Benz Center. ► Have the Advanced TPMS checked at an authorized Mercedes-Benz Center. <p>After the malfunction has been remedied, the combination low tire pressure/TPMS malfunction telltale goes out after a few minutes of driving.</p>

Practical hints

 **Warning!**

Each tire, including the spare (if provided), should be checked at least once a month when cold and inflated to the inflation pressure recommended by the vehicle manufacturer on the Tire and Loading Information placard on the driver's door B-pillar or the tire inflation pressure label on the inside of the fuel filler flap. If your vehicle has tires of a different size than the size indicated on the Tire and Loading Information placard or the tire inflation pressure label, you should

determine the proper tire inflation pressure for those tires.

As an added safety feature, your vehicle has been equipped with a tire pressure monitoring system (TPMS) that illuminates a low tire pressure telltale when one or more of your tires are significantly underinflated. Accordingly, when the low tire pressure telltale illuminates, you should stop and check your tires as soon as possible, and inflate them to the proper pressure. Driving on a significantly underinflated tire causes the tire to overheat and can lead to tire failure.

Underinflation also reduces fuel efficiency and tire tread life, and may affect the vehicle's handling and stopping ability. Please note that the TPMS is not a substitute for proper tire maintenance, and it is the driver's responsibility to maintain correct tire pressure, even if underinflation has not reached the level to trigger illumination of the TPMS low tire pressure telltale.

USA only:

Your vehicle has also been equipped with a TPMS malfunction indicator to indicate when the system is not operating properly. The TPMS malfunction indicator is combined with the low tire pressure telltale. When the system detects a malfunction, the telltale will flash for approximately 1 minute and then

remain continuously illuminated. This sequence will continue upon subsequent vehicle start-ups as long as the malfunction exists. When the malfunction indicator is illuminated, the system may not be able to detect or signal low tire pressure as intended. TPMS malfunctions may occur for a variety of reasons, including the installation of incompatible replacement or alternate tires or wheels on the vehicle that prevent the TPMS from functioning properly. Always check the TPMS malfunction telltale after replacing one or more tires or wheels on your vehicle to ensure that the replacement or alternate tires and wheels allow the TPMS to continue to function properly.

Lamp in center console

Problem



The passenger front air bag off indicator lamp illuminates and remains illuminated with the weight of a typical adult or someone larger than a small individual on the passenger seat.

Possible causes/consequences and ► Solutions

The system is malfunctioning.

- Have the system checked as soon as possible at an authorized Mercedes-Benz Center.
- Read and observe messages in the multifunction display and follow corrective steps (► page 226).

Warning!

If the  indicator lamp illuminates and remains illuminated with the weight of a typical adult or someone larger than a small

individual on the passenger seat, do not have any passenger use the passenger seat until the system has been repaired.

Problem	Possible causes/consequences and ► Solutions
 <p>The passenger front air bag off indicator lamp does not illuminate and/or does not remain illuminated with the weight of a typical 12-month-old child in a standard child restraint or less on the passenger seat.</p>	<p>The system is malfunctioning.</p> <ul style="list-style-type: none"> ► Make sure there is nothing between seat cushion and child seat and check installation of the child seat. ► Make sure no objects applying supplemental weight onto the seat are present. ► If the passenger front air bag off indicator lamp remains out, have the system checked as soon as possible at an authorized Mercedes-Benz Center. Do not transport a child on the passenger seat until the system has been repaired. ► Read and observe messages in the multifunction display and follow corrective steps (► page 226).

Warning!

If the  indicator lamp does not illuminate or remains out with the weight of a typical 12-month-old child in a standard child restraint or less on the passenger seat, do not transport a child on the passenger seat until the system has been repaired.

Unlocking/locking manually

Unlocking the vehicle

If you cannot unlock the vehicle with the SmartKey or with KEYLESS-GO, unlock the driver's door and the trunk using the mechanical key.

The anti-theft alarm system will trigger when you

- unlock the driver's door or the trunk with the mechanical key and
- open the driver's door or the trunk

To cancel the alarm, insert the SmartKey into the starter switch.

Removing the mechanical key

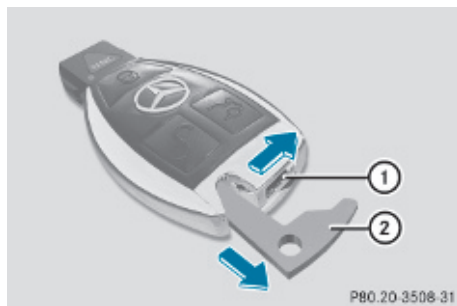

SmartKey

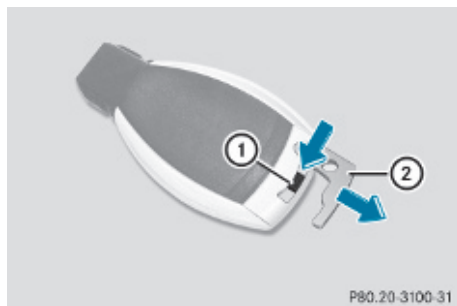

SmartKey with KEYLESS-GO

- Move locking tab ① in the direction of arrow.
- Slide mechanical key ② out of the housing.

Unlocking the driver's door

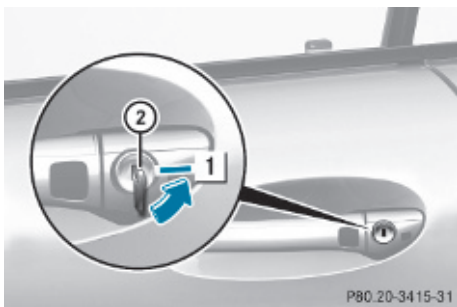

P80.20-3415-31

- ▶ Insert mechanical key ② into the driver's door lock.
- ▶ Turn mechanical key ② counterclockwise to position ① until the locking knob moves up. The driver's door is unlocked.
- ▶ Pull the door handle to open the driver's door.
- ▶ Turn mechanical key ② back and remove it from the driver's door lock.

Unlocking the trunk

A minimum height clearance of 6.2 ft (1.89 m) is required to open the trunk lid.

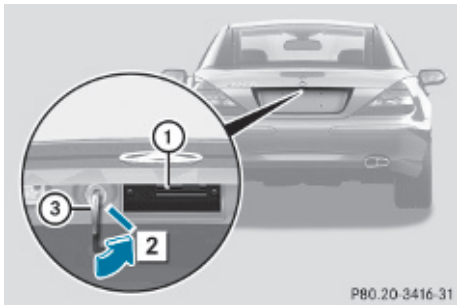

P80.20-3416-31

- ▶ Insert mechanical key ③ into the trunk lid lock.
- ▶ Turn mechanical key ③ counterclockwise to position ②.
- ▶ Pull handle ① and lift the trunk lid.

! When you open the trunk, the trunk lid swings open upwards. Always make sure there is sufficient overhead clearance.

- ▶ Turn mechanical key ③ back and remove it from the trunk lid lock.

Unlocking the glove box

Lockable storage areas in the passenger compartment include:

- the glove box
- the storage compartment under the armrest
- the rear storage compartments

If these cannot be unlocked by means of the SmartKey, use the mechanical key to unlock the glove box.

- i** To unlock the remaining storage compartments, the cause for the malfunction of the SmartKey must be determined and corrected, see (> page 68).

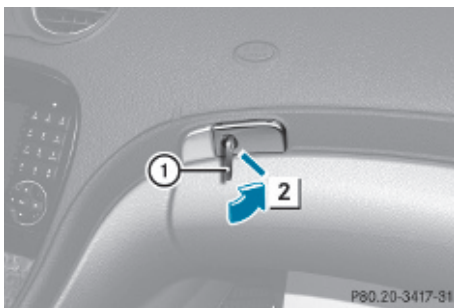

P80.20-3417-31

- ▶ Insert mechanical key ① into the glove box lock.
- ▶ Turn mechanical key ① counterclockwise to position ②. You can now open the glove box.
- i** Unlocking the glove box with the mechanical key will trigger the anti-theft alarm system. To cancel the alarm, insert the SmartKey in the starter switch.

Locking the vehicle

If you cannot lock the vehicle with the SmartKey or with KEYLESS-GO, lock it as follows:

- ▶ Open the driver's door.
- ▶ Close the passenger door and the trunk.
- ▶ Press the central locking switch (▷ page 73).
- ▶ Check to see whether the locking knob on the passenger door has moved down.
- ▶ If necessary, push it down manually.
- ▶ Exit the vehicle and close the driver's door.
- ▶ Remove the mechanical key from the SmartKey (▷ page 267).
- ▶ Check whether the trunk is locked.
- ▶ If it is not locked, lock it with the mechanical key (▷ page 77).
Except for the driver's door, the vehicle should now be locked.

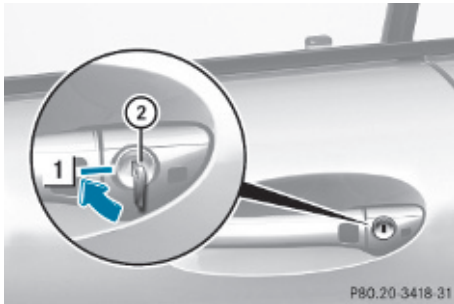

- ▶ Insert mechanical key ② into the driver's door lock.
- ▶ Turn mechanical key ② clockwise to position ①.
The driver's door is locked.
- ▶ Turn mechanical key ② back and remove it from the driver's door lock.

i This procedure does not arm the anti-theft alarm system, nor does it lock the fuel filler flap and the storage compartments. The storage compartments can be locked separately (▷ page 161).

Lowering the load assist manually

If the load assist feature does not fully lower the retractable hardtop into the trunk compartment and you are unable to close the trunk lid, follow the instructions below.

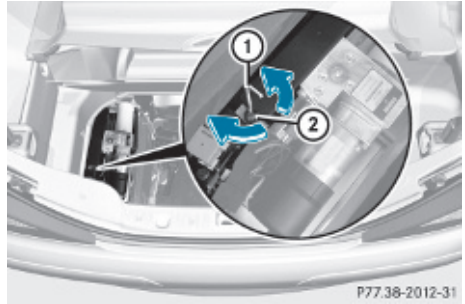

- ▶ Open the trunk (▷ page 73).
- ▶ Remove the trunk floor from the trunk.
- ▶ Have a second person lift and hold the retracted hardtop.
- ▶ Take the hex-socket wrench from the vehicle tool kit (▷ page 224).
- ▶ Using hex-socket wrench ①, carefully turn locking screw ② approximately one quarter of a turn counterclockwise.
- ▶ Hook luggage cover into holders (▷ page 159).
- ▶ Let go of the hardtop.
It should gradually lower into the trunk.
- ▶ When hardtop is completely lowered, return locking screw ② clockwise to its original position.
- ▶ **!** Do not overtighten the screw.
- ▶ Replace the trunk floor.
- ▶ Close the trunk.
- ▶ Contact an authorized Mercedes-Benz Center as soon as possible.

Replacing SmartKey batteries

If the batteries in the SmartKey are discharged, the vehicle can no longer be

locked or unlocked. It is recommended to have the batteries replaced at an authorized Mercedes-Benz Center.

Warning!

Batteries contain poisonous and corrosive substances. Therefore, keep the batteries out of reach of children.

If a battery is swallowed, seek medical help immediately.

Warning!

SmartKey batteries contain perchlorate material, which may require special handling and regard for the environment. Check with your local government's disposal guidelines. California residents, see www.dtsc.ca.gov/HazardousWaste/Perchlorate/index.cfm.

Batteries contain materials that can harm the environment if disposed of improperly. Recycling of batteries is the preferred method of disposal. Many states (USA only) or provinces (Canada only) require sellers of batteries to accept old batteries for recycling. When inserting the batteries, make sure they are clean and free of lint.

When replacing batteries, always replace both batteries.

-  The required replacement batteries are available at any authorized Mercedes-Benz Center.

Replacement batteries: Lithium, type CR 2025 or equivalent.

- ▶ Remove the mechanical key from the SmartKey (▶ page 267).

SmartKey

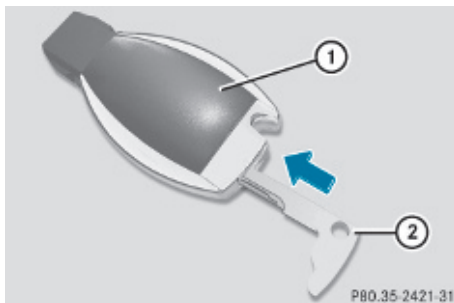

- ▶ Press mechanical key ② into the SmartKey opening until battery compartment cover ① opens. Do not keep the cover shut.

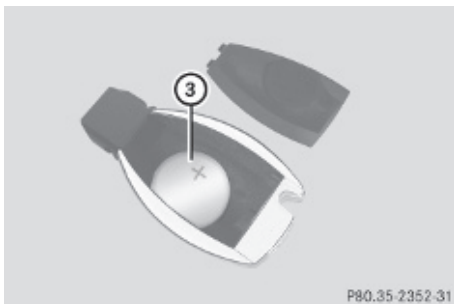

- ▶ Remove the battery compartment cover.
- ▶ Pat the SmartKey against the palm of your hand until battery ③ falls out.
- ▶ Insert the new battery with the positive terminal (+) facing up. Use a lint-free cloth.
- ▶ Insert the tabs of the battery compartment cover into the housing and press the cover closed.
- ▶ Slide mechanical key ① back into the SmartKey.
- ▶ Check the operation of the SmartKey.

SmartKey with KEYLESS-GO

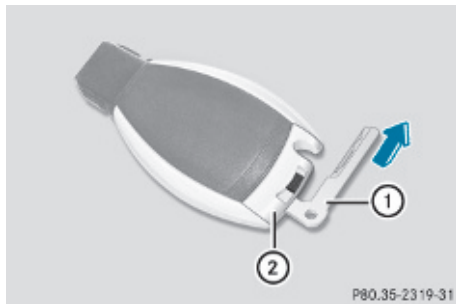

- ▶ Insert mechanical key ① into opening.
- ▶ Press mechanical key ① in direction of arrow. Battery compartment ② is unlatched.
- ▶ Pull battery compartment ② out of the SmartKey housing.

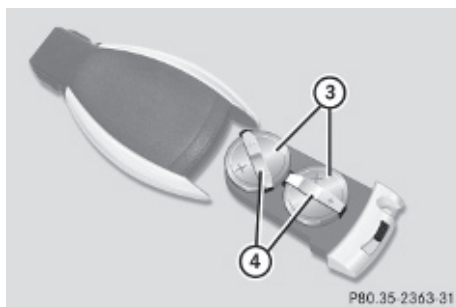

- ▶ Pull out batteries ③.
- ▶ Insert new batteries ③ under contact springs ④ with the positive terminal (+) side facing up.
- ▶ Return battery compartment ② into SmartKey housing until it locks into place.
- ▶ Slide mechanical key ① back into the SmartKey.
- ▶ Check the operation of the SmartKey as well as the KEYLESS-GO function.

Replacing bulbs

Safety notes

Safe vehicle operation depends on proper exterior lighting and signaling to a large degree.

Correct headlamp adjustment is extremely important. Have headlamps checked and readjusted at regular intervals and when a bulb has been replaced. Contact an authorized Mercedes-Benz Center for headlamp adjustment.

⚠ Warning!

Bulbs and bulb sockets can be very hot. Allow the lamp to cool down before changing a bulb. Keep bulbs out of reach of children.

Halogen lamps contain pressurized gas. A bulb can explode if you

- touch or move it when hot
- drop the bulb
- scratch the bulb

Wear eye and hand protection.

Because of high voltage in Xenon lamps, it is dangerous to replace the bulb or repair the lamp and its components. We recommend that you have such work done by a qualified technician.

- i** Since replacing bulbs is a technically highly demanding process, we recommend to have them replaced at an authorized Mercedes-Benz Center.
- i** If the headlamps or front fog lamps are fogged up on the inside as a result of high humidity, driving the vehicle a distance with the lights on should clear up the fogging.

Bulbs

You can replace the following bulbs yourself:

Bi-Xenon headlamps

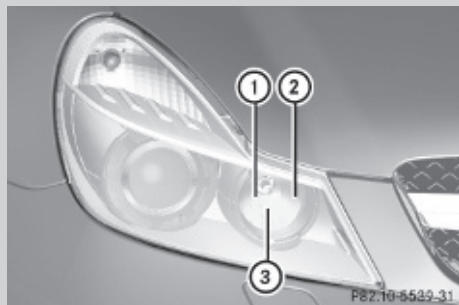

Type

- ① High-beam flasher lamp: H7 55 W
- ② Corner-illuminating lamp: H7 55 W
- ③ Parking and standing lamp: W 5 W

Rear lamps

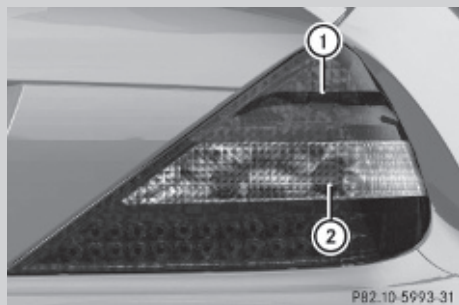

Type

- ① Turn signal lamp: PY 21 W
- ② Backup lamp: P 21 W

License plate lamps

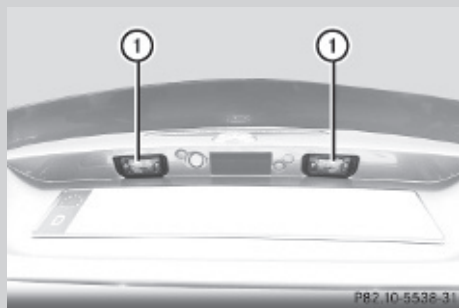

Type

- ① License plate lamps: C 5 W

Notes on bulb replacement

! Do not replace LEDs or bulbs not described in this section. You could otherwise damage the LEDs, the bulbs or parts of the vehicle. Only have the LEDs and

bulbs replaced at an authorized Mercedes-Benz Center.

⚠ Observe Safety notes, see page 271.

- Only use 12-volt bulbs of the same type and with the specified watt rating.
- Switch the lights off before changing a bulb to prevent short circuits.
- Always use a clean lint-free cloth when handling bulbs.
- Your hands should be dry and free of oil and grease.
- If the newly installed bulb does not come on, contact an authorized Mercedes-Benz Center.

i Mercedes-Benz recommends using Longlife (LL) bulbs.

Replacing bulbs for front lamps

⚠ Warning!

Do not remove the cover for the Bi-Xenon headlamp. Because of high voltage in Xenon lamps, it is dangerous to replace the bulb or repair the lamp and its components. It is recommended to have such work done by a qualified technician.

Before you start to replace a bulb for a front lamp, do the following:

- ▶ Switch off the ignition.
- ▶ Turn the exterior lamp switch to position **0**.
- ▶ Open the hood (▶ page 180).

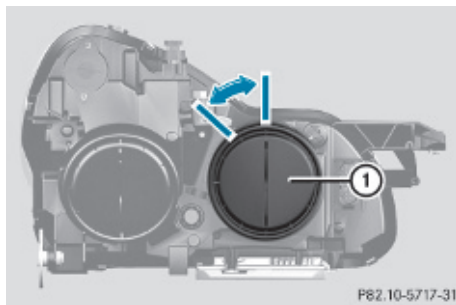

P82.10-5717-31

- ① Housing cover for high-beam headlamp, parking and standing lamp, corner-illuminating lamp

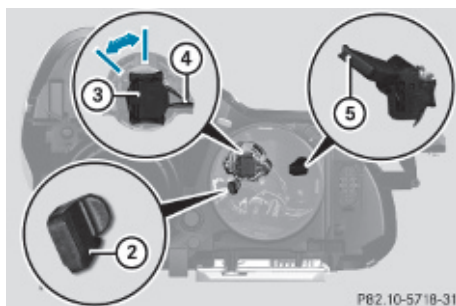

P82.10-5718-31

- ② Bulb socket for parking and standing lamp bulb
- ③ Bulb socket for high-beam bulb
- ④ Cable outlet for high-beam bulb
- ⑤ Bulb socket for corner-illuminating lamp bulb

High-beam and high-beam flasher bulb

- ▶ Turn housing cover ① counterclockwise and remove it.
- ▶ Pull out bulb socket ②.
- ▶ Turn bulb socket ③ with the bulb counterclockwise and remove it.
- ▶ Pull the bulb out of bulb socket ③.
- ▶ Gently press the new bulb into bulb socket ③.
- ▶ Insert bulb socket ③ into the guide in the headlamp.

- ▶ Turn bulb socket ③ clockwise until it engages.
Driver's side headlamp: Cable outlet ④ of bulb socket ③ must point towards the lower right.
Passenger-side headlamp: Cable outlet ④ of bulb socket ③ must point towards the lower left.
- ▶ Place bulb socket ② back into the housing.
- ▶ Align housing cover ① and turn it clockwise until it engages.

Parking and standing lamp bulb

- ▶ Turn housing cover ① counterclockwise and remove it.
- ▶ Pull out bulb socket ②.
- ▶ Pull the bulb out of bulb socket ②.
- ▶ Gently press the new bulb into bulb socket ②.
- ▶ Place bulb socket ② back into the housing.
- ▶ Align housing cover ① and turn it clockwise until it engages.

Corner-illuminating lamp bulbs

- ▶ Turn housing cover ① counterclockwise and remove it.
- ▶ Turn bulb socket ⑤ counterclockwise and remove it.
- ▶ Pull the bulb out of bulb socket ⑤.
- ▶ Gently press the new bulb into bulb socket ⑤.
- ▶ Insert bulb socket ⑤ into the guide in the headlamp.
- ▶ Turn bulb socket ⑤ clockwise until it engages.
 The handle of the bulb socket must be vertical.
- ▶ Align housing cover ① and turn it clockwise until it engages.

Replacing bulbs for rear lamps

Before you start to replace a bulb for a rear lamp, do the following:

- ▶ Switch off the ignition.
- ▶ Turn the exterior lamp switch to position **0**.
- ▶ Open the trunk.

Tail lamp unit

Opening the driver's side trim panel

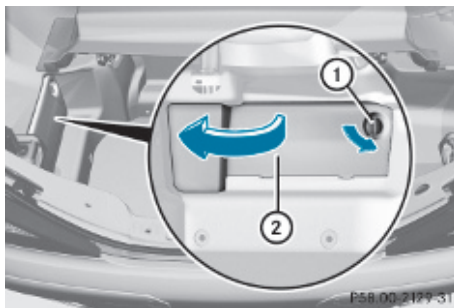

- ▶ Turn lock ① counterclockwise by 90°.
- ▶ Remove cover ②.

Opening the passenger-side trim panel

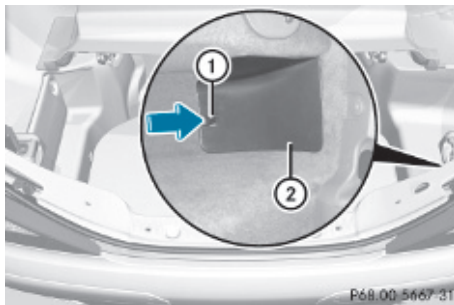

- ▶ Move lock ① in direction of the arrow and remove cover ②.

Replacing bulbs

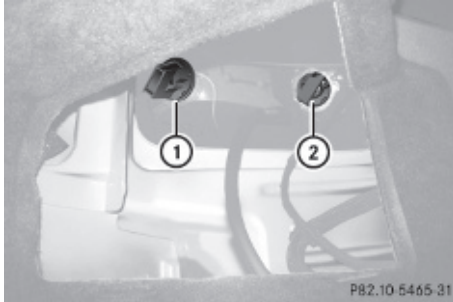

Example illustration: Bulb socket passenger side

- ① Turn signal lamp
- ② Backup lamp

- i** The lamps on the driver's side are mirrored.
- ▶ Depending on which bulb needs to be replaced, turn the respective bulb socket counterclockwise and remove it.
- ▶ Gently press onto the bulb and turn it clockwise out of its bulb socket.
- ▶ Gently press the new bulb into its bulb socket and turn it counterclockwise until it engages.
- ▶ Align the respective bulb socket and press it into the tail lamp unit until it audibly engages.
- ▶ Reinstall the trim.

License plate lamps

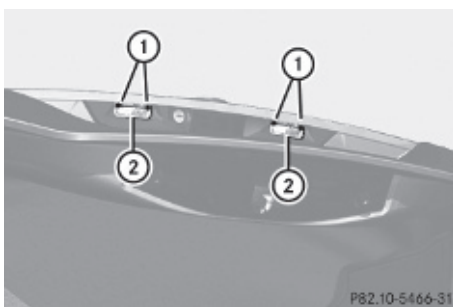

- ▶ Loosen screws ① of lamp cover to be removed.
- ▶ Remove lamp cover ②.
- ▶ Replace the bulb.
- ▶ Reinstall lamp cover ②.
- ▶ Retighten screws ①.

Replacing wiper blades

Safety notes

⚠ Warning!

For safety reasons, switch off the wipers and remove the SmartKey from the starter switch (vehicles with KEYLESS-GO: Make sure the vehicle's on-board electronics have status **0**) before replacing a wiper blade. Otherwise, the wiper motor could suddenly turn on and cause injury.

⚠ Warning!

Wiper blades are components that are subject to wear and tear. Replace the wiper blades twice a year, preferably in the spring and fall. Otherwise the windshield will not be wiped properly. As a result, you may not be able to observe surrounding traffic conditions and could cause an accident.

- !** To avoid damage to the hood, the wiper arms should only be folded forward when in the vertical position.
- !** Never open the hood when a wiper arm is folded forward.
 - Hold on to the wiper when folding a wiper arm back. If released, the force of the impact from the tensioning spring could crack the windshield.
 - Do not allow a wiper arm to contact the windshield glass without a wiper blade inserted.
 - Mercedes-Benz recommends that you have this work carried out at an authorized Mercedes-Benz Center.

Placing wiper arms in vertical position



Wiper arms in vertical position

- ▶ Make sure the hood is fully closed.

Vehicles with SmartKey

- ▶ Turn the SmartKey in the starter switch to position **1**.
- ▶ Turn the combination switch to wiper setting **II**.
- ▶ With wiper arms in vertical position, turn the SmartKey in the starter switch to position **0**.
- ▶ Remove the SmartKey from the starter switch.

Vehicles with KEYLESS-GO

- ▶ Turn off the engine.
With the driver's door closed, the starter switch is now in position **1**.
- ▶ Turn the combination switch to wiper setting **II**.
- ▶ With wiper arms in vertical position, open the driver's door.
The starter switch is set to position **0**, same as the SmartKey removed from the starter switch.
- ▶ Turn the combination switch to wiper setting **0**.

Removing wiper blades

- ❗ Do not pull on the wiper blade inserts. They could tear.
- ▶ Fold the wiper arm forward until it snaps into place.



- ▶ Turn the wiper blade at a right angle to wiper arm.
- ▶ Slide the wiper blade sideways out of the retainer.

Installing wiper blades

- ▶ Slide the wiper blade onto the wiper arm in opposite direction of arrow (▶ page 276).
- ▶ Rotate the wiper blade into a position parallel to the wiper arm.
- ▶ Fold the wiper arm backward to rest on the windshield.
Make sure you hold on to the wiper when folding the wiper arm back.

- ❗ Make sure the wiper blades are installed properly. Improperly installed wiper blades may cause windshield damage.

Flat tire

Safety notes

⚠ Warning!

The dimensions of the spare wheel are different from those of the road wheels. As a result, the vehicle handling characteristics

change when driving with a spare wheel mounted. Adapt your driving style accordingly.

The spare wheel is for temporary use only. When driving with a spare wheel mounted, ensure proper tire inflation pressure and do not exceed a vehicle speed of 50 mph (80 km/h).

Contact the nearest authorized Mercedes-Benz Center as soon as possible to have the spare wheel replaced with a regular road wheel.

Never operate the vehicle with more than one spare wheel mounted.

Do not switch off the ESP® when a spare wheel is mounted.

Preparing the vehicle

- ▶ Whenever possible, park the vehicle in a safe distance from moving traffic on a hard, flat surface.
- ▶ Turn on the hazard warning flasher.
- ▶ Turn the steering wheel so that the front wheels are in a straight-ahead position.
- ▶ Engage the parking brake.
- ▶ Shift the automatic transmission into park position **P**.
- ▶ Turn off the engine.
- ▶ Remove the SmartKey from the starter switch.

or

- ▶ Vehicles with KEYLESS-GO: Open the driver's door (this puts the starter switch in position **0**, same as with the SmartKey removed from the starter switch). The driver's door can then be closed again. Open doors only when conditions are safe to do so.
- ▶ Have any passenger exit the vehicle at a safe distance from the roadway. Open doors only when conditions are safe to do so.

Mounting the spare wheel

Introduction

- ▶ Prepare the vehicle as described (▷ page 277).
- ▶ Take the following out of the vehicle:
 - spare wheel
 - jack
 - vehicle tool kit
 - wheel wrench
 - electric air pump

For information on where to find the respective items, see "Where will I find ...?" (▷ page 224) and (▷ page 225).

i Vehicles without spare wheel are not factory-equipped with the tools required for a wheel change such as a jack or a wheel wrench. Some tools required for a wheel change are specific to your vehicle. Contact an authorized Mercedes-Benz Center to obtain the tools approved for your vehicle. This section describes the wheel change using the tools approved and recommended for your vehicle.

Removing tensioning straps from spare wheel

This description applies to vehicles with 19" spare wheel with collapsible tire only.

A 19" spare wheel with collapsible tire has two tensioning straps on it that must be removed before mounting the spare wheel.

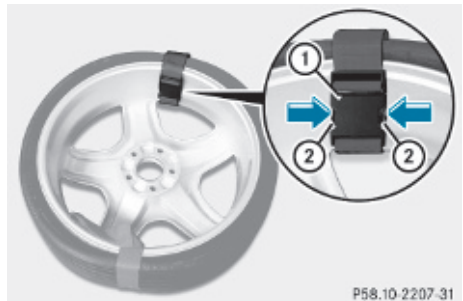

P58.10 2207-31

- ▶ Press on both clips ② simultaneously to release buckle ①.
- ▶ Store the tensioning straps in a safe place. You will need them to store the spare wheel in the trunk after use (▶ page 225).

Lifting the vehicle

⚠ Warning!

When jacking up the vehicle, only use the jack which has been specifically approved by Mercedes-Benz for your vehicle.

The jack is designed exclusively for jacking up the vehicle at the jack tubes built into both sides of the vehicle. Make sure the jack arm is fully inserted in the jack tube. The jack must always be vertical when in use, especially on inclines or declines.

The jack is intended only for lifting the vehicle briefly for wheel changes. It is not suited for performing maintenance work under the vehicle. To help avoid personal injury, use the jack only to lift the vehicle during a wheel change.

Never get beneath the vehicle while it is supported by the jack. Keep hands and feet away from the area under the lifted vehicle. Always lower the vehicle onto sufficient capacity jackstands before working under the vehicle.

Always engage the parking brake firmly and block the wheels with wheel chocks or other sizeable objects before raising the vehicle with the jack. Do not disengage the parking brake while the vehicle is raised.

Make sure that the ground on which the vehicle is standing and where you place the jack is solid, level and not slippery. If necessary, use a large underlay. On slippery surfaces, such as tiled floors, you should use a non-slip underlay, for example a rubber mat. Do not use wooden blocks or similar objects to support the jack. Otherwise the jack may not be able to achieve its load-bearing capacity if it is not at its full height.

Never start the engine when the vehicle is raised.

Also observe the notes on the jack.

- ▶ Prevent the vehicle from rolling away by blocking wheels with wheel chocks (not included) or other sizeable objects.

When changing a wheel on a level surface:

- ▶ Place a wheel chock or other sizeable object in front of and another wheel chock or other sizeable object behind the wheel that is diagonally opposite to the wheel being changed.

Always try lifting the vehicle using the jack on a level surface. However, should circumstances require you to do so on a hill:

- ▶ Place wheel chocks or other sizeable objects on the downhill side in front of both wheels on the side opposite to the side on which the wheel is to be changed.

⚠ Warning!

Only jack up the vehicle on level ground or on slight inclines/declines. Otherwise, the vehicle could fall off the jack and injure you or others.

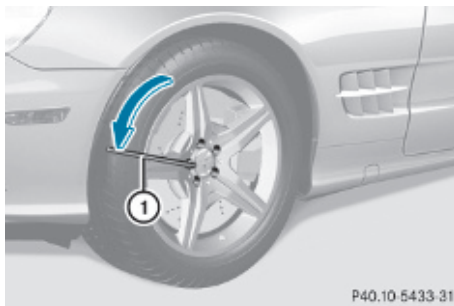

- ▶ On the wheel to be changed, loosen but do not yet remove the wheel bolts (approximately one full turn with wheel wrench ①).

The jack support tubes are located directly behind the front wheel housings and in front of the rear wheel housings.

Warning!

When turning the wheel wrench to loosen the wheel bolts, make sure you position your hands on the wrench in such a way that you avoid injury to yourself, such as scraping your hands against the wheel. Make sure turning the wheel wrench will not scratch or damage the wheel rim.

- ❗ Do not position the jack on the body of the vehicle, as this may cause damage to the vehicle.

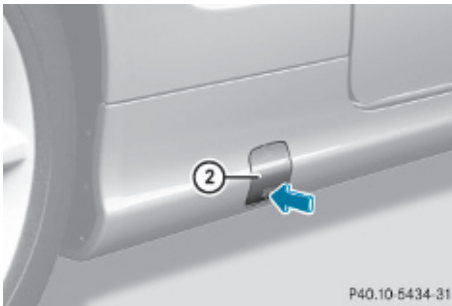

P40.10 5434 31

Jack support tube cover (except SL 63 AMG, SL 65 AMG, and vehicles with Sport Package)

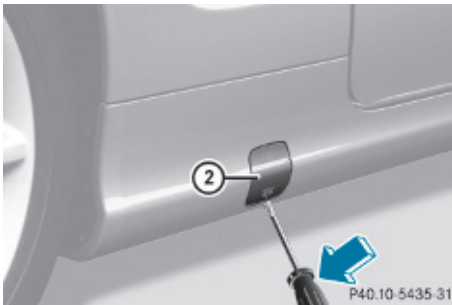

P40.10 5435 31

Jack support tube cover (SL 63 AMG, SL 65 AMG, and vehicles with Sport Package only)

- ▶ Open cover ② by pressing at point indicated by arrow.
- or
- ▶ Insert a flat blade screwdriver in the opening of cover ② and pry it out.

- ▶ Remove cover ②, taking care not to damage the locking tabs.

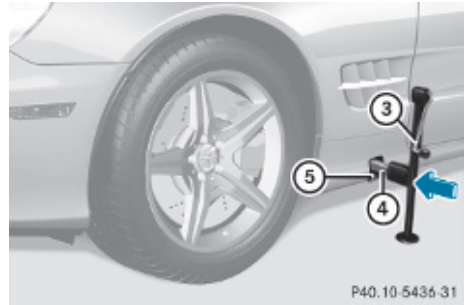

P40.10 5436 31

- ▶ Insert jack arm ④ fully into jack support tube hole ⑤ up to the stop.

Warning!

Insert the jack fully into the jack support tube hole up to the stop. Otherwise, the vehicle may fall from the jack and cause personal injury or damage to the vehicle.

- ▶ Keeping jack in this position, turn crank ③ clockwise until the jack base meets the ground. Make sure the jack is vertical.
- ▶ Jack up the vehicle until the wheel is a maximum of 1.2 in (3 cm) from the ground.

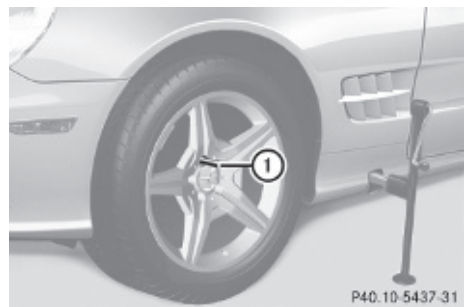
Removing the wheel

P40.10 5437 31

- ▶ Unscrew the uppermost wheel bolt and remove it.
- ▶ Replace this wheel bolt with alignment bolt ①.
- ▶ Remove the remaining bolts.

! Do not place wheel bolts in sand or dirt. This could result in damage to the wheel bolts and wheel hub threads.

► Remove the wheel.

Attaching the spare wheel

Warning!

Inflate collapsible tire only after the wheel is properly attached.

Inflate the collapsible tire using the electric air pump before lowering the vehicle.

Warning!

Always replace wheel bolts that are damaged or rusted.

Never apply oil or grease to wheel bolts.

Damaged wheel hub threads should be repaired immediately. Do not continue to drive under these circumstances! Contact an authorized Mercedes-Benz Center or call Roadside Assistance.

Incorrect wheel bolts or improperly tightened wheel bolts can cause the wheel to come off. This could cause an accident. Make sure to use the correct wheel bolts.

Warning!

Only use genuine Mercedes-Benz wheel bolts. Other wheel bolts may come loose.

Do not tighten the wheel bolts when the vehicle is raised. Otherwise the vehicle could fall off the jack.

► Clean contact surfaces of wheel and wheel hub.

! To avoid paint damage, place wheel flat against hub and hold it there while installing first wheel bolt.

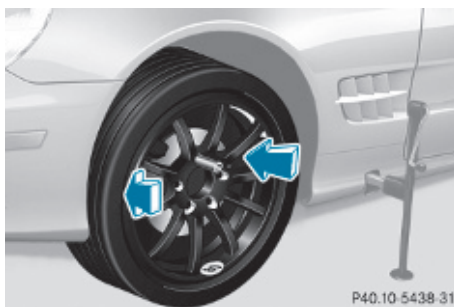

- Guide the spare wheel onto the alignment bolt and push it on.
- Insert the wheel bolts and tighten them slightly.
- Unscrew the alignment bolt.
- Install the last wheel bolt and tighten it slightly.
- Inflate the collapsible tire (► page 280).

Inflating the collapsible tire

Warning!

Inflate collapsible tire only after the wheel is properly attached.

Inflate the collapsible tire using the electric air pump before lowering the vehicle.

Warning!

Observe safety instructions on air pump label.

! Do not lower the vehicle before inflating the collapsible tire. Otherwise the rim may be damaged.

Your vehicle may be equipped with either of two versions of the electric air pump:

- **Version 1:** The air hose with pressure gauge and the electrical plug are located behind a flap.
- **Version 2:** The pressure gauge is located in the pump housing. The air hose and electrical plug are located at the bottom of the pump housing.

The following description applies to both versions. Differences in usage are expressly declared.

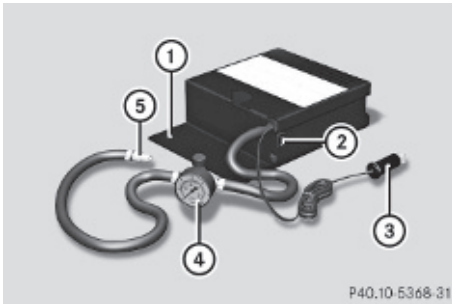

Version 1

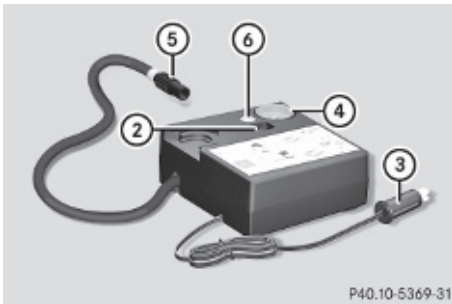

Version 2

- ▶ **Version 1 only:** Open flap ① on electric air pump.
- ▶ **Version 1 only:** Pull out electrical plug ③ and air hose with pressure gauge and vent screw ④.
- ▶ **Version 2 only:** Pull electrical plug ③ and the air hose out of the pump housing bottom.
- ▶ **Version 1 only:** Close vent screw on air hose ④.
- ▶ Remove the valve cap from the collapsible tire valve.
- ▶ Screw union nut ⑤ onto the collapsible tire valve.
- ▶ Make sure air pump switch ② is set to 0.
- ▶ Insert electrical plug ③ into the cigarette lighter socket (▷ page 166) or a power outlet (▷ page 166).

- ▶ Turn the SmartKey in the starter switch to position 1.
- or
- ▶ Vehicles with KEYLESS-GO: Press the KEYLESS-GO start/stop button once. Do not depress the brake pedal.
- ▶ Press I on electric air pump switch ②. The electric air pump switches on and inflates the collapsible tire.
- ▶ Inflate the collapsible tire to the recommended tire inflation pressure as specified for your vehicle (▷ page 303). This should take approximately 5 minutes.

⚠ Warning!

The air hose and the union nut can become hot during inflation. Exercise proper caution to avoid burning yourself when using the equipment.

- ❗ Do not operate the electric air pump longer than 8 minutes without interruption. Otherwise it may overheat. You may operate the air pump again after it has cooled off.

- ❗ Compare the recommended tire inflation pressure for your vehicle with the tire inflation pressure on the yellow label located on the spare wheel rim. If the tire inflation pressure on the yellow label on the spare wheel rim differs from the values given in this Operator's Manual, inflate the tire to the recommended tire inflation pressure given on the yellow label on the spare wheel rim.

- ▶ Press 0 on electric air pump switch ②.
- ▶ Turn the SmartKey in the starter switch to position 0.
- or
- ▶ Vehicles with KEYLESS-GO: Press the KEYLESS-GO start/stop button twice. Do not depress the brake pedal.
- ▶ **Version 1 only:** If the tire inflation pressure is above the recommended tire inflation

pressure as specified for your vehicle (▷ page 303), decrease tire pressure using the vent screw on air hose ④.

- ▶ **Version 2 only:** If the tire inflation pressure is above the recommended tire inflation pressure as specified for your vehicle (▷ page 303), decrease tire pressure using deflate button ⑥.

Observe Safety notes, see page 189.

- ▶ Detach the electric air pump.
- ▶ Reinstall collapsible tire valve cap.
- ▶ **Version 1 only:** Store electrical plug ③ and air hose ④ behind flap ①.
- ▶ **Version 2 only:** Store electrical plug ③ and the air hose back into the pump housing bottom.
- ▶ Place the electric air pump back in its designated storage space.
- ▶ Lower the vehicle.

Lowering the vehicle

Warning!

Inflate collapsible tire only after the wheel is properly attached.

Inflate the collapsible tire using the electric air pump before lowering the vehicle.

- ▶ Lower the vehicle by turning the crank counterclockwise until the vehicle is resting fully on its own weight.
- ▶ Pull the jack out of the jack support tube.

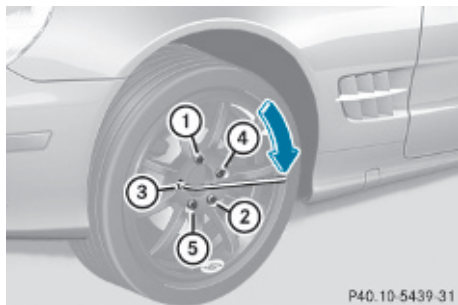

P40.10.5439.31

- ▶ Tighten the five wheel bolts evenly, following the diagonal sequence illustrated (① to ⑤), until all bolts are tight. Observe a tightening torque of 96 lb-ft (130 Nm).

Warning!

Have the tightening torque checked after changing a wheel. The wheels could come loose if they are not tightened to a torque of 96 lb-ft (130 Nm).

Warning!

When turning the wheel wrench to tighten the wheel bolts, make sure you position your hands on the wrench in such a way that you avoid injury to yourself, such as scraping your hands against the wheel. Make sure turning the wheel wrench will not scratch or damage the wheel rim.

- ▶ Before storing the jack in the trunk, crank back to storage position and fold in the jack arm.
- ▶ Store the jack and the other vehicle tools in the designated storage space.

For information on storing the spare wheel after it has been replaced by a regular road wheel, see (▷ page 225).

- i** The flat tire may be transported in the trunk when the retractable hardtop is closed. If available use a protective wrap on the spare wheel.
- i** Do not restart the tire inflation pressure monitor until a full size wheel/tire with functioning sensor has been placed back into service on the vehicle.

- ▶ Do not exceed the maximum speed of 50 mph (80 km/h).

Replacing jack support tube cover

- ▶ Slide tongue of cover under the upper edge of the tube opening.
- ▶ Applying even pressure, press cover until it snaps into place.

Be careful not to damage the locking tabs or clamp the plastic retaining strap.

MOExtended system

The MOExtended system allows you to continue driving your vehicle even if there is a total loss of pressure in one or more tires.

You may only use the MOExtended system in conjunction with the Advanced TPMS (▷ page 190).

The maximum distance in emergency mode depends on the vehicle's load. It is 50 miles (80 km) if the vehicle is partially loaded and 18 miles (30 km) if the vehicle is fully loaded. The point at which the maximum driving distance in emergency mode begins is when the warning message appears in the multifunction display indicating that there is a loss of tire inflation pressure.

- ▶ Do not exceed the maximum speed of 50 mph (80 km/h).

Warning!

In emergency mode, your vehicle's driving characteristics are diminished in such situations as:

- driving around curves
- while braking
- while accelerating rapidly

Therefore, your driving style must be adapted accordingly. Avoid abrupt steering and driving maneuvers, as well as driving over obstacles (road curbs, potholes, or off-road areas). This is especially important if the vehicle is heavily loaded.

The emergency driving distance that can be achieved greatly depends on the demands placed on the vehicle. Depending on speed, load, driving maneuvers, road conditions, outside temperature, etc., the distance can be significantly shorter or, if the vehicle is driven cautiously, somewhat longer.

Do not continue driving in emergency mode if

- you notice knocking sounds
- the vehicle starts to shake
- smoke develops and you smell rubber
- ESP® is intervening continuously
- you notice tears on the tire sidewalls

After driving in emergency mode, you must have the rims inspected by an authorized Mercedes-Benz Center to check if they are suitable for further use. The failed tire must be replaced in any case.

When replacing individual or all tires on the vehicle, make sure only tires marked with "MOExtended" are mounted in the size specified for your vehicle (▷ page 299).

Battery

Safety notes

These batteries should always be sufficiently charged in order to achieve their rated service life. Refer to Maintenance Booklet for battery maintenance intervals.

If you use your vehicle mostly for short-distance trips, you will need to have the battery charge checked more frequently.

When replacing a battery, always use a battery approved by Mercedes-Benz.

If you do not intend to operate your vehicle for an extended period of time, contact an authorized Mercedes-Benz Center about steps you need to observe.

Warning!

Observe all safety instructions and precautions when handling automotive batteries.



Risk of explosion.



Fire, open flames and smoking are prohibited when handling batteries. Avoid creating sparks.



Battery acid is caustic. Do not allow it to come into contact with skin, eyes or clothing.

Wear suitable protective clothing, especially gloves, apron and faceguard.



Wear eye protection. Rinse any acid spills immediately with clear water. Contact a physician if necessary.



Keep children away.



Follow the instructions in this Operator's Manual.

A battery contains materials that can harm the environment if disposed of improperly. A large 12 V storage battery contains lead. Recycling of the battery is the preferred method of disposal. Many states (USA only) or provinces (Canada only) require sellers of batteries to accept the old battery for recycling.

Warning!

Failure to follow these instructions can result in severe injury or death.

Never lean over batteries while connecting. You might get injured.

Battery fluid contains sulfuric acid. Do not allow this fluid to come in contact with eyes, skin or clothing. In case it does, immediately

flush affected area with water and seek medical help if necessary.

A battery will also produce hydrogen gas, which is flammable and explosive. Keep flames or sparks away from battery, avoid improper connection of jumper cables, smoking etc.

Warning!

Do not place metal objects on the battery as this could result in a short circuit.

Use leak-proof batteries only to avoid the risk of acid burns in the event of an accident.

Take care that you do not become statically charged, e.g. by wearing synthetic clothing or rubbing against textiles. For this reason, you also should not pull or push the battery over carpets or other synthetic materials.

Never touch the battery first. First touch the outside body of the vehicle in order to release any possible electrostatic charges.

Do not rub the battery with rags or cloths. The battery could explode if touched due to electrostatic charge or due to spark formation.

! The battery is a Valve-Regulated Lead Acid (VRLA) battery, also referred to as "fleece" battery.

Such batteries do not require topping-up of the electrolyte level. VRLA batteries therefore do not have cell caps and the battery cover is non-removable. Do not attempt to open the battery as otherwise the battery will be damaged.

VRLA batteries do not require topping-up of the electrolyte level. They cannot be opened to check the electrolyte level. However, the battery condition must be checked periodically by performing a battery conductance test. Refer to Maintenance Booklet for battery condition testing intervals.

The factory-equipped battery may only be replaced with a battery that

- has the same security features
- is of identical size
- is of identical voltage
- is of identical capacity

! As any other battery, the battery may discharge if you do not operate the vehicle for an extended period of time. Have the battery disconnected at a qualified workshop or an authorized Mercedes-Benz Center in such a case. You may also connect an accessory battery charge unit expressly approved by Mercedes-Benz for your vehicle model to maintain the battery charge. Contact an authorized Mercedes-Benz Center for further information.

The battery, the battery ventilation hose and the lateral plug must always be securely installed when the vehicle is in operation.

! Never loosen or detach battery terminal clamps while the engine is running or the SmartKey is in the starter switch or KEYLESS-GO button is in position **1**. Otherwise the alternator and other electronic components could be severely damaged.

Have the battery checked regularly at an authorized Mercedes-Benz Center.

Refer to Maintenance Booklet for maintenance intervals or contact an authorized Mercedes-Benz Center for further information.

i After battery power was interrupted, do the following:

- Synchronize the ESP® (▷ page 228).
- Synchronize the power windows (▷ page 98).

Charging the battery

Warning!

Never charge a battery while still installed in the vehicle unless the accessory battery charge unit approved by Mercedes-Benz is being used. Gases may escape during charging and could cause an explosion that may result in personal injury, paint damage or corrosion.

An accessory battery charge unit specially adapted for Mercedes-Benz vehicles and tested and approved by Mercedes-Benz is available. It permits the charging of the battery in its installed position. Contact an authorized Mercedes-Benz Center for information and availability.

Charge battery in accordance with the separate instructions for the accessory battery charger.

Have the battery charged at an authorized Mercedes-Benz Center. If you charge the battery yourself, follow the operating instructions for your charging device.

Only use a battery charge unit with a maximum charging voltage of 14.8 V.

- ▶ Charge battery in accordance with the instructions of the battery charger manufacturer.

Jump starting

Warning!

Failure to follow these directions will cause damage to the electronic components, and can lead to a battery explosion and severe injury or death.

Never lean over batteries while connecting or jump starting. You might get injured.

Battery fluid contains sulfuric acid. Do not allow this fluid to come in contact with eyes, skin or clothing. In case it does, immediately

flush affected area with water, and seek medical help if necessary.

A battery will also produce hydrogen gas, which is flammable and explosive. Keep flames or sparks away from battery, avoid improper connection of jumper cables, smoking, etc.

Attempting to jump start a frozen battery can result in it exploding, causing personal injury.

Read all instructions before proceeding.

! Do not tow-start the vehicle. You could otherwise seriously damage the automatic transmission which is not covered by the Mercedes-Benz Limited Warranty.

! Jump starting should only be performed on the starter battery installed in the engine compartment.

Avoid repeated and lengthy starting attempts.

Do not attempt to start the engine using a battery quick-charge unit.

If the engine does not run after several unsuccessful starting attempts, have it checked at the nearest authorized Mercedes-Benz Center.

Excessive unburned fuel generated by repeated failed starting attempts may damage the catalytic converter and may present a fire risk.

Make sure the jumper cables do not have loose or missing insulation.

Make sure the cable clamps do not touch any other metal part while the other end is still attached to a battery.

If the starter battery is discharged, the engine can be started with jumper cables and the fully charged battery of another vehicle or an equivalent starter pack. Observe the following:

- Access to the battery is not possible on all vehicles. If you cannot access the battery

of the other vehicle, provide jump start power by an external battery or starter pack.

- Jump starting should only be performed when the engine and catalytic converter are cold.
- Do not jump start the engine or charge the battery if the battery is frozen. Let the battery thaw out first.
- Only jump start from batteries with the same voltage rating (12 V). Jump starting with a more powerful battery could damage the vehicle's electrical system, which is not covered by the Mercedes-Benz Limited Warranty.
- Only use jumper cables with sufficient cross-section and insulated terminal clamps.
- Always make sure the jumper cables are not on or near pulleys, fans or other parts that move when an engine is started or running.
- Should the battery be drained completely, let the donating power source charge the vehicle for several minutes before reattempting the starting process.

Jump starting should only be performed on the starter battery. The starter battery is located in the engine compartment on the passenger side.

- ▶ Make sure the two vehicles do not touch.
- ▶ Switch off all electrical consumers.
- ▶ Engage the parking brake.
- ▶ Make sure the automatic transmission is in park position **P**.
- ▶ Open the hood (> page 180).

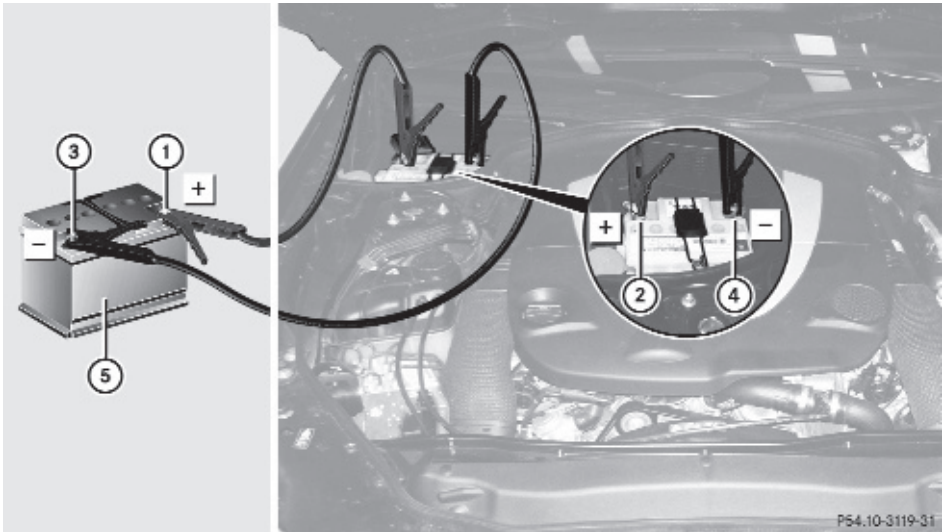

Position ⑤ represents the charged battery of another vehicle or an equivalent starter pack.

- ▶ Remove cover from battery positive terminal ②.

! Never invert the terminal connections!

- ▶ Connect positive terminal ① of charged battery ⑤ with positive terminal ② with a jumper cable. Clamp the cable to positive terminal ① of charged battery ⑤ first.
- ▶ Start engine of the vehicle with charged battery ⑤ and run at idle speed.
- ▶ Connect negative terminal ③ of charged battery ⑤ with negative terminal ④ with a jumper cable. Clamp the cable to negative terminal ③ of charged battery ⑤ first.
- ▶ Start engine of the vehicle with the discharged battery and run at idle speed. You can now turn on the electrical consumers. Do not switch on the headlamps under any circumstances.
- ▶ Remove the jumper cables from negative terminals ③ and ④ first.

- ▶ Remove the jumper cables from positive terminals ① and ②. You can now switch on the headlamps.
- ▶ Have the battery checked at the nearest authorized Mercedes-Benz Center.

Towing the vehicle

Safety notes

Mercedes-Benz recommends that the vehicle be transported with all wheels off the ground using flatbed or appropriate wheel lift/dolly equipment. This method is preferable to other types of towing.

- !** To prevent damage during transport, do not tie down vehicle by its chassis or suspension parts.

⚠ Warning!

The electro-hydraulic brake system requires electrical power to operate.

A malfunction in the vehicle's power supply or electrical system may impair brake system operation and switch it into its emergency operation mode. In such a case, the red brake

warning lamp comes on and warning messages appear in the multifunction display while driving. To brake, the driver must then apply significantly greater brake pedal pressure and depress the pedal much further to obtain the expected braking effect. If necessary, apply full pressure to the brake pedal. Brakes are only applied to the front wheels. Stopping distance is increased! For more information, see “Electro-hydraulic brake system” in this in this Operator’s Manual.

If there is a malfunction in the electro-hydraulic brake system, we recommend that the vehicle be transported with all wheels off the ground using flatbed or appropriate wheel lift/dolly equipment.

If circumstances do not permit the recommended towing methods, the vehicle may be towed with all wheels on the ground or one axle raised only so far as necessary to have the vehicle moved to a safe location where the recommended towing methods can be employed.

► Switch off the tow-away alarm before towing the vehicle with all wheels on the ground or one axle raised (▷ page 64).

❗ Before towing the vehicle observe the following instructions:

- Do not tow-start the vehicle. You could otherwise seriously damage the automatic transmission which is not covered by the Mercedes-Benz Limited Warranty.
- Do not tow with sling-type equipment. Towing with sling-type equipment over bumpy roads will damage radiator and supports.
- Towing of the vehicle should only be done using the properly installed towing eye bolt. Never attach a tow cable, tow rope or tow rod to the vehicle chassis, frame or suspension parts.

Warning!

With the engine not running, there is no power assistance for the brake and steering systems. In this case, it is important to keep in mind that a considerably higher degree of effort is necessary to brake and steer the vehicle. Adapt your driving accordingly.

❗ Avoid pulling the vehicle abruptly or diagonally, since it could result in damage to the chassis alignment.

❗ Do not use the towing eye bolt for recovery, as this could damage the vehicle. If in doubt, recover the vehicle with a crane.

i If the battery is disconnected or discharged

- the SmartKey will not turn in the starter switch
- the automatic transmission will remain in park position **P**

For more information see “Battery” (▷ page 283) or “Jump starting” (▷ page 285).

Installing towing eye bolt

Depending on whether you are towing a vehicle or you are being towed, the towing eye bolt can be screwed into threaded holes which are located behind covers on each bumper.

The towing eye bolt is supplied with the vehicle tool kit, located in the compartment underneath the trunk floor (▷ page 224).

► Take the vehicle tool kit out of the trunk.

Removing cover in front bumper

- Press mark on cover **①** as indicated by the arrow.
- Lift cover **①** off to reveal the threaded hole for the towing eye bolt.

USA only

- ▶ Press mark on cover ① as indicated by the arrow.
- ▶ Lift cover ① off to reveal the threaded hole for the towing eye bolt.

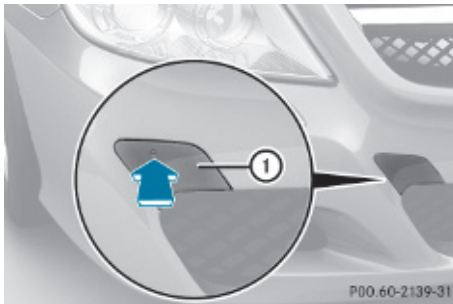
Canada only

- ▶ Press mark on cover ① as indicated by the arrow and pull on lower edge simultaneously.
- ▶ Lift cover ① off to reveal the threaded hole for the towing eye bolt.

Removing cover in rear bumper**⚠ Warning!**

In order to avoid possible serious burns or injury, use extreme caution when removing the rear cover, because the rear exhaust pipe is extremely hot.

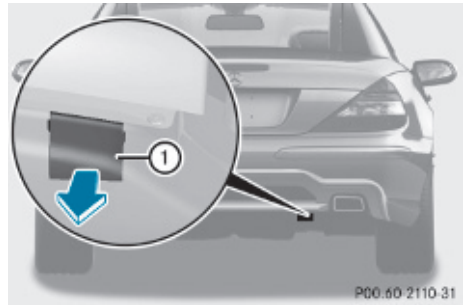

Example illustration USA, bumper in Canada differs slightly

- ▶ Insert flat, blunt object as a lever into upper left or right recess of cover ①.
- ▶ Loosen cover ① using the lever.
- ▶ Fold cover ① down in direction of arrow to reveal the threaded hole for the towing eye bolt.

Fixing towing eye bolt

Example illustration front bumper

- ▶ Take the towing eye bolt and, if so equipped, the wheel wrench from the vehicle tool kit (▷ page 224).
- ▶ Screw towing eye bolt ② clockwise into threaded hole to its stop.
- ▶ Insert wheel wrench into towing eye and tighten towing eye bolt ② by turning it clockwise.

or

- ▶ If your vehicle is not equipped with a wheel wrench, use a suitable object to turn the towing eye bolt.

Removing towing eye bolt

- ▶ Loosen towing eye bolt ② by turning it counterclockwise.
- ▶ Unscrew towing eye bolt ②.
- ▶ **Reinstalling front cover:** Fit locking tabs of cover ① (▷ page 288) under the lower edge of the opening in the bumper.
- ▶ Apply even pressure on the upper part of the cover until it snaps into place.
- ▶ **Reinstalling rear cover:** Fit cover ① (▷ page 288) and snap it into place.
- ▶ Store the towing eye bolt ② and wheel wrench back into the vehicle tool kit.

Towing with front axle raised

- ❗ The vehicle may be towed only for distances up to 30 miles (50 km) and at a speed not to exceed 30 mph (50 km/h).
- ▶ Make sure the ignition is switched on.
- ▶ With the vehicle at a standstill, depress the brake pedal and keep it pressed.
- ▶ Shift the automatic transmission into neutral position **N**.
- ▶ Release the brake pedal.
- ▶ If engaged, release the parking brake.
- ▶ Switch off the automatic central locking (▷ page 126).
- ▶ Switch off the ignition and leave the SmartKey in the starter switch.
- ▶ Switch on the hazard warning flasher (▷ page 92).
- ❗ Because the ESP® operates automatically, the engine and ignition must be shut off (SmartKey in starter switch position **0** or **1** or KEYLESS-GO start/stop button in position **0** or **1**) when the vehicle is being towed with the front axle raised. Active braking action through the ESP® may otherwise seriously damage the brake system which is not covered by the Mercedes-Benz Limited Warranty.

Towing with all wheels on the ground

Warning!

If circumstances require towing the vehicle with all wheels on the ground, always tow with a tow bar if:

- the engine will not run
- there is a malfunction in the electro-hydraulic brake system
- there is a malfunction in the power supply or in the vehicle's electrical system

This is necessary to adequately control the towed vehicle.

Prior to towing the vehicle with all wheels on the ground, make sure the SmartKey is in starter switch position **2**.

Warning!

With the engine not running, there is no power assistance for the brake and steering systems. In this case, it is important to keep in mind that a considerably higher degree of effort is necessary to brake and steer the vehicle. Adapt your driving accordingly.

- ▶ Make sure the ignition is switched on.
- ▶ With the vehicle at a standstill, depress the brake pedal and keep it pressed.
- ▶ Shift the automatic transmission into neutral position **N**.
- ▶ Release the brake pedal.
- ▶ If engaged, release the parking brake.
- ▶ Switch on the hazard warning flasher (▷ page 92).

- ❗ The vehicle may be towed only for distances up to 30 miles (50 km) and at a speed not to exceed 30 mph (50 km/h).

- i** While being towed with the hazard warning flasher in use, use the combination switch in the usual manner to signal turns. Only the selected turn signal will operate. Upon canceling the turn signal, the hazard warning flasher will operate again.

Fuses

Introduction

The electrical fuses in your vehicle serve to switch off malfunctioning power circuits. If a fuse is blown, the components and systems secured by that fuse will stop operating.

Warning!

Only use fuses approved by Mercedes-Benz with the specified amperage for the system in question and do not attempt to repair or bridge a blown fuse. Using other than approved fuses or using repaired or bridged fuses may cause an overload leading to a fire, and/or cause damage to electrical components and/or systems. Have the cause determined and remedied by an authorized Mercedes-Benz Center.

A blown fuse must be replaced by an appropriate spare fuse (recognizable by its color or the fuse rating given on the fuse) of the amperage recommended in the fuse chart. Any Mercedes-Benz Center will be glad to advise you on this subject.

- i** In case of a blown fuse contact Roadside Assistance or an authorized Mercedes-Benz Center.

If a newly inserted fuse blows again, have the cause determined and rectified by an authorized Mercedes-Benz Center.

The fuse chart is located in the trunk with the vehicle tool kit (> page 224). The fuse chart explains the fuse allocation and fuse amperages.

Before replacing fuses

- ▶ Engage the parking brake.
- ▶ Make sure the automatic transmission is in park position **P**.
- ▶ Switch off all electrical consumers.
- ▶ Turn off the engine.

- ▶ Remove the SmartKey from the starter switch.
- ▶ Vehicles with KEYLESS-GO: Open the driver's door (this puts the starter switch in position **0**, same as with the SmartKey removed from the starter switch). The driver's door then can be closed again.

Fuse box in passenger compartment

The fuse box is located under the rear passenger-side storage compartment.

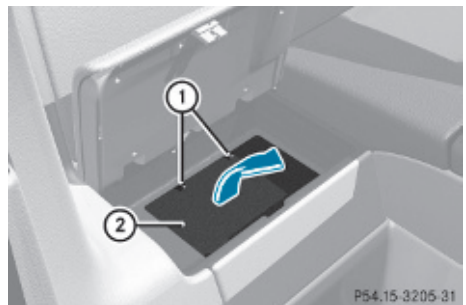

- ▶ Open the passenger door.
- ▶ **Opening:** Open the rear passenger-side storage compartment (> page 163).
- ▶ Lift both clips ①.
- ▶ Remove storage compartment floor ② in direction of arrow.
- ▶ **Closing:** To reinstall storage compartment floor ② after checking or replacing fuses, follow the procedure in reverse order.
- !** The fuse box cover must be properly positioned as described. Otherwise, moisture or dirt could enter the fuse box and possibly impair fuse operation.

Fuse box in trunk

The fuse in the trunk is located on the right-hand side of the trunk.

- ▶ Lift up the trunk floor cover.



P54.15.3206.31

- ▶ With a dry cloth, remove any moisture from fuse box cover ①.
- ▶ Move slide to position ③ and lift fuse box cover ①.
- ▶ **Closing:** Make sure the sealing rubber is positioned properly.
- ▶ Hook fuse box cover ① onto tabs and close it.
- ▶ Move slide to position ②.

! The fuse box cover must be properly positioned with the slide at the  symbol to prevent moisture and/or dirt from entering the fuse box and possibly impairing fuse operation.

- ▶ Close the hood after checking or replacing fuses.

Fuse box in engine compartment

The fuse boxes are located on the driver's and passenger side in front of the bulkhead (wall separating the engine and passenger compartment).

- ▶ Open the hood.

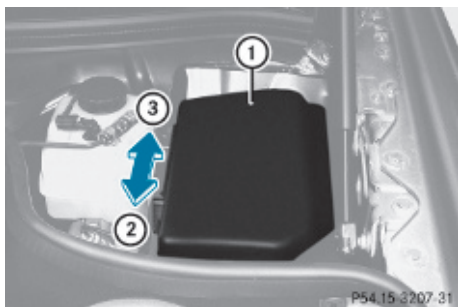

P54.15.3207.31

Fuse box on driver's side

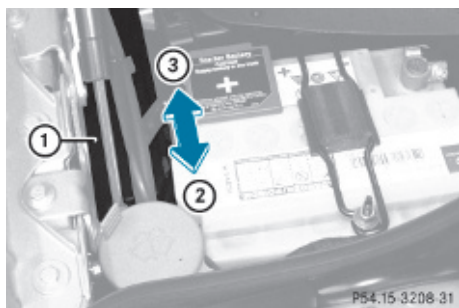

P54.15.3208.31

Fuse box on passenger side

Emergency engine shut-down

If the engine cannot be turned off as described (▷ page 102), you may use the following emergency procedure.

- ▶ Take the fuse chart from the vehicle tool kit (▷ page 224).
- ▶ Find row "Engine emergency stop" in the fuse chart table to identify the fuses that have to be removed as well as their locations.
- ▶ Remove the respective fuses.

Vehicle equipment	294
Parts service	294
Warranty coverage	294
Identification labels	294
Vehicle specification SL 550 (230.471)	296
Vehicle specification SL 600 (230.477)	296
Vehicle specification SL 63 AMG (230.470)	297
Vehicle specification SL 65 AMG (230.479)	298
Rims and tires	299
Fuels, coolants, lubricants, etc.	303



Vehicle equipment

i This Operator's Manual describes all features, standard or optional, potentially available for your vehicle at the time of purchase. Please be aware that your vehicle might not be equipped with all features described in this manual.

Parts service

All authorized Mercedes-Benz Centers maintain a stock of Genuine Mercedes-Benz Parts required for maintenance and repair work. In addition, strategically located parts distribution centers provide quick and reliable parts service.

More than 300 000 different parts for Mercedes-Benz models are available.

Genuine Mercedes-Benz Parts are subjected to stringent quality inspections. Each part has been specifically developed, manufactured or selected for and adapted to Mercedes-Benz vehicles.

Therefore, Genuine Mercedes-Benz Parts should be installed.

! Do not use non-genuine Mercedes-Benz parts and accessories not authorized by Mercedes-Benz. Doing so could damage the vehicle, which is not covered by the Mercedes-Benz Limited Warranty. Also, it could compromise the vehicle's durability or safety.

Warranty coverage

Your vehicle is covered under the terms of the warranties printed in the Service and Warranty Information booklet.

Your authorized Mercedes-Benz Center will exchange or repair any defective parts originally installed in the vehicle in accordance with the terms of the following warranties:

- New Vehicle Limited Warranty
- Emission System Warranty
- Emission Performance Warranty
- California, Connecticut, Maine, Massachusetts, New York, Pennsylvania, Rhode Island, and Vermont Emission Control Systems Warranty
- State Warranty Enforcement Laws (Lemon Laws)

Replacement parts and accessories are covered by the Mercedes-Benz Parts and Accessories warranties, copies of which are available at any authorized Mercedes-Benz Center.

Loss of Service and Warranty Information booklet

Should you lose your Service and Warranty Information booklet, have an authorized Mercedes-Benz Center arrange for a replacement. It will be mailed to you.

Identification labels

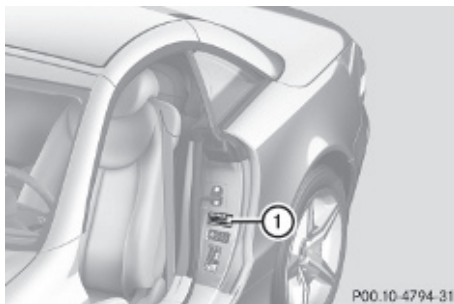

Vehicle specification SL 550 (230.471)

The quoted data apply only to the standard vehicle. Contact an authorized Mercedes-Benz Center for the corresponding data of all special bodies and special equipment.

Engine SL 550	
Engine, type	273
Mode of operation	4-stroke engine, gasoline injection
No. of cylinders	8
Bore	3.86 in (98.00 mm)
Stroke	3.56 in (90.50 mm)
Total piston displacement	333.2 cu in (5 461 cm ³)
Compression ratio	10.7:1
Output acc. to SAE J 1349 ²⁰	382 hp/6 000 rpm (285 kW/6 000 rpm)
Maximum torque acc. to SAE J 1349	391 lb-ft/ 2 800 - 4 800 rpm (530 Nm/ 2 800 - 4 800 rpm)
Maximum engine speed	6 500 rpm
Firing order	1-5-4-2-6-3-7-8
Poly-V-belt	2 401 mm

Electrical system SL 550

Alternator	14 V/180 A
Starter motor	12 V/1.7 kW
Starter battery	12 V/35 Ah

Electrical system SL 550

Battery for electrical consumers	12 V/70 Ah
Spark plugs, type	Bosch Y 7 MPP33
Spark plugs, electrode gap	0.031 in (0.8 mm)
Spark plugs, tightening torque	15 - 18 lb-ft (20 - 25 Nm)

Main dimensions SL 550

Overall vehicle length	179.8 in (4 568 mm)
	185.6 in (4 713 mm) ²¹
Overall vehicle width ²²	81.5 in (2 069 mm)
Overall vehicle height	51.0 in (1 295 mm)
	65.9 in (1 674 mm) ²¹
Wheelbase	100.8 in (2 560 mm)
Track, front	61.4 in (1 559 mm)
Track, rear	60.5 in (1 537 mm)
Turning circle	36.2 ft (11.04 m)

Weights SL 550

Trunk load	max. 220 lb (100 kg)
------------	----------------------

Vehicle specification SL 600 (230.477)

The quoted data apply only to the standard vehicle. Contact an authorized Mercedes-Benz Center for the corresponding data of all special bodies and special equipment.

²⁰ Premium fuel required. Performance may vary with fuel octane rating.

²¹ When opening/closing hardtop.

²² Exterior rear view mirrors folded out.

Engine SL 600	
Engine, type	275
Mode of operation	4-stroke engine, gasoline injection
No. of cylinders	12
Bore	3.23 in (82.00 mm)
Stroke	3.43 in (87.00 mm)
Total piston displacement	336.4 cu in (5 513 cm ³)
Compression ratio	9.0:1
Output acc. to SAE J 1349 ²³	510 hp/5 000 rpm (380 kW/5 000 rpm)
Maximum torque acc. to SAE J 1349	612 lb-ft/1 900 - 3 500 rpm (830 Nm/1 900 - 3 500 rpm)
Maximum engine speed	5 950 rpm
Firing order	1-12-5-8-3-10-6-7-2-11-4-9
Poly-V-belt	2 335 mm

Electrical system SL 600	
Alternator	14 V/180 A
Starter motor	12 V/2.0 kW
Starter battery	12 V/35 Ah
Battery for electrical consumers	12 V/70 Ah
Spark plugs, type	NGK IFR 6Q-G

Electrical system SL 600	
Spark plugs, electrode gap	0.028 in (0.7 mm)
Spark plugs, tightening torque	15 - 22 lb-ft (20 - 30 Nm)

Main dimensions SL 600	
Overall vehicle length	179.8 in (4 568 mm)
	185.6 in (4 713 mm) ²⁴
Overall vehicle width ²⁵	81.5 in (2 069 mm)
Overall vehicle height	51.0 in (1 295 mm)
	65.9 in (1 674 mm) ²⁴
Wheelbase	100.8 in (2 560 mm)
Track, front	61.4 in (1 559 mm)
Track, rear	60.5 in (1 537 mm)
Turning circle	36.2 ft (11.04 m)

Weights SL 600	
Trunk load	max. 220 lb (100 kg)

Vehicle specification SL 63 AMG (230.470)

The quoted data apply only to the standard vehicle. Contact an authorized Mercedes-Benz Center for the corresponding data of all special bodies and special equipment.

²³ Premium fuel required. Performance may vary with fuel octane rating.

²⁴ When opening/closing hardtop.

²⁵ Exterior rear view mirrors folded out.



Engine SL 63 AMG	
Engine, type	156
Mode of operation	4-stroke engine, gasoline injection
No. of cylinders	8
Bore	4.02 in (102.20 mm)
Stroke	3.72 in (94.60 mm)
Total piston displacement	378.8 cu in (6 208 cm ³)
Compression ratio	11.3:1
Output acc. to SAE J 1349 ²⁶	518 hp/6 800 rpm (386 kW/6 800 rpm)
Maximum torque acc. to SAE J 1349	465 lb-ft/5 200 rpm (630 Nm/5 200 rpm)
Maximum engine speed	7 000 rpm
Firing order	1-5-4-2-6-3-7-8
Poly-V-belt	2 360 mm

Electrical system SL 63 AMG	
Alternator	14 V/180 A
Starter motor	12 V/2.1 kW
Starter battery	12 V/35 Ah
Battery for electrical consumers	12 V/70 Ah
Spark plugs, type	NGK ILZKAR 7A10
Spark plugs, electrode gap	0.039 in (1.0 mm)
Spark plugs, tightening torque	15 - 18 lb-ft (20 - 25 Nm)

Main dimensions SL 63 AMG	
Overall vehicle length	181.0 in (4 598 mm)
	187.9 in (4 772 mm) ²⁷
Overall vehicle width ²⁸	81.5 in (2 069 mm)
Overall vehicle height	51.1 in (1 298 mm)
	66.1 in (1 680 mm) ²⁷
Wheelbase	100.8 in (2 560 mm)
Track, front	61.8 in (1 569 mm)
Track, rear	61.2 in (1 555 mm)
Turning circle	36.3 ft (11.05 m)

SL 63 AMG	
Trunk load	max. 220 lb (100 kg)

Vehicle specification SL 65 AMG (230.479)

The quoted data apply only to the standard vehicle. Contact an authorized Mercedes-Benz Center for the corresponding data of all special bodies and special equipment.

Engine SL 65 AMG	
Engine, type	275
Mode of operation	4-stroke engine, gasoline injection
No. of cylinders	12
Bore	3.25 in (82.60 mm)
Stroke	3.66 in (93.00 mm)
Total piston displacement	364.9 cu in (5 980 cm ³)

²⁶ Premium fuel required. Performance may vary with fuel octane rating.

²⁷ When opening/closing hardtop.

²⁸ Exterior rear view mirrors folded out.

Engine SL 65 AMG	
Compression ratio	9.0:1
Output acc. to SAE J 1349 ²⁹	603 hp/ 4 800 - 5 100 rpm (450 kW/ 4 800 - 5 100 rpm)
Maximum torque acc. to SAE J 1349	738 lb-ft/ 2 000 - 4 000 rpm (1 000 Nm/ 2 000 - 4 000 rpm)
Maximum engine speed	5 950 rpm
Firing order	1-12-5-8-3-10- 6-7-2-11-4-9
Poly-V-belt	2 335 mm

Electrical system SL 65 AMG	
Alternator	14 V/180 A
Starter motor	12 V/1.7 kW
Starter battery	12 V/35 Ah
Battery for electrical consumers	12 V/70 Ah
Spark plugs, type	NGK IFR 6Q-G
Spark plugs, electrode gap	0.028 in (0.7 mm)
Spark plugs, tightening torque	18 - 22 lb-ft (25 - 30 Nm)

Main dimensions SL 65 AMG	
Overall vehicle length	181.0 in (4 598 mm)
	187.9 in (4 772 mm) ³⁰

Main dimensions SL 65 AMG	
Overall vehicle width ³¹	81.5 in (2 069 mm)
Overall vehicle height	51.1 in (1 298 mm)
	66.1 in (1 680 mm) ³⁰
Wheelbase	100.8 in (2 560 mm)
Track, front	61.8 in (1 569 mm)
Track, rear	61.2 in (1 555 mm)
Turning circle	36.3 ft (11.05 m)

SL 65 AMG	
Trunk load	max. 220 lb (100 kg)

Rims and tires

Notes

! Only use tires which have been tested and approved by Mercedes-Benz. Tires approved by Mercedes-Benz are developed to provide best possible performance in conjunction with the driving safety systems on your vehicle such as the ABS or the ESP®. Tires specially developed for your vehicle and tested and approved by Mercedes-Benz can be identified by finding the following on the tire's sidewall:

- MO = Mercedes-Benz Original equipment tires
- MO1 = Mercedes-Benz Original equipment tires (applicable to selected tire sizes only)
- MOE = Mercedes-Benz Original Extended (tires with limited run-flat characteristics) original equipment tires

²⁹ Premium fuel required. Performance may vary with fuel octane rating.

³⁰ When opening/closing hardtop.

³¹ Exterior rear view mirrors folded out.

Using tires other than those approved by Mercedes-Benz may result in damage that is not covered by the Mercedes-Benz Limited Warranty.

For information on driving with MOExtended tires, see the “Practical hints” section (> page 283).

! Using tires other than those approved by Mercedes-Benz can have detrimental effects, such as

- poor handling characteristics
- increased noise
- increased fuel consumption

Moreover, tires and rims not approved by Mercedes-Benz may, under load, exhibit dimensional variations and different tire deformation characteristics that could cause them to come into contact with the vehicle body or axle parts. Damage to the tires or the vehicle may be the result.

i Further information on tires and rims is available at any authorized Mercedes-Benz Center. The Tire and Loading Information placard with the recommended tire inflation pressures for cold tires is located on the driver’s door B-pillar. Supplemental tire inflation pressure information for driving at high speeds or for vehicle loads less than the maximum loaded vehicle condition can be found on the tire inflation pressure label. The tire inflation pressure label is located on the inside of the fuel filler

flap. The tire inflation pressure should be checked regularly and should only be adjusted on cold tires. Follow tire manufacturer’s maintenance recommendation included with the vehicle.





For information on recommended tire inflation pressure and supplemental tire inflation pressure information for special driving situations, see (> page 187).

i Please keep in mind that the vehicle must be equipped

- with wheels of identical dimensions on each axle (left and right)
- with tires of identical characteristics all around, i.e. summer tires, winter tires, all-season tires, or MOExtended tires etc.

i The following pages also list the approved rim and tire sizes for equipping your vehicle with winter tires. Winter tires are not available as standard or optional factory equipment, but can be purchased from an authorized Mercedes-Benz Center.

Equipping your vehicle with winter tires approved for your vehicle model may require the purchase of rims of the recommended size for use with these winter tires. This depends on vehicle model and the standard or optional factory-equipped wheel rim/tire configuration on your vehicle. For more information contact an authorized Mercedes-Benz Center.

Same size tires			
		SL 550 SL 550 (Sport Package) SL 600 SL 600 (Sport Package)	SL 63 AMG
18" wheels	Rims (light alloy)	8.5 J x 18 H2	—
	Wheel offset	1.38 in (35 mm)	—
	AMG rims (light alloy)	—	8.5 J x 18 H2
	Wheel offset	—	1.18 in (30 mm)
	Winter tires ^{32,33}	255/40 R18 95V M+S  or 255/40 R18 95V M+S  MOExtended ³⁴	255/40 R18 95V M+S 
		SL 63 AMG SL 63 AMG (Performance Package) SL 65 AMG	
19" wheels	AMG rims (light alloy)	8.5 J x 19 H2	
	Wheel offset	1.18 in (30 mm)	
	Winter tires ^{32,33}	255/35 R19 96V XL (Extra Load) M+S 	

³² Radial-ply tires.

³³ Not available as factory equipment.

³⁴ Must be used in conjunction with Advanced Tire Pressure Monitoring System only.

Mixed size tires

			SL 550 ³⁵	SL 600 ³⁵
18" wheels	Front axle	Rims (light alloy) Wheel offset	8.5 J x 18 H2 1.38 in (35 mm)	8.5 J x 18 H2 1.38 in (35 mm)
		Summer tires ³⁶	255/40 R18 95W or 255/40 R18 95Y MOExtended ³⁷	255/40 R18 95Y or 255/40 R18 95Y MOExtended ³⁷
	Rear axle	Rims (light alloy) Wheel offset	9.5 J x 18 H2 1.57 in (40 mm)	9.5 J x 18 H2 1.57 in (40 mm)
		Summer tires ^{36,38}	285/35 R18 97W or 285/35 R18 97Y MOExtended ³⁷	285/35 R18 97Y or 285/35 R18 97Y MOExtended ³⁷

			SL 550 ³⁹ SL 550 (Sport Package) ³⁵ SL 600 ³⁹ SL 600 (Sport Package) ³⁵ SL 63 AMG SL 63 AMG (Performance Package) SL 65 AMG
19" wheels	Front axle	AMG rims (light alloy) Wheel offset	8.5 J x 19 H2 1.18 in (30 mm)
		Summer tires ³⁶	255/35 ZR19 96Y XL (Extra Load) MO1
	Rear axle	AMG rims (light alloy) Wheel offset	9.5 J x 19 H2 1.22 in (31 mm)
		Summer tires ^{36,38}	285/30 ZR19 98Y XL (Extra Load) MO1

³⁵ USA only.³⁶ Radial-ply tires.³⁷ Must be used in conjunction with Advanced Tire Pressure Monitoring System only.³⁸ Must not be used with snow chains.³⁹ Canada only.

Spare wheel

- !** Compare the recommended tire inflation pressure for your vehicle with the tire inflation pressure on the yellow label located on the spare wheel rim.
If the tire inflation pressure on the yellow label on the spare wheel rim differs from the values given in this Operator's Manual, inflate the tire to the recommended tire inflation pressure given on the yellow label on the spare wheel rim.
- i** Please note that the tire inflation pressure of the spare wheel differs from the tire inflation pressure of the road tires.

	SL 550 SL 550 (Sport Package)	SL 600 SL 600 (Sport Package) SL 63 AMG
Rim	6 B x 17 H2	6 B x 18 H2
Wheel offset	0.98 in (25 mm)	0.98 in (25 mm)
Collapsible tire⁴⁰	185/60-17 93P	175/55-18 95P
Recommended tire inflation pressure	41 psi (2.8 bar)	51 psi (3.5 bar)

	SL 63 AMG (Performance Package) SL 65 AMG
Rim	6.5 B x 19 H2
Wheel offset	0.55 in (14 mm)
Collapsible tire⁴⁰	175/50-19 97P
Recommended tire inflation pressure	51 psi (3.5 bar)

Fuels, coolants, lubricants, etc.

Capacities

Vehicle components and their respective lubricants must match. Therefore only use products tested and approved by Mercedes-Benz.

For information on tested and approved products, contact an authorized Mercedes-Benz Center or visit **www.mbusa.com** (USA only).

Warning!

Comply with all valid regulations with respect to handling, storing, and disposing of service fluids. Otherwise you could endanger persons or the environment.

Keep service fluids out of the reach of children.

For health reasons, you should prevent service fluids from coming into direct contact with your skin or clothing.

⁴⁰ Must not be used with snow chains.

If a service fluid is swallowed, contact a physician immediately.

	Model	Capacity	Fuels, coolants, lubricants, etc.
Engine with oil filter	SL 550 SL 65 AMG	9.0 US qt (8.5 l)	Approved engine oils
	SL 600 SL 63 AMG	8.5 US qt (8.0 l)	
Automatic transmission	SL 550	9.8 US qt (9.3 l)	MB Automatic Transmission Fluid
	SL 63 AMG	9.3 US qt (8.8 l)	
	SL 600 SL 65 AMG	8.0 US qt (7.5 l)	
Rear axle	SL 550 SL 600	1.3 US qt (1.2 l)	MB Hypoid Gear Oil (SAE 85W-90)
	SL 63 AMG		Fuchs Titan EG 5010 D
	SL 63 AMG ⁴¹ SL 65 AMG		Castrol SAF-XJ (SAE 75W-140)
Hydraulic system for active body control (ABC)	All models	3.7 US qt (3.5 l)	MB ABC Fluid
Power steering	All models	approx. 1.1 US qt (1.0 l)	MB Power Steering Fluid (Chevron Texaco PSF 9109)
Brake system	All models	0.53 US qt (0.5 l)	MB Brake Fluid (DOT 4+)
Cooling system	SL 550	approx. 12.3 US qt (11.6 l)	MB 325.0 Anticorrosion/Antifreeze
	SL 600	approx. 15.9 US qt (15.0 l)	
	SL 63 AMG	approx. 11.9 US qt (11.3 l)	
	SL 65 AMG	approx. 14.8 US qt (14.0 l)	
Low temperature cooling system	SL 600	approx. 2.2 US qt (2.1 l)	
	SL 65 AMG	approx. 3.4 US qt (3.2 l)	

⁴¹ With Performance Package.

	Model	Capacity	Fuels, coolants, lubricants, etc.
Fuel tank	All models	21.1 US gal (80.0 l)	Premium unleaded gasoline (Minimum Posted Octane 91 [Avg. of 96 RON/86 MON])
Fuel tank reserve	SL 550 SL 600	approx. 2.6 US gal (10.0 l)	
	SL 63 AMG SL 65 AMG	approx. 3.7 US gal (14.0 l)	
Air conditioning system	All models	—	R134a refrigerant and special PAG lubricant oil (never R 12)
Hydraulic system for retractable hardtop	All models	0.42 US qt (0.4 l)	MB Hydraulic Oil
Washer system and headlamp cleaning system	All models	7.4 US qt (7.0 l)	MB Windshield Washer Concentrate ⁴² (▷ page 309) Washer fluid mixing ratio (▷ page 309)

Approved engine oils

Engine oils are specifically tested for their suitability in our engines and durability for our service intervals. Therefore, only use approved engine oils and oil filters required for vehicles with the Maintenance System.

For a listing of approved engine oils and oil filters, contact an authorized Mercedes-Benz Center or visit www.mbusa.com (USA only).

! Using engine oils and oil filters of a specification other than those expressly required for the Maintenance System, or changing of oil and oil filter at change intervals longer than those called for by the Maintenance System will result in engine or emission control system damage not

covered by the Mercedes-Benz Limited Warranty.

Please follow Maintenance System recommendations for scheduled oil changes. Failure to do so will result in engine or emission control system damage not covered by the Mercedes-Benz Limited Warranty.

Mercedes-Benz recommends MOBIL OIL.

Use the table below to determine the MB sheet number.

Model	Engine, type	MB sheet number
SL 550	273	229.5
SL 600	275	229.5

⁴² Mixed with water or commercially available premixed washer solvent/antifreeze.

Model	Engine, type	MB sheet number
SL 63 AMG	156	229.5 ⁴³
SL 65 AMG	275	229.5

i MB sheet numbers are printed on the outside of oil containers.

Viscosity grades for engine oils

Using the chart below, select oil viscosity according to the lowest air temperature expected before the next oil change.

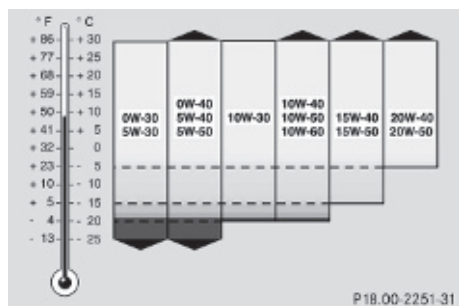

Engine oil additives

! Do not blend oil additives with engine oil. They may damage the engine. Damage or malfunctions resulting from blending oil additives are not covered by the Mercedes-Benz Limited Warranty.

Air conditioning refrigerant

R134a (HFC) refrigerant and special PAG lubricating oil are used in the air conditioning system.

! Never use R 12 (CFC) or mineral-based lubricating oil. Otherwise damage to the system will occur.

Brake fluid

Warning!

During vehicle operation, the boiling point of the brake fluid is continuously reduced through the absorption of moisture from the atmosphere.

Under extremely strenuous operating conditions, this moisture content can lead to the formation of bubbles in the system, thus reducing the system's efficiency.

Therefore, the brake fluid must be replaced regularly. Refer to your vehicle's Maintenance Booklet for replacement interval.

Only brake fluid approved by Mercedes-Benz is recommended. Any authorized Mercedes-Benz Center will provide you with additional information.

Premium unleaded gasoline

Warning!

Gasoline is highly flammable and poisonous. It burns violently and can cause serious personal injury.

Never allow sparks, flames or smoking materials near gasoline!

Turn off the engine before refueling.

Whenever you are around gasoline, avoid inhaling fumes and any skin or clothing contact. Extinguish all smoking materials.

Direct skin contact with fuels and the inhalation of fuel vapors are damaging your health.

! To maintain the engine's durability and performance, premium unleaded gasoline must be used.

If premium unleaded gasoline is not available and low octane gasoline is used, follow these precautions:

- Have the fuel tank only partially filled with unleaded regular gasoline and fill up

⁴³ Restriction: Only SAE 0W-40/SAE 5W-40 engine oils may be used.

with premium unleaded gasoline as soon as possible.

- Avoid full throttle driving and abrupt acceleration.
- Do not exceed an engine speed of 3 000 rpm if the vehicle is loaded with a light load such as two persons and no luggage.
- Do not exceed $\frac{2}{3}$ of maximum accelerator pedal position if the vehicle is fully loaded or operating in mountainous terrain.

Fuel requirements

Only use premium unleaded gasoline. The octane number (posted at the pump) must be 91 min. It is an average of both the Research Octane Number (RON) and the Motor Octane Number (MON): $(RON+MON)/2$. This is also known as the ANTI-KNOCK INDEX.

Reformulated gasolines (RFG) and/or unleaded gasoline containing oxygenates such as ethanol, TAME, ETBE, IPA, IBA, and TBA can be used provided the ratio of any one of these oxygenates to gasoline does not exceed 10%; MTBE must not exceed 15%.

The ratio of methanol to gasoline must not exceed 3% plus additional cosolvents.

Using mixtures of ethanol and methanol is not allowed. Gasohol, which contains 10% ethanol and 90% unleaded gasoline, can be used.

These blends must also meet all other fuel requirements, such as resistance to spark knock, boiling range, vapor pressure, etc.

Gasoline additives

A major concern among engine manufacturers is carbon build-up caused by gasoline. Mercedes-Benz recommends only the use of quality gasoline containing

additives that prevent the build-up of carbon deposits.

After an extended period of using fuels without such additives carbon deposits can build up, especially on the intake valves and in the combustion area, leading to engine performance problems such as:

- Warm-up hesitation
- Unstable idle
- Knocking/pinging
- Misfire
- Power loss

In areas where carbon deposits may be encountered due to lack of availability of gasoline which contains these additives, the use of Mercedes-Benz approved additives is recommended.

Contact an authorized Mercedes-Benz Center or visit www.mbusa.com (USA only) for a listing of approved products. Follow directions on the product label.

Do not blend other fuel additives with fuel. This only results in unnecessary cost and may be harmful to the engine operation.

! Damage or malfunction resulting from poor fuel quality or from blending additional fuel additives other than those tested and approved by us for use on Mercedes-Benz vehicles are not covered by the Mercedes-Benz Limited Warranty or by any pre-owned or Extended Limited Warranties.

Coolants

The engine coolant is a mixture of water and anticorrosion/antifreeze, which provides:

- Corrosion protection
- Freeze protection
- Boiling protection (by increasing the boiling point)

The cooling system was filled at the factory with a coolant providing freeze protection to

approximately -35°F (-37°C) and corrosion protection.

! Add premixed coolant solution only. Adding water and MB 325.0 Anticorrosion/Antifreeze separately from each other, could cause engine damage not covered by the Mercedes-Benz Limited Warranty.

If the antifreeze mixture is effective to -35°F (-37°C), the boiling point of the coolant in the pressurized cooling system is reached at approximately 266°F (130°C).

The coolant solution must be used year round to provide the necessary corrosion protection and increase boil-over protection. Refer to the Maintenance Booklet for replacement interval.

Coolant system design and coolant used determine the replacement interval. The replacement interval published in the Maintenance Booklet is only applicable if MB 325.0 Anticorrosion/Antifreeze solution or other Mercedes-Benz approved products of equal specification are used to renew the coolant concentration or bring it back up to the proper level.

For information on other Mercedes-Benz approved products of equal specification, contact an authorized Mercedes-Benz Center or visit **www.mbusa.com** (USA only).

To provide important corrosion protection, the solution must be at least 50% anticorrosion/antifreeze (equivalent to freeze protection to approximately -35°F [-37°C]).

If you use a solution that is more than 55% anticorrosion/antifreeze (freeze protection to approximately -49°F [-45°C]), the engine temperature will increase due to the lower heat transfer capability of the solution. Therefore, do not use more than this amount of anticorrosion/antifreeze.

If the coolant level is low, water and MB 325.0 Anticorrosion/Antifreeze should be used to bring it up to the proper level (have cooling system checked for signs of leakage). Please

make sure the mixture is in accordance with label instructions.

The water in the cooling system must meet minimum requirements, which are usually satisfied by normal drinking water.

If you are not sure about the water quality, contact an authorized Mercedes-Benz Center.

Anticorrosion/antifreeze

Your vehicle contains a number of aluminum parts. The use of aluminum components in motor vehicle engines necessitates that anticorrosion/antifreeze coolant used in such engines be specifically formulated to protect the aluminum parts. Failure to use such anticorrosion/antifreeze coolant will result in a significantly shortened service life.

Therefore, the following product is strongly recommended for use in your vehicle: MB 325.0 Anticorrosion/Antifreeze agent.

Before the start of the winter season (or once a year in hot southern regions), you should have the anticorrosion/antifreeze concentration checked.

The coolant is also regularly checked each time you bring your vehicle to an authorized Mercedes-Benz Center for service.

	Model	Approximate freeze protection	
		-35°F (-37°C)	-49°F (-45°C)
Cooling system	SL 550	6.1 US qt (5.8 l)	6.8 US qt (6.4 l)
	SL 600	7.9 US qt (7.5 l)	8.7 US qt (8.3 l)
	SL 63 AMG	6.0 US qt (5.65 l)	6.6 US qt (6.2 l)
	SL 65 AMG	7.4 US qt (7.0 l)	8.1 US qt (7.7 l)
Low temperature cooling system	SL 600	1.1 US qt (1.05 l)	1.3 US qt (1.2 l)
	SL 65 AMG	1.7 US qt (1.6 l)	1.9 US qt (1.8 l)

Washer system and headlamp cleaning system

Warning!

Washer solvent/antifreeze is highly flammable. Do not spill washer solvent/antifreeze on hot engine parts, because it may ignite and burn. You could be seriously burned.

- ▶ Use MB Windshield Washer Concentrate “MB SummerFit”.
- ▶ Mix with water for temperatures above freezing point.
- ▶ Mix with commercially available premixed washer solvent/antifreeze for temperatures below freezing point.

Washer fluid mixing ratio

For temperatures above the freezing point:
1 part “MB SummerFit” to 100 parts water
(1.34 fl oz [40 ml] “MB SummerFit” to 1 gal [4.0 l] water)

For temperatures below freezing point:
1 part “MB SummerFit” to 100 parts solvent
(1.34 fl oz [40 ml] “MB SummerFit” to 1 gal [4.0 l] solvent)

Service and Literature

Your authorized Mercedes-Benz Center has trained technicians and Genuine Mercedes-Benz Parts to service your vehicle properly. For expert advice and quality service, contact an authorized Mercedes-Benz Center.

If you are interested in obtaining service literature for your vehicle, please contact an authorized Mercedes-Benz Center.

We consider this the best way for you to obtain accurate information for your vehicle.

For further information you can find us on the Mercedes-Benz web site **www.mbusa.com** (USA only) or **www.mercedes-benz.ca** (Canada only).

Warning!

To help avoid personal injury, be extremely careful when performing any service work or repairs. Improper or incomplete service or the use of incorrect or inappropriate parts or materials may damage the vehicle or its equipment, which may in turn result in personal injury.

If you have any questions about carrying out any type of service, turn to the advice of an authorized Mercedes-Benz Center.

We reserve the right to make changes in design and equipment.

Therefore, information, illustrations and descriptions in this Operator's Manual might differ from your vehicle.

Reprinting, translation and copying, even of excerpts, is not permitted without our prior authorization in writing.

Press time July 30, 2009

GSP/OIS

Printed in U. S. A.



2305849396

Order no. 6515 3100 13 Part no. 230 584 93 96 Edition A 2011

Free Manuals Download Website

<http://myh66.com>

<http://usermanuals.us>

<http://www.somanuals.com>

<http://www.4manuals.cc>

<http://www.manual-lib.com>

<http://www.404manual.com>

<http://www.luxmanual.com>

<http://aubethermostatmanual.com>

Golf course search by state

<http://golfingnear.com>

Email search by domain

<http://emailbydomain.com>

Auto manuals search

<http://auto.somanuals.com>

TV manuals search

<http://tv.somanuals.com>