



Mercedes-Benz

Accessories

**Installation and Operation
Instructions**

Mercedes-Benz Bluetooth® Cradle for
Motorola V3 RAZR phone

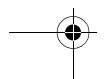
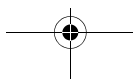
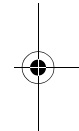
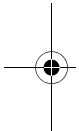



**Mercedes-Benz Bluetooth® Cradle
for Motorola V3 RAZR phone**

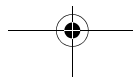
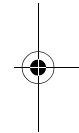
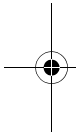
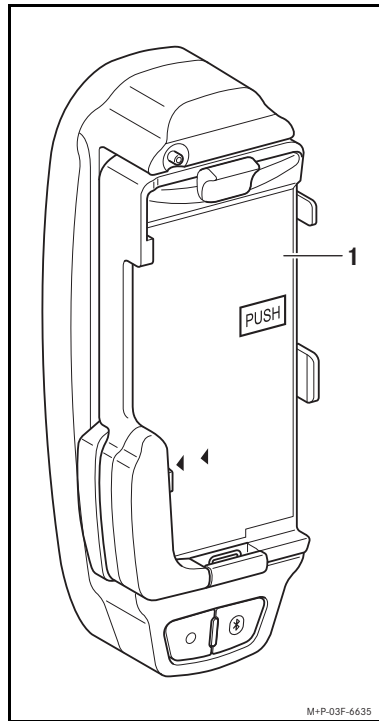



Application

These installation instructions are valid for vehicles with an MHI hands-free communication system and a Mercedes-Benz-approved Motorola RAZR phone with approved software level. Approved mobile telephones are listed and can be purchased on the Internet at www.wireless4mb.com or call 1-800-910-1021 to speak to a wireless activation specialist.

Parts included

- (1) Mercedes-Benz Bluetooth® Cradle for Motorola RAZR phones

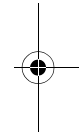
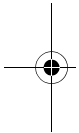

Warning

Always use approved phones with the Mercedes-Benz V3 Cradle. Operating a non-approved phone or radio transmitter with its own attached or built-in antenna while the engine is running can interfere with the vehicle's electronic system. For safety reasons, the driver should not use the mobile phone while the vehicle is in motion. We encourage the driver to stop the vehicle in a safe location before answering or placing a call.

Note

Please contact your local Mercedes-Benz Center if you encounter difficulties when operating the Mercedes-Benz Hands-Free Communication System.

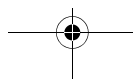



Notes

More information can be found on the Internet at www.wireless4mb.com or call 1-800-910-1021 to speak to a wireless activation specialist.

We reserve the right to change technical details from those shown in the illustrations contained in these installation instructions.

These installation instructions also refer to the Vehicle Operator's Manual, COMAND Operator's Manual, and mobile telephone manual. Please keep them available for reference.

Installing the Mercedes-Benz V3 Cradle

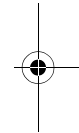
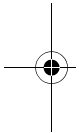
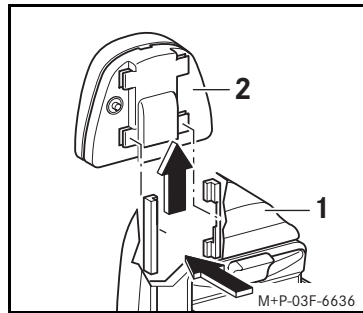

1. Insert the Mercedes-Benz V3 Cradle (1) into the latches on the pre-installed MHI contact plate (2), located in the center console.

Availability varies by model, see dealer for details. To insert the Mercedes-Benz V3 Cradle (1), slide it upwards until it clicks into place.

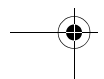
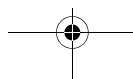



Inserting mobile telephone

Notes

The Motorola RAZR phone can be used inside and outside of the Mercedes-Benz V3 Cradle for use in hands-free mode. This is possible because the Mercedes-Benz V3 Cradle uses Bluetooth® technology to connect with your headset. Make sure you have established a Bluetooth® connection before using the Mercedes-Benz V3 Cradle, see pairing procedure on page 5.

When using the Motorola RAZR phone in the cradle, the Motorola RAZR phone will also be charged and connected to the vehicle's external mobile antenna for improved reception. Using the Motorola RAZR phone outside of the Mercedes-Benz V3 Cradle provides convenient hands-free operation with the phone in your pocket or hand bag. We recommend placing the phone in the cradle when the battery is low or when calling in a weak signal area. The phone may be inserted into the Mercedes-Benz V3 Cradle during a call, but we encourage that this is only done when the vehicle is not in motion.

Close the flip screen of the Motorola RAZR phone before inserting it into the Mercedes-Benz V3 Cradle.

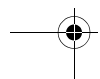
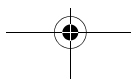
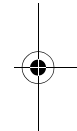
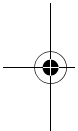

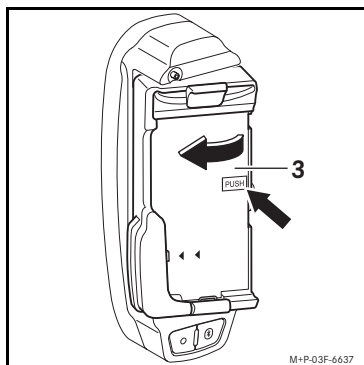

1. Push the latch (3) at the "PUSH"-sign. The latch (3) will swing out.

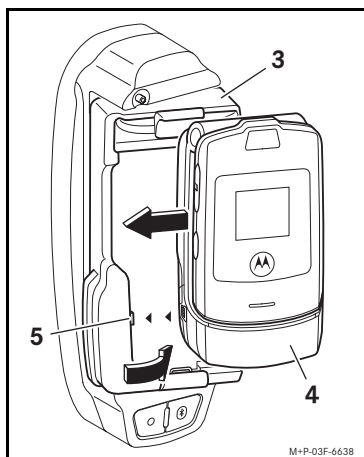
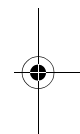
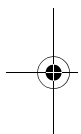

2. Slide the Motorola RAZR phone (4) into place. Make sure that connector (5) connects to Motorola RAZR phone (4).
3. Close latch (3).

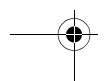
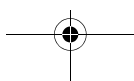



Pairing the Motorola RAZR phone with the Mercedes-Benz V3 Cradle

Make sure that the starter switch is in position 1, 2 or 3 (see the Vehicle Operator's Manual).

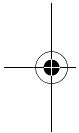
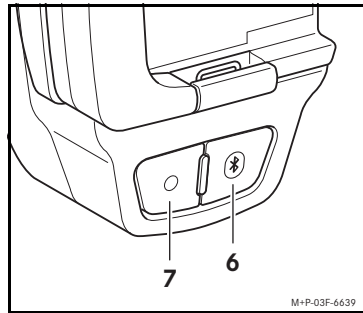

1. With Mercedes-Benz V3 Cradle connected to the vehicle press button (6) for approx. 2–3 seconds.

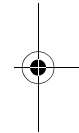

The LED (7) will begin to flash rapidly. The Mercedes-Benz V3 Cradle is in Discovery Mode and can be detected by the Motorola RAZR phone. The Mercedes-Benz V3 Cradle will appear as "MB V3 Cradle" on the Motorola RAZR phone.

2. For instructions on how to get the mobile telephone ready for pairing, see the mobile telephone manual or visit www.wireless4mb.com. Once the Motorola RAZR phone and Mercedes-Benz V3 Cradle find each other the Motorola RAZR phone will prompt the user to enter a Pass-Key.

3. When prompted, enter the Pass-Key 62872 into the Motorola RAZR phone.

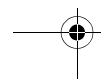
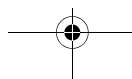



4. Once the Pass-Key has been entered and accepted the LED (7) will be lit continuously. This confirms that the Motorola RAZR phone is paired and connected and the Motorola RAZR phone's identity information has been stored in the Mercedes-Benz V3 Cradle.

5. The Motorola RAZR phone is now ready for use with the Mercedes-Benz Hands-Free Communication System.

Establishing a Bluetooth® connection

Notes

A maximum of 4 Motorola RAZR phones can be paired with the Mercedes-Benz V3 Cradle. However, only one Motorola RAZR phone is connected to the Mercedes-Benz V3 Cradle at a time. If a fifth Motorola RAZR phone is paired with the Mercedes-Benz V3 Cradle, then the information stored from the first Motorola RAZR phone which was paired with the Mercedes-Benz V3 Cradle will be replaced.

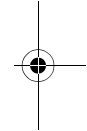
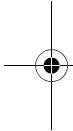

When the starter switch is in position 1, 2 or 3 (see the Vehicle Operator's Manual), the Mercedes-Benz V3 Cradle will search for the last connected Motorola RAZR phone and reconnect.

The Mercedes-Benz V3 Cradle will search continuously and automatically after start-up for one of the paired phones.

If the last connected Motorola RAZR phone is not found the Mercedes-Benz V3 Cradle will search for one of the previously paired phones and connect to it.

The searching routine is being repeated as long as a paired RAZR mobile phone is ready to be connected. Searching is indicated with LED (7) flashing periodically.

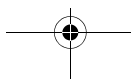



If the connection between the Mercedes-Benz V3 Cradle and Motorola RAZR phone is not established automatically, it is possible to establish a connection manually (see page 8).

Stored SMS messages can not be accessed via the COMAND or radio while the Bluetooth® connection is established.

The Motorola RAZR V3 and V3i allow viewing of incoming SMS. This feature is not possible with the Motorola RAZR V3c and V3m.

Not every ring-tone of the Motorola RAZR phone is supported by the COMAND or radio.

3-way-calling and call waiting are not supported from the Mercedes-Benz V3 Cradle. An audible beep will notify a waiting call.

The roaming indication is not supported by the COMAND or radio.

The Tele Aid System (emergency call system) will continue to function independently of the hands-free phone system as designed as long as there is a valid service contract.

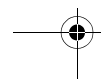
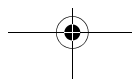
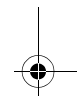
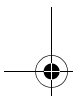
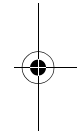
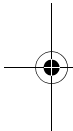



Connecting the Motorola RAZR phone and Mercedes-Benz V3 Cradle manually

For all Mercedes-Benz vehicles with the exception of the model year 2007 S-Class:

- Press **TEL** button on the COMAND or radio.

For model year 2007 S-Class vehicles:

- Using the COMAND Controller, select “Telephone” → “Telephone” → “Telephone on”.

Notes

Before manual connection, the Motorola RAZR phone must previously be paired with the Mercedes-Benz V3 Cradle, see pairing procedure on page 5.

The Mercedes-Benz V3 Cradle will search continuously and in sequence for one of the paired Motorola RAZR phones. If a Bluetooth® connection is disconnected manually the Mercedes-Benz V3 Cradle will stop searching.

When the Motorola RAZR phone is within the range (approx. 30 ft) of the Mercedes-Benz V3 Cradle, the connection between the Motorola RAZR phone and the Mercedes-Benz V3 Cradle will remain active, and phone calls made with the Motorola RAZR phone using the vehicle’s hands-free system. For this reason, the connection between the Motorola RAZR phone and the Mercedes-Benz V3 Cradle should be disconnected manually if the Motorola RAZR phone is taken out of the vehicle for independent use outside of it (see page 9).

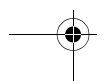
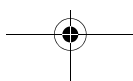
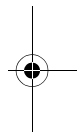
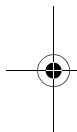



Disconnecting the Bluetooth® connection automatically

The connection between the Motorola RAZR phone and the Mercedes-Benz V3 Cradle is automatically disconnected when the Motorola RAZR phone travels outside of the connection range (approx. 30 ft) of the Mercedes-Benz V3 Cradle.

Disconnecting the Bluetooth® connection manually

The connection between the Motorola RAZR phone and the Mercedes-Benz V3 Cradle can be disconnected at any time by using the Motorola RAZR phone (see the Motorola RAZR phone manual for disconnection instructions).

To disconnect the paired Motorola RAZR phone from Mercedes-Benz V3 Cradle using the COMAND or radio:

For all Mercedes-Benz vehicles with the exception of the model year 2007 S-Class:

- Press and hold **TEL** button on the COMAND or radio for approx. 3 seconds.

For model year 2007 S-Class vehicles:

- Using the COMAND Controller, select "Telephone" → "Telephone" → "Telephone off".

Note

If a phone call is in progress, the connection can only be disconnected directly on the Motorola RAZR phone (see the Motorola RAZR phone manual for disconnection instructions).

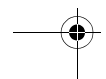
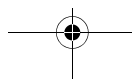
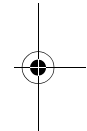
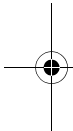



Removing Motorola RAZR phone

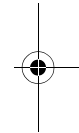
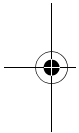
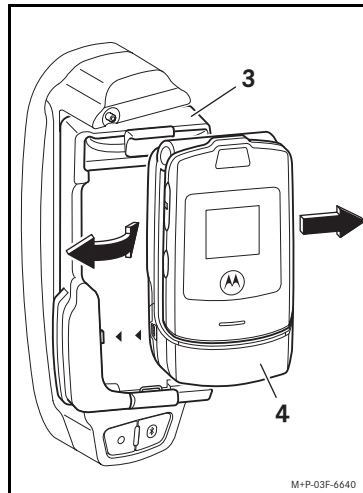

1. Press the latch (3) on the top of the Motorola RAZR phone (4). The latch (3) and the Motorola RAZR phone (4) will swing out.
2. Remove Motorola RAZR phone (4) sliding it out sideways.

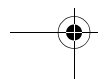
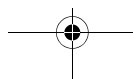



Detaching the Mercedes-Benz V3 Cradle

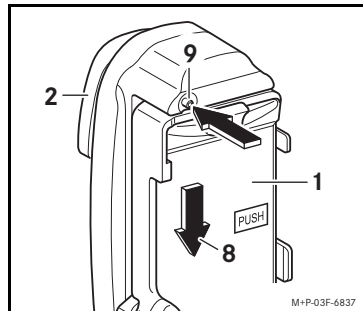

1. Press and hold the release button (9). Slide the Mercedes-Benz V3 Cradle (1) in direction of arrow (8) and remove it from the pre-installed contact plate (2).

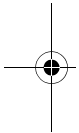

Note

This device complies with part 15 of the FCC Rules. Operation is subject to the following two conditions:

- This device may not cause harmful interference.
- This device must accept any interference received, including interference that may cause undesired operation.

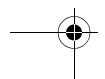
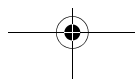
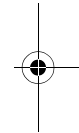

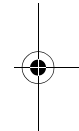
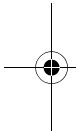

© 2006, Mercedes-Benz Accessories Inc.
Not to be reprinted, translated or otherwise
reproduced, either wholly or in part.
Mercedes-Benz Accessories Inc., Stuttgart ·
A DaimlerChrysler AG Company
09/06
03F035-06
Order No. S-3155-06A
Printed on 100 % Recycled Paper

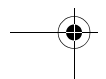
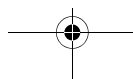

Free Manuals Download Website

<http://myh66.com>

<http://usermanuals.us>

<http://www.somanuals.com>

<http://www.4manuals.cc>

<http://www.manual-lib.com>

<http://www.404manual.com>

<http://www.luxmanual.com>

<http://aubethermostatmanual.com>

Golf course search by state

<http://golfingnear.com>

Email search by domain

<http://emailbydomain.com>

Auto manuals search

<http://auto.somanuals.com>

TV manuals search

<http://tv.somanuals.com>