



Mercedes-Benz



Operator's Manual

S 350 TURBODIESEL

Product information

Kindly observe the following in your own best interest:

We recommend using Mercedes-Benz original parts as well as conversion parts and accessories explicitly approved by us for your vehicle model. We have tested these parts to determine their reliability, safety and their special suitability for Mercedes-Benz vehicles.

We are unable to make an assessment for other products and therefore cannot be held responsible for them, even if in individual cases an official approval or authorization by governmental or other agencies should exist. Use of such parts and accessories could adversely affect the safety, performance or reliability of your vehicle. Please do not use them. Mercedes-Benz original parts as well as conversion parts and accessories approved by us are available at your authorized Mercedes-Benz Center where you will receive comprehensive information, also on permissible technical modifications, and where proper installation will be performed.

Our company and staff congratulate you on the purchase of your new Mercedes-Benz.

Your selection of our product is a demonstration of your trust in our company name. Further, it exemplifies your desire to own an automobile that will be as easy as possible to operate and provide years of service.

Your Mercedes-Benz represents the efforts of many skilled engineers and craftsmen. To ensure your pleasure of ownership, and for your safety and that of your passengers, we ask you to make a small investment of your time:

- Please read this manual carefully before putting it aside. Then return it to your vehicle where it will be handy for your reference.
- Please abide by the recommendations contained in this manual. They are designed to acquaint you with the operation of your Mercedes-Benz.
- Please abide by the warnings and cautions contained in this manual. They are designed to help improve the safety of the vehicle operator and occupants.

We extend our best wishes for many miles of safe, pleasurable driving.

DaimlerChrysler AG

Operator's manual

This Operator's Manual contains a great deal of useful information. We urge you to read it carefully and familiarize yourself with the vehicle before driving.

For your own safety and longer service life of the vehicle, we urge you to follow the instructions and warnings contained in this manual. Ignoring them could result in damage to the vehicle or personal injury to you or others. Vehicle damage caused by failure to follow instructions is not covered by the Mercedes-Benz Limited Warranty.

Your vehicle may have some or all of the equipment described in this manual. Therefore, you may find explanations for optional equipment not installed in your vehicle. If you have any questions about the operation of any equipment, your authorized Mercedes-Benz Center will be glad to demonstrate the proper procedures.

Owner's Service and Warranty Policy

The Owner's Service and Warranty Information Booklet contains detailed information about the warranties covering your Mercedes-Benz, including:

- New Car Limited Warranty,
- Emission System Warranty,
- Emission Performance Warranty,
- State Warranty Enforcement Laws (Lemon Laws).

Important notice for California retail buyers of Mercedes-Benz automobiles

Under California law you may be entitled to a replacement of your vehicle or a refund of the purchase price, if Mercedes-Benz USA,LLC or its authorized Mercedes-Benz Center fails to conform the vehicle to its express warranties after a reasonable number of repair attempts during the period of one year or 12 000 miles from original delivery of the vehicle. A reasonable number of repair attempts is presumed for a retail buyer (1) if the vehicle is out of service by reason of repair of substantial nonconformities for a cumulative total of more than 30 calendar days or (2) the same substantial non-conformity has been subject to repair four or more times **and you have at least once directly notified us in writing of the need to repair the non-conformity and have given us an opportunity to perform the repair ourselves. Notifications should be sent to the nearest Mercedes-Benz Regional Office listed in the Service and Warranty Information Booklet.**

Maintenance

The Service Booklet describes all the necessary maintenance work which should be performed at regular intervals.

Always have the Service Booklet with you when you take the vehicle to your authorized Mercedes-Benz Center for service.

The service advisor will record each service in the booklet for you.

Roadside assistance

The Mercedes-Benz Roadside Assistance Program provides factory trained technical help in the event of a breakdown. Calls to the toll-free Roadside Assistance number:

1-800-222-0100 (in the USA) only

will be answered by Mercedes-Benz Client Assistance Representatives 24 hours a day, 365 days a year.

For additional information refer to the Mercedes-Benz Roadside Assistance Program brochure in your glove box.

Change of address or ownership

If you change your address, be sure to send in the "Change of Address Notice" found in the Owner's Service and Warranty Policy Booklet. It is in your own interest that we can contact you should the need arise.

If you sell your Mercedes, please leave all owner's literature with the vehicle to make it available to the next owner.

If you bought this vehicle used, be sure to send in the "Notice of Purchase of Used Car" found in the Owner's Service and Warranty Policy Booklet.

Operating your vehicle outside the USA or Canada

If you plan to operate your vehicle in foreign countries, please be aware that service facilities or replacement parts may not be readily available.

Certain Mercedes-Benz models are available for delivery in Europe under our European Delivery Program. For details, consult your authorized Mercedes-Benz dealer or write to:

In the USA:

Mercedes-Benz USA,
LLC European Delivery Department
One Mercedes Drive
Montvale, NJ 07645

In Canada:

Mercedes-Benz Canada, Inc.
European Delivery Department
849 Eglinton Avenue East
Toronto, Ontario M4G 2L5

We continuously strive to improve our product, and ask for your understanding that we reserve the right to make changes in design and equipment. Therefore, information, illustrations and descriptions in this Operator's Manual might differ from your vehicle.

Optional equipment is also described in this manual, including operating instructions wherever necessary. Since they are special-order items, the descriptions and illustrations herein may vary slightly from the actual equipment of your vehicle.

If there are any equipment details that are not shown or described in this Operator's Manual, your authorized Mercedes-Benz Center will be glad to inform you of correct care and operating procedures.

The Operator's Manual and Service Booklet are important documents and should be kept with the vehicle.

Check Regularly and Before a Long Trip

See Index

The First 1000 Miles (1500 km)

The more cautiously you treat your vehicle during the break-in period, the more satisfied you will be with its performance later on. Therefore, drive your vehicle during the first 1500 km (1000 miles) at moderate vehicle and engine-speeds.

During this period, avoid heavy loads (full throttle driving) and high RPM (no more than 2/3 of maximum permissible speed in each gear as indicated on the speedometer).

Avoid accelerating by kickdown. It is not recommended to brake the vehicle by manually shifting to a lower gear.

We recommend to select positions "3" or "2" only at moderate speeds (for hill driving).

After 1000 miles (1500 km) speeds may be gradually increased to the permissible maximum

Maintenance

We strongly recommend that you have your vehicle serviced by your authorized Mercedes-Benz dealer, in accordance with the Maintenance Booklet.

Radio Transmitters

Warning!

Never operate radio transmitters equipped with a built-in or attached antenna (i.e. without the telephone connected to an external antenna) from inside the vehicle while the engine is running. Doing so could lead to a malfunction of the vehicle's electronic system, possibly resulting in an accident and personal injury.

Radio transmitters, such as a portable telephone or a citizens band unit should only be used inside the passenger compartment, if they are connected to a Mercedes-Benz approved antenna that is installed on the outside of the vehicle.

Introduction				
Product information	2	Power closing assist for door and trunk lid	33	Rear Window Sunshade
Operator's manual	4	Anti-Theft Alarm System	34	Rear Window Defroster
Consumer Information	130	Power Seats	35	Trunk Lid Release switch
Problems with your vehicle	131	Lumbar support	38	Instrument Lamps
Reporting Safety Defects	132	Multicontour Backrest	38	Display Illumination
Index	134	Heated Seats	39	Trip Odometer
		Armrest, Front	40	Clock
				Shelf below rear window
Instruments and controls	10	Armrest, Rear	41	Antenna
Instrument Cluster	12	Power head Restraints, Rear	41	Cellular telephone
Indicator Lamp Symbols	13	Adjustable steering wheel	42	
Starting and Turning Off the Engine	14	Seat belts and Supplemental restraint system (SRS)	43	Driving
Driving Instructions	15	Seat belts	43	
		Emergency tensioning retractor (ETR)	46	Drinking and driving
Operation		Airbag	47	Parking Brake
Air Outlets	20	Steering lock	52	Driving off
Automatic Climate Control	21	Combination Switch	53	Automatic Transmission
Rear passenger compartment	24	Exterior Lamp Switch	55	Rear fender indicator
Adjustable Air outlet	24	Inside and Exterior Rear View Mirrors	56	Cruise Control
Activated Charcoal Control	25	Sun Visors	59	Charge Indicator Lamp
Car keys	26	Vanity mirrors	59	Engine Oil Pressure Gauge
Infrared Remote Control	27	Interior Lighting	60	Low Engine Oil Level Warning Lamp
Central Locking system, Doors	30	Storage Compartments	61	Engine Oil Consumption
Trunk	31	Ashtrays	62	Fuel Consumption Gauge
Power window and sliding/		Lighter	62	Tachometer
Pop-Up roof	32	Sliding roof with rear pop-up feature	63	Fuel Reserve Warning Lamp
		Power Windows	64	Outside Temperature Indicator

Coolant Temperature Gauge	78	Checking Automatic Trans. Fluid Level	91	Manual Closing of Trunk Lid	116
Low Engine Coolant Level Warning Lamp	79	Turning Off Engine Manually	92	Replacing Wiper Blades	117
Low Windshield and Headlamp		Bleeding of Fuel System	92	Manual Release of Fuel Filler Flap	118
Washer Fluid Level Warning Lamp	79	Trunk Lamp	93	Roof rack	118
Exterior Lamp Failure Indicator Lamp	80	Spare Wheel, lug wrench	93	Emergency Operation of Sliding Roof	119
Seat Belt and Lock Warning Lamp	80	First Aid Kit	93	MERCEDES-BENZ	119
				Spare Parts Service	
Brake Pad Wear Indicator Lamp	80	Stowing Things in the Vehicle	93	Layout of Poly-V-Belt Drive	119
Brake Warning Lamp	81	Vehicle Jack	94		
ABS (Antilock Brake System)		Vehicle Tools	94	Technical Data.	
Warning Lamp	82			Fuels, Coolants, Lubricants etc.	
				Consumer Information	
Electronic Traction System (ETS)	83	Storage compartment below vehicle tool box	94		
Adaptive damping system (ADS)	84	Wheels	95	Identification Plates	122
Emission Control	85	Changing Wheels	96	Vehicle Data Card	123
Traveling Abroad	85	Tire Inflation Pressure	99	Warranty Coverage	123
Winter Driving	86	Exterior Lamps	100	Technical Data	124
Snow Chains	86	Fuses	105	Fuels, Coolants, Lubricants etc.	125
		Battery	106	Capacities	125
Practical Hints		Jump Starting	107	Engine Oils	127
		Towing the Vehicle	109	Engine Oils Additives	127
Hood	88	Cleaning and Care of the Vehicle	110	Brake Fluid	127
Checking Coolant Level	89	Testing Infrared Remote Control	114	Air Conditioner Refrigerant	127
Adding Coolant	89	Front Head Restraints	115	Coolants	129
Checking Engine Oil Level	90	Rear Seat Cushion	116	Check regularly and before a long trip	140

Instruments and Controls *For more detailed descriptions see specified pages*

- | | | | |
|-----------|---|-----------|--|
| 1 | Adjustable air outlet | 19 | Storage/eyeglasses compartment |
| 2 | Exterior lamp switch | 20 | Lock for storage/eyeglasses compartment and eye glove |
| 3 | Parking brake release | 21 | Glove box (illuminated with key in steering lock position 2) |
| 4 | Hood lock release | 22 | Rear window defroster switch |
| 5 | Parking brake pedal | 23 | Activated charcoal filter switch |
| 6 | Steering wheel adjustment switch | 24 | Central locking switch, Indicator lamp for anti-theft alarm |
| 7 | Combination switch | 25 | Hazard warning flasher switch |
| 8 | Cruise control | 26 | Trunk lid release switch |
| 9 | Horn, airbag | 27 | Automatic climate control |
| 10 | Instrument cluster | 28 | Radio |
| 11 | Steering lock with ignition/starter switch | 29 | Ashtray with lighter |
| 12 | Adjustable air outlet | 30 | Adaptive damping system adjustment switch |
| 13 | Heated air supply button - center air outlet | 31 | Seat heater switch |
| 14 | Non heated/cooled air supply button - center air outlet | 32 | Mirror adjustment switch |
| 15 | Air volume control for left air outlet | 33 | Power window switch |
| 16 | Air volume control for left center air outlet | 34 | Switch for rear seat head restraints |
| 17 | Air volume control for center air outlet | 35 | Switch for rear window sunshade |
| 18 | Air volume control for right air outlet | | |

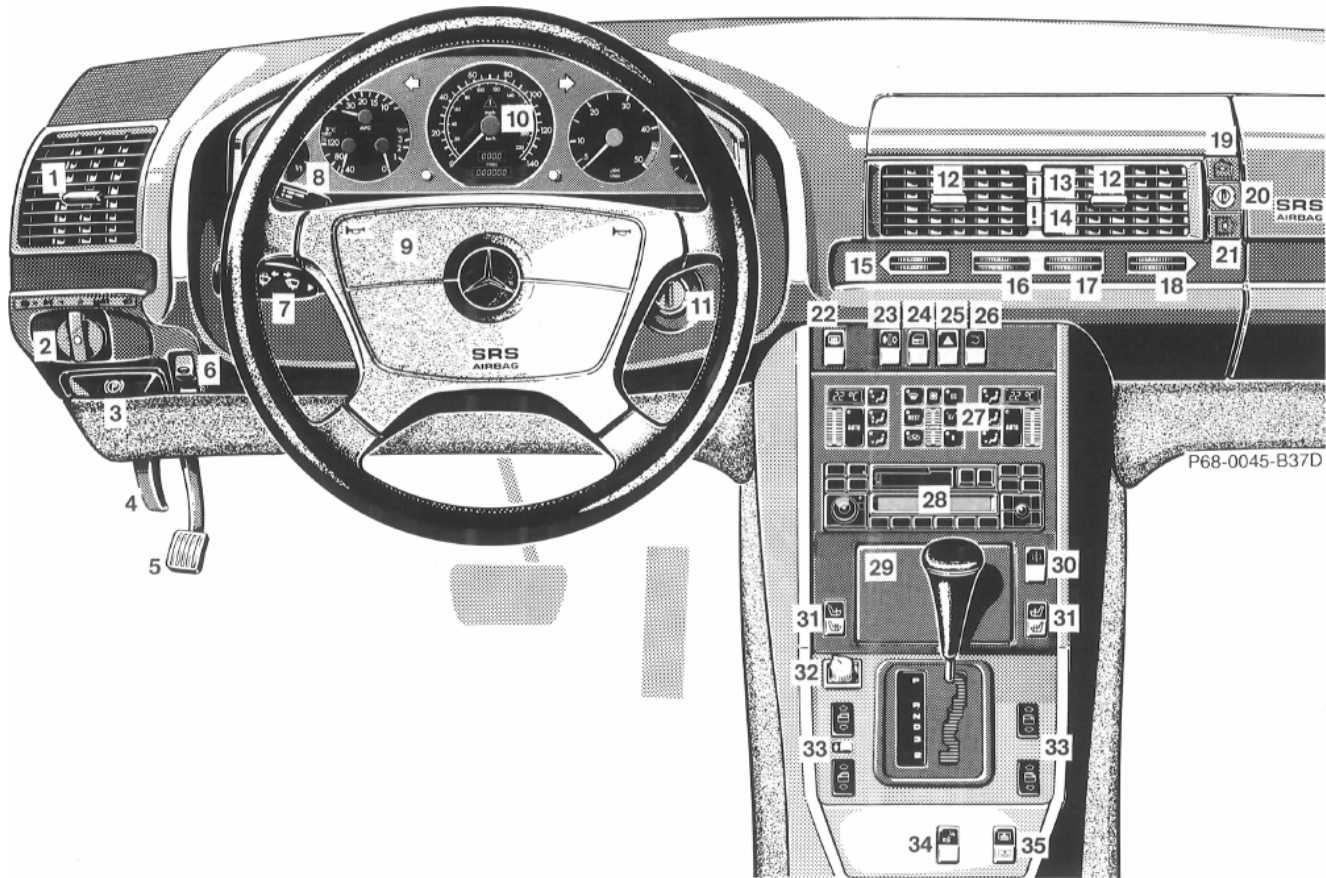

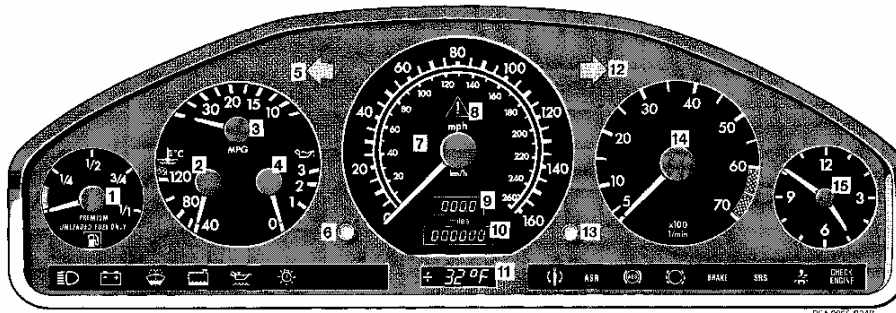

Instrument Cluster

- | | | | |
|---|--|----|--|
| 1 | Fuel gauge with reserve warning lamp (yellow). See Index | 9 | Trip odometer. See Index |
| 2 | Coolant temperature gauge. See Index | 10 | Main odometer. See Index |
| 3 | Fuel consumption gauge. See Index | 11 | Outside temperature indicator. See Index |
| 4 | Engine oil pressure gauge (bar). See Index | 12 | Right turn signal indicator lamp (green) See Index |
| 5 | Left turn signal indicator lamp (green). See Index | 13 | Knob for setting clock. See Index |
| 6 | Knob for instrument lamps and trip odometer. | 14 | Tachometer. See Index |
| 7 | Speedometer See Index | 15 | Clock. See Index |
| 8 | ETS warning lamp (yellow). See Index | | |

Indicator Lamp Symbols

Function Indicator Lamp



High beam



Preglow. See Index.

Warning Lamp

(should go out with the engine running unless)



ETS. Adjust driving to road condition.
See Index



Battery not being charged properly. See Index



Fluid level for windshield and headlamp washer system low. See Index.



Coolant level low. See Index.



Engine oil level low. See Index.



Exterior lamp failure. See Index.



ADS malfunction. See Index.



ETS malfunction. See Index.



ABS malfunction. See Index.



Brake pads worn down. See Index.



Brake fluid low (except Canada).
Parking brake engaged. See Index.



Brake fluid low (Canada only).
Parking brake engaged. See Index.



SRS malfunction. See Index.



Fasten seat belts. See Index.

Starting and Turning off the Engine

Starter Lock-Out

Important!

The engine can only be started, if the vehicle was unlocked from the outside.

Before Starting

Engage parking brake and move the selector lever to position "P" or "N".

Cold Engine

Turn key to steering lock position 2. Charge indicator and pre-glow indicator lamp should come on. The preglow process starts. When the preglow indicator lamp goes out, the engine is ready for starting.

Ambient temperatures above + 14 °F (-10 °C):

Do not depress accelerator. Turn key in steering lock clockwise to the stop. Release key only when the engine is firing regularly.

Ambient temperatures below + 14 °F(-10 °C):

Depress accelerator fully. Turn key in steering lock clockwise to the stop. Release key only when the engine is firing regularly and back off accelerator slowly.

Do not interrupt the starting process. If the engine is very cold, it is possible that it will fail to start on subsequent attempts.

At ambient temperatures below 0 °F (-18 °C), depress accelerator three times prior to starting.

Hot Engine

Turn key in steering lock clockwise to the stop and start engine immediately without depressing the accelerator.

Turning Off

Turn the key in the steering lock to position 0 to stop the engine.

The key can only be removed with the selector lever in position "P".

If the coolant temperature is very high (e.g. after hard driving on mountain roads), do not shut off the engine immediately, but allow it to run for 1-2 minutes at increased idle speed with selector lever in position "P" or "N".

Important!

Due to the installed starter non-repeat feature, the key must be turned completely to the left before attempting to start the engine again.

Observe the oil pressure gauge immediately after starting the engine. In a very cold engine the oil pressure will rise slowly. Do not speed up the engine before pressure is registered on the pressure gauge. If you do not see the gauge register oil pressure, stop the engine and have it checked.

The battery charge indicator lamp should go out as soon as the engine has started.

If the preglow indicator lamp fails to light up, or lights up while driving, the preglow system is defective and should be repaired at your authorized Mercedes-Benz dealer at the earliest possible date.

The engine is equipped with a block heater to provide reliable starting at temperatures below 0°F (-18°C). Refer to *Winter Driving* in Index.

Driving Instructions

Power Assistance

Warning!

When the engine is not running, the brake and steering systems are without power assistance. Under these circumstances, a much greater effort is necessary to stop or steer the vehicle.

Brakes

Caution!

When driving down long and steep grades, relieve the load on the brakes by shifting into "3" or "2". This helps prevent overheating of the brakes and reduces brake pad wear. Do not exceed engine speed limits. Refer to Technical Data for downshift points.

After hard braking, it is advisable to drive on for some time, rather than immediately parking, so the air stream will cool down the brakes faster.

Warning!

After driving in heavy rain for some time without applying the brakes or through water deep enough to wet brake components, the first braking action may be somewhat reduced and increased pedal pressure may be necessary. Be sure to maintain a safe distance from vehicles in front.

Resting your foot on the brake pedal will cause excessive and premature wear of the brake pads.

It can also result in the brakes overheating thereby significantly reducing their effectiveness. It may not be possible to stop the car in sufficient time to avoid an accident.

The condition of the parking brake system is checked each time the car is in the shop for the required maintenance.

All checks and maintenance work on the brake system should be carried out by an authorized Mercedes-Benz dealer.

If the parking brake is released and the brake warning lamp in the instrument cluster stays on, the brake fluid level in the reservoir is too low.

Brake pad wear or a leak in the system may be the reason for low brake fluid in the reservoir.

Have the brake system inspected at an authorized Mercedes-Benz dealer immediately.

Install only brake pads and brake fluid recommended by Mercedes-Benz.

Warning!

If other than recommended brake pads are installed, or other than recommended brake fluid is used, the braking properties of the vehicle can be degraded to an extent that safe braking is substantially impaired.

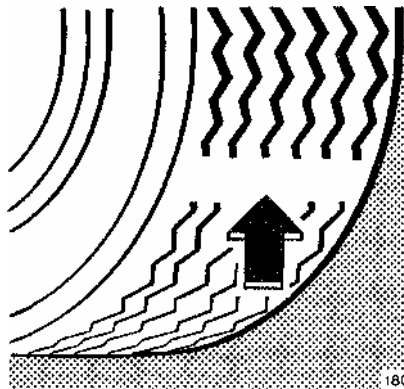

Tires

Tread wear indicators (TWI) are required by law. These indicators are located in six places on the tread circumference and become visible at a depth of approx. 1/16 in (1,5 mm), at which point the tire is considered worn and should be replaced.

The tread wear indicator appears as a solid band across the tread.

Warning!

Do not allow your tires to wear down too far. With less than 3 mm (1/8 in) of tread, the adhesion properties on a wet road are sharply reduced. Depending upon the weather and/or road surface (conditions), the tire traction varies widely.

Specified tire pressures must be maintained. This applies particularly if the tires are subjected to high loads (e.g. high speeds, heavy loads, high ambient temperatures).

Warning!

Do not drive with a flat tire. A flat tire affects the ability to steer or brake the vehicle. You may lose control of the car. Continued driving with a flat tire or driving at high speed with a flat tire will cause excessive heat build-up and possibly a fire, or tire blowout.

Aquaplaning

Depending on the depth of the water layer on the road, aquaplaning may occur, even at low speeds and with new tires. Reduce vehicle speed, avoid track grooves in the road and apply brakes cautiously in the rain.

Tire Traction

The safe speed on a wet, snow covered or icy road is always lower than on a dry road.

You should pay particular attention to the condition of the road whenever the outside temperatures are close to the freezing point.

Warning!

If ice has formed on the road, tire traction will be substantially reduced. Under such weather conditions, drive, steer and brake with extreme caution.

We recommend M + S radial-ply tires for the winter season for all four wheels to insure normal balanced handling characteristics. On packed snow, they can reduce

your stopping distance as compared with summer tires. Stopping distance, however, is still considerably greater than when the road is wet or dry,

Tire Speed Rating

Your vehicle is factory equipped with "H"-rated tires, which have a European speed rating of 130mph (210km/h).

Despite the tire rating, local speed limits should be obeyed. Use prudent driving speeds appropriate to prevailing conditions.

Warning!

Even when permitted by law, never operate a vehicle at speeds greater than the maximum speed rating of the tires.

Exceeding the maximum speed for which tires are rated can lead to sudden tire failure causing loss of vehicle control and resulting in personal injury and possible death.

Parking

Warning!

To reduce the risk of personal injury as a result of vehicle movement, before turning off the engine and leaving the vehicle always:

1. **Keep right foot on brake pedal.**
2. **Firmly depress parking brake pedal.**
3. **Move the selector lever to position "P".**
4. **Slowly release brake pedal.**
5. **Turn front wheels towards the road curb.**
6. **Turn the key to steering lock position 0 and remove.**

Important!

It is advisable to set the parking brake whenever parking or leaving the vehicle. In addition, move selector lever to position "P".

When parking on hills, always set the parking brake.

Winter Driving Instructions

The most important rule for slippery or icy roads is to drive sensibly and to avoid abrupt acceleration, braking and steering action. Do not use the cruise control system under such conditions.

When the vehicle is in danger of skidding, declutch, or in case of automatic transmission move selector lever to position "N". Try to keep the vehicle under control by corrective steering action.

Road salts and chemicals can adversely affect braking efficiency. Increased pedal force may become necessary to produce the normal brake effect. We therefore recommend depressing the brake pedal repeatedly when traveling on salt-strewn roads at length. This can bring road salt impaired braking efficiency back to normal. A prerequisite is, however, that this is possible without endangering other drivers on the road.

If the vehicle is parked after being driven on salt treated roads, the braking efficiency should be tested as soon as possible after driving is resumed while observing the safety rules in the previous paragraph.

Warning!

If the vehicle becomes stuck in snow, make sure that snow is kept clear of the exhaust pipe and from around the vehicle with engine running. Otherwise, deadly carbon monoxide (CO) gases may enter vehicle interior resulting in unconsciousness and death.

To assure sufficient fresh air ventilation, open a window slightly on the side of the car that is out of the wind.

Passenger Compartment

Warning!

Always fasten items being carried as securely as possible.

In an accident, during hard braking or sudden maneuvers, loose items will be thrown around inside the vehicle, and cause injury to vehicle occupants unless the items are securely fastened in the vehicle.

Operation

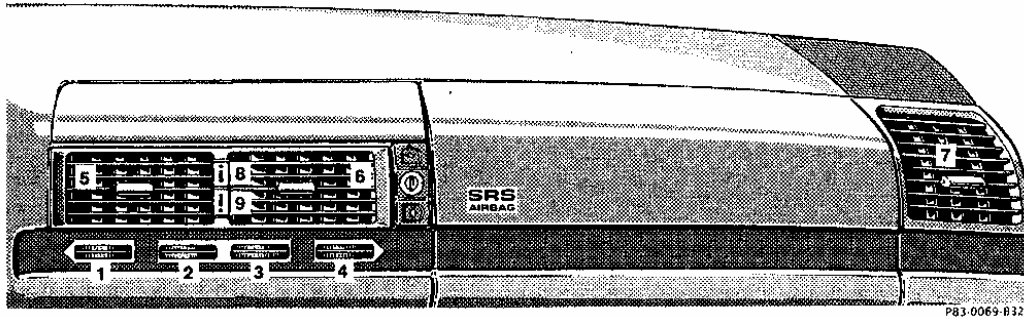

Air Outlets

- 1 Air volume control for left air outlet, turn left to open
- 2 Air volume control for left center air outlet, turn left to open
- 3 Air volume control for right center air outlet, turn left to open
- 4 Air volume control for right air outlet, turn left to open

- 5 Left center air outlet, adjustable
- 6 Right center air outlet, adjustable
- 7 Side air outlet, left and right, adjustable

Push-buttons for center air Outlets

- 8 Heated air supply (red indicator)
- 9 Non-heated/cooled air supply (blue indicator)

Basic mode:
None of the push-buttons (8 or 9) is pressed.

Dust Filter

Dust particles (down to a certain size) and pollen are filtered out before outside air enters the passenger compartment through the air distribution system.

Notes:

Do not obstruct the air flow by placing objects on the air flow-through exhaust slots below the rear window.

Also keep the air intake grille in front of windshield free of snow and debris.

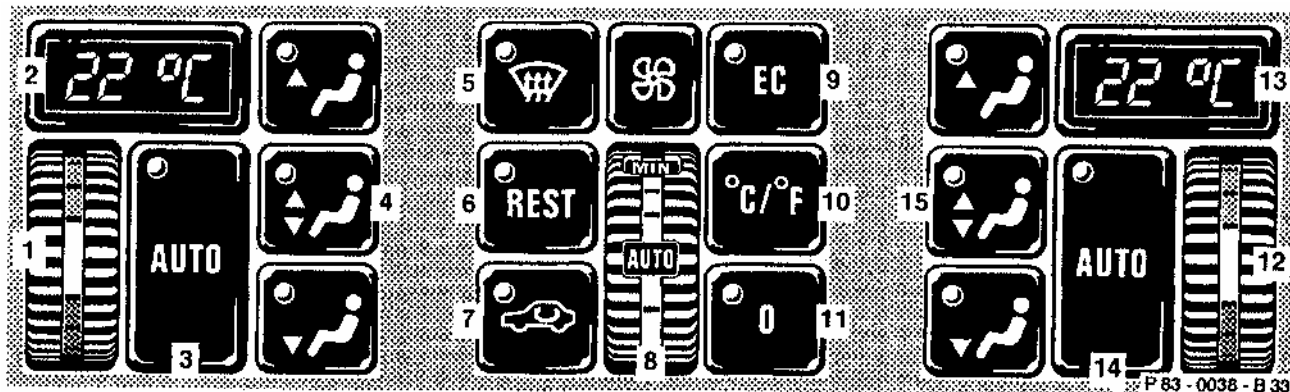

P 83 - 0038 - B 33

Automatic Climate Control

Left side passenger compartment:

- 1 Temperature selector
- 2 Temperature display
- 3 Automatic mode
- 4 Air distribution buttons

- 5 Defrost
- 6 Residual engine heat utilization
- 7 Air recirculation
- 8 Air volume selector
- 9 Economy
- 10 Selection switch
- 11 Off

Right side passenger compartment:

- 12 Temperature selector
- 13 Temperature display
- 14 Automatic mode
- 15 Air distribution buttons

The temperature selected with the temperature selector is reached as quickly as possible.

The temperature selector should be left at the desired temperature setting. With the center air outlets open and the system in heating mode, switch the outlets to non-heated/ cooled air by pressing the blue button (indicator lamp lights up).

With the center air outlets open and the system in cooling mode, switch the outlets to non-heated/ fresh air by pressing the red button (indicator lamp lights up).

The system will not heat or cool any quicker by setting a higher or lower temperature.

The automatic climate control only operates with the engine running. The automatic climate control removes considerable moisture from the air during operation in the cooling mode. It is normal for water to drip on the ground through ducts in the underbody.

1, 12 Temperature Selector

The desired interior temperature can be selected separately for the left and right side of the passenger compartment.

A basic setting in the white field of the selector is recommended, and can be used for driving year round.

The selected temperature can be shown in the display window (2) in either °F or °C.







3, 14 Automatic Mode

This is the normal setting.

Air volume and distribution are controlled automatically.

To select: Press  button (indicator lamp lights up).

To change selection:

Press, , , ,  or  button (indicator lamp of selected button lights up). The indicator lamp for  button goes out.

Note:

If the Automatic Climate Control is in the "Diagnosis Mode", turn key in steering lock to position 0 to return it to its normal operation.



5 Defrost

Maximum heated and automatically controlled amount of air is directed to the windshield and side windows. As the engine coolant temperature increases, the air volume is automatically increased, thereby defrosting as quickly as possible. Open and direct air outlets (7) towards the side windows.

Note:

Press  once again to return to previous setting.

Defogging Windows

Switch off,  or switch on  (left and right side), or switch 

Note:

To quickly defog the inside of the windshield, select the largest air volume and air distribution button 

6 Residual Engine Heat Utilization

With the engine switched off, it is possible to continue heating the interior for a short while. The rear passenger compartment air outlet must be closed.

Air volume and distribution are controlled automatically.

To select:

Turn key in steering lock to position 1 or 0 or remove key. Press  button (indicator lamp lights up). This function selection will not activate if the engine coolant temperature is below 40°C (105°F) or if the battery charge is insufficient.

To cancel:

- Press  button (indicator lamp goes out).
- Turn key in steering lock to position 2.

The system will automatically shut off

- after approx. 30 minutes,
- if the engine coolant temperature drops below 122°F (50 °C),
- if the battery voltage drops.

7 Air Recirculation

Outside air is not supplied to the car's interior.

This mode can be selected to prevent annoying odors or dust from entering the car's interior.

To select: Press  button (indicator lamp lights up).

To cancel:
Press  button (indicator lamp goes out).

The system will automatically switch from recirculated air to fresh air if button  is pressed

- after approx. 5 minutes at outside temperatures below approx. 40°F(5°C),
- after approx. 20 minutes, at outside temperatures above approx. 40°F(5°C).

If button  is pressed: after approx. 5 minutes.

Notes:

If the windows should fog up from the inside, switch from recirculated air back to fresh air.

At high outside temperatures, the system automatically engages the recirculated air mode thereby increasing the cooling capacity performance, switching to partially fresh air within 20 minutes.

8 Air Volume Selector

The air volume is automatically regulated in

AUTO = Normal setting
and all intermediate positions, except
when selecting

MIN = minimum air flow, MAX =
maximum air flow.

9 Economy **EC**

The function of this setting
corresponds to the automatic mode.
However, because the air conditioning
compressor will not engage (fuel
savings), it is not possible to air
condition in this setting.

11 Off **O**

The fresh air supply to the car interior
is shut off.

While driving, use this setting only
temporarily, otherwise the windshield
could fog up.

Important!

This vehicle is equipped with an air
conditioner system that uses HFC-
134a (ozone-friendly hydro-
fluorocarbon) as a refrigerant.

Repairs should always be performed
by a qualified technician, and
refrigerant should be collected in a
recovery system for recycling.

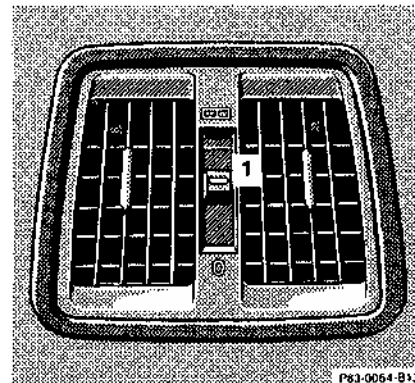

Rear Passenger Compartment Adjustable Air Outlet

Vehicles without rear passenger
compartment climate control.

Slide switch (1) up to open outlet for
fresh/cooled air only.

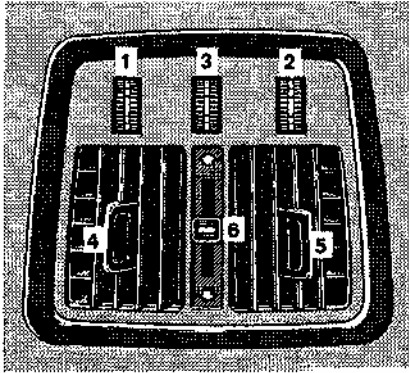

P83 0044 B13A

Rear Passenger Compartment Climate Control

- 1 Temperature selector, left side
- 2 Temperature selector, right side

A basic setting in the white field of the selector is recommended.

- 3 Air volume selector

The air volume can be varied continuously. The air flow is switched off with selector in position "0".

- 4 Adjustable air outlet, left side
- 5 Adjustable air outlet, right side
- 6 Air distribution slide
Top position: air flow from air outlets (4 and 5). Bottom position: air flow from air outlets beneath front seats.
Intermediate positions can be selected for a mixed air flow.

Note:

The rear passenger climate control does not operate with automatic climate control in **EC** mode or switched off with button **0**.

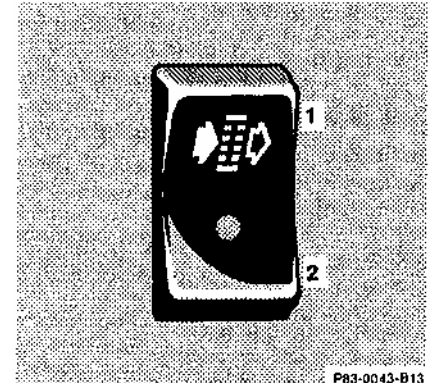

P83-0043-B13

Activated Charcoal Filter

- 1 Switch on
- 2 Switch off

An activated charcoal filter markedly reduces bad odors and removes pollutants from the air entering the passenger compartment. When pressing button **AC** or **EC**, the filter is also switched off.

Note:

The activated charcoal filter should be switched off when windows fog up on the inside, or if the passenger compartment needs to be quickly heated up or cooled down.

Car Keys

Included with your vehicle are

- 2 Master keys with infrared remote control
- 1 Master key
- 1 Valet key
- 1 Flat key

Infrared Remote Control with Folding Master Key

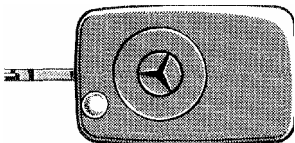

The master key fits all locks on the car.

To release the key, press button (1). The key unfolds from the holder by itself.

The transmitter for the infrared remote control is located in the key holder, the receivers are located in the door handles and next to the trunk lock.

Master Key

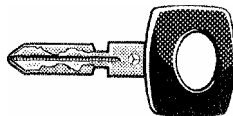

The master key fits all locks on the car.

Valet Key

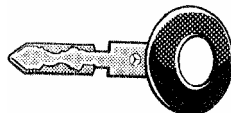

The valet key fits only the door locks and the steering lock.

The valet key will not fit the trunk lock or storage compartment eyeglasses compartment lock in the dashboard.

Flat Key

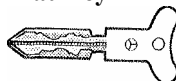

The flat key fits all locks on the car.

Notes:

Do not give the master key to an unauthorized person.

We recommend that you carry the flat key with you and keep it in a safe place (e.g. your wallet) so that it is always handy. Never leave the flat key in the vehicle.

Warning!

When leaving the vehicle always remove the key from the steering lock. Do not leave children unattended in the vehicle. Unsupervised use of vehicle equipment may cause serious personal injury.

Obtaining Replacement Keys

Your vehicle is equipped with a theft deterrent locking system requiring a special key manufacturing process. For security reasons, replacement keys can only be obtained from your authorized Mercedes-Benz dealer.

Infrared Remote Control Starter Lock-Out

Important!

Locking the vehicle activates the starter lock-out.

The engine can only be started, if the vehicle was unlocked from the outside.

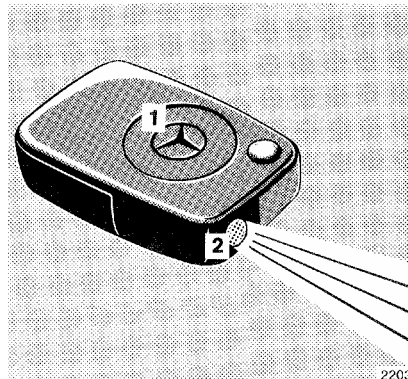

- 1 Transmit button
- 2 Transmitter eye and battery check

The vehicle can be centrally locked and unlocked, as well as the windows and sliding roof closed with infrared remote control.

The transmitter is located in the key holder, the receivers are located in the door handles and next to the trunk lock.

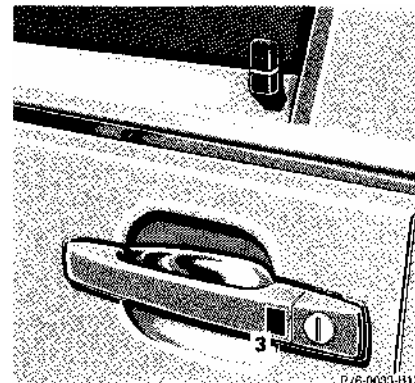

- 3 Receiver in door handle

Unlocking:

Aim transmitter eye (2) at a receiver (3) and press transmit button (1). Distance to receiver max. 20 ft (6 m).

The green indicator lamps on the receivers should blink. They stop blinking when the vehicle is unlocked.

Note:

If the trunk was previously locked separately, it will remain locked (see Index).

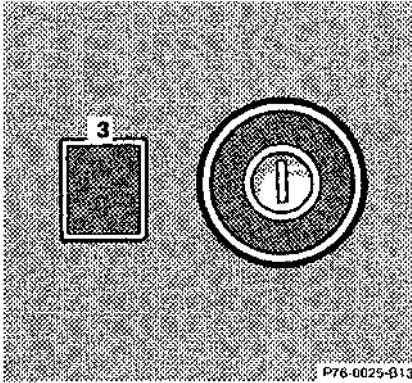

3 Receiver next to trunk lock

Locking:

Aim transmitter eye (2) at a receiver (3) and press transmit button (1).
Distance to receiver max. 20 ft (6 m).

The red indicator lamp on the receiver should blink. It stops blinking after approximately 3 seconds when the vehicle is properly locked.

Notes:

If a door or the trunk is not properly closed after you attempt to lock the vehicle by remote control, the red indicator lamps will continue to blink (max. 10 seconds). Open the door or trunk lid, close it properly, and lock the car again.

If the vehicle cannot be locked or unlocked by pressing the transmit button (1), then it may be necessary to change the batteries in the transmitter (if ok, battery indicator lamp in transmitter will light when transmitting) or to synchronize the system, see *Testing Infrared Remote Control* in Index.

Closing Windows and Sliding/ Pop-Up Roof from Outside

Continue to press transmit button (1) after locking car. Distance to receiver max. 20 ft. (6 m).

The windows and sliding/pop-up roof begin to close after approx. 1 second.

Warning!

Never close the windows or sliding/pop-up roof if there is the possibility of anyone being harmed by the closing procedure.

In case the closing procedure causes potential danger, the closing procedure can be immediately reversed by releasing and pressing the remote control button again until the green indicator lamp at the receiver blinks. The sliding/pop-up roof and windows will open again. The sliding/pop-up roof will only open if it was not fully closed.

Note:

If the side windows and sliding/ pop-up roof cannot be opened automatically by using the key or by pressing the transmit button of the infrared remote control (e.g. after a battery change), press  side of power window switch in center console until the window is completely closed and hold for additional 2 seconds. Repeat procedure for each window.

The automatic closing procedure of the windows and sliding/pop-up roof should now be restored.

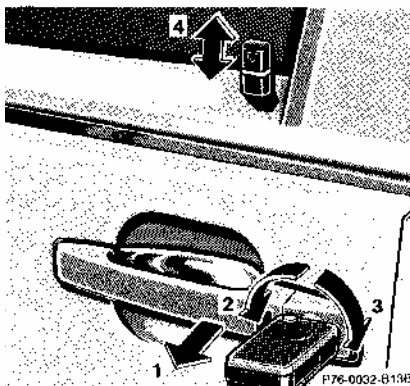

Central Locking System

The entire vehicle may be locked or unlocked by either using the master key in the door or trunk locks, or central locking switch located in center console. The central locking system also locks or unlocks the fuel filler flap.

Note:

If the fuel filler flap cannot be opened, refer to *Fuel Filler Flap, Manual Release* (see Index).

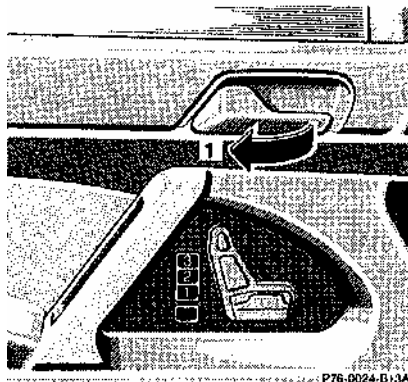

Starter Lock-Out

Important!

Locking the vehicle activates the starter lock-out.

The engine can only be started, if the vehicle was unlocked from the outside.

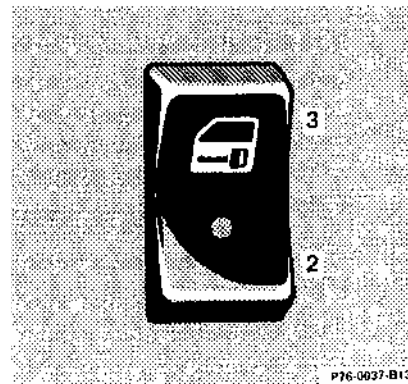

Central locking switch

Doors

- 1 Opening - pull handle
- 2 Unlocking
- 3 Locking
- 4 Individual door from inside:

- Push lock button down to lock.
- Pull lock button up to unlock.

When you lock the car, all door lock buttons should move down. If any one stays up, the respective door is not properly closed.

You should then unlock the car, open and reclose this door, and lock the car again. Each individual door can be locked with door lock button - the driver's door can only be locked when it is closed.

The doors can only be locked with the central locking switch, if the front doors are closed.

The doors cannot be unlocked with the central locking switch, if car was previously locked from outside.

When opening a front door, the entire car is unlocked, if it was previously locked with the central locking switch.

If the car has previously been locked from the outside, only the door being opened from the inside will unlock, the remaining doors, the trunk lid and fuel filler flap remain locked.

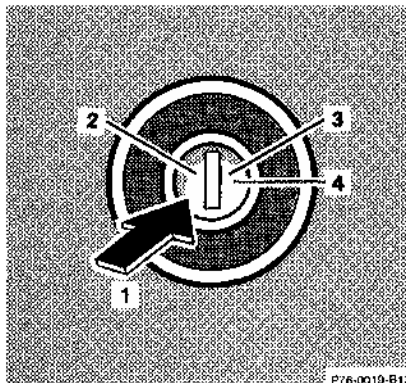

Trunk

- 1 Neutral position - push to open
- 2 Unlocking
- 3 Locking (detent)
- 4 Separate locking of trunk - remove key in this position.

When the trunk is separately locked, it remains locked when unlocking any door.

To deny any unauthorized person access to the trunk, lock it separately. Leave only the valet key with the vehicle.

Notes:

In case of a malfunction in the central locking system the doors and trunk can be locked and unlocked individually. To lock, turn key to position 3 or push down lock buttons.

To unlock, turn key to position 2 or pull up lock buttons.

The trunk lid can be lowered by using the recessed grips in the trunk lid liner, and closed with the dirt-free retracting handle.

If the trunk lid cannot be closed, refer to *Trunk Lid, Manual Closing* (see Index).

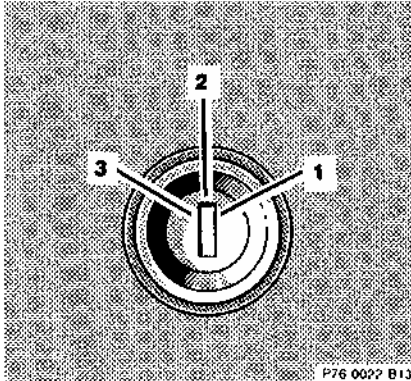

Door lock, left and trunk lock

Power Windows and Sliding/Pop-Up Roof

- 1 Closing
- 2 Interrupting
- 3 Opening

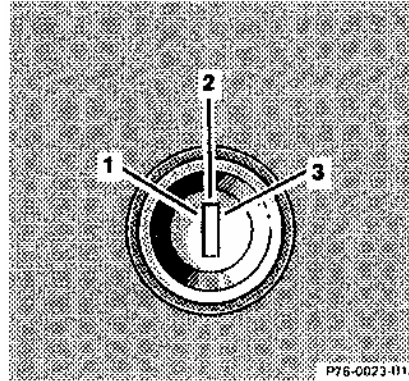

Door lock, right

When locking doors or trunk, turn key in door lock or trunk lock to position 1 and hold. The windows and the sliding/pop-up roof begin to close automatically after approximately 1 second.

To interrupt the closing procedure, turn key to position 2.

Warning!

Never close the windows or siding/pop-up roof if there is the possibility of anyone being harmed by the closing procedure.

In case the closing procedure causes potential danger, the closing procedure can be immediately reversed by turning the key to the unlocking position (3) within 10 seconds. The sliding/pop-up roof and windows will open again. The sliding/pop-up roof will only open if it was not fully closed.

Note:

If the closing procedure is interrupted, it can only be continued by first turning the key to the unlocked position (3) and then again to the locking position (1) and hold.

Power Closing Assist for Doors and Trunk Lid

The doors and trunk lid close automatically if:

- doors are pushed against the lock,
- trunk lid is lowered against the lock.

It is not necessary to slam doors or trunk lid closed, a pneumatic power-assisted mechanism will latch doors and trunk lid quietly and automatically once the lid or door has been brought to a close. When the pneumatic power-assisted mechanism has stopped, doors and/or trunk can be reopened.

Note:

If the trunk lid does not close, refer to *Trunk Lid, Manual Closing* in Index.

Warning!

To prevent possible personal injury, always keep hands and fingers away from the door or trunk opening when closing a door or the trunk lid. Be especially careful when small children are around.

The pneumatic power closing assist mechanism cannot be interrupted once it has been engaged.

To prevent personal injury, never activate the closing assist mechanism by tampering with the door or trunk lid latch.

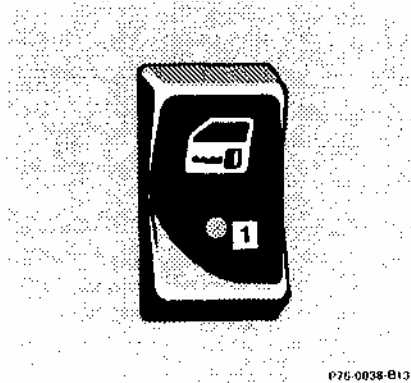

1 Indicator lamp in switch located in center console

Anti-Theft Alarm System

The anti-theft alarm is automatically armed or disarmed with any of your vehicle's keys or infrared remote control by locking or unlocking either front door or the trunk.

A blinking lamp (1) indicates that the alarm is armed.

The anti-theft alarm is disarmed when unlocking either front door or the trunk with any of your vehicle's keys or infrared remote control.

Operation:

Once the alarm system has been armed, the exterior vehicle lamps will flash and the horn will sound intermittently when someone:

- opens a door,
- opens the trunk,
- opens the hood,
- removes the radio,
- switches on or bridges the ignition circuit,
- steps on the brake pedal,

The alarm will last approximately 150 seconds in the form of blinking exterior lamps. At the same time an alarm horn will sound intermittently for 60 seconds, pause for 30 seconds, and repeat for another 60 seconds. The alarm will stay on even if the activating element (a door, for example) is immediately closed.

Note:

We recommend that you carry the flat key safely with you so that it is always handy. The flat key has the same functions as the master key.

Power Seats, Front

Warning!

Do not adjust the driver's seat while driving. Adjusting the seat while driving could cause the driver to lose control of the vehicle.

Never ride in a moving vehicle with the seat back reclined. Sitting in an excessively reclined position can be dangerous. You could slide under the seat belt in a collision. If you slide under it, the belt would apply force at the abdomen or neck. That could cause serious or even fatal injuries. The seat back and seat belts provide the best restraint when the wearer is in an upright position and belts are properly positioned on the body.

Never place hands under seat or near any moving parts while a seat is being adjusted.

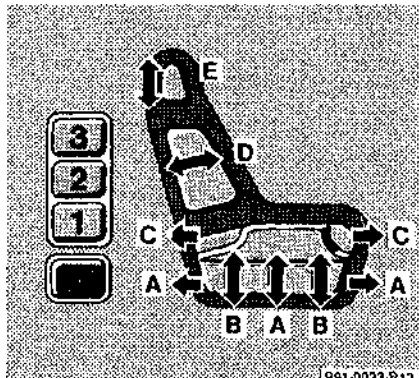

The slide switches are located in each front door.

Warning!

When leaving the vehicle always remove the key from the steering lock.

The power seats can also be operated with the driver's or front passenger door open. Do not leave children unattended in the vehicle. Unsupervised use of vehicle equipment may cause serious personal injury.

Turn key in steering lock to position 1 or 2 (with the driver's or front passenger's door open, the power seats can also be operated with the key removed or in steering lock position 0).

Seat and head restraint adjustment:

A Seat, fore/aft, up/down

B Seat tilt

C Seat cushion depth

D Backrest tilt

E Head restraint Adjust head restraint to support the back of the head approximately at ear level. The head restraint inclination can also be adjusted manually.

Note:

Your car is equipped with power head restraints, do not try to raise or lower them manually.

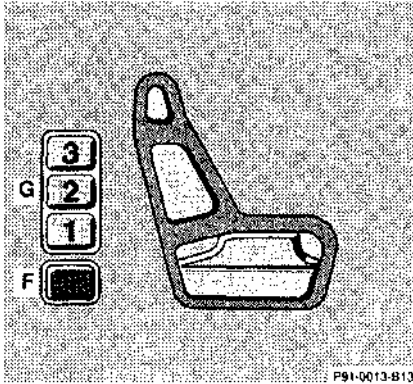

F Memory button

G Position buttons

Storing seat/head restraint/ steering wheel/exterior and inside rear view mirror positions in memory:

Three sets of seat/head restraint/ steering wheel/exterior and inside rear view mirror positions may be programmed into memory. After the seat/head restraint/steering wheel/ exterior and inside rear view mirrors are positioned, push memory button F, release, and within 3 seconds push position button "1". A second and third set of positions for the same seat/ head restraint/steering wheel/ exterior and inside rear view mirrors can be programmed into memory by pushing first button "F" and then "2", respectively "3".

Note:

See Index for instructions on adjustment of steering wheel and mirrors.

Recalling seat/head restraint/ steering wheel/exterior and inside rear view mirror positions stored in memory:

To recall a seat/head restraint/ steering wheel/exterior and inside rear view mirror position, push and hold position button "1", "2" or "3" until seat/head restraint/ steering wheel/exterior and inside rear view mirror movement has stopped. The seat/head restraint/ steering wheel/exterior and inside rear view mirror movement stops when the position button is released.

Caution!

Do not remove head restraints except when mounting seat covers. For removal and installation refer to *Head Restraints, Removal* in Index. Whenever restraints have been removed be sure to reinstall them before driving.

Important!

Bring seat backrest to upright position before recalling a stored seat/head restraint/steering wheel/exterior and inside rear view mirror position, otherwise the front seats could get forced against a rear seat and be damaged.

Prior to operating the vehicle, the driver should adjust the seat height for proper vision as well as fore/aft placement and seat back angle to insure adequate control, reach, operation, and comfort. The head restraint should also be adjusted for proper height.

Both the inside and outside rear view mirrors should be adjusted for adequate rearward vision.

Fasten seat belts. Infants and small children should be seated in a properly secured restraint system that complies with U.S. Federal Motor Vehicle Safety Standard 213 and Canadian Motor Vehicle Safety Standard 213.1.

All seat, head restraint, and rear view mirror adjustments as well as fastening of seat belts should be done before the vehicle is put into motion.

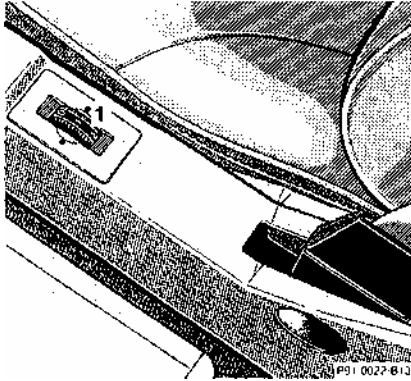

Lumbar Support

1 Pressure regulator

The seats have an inflatable air cushion built into the backrest to provide additional lumbar support.

The inflation pressure of the air cushion can be continuously varied between position "0" = without pressure, and position "5" = maximum pressure, by changing the pressure regulator (1) setting.

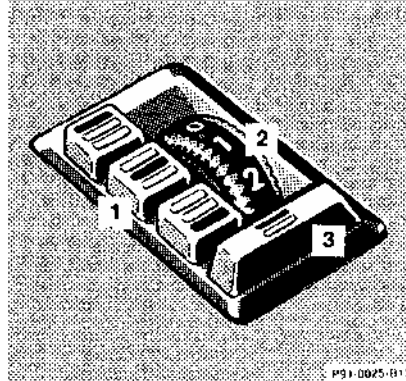

Multicontour Backrest

- 1 Bottom
- 2 Center
- 3 Top
- 4 Pressure regulator
- 5 Side bolster adjustment

Some models may be equipped with orthopedic seats. These seats have inflatable air cushions built into the backrest to provide additional lumbar and side support.

The amount of cushion height and curvature may be adjusted after turning the key in steering lock to position 2.

The center section (2) can be selected together with bottom section (1) or top section (3).

The inflation pressure of the air cushion can be continuously varied between position "0" = without pressure, and position "5" = maximum pressure, by changing the pressure regulator (2) setting.

The side bolsters of the backrest can be adjusted with push button (3):

- pushing forward -increase side support,
- pushing backward -decrease side support.

If the engine is turned off, the last cushion setting is retained in memory, and automatically adjusts the cushion to this setting when the engine is restarted.

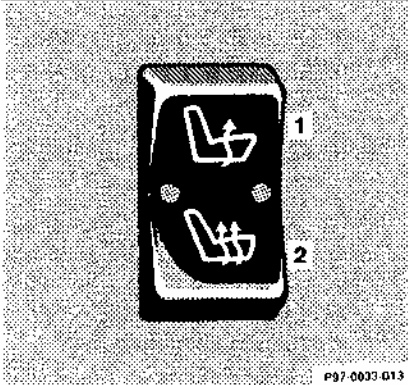

Heated Seats

The front seat heater switches are located to the left and right side of the center console ashtray.

The rear seat heater switches are located in each rear door.

The front seat heaters can be switched on with the key in steering lock positions 1 or 2, the rear seat heaters only in steering lock position 2.

Press switch to turn on heater:

- 1 Normal heating mode. One indicator lamp in the switch lights up.
- 2 Rapid heating mode. Both indicator lamps in the switch light up.

After approximately 5 minutes in the rapid heating mode, the heater automatically switches to normal operation and only one indicator lamp will stay on.

Turning off heater:

If one indicator lamp is on, press upper half of switch.

If both indicator lamps are on, press lower half of switch.

If left on, the heater automatically turns off after approximately 30 minutes of operation.

Note:

When in operation, the seat heater consumes a large amount of power. It is advisable not to use the seat heater longer than necessary.

The seat heaters may automatically switch off if too many power consumers are switched on at the same time, or if the battery charge is low. When this occurs, the indicator lamp in the switch will blink (both indicator lamps blink during rapid seat heating). The seat heaters will switch on again automatically as soon as sufficient voltage is available.

If the blinking of the indicator lamps is distracting to you, the seat heaters can be switched off.

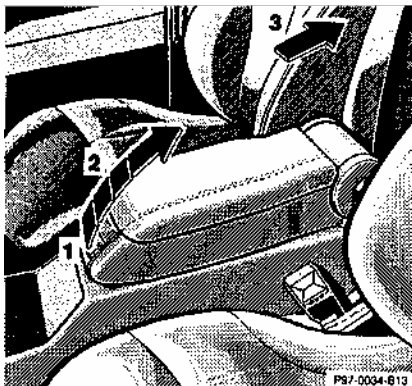

**Armrest with Compartment
for Telephone Handset**
(Front Seats)

- 1 Armrest folded down
- 2 Normal use
(3 comfort positions)
- 3 Armrest folded up

Folding down:

Raise armrest past top comfort position and push down.

Adjusting height:

Raise armrest to desired position.

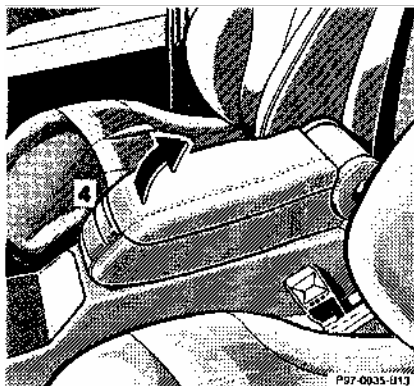

Press button (4) to open cover

Warning!

The armrest does not suffice as a child restraint system. In case of a frontal collision a child can be catapulted forward over the locked armrest. Infants and small children should always be seated in a properly secured restraint system that complies with U.S. Federal Motor Vehicle Safety Standard 213 and Canadian Motor Vehicle Safety Standard 213.1.



P07-0010-B13

Armrest with Integrated Storage Compartment (Rear Bench Seat)

Pull down the armrest by its strap. Before storing the armrest in the backrest, close its storage compartment lid.

For the removal of the *Rear Seat Cushion*, see Index.

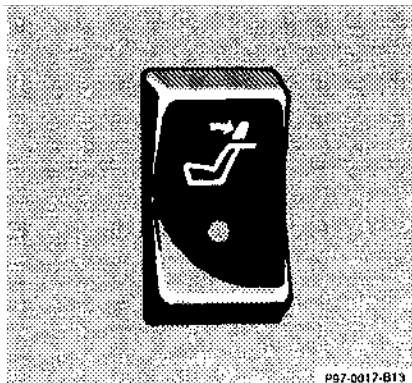

P97-0017-B13

Head Restraints, Rear

(Vehicles without rear power seats)

Turn key in steering lock to position 1 or 2.

Press symbol-side of rocker switch to release the head restraints. The head restraints will then fold backward for increased visibility.

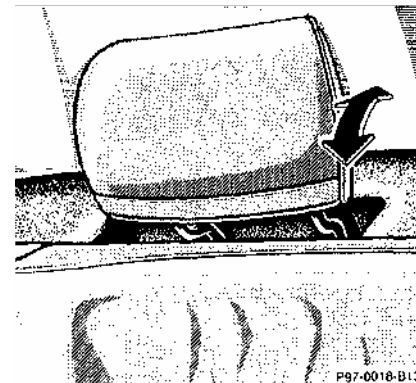

P97-0018-B13

Placing head restraints upright: Pull head restraint forward by its strap until it locks in position. Inclusion of head restraints: The head restraint inclination can be adjusted manually.

Important!

For safety reasons, always drive with the rear head restraints in the upright position when the rear seats are occupied.

Keep area around head restraints clear of articles (e.g. clothing) to not obstruct the folding operation of the head restraints.



P46 0005 B1J

Adjustable Steering Wheel

Turn key in steering lock to position 1 or 2 (with the driver's or front passenger's door open, the steering wheel can also be operated with the key removed or in steering lock position 0).

To lengthen or shorten the steering column, push in or pull out switch (1). To raise or lower steering wheel, push switch (1) up or down.

Note:

The steering wheel position can be stored in memory together with the seat/head restraint/exterior and inside rear view mirror positions, see Index.

Warning!

Do not adjust the steering wheel while driving. Adjusting the steering wheel while driving could cause the driver to lose control of the vehicle.

Seat Belts and Supplemental Restraint System (SRS)

Your vehicle is equipped with lap-shoulder seat belts, emergency tensioning retractors for the seat belts, driver airbag and knee bolster and passenger airbag and knee bolster.

Seat Belts

Important!

Laws in most states and all Canadian provinces require seat belt use.

All states and provinces require use of child restraints that comply with U.S. Federal Motor Vehicle Safety Standard 213 and Canadian Motor Vehicle Safety Standard 213.1.

We strongly recommend their use.

Warning!

Never ride in a moving vehicle with the seat back reclined. Sitting in an excessively reclined position can be dangerous. You could slide under the seat belt in a collision. If you slide under it, the belt would apply force at the abdomen or neck. That could cause serious or even fatal injuries. The seat back and seat belts provide the best restraint when the wearer is in an upright position and belts are properly positioned on the body.

Seat Belt Warning System

With the key in steering lock position 2, a warning sounds for a short time if the driver's seat belt is not fastened.

Warning!

Failure to wear and properly fasten and position your seat belt greatly increases your risk of injuries and their likely severity in an accident. You and your passengers should always wear seat belts.

If you are ever in an accident, your injuries can be considerably more severe without your seat belt properly buckled. Without your seat belt buckled, you can hit the interior of the vehicle or be ejected from it. You can be seriously injured or killed.

In the same crash, the possibility for injury or death is lessened with your seat belt buckled.

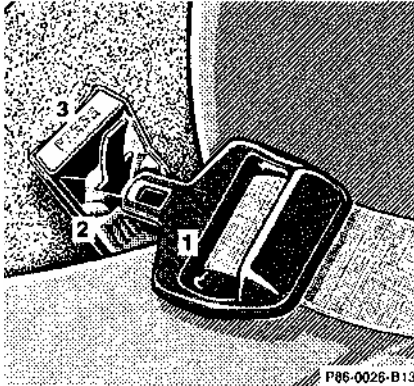

- 1 Latch plate
- 2 Buckle
- 3 Release button

Fastening of Seat Belts

Push latch plate (1) into buckle (2) until it clicks.

The lap belt should be positioned as low as possible on your hips and not across the abdomen.

Three-point seat belt:

Tighten the lap portion to a snug fit by pulling shoulder portion up.

Rear center seat belt: Tighten to a snug fit by feeding belt toward retractor.

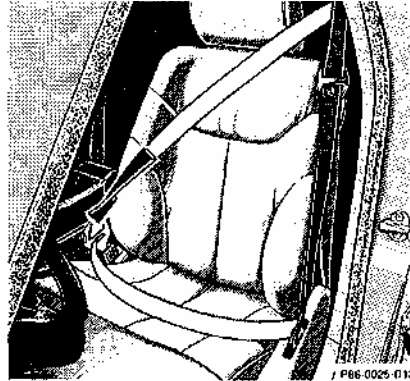

Adjust seat belt so that shoulder portion is located as close as possible to the middle of your shoulder. Do not twist the belt.

The shoulder portion of the seat belt must be pulled snug and checked for snugness immediately after engaging it. The height setting for the shoulder portion of the front seat belts are automatically adjusted by the fore/ aft movement of the front seat.

Seat moved to front: Belt outlet fully lowered.

Seat moved to rear: Belt outlet fully raised.

For safety reasons, avoid adjusting the seat or seat back into positions which could affect the correct seat belt position.

Unfastening of Seat Belts

Push the release button (3) in the belt buckle (2).

Allow the retractor to completely rewind the seat belt by guiding the latch plate (1).

Notes:

The rear seat belt buckles can be stored in the space next to the rear armrest (to the left and right of armrest). The rear center seat belt should be latched and stored under the armrest.

For cleaning and care of the seat belts, see *Cleaning and Care of the Vehicle* in Index.

Operation:

The inertia reel stops the belt from unwinding during sudden vehicle stops or when quickly pulling on the belt.

The locking function of the reel may be checked by quickly pulling out the belt.

Warning!

USE SEAT BELTS PROPERLY.

- Each occupant should wear their seat belt at all times, because seat belts help reduce the likelihood of and potential severity of injuries in accidents, including rollovers. "SRS" (driver airbag, passenger airbag), "ETR" (seat belt emergency tensioning retractors), and knee bolsters are designed to enhance the protection offered to properly belted occupants in certain frontal impacts which exceed preset deployment thresholds.
- Improperly positioned seat belts do not provide maximum protection and may cause serious injuries in case of an accident.
- Never wear the shoulder belt under your arm, against your neck or off your shoulder. In a crash, your body would move too far forward.

That would increase the chance of head and neck injuries. The belt would also apply too much force to the ribs or abdomen, which could severely injure internal organs such as your liver or spleen.

- Position the lap belt as low as possible on your hips and not across the abdomen. If the belt is positioned across your abdomen, it could cause serious injuries in a crash.
- Each seat belt should never be used for more than one person at a time. Do not fasten a seat belt around a person and objects.
- Belts should not be worn twisted. In a crash, you wouldn't have the full width of the belt to take impact forces. The twisted belt against your body could cause injuries.

- Pregnant women should also use a lap-shoulder belt. The lap belt portion should be positioned as low as possible on the hips to avoid any possible pressure on the abdomen.

USE CHILD RESTRAINTS PROPERLY.

- Infants and small children must be seated in an infant or child restraint system, which is properly secured by a lap belt or lap belt portion of a lap-shoulder belt. Children could be endangered in an accident if their child restraints are not properly secured in the vehicle.
- Rear-facing child restraints must not be used in the front seat. They could be struck by the airbag when it inflates in a crash. If this happens, a child in the restraint could be seriously or fatally injured.

- **According to accident statistics, children are safer when properly restrained in the rear seating positions than in the front seating positions.**
- **Children too big for child restraint systems should ride in rear seats using regular seat belts. Position shoulder belt across chest and shoulder, not face or neck. A booster seat may be necessary to achieve proper belt positioning.**
- **Adjust the front passenger seat as far as possible rear ward from the dashboard when a child restraint is installed.**

Supplemental Restraint System (SRS)

The SRS uses two crash severity levels (thresholds) to activate either the ETR or airbag or both. Activation depends on exceeding the thresholds and fastening of the seat belt.

Seat belt fastened

- first threshold exceeded: ETR activates
- second threshold exceeded: airbag also activates

Seat belt not fastened

- first threshold exceeded: airbag activates, but not ETR

Driver and front passenger systems operate independently from each other

Emergency Tensioning Retractor (ETR)

The seat belts are equipped with emergency tensioning retractors. These tensioning retractors are located in each belt's inertia reel and become operationally ready with the key in steering lock position 1 or 2.

The emergency tensioning retractors are designed to activate only when the seat belts are fastened during major frontal impacts within the shaded area shown. They tighten the belts in such a way that they fit more snugly against the body, restricting its forward movement as much as possible. In cases of other frontal impacts, roll-overs, certain side impacts, rear collisions, or other accidents without frontal forces, the emergency tensioning retractors will not be activated. The driver and passenger will then be protected by the fastened seat belts and inertia reel in the usual manner.

For seat belt and emergency tensioning retractor safety guidelines, see *Safety Guidelines* in Index.

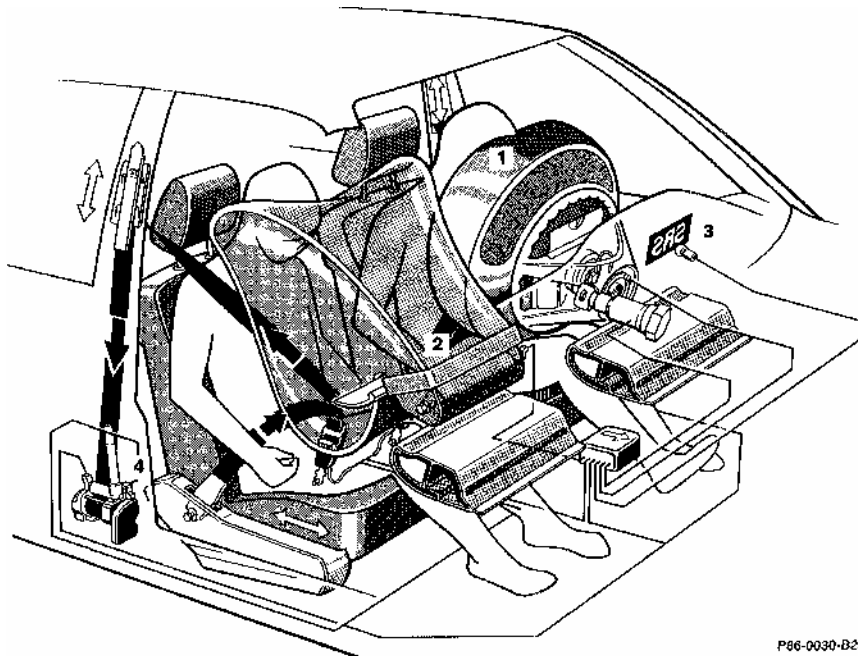

P86-0030-B25

Airbags

The most effective occupant restraint system yet developed for use in production vehicles is the three point seat belt. In some cases, however, the protective effect of a seat belt can be further enhanced by an airbag.

The driver airbag (1) is located in the steering wheel hub. The passenger airbag (2) is located in the dashboard ahead of the passenger. In conjunction with wearing the seat belts with emergency tensioning retractors (4), they provide increased protection for the driver and passenger.

The operational readiness of the airbag system is verified by the indicator lamp "SRS" (3) in the instrument cluster. If no fault is detected, the lamp will go out after approximately 4 seconds; after the lamp goes out, the system continues to monitor the components and circuitry of the airbag system and will indicate a malfunction by coming on again.

The following system components are monitored or undergo a self-check: crash-sensor, airbag ignition circuits, driver and passenger seat belt buckles. Initially, when the key is turned from steering lock position 0 to positions 1 or 2, malfunctions in the crash-sensor are detected and indicated (the "SRS" indicator lamp stays on longer than 4 seconds).

In the operational mode, after the indicator lamp has gone out following the initial check, interruptions and short circuits in the airbag ignition circuit and in the driver and passenger seat belt buckle harnesses, and low voltage in the entire system are detected and indicated.

In the event a malfunction of the "SRS" is indicated as outlined above, the "SRS" may not be operational. We strongly recommend that you visit an authorized MERCEDES-BENZ dealer immediately to have the system checked; otherwise the "SRS" may not be activated when needed.

Important!

The airbags are designed to activate only in certain frontal and front-angled impacts (within the shaded area shown in the illustration on page 44). Only during these types of impacts will they provide their supplemental protection. The driver and passenger should always wear the seat belts; otherwise it is not possible for the airbags to provide their intended supplemental protection.

In cases of other frontal impacts, roll-overs, certain side impacts, rear collisions, or other accidents without frontal forces, the airbag will not be activated. The driver and passengers will then be protected by the fastened seat belts.

We caution you not to rely on the presence of an airbag in order to avoid wearing your seat belt.

Important!

The "SRS" is designed to reduce the potential of injury in certain frontal and front-angled impacts which may cause injuries; however, no system available today can totally eliminate injuries and fatalities.

The activation of the "SRS" temporarily releases a small amount of dust from the air-bags. This dust, however, is neither injurious to your health, nor does it indicate a fire in the vehicle.

The service life of the airbags extends to the date indicated on the label located on the driver-side door latch post. To provide continued reliability after that date, they should be inspected by an authorized MERCEDES-BENZ dealer at that time and replaced when necessary.

Warning!

It is very important for your safety to always be in a properly seated position.

For maximum protection in the event of a collision always be in normal seated position with your back against the seat back. Fasten your seat belt and ensure that it is properly positioned on the body.

Since the airbag inflates with considerable speed and force, a proper seating position will keep you in a safe distance from the airbag:

- Sit properly belted in an upright position with your back against the seat back.
- Adjust the driver seat as far as possible rearward, still permitting proper operation of vehicle controls.

- Do not lean with your head or chest close to the steering wheel or dashboard.
- Adjust the passenger seat as far as possible rearward from the dashboard, especially when a child restraint is installed.
- Infants and small children should only be seated in an infant or child restraint which is properly secured by the seat belt.
- Rear-facing child restraints must not be used in a front seat.

Failure to follow these instructions can result in severe injuries to you or other occupants.

Safety Guidelines for the Seat Belt, Emergency Tensioning Retractor and Airbag

Warning!

- **Damaged belts or belts that were highly stressed in an accident must be replaced and their anchoring points must also be checked. Use only belts installed or supplied by an authorized Mercedes-Benz dealer.**
- **Do not pass belts over sharp edges.**
- **Do not make any modification that could change the effectiveness of the belts.**
- **The "SRS" is designed to function on a one-time-only basis. An airbag or emergency tensioning retractor (ETR) that was activated must be replaced.**
- **No modifications of any kind may be made to any components or wiring of the "SRS". This includes the installation of additional trim material, badges etc. over the steering wheel hub or front passenger airbag cover and installation of additional electrical/electronic equipment on or near "SRS" components and wiring.**
- **An airbag system component within the steering wheel gets hot after the airbag has inflated.**
- **Improper work on the system, including incorrect installation and removal, can lead to possible injury through an uncontrolled activation of the "SRS".**
- **In addition, through improper work there is the risk of rendering the "SRS" inoperative. Work on the "SRS" must therefore only be performed by an authorized Mercedes-Benz dealer.**
- **When scrapping the airbag unit or emergency tensioning retractor, it is mandatory to follow our safety instructions. These instructions are available at your authorized Mercedes-Benz dealer.**

When you sell the vehicle we strongly urge you to give notice to the subsequent owner that it is equipped with an "SRS" by alerting him to the applicable section in the Owner's Manual.

Infants and Child Restraint Systems

We recommend that all infants and children be restrained at all times while the vehicle is in motion.

Important!

The use of infant or child restraints is required by law in all 50 states and all Canadian provinces.

Infants and small children should be seated in an infant or child restraint system, which is properly secured by the lap belt portion of the lap-shoulder belt, and that complies with U.S. Federal Motor Safety Standard 213 and Canadian Motor Vehicle Safety Standard 213.1.

A statement by the child restraint manufacturer of compliance with this standard can be found on the instruction label on the restraint and in the instruction manual provided with the restraint.

When using any infant or child restraint system, be sure to carefully read and follow all manufacturer's instructions for installation and use.

Warning!

According to accident statistics, children are safer when properly restrained in the rear seating positions than in the front seating positions.

Rear-facing child restraints must not be used in the front passenger seat. They could be struck by the airbag when it inflates in a crash. If this happens, a child in the restraint could be seriously or fatally injured.

Infants and small children should never be held on the lap while the vehicle is in motion. During an accident they would be almost impossible to hold, and could be crushed between the adult and the dashboard.

Infants and small children should never share a seat belt with another occupant. During an accident, they could be crushed between the occupant and seat belt.

Children too big for child restraint systems should ride in rear seats using regular seat belts. Position shoulder belt across chest and shoulder, not face or neck. A booster seat may be necessary to achieve proper belt positioning.

When the child restraint is not in use, remove it from the car or secure it with the seat belt to prevent the child restraint from becoming a projectile in the event of an accident.

U.S.A. Models only:

Since 1986 all U.S. child restraints comply with U.S. regulations without the use of a tether strap.

Canada Models only:

This vehicle is provided with tether anchorages for a top tether strap. Consult your authorized Mercedes-Benz dealer for installation of these anchorages.

In compliance with Canadian Motor Vehicle Safety Standard 210.1, child restraint tether anchorage hardware is attached to the tool kit located in the trunk.

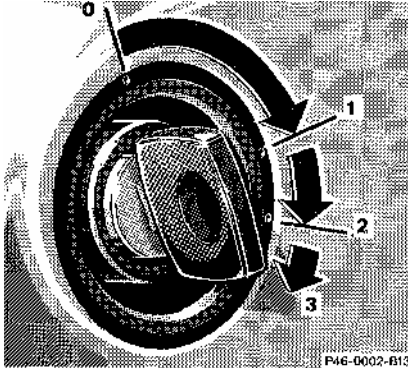

Steering Lock

- 0 The key can be withdrawn in this position only. The steering is locked with the key removed from the steering lock. The key can be removed only with the selector lever in position "P". After removing the key or with the key in steering lock position 0, the selector lever is locked in position "P".

- 1 Steering is unlocked.
(If necessary, move steering wheel slightly to allow the key to be turned clockwise to position 1.)

Most electrical consumers can be operated. For detailed information see respective subjects.

- 2 Driving position.
3 Starting position.

Refer to Index for *Starting and turning off the engine*.

Warning!

When leaving the vehicle always remove the key from the steering lock. Do not leave children unattended in the vehicle. Unsupervised use of vehicle equipment may cause serious personal injury.

Notes:

A warning sounds when the driver's door is opened with the key in steering lock position 1 or 0.

With the engine at idle speed, the charging rate of the alternator (output) is limited.

It is therefore recommended to turn off unnecessary electrical consumers while driving in stop-and-go traffic. This precaution helps to avoid draining of the battery.



Unnecessary strain on the battery and charging system may be minimized by turning off the following power consumers, for example: Heated seats, rear window defroster. In addition, the automatic climate air volume control should be set to "MIN".

Caution!

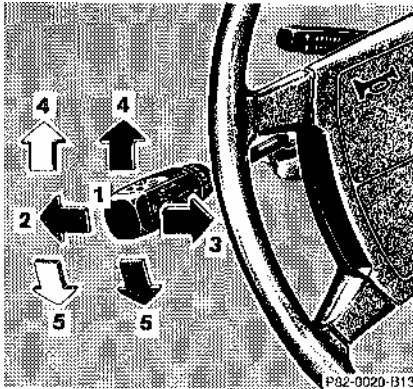
To prevent accelerated battery discharge and a possible dead battery, always remove the key from the steering lock. **Do not** leave the key in steering lock position 0.



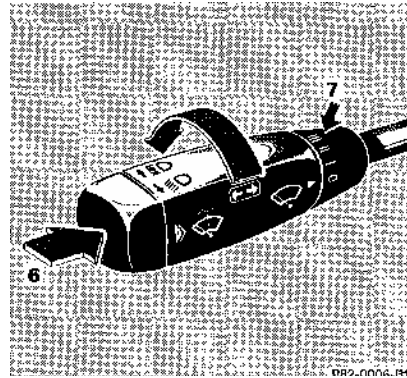

Combination Switch

- 1 Low beam (exterior lamp switch position )
- 2 High beam (exterior lamp switch position )
- 3 High beam flasher (high beam available independent of exterior lamp switch position)
- 4 Turn signals, right
- 5 Turn signals, left



- 6 Press switch briefly:
One wipe without washer water (select only if window is wet) Press switch past resistance point:

Windshield washer, windshield wiper; headlamp cleaning system (only in exterior lamp switch positions  or  Canada only: also in position when the engine is running)

- 7 Windshield wiper
 - 0 Wiper off
 - I Intermittent wiping
 - II Normal wiper speed
 - III Fast wiper speed

Note:

The windshield washer reservoir, hoses and nozzles are automatically heated.

To signal minor directional changes, such as changing lanes on a highway, move combination switch to the point of resistance only and hold it there.

To operate the turn signals continuously, move the combination switch past the point of resistance (up or down). The switch is automatically canceled when the steering wheel is turned to a large enough degree.

Windshield Washer Fluid Mixing Ratio

For temperatures above freezing:

MB Windshield Washer Concentrate "S" and water

1 part "S" to 100 parts water (40 ml "S" to 1 gallon water).

For temperature below freezing:

MB Windshield Washer Concentrate "S" and commercially available

premixed windshield washer solvent/antifreeze

1 part "S" to 100 parts solvent (40 ml "S" to 1 gallon solvent).

Windshield Wiper Smears

If the windshield wiper smears the windshield, even during rain, activate the washer system as often as necessary. The fluid in the washer reservoir should be mixed in the correct ratio.

Blocked Windshield Wiper

If the windshield wiper becomes blocked (for example, due to snow), switch off the wiper motor.

For safety reasons before removing ice or snow, remove key from steering lock. Remove blockage.

Activate combination switch again (key in steering lock position 1).

Emergency Operation of Windshield Wiper

In case of windshield wiper malfunction, turn combination switch to wiper setting II.

Have the system checked at your authorized MERCEDES-BENZ dealer as soon as possible.

Signaling Turns with Hazard Warning Flasher in Use

For example, when the vehicle is being towed (key in steering lock turned to position 2):

With hazard warning flasher on, activate combination switch for left or right turn signal - only the selected turn signal will blink.

Upon canceling the turn signal, the hazard warning flasher will operate again.

Turn Signal Failure

If one of the turn signals fails, the turn signal indicator system flashes and sounds at a faster than normal rate. In addition, the exterior lamp failure indicator will come on.

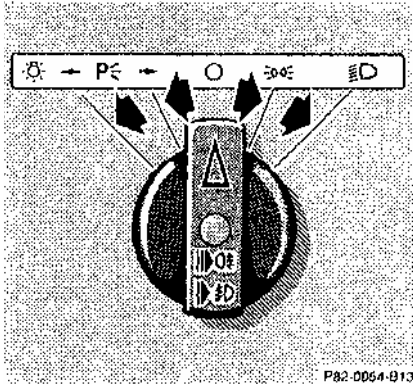









Exterior Lamp Switch

Canada only:

When the engine is running, the low beam (includes parking lamps, side marker lamps, taillamps, license plate lamps and instrument panel lamps) are automatically switched on.

Note:

For nighttime driving the exterior lamp switch should be turned to position ID to  permit activation of the high beam headlamps.

-  Off
-  Parking lamps (also side marker lamps, taillamps, license plate lamps, instrument panel lamps)
Canada only: When the engine is running, the low beam is additionally switched on.
-  Parking lamps plus low beam or high beam headlamps (combination switch pushed forward)
-  Standing lamps, right (turn left one stop)
-  Standing lamps, left (turn left two stops)
-  Fog lamps (pull out one stop) with parking and/or headlamps on
-  Rear fog lamp (pull out to 2nd detent) in addition to fog lamps. Indicator lamp in lamp switch comes on.

Standing Lamps

When the vehicle is parked on the street the standing lamps (right or left side parking lamps) can be turned on, making the vehicle more visible to passing vehicles.

The standing lamps cannot be operated with the key in steering lock position 2.

Note:

With the key removed and a front door open, an audible warning will sound if the vehicle's exterior lamps (except standing lamps) are not switched off. Fog lamps will operate with the parking lamps and the low or high beam headlamps. Fog lamps should only be used in conjunction with low beam headlamps. Consult your state Motor Vehicle Regulations regarding allowable lamp operation.

Fog lamps are automatically switched off when the exterior lamp switch is turned to position O .

Inside and Exterior Rear View Mirrors

Inside Rear View Mirror

The mirror is electrically adjustable.

Use your inside mirror to determine the size and distance of objects seen in the passenger side convex mirror.

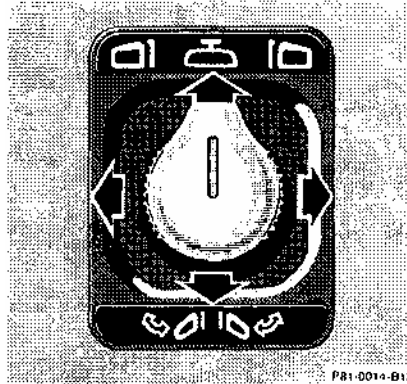

The switch is located on the center console.

Turn key in steering lock to position 2 (with either front door open, the mirror can be operated with key removed or in steering lock position 0 or 1).

Turn switch to position . To adjust, move the switch forward, backward or to either side.

Antiglare Night Position

With the key in steering lock position 2, the mirror reflection brightness responds to changes in light sensitivity.

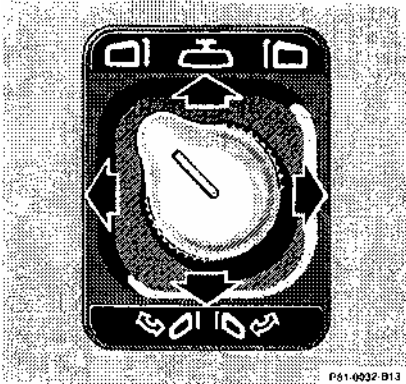

Exterior rear view mirror, left
Exterior rear view mirror, right

Exterior Rear View Mirrors

Turn key in steering lock to position 2 (with either front door open, the mirrors can be operated with key removed or in steering lock position 0 or 1).

Turn switch to select the mirror to be adjusted.

To adjust, move the switch forward, backward or to either side.

Note:

The exterior mirrors have electrically heated glass. The heater switches on automatically, depending on outside temperature.

If an exterior mirror housing is forcibly pivoted from its normal position, it must be repositioned by applying firm pressure until it snaps into place.

Warning!

Exercise care when using the passenger-side mirror. The passenger-side exterior mirror is convex (outwardly curved surface for a wider field of view). Objects in mirror are closer than they appear. Check your inside rear view mirror or glance over your shoulder before changing lanes.

Exterior Rear View Mirror Multiple Images

This vehicle is equipped with anti-fogging dual-pane side windows to provide extra insulation against heat, cold and noise. Because of the second pane of glass, under certain light and weather conditions a multiple image may become noticeable, especially when looking through the side windows at an outside rear view mirror.

Storing Mirror Positions in Memory

The exterior and inside rear view mirror positions are stored in memory with the seat/head restraint/ steering column position and can be recalled when necessary, see Index.

Note:

If the inside rear view mirror was adjusted separately, the originally stored position remains in memory. To recall position, press the desired position button.



Folding the mirrors in

Turn switch to point rearward. Press switch rearward until the mirrors are folded in.

Important!

Before running the vehicle through an automatic car wash, fold mirror in, otherwise they may get damaged.

Folding the mirrors out

Turn switch to point rearward. Press switch forward until the mirrors are folded out.

Important!

Do not fold mirrors out, forcing them by hand. This will damage the operating mechanism of the mirrors.

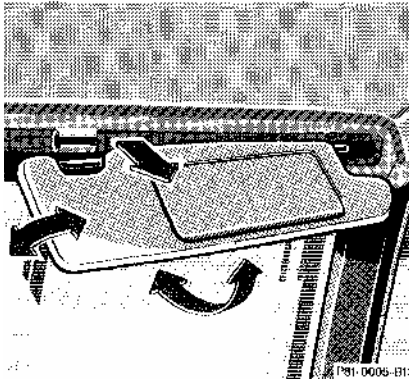

Sun Visors

Swing sun visors down to protect against sun glare.

If sunlight enters through a side window, disengage visor from inner mounting and pivot to the side. From this position, the visor can slide forward and backward on its shaft.

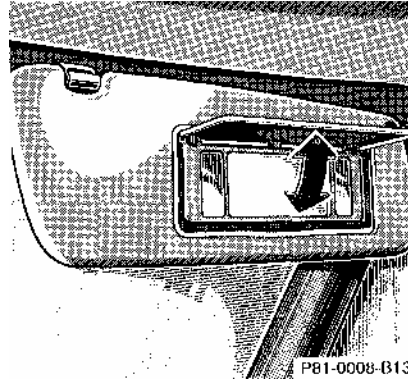

Illuminated Vanity Mirrors

Front seats:

With the visor engaged in its inner mounting, the lamp can be switched on by opening the cover.

Warning!

Do not use the vanity mirror while driving.

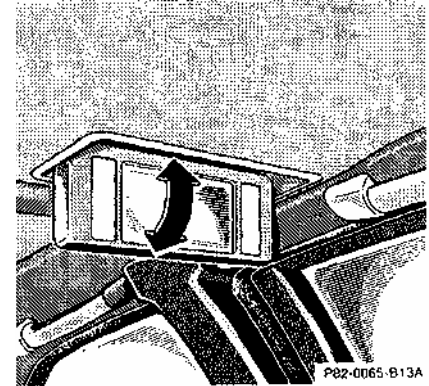

Rear seats:

Touch the cover to lower the mirror. The lamp will switch on automatically. Close the cover and the lamp will go out.

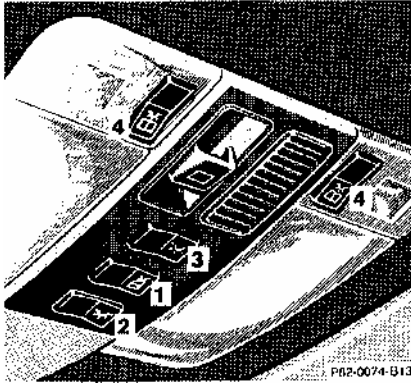

Interior Lighting

1 Interior Lamps (Door contact)



A Interior lamps are switched on, and off delayed, when unlocking or locking the vehicle, or when opening or closing either front door. However, there will be no delay when the key is in steering lock position 2.

B Interior lamps switched off.

2 Interior Lamps



A Interior lamps switched off.
 B Interior lamps switched on,

3 Rear Courtesy Lamps



A Courtesy lamps switched off.
 B Courtesy lamps switched on.

Note:

The courtesy lamps cannot be switched off as long as a rear door is open.

2 Reading Lamps, Front



A Reading lamp switched off.
 B Reading lamp switched on.

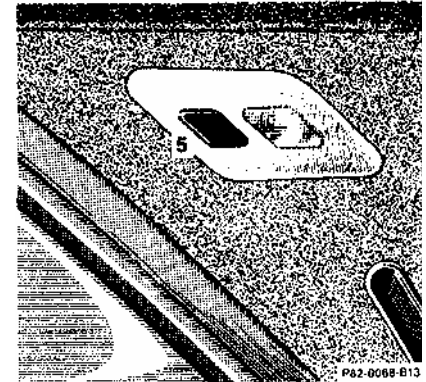

5 Reading Lamps, Rear

The lamps are switched on and off individually with a switch in the respective lamp.

Entrance Lamps, Exit Lamps

The lamps are switched on and off by the door contact switches.

Note:

To prevent the vehicle battery from being discharged, do not leave doors open for a long period of time.

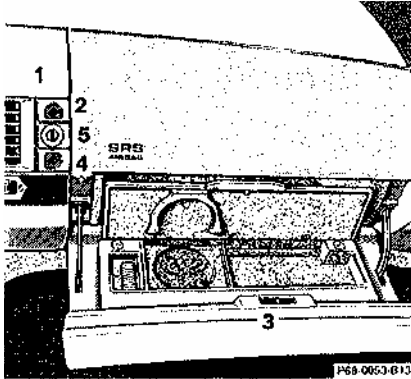

Storage Compartments

Storage Compartments in the Dashboard

- 1 Storage/eyeglasses compartment
- 2 Button for storage/eyeglasses compartment
- 3 Glove box
- 4 Button for glove box
- 5 Lock

Storage/Eyeglasses Compartment

To open: Press button (2).

Glove Box

The glove box lid is equipped with a container for coins and small accessories.

To open: Press button (4).

Note:

The storage compartments may be locked and unlocked by using the master key in lock (5).

Locking:

Turn master key in lock (5) to the right and remove.

Unlocking:

Turn master key back to vertical position.

Caution!

Keep compartment lids closed. This will prevent stored objects from being thrown about and injuring vehicle occupants during an accident.

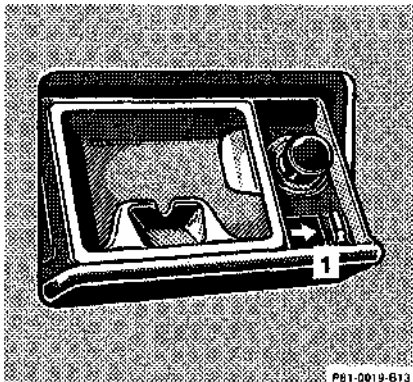

in center console, front

Ashtrays

By touching the top of the cover lightly, the ashtray opens automatically. Prior to removing the ashtray insert move gear selector lever to position "N"

Warning!

With the gear selector lever in position "N", turn off the engine and set the parking brake. Otherwise the vehicle might move unintentionally.

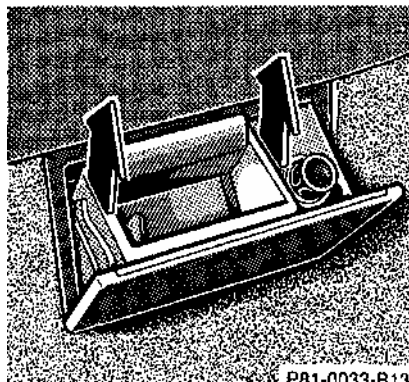

in rear doors

To remove ashtray from center console:

Push sliding knob (1) toward the right to eject the insert.

To remove ashtray from rear door: Hold left and right side of insert and pull up.

To install ashtray: Install insert into ashtray frame and push down to engage.

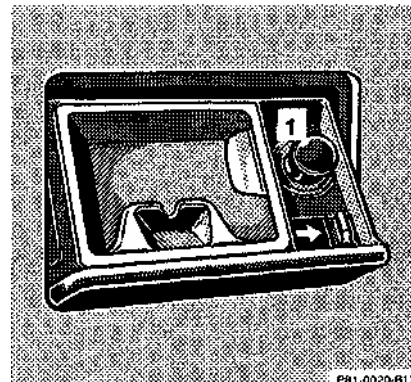

Lighter

Turn key in steering lock to position 1 or 2. Push in lighter (1); it will pop out automatically when hot.

Warning!

Never touch the heating element or sides of the lighter, hold at knob only

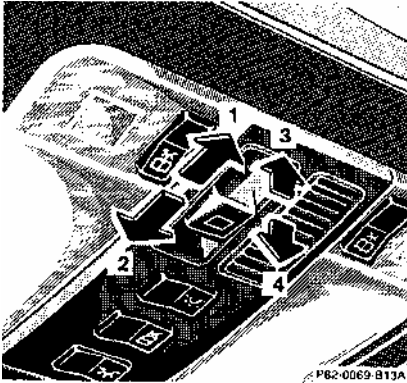

Sliding Roof with Rear Pop-Up Feature

- 1 to slide roof open
- 2 to slide roof closed
- 3 to raise roof at rear
- 4 to lower roof at rear

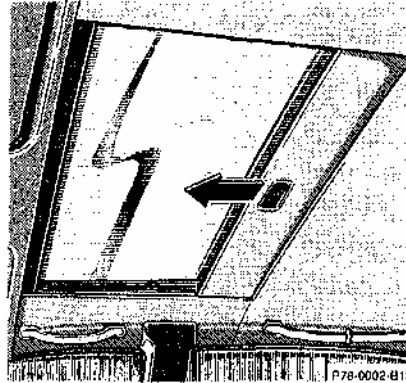

Turn key in steering lock to position 1 or 2 (with either front door open, the sliding/pop-up roof can be operated with key removed or in steering lock position 0).

The switch is illuminated when the exterior lamps are switched on (except standing lamps).

Glass Sliding Roof with Rear Pop-Up Feature

An additional screen can be slid into the roof opening to guard against sun rays. When sliding the roof open, the screen will also retract.

Warning!

When closing the sliding roof, be sure that there is no danger of anyone being harmed by the closing procedure.

Notes:

The sliding roof can be opened or closed manually should an electrical malfunction occur, refer to *Emergency Operation* in Index.

The sliding roof can also be closed with the key or infrared remote control while locking the vehicle doors or trunk (see *Central Locking System* in Index).

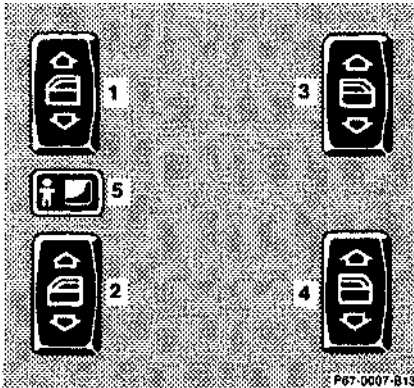

in center console, front

Power Windows

Switches for:

- 1 left, front
- 2 left, rear
- 3 right, front
- 4 right, rear
- 5 safety switch
- 6 individual switches (rear doors)

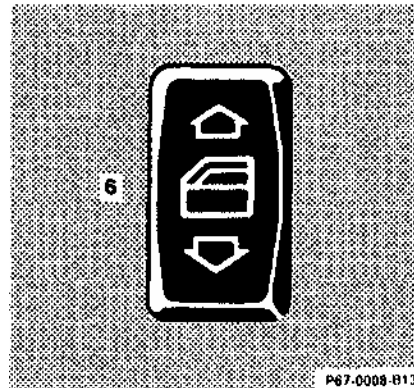

in rear doors



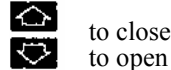

Turn key in steering lock to position 1 or 2.

Press switch in to resistance point:



Release switch when window is in desired position.

Express Opening and Closing

Press switch  or  past resistance point and release - window opens or closes completely. To interrupt procedure, briefly press  or .

If the upward movement of the window is blocked during the closing procedure, the window will stop during the last few inches before closure and open slightly.

When pressing and holding the switch  to close the window, and upward movement of the window is blocked during the last few inches before closure, it will stop but not open slightly.

Blocking of Rear Door Window Operation

If no operation of the rear windows by switch (6) (for instance by children) is desired, slide safety switch (5) to right, symbol  becomes visible.

Warning!

When closing the windows, be sure that there is no danger of anyone being harmed by the closing procedure.

In case of obstruction, the automatic reversal will not operate if a window is being closed by pressing the switch to its resistance point and holding it there, or when using a key or the remote control.

The closing procedure can be immediately reversed by either pressing the switch , turning the key to the unlocking position, or releasing and pressing the transmit button, and holding it.

Warning!

When leaving the vehicle, always remove the key from the steering lock. Do not leave children unattended in the vehicle. Unsupervised use of vehicle equipment can cause serious personal injury.

Synchronizing Power Windows

If the power supply was interrupted (battery disconnected or empty), the windows cannot be opened or closed by the Express feature.

To resynchronize the Express feature, press  side of power window switch until the window is completely closed and hold for additional 2 seconds. Repeat procedure for each window.

The automatic full opening and closing procedure of the windows should now be restored.

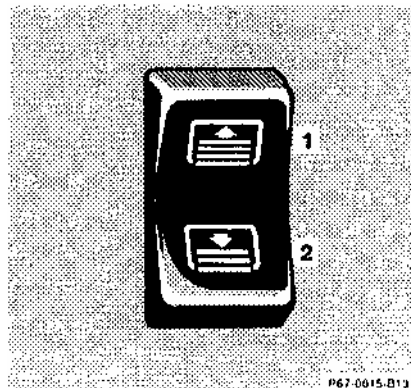

Rear Window Sunshade

- 1 Raising
- 2 Lowering

The switches are located on the center console and between the single rear seats.

The sunshade should always be either fully raised or fully lowered.

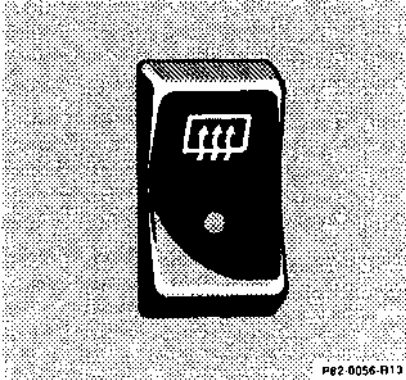

Rear Window Defroster

The switch is located in the center console.

Turn key in steering lock to position I or 2.

When activating the rear window defroster, the indicator lamp in the switch will come on.

Note:

The rear window defroster uses a large amount of power. To keep the battery drain to a minimum, turn off the defroster as soon as the window is clear.

The defroster is automatically turned off after a maximum of 20 minutes of operation.

Heavy accumulation of snow and ice should be removed before activating the defroster.

If several power consumers are turned on simultaneously, or the battery is only partially charged, it is possible that the defroster will automatically turn itself off. When this happens, the indicator lamp inside the switch starts blinking.

As soon as the battery has sufficient voltage, the defroster automatically turns itself back on.

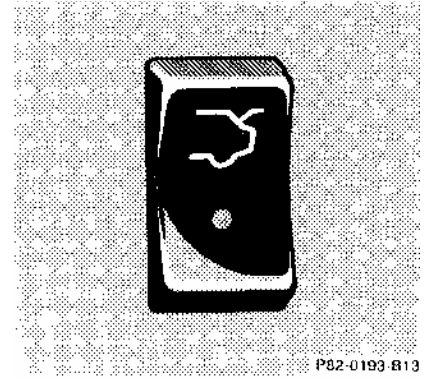

Trunk Lid Release Switch

The switch is located in the center console.

To open the trunk, the vehicle must be parked and unlocked. Press symbol side of switch.

With vehicle centrally locked, the trunk can also be opened by using the infrared remote control. Aim transmitter eye at receiver next to trunk lid lock and press transmit button twice.

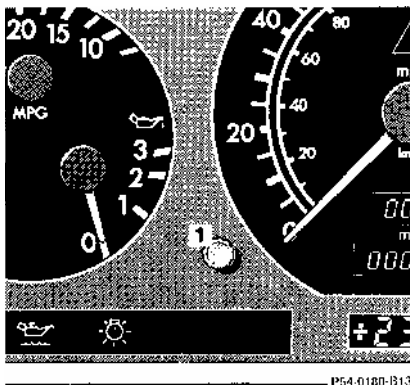

1 Adjusting knob

Instrument Lamps

Rotate adjusting knob (1) to vary intensity of instrument lamps.

Display Illumination

Press adjusting knob to briefly illuminate the display (with key removed or in steering lock position 0 or 1).

With exterior lamps switched on the display illumination becomes automatically dim.

Rotate adjusting knob clockwise to its stop to override the dimmed illumination.

Trip odometer

To reset:

- Press adjusting knob (1) once (with key in steering lock position 2).
- Press adjusting knob (1) twice (with key removed or in steering lock position 0 or 1).

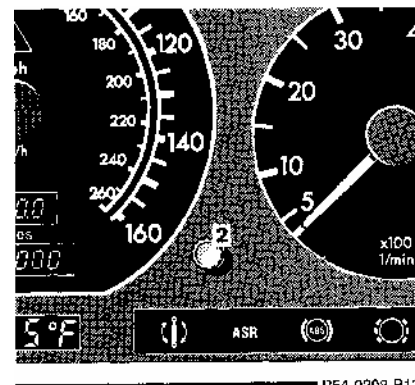

Setting Clock

Adjusting clock one minute ahead or back:

Pull out adjustment knob (2), briefly turn to the right respectively left and release knob.

Adjusting clock more than one minute ahead or back: Pull out adjustment knob (2), turn to the right respectively left and hold until the desired time is set. Within the first 2 seconds, the minute hand advances 8 minutes and advances another 8 minutes every additional second thereafter

Shelf below Rear Window

Warning!

The shelf below the rear window should not be used to carry objects. This will prevent such objects from being thrown about and injuring vehicle occupants during an accident or sudden maneuver.

Antenna

The antenna extends when switching on the telephone.

Note:

To retract the antenna (e.g. when entering a car wash) the telephone must be switched off.

Cellular Telephone

The vehicle is prepared for the installation of a cellular telephone. For further information and installation contact your authorized Mercedes-Benz dealer.

Warning!

Some jurisdictions prohibit the driver from using a cellular telephone while driving a vehicle. Whether or not prohibited by law, for safety reasons, the driver should not use the cellular telephone while the vehicle is in motion. Stop the vehicle in a safe location before answering or placing a call.

Driving

Drinking and Driving

Warning!

Drinking and driving can be a very dangerous combination. Even a small amount of alcohol or drugs can affect your reflexes, perceptions and judgement.

The possibility of a serious or even fatal accident is sharply increased when you drink and drive.

Please don't drink and drive or allow anyone to drive after drinking.

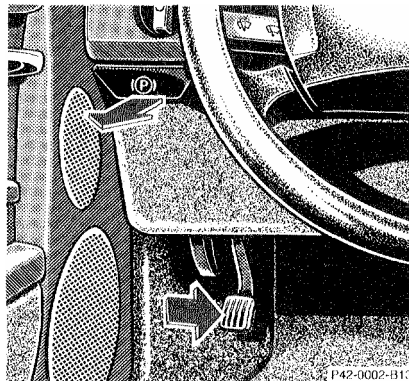

Parking Brake

To engage, depress parking brake pedal. When the key is in steering lock position 2, the brake warning lamp in the instrument cluster should come on brightly.

To release the parking brake, pull handle on instrument panel. The brake warning lamp in the instrument cluster should go out.

A warning sounds, if you start to drive without having released the parking brake.

Also see *Brake Warning Lamp Test* in Index.

Driving Off

Test the brakes briefly after driving off. Perform this procedure only when the road is clear of other traffic.

Warm up the engine smoothly. Do not place full load on the engine until the operating temperature has been reached.

Warning!

Keep driver's foot area clear at all times. Objects stored in this area may impair pedal movement.

Automatic Transmission

The automatic transmission selects individual gears automatically, dependent upon

- Selector lever position
- Accelerator position
- Vehicle speed

Important!

When parking the car or before working on the vehicle with the engine running, firmly depress the parking brake pedal and shift the selector lever into "P".

Driving

The selector lever is automatically locked while in position "P". To move the selector lever out of position "P", the service brake pedal must be firmly depressed before the shift lock will release.

Shift selector lever to the desired driving position only when the engine is idling and the service brake is applied. Do not release the brake

until ready to drive. The vehicle may otherwise start creeping when the selector lever is in drive or reverse position.

Warning!

It is dangerous to shift the selector lever out of "P" or "N" if the engine speed is higher than idle speed. If your foot is not on the brake pedal, the car could accelerate quickly forward or in reverse. You could lose control of the car and hit someone or something. Only shift into gear when the engine is idling normally and when your right foot is firmly on the brake pedal.

Important!

After selecting any driving position from "N" or "P", wait a moment to allow the gear to fully engage before accelerating, especially when the engine is cold.

Accelerator position

Partial throttle = early upshifting = normal acceleration

Full throttle = later upshifting = rapid acceleration

Kickdown (depressing the accelerator beyond full throttle) = downshifting to next lowest gear = maximum acceleration. Once the desired speed is attained, ease up on the accelerator - the transmission shifts up again.

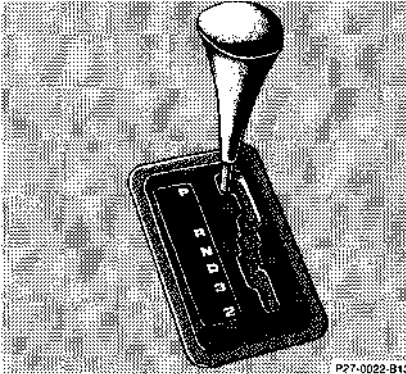

Selector Lever Positions

The automatic gear shifting process can be adapted to specific operating conditions using the selector lever.

P Parking lock.

The parking lock is an additional safeguard to the parking brake when parking the vehicle. Engage only with the car stopped.

Note:

The key can be removed from the steering lock only with the selector lever in position "P". With the key removed, the selector lever is locked in position "P".

R Reverse gear.

Shift to reverse gear only with the car stopped.

N Neutral.

No power is transmitted from the engine to the rear axle. When the brakes conditions. are released, the vehicle can be moved freely (pushed or towed). Do not engage "N" while driving except to coast when the vehicle is in danger of skidding (e.g. on icy roads, see *Winter Driving Instructions* in Index).

Important!

Coasting the vehicle, or driving for any other reason with selector lever in "N", can result in transmission damage that is not covered by the Mercedes-Benz Limited Warranty.

- D** The transmission automatically upshifts to 4th gear. Position "D" provides optimum driving characteristics under all normal operating conditions.
- 3** Upshift to 3rd gear only. Suitable for moderately steep hills.
- 2** Upshift to 2nd gear only. For driving in mountainous regions. Since the transmission does not shift higher than 2nd gear, this gear selection will allow use of the engine's braking power downhill.

Important!

Do not exceed the vehicle speed limits for individual gear selections, which are indicated by marks (I, II, III etc.) on the circumference of the speedometer.

To avoid overrevving the engine when the selector lever is moved to a lower driving range, the transmission will not shift to a lower gear as long as the vehicle speed exceeds the speed limit of that gear.

Warning!

On slippery road surfaces, never downshift in order to obtain braking action. This could result in rear wheel slip and reduced vehicle control. Your vehicle's ABS will not prevent this type of loss of control.

To prevent the engine from laboring at low RPMs, do not allow the engine speed to drop too low on uphill gradients.

Depending on the degree of the incline, shift selector lever to a lower gear range early enough to maintain engine RPM within the best torque range.

Maneuvering

To maneuver in tight areas, e.g. when pulling into parking space, control the car speed by gradually releasing the brakes. Accelerate gently and never abruptly step on the accelerator.

To rock a car out of soft ground (mud or snow), alternately shift from forward to reverse, while applying slight partial throttle.

Rocking a car free in this manner may cause the ABS warning lamp to come on. Turn off and restart the engine to clear the malfunction indication.

Stopping

For brief stops, e.g. at traffic lights, leave the transmission in gear and hold vehicle with the service brake.

For longer stops with the engine idling, shift into "N" or "P".

When stopping the car on an uphill incline, do not hold it with the accelerator, use the brake. This avoids unnecessary transmission heat build up.

Warning!

Getting out of your car with the selector lever not fully engaged in position "P" is dangerous. When parked on a steep incline, position "P" alone may not prevent your vehicle from moving, possibly hitting people or objects.

Always set the parking brake in addition to shifting to position "P".

When parked on an incline, also turn front wheel against curb.

Rear Fender Indicators

When the reverse gear is selected, the rear fender indicators will extend upward from the rear corners of the fenders.

The rear fender indicators retract delayed when shifting out of reverse. They retract immediately when turning key in steering lock to position 0.

Note:

Before shifting into reverse gear, ensure that the rear fender indicators can extend freely.

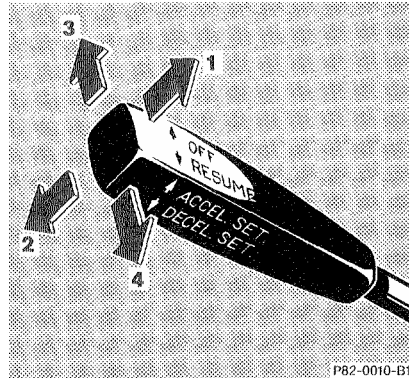

Cruise Control

Any given speed above approximately 25 mph (40 km/h) can be maintained with the cruise control by operating the lever.

- 1 Accelerate and set:
Lift lever briefly to set speed. Hold lever up to accelerate.
- 2 Decelerate and set:
Depress lever briefly to set speed.
Hold lever down to decelerate.

Normally the vehicle is accelerated to the desired speed with the accelerator.

Speed is set by briefly pushing the lever to position 1 or 2. The accelerator can be released.

The speed can be increased (e.g. for passing) by using the accelerator. As soon as the accelerator is released, the previously set speed will be resumed automatically.

If a set speed is to be increased or decreased slightly, e.g. to adapt to the traffic flow, hold lever in position 1 or 2 until the desired speed is reached, or briefly tip the control lever in the appropriate direction for increases or decreases in 0.6 mph (1 km/h) increments. When the lever is released, the newly set speed remains.

3 Canceling

To cancel the cruise control, briefly push lever to position 3.

When you step on the brake or the vehicle speed drops below approx. 25 mph (40 km/h), for example when driving upgrade, the cruise control will be canceled.

If the cruise control cancels by itself and remains inoperative until the engine is restarted, have the system checked at your authorized Mercedes-Benz dealer as soon as possible.

4 Resume

If the lever is briefly pushed to position 4 when driving at a speed exceeding approx. 25 mph (40 km/h), the vehicle resumes the speed which was set prior to the cancellation of the cruise control. The last memorized speed is canceled when the key in the steering lock is turned to position 1 or 0.

Note:

If the engine does not brake the vehicle sufficiently while driving on a downgrade, the speed you set on the cruise control may be exceeded and you may have to step on the brake pedal to slow down. As soon as the grade eases, the cruise controlled speed will again be maintained as long as the brakes were not previously applied, or the lever may be used to resume the previously set speed if the brakes were applied.

Caution!

When driving with the cruise control, the transmission selector lever must not be shifted to position "N" as otherwise the engine will overrev, possibly causing engine damage that is not covered by the Mercedes-Benz Limited Warranty.

Warning!

Only use the cruise control if the traffic and weather conditions make it advisable to travel at a steady speed.

- **The use of cruise control can be dangerous on winding roads or in heavy traffic because conditions do not allow safe driving at a steady speed.**
- **The use of cruise control can be dangerous on slippery roads. Rapid changes in tire adhesion can result in wheel spin and loss of control.**

The "Resume" function should only be operated if the driver is fully aware of the previously set speed and wishes to resume this particular preset speed.

Charge Indicator Lamp

Should the charge indicator lamp fail to come on prior to starting when the key is in steering lock position 2 or should it fail to go out after starting or during operation, this indicates a fault which must be repaired at an authorized MERCEDES-BENZ dealer immediately.

If the charge indicator lamp comes on while the engine is running, this may indicate that the poly-V-belt has broken. Should this condition occur, the poly-V-belt must be replaced before continuing to operate the vehicle. Otherwise, the engine will overheat due to an inoperative water pump which may result in damage to the engine.

Do not continue to drive the vehicle with the charge indicator lamp illuminated. Doing so could result in engine damage that is not covered by the Mercedes-Benz Limited Warranty.

Engine Oil Pressure Gauge

The oil pressure at idle speed may drop if the engine is at operating temperature. This will not jeopardize the engine's operational reliability. Pressure must, however, rise immediately upon acceleration.

Note:

If the oil pressure gauge needle drops to "0" with the engine running, then damage to the engine may occur with continued operation. Turn off engine immediately and contact an authorized Mercedes-Benz dealer. Do not operate the car until the condition is repaired.

Low Engine Oil Level Warning Lamp

With the key in steering lock position 2, the oil level warning lamp comes on and should go out when the engine is running.

If the warning lamp comes on with the engine running and at operating temperature, the engine oil

level has dropped to approximately the minimum mark on the dipstick.

When this occurs, the warning lamp will first come on intermittently and then stay on if the oil level drops further.

If no oil leaks are noted and there is no loss in engine oil pressure, continue to drive to the nearest service station where the engine oil should be topped to the "full" mark on the dipstick with an approved oil.

The low engine oil level warning light should not be ignored. Extended driving with the light illuminated could result in engine damage that is not covered by the Mercedes-Benz Limited Warranty.

In addition to the warning lamp, the engine oil level should be periodically checked with the dipstick, for example during a fuel stop, or before a long trip (see Index).

Engine Oil Consumption

Engine oil consumption checks should only be made after the break-in period. During the break-in period, higher oil consumption may be noticed and is normal. Frequent driving at high engine speeds results in increased consumption.

Fuel Consumption Gauge

While driving, instantaneous fuel consumption is indicated in miles per gallon (mpg), or in Canada liters per 100 kilometers (l/100 km).

With the engine switched off, the needle reads "0".

Due to system design, maximum consumption is indicated at idle speed.

Tachometer

Red marking on tachometer:
Excessive engine speed.

Avoid this engine speed, as it may result in engine damage that is not covered by the Mercedes-Benz Limited Warranty.

For engine protection, the fuel supply is interrupted if the engine is operated within the red marking.

Fuel Reserve Warning Lamps

With the key in steering lock position 2, the fuel reserve warning lamp comes on and goes out with the engine running.

If the warning lamp does not go out after starting the engine or if it comes on while driving, it indicates that the fuel level is down to the reserve quantity of approx. 10 liters (2.6 gal).

Outside Temperature Indicator

The temperature sensor is located in the front bumper area. Due to its location, the sensor can be affected by road or engine heat during idling or slow driving. This means that the accuracy of the displayed temperature can only be verified by comparison to a thermometer placed next to the sensor, not by comparison to external displays (e.g. bank signs, etc.).

Adaptation to ambient temperature takes place in steps and depends on the prevailing driving conditions (stop-and-go or moderate, constant driving) and amount of temperature change.

Warning!

The outside temperature indicator is not designed to serve as an Ice-Warning Device and is therefore unsuitable for that purpose. Indicated temperatures just above the freezing point do not guarantee that the road surface is free of ice.

Coolant Temperature Gauge

If the antifreeze mixture is effective to - 30°C (- 22°F), the boiling point of the coolant in the pressurized cooling system of your vehicle is approx. 130°C (266 °F).

During severe operating conditions and stop-and-go city traffic, the coolant temperature may rise close to the red marking.

The engine should not be operated with the coolant temperature in the red zone. Doing so may cause serious engine damage which is not covered by the Mercedes-Benz Limited Warranty.

Warning!

- **Driving when your engine is badly overheated can cause some fluids which may have leaked into the engine compartment to catch fire. You could be seriously burned. Turn off the engine and get out of the car until it cools down.**
- **Steam from an overheated engine can cause serious burns and can occur just by opening the engine hood. Stay away from the engine if you see or hear steam coming from it. Turn off the engine and do not stand near the car until it cools down.**

Low Engine Coolant Level Warning Lamp

With the key in steering lock position 2, the warning lamp comes on and goes out with the engine running.

If the warning lamp does not go out after starting the engine, or if it comes on while driving, then the coolant level has dropped below the required level. If no leaks are noticeable and the engine temperature does not increase, continue to drive to the nearest service station and have coolant added to the coolant system (see Index).

The low engine coolant level warning light should not be ignored. Extended driving with the light illuminated may cause serious engine damage not covered by the Mercedes-Benz Limited Warranty.

In cases of major or frequent minor coolant loss, have the cooling system checked at your authorized Mercedes-Benz dealer as soon as possible.

Note:

Do not drive without coolant in the cooling system. The engine will overheat causing major engine damage.

Monitor the coolant temperature gauge while driving.

Warning!

Do not spill antifreeze on hot engine parts. Antifreeze contains ethylene glycol which may burn if it comes into contact with hot engine parts. You can be seriously burned.

Low Windshield and Headlamp Washer System Fluid Level

Warning Lamp

With the key in steering lock position 2, the warning lamp comes on and goes out with the engine running.

If the warning lamp comes on with the engine running, the level of the reservoir has dropped to approx. $\frac{1}{4}$ pf the total volume. The reservoir should be refilled with MB Windshield Washer Concentrate "S" and water (or commercially available premixed windshield washer solvent/antifreeze, depending on ambient temperature - see Index) at the next opportunity. The reservoir for the windshield and headlamp washer system is located in the engine compartment next to the radiator.

Exterior Lamp Failure Indicator Lamp

With the key in steering lock position 2, a dim indicator lamp comes on, and goes out when the engine is running.

With the key in steering lock position 2 or with the engine running, a bright illumination of this lamp indicates an exterior lamp failure.

If an exterior lamp fails, the indicator lamp will come on only when that lamp is switched on.

If a brake or turn signal lamp fails, the lamp failure indicator will come on when applying the brake or actuating the turn signal and stay on until the engine is turned off.

Note:

The indicator lamp will also come on if an incorrect bulb is installed.

If additional lighting equipment is installed (e.g. auxiliary headlamps etc.) be certain to connect into the fuse before the failure indicator monitoring unit in order to avoid damaging the system.

Seat Belt Warning Lamp

With the key in steering lock position 2, the warning lamp comes on and an audible warning sounds for a short time if the driver's seat belt is not fastened.

After starting the engine, the warning lamp blinks for a brief period to remind the driver and passengers to fasten seat belts before driving off.

Brake Pad Wear Indicator Lamp

The brake pad wear indicator lamp in the instrument cluster comes on when the key in the steering lock is turned to position 2 and goes out when the engine is running.

If the indicator lamp lights up during braking, this indicates that the front wheel brake pads are worn down.

Have the brake system checked at your authorized Mercedes-Benz dealer as soon as possible.

Brake Warning Lamp

The brake warning lamp will come on with the key in steering lock position 2 and should go out when the engine is running.

The brake warning lamp will come on:

- when there is insufficient brake fluid in the reservoir (engine running and parking brake released)
- when the parking brake is set (engine running).

Warning!

Driving with the brake warning lamp on can result in an accident. Have your brake system checked immediately if the brake warning lamp stays on. Don't add brake fluid before checking the brake system. Overfilling the brake fluid reservoir can result in spilling brake fluid on hot engine parts and the brake fluid catching fire. You can be seriously burned.

When the minimum mark on the reservoir is reached, have the brake system checked for brake pad thickness and leaks.

To test the brake warning lamp, turn key in steering lock to position 2. The brake warning lamp comes on, and should go out when the engine is running.

Antilock Brake System (ABS)

The ABS prevents the wheels from locking up above a vehicle speed of approximately 2 mph (3 km/h) independent of road surface conditions. It is necessary, however, that the vehicle speed reaches at least 5 mph (8 km/h) before commencing to function.

At the instant one of the wheels is about to lock up, a slight pulsation can be felt in the brake pedal, indicating that the ABS is in the regulating mode.

On slippery road surfaces, the ABS will respond even with only slight brake pedal pressure. The pulsating brake pedal can be an indication of hazardous road conditions and functions as a reminder to take extra care while driving.

The ABS warning lamp in the instrument cluster comes on with the key in steering lock position 2 and should go out with the engine running.

If the charging voltage falls below 10 volts, the warning lamp comes on and the ABS is switched off. When the voltage is above this value again, the warning lamp should go out and the ABS will be operational.

If the ABS warning lamp does not go out or comes on while driving, it indicates that the ABS has detected a malfunction and has switched off. In this case, the brake system functions in the usual manner, but without antilock assistance.

Have the system checked at your authorized MERCEDES-BENZ dealer as soon as possible.

Warning!

Even the ABS cannot prevent the natural laws of physics from acting on the vehicle. The ABS cannot prevent accidents, including those resulting from excessive speed in turns, following another vehicle too closely, or aquaplaning. Only a safe, attentive, and skillful driver can prevent accidents. The capabilities of an ABS equipped car must never be exploited in a reckless or dangerous manner which could jeopardize the user's safety or the safety of others.

Note:

To alert following vehicles to slippery road conditions you discover, operate your hazard warning flashers as appropriate.

With the ABS malfunctioning, the ETS is also switched off. Both malfunction indicator lamps come on with the key in steering lock position 2.

Electronic Traction System (ETS)

The ETS improves vehicle traction, especially under slippery road conditions. It engages at vehicle speeds up to approximately 24 mph (40 km/h), and applies the brakes to the spinning drive wheel. At approximately 50 mph (80 km/h), the ETS switches off.

The ETS warning lamp, located in the speedometer dial, starts to flash at any vehicle speed, as soon as the tires lose traction and the wheels begin to spin.

Important!

If the ETS warning lamp flashes:

- during take-off, apply as little throttle as possible,
- while driving, ease up on the accelerator.

Adapt your speed and driving to the prevailing road conditions.

With the key in steering lock position 2, the yellow ETS malfunction indicator lamp in the instrument cluster and the ETS warning lamp in the speedometer dial come on. They must go out when the engine is running.

If the ETS malfunction indicator lamp comes on with the engine running, a malfunction has been detected.

Have the ETS checked at your authorized Mercedes-Benz dealer as soon as possible.

With the ABS malfunctioning, the ETS is also switched off.

Caution!

If the vehicle is towed with the front axle raised (see *Towing the vehicle* in Index), or when testing the parking brake on a brake test dynamometer, the key must not be in steering lock position 2. Otherwise, the electronic traction system will immediately be engaged and will apply the rear wheel brakes.

Notes:

If the ETS malfunction indicator lamp comes on while the ETS warning lamp flashes, the electronic traction system is being switched off temporarily to prevent overheating of the drive wheel brakes.

In winter operation, the maximum effectiveness of the electronic traction system is only achieved with Mercedes-Benz recommended M + S radial-ply tires and/or snow chains.

Adaptive Damping System (ADS)

Depending upon road surface conditions, load, driving style, ADS will automatically adjust the optimal ride firmness.

The malfunction indicator lamp comes on with the key in steering lock position 2 and goes out when the engine is running.

If the malfunction indicator lamp stays on after the engine is running or comes on while driving, then the system has detected a malfunction.

We recommend that you visit an authorized Mercedes-Benz dealer as soon as possible to have the system checked out.

Note:

If the power supply was interrupted (battery disconnected or empty), the malfunction indicator lamp will light up when the engine is running. Turn the steering wheel from full left to full right lock position. The light should go out.

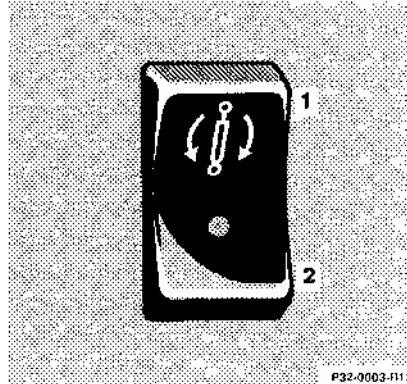

Adaptive Damping System Adjustment

The switch is located in the center console.

- 1** Firm dampening program. This setting should be used for sporty driving. During the setting for sporty driving the indicator lamp in the switch lights up.
- 2** Soft dampening program. This setting should be used for regular driving.

Note:

The firm damping program must be selected again when restarting the engine.

Emission Control

Certain systems of the engine serve to keep certain components of the exhaust gases within permissible limits required by law.

These systems, of course, will function properly only when maintained strictly according to factory specifications. Any adjustments on the engine should, therefore, be carried out only by qualified Mercedes-Benz technicians. Engine adjustments should not be altered in any way. Moreover, the specified service and maintenance jobs must be carried out regularly according to Mercedes-Benz servicing requirements. For details refer to the Maintenance Booklet.

Warning!

Inhalation of exhaust gas is hazardous to your health. All exhaust gas contains carbon monoxide, and inhaling it can cause unconsciousness and lead to death.

Do not run the engine in confined areas (such as a garage) which are not properly ventilated. If you think that exhaust gas fumes are entering the vehicle while driving, have the cause determined and corrected immediately. If you must drive under these conditions, drive only with at least one window fully open.

Traveling Abroad

Abroad, there is a widely-spread Mercedes-Benz service network at your disposal. If you plan to travel into areas which are not listed in the index of your dealer directory, you should request pertinent information from your authorized Mercedes-Benz dealer.

Winter Driving

Have your car winterized at your authorized Mercedes-Benz dealer before the onset of winter.

- Change the engine oil if the engine contains an oil which is not approved for winter operation. For viscosity (SAE class) and filling quantity, see *Capacities: Fuels, Coolants, Lubricants etc.* in Index.
- Check engine coolant anticorrosion/antifreeze concentration.
- Additive for the windshield washer and headlamp cleaning system: Add MB Concentrate "S" to a premixed windshield washer solvent/antifreeze which is formulated for below freezing temperatures (see Index).
- Test battery: Battery capacity drops with decreasing ambient temperature. A well charged battery ensures that the engine can always be started, even at low ambient temperatures.

- Tires: We recommend M + S radial-ply tires on all four wheels for the winter season. Observe permissible maximum speed for M + S radial-ply tires and the legal speed limit.
- Engine block heater: The engine is equipped with a block heater. The electrical cable may be installed free-of-charge at your authorized Mercedes-Benz dealer by using the coupon in the "Owner's Service and Warranty Policy" booklet. The coupon is valid for 12 months from date of vehicle delivery.

After installation, the electrical plug is located at the side of the radiator (behind the grill) and can be plugged into ordinary household outlets. One or two hours of operation is usually sufficient to pre-warm the engine before starting. The engine block heater can be left plugged in overnight, if desired.

Note:

In winter operation, the maximum effectiveness of the electronic traction system can only be achieved with M + S radial-ply tires and/or snow chains recommended by Mercedes-Benz.

Snow Chains

Use only snow chains that are tested and recommended by Mercedes-Benz. Your authorized Mercedes-Benz dealer will be glad to advise you on this subject.

Chains should only be used on the rear wheels. Follow the manufacturer's mounting instructions.

Snow chains should only be driven on snow covered roads at speeds not to exceed 30 mph (50 km/h). Remove chains as soon as possible when driving on roads without snow.

For tips on driving on slippery winter roads, refer to Index.

Practical Hints

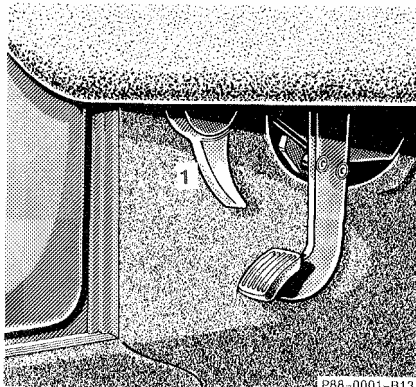

Hood

To unlock the hood, pull release lever (1) under the driver's side of the instrument panel. At the same time handle (2) will extend out of the radiator grill (it may be necessary to lift the hood up slightly).

Caution!

To avoid damage to the windshield wipers or hood, open the hood only with wipers in the parked position.

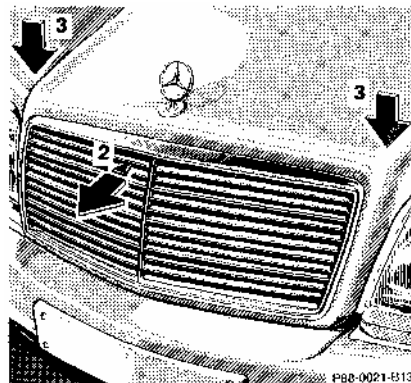

Pull handle (2) out of radiator grill to stop and open hood. Do not lift hood at louvers of grill! Make certain the windshield wiper arm is not folded forward.

To close:

Lower hood and let it drop into lock from a height of approx. 30 cm (1 ft). Do not press down on hood with hands.

To avoid hood damage, if hood is not fully closed, re-open and repeat closing procedure.

Warning!

To help prevent personal injury, stay clear of moving parts when the hood is open and the engine is running. Be sure the hood is properly closed before driving.

We recommend that you do not open the hood, if you see flames or smoke coming from the engine compartment.

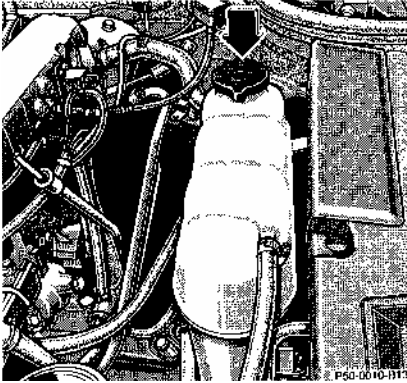

Checking Coolant Level

To check the coolant level, the vehicle must be parked on level ground.

Check coolant level only when coolant is cold:

The coolant should reach the rib in the filler neck. Also see marking (1) on reservoir.

Warning!

- **Use extreme caution when opening the hood if there are any signs of steam or coolant leaking from the cooling system.**
- **Do not remove pressure cap on coolant reservoir if engine temperature is above 90°C (194°F). Allow engine to cool down before removing cap. The coolant reservoir contains hot fluid and is under pressure.**
- **Using a rag, turn cap to first notch to relieve excess pressure. If opened immediately, hot scalding fluid and steam will be blown out under pressure, possibly causing personal injury,**
- **Do not spill antifreeze on hot engine parts. Antifreeze contains ethylene glycol which may burn if it comes into contact with hot engine parts. You can be seriously burned.**

Adding Coolant.

If coolant has to be added, a 50/50 mixture of water and MB anticorrosion/antifreeze should be added.

The drain plugs for the cooling system are located on the right side of the engine block and at the bottom of the radiator.

Anticorrosion/antifreeze, see *Coolants* in Index.

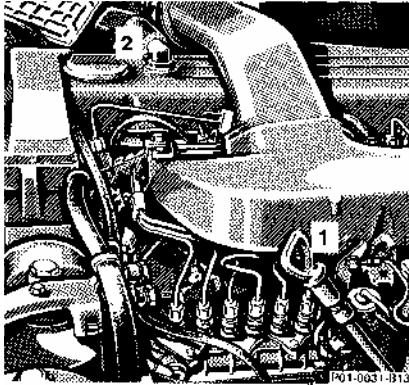

Checking Engine Oil Level

- 1 Oil dipstick
- 2 Oil filler cap

To check the engine oil level, park vehicle on level ground, with engine at normal operational temperature.

Check engine oil level approximately 5 minutes after stopping the engine, allowing for the oil to return to the oil pan.

Wipe oil dipstick clean prior to checking the engine oil level.

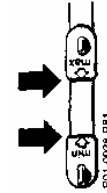

Oil level must be between the lower (min) and upper(max) mark of the dipstick

Do not overfill engine. Excessive oil must be drained or siphoned.

For low engine oil level warning lamp, see Index.

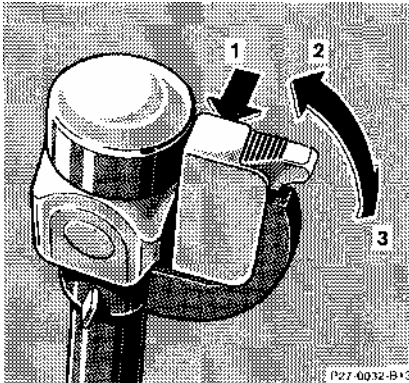

Checking Automatic Transmission Fluid Level

Dipstick locking lever

- 1 Break seal
- 2 Release
- 3 Engage

Regular automatic transmission fluid level checks are not required. For this reason the dipstick opening is sealed.

When noticing fluid loss or gear shifting malfunctions, we recommend to have your authorized Mercedes-Benz dealer check the transmission fluid level.

The transmission fluid level should only be checked with the engine idling, parking brake engaged and selector lever in position "P". The vehicle must be parked on level ground.

Prior to the check, allow engine to idle for approx. 1 to 2 minutes. To pull dipstick from tube, break seal by moving plastic pin (1) sideways. Then open cap by releasing locking lever (2).

Measure fluid level with the dipstick completely inserted and the locking lever released (2).

Extreme cleanliness must be observed! To wipe the dipstick, use a clean, lint-free cloth.

To fill the transmission with fluid, pour it through a fine-mesh filter into the dipstick opening. Even the slightest impurity may cause operational troubles

The level of the transmission fluid is dependent upon its temperature. Two sets of maximum and mini-mum fluid level marks on the dipstick are applicable references only if the transmission fluid has either reached its normal operating temperature of 176 °F (80 °C), or its temperature is 86 °F (30 °C).

Important!

The fluid level must not exceed the dipstick maximum mark. Drain or siphon excess fluid, if required.

Then push dipstick all the way in and swing locking lever downward (3).

Note:

Damage to transmission caused by contamination of transmission fluid or overfilling of transmission may result in serious transmission damage which is not covered by the Mercedes-Benz Limited Warranty.

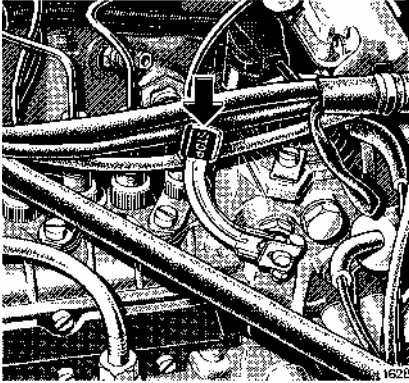

Turning Off Engine Manually

If the engine continues to run after the key is turned to steering lock position 0, open the hood and push down the lever marked "STOP" until the engine stops running.

Using an extension such as a pen or screwdriver should make it easier to push the "STOP" lever down.

Warning!

To help prevent personal injury, stay clear of moving parts when the hood is open and the engine is running. Be sure the hood is properly closed before driving.

Bleeding of Fuel System

The fuel system is a self bleeding system. Turn the key in steering lock fully to the right and crank engine (for up to one minute maximum). Push accelerator pedal to the floor while cranking engine. Only release key after engine fires evenly.

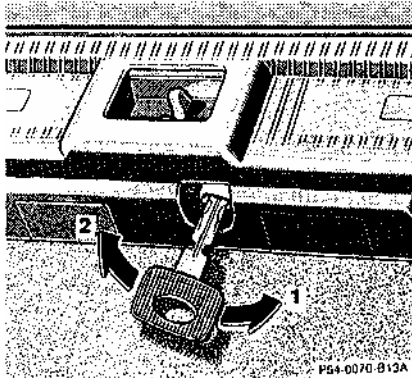

Trunk Lamp

- 1 Switching off
- 2 Switching on

Switch off (1) trunk lamp if the trunk is to remain open for along period of time. This prevents the vehicle battery from being discharged.

The lamp switches on automatically, when you open the trunk again the next time.

When you switch off the trunk lamp, the trunk lid handle will also retract. To close the trunk lid by its handle, first switch on (2) the trunk lamp.

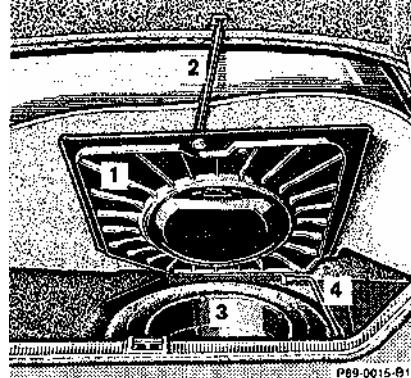

Spare Wheel, Lug Wrench

- 1 Trunk floor
- 2 Strap
- 3 Luggage bowl
- 4 Lug wrench

Roll back the floor mat. Lift the trunk floor (1) and engage strap (2) in the eyelet on the edge of the trunk lid.

To remove the spare tire, turn luggage bowl (3) to the left and remove.

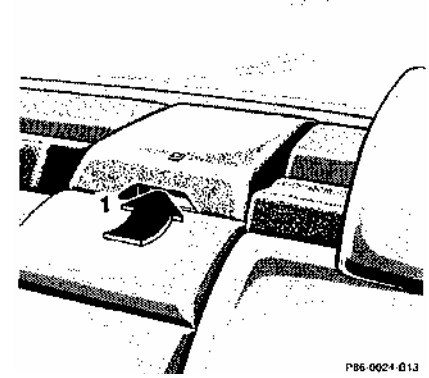

First Aid Kit

- 1 Opening lid
- The first aid kit is stored in the shelf below the rear window.

Stowing Things in the Vehicle

Warning!

To help avoid personal injury during a collision or sudden maneuver, exercise care when stowing things. Put luggage or cargo in the trunk if possible. Do not pile luggage or cargo higher than the seat backs. Do not place anything on the shelf below the rear window.

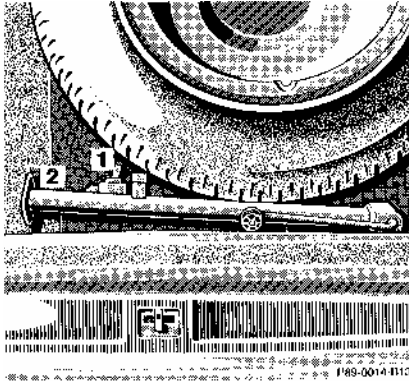

Vehicle Jack

- 1 Jack arm
- 2 Jack base

See illustration for proper storage of jack.

Before storing the jack on the felt in the spare wheel well, the jack arm must be lowered almost to the base of the jack.

Warning!

The jack is designed exclusively for jacking up the vehicle at the jack tubes built into either side of the vehicle. Use the jack only to lift the vehicle during a wheel change. Never get beneath the vehicle while it is supported by the jack. Keep hands and feet away from the area under the lifted vehicle. Always firmly set parking brake and block wheels before raising vehicle with jack.

Do not disengage parking brake while the vehicle is raised. Be certain that the jack is always vertical when in use, especially on hills. Always try to use the jack on level surface. Be sure that the jack arm is fully inserted in the jack tube. Always lower the vehicle onto sufficient capacity jackstands before working under the vehicle.

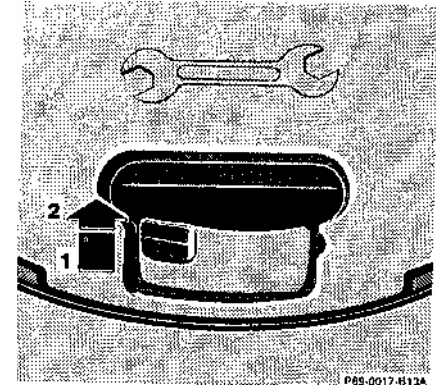

Vehicle Tools, Storage Compartment below Tool Box

- 1 Lock tool box lid
- 2 Unlock tool box lid

To open the storage compartment: Lift out tool box.

To insert the tool box: Position rear end of tool box, press down its front end.

Wheels

Replace rims or tires with the same designation, manufacturer and type as shown on the original part. See your authorized Mercedes-Benz dealer for further information.

Warning!

Do not mix different tire construction types (i.e. radial, bias, and bias-belted) on your car because handling may be adversely affected and may result in loss of control.

See your authorized Mercedes-Benz dealer for information on tested and recommended rims and tires for summer and winter operation. They can also offer advice concerning tire service and purchase.

Tire Replacement

Front tires should be replaced in sets. Furthermore - in the event of tire replacement - the spare wheel, if possible, should be used on the rear axle. Rims and tires must be of the same size and type. For dimensions, see "Technical Data".

We recommend that you break in new tires for approx. 60 miles (100 km) at moderate speed. It is imperative that the wheel mounting bolts be retightened after approx. 60-300 miles (100-500 km).

On new vehicles retightening is carried out during the 1st inspection. Retightening is also necessary whenever wheels are fitted, e.g. when the spare wheel is used for the first time or when a set of wheels with M + S tires is installed.

Tightening torque:
110 ft.lb. (150 Nm).

For rim and tire specifications, refer to "Technical Data".

Warning!

Worn, old tires can cause accidents. If the fire tread is badly worn, or if the tires have sustained damage, replace them.

When replacing rims, use only genuine Mercedes-Benz wheel bolts (identified by Mercedes star) specified for the particular rim type. Failure to do so can result in the bolts loosening and possibly an accident.

Rotating Wheels

The wheels can be rotated according to the degree of tire wear while retaining the same direction of travel. Rotating, however, should be carried out at a mileage of 3000 -6000 miles (5000 - 10 000 km), before the characteristic tire wear pattern (shoulder wear on front wheels and tread center wear on rear wheels) becomes visible, as otherwise the driving properties deteriorate.

Important!

Unidirectional snow tires must always be mounted with arrow on tire sidewall pointing in direction of vehicle forward movement.

Note:

Thoroughly clean the inner side of the wheels any time you rotate the wheels or wash the vehicle underside.

The use of retread tires is not recommended. Retread tires may adversely affect the handling characteristics and safety of the vehicle.

Dented or bent rims can cause tire pressure loss and damage to the

tire beads. For this reason, check rims for damage at regular intervals. The rim flanges must be checked for wear before a tire is mounted. Remove burrs, if any.

Check and correct tire inflation pressure after rotating the wheels. For *Tire Inflation Pressure* refer to Index.

Warning!

The jack is designed exclusively for jacking up the vehicle at the jack tubes built into either side of the vehicle. To help avoid personal injury, use the jack only to lift the vehicle during a wheel change. Never get beneath the vehicle while it is supported by the jack. Keep hands and feet away from the area under the lifted vehicle. Always firmly set parking brake and block wheels before raising vehicle with jack.

Do not disengage parking brake while the vehicle is raised. Be certain that the jack is always vertical when in use, especially on hills. Always try

to use the jack on level surface. Be sure that the jack arm is fully inserted in the jack tube. Always lower the vehicle onto sufficient capacity jackstands before working under the vehicle.

Changing Wheels

Move vehicle to a level area which is a safe distance from the roadway.

1. Set parking brake and turn on hazard warning flasher.
2. Move selector lever to position "P" and turn off engine.
3. Prevent vehicle from rolling away by blocking wheels with wheel chocks (not supplied with vehicle) or sizable wood block or stone. When changing a wheel on a hill, place chocks on the downhill side blocking both wheels of the other axle. On a level road, place one chock in front of and one behind the wheel that is diagonally opposite to the wheel being changed.

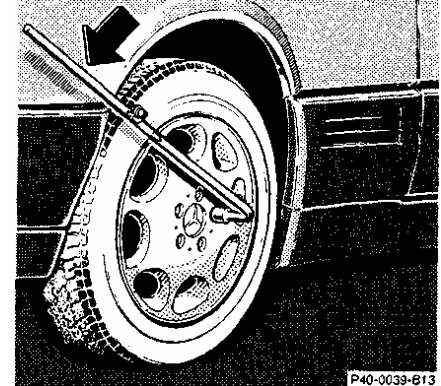

P40-0039-B13

4. Unfold wrench, loosen but do not remove the wheel bolts yet.

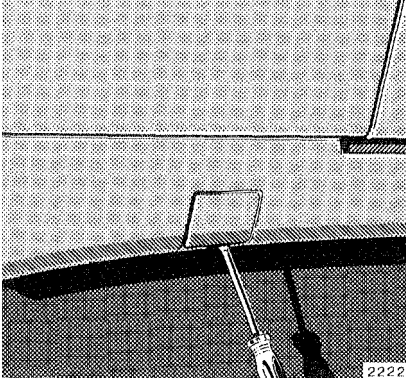

5. Remove the protective cover from the jack support tube opening by inserting a screw driver in the opening and prying it out.

The tube openings are located directly behind the front wheel housings and in front of the rear wheel housings.

6. Insert jack arm fully into the tube hole up to the stop. Place jack on firm ground. Position the jack so that it is always vertical (plumb-line) as seen from the side (see arrow), even if the vehicle is parked on an incline.

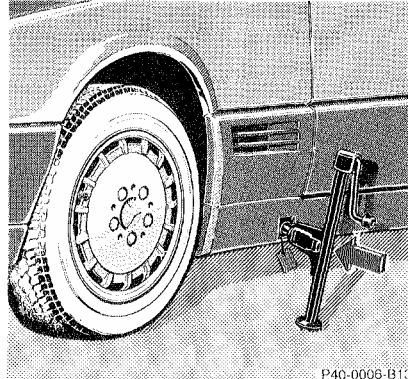

7. Jack up the vehicle until the wheel is clear of the ground. Never start engine while vehicle is raised.

8. Unscrew wheel bolts completely. Keep bolt threads protected from dirt and sand.

While removing the last bolt, hold wheel against hub to avoid paint damage on rim.

9. Remove wheel. Grip wheel from the sides. Keep hands from beneath the wheels.

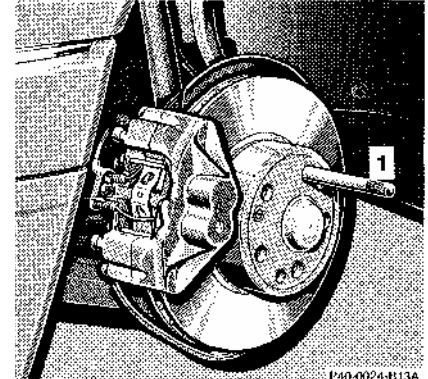

10. Screw the alignment bolt (1) supplied in the tool kit into the upper-most threaded hole.

Warning!

Always replace wheel bolts that are damaged or rusted.

Never apply oil or grease to wheel bolt threads.

Damaged wheel hub threads should be repaired immediately.

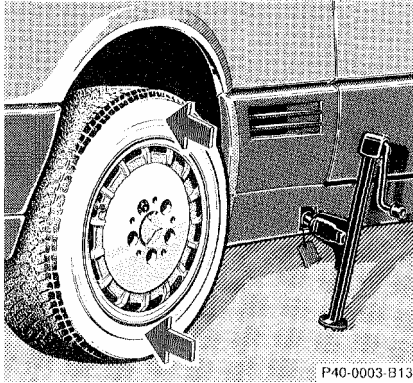

P40-0003-B13

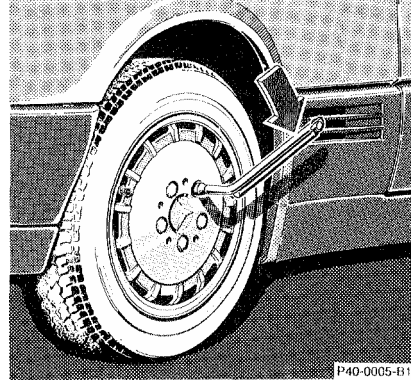

P40-0005-B13

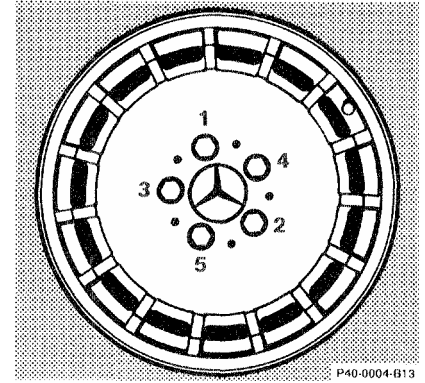

P40-0004-B13

11. Clean contact surfaces of wheel and wheel hub. Install spare wheel on wheel hub. Insert wheel bolts and tighten them slightly

To avoid paint damage, place wheel flat against hub and hold it there while installing first wheel bolt.

Unscrew the alignment bolt to install the last wheel bolt.

12. Lower car. Remove jack and insert jack tube cover.

13. Fold wrench together and tighten the five bolts evenly, following the sequence illustrated above, until all bolts are tight.

Observe a tightening torque of 110 Nm (80 ft.lb.).

14. Correct tire pressure.

Important!

When installing new wheels the mounting bolts must be retightened after approx. 100 to 500 km (60 - 300 miles).

Before storing the jack, the jack arm must be lowered almost to the base of the jack. Store the spare wheel first and then the vehicle jack.

Warning!

Incorrect mounting bolts or improperly tightened mounting bolts can cause the wheel to come off. This could cause an accident. Be sure to use the correct mounting bolts.

Tire Inflation Pressure

A table (see fuel filler flap) lists the tire inflation pressures specified for summer and winter tires as well as for the varying operating conditions.

Important!

Tire pressure differs by approx. 0.1 bar (1.5 psi) per 10°C (18°F) of air temperature change. Keep this in mind when checking tire pressure inside a garage especially in the winter.

Example:

If garage temperature = approx. + 20°C (+ 68 °F) and ambient temperature = approx. 0 °C (+ 32 °F) then the adjusted air pressure = specified air pressure + 0.2 bar (+ 3 psi).

Tire pressures listed for light loads are minimum values offering high driving comfort.

Increased inflation pressures for heavy loads produce favorable handling characteristics with lighter loads and are perfectly permissible. The ride of the vehicle, however, will become somewhat harder.

Tire temperature and pressure increase with the vehicle speed. Tire pressure should therefore only be corrected on cold tires. Correct tire pressure in warm tires only if pressure has dropped below the pressure listed in the table and the respective operating conditions are taken into consideration.

An underinflated tire due to a slow leak (e.g. due to a nail in the tire) may cause damage such as tread separation, bulging, etc.. Regular tire pressure checks (including the spare tire) at intervals of no more than 14 days are therefore essential.

If a tire constantly loses air, it should be inspected for damage.

Warning!

Do not overinflate tires, Overinflating tires can result in sudden deflation (blow-out) because they are more likely to become punctured or damaged by road debris, potholes, etc. Follow recommended inflation pressures.

Do not overload the tires by exceeding the specified vehicle capacity weight (as indicated by the label on the driver's door latch post). Overloading the tires can overheat them, possibly causing a blow-out.

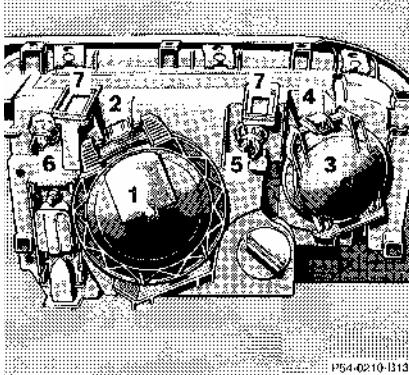

Exterior Lamps

When replacing bulbs, install only 12 volt bulbs with the specified watt rating

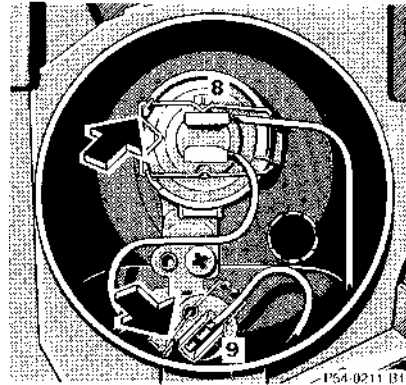

Headlamp Assembly

- 1 Cover for low beam headlamp bulb and fog lamp
- 2 Latch for cover (1)
- 3 Cover for high beam headlamp and level for vertical adjustment
- 4 Latch for cover (3)
- 5 Headlamp vertical adjustment screw

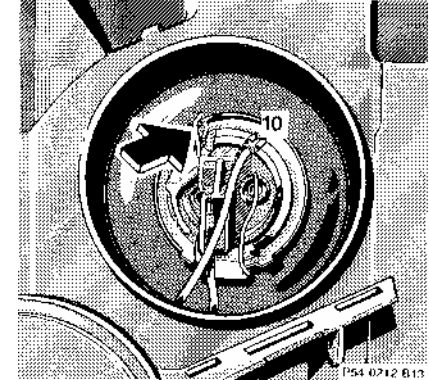

- 6 Headlamp horizontal adjustment screw
- 7 Scale for horizontal adjustment
- 8 Electrical connector for low beam headlamp bulb
- 9 Electrical connector for fog lamp bulb
- 10 Electrical connector for high beam headlamp bulb

Replacing bulb:

When replacing halogen bulbs do not touch glass portion of bulb with bare hands. Use plain paper or a clean cloth.

Warning!

Halogen lamps contain pressurized gas. A bulb can explode if you:

- **touch or move it when hot,**
- **drop the bulb,**
- **scratch the bulb.**

Bulb for low beam HB2 (60/55 W)
Bulb for fog lamp YC (H3) (55 W)

Open hood.

Depress latch (2) and remove cover (1).

Pull off electrical connector (8) or (9).
Unhook clamping ring (arrow) and remove bulb.

Insert new bulb (seating properly in cutouts of bulb socket), and mount clamping ring. Reinstall and push electrical connector on securely.
Reinstall bottom end of cover (1) and push against top end of cover until properly seated.

Check lamp for proper operation.

Bulb for high beam H1 (55 W)

Open hood.

Depress latch (4) and remove cover (3).

Pull off electrical connector (10).
Unhook clamping ring (arrow) and remove bulb.

Insert new bulb (seating properly in cutouts of bulb socket), and mount clamping ring. Reinstall and push electrical connector on securely.

Reinstall bottom end of cover (3) and push against top end of cover until properly seated.

Check lamp for proper operation.

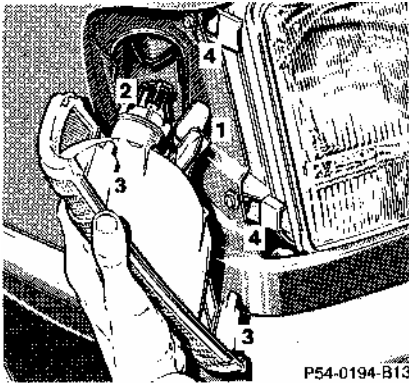

- 1 Latch for turn signal, parking, side marker and standing lamp assembly
- 2 Bulb socket for turn signal, parking, side marker and standing lamp
- 3 Tab
- 4 Guide

Turn Signal, Parking, Side Marker and Standing Lamp (2357 NA [28.5/8.3 W/30/2.2 cp] bulb)

Open hood.

Squeeze latch (1) together and lift complete lamp assembly out to front of vehicle. Twist bulb socket (2) counterclockwise and pull out. Push bulb into socket, turn counterclockwise and remove.

Insert new bulb in socket, push in and twist clockwise. Reinstall bulb socket. Reinstall lamp assembly by sliding tabs (3) into guides (4) until properly seated.

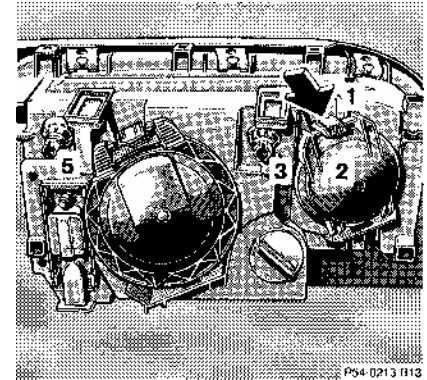

Adjusting Headlamp

Correct headlamp adjustment is extremely important. To check and readjust a headlamp do the following:

- Park unloaded vehicle on level surface. Check surface with carpenter's level.
- Remove cover above headlamp.

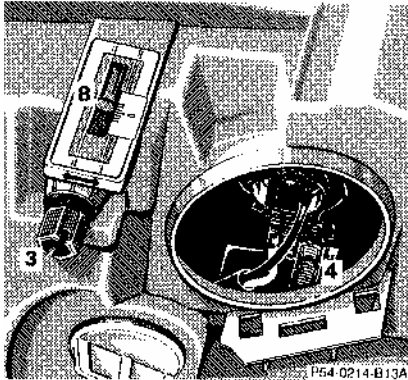

Vertical headlamp aim:

Depress latch (1) and remove cover (2).

Turn adjusting screw (3) (counterclockwise to adjust headlamp downward, clockwise upward) until the bubble in level (4) is in center of the marking (bold line).

Graduations: Vertical 0.18° pitch.

Reinstall bottom end of cover (2) and push against top end of cover until properly seated.

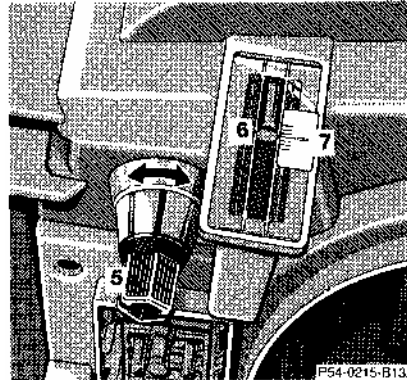

Horizontal headlamp aim:

Turn adjustment screw (5) until pins in sight glasses (6) and (8) show the same value.

Right front headlamp: Turn adjustment screw (5) counterclockwise to adjust headlamp to the left, clockwise to the right.

Left front headlamp: Turn adjustment screw (5) counterclockwise to adjust headlamp to the right, clockwise to the left.

Graduations: Horizontal 0.38° pitch,
Reinstall cover above headlamp.

Notes:

Horizontal headlamp aim normally never changes and needs readjustment only after repair to the body or a headlamp unit. Therefore, do not turn the horizontal adjustment screw (5), if pins in sight glasses (6) and (8) show the same value.

The headlighting system is properly aimed if the appropriate vertical plane is perpendicular to both the longitudinal axis of the vehicle, and a horizontal plane when the vehicle is on a horizontal surface, and the vehicle headlamp adjustment device is set at "0" vertical and "0" horizontal.

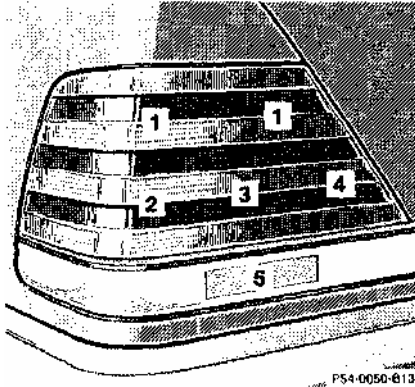

Taillamp Assemblies

- 1 Turn signal lamp
(21 W/32 cp bulb)
- 2 Stop, side marker lamp
(21/4 W/35/1.2 cp bulb)
- 3 Tail, parking, standing lamp
(5 W bulb)
- 4 Driver's side: Rear fog lamp
(21 W/32 cp bulb)
- 5 Backup lamp
(21 W/32 cp bulb)
- 6 Trunk lamp (10 W bulb)

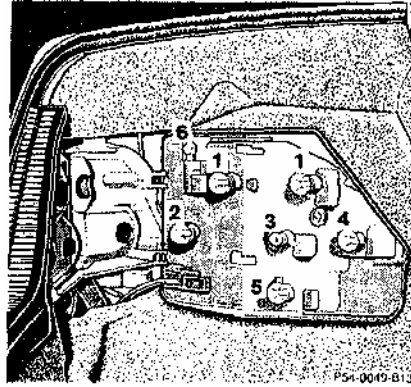

7 Cover

To replace bulbs:

Open trunk lid. Swing cover (7) aside. Twist bulb socket counterclockwise and pull out. Push bulb into socket, turn counterclockwise and remove.

Insert new bulb in socket, push in and twist clockwise. Reinstall bulb socket.

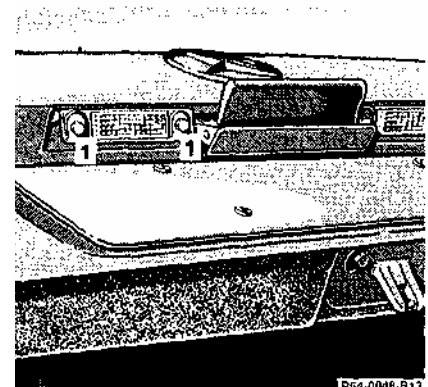

License Plate Lamps (5 W bulb)

Loosen both securing screws (1), remove lamp and take out bulb.

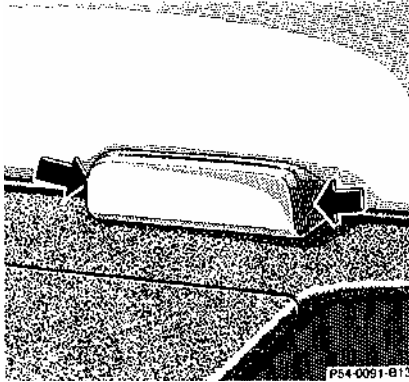

High Mounted Stop Lamp (H2 [20 W] bulb)

To replace the bulb, press tabs on both sides (arrows) to release cover.

Turn bulb socket with bulb counterclockwise and pull out.

Press bulb down, turn counterclockwise and remove.

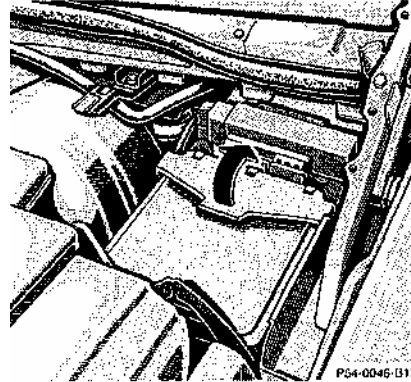

Main fuse box in engine compartment

Fuses

Before replacing a blown fuse, determine the cause of the short circuit.

Spare fuses are supplied inside the main fuse box. Observe amperage and color of fuse.

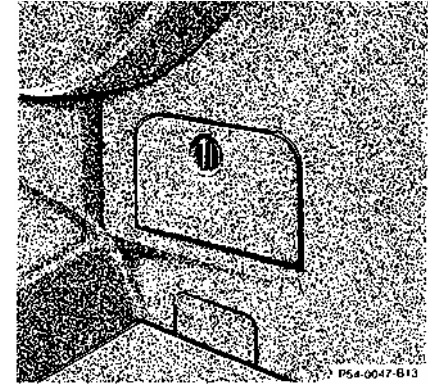

Auxiliary fuse box in trunk behind right side cover

Always use a new fuse for replacement. Never attempt to repair or bridge a blown fuse.

After replacing a blown fuse, close fuse box cover.

Battery

The maintenance-free battery is located in the trunk behind the right-hand cover panel.

The service life of the battery is also dependent on its condition of charge. The battery should always be kept sufficiently charged, in order to last an optimum length of time.

Therefore, we strongly recommend that you have the battery charge checked frequently, and corrected if necessary, especially if you use the vehicle less than approximately 200 miles (300 km) per month, mostly for short distance trips, or if it is not used for long periods of time.

Only charge a battery with a battery charger after it has been disconnected from the vehicle electrical circuit.

When removing and connecting the battery, always make sure that all electrical consumers are off and the key is in steering lock position 0.

While the engine is running the battery terminal clamps must not be loosened or detached, otherwise the generator and other electronic components would be damaged.

Always disconnect the battery negative lead first and connect last.

Note:

After reconnecting the battery also resynchronize the Express feature of the power windows and the Adaptive Damping System (ADS) (see *Power Windows* and *ADS* in Index).

Battery Recycling

Batteries contain materials that can harm the environment with improper disposal.

Large 12 Volt storage batteries contain lead, and smaller watch-type batteries (such as in the Infrared Remote Control Unit) may contain mercury.

Recycling of batteries is the preferred method of disposal.

Many states require sellers of batteries to accept old batteries for recycling.

Warning!

Never lean over batteries while connecting, you might get injured. Battery fluid contains sulfuric acid. Do not allow this fluid to come in contact with eyes, skin or clothing. In case it does, immediately flush affected area with water and seek medical help.

A battery will also produce hydrogen gas, which is flammable and explosive. Keep flames or sparks away from battery, avoid improper connection of jumper cables, smoking etc..

Jump Starting

If the battery is discharged, the engine should be started with jumper cables and the (12 V) battery of another vehicle.

The battery is located in the trunk behind the right-hand cover panel.

Warning!

Failure to follow these directions will cause damage to the electronic components, and can lead to a battery explosion and personal injury.

Read all instructions before proceeding.

Proceed as follows:

1. Position the vehicle with the charged battery so that the jumper cables will reach, but never let the vehicles touch. Make sure the jumper cables do not have loose or missing insulation.
2. On both vehicles:
 - Turn off engine and all lights and accessories, except hazard warning flashers or work lights.
 - Apply parking brake and shift selector lever to position "P".

Important!

3. Clamp one end of the first jumper cable to the positive (+) terminal of the discharged battery and the other end to the positive (+) terminal of the charged battery. Make sure the cable clamps do not touch any other metal parts.
4. Clamp one end of the second jumper cable to the grounded negative (-) terminal of the charged battery and the final connection to the negative (-) terminal of the discharged battery.

Important!

5. Start engine of the vehicle with the charged battery and run at high idle. Make sure the cables are not on or near pulleys, fans, or other parts that will move when the engine is started. Then start engine of the disabled vehicle in the usual manner.
6. After the engine has started, remove jumper cables by exactly reversing the above installation sequence, starting with the last connection made first. When removing each clamp, make sure that it does not touch any other metal while the other end is still attached.

Warning!

Never lean over batteries while connecting or jump starting, you might get injured.

Battery fluid contains sulfuric acid. Do not allow this fluid to come in contact with eyes, skin or clothing. In case it does, immediately flush affected area with water, and seek medical help.

A battery will also produce hydrogen gas, which is flammable and very explosive. Keep flames or sparks away from battery, avoid improper connection of jumper cables, smoking etc..

Important!

A discharged battery can freeze at approx. + 14°F (- 10°C). In that case, it must be thawed out before jumper cables are used. A frozen battery can explode and cause personal injury.

Jumper cable specifications:

- Minimum cable cross-section of 25 mm² or approx. 2 AWG
- Maximum length of 11.5 ft. (3.5 m).

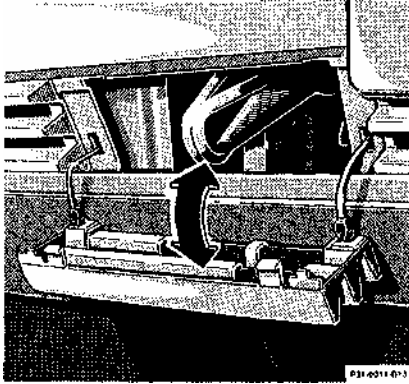

Towing the Vehicle

The rear towing eye is located at the right, below the bumper. The front towing eye is located on the passenger side behind a flap in the bumper panel.

Flap removal: Insert finger in recess of flap and pull flap out.

Flap installation: Engage flap at bottom and press in top securely.

We recommend that the vehicle be transported using flat bed equipment. This method is preferable to other types of towing.

The vehicle may be towed with all wheels on the ground and the selector lever in position "N" for distances up to 30 miles (50 km) and at a speed not to exceed 30 mph (50 km/h).

To positively avoid a possibility of damage to the transmission, however, we recommend to disconnect the drive shaft at the rear axle drive flange on any towing beyond a short tow to a nearby garage.

Do not tow with sling-type equipment. Towing with sling-type equipment over bumpy roads will damage radiator and supports.

Use wheel lift, dolly, or flat bed equipment, with key in steering lock turned to position 0.

Warning!

With the engine not running, there is no power assistance for the braking and steering systems. In this case, it is important to keep in mind that a considerably higher degree of effort is necessary to brake and steer the vehicle.

Note:

To signal turns while being towed with hazard warning flasher in use, turn key in steering lock to position 2 and activate combination switch for left or right turn signal in usual manner - only the selected turn signal will operate.

Upon canceling the turn signal, the hazard flasher will operate again.

Caution!

If the vehicle is towed with the front axle raised, the key must not be in steering lock position 2. Otherwise, the acceleration slip control will immediately be engaged and will apply the rear wheel brakes.

Cleaning and Care of the Vehicle

Warning!

Many cleaning products can be hazardous. Some are poisonous, others are flammable. Always follow the instructions on the particular container. Always open your car's doors or windows when cleaning the inside.

Never use fluids or solvents that are not designed for cleaning your car.

In operation, your vehicle is subjected to varying external influences which, if gone unchecked, can attack the paint-work as well as the underbody and cause lasting damage.

Such damage is caused not only by extreme and varying climatic conditions, but also by air pollution, road salt, tar, gravel and stone chipping. Grease and oil, fuel, coolant, brake fluid, bird droppings, tree resins etc. should be removed immediately to avoid

paint damage. Frequent washing, however, reduces and/or eliminates the aggressiveness and potency of the above adverse influences.

More frequent washings are necessary to deal with unfavorable conditions; for example, near the ocean, in industrial areas (smoke, exhaust emissions), or during winter operation.

You should check your vehicle from time to time for stone chipping or other damage. Any damage should be repaired as soon as possible to prevent the start of corrosion.

In doing so, do not neglect the underside of the car. A prerequisite for a thorough check is a washing of the underbody followed by a thorough inspection. Damaged areas need to be re-undercoated.

Your vehicle has been treated at the factory with a wax-base rustproofing in the body cavities which will last for the lifetime of the vehicle. Post-production treatment is neither necessary nor

recommended by Mercedes-Benz because of the possibility of incompatibility between materials used in the production process and others applied later.

We have selected car-care products and compiled recommendations which are specially matched to our vehicles and which always reflect the latest technology. You can obtain MB car-care products at your authorized Mercedes-Benz dealer.

Scratches, corrosive deposits, corrosion or damage due to negligent or incorrect care cannot always be removed or repaired with the car-care products recommended here. In such cases it is best to seek aid at your authorized Mercedes-Benz dealer.

The following topics deal with the cleaning and care of your vehicle and give important "how-to" information as well as references to recommended MB car-care products.

Additional information can be found in the booklet titled "Car Care".

Engine Cleaning

Prior to cleaning the engine compartment make sure to protect electrical components and connectors from the intrusion of water or cleaning agents.

Corrosion protection, such as MB Anticorrosion Wax should be applied to the engine compartment after every engine cleaning. Before applying, all control linkage bushings and joints should be lubricated. The poly-V-belt and all pulleys should be protected from any wax.

Car Washing

Before washing your vehicle, remove insect residues. MB Insect Remover is recommended. Do not use hot water or wash your car in direct sunlight. Use only a mild car wash detergent, such as MB Autoshampoo.

Thoroughly spray the car with a diffused jet of water. Direct only a very weak spray towards the

ventilation intake. Use plenty of water and rinse the sponge and chamois frequently.

Rinse with clear water and thoroughly wipe dry with a chamois. Do not allow cleaning agents to dry on the finish.

Before running the vehicle through an automatic car wash, fold back the outside mirrors to prevent them from getting damaged.

If the vehicle has been run through an automatic car wash -in particular one of the older installations - rewipe the recessed sections in the taillamps (designed to prevent soiling) if necessary. No solvents (fuels, thinners etc.) must be used.

In the winter, thoroughly remove all traces of road salt as soon as possible.

When washing the underbody, do not forget to clean the inner sides of the wheels.

Tar Stains

Quickly remove tar stains before they dry and become more difficult to remove. MB Tar Remover is recommended.

Window Cleaning

Use a window cleaning solution on all glass surfaces. MB Glass Cleaner is recommended.

Wiper Blades

Clean the wiper blade rubber with a clean cloth and detergent solution. Replace blades twice a year; once before and once after winter.

Headlamp Cleaning System

The condition of the wiper blades is important for satisfactory cleaning of the headlamp lenses. We therefore recommend that the blades be inspected regularly.

Replace damaged wiper blades.

Plastic Parts, Headliner and Rubber Parts

Do not use oil or wax on these parts. See separate subject for additional information.

Seat Belts

The webbing must not be treated with chemical cleaning agents. Use only clear, lukewarm water and soap. Do not dry the webbing at temperatures above 176 °F (80 °C) or in direct sunlight.

Warning!

Do not bleach or dye seat belts as this may severely weaken them. In a crash they may not be able to provide adequate protection.

Instrument Cluster

Use a gentle dish-washing detergent or mild detergent for delicate fabrics as a washing solution. Wipe with a cloth moistened in lukewarm solution. Do not use scouring agents.

Steering Wheel and Gear Selector Lever

Wipe with a damp cloth and dry thoroughly or clean with MB Leather Cleaner.

Hard Plastic Trim Items

Pour MB Plastic Cleaner onto soft lint-free cloth and apply with light pressure.

Headliner and Shelf below Rear Window

Clean with soft bristle brush, or use a dry-shampoo cleaner in case of excessive dirt.

Leather Upholstery

Using aftermarket seat covers or wearing clothing that have the tendency to give off coloring (e.g. when wet etc.) may cause the upholstery to become permanently discolored. By lining the seats with a proper intermediate cover, contact-discoloration will be prevented.

Wipe leather upholstery with a damp cloth and dry thoroughly or clean with MB Leather Cleaner. Exercise particular care when cleaning perforated leather as its underside should not become wet.

Paintwork, Painted Body Components

MB-Gloss Preserver should be applied when water drops on the paint surface do not "bead up"; normally in 3 to 5 months, depending on climate and washing detergent used.

MB-Paint-Polish should be applied if paint surface shows signs of dirt embedding (i.e. loss of gloss).

MB-Fine Polishing Paste must be used when the paint surface shows signs of excessive fading/ chalking due to lack of care etc..

Do not apply any of these products or wax if your car is parked in the sun or if the hood is still hot.

Use the appropriate MB-Touch-Up Stick for quick and provisional repairs of minor paint damage (i.e. chips from stones, car doors etc.).

Light Alloy Wheels

MB-Autoshampoo should be used for regular cleaning of the light alloy wheels.

If possible, clean wheels once a week with MB-Autoshampoo, using a soft sponge and an ample supply of lukewarm water.

If the MB-Autoshampoo does not satisfactorily clean the wheels, use MB Protective Agent for Light Alloy Wheels for normal cleaning and MB-Cleaner for Light Alloy Wheels for heavier dirt accumulation.

Follow instructions on container. Note: Use only acid-free cleaning materials. The acid could lead to corrosion.

Ornamental Moldings

For regular cleaning and care of very dirty chrome-plated parts, use a chrome cleaner.

Automatic Antenna and Rear Fender Indicators

For trouble-free operation of the automatic antenna and rear fender indicators, we recommend that you clean them periodically.

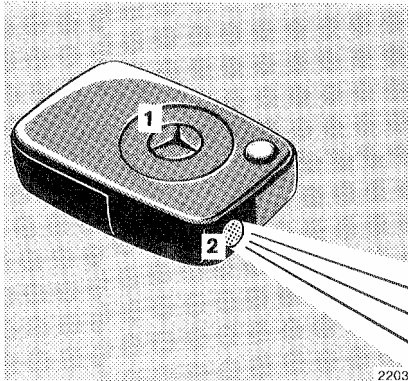

Testing Infrared Remote Control Checking Batteries:

If the transmit button (1) is pressed longer than 1 second, the battery indicator lamp in the transmitter eye (2) briefly illuminates -indicating that the batteries are in order.

Change batteries if the indicator lamp does not come on.

Changing Batteries:

Unfold key from holder by pressing lock button (3). Pull off battery cover (4).

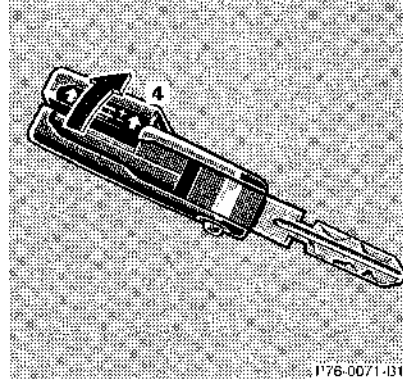

Change batteries, inserting new ones under contact spring (5) with plus (+) side facing up. Press battery cover onto housing until locked in place.

Important!

Batteries contain materials that can harm the environment if disposed of improperly. Recycling of batteries is the preferred method of disposal. For disposal, please follow manufacturer's recommendation on battery package. Replacement battery: Type VARTA V675PX or equivalent. Replacement battery: Lithium, type CR 2025 or equivalent.

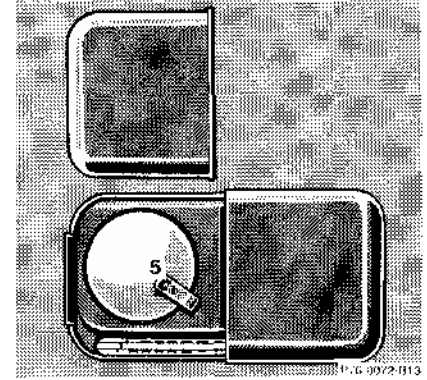

Synchronizing System:

The system may have to be re-synchronized, if the transmitter is without voltage for several minutes.

To synchronize system, aim transmitter eye (2) at door or trunk receiver and briefly press transmit button (1). Within approx. 30 seconds, insert key in steering lock and turn it to position 2.

The infrared remote control should once again be operational.

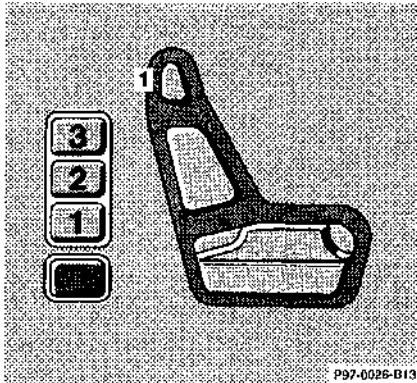

Front Head Restraints

Removal:

Push button (1) up to bring the head restraint to its highest position.

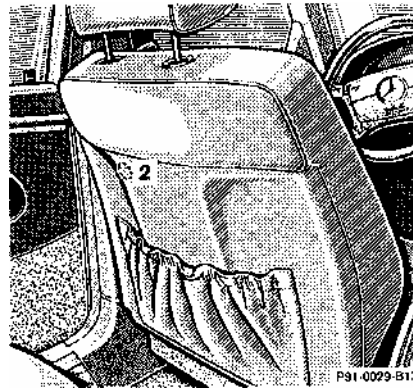

Depress release button (2) beneath the seatback covering material and pull head restraint up sharply, holding it by the left head restraint post (viewed in driving direction).

Pull out head restraint completely with both hands.

Installation:

Push button (1) up for approximately 5 seconds.

Insert the head restraint and push it down to the stop.

Adjust head restraint to the desired position.

Warning!

For your protection, drive only with properly positioned head restraints.

Do not drive the vehicle without the seat head restraints. Head restraints are intended to help reduce injuries during an accident.

For positioning of head restraints refer to sections *Power Seats, Front,* and *Head Restraints, Rear* in Index.

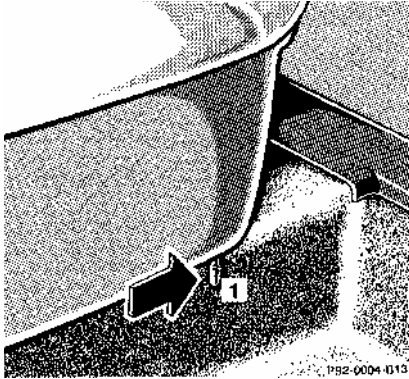

Rear Seat Cushion

Removal: Push in locking tabs (1) (on left and right side of seat) and pull up seat at the front.

Installation: Slide rear edge of cushion under the backrest so that both wire loops under the backrest engage at the seat cushion. Push front of cushion down until it locks in place.

Caution!

Watch out for sharp edges when removing or installing the rear seat cushion, and make sure that it is securely locked in place again, to prevent injury.

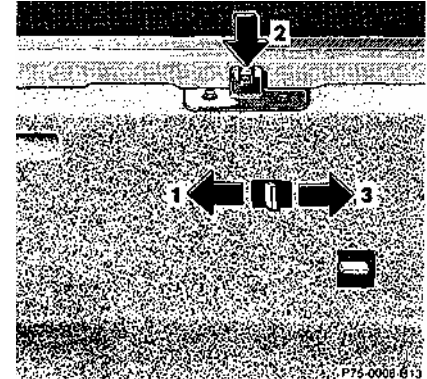

Manual Closing of Trunk Lid

The trunk lid can be closed manually should a malfunction occur on the power closing system.

With the trunk lid open:

push sliding switch to position (1),
press eye of latch in (2),

push sliding switch to position (3).
Close trunk lid.

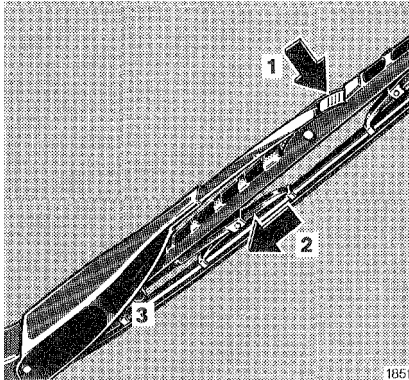

Replacing Wiper Blades

For safety reasons, remove key from steering lock before replacing a wiper blade, otherwise the motor can suddenly turn on and cause injury.

Windshield Wiper Blades

Removal:

Pull wiper blade arms upward from the rest position to their stop.

Replace wiper blades one at a time to prevent the wiper arms from sliding back to the rest position.

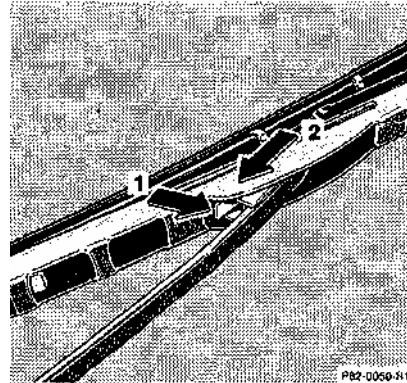

Fold wiper arm forward. Press safety tab down (1), push wiper blade downward (2) and remove,

Installation - driver's side:

Press safety tab of new wiper blade down. Insert wiper blade between the tabs (3) on the wiper arm and slide into end of wiper arm. Then press safety tab upward until it locks in place.

Installation - passenger side:

Fold wiper arm forward and slide wiper blade into end of wiper arm until safety tab locks in place.

Note:

Do not open engine hood with wiper arms folded forward.

Do not allow wiper arms to contact the windshield glass without wiper blades inserted. The glass may be scratched or broken.

Make certain that the wiper blade is properly installed. An improperly installed blade may cause windshield damage.

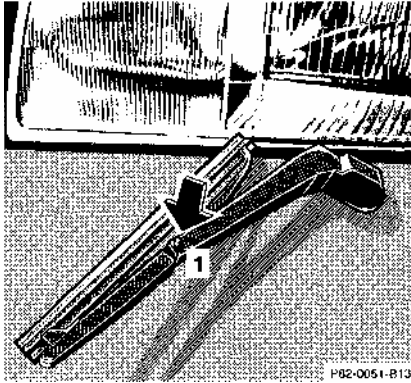

Headlamp Wiper Blades

Removal:

Fold wiper arm forward. Push pin (1) and remove wiper blade.

Installation:

Place wiper blade on wiper arm and press in pin (1).

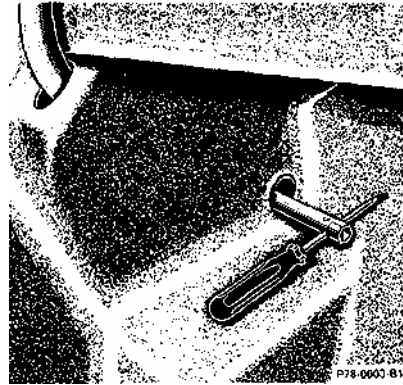

Manual Release of Fuel Filler Flap

The manual release knob is located behind the right side trunk panel and felt pad.

In case the central locking system does not release the fuel filler flap, pull the manual release knob while simultaneously opening the fuel filler flap.

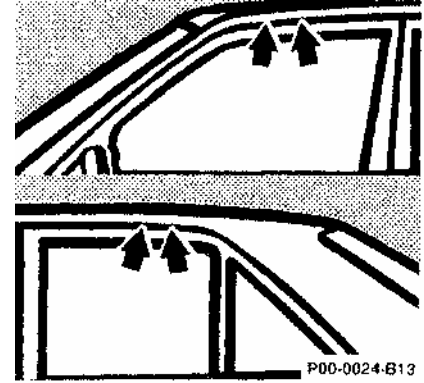

Roof Rack

Use only those roof racks approved by Mercedes-Benz to avoid damage to the vehicle. Follow manufacturer's installation instructions.

Mount supports only between markings on border of roof which are visible when doors are opened.

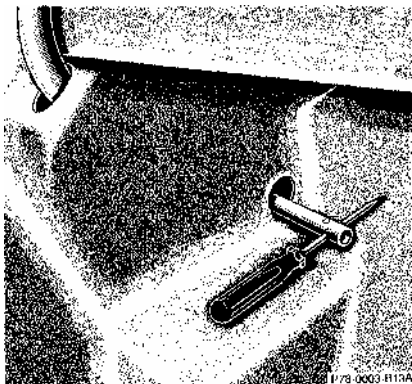

Emergency Operation of Sliding Roof

The sliding roof can be opened or closed manually should an electrical malfunction occur.

Fold back access cover in left side panel of trunk with a screwdriver. Insert socket wrench (from tool kit) through opening in panel and place on the hex-drive of the electric motor. Turn socket wrench (manually) to open or close roof as desired.

To slide the roof closed or to raise the roof at the rear: turn clockwise.

To slide the roof open or to lower the roof at the rear: turn counterclockwise.

Spare Parts Service

All authorized Mercedes-Benz dealers maintain a stock of original spare parts required for maintenance and repair work. In addition, strategically located parts distribution centers provide quick and reliable parts service,

More than 300,000 different spare parts, even for older models, are available.

Mercedes-Benz original spare parts are subjected to the most stringent quality inspections. Each part has been specifically developed, manufactured or selected for and adapted to Mercedes-Benz vehicles.

Therefore, Mercedes-Benz original spare parts should be installed.

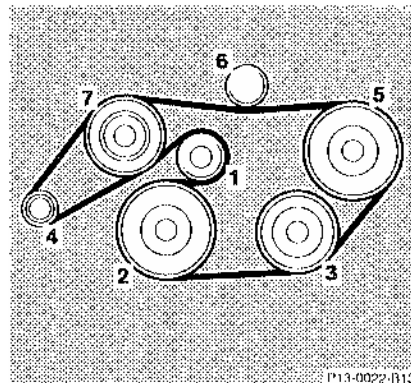

Layout of Poly-V-belt Drive

- 1 Automatic belt tensioner
- 2 Crankshaft
- 3 Air conditioning compressor
- 4 Generator (alternator)
- 5 Power steering pump
- 6 Idler pulley
- 7 Coolant pump - fan

For dimensions of the poly-V-belt, see *Technical Data* in Index.

Technical Data

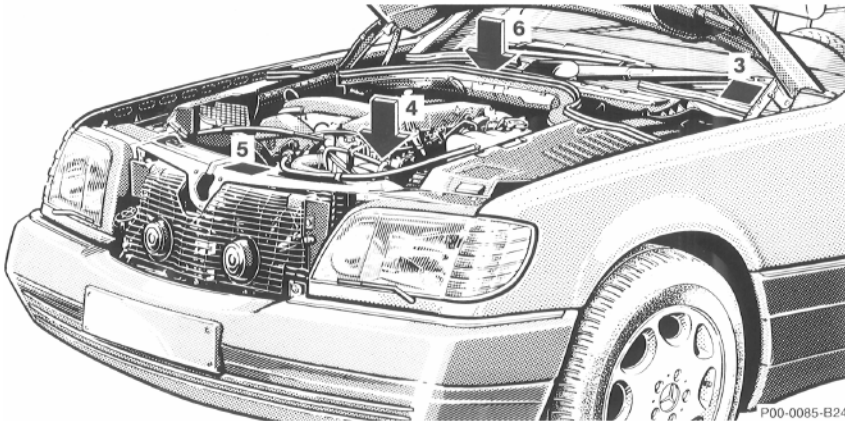
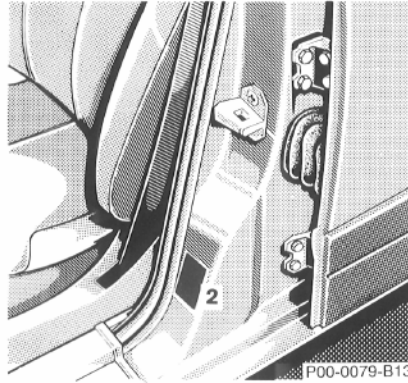
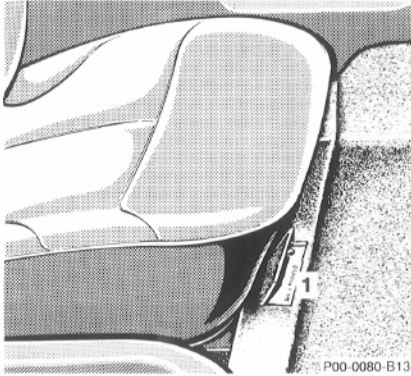

Identification Plates

When ordering spare parts, please specify vehicle identification and engine numbers.

- 1 Vehicle Identification No.
- 2 Certification Tag
- 3 Identification Tag
(lower edge of windshield)
- 4 Engine No.
- 5 Body No. and Paintwork No.
- 6 Emission Control Tag

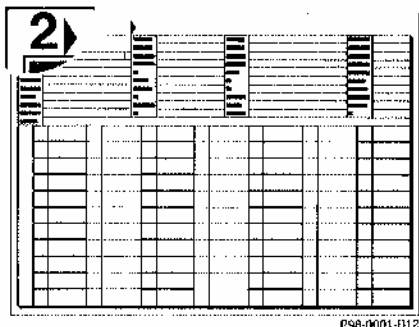

Vehicle Data Card

The vehicle data card contains all important data pertaining to the vehicle. It should be kept in the maintenance booklet where indicated, and it is needed when obtaining replacement or additional keys at your authorized Mercedes-Benz dealer.

Warranty Coverage

Your car is covered under the terms of the "warranties" printed in the Owner's Service and Warranty Policy Booklet and your authorized MERCEDES-BENZ dealer will exchange or repair any defective parts in accordance with the terms of the following warranties:

1. New vehicle limited warranty
2. Emission systems warranty
3. Emission performance warranty

Loss of Owner's Service and Warranty Policy

Should you lose your Owner's Service and Warranty Policy Booklet, have your authorized MERCEDES-BENZ dealer arrange for a replacement. It will be mailed to you.

Technical Data

Model S 350 TURBODIESEL (140 134)¹

Engine 603

Mode of operation Diesel four stroke

No. of cylinders 6

Bore 89.90 mm (3.54 in)

Stroke 92.40 mm (3.60 in)

Total piston displacement 3449 m³ (210.5 cu.in)

Compression ratio 22:1

Output acc. to SAE J 1349 110 kW/4000rpm
(148 hp/4000 rpm)

Maximum torque acc. to SAE J 1349 310 Nm/2200 rpm
(229 ft-lb/2200 rpm)

Maximum engine speed 4750 rpm

Firing order 1-5-3-6-2-4

Poly – V belts length 2145 mm

Transmission

Downshift points, D to 3: 124 mph (200 km/h)

3 to 2: 79 mph (127 km/h)

2 to B: 46 mph (74 km/h)

¹ The quoted data apply only to the standard vehicle. See an authorized Mercedes-Benz dealer for the corresponding data of all special bodies and special equipment.

Electrical System

Generator (alternator) 14 V/90 A

Starter motor 12 V/2.2 kW

Battery 12 V/100 Ah

Rims – Tires

Rims

(light alloy rims) 7 1/2 J x 16 H 2

Wheel offset 51 mm (2.0 in)

Summer tires:

Radial-ply tires 225/60 R16 98 H M+S

Winter tires:

Radial-ply tires 225/60 R16 98 H M+S

Weights See certification tag

Roof load max. 100 kg (220 lb)

Trunk load max. 100 kg (220 lb)

Main Dimensions

Overall vehicle length 5213 mm (201.3 in)

Overall vehicle width 1886 mm (74.3 in)

Overall height: 1483 mm (58.4 in)

Wheel base 3140 mm (123.6 in)

Track, front 1606 mm (63.2 in)

Track, rear 1579 mm (62.2 in)

Fuels , Coolants, Lubricants etc. - Capacities

Vehicle components and their respective lubricants must match.

Therefore use only brands tested and recommended by us.

Inquire at your authorized Mercedes-Benz dealer.

	Capacity	Fuels, coolants, lubricants etc.
Engine with oil filter	8.0 l (8.5 US qt)	Recommended engine oils
Automatic transmission	Initial fill: 7.3 l (7.7 US qt) Fluid change: 6.2 l (6.6 US qt)	Automatic transmission fluid
Rear axle	1.3 l (1.4 US qt)	Hypoid gear oil SAE 90, 85 W 90
Hydraulic system for adaptive damping system (ADS)	approx. 2.1 US qt (2.0 l)	MB Hydraulic fluid
Power steering	approx. 1.4 US qt (1.3 l)	MB Power steering fluid
Front wheel hubs Accelerator control linkage	approx. 2.1 oz (60 g) each	High temperature roller bearing grease Hydraulic fluid
Brake system	approx. 0.7 US qt (0.7 l)	MB Brake fluid (DOT 4)

Model	Capacity	Fuels, coolants, lubricants etc.
Windshield washer and headlamp cleaning system	approx. 5.3 US qt (5.0 l)	MB Windshield washer concentrate "S" ¹
Cooling system	approx. 11.6 US qt (11.0 l)	MB Anticorrosion/antifreeze
Fuel tank including a reserve of	approx. 26.4 US gal (100 l) approx. 3.3 US gal (12.5 l)	Premium unleaded gasoline: Posted Octane 91 (Average of 96 RON/86 MON)
Air conditioner system		R-134a refrigerant and special lubricant(<i>Never R-12</i>) (selected vehicles - see underhood label)

¹ Use MB Windshield Washer Concentrate "S" and water for temperatures above freezing or MB Windshield Washer Concentrate "S" and commercially available premixed windshield washer solvent/antifreeze for temperatures below freezing. Follow suggested mixing ratios, see *Windshield/Headlamp Washer System* in Index.

Engine Oils

Engine oils are specifically tested for their suitability in our engines. Therefore, use only engine oils recommended by Mercedes-Benz. Information on recommended brands is available at your authorized Mercedes-Benz dealer.

Please follow maintenance booklet recommendations for scheduled oil changes. Failure to do so could result in engine damage not covered by the Mercedes-Benz Limited Warranty.

Engine Oil Additives

Do not blend oil additives with engine oil. They may be harmful to the engine operation.

Damage or malfunctions resulting from blending oil additives are not covered by the Mercedes-Benz Limited Warranty.

Brake Fluid

During vehicle operation, the boiling point of the brake fluid is continuously reduced through the absorption of moisture from the atmosphere. Under extremely hard operating conditions, this moisture content can lead to the formation of bubbles in the system thus reducing the system's efficiency.

The brake fluid must therefore be replaced every two years, preferably in the spring.

It is recommended to use only brake fluid approved by Mercedes-Benz. Your authorized Mercedes-Benz dealer will provide you with additional information.

Air Conditioner Refrigerant

Ozone-friendly HFC-134a refrigerant and special lubricating oil is used in the air conditioner system.

Never use R-12 (CFC) or mineral-based lubricating oil, otherwise damage to the system will occur.

Diesel Fuels

Use only commercially available vehicular diesel fuels No. 2 or No. 1 (ASTM D 975 No. 2-D or No. 1-D).

Marine diesel fuel, heating oil or the like must not be used.

At very low temperatures the fluidity of No. 2 diesel fuel may become insufficient due to paraffin separation. For this reason the vehicle comes equipped with a fuel preheater. The fuel preheater only works with the vehicles interior heater operating. It permits a trouble free engine operation to a temperature of approximately + 14°F (-10°C) when using No. 2 diesel fuel.

To avoid malfunctions, No. 2 diesel fuel of a lowered cloud point is marketed during the cold season.

At temperatures below + 14°F (-10°C) use winterized or No. 1 diesel fuel only. If not available, a certain quantity of kerosene or fuel flow improver (refer to MB Factory

Approved Service Products pamphlet) may be added. Mixing only to be done within the cars' fuel tank. Kerosene or fuel flow improver has to be filled in before the diesel fuel.

Engine power may drop according to the proportion of kerosene. For this reason, keep percentage of kerosene added to the minimum necessitated by the ambient temperature.

The following table can be used as a reference, if adding of kerosene becomes necessary. The mixing ratios shown refer to the total mixture.

Ambient temperature
+ 14°F to -4°F (-10°C to -20°C)
No. 2 Diesel Fuel: 70%
Kerosene: 30%

Ambient temperature below
4 °F (-20°C)
No. 2 Diesel Fuel: 50%
Kerosene: 50%

Even in extreme climatic conditions, the maximum mixture ratio should not exceed 50%.

Adding of kerosene to No. 1 diesel fuel is not recommended even at low temperatures.

Do not blend other specific fuel additives with fuel. They only result in unnecessary cost, and may be harmful to the engine operation.

Damage or malfunctions resulting from poor fuel quality or from blending specific fuel additives are not covered by the Mercedes-Benz Limited Warranty.

Warning!

Under no circumstances should gasoline be mixed with diesel fuel.

Always follow basic safety rules when working with any combustible material. Do not fill the fuel tank or mix diesel fuel and kerosene when smoking, near an open flame or while the vehicle's engine is running. An explosion or fire can result.

Coolants

The engine coolant is a mixture of water and anticorrosion/anti-freeze, which provides:

- corrosion protection
- freeze protection
- boiling protection (by increasing the boiling point).

The cooling system was filled at the factory with a coolant providing freeze protection to approx. -22 °F (-30 °C) and corrosion protection.

The coolant solution must be used year round to provide the necessary corrosion protection and increase in the boil-over protection. You should have it replaced every 3 years.

To provide the important corrosion protection, the solution must be at least 45% anticorrosion/antifreeze (equals a freeze protection to approx. -22 °F [-30 °C]). If you use a solution that is more than 55% anticorrosion/antifreeze (freeze protection to approx. -49 °F [-45°C]), the engine temperature will increase due to the lower

Heat transfer capability of the solution. Therefore, do not use more than this amount of anti-corrosion/antifreeze.

If the coolant level is low, water and MB anticorrosion/antifreeze should be used to bring it up to the proper level (have cooling system checked for signs of leakage).

The water in the cooling system must meet minimum requirements, which are usually satisfied by normal drinking water. If you are not sure about the water quality, consult your authorized Mercedes-Benz dealer.

Anticorrosion/antifreeze

Your vehicle contains a number of aluminum parts. The use of aluminum components in motor vehicle engines necessitates that anticorrosion/antifreeze coolant used in such engines be specifically formulated to protect the aluminum parts. (Failure to use such anticorrosion/antifreeze coolant will result in a significantly shortened service life.)

Therefore the following product is strongly recommended for use in your car: Mercedes-Benz Anticorrosion/Antifreeze Agent.

Before the start of the winter season (or once a year in the hot southern regions), you should have the anticorrosion/antifreeze concentration checked. The coolant is also regularly checked each time you bring your vehicle to your authorized Mercedes-Benz dealer for maintenance service.

Approx. freeze	Anticorrosion/antifreeze
-35 ° F (-37 ° C)	5.3 US qt (5.0 l)
-49 ° F (-45 ° C)	6.3 US qt (6.0 l)

Consumer Information

This has been prepared as required of all manufacturers of passenger cars under Title 49, Code of U.S. Federal Regulations, Part 575 pursuant to the "National Traffic and Motor Vehicle Safety Act of 1966".

Uniform Tire Quality Grading

Refer to the tire sidewall for the specific tire grades for the tires with which this vehicle is equipped.

All passenger car tires must conform to federal safety requirements in addition to these grades.

Treadwear

The treadwear grade is a comparative rating based on the wear rate of the tire when tested under controlled conditions on a specified government test course. For example, a tire graded 150 would wear one and one-half (1½) times as well on the government course as a tire graded 100. The relative performance of tires "depends upon the actual conditions of their use, however

and may depart significantly from the norm due to variations in driving habits, service practices and differences in road characteristics and climate.

Traction "A", "B", "C"

The traction grades, from highest to lowest, are "A", "B" and "C" and they represent the tire's ability to stop on wet pavement as measured under controlled conditions on specified government test surfaces of asphalt and concrete. A tire marked "C" may have poor traction performance.

Warning!

The traction grade assigned to this tire is based on braking (straight ahead) traction tests and does not include cornering (turning) traction.

Temperature "A", "B", "C"

The temperature grades are "A" (the highest), "B" and "C", representing the tire's resistance to the generation of heat and its ability to dissipate heat when

tested under controlled conditions on a specified indoor laboratory test wheel. Sustained high temperature can cause the material of the tire to degenerate and reduce tire life, and excessive temperature can lead to sudden tire failure. The grade "C" corresponds to a level of performance which all passenger car tires must meet under the Federal Motor Vehicle Safety Standard No. 109. Grades "B" and "A" represent higher levels of performance on the laboratory test wheel than the minimum required by law.

Warning!

The temperature grade for this tire is established for a tire that is properly inflated and not overloaded. Excessive speed, underinflation, or excessive loading, either separately or in combination, can cause excessive heat build up and possible tire failure.

Problems with your Vehicle

If you should experience a problem with your vehicle, particularly one that you believe may affect its safe operation, we urge you to immediately contact your authorized Mercedes-Benz dealer to have the problem diagnosed and corrected if required. If the matter is not handled to your satisfaction, please discuss the problem with the dealership management, or if necessary contact the Owner Service Manager at the Mercedes-Benz Regional Office nearest you (see Owner's Service and Warranty Information booklet for addresses). You may also write directly to us at the following addresses:

In the U.S.A.: Owner Service Department
Mercedes-Benz of North America Inc.
One Mercedes Drive
Montvale, NJ 07645-0350

In Canada: Owner Service Department
Mercedes-Benz Canada Inc.
849 Eglinton Avenue East
Toronto, Ontario, M4G 2L5

For the U.S.A. only.
The following text is published as required of manufacturers under Title 49, Code of U.S. Federal Regulations, Part 575 pursuant to the "National Traffic and Motor Vehicle Safety Act of 1966".

Reporting Safety Defects

If you believe that your vehicle has a defect which could cause a crash or could cause injury or death, you should immediately inform the National Highway Traffic Safety Administration (NHTSA) in addition to notifying Mercedes-Benz of North America Inc..

If NHTSA receives similar complaints, it may open an investigation, and if it finds that a safety defect exists in a group of vehicles, it may order a recall and remedy campaign. However, NHTSA cannot become involved in individual problems between you, your dealer, or Mercedes-Benz of North America Inc..

To contact NHTSA, you may either call the Auto Safety Hotline toll-free at 1-800-424-9393 (or 366-0123 in Washington, D.C. area) or write to: NHTSA, U.S. Department of Transportation, Washington, D.C. 20590. You can also obtain other information about motor vehicle safety from the Hotline.

Index:

ABS [73](#), [82](#)
Activated charcoal filter [25](#)
Adaptive damping system (ADS)
[84](#)
ADS [84](#), [106](#), [125](#)
Air conditioner refrigerant [127](#)
Air outlets [23](#)
Airbag [47](#)
Alarm system [34](#)
Antenna [68](#), [113](#)
Anti-theft alarm system [34](#)
Anticorrosion/antifreeze [86](#), [89](#),
[126](#), [129](#)
Antilock brake system (ABS) [82](#)
Armrest, front [40](#)
Armrest, rear [41](#)
Ashtrays [62](#)
Automatic climate control [21](#)
Automatic transmission [71](#)
Automatic transmission fluid level,
checking [91](#)

Battery [106](#)
Battery not being charged
Charge indicator lamp [14](#), [76](#)
Brake fluid [15](#), [81](#), [110](#), [125](#), [127](#)
Brake pads worn
Brake pad wear indicator lamp
[80](#)
Brake warning lamp
Brake fluid low [81](#)
Brake warning lamp test [81](#)
Brakes [15](#), [17](#), [70](#), [72-73](#), [75](#)

Capacities: Fuels, coolants,
lubricants etc. [125](#)
Cellular telephone [68](#)
Central locking system [30](#)
Check regularly and before a long
trip [140](#)
Child restraint [40](#), [45-46](#), [49](#), [51](#)
Cleaning and care of the vehicle
[110](#)
Clock, setting [67](#)
Combination switch [53](#)
Consumer information [130](#)
Coolant level low
Adding coolant [89](#)
Low engine coolant level
warning lamp [79](#)
Coolant level, checking [89](#)
Coolant temperature gauge [78](#) - [79](#)
Coolants [129](#)
Cruise control [74](#)

Diesel fuels [128](#)
Display illumination [67](#)
Drinking and driving [70](#)
Driving instructions [15](#)
Driving off [70](#)

Electronic traction system
(ETS) [83](#)
Emergency tensioning retractor
(ETR) [46](#)
Emission control [85](#)
Engine oil consumption [77](#)
Engine oil level low
Low engine oil level warning
lamp [90](#)
Engine oil level, checking [90](#)
Engine oil pressure gauge [76](#)
Engine oils [125](#), [127](#)
Engine overheating [78](#)
Engine speed limit Overrevving [73](#)
Engine, turning off manually [92](#)
ETS [83](#), [109](#)
Exterior lamp failure indicator
lamp [80](#)
Exterior lamp switch [55](#)

First aid kit [93](#)
Fuel consumption gauge [77](#)
Fuel filler flap, manual release
[118](#)
Fuel reserve warning lamp [78](#)
Fuel system, bleeding [92](#)
Fuses [105](#)

Head restraints, front [35](#)
Head restraints, rear [41](#)
Head restraints, removal [115](#)
Headlights [55](#)
Heated seats [39](#)
Hood [88](#)

Identification plates [122](#)
Indicator lamp symbols [13](#)
Instrument cluster [12](#)
Instrument lamps [67](#)
Interior lighting [60](#)

Jump starting [107](#)

Keys, vehicle [26](#)

Lamps, exterior
Fog lamps [55](#)
Headlamps [55](#), [80](#), [100](#)
High mounted stop lamp [105](#)
License plate lamp [55](#), [104](#)
Taillamps [55](#), [104](#), [111](#)
Layout of poly-V-belt drive [119](#)
Lighter [62](#)
Low engine oil Level warning lamp
[76](#)
Lumbar support [38](#)

Maintenance [4](#), [8](#)
Memory [36](#)
Mirrors, adjusting [57](#)
Multicontour backrest [38](#)

Outside temperature indicator [78](#)

Parking brake [14-15](#), [17](#), [62](#), [70-73](#),
[81](#), [83](#), [91](#), [94](#), [96](#), [107](#)
Power closing assist for doors and
trunk lid [33](#)
Power seats, front [35](#)
Power windows [64](#)
Problems with your vehicle [131](#)

Radio transmitters [8](#)
Reading lamps [60](#)
Rear fender indicators [74](#)
Rear passenger compartment
adjustable air outlet [24](#)
Rear passenger compartment
climate control [25](#)
Rear seat cushion [116](#)
Rear view mirrors
Exterior rear view mirrors [57](#)
Inside rear view mirror [36](#) -
[37](#), [42](#), [56](#) - [58](#)
Rear window defroster [66](#)
Rear window sunshade [65](#)
Remote control, infrared [27](#), [114](#)
Replacing bulbs [101](#)
Roadside assistance [5](#)
Roof rack [118](#)

Safety guidelines for the seat belt,
emergency tensioning retractor
and airbag [50](#)
Seat belt warning lamp [80](#)
Seat belts and warning system [43](#)
Shelf below rear window [68](#)
Sliding roof Emergency operation [119](#)
Sliding roof operation [63](#)
Snow chains [86](#)
Spare parts service [119](#)
Spare wheel [93](#)
SRS malfunction [47](#)
Starting and turning off the engine
[14](#)
Steering lock [52](#)
Steering wheel, adjustable [42](#)
Storage compartments [61](#)
Stowing things in the vehicle [93](#)
Sun visors [59](#)
Supplemental restraint system
(SRS) [43](#), [46](#)

Technical data [124](#)
Tire inflation pressure [99](#)
Tires [16-17](#), [83](#), [86](#), [95](#), [99](#), [124](#), [130](#)
Towing the vehicle [109](#)
Traveling abroad [85](#)
Trip odometer [67](#)
Trunk lamp [93](#)
Trunk lid
 Manual closing [116](#)
 Release switch [64](#), [66](#)
Trunk, separately locked [31](#)
Turn signals [53-54](#)

Vanity mirrors [59](#)
Vehicle data card
Vehicle jack [94](#)
Vehicle tools [94](#)

Warranty coverage [123](#)
Washing the car [111](#)
Wheels
 Alloy wheels [113](#)
 Rims and tires [95](#)
 Wheels, changing [96](#)
Windshield/headlamp washer system
 Fluid level low [79](#)
 Washer fluid mixing ratio [54](#)
Winter driving [86](#)
Winter driving instructions [18](#)
Wiper blades, replacing [117](#)

Service and Literature

Your authorized Mercedes-Benz dealer has trained technicians and original Mercedes-Benz parts to service your vehicle properly. For expert advice and quality service, see your authorized Mercedes-Benz dealer.

If you are interested in obtaining service literature for your vehicle, please contact your authorized Mercedes-Benz dealer.

We consider this to be the best way to obtain accurate information for your vehicle.

Warning!

To help avoid personal injury, be extremely careful when performing any maintenance work or repairs. Improper or incomplete service may damage the vehicle or its equipment, which may in turn result in personal injury.

If you have any question about carrying out some service, turn to the advice of an authorized MERCEDES-BENZ dealer.

Check Regularly and Before a Long Trip

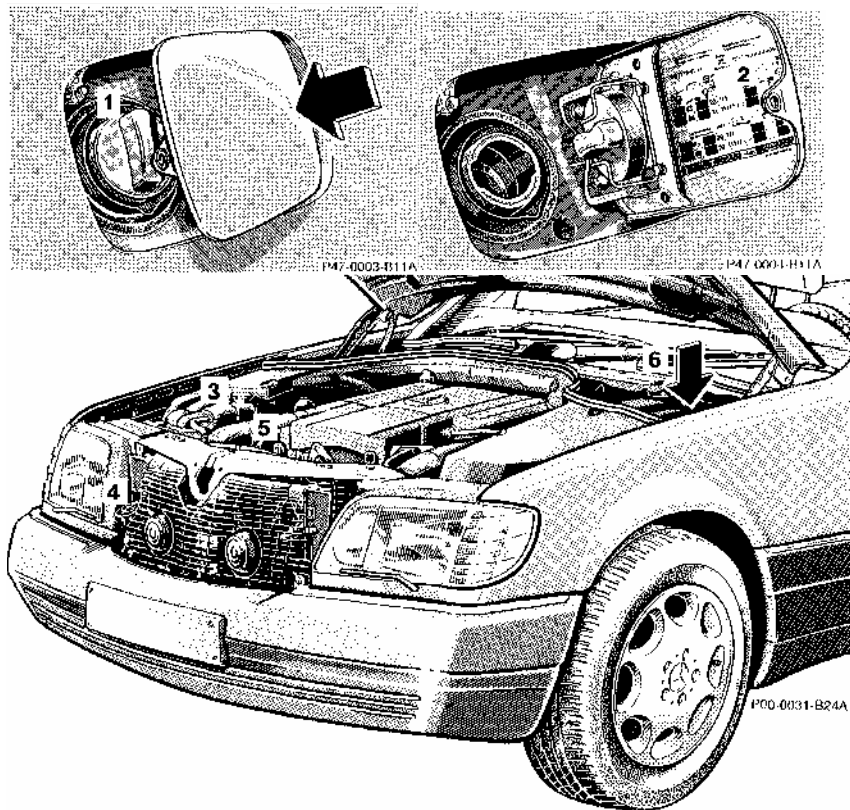

1 Fuel Supply

To add fuel turn cap to the left and hold on to it until possible pressure in tank has been released, then remove cap. Failure to do so could result in personal injury.

2 Tire Inflation Pressure

Check at least every two weeks. For details see Index.

3 Coolant Level

See *Adding coolant* in Index.

4 Windshield Washer System, Headlamp Cleaning System

For refilling reservoir see Index.

5 Engine Oil Level

See Index.

6 Brake Fluid

See Index.

Vehicle Lighting:

Check function and cleanliness. For replacement of light bulbs, see Index.

What You Should Know at the Gas Station

- **Fuel:**

Use premium unleaded gasoline: Posted Octane index 91 (Average of 96 RON/86 MON).

Fuel tank capacity approx. 21.1 US gal (80 l). This includes approx .2.6 US gal (10 l) reserve.

Only fill fuel tank until the filler nozzle unit cuts out - do not overfill.

Warning!

Gasoline vapor is highly flammable. It burns violently and can cause serious injury. Whenever you are around gasoline, extinguish all smoking materials. Never get sparks, flame or smoking materials near gasoline!

- **Engine Oil:**

Engine oil level check, see Index.

Quantity differential between upper and lower dipstick marking level: 2.1 US qt (2.0 l).

Recommended engine oils, see Index.

- **Automatic Transmission:**

Automatic transmission fluid. For level checks refer to Index.

- **Coolant:**

For normal replenishing, use water (potable water quality). For further information (e.g. anticorrosion/antifreeze), refer to Index.

- **Spark Plugs:**

Approved spark plugs, refer to "Technical Data" (also see Index).

- **Bulbs:**

High and low beams: Halogen type 9004,
fog lamps: Halogen type H 1 (55 W),
tail, parking, standing and driver's side
rear fog lamp 21/4 W/ 35/ 1.2 cp,
turn signal, standing, side marker and parking
lamps, front 21/5 W/ 32P/3 cp,
turn signal lamps, rear 21W/ 32 cp,
stop lamps 21 W/ 32 cp,
license plate lamps 5 W.

- **Tire Pressure:**

For tire pressure, refer to tire pressure inside the fuel filler flap.

- **Air Conditioner:**

R-134a refrigerant and special lubricant (in selected vehicles - see underhood label) refer to "Technical Data" (also see Index).

Free Manuals Download Website

<http://myh66.com>

<http://usermanuals.us>

<http://www.somanuals.com>

<http://www.4manuals.cc>

<http://www.manual-lib.com>

<http://www.404manual.com>

<http://www.luxmanual.com>

<http://aubethermostatmanual.com>

Golf course search by state

<http://golfingnear.com>

Email search by domain

<http://emailbydomain.com>

Auto manuals search

<http://auto.somanuals.com>

TV manuals search

<http://tv.somanuals.com>