



Operator's Manual
SL-Class



Mercedes-Benz



Order No. 6515 3053 13 Part No. 230 584 45 82 USA Edition A, 2005

SL 500

SL 55 AMG

SL 600

SL 65 AMG

Our company and staff congratulate you on the purchase of your new Mercedes-Benz.

Your selection of our product is a demonstration of your trust in our company name. Furthermore, it exemplifies your desire to own an automobile that will be as easy as possible to operate and provide years of service.

Your Mercedes-Benz represents the efforts of many skilled engineers and craftsmen. To help assure your driving pleasure, and also the safety of you and your passengers, we ask you to make a small investment of time:

- Please read this manual carefully, then return it to your vehicle where it will be handy for your reference.
- Please follow the recommendations contained in this manual. They are designed to acquaint you with the operation of your Mercedes-Benz.
- Please pay attention to the warnings and cautions contained in this manual. They are designed to help improve the safety of the vehicle operator and occupants.

We extend our best wishes for many miles of safe, pleasurable driving.

Mercedes-Benz USA, LLC
A DaimlerChrysler Company

Contents

Introduction	9	At a glance	21	Getting started	33
Product information	9	Cockpit	22	Unlocking	34
Operator's Manual	10	Instrument cluster	24	Unlocking with the SmartKey	34
Service and warranty information ..	10	Multifunction steering wheel	28	Unlocking with KEYLESS-GO*	35
Important notice for California		Center console	29	Starter switch positions	36
retail buyers and lessees of		Upper part	29	Adjusting	39
Mercedes-Benz automobiles	11	Lower part	30	Seats	39
Maintenance	12	Overhead control panel	31	Steering wheel	42
Roadside Assistance	12	Door control panel	32	Mirrors	43
Change of address or ownership....	12			Driving	45
Operating your vehicle outside the				Fastening the seat belts	45
USA or Canada	13			Starting the engine	48
Where to find it	14			Switching on headlamps	51
Symbols	15			Turn signals	52
Operating safety	16			Windshield wipers	53
Proper use of the vehicle	16			Problems while driving	55
Problems with your vehicle	17			Parking and locking	56
Reporting safety defects	18			Parking brake	57
Reporting safety defects	18			Switching off headlamps	57
Vehicle data recording	19			Turning off the engine	58
Information regarding electronic				Emergency engine shut-down	60
recording devices	19				

Contents

Safety and Security	61	Controls in detail	93	Memory function	120
Occupant safety	62	Locking and unlocking	94	Storing positions into memory	121
Airbags	63	SmartKey	94	Recalling positions from memory	121
Seat belts	69	SmartKey with KEYLESS-GO*	98	Storing exterior rear view mirror	
Roll bar	73	Opening the doors from the inside	106	parking position	121
Children in the vehicle	74	Opening the trunk	107	Lighting	123
Panic alarm	78	Closing the trunk	109	Exterior lamp switch	123
Activating	78	Trunk lid emergency release	109	Combination switch	128
Deactivating	78	Automatic central locking	110	Hazard warning flasher	128
Driving safety systems	79	Locking and unlocking from the		Interior lighting	129
ABS	80	inside	111	Courtesy lighting	130
BAS	81	Seats	113	Instrument cluster	131
ESP	82	Easy-entry / exit feature	113	Instrument cluster illumination	131
SBC brake system	85	Moving the seats forward and		Coolant temperature gauge	131
Anti-theft systems	88	backward	115	Trip odometer	132
Immobilizer	88	Lumbar support	115	Tachometer	132
Anti-theft alarm system	88	Multicontour backrest*		Outside temperature indicator	133
Tow-away alarm	90	(standard on SL 600, SL 55 AMG,		Control system	134
		and SL 65 AMG)	116	Multifunction display	134
		Seat heating	117	Multifunction steering wheel	135
		Seat ventilation*		Menus	137
		(standard on SL 600 and		Standard display menu	139
		SL 65 AMG)	119	AUDIO menu	139
				NAV menu	142
				Distronic* menu	142

Contents

Vehicle status message memory menu.....	143	Automatic climate control	182	Driving systems.....	205
Settings menu.....	144	Setting the temperature.....	185	Cruise control	205
Trip computer menu.....	159	Adjusting air volume	185	Distronic*	208
TEL menu*	161	Adjusting air distribution.....	186	Active Body Control (ABC)	220
Automatic transmission.....	164	Maximum cooling MAXCOOL.....	186	Parktronic* (Parking assist).....	223
One-touch gearshifting.....	166	Defrosting windshield	187	Useful features.....	228
Gear ranges	167	Air recirculation mode	187	Storage compartments.....	228
Gear selector lever position	168	Rear window defroster.....	189	Ashtray	233
Automatic shift program	170	Residual heat and ventilation.....	190	Cigarette lighter.....	233
Driving tips.....	171	Deactivating the automatic climate control system	191	Heated steering wheel* (SL 500, SL 600).....	234
Steering wheel gearshift control (Speedshift).....	172	Air conditioning.....	191	Load assist in the trunk	235
Manual shift program		Ventilated storage compartments.....	192	Electrical outlet.....	236
SL 55 AMG and SL 65 AMG	175	Power windows	193	Telephone*	236
Emergency operation (Limp Home Mode)	177	Opening and closing the windows.....	193	Tele Aid.....	237
Good visibility	178	Synchronizing power windows.....	195	Garage door opener.....	246
Headlamp cleaning system	178	Retractable hardtop.....	196		
Rear window defroster.....	178	Opening and closing the retractable hardtop.....	196		
Rear view mirrors.....	178				
Sun visors	180				

Contents

Operation	253	At the gas station	267	Maximum tire load	301
The first 1000 miles (1500 km)	254	Refuelling	267	Maximum tire inflation pressure ..	302
Driving instructions.....	255	Check regularly and before a		Uniform Tire Quality Grading	
Drive sensibly – save fuel.....	255	long trip.....	269	Standards (U.S. vehicles).....	302
Drinking and driving	255	Engine compartment	270	Tire ply material	304
Pedals	255	Hood	270	Tire and loading terminology.....	305
Power assistance	256	Engine oil	272	Rotating tires	308
Brakes	256	Transmission fluid level.....	275	Winter driving	309
Driving off.....	258	Oil level in the ABC system	275	Winter tires	309
Parking	259	Coolant	276	Block heater (Canada only).....	310
Tires	259	Battery	277	Snow chains.....	310
Hydroplaning.....	260	Windshield washer system and		Maintenance.....	312
Tire traction.....	261	headlamp cleaning system.....	278	Clearing the maintenance service	
Tire speed rating	261	Tires and wheels.....	279	indicator.....	313
Winter driving instructions	262	Important guidelines	279	Maintenance service term	
Standing water	263	Tire care and maintenance.....	280	exceeded	313
Passenger compartment	264	Direction of rotation	282	Calling up the maintenance	
Driving abroad.....	264	Loading the vehicle	282	service indicator	313
Control and operation of radio		Recommended tire inflation		Resetting the maintenance	
transmitters.....	264	pressure	288	service indicator	314
Catalytic converter	265	Checking tire inflation pressure ...	290	Vehicle care.....	315
Emission control.....	265	Tire labeling.....	295	Cleaning and care of the vehicle..	315
Coolant temperature	266	Load identification	299		
		DOT, Tire Identification Number			
		(TIN)	300		

Contents

Practical hints	323	Replacing wiper blades.....	386	Technical data	415
What to do if	324	Removing wiper blades.....	386	Parts service	416
Lamps in the instrument cluster ..	324	Installing wiper blades	387	Warranty coverage	417
AIRBAG OFF indicator lamp	334	Flat tire.....	388	Loss of Service and Warranty	
Vehicle status messages in the		Preparing the vehicle	388	Information Booklet	417
multifunction display.....	335	Sealing tires with TIREFIT.....	388	Identification labels	418
Where will I find ...?	372	Mounting the spare wheel	393	Layout of poly-V-belt drive.....	419
First aid kit.....	372	Batteries.....	401	SL 500	419
Vehicle tool kit, jack, and		Disconnecting the batteries.....	403	SL 55 AMG	419
spare wheel.....	372	Removing the batteries.....	404	SL 600, SL 65 AMG	419
Locking/unlocking in an emergency .	374	Charging and reinstalling		Engine	420
Unlocking the vehicle.....	374	batteries	404	Rims and tires	422
Locking the vehicle	376	Reconnecting the batteries.....	405	Same size tires	423
Lowering the load assist manually	376	Jump starting.....	406	Mixed size tires.....	425
Replacing batteries in the		Towing the vehicle.....	408	Spare wheel.....	427
SmartKey/SmartKey with		Installing towing eye bolt	411	Electrical system	428
KEYLESS-GO*	377	Fuses.....	412	Main dimensions	429
Replacing bulbs	380	Main fuse box	412	Weights	430
Bulbs	380				
Replacing bulbs for front lamps ...	383				
Replacing bulbs for rear lamps.....	385				

Contents

Fuels, coolants, lubricants, etc.	431	
Capacities	431	Technical terms 439
Engine oils.....	433	
Engine oil additives	433	
Air conditioner refrigerant	433	Index 445
Brake fluid	433	
Premium unleaded gasoline	434	
Fuel requirements	434	
Gasoline additives	435	
Coolants.....	435	
Windshield and headlamp washer system.....	438	

▼ **Product information**

Please observe the following in your own best interest:

We recommend using genuine Mercedes-Benz parts as well as conversion parts and accessories explicitly approved by us for your vehicle model.

We have tested these parts to determine their reliability, safety and special suitability for Mercedes-Benz vehicles.

We are unable to make an assessment for other products and therefore cannot be held responsible for them, even if in individual cases an official approval or authorization by governmental or other agencies should exist. Use of such parts and accessories could adversely affect the safety, performance or reliability of your vehicle. Please do not use them.

Genuine Mercedes-Benz parts as well as conversion parts and accessories approved by us are available at your authorized Mercedes-Benz Center where you will receive comprehensive information, also on permissible technical modifications, and where proper installation will be performed.

Introduction

Operator's Manual

This Operator's Manual contains a great deal of useful information. We urge you to read it carefully and familiarize yourself with the vehicle before driving.

For your own safety and longer service life of the vehicle, we urge you to follow the instructions and warnings contained in this manual. Ignoring them could result in damage to the vehicle or personal injury to you or others. Vehicle damage caused by failure to follow instructions is not covered by the Mercedes-Benz Limited Warranty.

Your vehicle may have some or all of the equipment described in this manual. Therefore, you may find explanations for optional equipment not installed in your vehicle. If you have any questions about the operation of any equipment, your authorized Mercedes-Benz Center will be glad to demonstrate the proper procedures.

We continuously strive to improve our product, and ask for your understanding that we reserve the right to make changes in design and equipment. Therefore, information, illustrations, and descriptions in this Operator's Manual might differ from your vehicle.

Optional equipment is also described in this manual, including operating instructions wherever necessary. Since they are special-order items, the descriptions and illustrations herein may vary slightly from the actual equipment of your vehicle.

If there are any equipment details that are not shown or described in this Operator's Manual, your authorized Mercedes-Benz Center will be glad to inform you of correct care and operating procedures.

The Operator's Manual and Maintenance Booklet are important documents and should be kept with the vehicle.

Service and warranty information

The Service and Warranty Information Booklet contains detailed information about the warranties covering your Mercedes-Benz, including:

- New Car Limited Warranty,
- Emission System Warranty,
- Emission Performance Warranty,
- California, Maine, Massachusetts, and Vermont Emission Control System Warranty (California, Maine, Massachusetts, and Vermont only),
- State Warranty Enforcement Laws (Lemon Laws).

Important notice for California retail buyers and lessees of Mercedes-Benz automobiles

Under California law you may be entitled to a replacement of your vehicle or a refund of the purchase price or lease price, if Mercedes-Benz USA, LLC and /or its authorized repair or service facilities fail to fix one or more substantial defects or malfunctions in the vehicle that are covered by its express warranty after a reasonable number of repair attempts. During the period of 18 months from original delivery of the vehicle or the accumulation of 18000 miles (approx. 29000 km) on the odometer of the vehicle, whichever occurs first, a reasonable number of repair attempts is presumed for a retail buyer or lessee if one or more of the following occurs:

- (1) the same substantial defect or malfunction results in a condition that is likely to cause death or serious bodily injury if the vehicle is driven, that defect or malfunction has been subject to repair two or more times, and you have directly notified Mercedes-Benz USA, LLC in writing of the need for its repair,
- (2) the same substantial defect or malfunction of a less serious nature than category (1) has been subject to repair four or more times and you have directly notified us in writing of the need for its repair, or
- (3) the vehicle is out of service by reason of repair of the same or different substantial defects or malfunctions for a cumulative total of more than 30 calendar days.

Written notification should be sent to us, not a dealer, at Mercedes-Benz USA, LLC, Customer Assistance Center, One Mercedes Drive, Montvale, NJ 07645-0350.

Introduction

Operator's Manual

Maintenance

The Maintenance Booklet describes all the necessary maintenance work which should be performed at regular intervals.

Always have the Maintenance Booklet with you when you take the vehicle to your authorized Mercedes-Benz Center for service. The service advisor will record each service in the booklet for you.

Roadside Assistance

The Mercedes-Benz Roadside Assistance Program provides factory trained technical help in the event of a breakdown. Calls to the toll-free Roadside Assistance number:

1-800-FOR-MERCEdes (in the USA)
1-800-387-0100 (in Canada)

will be answered by Mercedes-Benz Customer Assistance Representatives 24 hours a day, 365 days a year.

For additional information refer to the Mercedes-Benz Roadside Assistance Program brochure in your vehicle literature portfolio.

Change of address or ownership

If you change your address, be sure to send in the "Change of Address Notice" found in the Service and Warranty Information Booklet, or simply call the Mercedes-Benz Customer Assistance Center (in the USA) at 1-800-FOR-MERCEdes, or Customer Service (in Canada) at 1-800-387-0100. It is in your own interest that we can contact you should the need arise.

If you sell your Mercedes, please leave all literature with the vehicle to make it available to the next operator.

If you bought this vehicle used, be sure to send in the "Notice of Purchase of Used Car" found in the Service and Warranty Information Booklet, or call the Mercedes-Benz Customer Assistance Center (in the USA) at 1-800-FOR-MERCEdes, or Customer Service (in Canada) at 1-800-387-0100.

Operating your vehicle outside the USA or Canada

If you plan to operate your vehicle in foreign countries, please be aware that:

- Service facilities or replacement parts may not be readily available,
- unleaded gasoline for vehicles with catalytic converters may not be available; the use of leaded fuels will damage the catalyts,
- gasoline may have a considerably lower octane rating, and improper fuel can cause engine damage.

Certain Mercedes-Benz models are available for delivery in Europe under our European Delivery Program. For details, consult an authorized Mercedes-Benz Center or write to:

In the USA:

Mercedes-Benz USA, LLC
European Delivery Department
One Mercedes Drive
Montvale, NJ 07645-0350

In Canada:

Mercedes-Benz Canada, Inc.
European Delivery Department
98 Vanderhoof Avenue
Toronto, Ontario M4G 4C9

Introduction

Where to find it

This Operator's Manual is designed to provide comprehensive support information for you, the vehicle operator. For you to find information quickly each section has its own reference color:

At a glance

Here you will find an overview of all the controls that can be operated from the driver's seat.

Getting started

Here you will find all the information you need for your first drive. You should read this section first if this is your first Mercedes-Benz vehicle or if you are renting or borrowing this vehicle.

Safety and Security

Here you will find descriptions of the safety features in your vehicle.

Controls in detail

Here you will find detailed information about the equipment installed on your vehicle. This section expands on the "Getting started" section and also describes technical innovations. If you are already familiar with the basic functions of your vehicle, this section will be of particular interest to you.

Operation

Here you will find all the information you need for the proper operation of your vehicle.

Practical hints

This section provides fast assistance for dealing with problems you may encounter.

Technical data

All important technical data for your vehicle can be found in this section.

Indexes

The glossary provides explanations of the most important technical terms.

The table of contents and the index are designed to help you find information quickly and easily.

The following publications are part of your vehicle documentation:

- this Operator's Manual
- the Maintenance Booklet

Separate operating instructions will be provided as required depending on the equipment options installed in your vehicle.

▼ Symbols

The following symbols are found in this Operator's Manual:

- * Optional equipment is identified with an asterisk. Since standard equipment varies between models, the descriptions and illustrations in this manual may differ slightly from the actual equipment of your vehicle.

Warning!



Warning notices draw your attention to hazards that may endanger your health or life, or the health or life of others.



Highlights hazards that may result in damage to your vehicle.



Helpful hints or further information you may find useful.

- ▶ This symbol points to instructions for you to follow.
- ▶ A number of these symbols appearing in succession indicates a multiple-step procedure.
- ▷ Page This symbol tells you where to look for further information on a topic.
- ▷▷ This continuation symbol marks an interrupted procedure which will be continued on the next page.
- > In the glossary of technical terms, this symbol is used to indicate cross-references to term definitions.
- Display Words appearing in the multi-function display are printed in the type shown here.

Introduction

Operating safety

Warning!



Work improperly carried out on electronic components and associated software could cause them to cease functioning. Because the vehicle's electronic components are interconnected, any modifications made may produce an undesired effect on other systems. Electronic malfunctions could seriously impair the operating safety of your vehicle.

See an authorized Mercedes-Benz Center for repairs or modifications to electronic components.

Other improper work or modifications on the vehicle could also have a negative impact on the operating safety of the vehicle.

Some safety systems only function while the engine is running. You should therefore never turn off the engine while driving.

Warning!



Heavy blows against the vehicle underbody or tires / wheels, for example when running over an obstacle, road debris or a pothole, may cause serious damage and impair the operating safety of your vehicle. If you feel a sudden significant vibration or ride disturbance, or you suspect that damage to your vehicle has occurred, you should turn on your hazard warning flashers, carefully slow down, and drive with caution to an area which is a safe distance from the road.

Inspect the vehicle underbody and tires / wheels for possible damage. If the vehicle appears unsafe, have it towed to the nearest authorized Mercedes-Benz Center or other qualified maintenance or repair facility for further inspection or repairs.

Proper use of the vehicle

Proper use of the vehicle requires that you are familiar with the following information and rules:

- the safety precautions in this manual
- the "Technical data" section in this manual
- traffic rules and regulations
- motor vehicle laws and safety standards

Warning



Various warning labels are attached to your vehicle. These warning labels are intended to make you and others aware of various risks. You should not remove any of these warning labels unless explicitly instructed to do so by information on the label itself. Removal of any of these labels may cause you and others to be unaware of certain risks which may result in an accident and/or personal injury.

▼ **Problems with your vehicle**

If you should experience a problem with your vehicle, particularly one that you believe may affect its safe operation, we urge you to immediately contact an authorized Mercedes-Benz Center to have the problem diagnosed and corrected if required. If the matter is not handled to your satisfaction, please discuss the problem with the Mercedes-Benz Center management, or if necessary contact us at one of the following addresses:

In the USA:

Customer Assistance Center
Mercedes-Benz USA, LLC
One Mercedes Drive
Montvale, NJ 07645-0350

In Canada:

Customer Relations Department
Mercedes-Benz Canada, Inc.
98 Vanderhoof Avenue
Toronto, Ontario M4G 4C9

Introduction

Reporting safety defects

For the USA only:

The following text is published as required of manufacturers under Title 49, Code of U.S. Federal Regulations, Part 575 pursuant to the “National Traffic and Motor Vehicle Safety Act of 1966”.

Reporting safety defects

If you believe that your vehicle has a defect which could cause a crash or could cause injury or death, you should immediately inform the National Highway Traffic Safety Administration (NHTSA) in addition to notifying Mercedes-Benz USA, LLC.

If NHTSA receives similar complaints, it may open an investigation, and if it finds that a safety defect exists in a group of vehicles, it may order a recall and remedy campaign. However, NHTSA cannot become involved in individual problems between you, your dealer, or Mercedes-Benz USA, LLC.

To contact NHTSA, you may either call the Auto Safety Hotline toll-free at 1-888-327-4236 (or 366-0123 in Washington, D.C. area) or write to: NHTSA, U.S. Department of Transportation, Washington, D.C. 20590. You can also obtain other information about motor vehicle safety from the Hotline.

▼ Vehicle data recording

Information regarding electronic recording devices

(Including notice pursuant to California Code § 9951)

Please note that your vehicle is equipped with devices that can record vehicle systems data and, if equipped with the Tele Aid system, may transmit some data in certain accidents.

This information helps, for example, to diagnose vehicle systems after a collision and to continuously improve vehicle safety. DaimlerChrysler may access the information and share it with others

- for safety research or vehicle diagnosis purposes
- with the consent of the vehicle owner or lessee
- in response to an official request by law enforcement or other government agency
- for use in dispute resolution involving DaimlerChrysler, its affiliates or sales/service organization and/or
- as otherwise required or permitted by law.

Please check the Tele Aid subscription service agreement for details regarding the information that may be recorded or transmitted via that system.



At a glance

Cockpit

Instrument cluster

Multifunction steering wheel

Center console

Overhead control panel

Door control panel



At a glance

Cockpit

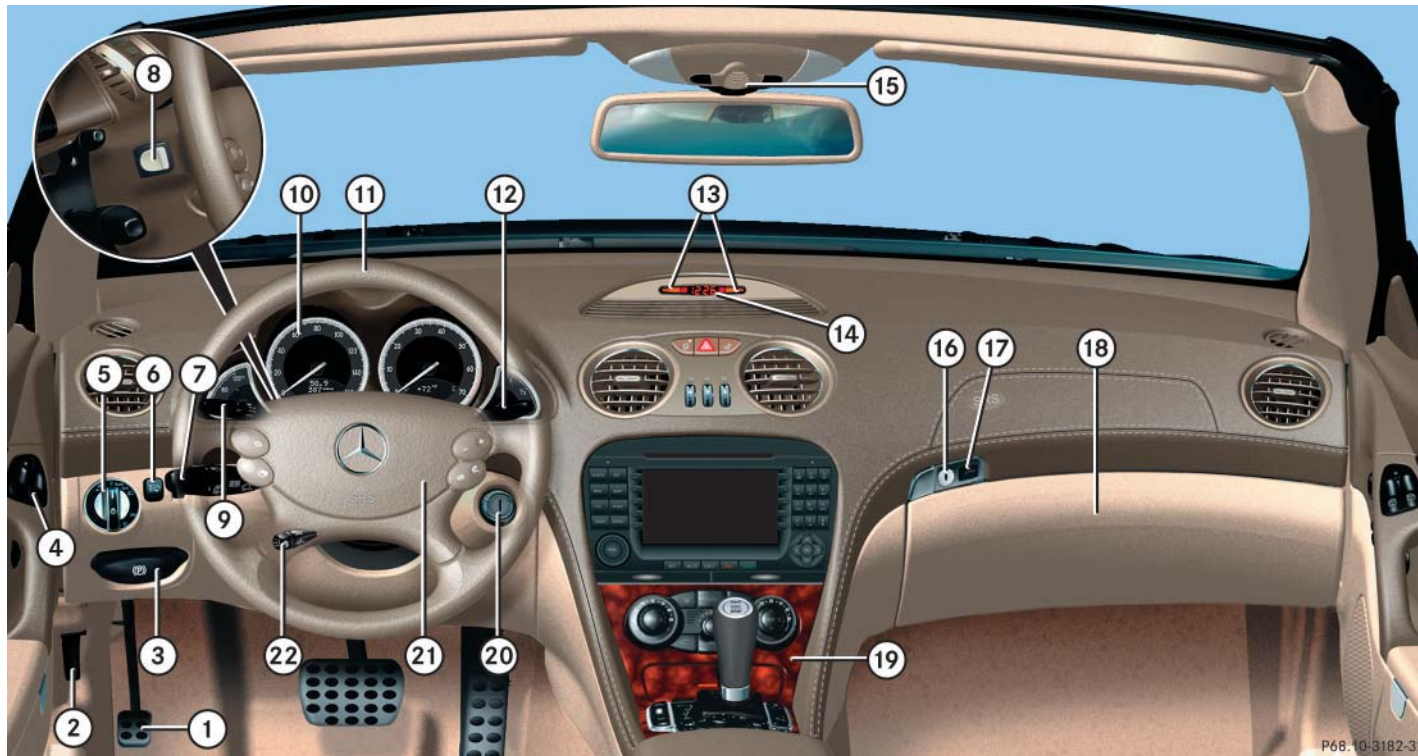

At a glance

Cockpit

	Item	Page
①	Parking brake pedal	50
②	Hood lock release	270
③	Parking brake release	57
④	Door control panel	32
⑤	Exterior lamp switch	51, 123
⑥	Headlamp washer button	178
⑦	Combination switch	
	• Turn signals	52
	• Windshield wipers	53
	• High beam	128





	Item	Page
⑧	Steering wheel gearshift control (SL 55 AMG, SL 65 AMG, and vehicles with Sport Package* only)	172
⑨	Cruise control switch	
	• Cruise control	205
	• DISTRONIC*	208
⑩	Instrument cluster	24, 131
⑪	Multifunction steering wheel	28, 135
⑫	Lever for voice control system*, see separate operating instructions	
⑬	Front Parktronic* warning indicator	225



	Item	Page
⑭	Digital clock	149
⑮	Overhead control panel	31
⑯	Interior storage compartments (locking/unlocking)	230
⑰	 indicator lamp	76
⑱	Glove box	228
⑲	Center console	29, 30
⑳	Starter switch	38
㉑	Horn	
㉒	Steering wheel adjustment lever Heated steering wheel*	42 234

At a glance

Instrument cluster



Item	Page
① Coolant temperature gauge with:	
 Coolant temperature warning lamp	328
② Speedometer with:	
 Brake warning lamp, USA only	326
 Brake warning lamp, Canada only	
 ABS/ESP warning lamp	324
 Distronic* indicator lamp ¹ (white) or warning lamp (red)	330

Item	Page
 Right turn signal indicator lamp	
 Left turn signal indicator lamp	
③ Left multifunction display with:	
• Trip odometer	132
• Main odometer	
Stored speed for	
• Cruise control	205
• Distronic*	142
④ Reset button	





¹ Vehicles without Distronic*: Warning lamp without function. It illuminates when the ignition is on. It should go out when the engine is running.

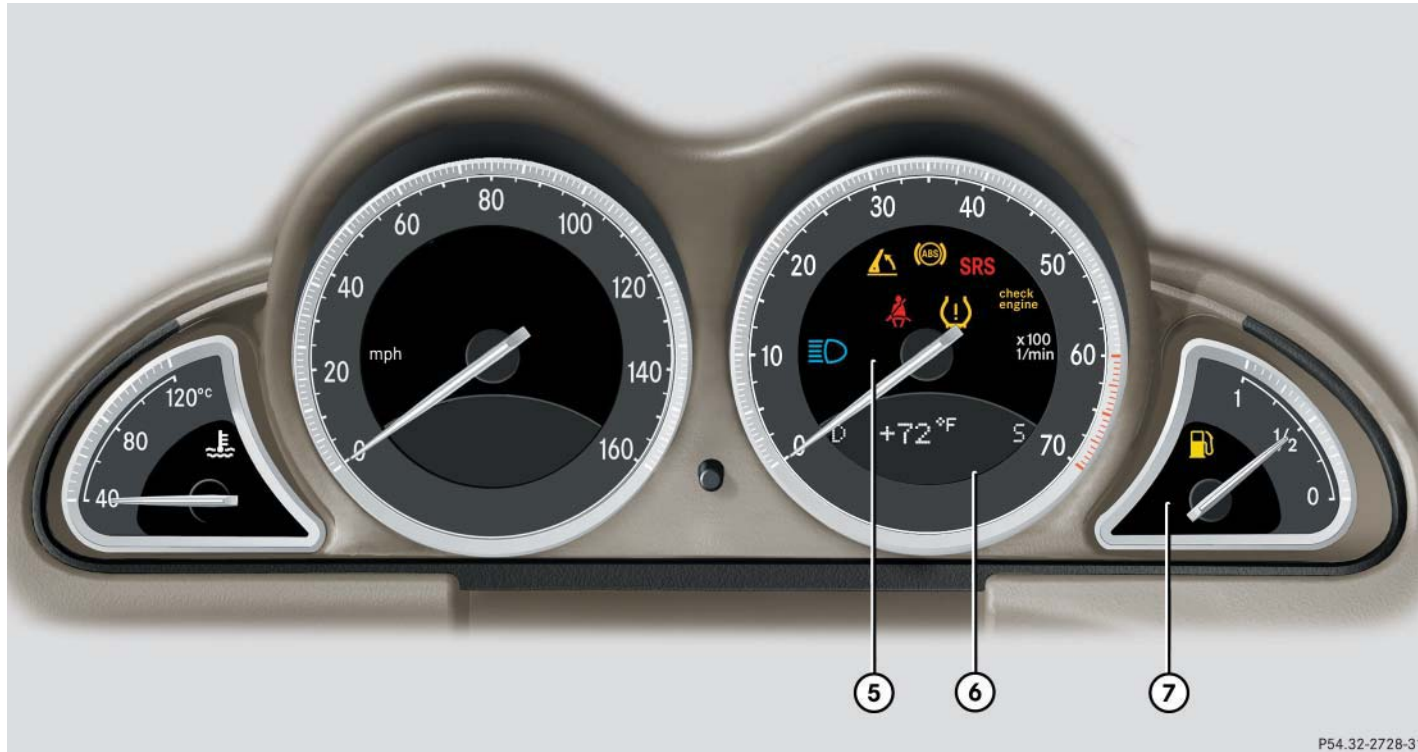



At a glance

Instrument cluster



P54.32-2728-31





	Item	Page
⑤	Tachometer with:	132
	 High beam headlamp indicator	128
	 Engine malfunction indicator lamp, USA only	327
	 Engine malfunction indicator lamp, Canada only	
	 Roll bar warning lamp	331
	 Antilock Brake System (ABS) indicator lamp	325





	Item	Page
	 Supplemental restraint system indicator lamp	332
	 Seat belt telltale	332
	 Tire pressure control warning light	333
⑥	Right multifunction display with	
	• Gear selector lever position	168
	• Outside temperature display	133
	• Program mode	165
⑦	Fuel gauge with:	
	 Fuel reserve warning lamp	330

At a glance

Multifunction steering wheel



Item	Page
① Left multifunction display in the speedometer	134
② Right multifunction display in the tachometer	134
Operating the control system	135
③ Selecting the submenu or setting the volume: Press button	
 down/to decrease	
 up/to increase	
④ Telephone*: Press button	
 to take a call	
 to end a call	

Item	Page
⑤ Menu systems: Press button	
 for previous menu	
 for next menu	
⑥ Moving within a menu: Press button	
 for next display	
 for previous display	

▼ Center console

Upper part



Item	Page
① Central locking switch	111
② Hazard warning flasher on/off switch	128
③ Central unlocking switch	111
④ Center and side air vent adjustment	182
⑤ COMAND system, see separate operating instructions	137
⑥ Automatic climate control	185
⑦ Right cup holder	228
⑧ KEYLESS-GO* start/stop button	37
⑨ Ashtray	233
Cigarette lighter	233
⑩ Left cup holder	228

At a glance

Center console

Lower part



	Item	Page
①	Parking assist (Parktronic system)* deactivation switch	223
②	Active Body Control (ABC) switch	220
③	Tow-away alarm switch	90
④	Hardtop open/close control with buttons for roll bar	196 73
⑤	Exterior rear view mirror adjustment	43

	Item	Page
⑥	Vehicle level control switch	221
⑦	ESP control switch	83
⑧	Thumbwheel for setting distance for DISTRONIC*	216
⑨	Distance warning function* on/off switch	216
⑩	Program mode selector switch for automatic transmission	175
⑪	Gear selector lever for automatic transmission	170

▼ Overhead control panel

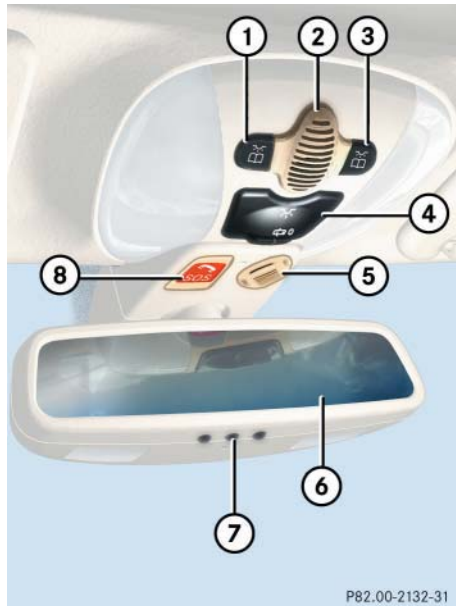

P82.00-2132-31

Item	Page
① Left reading lamp on/off	129
② Temperature sensor for automatic climate control	182
③ Right reading lamp on/off	129
④ Interior lighting control	129
⑤ Hands-free microphone for Tele Aid (emergency call system), telephone* and voice control system* (see separate operating instructions)	236
⑥ Rear view mirror	43, 178
⑦ Garage door opener	246
⑧ Tele Aid (emergency call system) button	237

At a glance

Door control panel

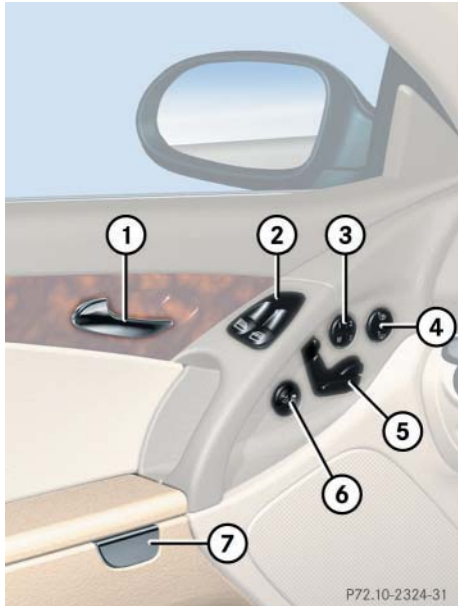

	Item	Page
①	Door handle	106
②	Switches for opening/closing front and rear side windows	193
③	Memory function (for storing seat, mirror and steering wheel settings)	120
④	Seat heating switch	117
	Seat ventilation* switch	119
⑤	Seat adjustment switch	39, 113
⑥	Remote trunk lid release switch	109
⑦	Door pocket	229

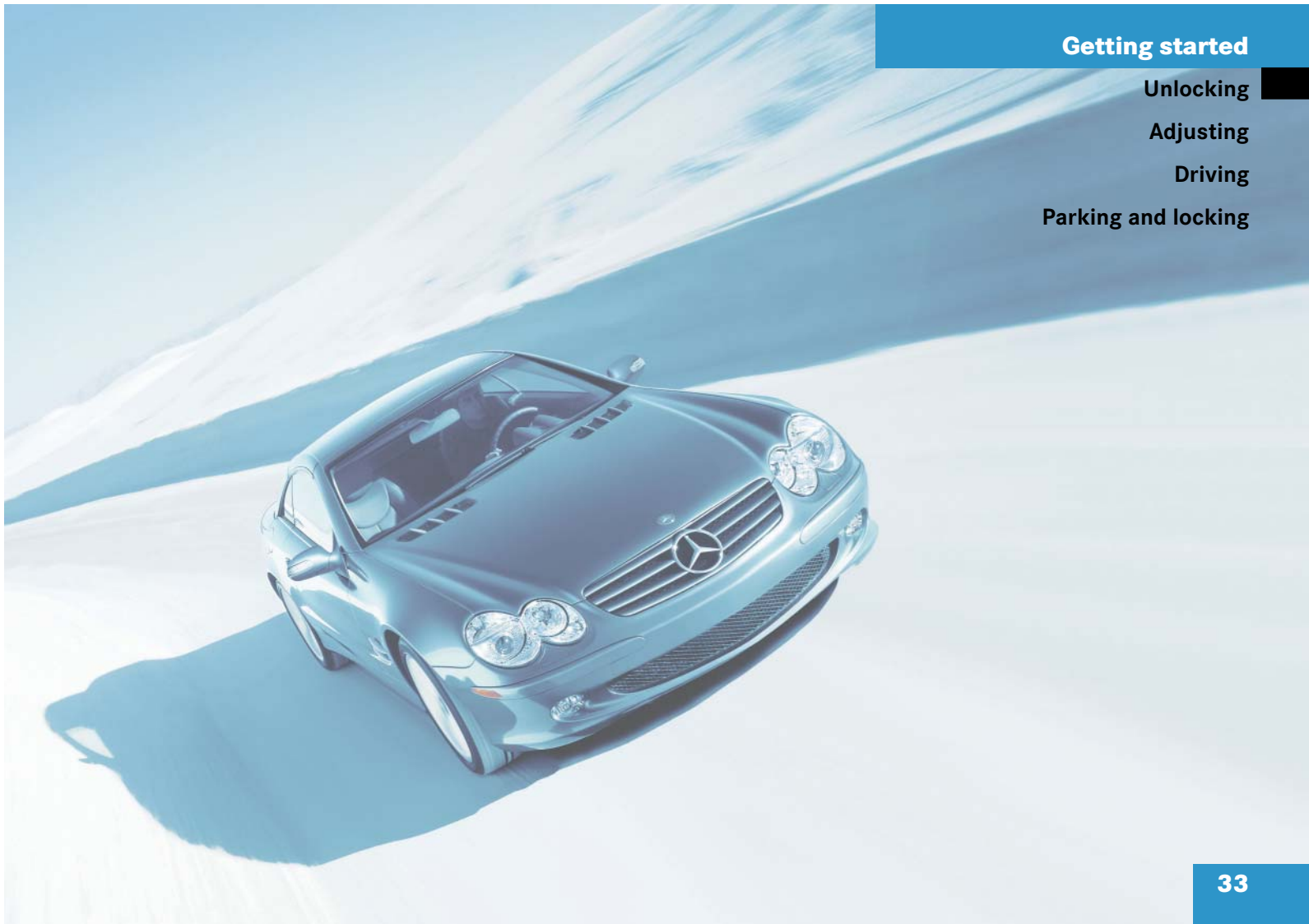

Getting started

Unlocking

Adjusting

Driving

Parking and locking

Getting started

Unlocking



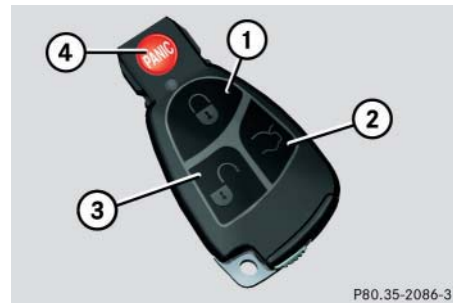

The “Getting started” section provides an overview of the vehicle’s most basic functions. First-time Mercedes-Benz owners should pay special attention to the information given here.

If you are already familiar with the basic functions described here, the “Controls in detail” section will provide you with further information. The corresponding page references are located at the end of each segment.

Unlocking with the SmartKey



SmartKey with remote control

- ①  Lock button
- ②  Unlock button for trunk lid
- ③  Unlock button
- ④  Panic button

- ▶ Press unlock button  on the SmartKey.

All turn signal lamps flash once. The locking knobs in the doors move up. The anti-theft alarm system is disarmed.

The SBC brake system is activated.

- ▶ Enter the vehicle and insert the SmartKey in the starter switch.

Warning!



When leaving the vehicle, always remove the SmartKey from the starter switch, take it with you, and lock the vehicle. Do not leave children unattended in the vehicle, or with access to an unlocked vehicle. Unsupervised use of vehicle equipment may cause an accident and/or serious personal injury.



Opening a door causes the windows on that side of the car to open slightly. They will return to the up-position when the door is closed.

For more information, see “SmartKey” (▷ page 94).

Unlocking with KEYLESS-GO*

If your vehicle is equipped with the KEYLESS-GO function, your vehicle checks whether the SmartKey with KEYLESS-GO is valid when you grasp the door handle. If your SmartKey with KEYLESS-GO is valid, the doors will unlock and you can open them.

The function of the SmartKey overrules the KEYLESS-GO function.

Warning!



When leaving the vehicle, always take the SmartKey with KEYLESS-GO* with you, and lock the vehicle. Do not leave children unattended in the vehicle, or with access to an unlocked vehicle. Unsupervised use of vehicle equipment may cause an accident and/or serious personal injury.



To unlock the vehicle, the SmartKey with KEYLESS-GO must be outside the vehicle, no further than approx. 3 feet (1 meter) away from the door.

- ▶ Grasp the door handle.

The turn signal lamps flash once. The locking knobs on the doors move up. The anti-theft alarm system is disarmed.

The SBC brake system is activated.



If the vehicle has been parked for more than 72 hours, you must pull the outside door handle in order to activate the KEYLESS-GO function.

If the SmartKey with KEYLESS-GO is inside the vehicle, pressing the KEYLESS-GO start/stop button on the gear selector lever corresponds to turning the SmartKey to the various starter switch positions (▷ page 37).



Opening a door causes the windows on that side of the car to open slightly. They will return to the up-position when the door is closed.

For more information, see “SmartKey with KEYLESS-GO*” (▷ page 98).

Getting started

Unlocking

Starter switch positions

Warning!



When leaving the vehicle, always remove the SmartKey or the SmartKey with KEYLESS-GO* from the starter switch, take it with you, and lock the vehicle. Do not leave children unattended in the vehicle, or with access to an unlocked vehicle. Unsupervised use of vehicle equipment may cause an accident and/or serious personal injury.

SmartKey



Starter switch

- 0** For removing SmartKey
- 1** Power supply to some electrical consumers, such as seat adjustment
- 2** Ignition (power supply for all electrical consumers) and driving position
All lamps (except high beam headlamp indicator lamp and turn signal indicator lamps unless activated) in the instrument cluster come on. If a lamp in the instrument cluster fails to come on when the ignition is switched on, have it checked and replaced if necessary.

If a lamp in the instrument cluster remains on after starting the engine or comes on while driving, refer to “Lamps in the instrument cluster” (▷ page 324).

3 Starting position

i

When you switch on the ignition, the indicator and warning lamps (except high beam headlamp indicator lamp and turn signal indicator lamps unless activated) in the instrument cluster come on. This indicates that the respective systems are operational. The indicator and warning lamps (except high beam headlamp indicator lamp and turn signal indicator lamps if activated) should go out when the engine is running.

i

The SmartKey can only be removed from the starter switch with the gear selector lever in position **P**.



If the SmartKey cannot be turned in the starter switch, the starter battery may not be sufficiently charged.

- Check the starter battery and charge it if necessary (▷ page 401).
- Get a jump start (▷ page 406).

To prevent accelerated battery discharge or a completely discharged battery, always remove the SmartKey from the starter switch when the engine is not in operation.

SmartKey with KEYLESS-GO*

You can also use the SmartKey with KEYLESS-GO like a normal SmartKey.



KEYLESS-GO start/stop button

- ① USA only
- ② Canada only

The SmartKey with KEYLESS-GO must be located in the vehicle.

- ▶ Make sure the gear selector lever is set to **P**.
- ▶ Do not depress the brake pedal.

Position 0

Before you press the KEYLESS-GO start/stop button, the vehicle's on-board electronics have the status **0** (as with SmartKey removed).

Position 1

- ▶ Press the KEYLESS-GO start/stop button once.

This supplies power to some electrical consumers, such as seat adjustment.



If you now press the KEYLESS-GO start/stop button

- once again, the ignition (position **2**) is switched on
- twice, the power supply is again switched off

Getting started

Unlocking

Ignition (or Position 2)

- ▶ Press the KEYLESS-GO start/stop button twice.

This supplies power to all electrical consumers. All lamps (except high beam headlamp indicator lamp and turn signal indicator lamps unless activated) in the instrument cluster come on.



If you now press the KEYLESS-GO start/stop button once, the power supply is again switched off.



When you switch on the ignition, the indicator and warning lamps (except high beam headlamp indicator lamp and turn signal indicator lamps unless activated) in the instrument cluster come on. This indicates that the respective systems are operational. The indicator and warning lamps (except high beam headlamp indicator lamp and turn signal indicator lamps if activated) should go out when the engine is running.

For more information, see “SmartKey with KEYLESS-GO*” (▷ page 98).

For information on starting the engine using the KEYLESS-GO start/stop button, see “Starting with KEYLESS-GO*” (▷ page 49).

▼ Adjusting

Warning!



All seat, head restraint, steering wheel, and rear view mirror adjustments, as well as fastening of seat belts, must be done before the vehicle is put into motion.

Seats

Warning!



Do not adjust the driver's seat while driving. Adjusting the seat while driving could cause the driver to lose control of the vehicle.

Never ride in a moving vehicle with the seat backrest in an excessively reclined position as this can be dangerous. You could slide under the seat belt in a collision. If you slide under it, the belt would apply force at the abdomen or neck. That could cause serious or fatal injuries. The seat backrest and seat belts provide the best restraint when the wearer is in a nearly upright position and belts are properly positioned on the body. Your seat must be adjusted so that you can correctly fasten your seat belt (> page 45).

Never place hands under the seat or near any moving parts while a seat is being adjusted.

Getting started

Adjusting

Warning!



When leaving the vehicle, always remove the SmartKey or the SmartKey with KEYLESS-GO* from the starter switch, take it with you, and lock the vehicle.

Even with the SmartKey or the SmartKey with KEYLESS-GO* removed from the starter switch or the SmartKey with KEYLESS-GO* removed from the vehicle, the power seats can be operated when the respective door is open. Therefore, do not leave children unattended in the vehicle, or with access to an unlocked vehicle. Unsupervised use of vehicle equipment may cause an accident and/or serious personal injury.

Getting started

Adjusting

Warning!



Children 12 years old and under must never ride in this vehicle, except in a Mercedes-Benz authorized BabySmart™¹ compatible child seat, which operates with the BabySmart™ system installed in the vehicle to deactivate the passenger front airbag when it is properly installed. Otherwise they will be struck by the airbag when it inflates in a crash. If this happens, serious or fatal injury will result.

Infants and small children must be seated in an appropriate infant or child restraint system, which is properly secured with the vehicle's seat belt, fully in accordance with the child seat manufacturer's instructions.

A child's risk of serious or fatal injuries is significantly increased if the child restraints are not properly secured in the vehicle and the child is not properly secured in the child restraint.

¹ BabySmart™ is a trademark of Siemens Automotive Corp.

Seat adjustment

The seat adjustment switch is located in the door.

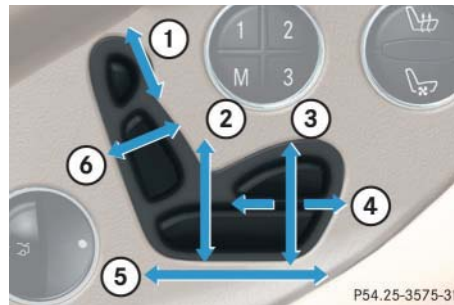

- ① Head restraint height
- ② Seat height
- ③ Seat cushion tilt
- ④ Seat cushion depth
- ⑤ Seat fore and aft adjustment
- ⑥ Backrest tilt

► Switch on the ignition (▷ page 36).

or

► Open the respective door.

Seat fore and aft adjustment

► Press the switch forward or backward in direction of arrow ⑤.

Adjust seat to a comfortable seating position that still allows you to reach the accelerator / brake pedal safely. The position should be as far to the rear as possible, consistent with ability to properly operate controls.



When moving the seats, make sure there are no items in the footwell or behind the seats. Otherwise you could damage the seats.

The memory function (▷ page 120) lets you store the setting for the seat position together with the settings for the steering wheel and the exterior rear view mirrors.

Seat height

- ▶ Press the switch up or down in direction of arrow ②.

Seat cushion tilt

- ▶ Press the switch up or down in direction of arrow ③ until your upper legs are lightly supported.

Seat cushion depth

- ▶ Press the switch forward or backward in direction of arrow ④ until your legs are supported comfortably.

Seat backrest tilt

- ▶ Press the switch forward or backward in direction of arrow ⑥ until your arms are slightly angled when holding the steering wheel.

Head restraint height

- ▶ Press the switch up or down in direction of arrow ①.

Warning!

For your protection, drive only with properly positioned head restraints.

Adjust head restraint so that the center of the head restraint supports the back of the head at eye level. This will reduce the potential for injury to the head and neck in the event of an accident or similar situation.

Do not drive the vehicle without the seat head restraints. Head restraints are intended to help reduce injuries during an accident.

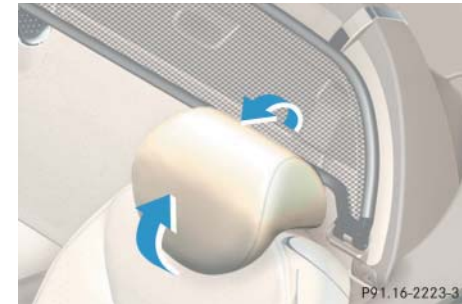
Head restraint tilt

Manually adjust the angle of the head restraint.

- ▶ Push or pull on the lower edge of the head restraint cushion.

For more information on seats, see “Seats” (▷ page 113).

Getting started

Adjusting

Steering wheel

Warning!



Do not adjust the steering wheel while driving. Adjusting the steering wheel while driving could cause the driver to lose control of the vehicle.

When leaving the vehicle, always remove the SmartKey or the SmartKey with KEYLESS-GO* from the starter switch, take it with you, and lock the vehicle.

Even with the SmartKey or the SmartKey with KEYLESS-GO* removed from the starter switch or the SmartKey with KEYLESS-GO* removed from the vehicle, the steering wheel adjustment feature can be operated when the driver's door is open. Therefore, do not leave children unattended in the vehicle, or with access to an unlocked vehicle. Unsupervised use of vehicle equipment may cause an accident and/or serious personal injury.

Steering wheel adjustment

The stalk for steering wheel adjustment is located on the lower left of the steering column.

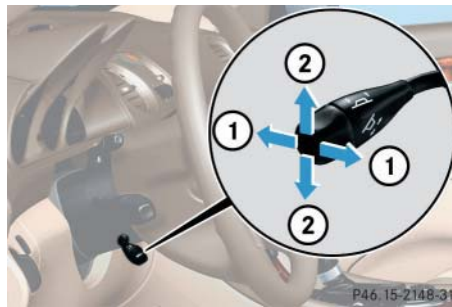

- ① Adjusting steering column, in or out
- ② Adjusting steering column, up or down

- ▶ Switch on the ignition (▷ page 36).
- or
- ▶ Open the driver's door.

Adjusting steering column in or out

- ▶ Move stalk forward or back in direction of arrow ① until a comfortable steering wheel position is reached with your arms slightly bent at the elbow.

Adjusting steering column up or down

- ▶ Move stalk up or down in direction of arrow ②.

Make sure your legs can move freely and that you have a good view on all the displays (including malfunction and indicator lamps) on the instrument cluster.



The memory function (▷ page 120) lets you store the setting for the steering wheel together with the settings for the seat position and the exterior rear view mirrors.

For more information, see "Heated steering wheel* (SL 500, SL 600)" (▷ page 234).

Mirrors

Adjust the interior and exterior rear view mirrors before driving so that you have a good view of the road and traffic conditions.

Warning!



In the case of an accident, liquid electrolyte may escape the mirror housing if the mirror glass breaks.

Electrolyte has an irritating effect. Do not allow the liquid to come into contact with eyes, skin, clothing, or respiratory system. In case it does, immediately flush affected area with water, and seek medical help if necessary.



Electrolyte drops coming into contact with the vehicle paint finish can only be completely removed while in their liquid state and by applying plenty of water.

Interior rear view mirror

- ▶ Manually adjust the interior rear view mirror.

For more information, see “Rear view mirrors” (▷ page 178).

Exterior rear view mirror

Warning!



Exercise care when using the passenger side exterior rear view mirror. The mirror surface is convex (outwardly curved surface for a wider field of view). Objects in mirror are closer than they appear. Check your interior rear view mirror or glance over your shoulder before changing lanes.

Getting started

Adjusting

The buttons are located on the lower part of the center console.

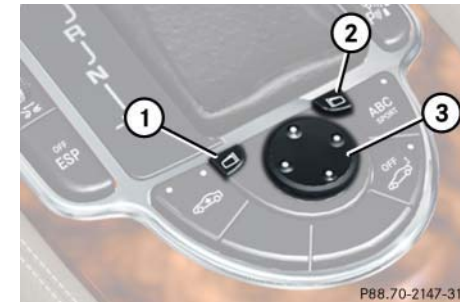

- ① Driver's side exterior rear view mirror button
 - ② Passenger-side exterior rear view mirror button
 - ③ Adjustment button
- ▶ Switch on the ignition (▷ page 36).
 - ▶ Press button ① for the left mirror or button ② for the right mirror.
 - ▶ Push adjustment button ③ up, down, left, or right according to the desired setting.

Getting started

Adjusting



If an exterior rear view mirror was forcibly pushed forward (hit from the rear) or forcibly pushed rearward (hit from the front), reposition it by applying firm pressure until it snaps into place. The mirror housing is then properly positioned and you can adjust the mirror in the usual manner.



The memory function (▷ page 120) lets you store the setting for the exterior rear view mirrors together with the settings for the steering wheel and the seat position.

For more information, see “Good visibility” (▷ page 178).

▼ Driving

Warning!

Do not lay any objects in the driver's footwell. Be careful that floor mats or carpets in the driver's footwell have sufficient clearance for the pedals.

During sudden driving or braking maneuvers, the objects could get caught between the pedals. You could then no longer brake or accelerate.

Fastening the seat belts**Warning!**

Always fasten your seat belt before driving off. Always make sure your passengers are properly restrained, even pregnant women.

Failure to wear and properly fasten and position your seat belt greatly increases your risk of injuries and their likely severity in an accident. You and your passenger should always wear seat belts.

If you are ever in an accident, your injuries can be considerably more severe without your seat belt properly buckled. Without your seat belt buckled, you are much more likely to hit the interior of the vehicle or be ejected from it. You can be seriously injured or killed.

In the same crash, the possibility of injury or death is lessened if you are wearing your seat belt. The airbags can only provide the protection they were designed to afford if the occupants are using their seat belts (▷ page 62).

Warning!

Children 12 years old and under must never ride in this vehicle, except in a Mercedes-Benz authorized BabySmartTM¹ compatible child seat, which operates with the BabySmartTM system installed in the vehicle to deactivate the passenger front airbag when it is properly installed. Otherwise they will be struck by the airbag when it inflates in a crash. If this happens, serious or fatal injury will result. ▷▷

¹ BabySmartTM is a trademark of Siemens Automotive Corp.

Getting started

Driving

▷▷ Infants and small children must be seated in an appropriate BabySmart™¹ compatible infant or child restraint system, which is properly secured with the vehicle's seat belt, fully in accordance with the child seat manufacturer's instructions.

A child's risk of serious or fatal injuries is significantly increased if the child restraints are not properly secured in the vehicle and the child is not properly secured in the child restraint.

¹ BabySmart™ is a trademark of Siemens Automotive Corp.

Warning!



Never ride in a moving vehicle with the seat backrest in an excessively reclined position as this can be dangerous. You could slide under the seat belt in a collision. If you slide under it, the belt would apply force at the abdomen or neck. That could cause serious or even fatal injuries. The seat backrest and seat belt provide the best restraint when the wearer is in a nearly upright position and the belt is properly positioned on the body.

Warning!



Never let more people ride in the vehicle than there are seat belts available. Be sure everyone riding in the vehicle is correctly restrained with a separate seat belt. Never use a seat belt for more than one person at a time.

Warning!



Read and observe the additional warning notices in the "Safety and Security" section (▷ page 69).

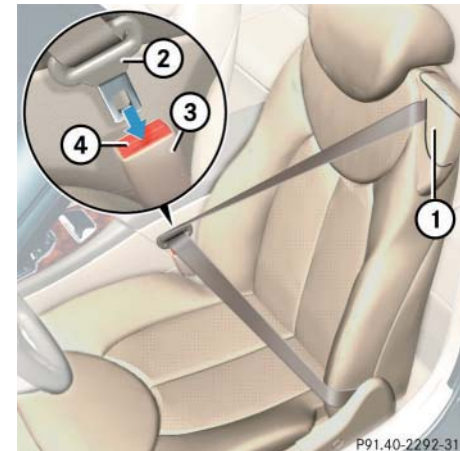

- ① Seat belt housing
- ② Latch plate
- ③ Buckle
- ④ Release button

- ▶ With a smooth motion, pull the belt from seat belt housing ①.
 - ▶ Place the shoulder portion of the belt across the top of your shoulder and the lap portion across your hips.
 - ▶ Push latch plate ② into buckle ③ until it clicks.
 - ▶ If necessary, tighten the lap portion to a snug fit by pulling shoulder portion up.
- Proper use of seat belts**
- Do not twist the belt when fastening.
 - Adjust seat belt so that the shoulder portion is located as close as possible to the middle of the shoulder (it should not touch the neck). Never pass the shoulder portion of the belt under your arm.
 - Position the lap belt as low as possible on your hips (over hip joint) and not across the abdomen.
 - Place the seat backrest in a nearly upright position.
 - Never use a seat belt for more than one person at a time.
 - Do not fasten a seat belt around a person and another object at the same time.
 - Check your seat belt during travel to ensure that it is properly positioned.
 - Make sure the seat belt is always fitted snugly. Take special care of this when wearing loose clothing.

Warning!



Do not pass belts over sharp edges. They could tear.

Do not allow the belt to get caught in the door or in the seat adjustment mechanism. This could damage the belt.

Never attempt to make modifications to seat belts. This could impair the effectiveness of the belts.

Do not bleach or dye seat belts as this may severely weaken them. In a crash, they may not be able to provide adequate protection.

Damaged seat belts or belts that were highly stressed in an accident must be replaced. Contact an authorized Mercedes-Benz Center.

Getting started

Driving

Starting the engine

Warning!



Inhalation of exhaust gas is hazardous to your health. All exhaust gas contains carbon monoxide, and inhaling it can cause unconsciousness and lead to death.

Do not run the engine in confined areas (such as a garage) which are not properly ventilated. If you think that exhaust gas fumes are entering the vehicle while driving, have the cause determined and corrected immediately. If you must drive under these conditions, drive with at least one window fully open.

Automatic transmission



Gearshift pattern for automatic transmission

- P** Park position with gear selector lever lock
- R** Reverse gear
- N** Neutral
- D** Drive position

For more information, see “Automatic transmission” (▷ page 164).

Starting with the SmartKey

- ▶ Make sure the gear selector lever is set to **P**.
- ▶ Do not depress the accelerator.
- ▶ Turn the SmartKey in the starter switch to position **3** and hold until the engine starts (▷ page 36).



You can also use the “touch-start” function. Turn the SmartKey to position **3** and release it again immediately. The engine then starts automatically.

- ▶ Depress the brake pedal.

The gear selector lever lock is released.

For information on turning off the engine with the SmartKey, see “Turning off with the SmartKey” (▷ page 58).

Starting with KEYLESS-GO*

You can start your vehicle without the SmartKey in the starter switch using the KEYLESS-GO start/stop button on the gear selector lever.

**KEYLESS-GO start/stop button**

- ① USA only
- ② Canada only

- ▶ Make sure the gear selector lever is set to **P**.

- ▶ Depress the brake pedal during the starting procedure. Do not depress accelerator.
The selector lever lock is released.
- ▶ Press KEYLESS-GO start/stop button ① once.
The engine starts automatically if the SmartKey with KEYLESS-GO is in the vehicle.

For information on turning off the engine with KEYLESS-GO, see “Turning off with KEYLESS-GO*” (▷ page 59).

Starting difficulties

If the engine does not start as described, carry out the following steps:

- ▶ If you are starting the engine with the SmartKey: Turn SmartKey in starter switch to position **0** and repeat starting procedure.

- ▶ If you are starting the engine with KEYLESS-GO*: Close any doors that may be open to allow for better detection of the SmartKey with KEYLESS-GO.
Or:
Start the engine with the SmartKey as radio signals from another source may be interfering with the SmartKey with KEYLESS-GO*.
- ▶ Repeat the starting procedure (▷ page 48). Remember that extended starting attempts can drain the battery.
- ▶ Get a jump start (▷ page 406).

If the engine does not start after several starting attempts, there could be a malfunction in the engine electronics or in the fuel supply system.

- ▶ Notify an authorized Mercedes-Benz Center.

Getting started

Driving

Parking brake

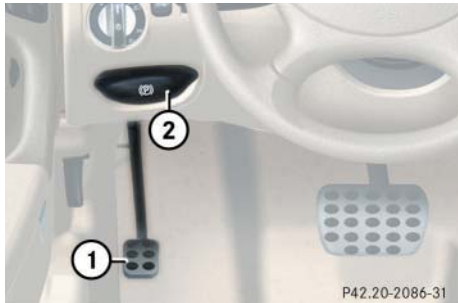

- ① Parking brake
- ② Parking brake release handle

Warning!



When leaving the vehicle, always remove the SmartKey or the SmartKey with KEYLESS-GO* from the starter switch, take it with you, and lock the vehicle. Do not leave children unattended in the vehicle, or with access to an unlocked vehicle. Children could release the parking brake, which could result in an accident and/or serious injury.

- ▶ Release the parking brake by pulling on handle ②.

The indicator lamp **BRAKE** (USA only) or **(P)** (Canada only) in the instrument cluster goes out.

Driving

- ▶ Depress the brake pedal.
- ▶ Place the gear selector lever in position **D** or **R**.

Warning!



It is dangerous to shift the gear selector lever out of **P** or **N** if the engine speed is higher than idle speed. If your foot is not firmly on the brake pedal, the vehicle could accelerate quickly forward or in reverse. You could lose control of the vehicle and hit someone or something. Only shift into gear when the engine is idling normally and when your right foot is firmly on the brake pedal.

Warning!



On slippery road surfaces, never downshift in order to obtain braking action. This could result in drive wheel slip and reduced vehicle control. Your vehicle's ABS will not prevent this type of loss of control.



In order to avoid damage to the transmission:

- Wait for the gear selection process to complete before setting the vehicle in motion.
- Place the gear selector lever in position **D** or **R** only when the vehicle is stopped.

- ▶ Release the brake pedal.
- ▶ Carefully depress the accelerator pedal.

Once the vehicle is in motion, the automatic central locking system engages and the locking knobs drop down.



If you hear a warning signal when driving off, you have forgotten to release the parking brake.

Release the parking brake.

After a cold start, the transmission engages at a higher revolution. This allows the catalytic converter to reach its operating temperature earlier.



Do not run cold engine at high engine speed. Running a cold engine at high engine speed may shorten the service life of the engine.



Simultaneously depressing the accelerator pedal and applying the brake reduces engine performance and causes premature brake and drivetrain wear.



You can open a locked door from the inside. Open door only when conditions are safe to do so.

You can deactivate the automatic locking using the control system (▷ page 156).

Switching on headlamps

Low beam headlamps

The exterior lamp switch is located on the dashboard to the left of the steering wheel.

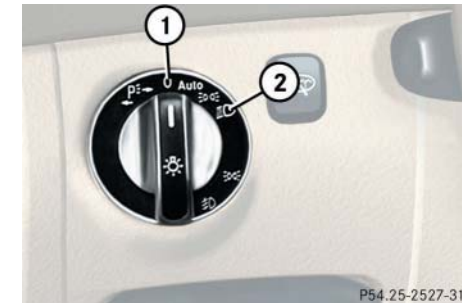

Exterior lamp switch

① Off

② Low beam headlamps on

► Turn the exterior lamp switch to position .

The low beam headlamps come on.

Getting started

Driving

High beam

The combination switch is located on the left of the steering column.



Combination switch

- ① High beam
- ② High beam flasher

► Push the combination switch in direction of arrow ①.

The high beam headlamps come on.

The high beam headlamp indicator  in the instrument cluster comes on (▷ page 27).

For more information, see “Lighting” (▷ page 123).

Turn signals

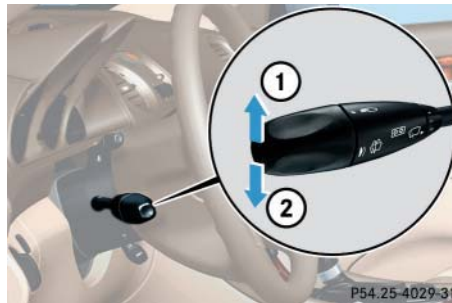

The combination switch is located on the left of the steering column.



Combination switch

- ① Turn signals, right
- ② Turn signals, left

► Press the combination switch in direction of arrow ① or ②.

The corresponding turn signal indicator lamp  or  in the instrument cluster flashes (▷ page 25).

The combination switch resets automatically after major steering wheel movements.

i

To signal minor directional changes such as changing lanes, press combination switch only to point of resistance and release. The corresponding turn signals will flash three times.

Windshield wipers

The combination switch is located on the left of the steering column.



Combination switch

- ① Single wipe
 - ② Switching on windshield wipers
- Switch on the ignition (► page 36).

Switching on windshield wipers

- Turn the combination switch to the desired position depending on the intensity of the rain.

- 0 Windshield wipers off
- I Intermittent wiping
- II Normal wiper speed
- III Fast wiper speed



The intermittent wiping interval is dependent on the wetness of the windshield. After the initial wipe, pauses between wipes are controlled by the rain sensor.

Wiping will not occur with a door open.



Do not leave windshield wipers in intermittent setting when vehicle is taken to an automatic car wash or during windshield cleaning. Wipers will operate in the presence of water sprayed on the windshield, and wipers may be damaged as a result.

The combination switch should not be left in intermittent setting as the wipers will wipe the windshield once every time the engine is started. Dust that accumulates on the windshield might scratch the glass and/or damage the wiper blades when wiping occurs on a dry windshield.

Intermittent wiping

- Set the combination switch to position I.



Intermittent wiping is suspended when the vehicle is at a standstill and a door is opened.

Getting started

Driving

Single wipe

- ▶ Press the combination switch briefly in direction of arrow ①.

The windshield wipers wipe one time without washer fluid.

Wiping with windshield washer fluid

- ▶ Push the combination switch in direction of arrow ① past the resistance point.

The windshield wipers operate with washer fluid.

For information on filling up the washer reservoir, see “Windshield washer system and headlamp cleaning system” (▷ page 278).



If anything blocks the windshield wipers (leaves, snow, etc.), switch them off immediately.

- For safety reasons,
 - turn off the engine by turning the SmartKey to position **0** and withdraw the SmartKey from the starter switchor
 - turn off the engine by pressing the KEYLESS-GO* start/stop button and open the driver's door (with the driver's door open, the starter switch is in position **0**, same as with the SmartKey removed from the starter switch)

before attempting to remove any blockage.

- Remove blockage.
- Turn the windshield wipers on again.

If windshield wipers fail to function at all in switch position **I**,

- set the combination switch to the next higher wiper speed
- have the windshield wipers checked at the nearest authorized Mercedes-Benz Center

Problems while driving

The engine runs erratically and misfires

- An ignition cable may be damaged.
- The engine electronics may not be operating properly.
- Unburned gasoline may have entered the catalytic converter and damaged it.
- ▶ Give very little gas.
- ▶ Have the problem repaired by an authorized Mercedes-Benz Center as soon as possible.

The coolant temperature gauge is above 248°F (120°C)

The coolant is too hot and is no longer cooling the engine.

- ▶ Stop the vehicle as soon as possible and turn off the engine. Allow engine and coolant to cool.
- ▶ Check the coolant level and add coolant if necessary (▶ page 276).

In case of accident

If the vehicle is leaking gasoline:

- ▶ Do not start the engine under any circumstances.
- ▶ Notify local fire and/or police authorities.

If the extent of the damage cannot be determined:

- ▶ Notify an authorized Mercedes-Benz Center.

If no damage can be determined on the

- major assemblies
- fuel system
- engine mount:
- ▶ Start the engine in the usual manner.

Getting started

Parking and locking

You have now completed your first drive. You have properly stopped and parked your vehicle. End your drive as follows.

Warning!



With the engine not running, there is no power assistance for the brake and steering systems. In this case, it is important to keep in mind that a considerably higher degree of effort is necessary to brake and steer the vehicle.

Warning!



Do not park this vehicle in areas where combustible materials such as grass, hay or leaves can come into contact with the hot exhaust system, as these materials could be ignited and cause a vehicle fire.

To reduce the risk of personal injury as a result of vehicle movement, before turning off the engine and leaving the vehicle always:

- Keep right foot on brake pedal.
- Firmly depress parking brake pedal.
- Move the gear selector lever to position **P**.
- Slowly release brake pedal.

- When parked on an incline, turn front wheels towards the road curb.
- Turn the SmartKey in the starter switch to position **0** and remove the SmartKey from the starter switch, or press the start / stop button (vehicles with KEYLESS-GO*).
- Take the SmartKey or the SmartKey with KEYLESS-GO* and lock vehicle when leaving.

Getting started

Parking and locking

Parking brake

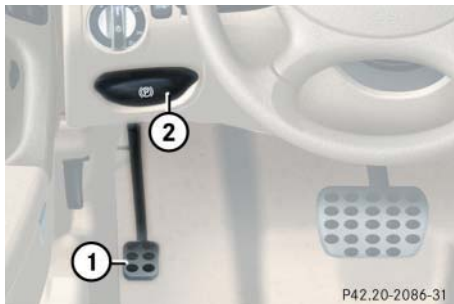

- ① Parking brake
- ② Release handle

- ▶ Step firmly on parking brake ①.

When the engine is running, the indicator lamp **BRAKE** (USA only) or **(P)** (Canada only) in the instrument cluster will be illuminated.

Warning!



When leaving the vehicle, always remove the SmartKey or the SmartKey with KEYLESS-GO* from the starter switch, take it with you, and lock the vehicle. Do not leave children unattended in the vehicle, or with access to an unlocked vehicle. Children could release the parking brake and/or move the gear selector lever from position **P**, either of which could result in an accident and/or serious injury.

Warning!



Getting out of your vehicle with the gear selector lever not fully engaged in position **P** is dangerous. Also, when parked on an incline, position **P** alone may not prevent your vehicle from moving, possibly hitting people or objects.

Always set the parking brake in addition to shifting to position **P** (▷ page 167).

When parked on an incline, also turn front wheels towards the road curb.

Switching off headlamps

- ▶ Turn the exterior lamp switch to position **0** (▷ page 51).

For more information, see “Exterior lamp switch” (▷ page 123).

Getting started

Parking and locking

Turning off the engine

- ▶ Place the gear selector lever in position **P**.



Always set the parking brake in addition to shifting to position **P**.

On slopes, turn the front wheels towards the road curb.

Turning off with the SmartKey

- ▶ Turn the SmartKey in the starter switch (▷ page 36) to position **0** and remove it.



The immobilizer is activated.



The SmartKey can only be removed from the starter switch with the gear selector lever in position **P**.

- ▶ Press the seat belt release button (▷ page 45).

Allow the retractor to completely rewind the seat belt by guiding the latch plate.



With the SmartKey removed and the driver's door open, a warning sounds if the vehicle's exterior lamps are not switched off.



Opening a door causes the windows on that side of the car to open slightly. They will return to the up position when the door is closed.

Warning!



To prevent possible personal injury, always keep hands and fingers away from the door openings when closing the doors. Be especially careful when small children are around.

Before closing doors, make sure that there is no possibility of someone getting caught in a door during closing.

- ▶ After exiting the vehicle, press the lock button  on the SmartKey (▷ page 34).

All turn signal lamps flash three times. The locking knobs on the doors move down. The anti-theft alarm system is armed.

Warning!



When leaving the vehicle, always remove the SmartKey from the starter switch, take it with you, and lock the vehicle. Do not leave children unattended in the vehicle, or with access to an unlocked vehicle. Unsupervised use of vehicle equipment may cause an accident and/or serious personal injury.

For more information, see “Locking and unlocking” (▷ page 94).

Turning off with KEYLESS-GO*

- ▶ Place the gear selector lever in **P**.
- ▶ Press the KEYLESS-GO start/stop button to shut off the engine.

With the driver’s door closed, the starter switch is now in position **1**. With the driver’s door opened, the starter switch is set to position **0**, same as SmartKey removed from starter switch (▷ page 36).

- ▶ Press the seat belt release button (▷ page 45).

Allow the retractor to completely re-wind the seat belt by guiding the latch plate.



If you hear a warning signal you have either

- forgotten to turn off the lights before opening the driver’s door
- or
- tried to turn off the engine while the gear selector lever is not in **P**

Turn off the lights or place the gear selector lever in **P**.



Opening a door causes the windows on that side of the car to open slightly. They will return to the up position when the door is closed.

Getting started

Parking and locking

Warning!



To prevent possible personal injury, always keep hands and fingers away from the door openings when closing the doors. Be especially careful when small children are around.

Before closing doors, make sure that there is no possibility of someone getting caught in a door during closing.

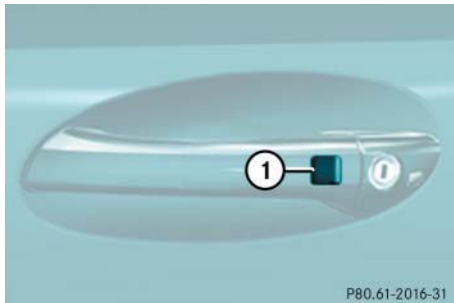

① Lock button on the door handle

- ▶ After exiting the vehicle, press lock button ① on the door handle or the lock button on the trunk lid (▷ page 104).

All turn signal lamps flash three times. The locking knobs on the doors move down. The anti-theft alarm system is armed.

Warning!



When leaving the vehicle, always remove the SmartKey or the SmartKey with KEYLESS-GO* from the starter switch, take it with you, and lock the vehicle. Do not leave children unattended in the vehicle, or with access to an unlocked vehicle. Unsupervised use of vehicle equipment may cause an accident and/or serious personal injury.

For more information, see “Locking and unlocking” (▷ page 94).

Emergency engine shut-down

If the engine cannot be turned off as described, you may use the following backup procedure.

- ▶ Open the main fuse box (▷ page 412).
- ▶ Pull out the two fuses labeled “ENGINE EMERGENCY STOP”.



Safety and Security

Occupant safety

Panic alarm

Driving safety systems

Anti-theft systems

Safety and Security

Occupant safety

In this section you will learn the most important facts about the restraint systems of the vehicle.

The restraint systems are

- Seat belts
- Emergency tensioning device
- Airbags
- Child seats
- Child seat recognition

As independent systems, their protective effects work in conjunction with each other.



For information on infants and children traveling with you in the vehicle and restraint systems for infants and children, see “Children in the vehicle” (▷ page 74).

The **SRS** indicator lamp in the instrument cluster comes on

- for about four seconds when you turn the SmartKey in the starter switch to position **1** or press the KEYLESS-GO* start/stop button once. It then goes out briefly, comes on again and remains lit until you start the engine, turn the SmartKey to position **2** or press the KEYLESS-GO start/stop button once more (▷ page 34).
- for about four seconds when you turn the SmartKey in the starter switch to position **2** or press the KEYLESS-GO* start/stop button twice (▷ page 34).
- for about four seconds when you start the engine by turning the SmartKey in the starter switch or by pressing the KEYLESS-GO* start/stop button once with the brake pedal depressed (▷ page 48).

The **SRS** indicator lamp goes out shortly after you start the engine. This shows that the restraint systems are operational.

A malfunction in the system has been detected if the **SRS** indicator lamp

- fails to go out after approximately four seconds
- does not come on at all
- comes on after the engine was started or while driving

For more information, see the “Practical hints” section (▷ page 332).

Warning!



In the event that the **SRS** indicator lamp comes on during driving or does not come on at all, the SRS self-check has detected a malfunction. For your safety, we strongly recommend that you visit an authorized Mercedes-Benz Center immediately to have the system checked; otherwise the SRS may not be activated when needed in an accident, which could result in serious or fatal injury, or it might deploy unexpectedly and unnecessarily which could also result in injury.

In addition, improper work on the SRS creates a risk of rendering the SRS inoperative or causing unintended airbag deployment. Work on the SRS must therefore only be performed by qualified technicians. Contact an authorized Mercedes-Benz Center.

Airbags

Warning!



Airbags are designed to reduce the potential of injury and fatality in certain frontal impacts (front airbags, driver-side kneebag) or side impacts (head-thorax airbags). However, no system available today can totally eliminate injuries and fatalities.

The activation of the airbags temporarily releases a small amount of dust from the airbags. This dust, however, is neither injurious to your health, nor does it indicate a fire in the vehicle. The dust might cause some temporary breathing difficulty for people with asthma or other breathing trouble. To avoid this, you may wish to get out of the vehicle as soon as it is safe to do so. If you have any breathing difficulty but cannot get out of the vehicle after the airbag inflates, then get fresh air by opening a window or door.

Warning!



To reduce the risk of injury when the front airbags inflate, it is very important for the driver and passenger to always be in a properly seated position and to wear your seat belts.

For maximum protection in the event of a collision always be in normal seated position with your back against the backrest. Fasten your seat belt and ensure that it is properly positioned on your body (▷ page 45).

Since the airbag inflates with considerable speed and force, a proper seating and hands on steering wheel position will help to keep you at a safe distance from the airbag. Occupants who are unbelted, out of position or too close to the airbag can be seriously injured by an airbag as it inflates with great force in the blink of an eye:

- Sit properly belted in a nearly upright position with your back against the seat backrest. ▷▷

Safety and Security

Occupant safety



- Adjust the driver seat as far as possible rearward, still permitting proper operation of vehicle controls. The distance from the center of the driver's breastbone to the center of the airbag cover on the steering wheel must be at least ten inches (25 cm) or more. You should be able to accomplish this by a combination of adjustments to the seat and steering wheel. If you have any problems, please see an authorized Mercedes-Benz Center.
- Do not lean with your head or chest close to the steering wheel or dashboard.
- Keep hands on the outside of steering wheel rim. Placing hands and arms inside the rim can increase the risk and potential severity of hand / arm injury when driver front airbag inflates.
- Adjust the passenger seat as far as possible rearward from the dashboard when the seat is occupied.

- Occupants, especially children, should never lean their heads in the area of the door where the head-thorax airbag inflates. This could result in serious injuries or death should the airbag be triggered. Always sit nearly upright, properly use the seat belts and appropriate size infant or child restraint system.
- Children 12 years old and under must never ride in this vehicle, except in a Mercedes-Benz authorized BabySmart™¹ compatible child seat, which operates with the BabySmart™ system installed in the vehicle to deactivate the passenger front airbag when it is properly installed. Otherwise they will be struck by the airbag when it inflates in a crash. If this happens, serious or fatal injury will result.

¹ BabySmart™ is a trademark of Siemens Automotive Corp.

Failure to follow these instructions can result in severe injuries to you or other occupants.

If you sell your vehicle, it is important that you make the buyer aware of this safety information. Be sure to give the buyer this Operator's Manual.

Warning!



Should you choose to place a child 12 years old or under in the passenger seat of your vehicle, you must properly use a BabySmart™ child restraint which will turn off the passenger front airbag (▷ page 74). BabySmart™ will not, however, turn off any side impact airbag.

It should be noted, however, that there is a possibility for a head-thorax airbag related injury if occupants, especially children, are not properly seated or restrained when next to a head-thorax airbag which needs to deploy rapidly in a side impact in order to do its job.

To help avoid the possibility of injury, please follow these guidelines:

- (1) Occupants, especially children, should never place their bodies or lean their heads in the area of the door where the head-thorax airbag inflates. This could result in serious injuries or death should the head-thorax airbag be activated.
- (2) Always sit nearly upright, properly use the seat belts and use an appropriately sized infant or child restraint system for all children 12 years old or under.
- (3) Always wear seat belts properly.

If you believe that, even with the use of these guidelines, it would be safer for your passenger seat occupants to have the passenger side head-thorax airbag deactivated, then deactivation can be accomplished upon your written election to do so at an authorized Mercedes-Benz Center at an additional cost. Please contact your local authorized Mercedes-Benz Center or call our Customer Assistance Center at 1-800-FOR-MERCEdes (1-800-367-6372) for details.

Safety and Security

Occupant safety



Airbags are designed to activate only in certain frontal impacts (front airbags, driver-side kneebag) and side impacts (head-thorax airbags) which exceed preset thresholds. Only during these types of impacts, if of sufficient severity to meet the deployment threshold, will they provide their supplemental protection.

The driver and passengers should always wear their seat belts. Otherwise it is not possible for the airbags to provide their intended supplemental protection.

In cases of other frontal impacts, angled impacts, roll-overs, other side impacts, rear collisions, or other accidents and impacts below airbag deployment thresholds, the airbags will not be activated. The driver and passenger will then be protected to the extent possible by a properly fastened seat belt.

We caution you not to rely on the presence of the airbags in order to avoid wearing your seat belt.

Your vehicle was originally equipped with airbags which are designed to activate in certain impacts exceeding a preset threshold to reduce the potential and severity of injury. It is important to your safety and that of your passenger that you replace deployed airbags and repair any malfunctioning airbags to ensure that the vehicle will continue to provide supplemental crash protection for occupants.

Safety and Security

Occupant safety

Safety guidelines for the seat belt, emergency tensioning device and airbag

Warning!



- Damaged seat belts or belts that were highly stressed in an accident must be replaced and their anchoring points must also be checked. Only use belts installed or supplied by an authorized Mercedes-Benz Center.
- Airbags and ETDs (Emergency Tensioning Devices) are designed to function on a one-time-only basis. An airbag or ETD that was activated must be replaced.
- No modifications of any kind may be made to any components or wiring of the SRS. This includes changing or removing any component or part of the SRS, the installation of additional trim material, badges, etc. over the steering wheel hub, passenger front airbag cover or door trim panels, and installation of

additional electrical /electronic equipment on or near SRS components and wiring. Keep area between airbags and occupants free from objects (e.g. packages, purses, umbrellas, etc.).

- Do not pass belts over sharp edges. They could tear.
- Do not make any modification that could change the effectiveness of the belts.
- Do not bleach or dye seat belts as this may severely weaken them. In a crash, they may not be able to provide adequate protection.
- Airbag system components will be hot after an airbag has inflated. Do not touch.
- Never place your feet on the instrument panel, dashboard, or on the seat. Always keep both feet on the floor in front of the seat.

- In addition, improper repair work on the SRS creates a risk of rendering the SRS inoperative or causing unintended airbag deployment. Work on the SRS must therefore only be performed by qualified technicians. Contact an authorized Mercedes-Benz Center.
- For your protection and the protection of others, when scrapping the airbag unit or emergency tensioning device, our safety instructions must be followed. These instructions are available from your authorized Mercedes-Benz Center.
- Given the considerable deployment speed and the textile structure of the airbags, there is the possibility of abrasions or other injuries resulting from airbag deployment.

When you sell your vehicle, we strongly urge you to give notice to the subsequent owner that it is equipped with an SRS by alerting them to the applicable section in the Operator's Manual.

Safety and Security

Occupant safety

Front airbags

Driver and passenger airbags are deployed:

- in the event of certain frontal impacts
- if impact exceeds a preset deployment threshold
- independently of the head-thorax airbags

The airbags will not deploy in impacts which do not exceed the system's deployment thresholds. You will then be protected by the fastened seat belts.

The passenger airbag will only be deployed if:

- the passenger seat is occupied
- the  indicator lamp on the glove box is not lit (> page 76)
- the impact exceeds a preset deployment threshold



- ① Driver airbag
- ② Passenger airbag
- ③ Kneebag



Do not place objects heavier than 20 lbs (9 kg) on the front passenger seat. This could cause the front airbag or the head-thorax airbag on the front passenger side to deploy in a crash which exceeds the system's deployment threshold.

Kneebag

The kneebag is located on the driver-side lower instrument panel. It is designed to operate together with the driver airbag in certain frontal impacts exceeding a preset threshold. The kneebag operates best in conjunction with a properly positioned and fastened seat belt.

Head-thorax airbags

The head-thorax airbags are deployed:

- on the impacted side of the vehicle
- in impacts exceeding a preset deployment threshold
- independently of the front airbags

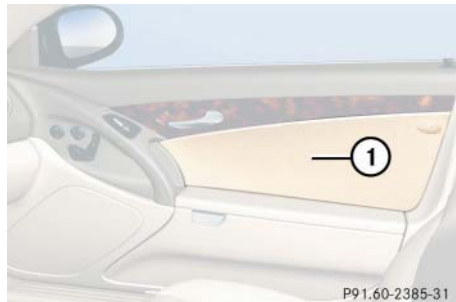

The head-thorax airbags are not deployed in impacts which do not exceed the system's deployment threshold.

The passenger head-thorax airbag will only deploy if the system senses that the passenger seat is occupied.



① Head-thorax airbag

Seat belts

When the engine is started, the seat belt telltale  illuminates to remind you and your passenger to fasten your seat belts. If the driver's seat belt is not fastened before the engine is started, the seat belt telltale  illuminates and a warning chime sounds for approximately six seconds when the engine is started.

The use of seat belts and infant and child restraint systems is required by law in all 50 states, the District of Columbia, the U.S. territories, and all Canadian provinces. Even where this is not the case, all vehicle occupants should have their seat belts fastened whenever the vehicle is in motion.

For information on fastening seat belts, see "Fastening the seat belts" (▷ page 45).

i

For information on infants and children traveling with you in the vehicle and restraint systems for infants and children, see "Children in the vehicle" (▷ page 74).

Safety and Security

Occupant safety

Warning!



Always fasten your seat belt before driving off. Always make sure your passengers are properly restrained, even pregnant women.

Failure to wear and properly fasten and position your seat belt greatly increases your risk of injuries and their likely severity in an accident. You and your passenger should always wear seat belts.

If you are ever in an accident, your injuries can be considerably more severe without your seat belt properly buckled. Without your seat belt buckled, you are much more likely to hit the interior of the vehicle or be ejected from it. You can be seriously injured or killed.

In the same crash, the possibility of injury or death is lessened if you are properly wearing your seat belt. Airbags can only protect as they are designed if the occupants are properly wearing their seat belts (> page 63).

Warning!



Never ride in a moving vehicle with the seat backrest in an excessively reclined position as this can be dangerous. You could slide under the seat belt in a collision. If you slide under it, the belt would apply force at the abdomen or neck. This could cause serious or even fatal injuries. The seat backrest and seat belt provide the best restraint when the wearer is in a nearly upright position and the belt is properly positioned on the body.

Keep door storage compartments closed while vehicle is in motion. Failure to do so may cause the seat belt to catch at the rear and prevent proper positioning of the seat belt.

Warning!



Never let more people ride in the vehicle than there are seat belts available. Be sure everyone riding in the vehicle is correctly restrained with a separate seat belt. Never use a seat belt for more than one person at a time.

Warning!



Damaged seat belts or belts that were highly stressed in an accident must be replaced and their anchoring points must also be checked.

Only use seat belts which have been approved by Mercedes-Benz.

Do not make any modifications to the seat belts. This can lead to unintended activation or to failure.

Do not bleach or dye seat belts as this may severely weaken them. In a crash, they may not be able to provide adequate protection.

Have all work carried out only by qualified technicians. Contact an authorized Mercedes-Benz Center.

Warning!



USE SEAT BELTS PROPERLY

- Seat belts can only work when used properly. Never wear seat belts in any other way than as described in this section, as that could result in serious injuries in case of an accident.
- Each occupant should wear their seat belt at all times, because seat belts help reduce the likelihood of and potential severity of injuries in accidents, including rollovers. The integrated restraint system includes SRS (driver airbag, driver-side kneebag, passenger airbag, head-thorax airbags) and ETD (seat belt emergency tensioning device). The system is designed to enhance the protection offered to properly belted occupants in certain frontal (front airbags, driver-side kneebag and ETD) and side (head-thorax airbags and ETD) impacts which exceed preset deployment thresholds.

- Never wear the shoulder belt under your arm, against your neck or off your shoulder. In a crash, your body would move too far forward. That would increase the chance of head and neck injuries. The belt would also apply too much force to the ribs or abdomen, which could severely injure internal organs such as your liver or spleen.
- Never wear belts over rigid or breakable objects in or on your clothing, such as eyeglasses, pens, keys, etc., as these might cause injuries.
- Position the lap belt as low as possible on your hips and not across the abdomen. If the belt is positioned across your abdomen, it could cause serious injuries in a crash.
- Never use a seat belt for more than one person at a time. Do not fasten a seat belt around a person and another person or other objects.



Safety and Security

Occupant safety



- Belts should not be worn twisted. In a crash, you would not have the full width of the belt to manage impact forces. The twisted belt against your body could cause injuries.
- Pregnant women should also use a lap-shoulder belt. The lap belt portion should be positioned as low as possible on the hips to avoid any possible pressure on the abdomen.
- Never place your feet on the instrument panel, dashboard or on the seat. Always keep both feet on the floor in front of the seat.

Emergency tensioning device (ETD), seat belt force limiter

The seat belts are equipped with emergency tensioning devices, belt force limiters, and automatic comfort-fit.

The ETD is designed to activate in the following cases:

- in frontal or rear-end impacts exceeding a preset severity level
- if the restraint systems are operational and functioning correctly, see **SRS** indicator lamp (▷ page 62).



The ETDs will only activate if the respective seat belt is fastened (latch plate properly inserted into buckle).

In an impact, emergency tensioning devices remove slack from the belts in such a way that the seat belts fit more snugly against the body. Belt force limiters reduce the force exerted by the seat belts on occupants during a crash.

Warning!



An emergency tensioning device (ETD) that was activated must be replaced.

When disposing of the emergency tensioning device, our safety instructions must be followed. These are available at your authorized Mercedes-Benz Center.



Do not place objects heavier than 20 lbs (9 kg) on the front passenger seat. This could cause the front or side impact airbag on the passenger side to deploy in a crash which exceeds the system's deployment threshold.

Automatic comfort-fit feature seat belt

The automatic comfort-fit feature reduces the retracting force of the seat belts when they are in normal use.

Roll bar

Warning!



This vehicle is a two occupant vehicle. The rear storage area is not intended for use by occupants and is not equipped for properly seating or restraining occupants. Thus this area should never be used by any persons.

Before operating the roll bar switch make sure that the roll bar's path is clear and no persons are injured by the moving roll bar due to inattention. Raising or lowering of the roll bar could injure someone inadvertently occupying the rear storage area.

For your own safety, we recommend to drive with the roll bar raised if the outside temperature is below +5°F (-15°C).



If the outside temperature falls below +5°F (-15°C), the roll bar must be raised manually using the buttons provided to avoid damaging the hydraulics.

The roll bar raises automatically in an accident or in a critical driving situation. You can also raise and lower the roll bar manually using the buttons provided.



When the roll bar is raised automatically, you will hear a ratcheting sound.

The buttons for the roll bar are on the center console under the roof switch.



- ① Lower roll bar
- ② Raise roll bar

The roll bar can be moved manually when the ignition is switched on (▷ page 36).

Warning!



If the roll bar warning light  in the tachometer remains lit after starting the engine, there is a malfunction. In the display you see the message Raise the roll-over bar.

For safety reasons, drive only with the roll bar upright until the malfunction is repaired. Have your vehicle checked at an authorized Mercedes-Benz Center.

Raising the roll bar

- ▶ Lift the switch for the retractable hardtop.
- ▶ Press and hold button ② until the roll bar is raised.

Safety and Security

Occupant safety

Lowering the roll bar

If the roll bar was raised manually:

- ▶ Lift the switch for the retractable hardtop.
- ▶ Press and hold button ① until the roll bar is lowered.

If the roll bar was raised automatically:

- ▶ Press and hold button ② until you hear the roll bar lock into place.
- ▶ Press and hold button ① until the roll bar is lowered.



If you raised the roll bar manually using the button, the roll bar will be automatically lowered and then raised again when you close and open the retractable hardtop.

Children in the vehicle

If an infant or child is traveling with you in the vehicle:

- Secure the child using an infant or child restraint appropriate to the age and size of the child.
- Make sure the infant or child is properly secured by a belt at all times while the vehicle is in motion.

Infant and child restraint seats and information on choosing an appropriate restraint system can be obtained from any Mercedes-Benz Center.

Infant and child restraint systems

Only use a BabySmart™¹ compatible child restraint for the front passenger seat in this vehicle.

We recommend all infants and children be properly restrained at all times while the vehicle is in motion.

The passenger lap-shoulder belt has a special seat belt retractor for the secure fastening of child restraints.

To fasten a child restraint follow child restraint instructions for mounting. Then pull the shoulder belt out completely and let it retract. During the seat belt retraction a ratcheting sound can be heard to indicate that the special seat belt retractor is activated. The belt is now locked. Push down on child restraint to take up any slack.

To deactivate, release seat belt buckle and let seat belt retract completely. The seat belt can again be used in the usual manner.

¹ BabySmart™ is a trademark of Siemens Automotive Corp.

Safety and Security

Occupant safety

Warning!



Never release the seat belt buckle while the vehicle is in motion, since the special seat belt retractor will be deactivated.



The use of infant or child restraints is required by law in all 50 states, the District of Columbia, the U.S. territories, and all Canadian provinces.

Infants and small children should be seated in an appropriate infant or child restraint system which is properly secured by a lap-shoulder belt and that complies with U.S. Federal Motor Vehicle Safety Standard 213 and Canadian Motor Vehicle Safety Standard 213.

A statement by the child restraint manufacturer of compliance with this standard can be found on the instruction label on the restraint and in the instruction manual provided with the restraint.

When using any infant or child restraint system, be sure to carefully read and follow all manufacturer's instructions for installation and use.

Please read and observe warning labels affixed to inside of vehicle and to infant or child restraints.

Warning!



Children 12 years old and under must never ride in this vehicle, except in a Mercedes-Benz authorized BabySmart™ compatible child seat, which operates with the BabySmart™ system installed in the vehicle to deactivate the passenger front airbag when it is properly installed. Otherwise they will be struck by the airbag when it inflates in a crash. If this happens, serious or fatal injury will result.

Infants and small children must be seated in an appropriate BabySmart™ compatible infant or child restraint system, which is properly secured with the vehicle's seat belt, fully in accordance with the child seat manufacturer's instructions.

Infants and small children should never share a seat belt with another occupant. During an accident, they could be crushed between the occupant and seat belt.

A child's risk of serious or fatal injuries is significantly increased if the child restraints are not properly secured in the vehicle and the child is not properly secured in the child restraint.

Adjust the passenger seat as far as possible rearward from the dashboard when the seat is occupied.

Safety and Security

Occupant safety

Warning!



Children too big for child restraint systems should use regular seat belts. Position the shoulder belt across chest and shoulder, not face or neck. A booster seat may be necessary to achieve proper belt positioning for children from 41 lbs until they reach a height where a lap/shoulder belt fits properly without a booster.

When the child restraint is not in use, remove it from the vehicle or secure it with the seat belt to prevent the child restraint from becoming a projectile in the event of an accident.

Do not leave children unattended in the vehicle, even if the children are secured in a child restraint system. Unsupervised children in a child restraint system may use vehicle equipment and cause an accident and/or serious personal injury.

BabySmart™¹ airbag deactivation system



Special BabySmart™ compatible child seats, designed for use with the Mercedes-Benz system and available at any authorized Mercedes-Benz Center, are required for use with the BabySmart™ airbag deactivation system. With the special child seat properly installed, the passenger front airbag will not deploy.

¹ BabySmart™ is a trademark of Siemens Automotive Corp.

The  indicator lamp located on the glove box will be illuminated, except with the SmartKey removed or in starter switch position **0**.



The system does not deactivate the head-thorax airbag and the emergency tensioning device.

Self-test BabySmart™ without special child seat installed

After turning the SmartKey in the starter switch to position **1** or **2** or pressing the KEYLESS-GO* start/stop button once or twice, the  indicator lamp located on the glove box comes on for approximately six seconds and then goes out.

If the indicator lamp should not come on or is continuously lit, the system is not functioning. You must see an authorized Mercedes-Benz Center before seating any child on the passenger seat.

Safety and Security

Occupant safety

Warning!



The BabySmart™ airbag deactivation system will ONLY work with a special child seat designed to operate with it. It will not work with child seats which are not BabySmart™ compatible.

Never place anything between seat cushion and child seat (e.g. pillow), since it reduces the effectiveness of the deactivation system. The bottom of the child seat must make full contact with the passenger seat cushion. An incorrectly mounted child seat could cause injuries to the child in case of an accident, instead of protecting the child.

Follow the manufacturer's instructions for installation of special child seats.

Warning!



When using a BabySmart™ compatible child seat on the front passenger seat, the passenger front airbag will not deploy only if the  indicator lamp remains illuminated.

Please be sure to check the indicator every time you use the special system child seat. Should the light go out while the restraint is installed, please check installation. If the light remains out, do not use the BabySmart™ restraint to transport children on the passenger seat until the system has been repaired.

Warning!



Do not place powered-on laptops, cell phones and like electronic devices on the passenger seat. Signals from such devices may interfere with the BabySmart™ system. Such signal interference may cause the  indicator lamp not to come on during self-test or be continuously lit, indicating that the system is not functioning.

Safety and Security

Panic alarm

An audible alarm and flashing exterior lamps will operate for approximately 2 1/2 minutes.



① PANIC button

Activating

- ▶ Press and hold button ① for at least one second.

Deactivating

- ▶ Press button ① again.
- or
- ▶ Insert SmartKey in starter switch.



USA only:

This device complies with Part 15 of the FCC Rules. Operation is subject to the following two conditions:

- (1) This device may not cause harmful interference, and
- (2) this device must accept any interference received, including interference that may cause undesired operation.

Any unauthorized modification to this device could void the user's authority to operate the equipment.



Canada only:

This device complies with RSS-210 of Industry Canada. Operation is subject to the following two conditions:

- (1) This device may not cause interference, and
- (2) this device must accept any interference received, including interference that may cause undesired operation of the device.

Any unauthorized modification to this device could void the user's authority to operate the equipment.

▼ Driving safety systems

In this section you will find information on the following driving safety systems:

- ABS (Antilock Brake System)
- BAS (Brake Assist System)
- ESP (Electronic Stability Program)
- SBC (Sensotronic Brake Control)



In winter operation, the maximum effectiveness of the ABS, the BAS, the ESP, and the SBC is only achieved with winter tires (M+S tires) or snow chains as required.

Warning!



The following factors increase the risk of accidents:

- Excessive speed, especially in turns
- Wet and slippery road surfaces
- Following another vehicle too closely

The ABS, BAS, ESP, and SBC cannot reduce this risk.

Always adjust your driving style to the prevailing road and weather conditions.

Safety and Security

Driving safety systems

ABS

Warning!



Do not pump the brake pedal. Use firm, steady brake pedal pressure instead. Pumping the brake pedal defeats the purpose of the ABS and significantly reduces braking effectiveness.

The Antilock Brake System (ABS) regulates the brake pressure so that the wheels do not lock during braking. This allows you to maintain the ability to steer your vehicle.

The ABS is functional above a speed of approximately 5 mph (8 km/h) independent of road surface conditions.

On slippery road surfaces, the ABS will respond even to light brake pressure.

The  indicator lamp in the instrument cluster comes on when you switch on ignition. It goes out when the engine is running.

Braking

If the ABS activates during braking, the ABS/ESP warning lamp  in the instrument cluster dial flashes. Because of the SBC brake system, you will not feel any pulsation in the brake pedal.

- ▶ Keep firm and steady pressure on the brake pedal.

Continuous, steady brake pedal pressure yields the advantages provided by the ABS, namely braking power and the ability to steer the vehicle.

The ABS/ESP warning lamp  flashes whenever the ABS is activated which can be an indication of hazardous road conditions and functions as a reminder to take extra care while driving.

Emergency brake maneuver

- ▶ Keep continuous, full pressure on the brake pedal.

Warning!



When the ABS is malfunctioning, the BAS and the ESP are also switched off.

When the ABS is malfunctioning, the wheels may lock during hard braking, reducing steering capability and extending the braking distance.

Warning!



The ABS cannot prevent the natural laws of physics from acting on the vehicle, nor can it increase braking or steering efficiency beyond that afforded by the condition of the vehicle brakes and tires or the traction afforded. The ABS cannot prevent accidents, including those resulting from excessive speed in turns, following another vehicle too closely, or hydroplaning. Only a safe, attentive, and skillful driver can prevent accidents. The capabilities of an ABS equipped vehicle must never be exploited in a reckless or dangerous manner which could jeopardize the user's safety or the safety of others.

For more information, see the "Practical hints" section (▷ page 324).

BAS

The Brake Assist System (BAS) operates in emergency situations. If you apply the brakes very quickly, the BAS automatically provides full brake boost, thereby potentially reducing the braking distance.

- ▶ Apply continuous full braking pressure until the emergency braking situation is over.

The ABS will prevent the wheels from locking.

When you release the brake pedal, the brakes function again as normal. The BAS is then deactivated.

Warning!



If the BAS is malfunctioning, the brake system is still functioning normally, but without the additional brake boost available that BAS would normally provide in an emergency braking maneuver. Therefore, the braking distance may increase.

Warning!



BAS cannot prevent the natural laws of physics from acting on the vehicle, nor can it increase braking efficiency beyond that afforded by the condition of the vehicle brakes and tires or the traction afforded. The BAS cannot prevent accidents, including those resulting from excessive speed in turns, following another vehicle too closely, or hydroplaning. Only a safe, attentive, and skillful driver can prevent accidents. The capabilities of a BAS equipped vehicle must never be exploited in a reckless or dangerous manner which could jeopardize the user's safety or the safety of others.

Safety and Security

Driving safety systems

ESP

The Electronic Stability Program (ESP) is operational as soon as the engine is running and monitors the vehicle's traction (force of adhesive friction between the tires and the road surface) and handling.

The ESP recognizes when a wheel is spinning or if the vehicle starts to skid. By applying brakes to the appropriate wheel and by limiting engine output, the ESP works to stabilize the vehicle. The ESP is especially useful while driving off and on wet or slippery road surfaces. The ESP also stabilizes the vehicle during braking maneuvers.

The ABS/ESP warning lamp  in the instrument cluster (▷ page 25) flashes when the ESP is engaged.

The ABS/ESP warning lamp  in the instrument cluster comes on when you switch on the ignition. It goes out when the engine is running.

Warning!



Never switch off the ESP when you see the ABS/ESP warning lamp  flashing in the instrument cluster. In this case proceed as follows:

- While driving off, apply as little throttle as possible.
- While driving, ease up on the accelerator.
- Adapt your speed and driving style to the prevailing road conditions.

Failure to observe these guidelines could cause the vehicle to skid.

The ESP cannot prevent accidents resulting from excessive speed.

Warning!



The ESP cannot prevent the natural laws of physics from acting on the vehicle, nor can it increase the traction afforded. The ESP cannot prevent accidents, including those resulting from excessive speed in turns, or hydroplaning. Only a safe, attentive, and skillful driver can prevent accidents. The capabilities of an ESP equipped vehicle must never be exploited in a reckless or dangerous manner which could jeopardize the user's safety or the safety of others.



The ESP will only function properly if you use wheels of the recommended tire size (▷ page 422).



Because of the ESP's automatic operation, the engine must be shut off (SmartKey in starter switch position **0** or **1** or KEYLESS-GO* start/stop button in position **0** or **1**) when

- the parking brake is being tested on a brake test dynamometer
- the vehicle is being towed with the front/rear axle raised

Active braking action through the ESP may otherwise seriously damage the brake system.

The ESP will only function properly if you use wheels of the recommended tire size (▷ page 422).

For more information, see the "Practical hints" section (▷ page 324).

Switching off the ESP

Warning!



ESP should not be switched off during normal driving other than in the circumstances described below. Disabling of the system will reduce vehicle stability in standard driving maneuvers.

To improve the vehicle's traction, turn off the ESP in driving situations where it would be advantageous to have the drive wheels spin and thus cut into surfaces for better grip such as:

- starting out on slippery surfaces and in deep snow in conjunction with snow chains
- in sand or gravel



Turn on the ESP immediately if the aforementioned circumstances do not apply anymore.

When you switch off the ESP

- the ESP does not stabilize the vehicle
- the engine output is not limited, which allows the drive wheels to spin and thus cut into surfaces for better grip
- the traction control will still brake a spinning wheel
- the ESP continues to operate when you are braking
- you cannot activate DISTRONIC*



When the ESP is switched off and one or more drive wheels are spinning, the ABS/ESP warning lamp  in the speedometer flashes. However, the ESP will then not stabilize the vehicle.

Safety and Security

Driving safety systems

The switch is located in the lower part of the center console.



① ESP switch

- ▶ Press ESP switch ① until the ABS/ESP warning lamp  in the instrument cluster comes on.

ESP is deactivated.

Warning!



When the ABS/ESP warning lamp  is illuminated continuously, the ESP is switched off.

Adapt your speed and driving to the prevailing road conditions and to the non-operating status of the ESP.



Avoid spinning of a drive wheel for an extended period with the ESP switched off. This may cause serious damage to the drivetrain which is not covered by the Mercedes-Benz Limited Warranty.

Switching on the ESP

- ▶ Press ESP switch ①.

The ABS/ESP warning lamp  in the instrument cluster goes out.

You are now again in normal driving mode with the ESP switched on.



Turn on the ESP immediately if the aforementioned circumstances do not apply anymore.

SBC brake system

The SBC brake system combines a hydraulic brake circuit with electronically controlled brake servo assistance. You have increased braking safety and improved braking comfort.

Warning!



Never ignore a brake malfunction indicated in the speedometer display, for example by the **BRAKE** (USA only) or  (Canada only) indicator lamp. Refer to the “Practical hints” section (> page 326). Also read and observe the messages in the instrument cluster multifunction display (> page 347).

Warning!



The SBC brake system requires electrical power to operate.

A malfunction in the vehicle's power supply or electrical system may impair brake system operation and switch it into its emergency operation mode. In such a case, the red brake warning lamp (> page 326) comes on and warning messages (> page 347) appear in the multifunction display while driving. To brake, the driver must then apply significantly greater brake pedal pressure and depress the pedal much further to obtain the expected braking effect. If necessary, apply full pressure to the brake pedal. Brakes are only applied to the front wheels. Stopping distance is increased!

If there is a malfunction in the SBC brake system, we recommend that the vehicle be transported with all wheels off the ground using flatbed or appropriate wheel lift/dolly equipment.

A tow bar must be used if circumstances do not permit the use of the recommended towing methods and the vehicle requires towing with all four wheels on the ground. Towing the vehicle with all four wheels on the ground is only permissible for distances up to 30 miles (50 km) and at a speed not to exceed 30 mph (50 km/h). For more information, see “Towing the vehicle” (> page 408).

Safety and Security

Driving safety systems

The SBC brake system is automatically activated when you

- unlock the vehicle with the SmartKey or the SmartKey with KEYLESS-GO*
- open the driver's or passenger door
- turn the SmartKey in the starter switch to position **1**
- in vehicles with KEYLESS-GO*, press the start/stop button on the gear selector lever once
- depress the brake pedal
- release the parking brake



If the SBC brake system is activated as the brake pedal is first depressed, you may feel a reduced pedal resistance and longer pedal travel than normal. When releasing the pedal, you may also feel the brake pedal pulsate and you may hear a sound which is caused by the activation of the SBC brake system pump. This is normal and not an indication of a malfunction. Pedal travel returns to normal when you release the brake pedal and the sound soon ceases.

If you experience the above while driving and the red brake warning lamp (> page 326) illuminates and/or warning messages appear in the multifunction display (> page 347), the brake system is malfunctioning. Follow the instructions of the warning message(s) and have the brake system checked immediately.

Warning!



Have brake pad replacement and other work on the SBC brake system carried out by qualified technicians only. Contact an authorized Mercedes-Benz Center for further information. The SBC brake system must be deactivated prior to working on the system. High pressure is intermittently built up in the system as part of its automatic self-test. In addition, the system is automatically activated when the vehicle is unlocked by remote control, when the driver or passenger door is opened, when the SmartKey in the starter switch is turned to position **1** or the KEYLESS-GO* start/stop button is pressed once, when the brake pedal is depressed or when the parking brake is released. Failure to deactivate the system prior to maintenance will cause brake pistons to extend and brake fluid to leak, which may result in injuries (contusions and acid burns). Extended brake pistons may also cause injury.

The SBC brake servo assistance switches off automatically

- approximately two minutes after you turned the SmartKey in the starter switch to position **0** or removed the SmartKey
- approximately two minutes after you pressed the KEYLESS-GO* start/stop button to turn off the engine or power supply and opened the driver's door (with driver's door open, the starter switch is set to position **0**, same as SmartKey removed from starter switch)
- approximately 20 seconds after you locked the vehicle from outside

Note on driving with the SBC brake system

- Following extended periods of only minor loads to your brake system, you should occasionally apply the brakes when traveling at high speeds. This improves the grip of the brake pads.

After driving on wet or snow-covered roads, you should apply your brakes firmly before parking your vehicle. This produces heat which serves to dry the brake disks and help prevent corrosion.

Warning!



Be very careful not to endanger other road users when you apply the brakes.

- On long and steep grades, shift to a lower gear (gear range **1**, **2**, or **3**) to prevent the brakes from overheating and to reduce brake wear.
- After hard braking, it is advisable to drive on for some time so that the air stream will cool down the brakes faster.
- Only Mercedes-Benz approved components (e.g. brake pads) should be installed on your vehicle. Brake pads not approved by Mercedes-Benz may impair the safety of your vehicle.

Safety and Security

Anti-theft systems

Immobilizer

The immobilizer prevents unauthorized persons from starting your vehicle.

Activating

With the SmartKey

- ▶ Remove the SmartKey from the starter switch.

*With KEYLESS-GO**

- ▶ Press the start/stop button on the gear selector lever once.
The engine is turned off.
- ▶ Open the driver's door.

Deactivating

With the SmartKey

- ▶ Turn the SmartKey in the starter switch to position **2** (▷ page 36).

*With KEYLESS-GO**

- ▶ Switch on the ignition (▷ page 38).



Starting the engine will also deactivate the immobilizer.

In case the engine cannot be started (yet the vehicle's battery is charged), the system is not operational. Contact an authorized Mercedes-Benz Center or call 1-800-FOR-MERCEdes (in the USA), or 1-800-387-0100 (in Canada).

Anti-theft alarm system

Once the alarm system has been armed, a visual and audible alarm is triggered when someone opens

- a door
- the trunk lid
- the hood
- a storage compartment in the rear
- the glove box
- the storage compartment under the armrest

The alarm will stay on, even if the activating element (a door, for example) is immediately closed.

The alarm system will also be triggered when

- someone attempts to raise the vehicle
- unlocking and opening the driver's door with the mechanical key
- someone opens a door from the inside if the vehicle was locked from the outside with the SmartKey
- someone opens the trunk lid with the emergency release button



If the alarm stays on for more than 30 seconds, a call to the Response Center is initiated automatically by the Tele Aid system (▷ page 239) provided Tele Aid service was subscribed to and properly activated, and that necessary cellular service and GPS coverage are available.

Arming the alarm system

The alarm system is armed after locking the vehicle with the SmartKey or KEYLESS-GO*. The turn signal lamps flash three times to indicate that the alarm system is activated. The  indicator lamp in the central locking switch (▷ page 29) begins to flash after arming the alarm system.



If the turn signal lamps do not flash three times, a door or the trunk lid may not be properly closed.

Close the respective element and lock the vehicle again.

Disarming the alarm system

The alarm system is disarmed when you unlock your vehicle with the SmartKey or KEYLESS-GO*. The turn signal lamps flash once to indicate that the alarm system is deactivated.



The alarm system will rearm automatically again after approximately 40 seconds if no door was opened.



Safety and Security

Anti-theft systems

Canceling the alarm

To cancel the alarm:

With the SmartKey

- ▶ Insert the SmartKey in the starter switch.
or
- ▶ Press the  or  button on the SmartKey.

*With KEYLESS-GO**

- ▶ Grasp the outside door handle.
The SmartKey with KEYLESS-GO must be within 3 ft. (1 m) of the vehicle.
or
- ▶ Press the KEYLESS-GO start/stop button.
The SmartKey with KEYLESS-GO must be inside the vehicle.

Tow-away alarm

Once the tow-away alarm is armed, a visual and audible alarm will be triggered when someone attempts to raise the vehicle.



The tow-away protection alarm is triggered, for example, if the vehicle is lifted on one side.

If the alarm stays on for more than 30 seconds, a call to the Response Center is initiated automatically by the Tele Aid system (▷ page 239) provided Tele Aid service was subscribed to and properly activated, and that necessary cellular service and GPS coverage are available.

Arming tow-away alarm

When you lock your vehicle, the tow-away alarm is automatically armed after about 30 seconds.

When you unlock your vehicle, the tow-away protection disarms automatically.

Disabling tow-away alarm

To prevent triggering the tow-away alarm, disable off the tow-away alarm feature before towing the vehicle, or when parking on a surface subject to movement, such as a ferry or auto train.

The button is located on the center console between the driver's seat and the passenger seat.



- ① Tow-away alarm off button
- ② Indicator lamp

- ▶ Switch off ignition and remove the SmartKey from the starter switch.



You cannot disarm the tow-away alarm if the ignition is switched on.

- ▶ Press button ①.
The indicator lamp ② in the switch comes on briefly.



- ▶ Exit and lock your vehicle with the SmartKey or (vehicles with KEYLESS-GO*) with the lock button at each door handle or trunk lid.

The tow-away alarm remains disarmed until you lock your vehicle again.

Canceling tow-away alarm

To cancel the alarm:

With the SmartKey

- ▶ Insert the SmartKey in the starter switch.
or
- ▶ Press the  or  button on the SmartKey.

*With KEYLESS-GO**

- ▶ Grasp the outside door handle.
or
- ▶ Press the KEYLESS-GO start/stop button.





Controls in detail

Locking and unlocking

Seats

Memory function

Lighting

Instrument cluster

Control system

Automatic transmission

Good visibility

Automatic climate control

Power windows

Retractable hardtop

Driving systems

Useful features

Controls in detail

Locking and unlocking

In the “Controls in detail” section you will find detailed information on how to operate the equipment installed on your vehicle. If you are already familiar with the basic functions of your vehicle, this section will be of particular interest to you.

To quickly familiarize yourself with the basic functions of the vehicle, refer to the “Getting started” section of this manual. The corresponding page numbers are given at the beginning of each segment.

For more information on locking and unlocking, see the Getting started section (▷ page 34).

SmartKey

Your vehicle comes supplied with two SmartKeys, each with remote control and a removable mechanical key.

The locking tabs for the mechanical key portion of the two SmartKeys are a different color to help distinguish each SmartKey unit.

The SmartKey provides an extended operating range. To prevent theft, however, it is advisable to only unlock the vehicle when you are in close proximity to it.

The SmartKey centrally locks and unlocks:



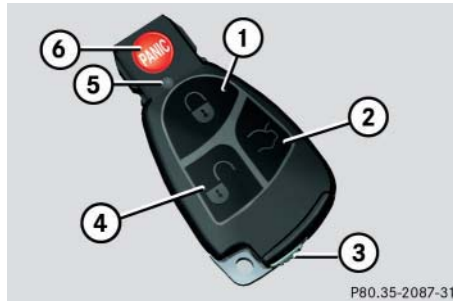

- the doors
- the trunk lid
- the glove box
- the storage compartment under the armrest
- the storage compartment in the rear
- the fuel filler flap

Controls in detail

Locking and unlocking



SmartKey with remote control

- ①  Lock button
- ②  Unlock button for the trunk lid
- ③ Mechanical key locking tab
- ④  Unlock button
- ⑤ Battery check lamp
- ⑥  Panic button (▷ page 78)

Warning!



When leaving the vehicle, always remove the SmartKey from the starter switch, take it with you, and lock the vehicle. Do not leave children unattended in the vehicle, or with access to an unlocked vehicle. It is possible for children to open a locked door from the inside, which could result in an accident and/or serious injury.



To prevent possible malfunction, avoid exposing the SmartKey to high levels of electromagnetic radiation.



USA only:

This device complies with Part 15 of the FCC Rules. Operation is subject to the following two conditions:

- (1) This device may not cause harmful interference, and
- (2) this device must accept any interference received, including interference that may cause undesired operation.

Any unauthorized modification to this device could void the user's authority to operate the equipment.

Controls in detail

Locking and unlocking



Canada only:

This device complies with RSS-210 of Industry Canada. Operation is subject to the following two conditions:

- (1) This device may not cause interference, and
- (2) this device must accept any interference received, including interference that may cause undesired operation of the device.

Any unauthorized modification to this device could void the user's authority to operate the equipment.



You can also open and close the power windows (▷ page 193) and the retractable hardtop using the SmartKey (▷ page 200).

Factory setting

Global unlocking

- ▶ Press button

All turn signals flash once. The locking knobs in the doors move up. The anti-theft alarm system is disarmed.

The vehicle will lock again automatically within approximately 40 seconds of unlocking if:

- neither door nor trunk is opened
- the SmartKey is not inserted in the starter switch
- the central locking switch is not activated

Global locking

- ▶ Press button

All turn signals flash three times. The locking knobs in the doors move down. The anti-theft alarm system is armed.

Selective setting

If you frequently travel alone, you may wish to reprogram the SmartKey so that pressing only unlocks the driver's door, interior lockable storage compartments and the fuel filler flap.

- ▶ Press and hold buttons and simultaneously for about six seconds until battery check lamp flashes twice.

The SmartKey will then function as follows:

Unlocking driver's door and fuel filler flap

- ▶ Press button once.

All turn signals flash once. The locking knob in the driver's door moves up. The anti-theft alarm system is disarmed.

Global unlocking

- ▶ Press button  twice.



All turn signals flash once. The locking knobs in the doors move up. The anti-theft alarm system is disarmed.

Global locking

- ▶ Press button .

All turn signals flash three times. The locking knobs in the doors move down. The anti-theft alarm system is armed.

Restoring to factory setting

- ▶ Press and hold buttons  and  simultaneously for about six seconds until battery check lamp  (▷ page 94) flashes twice.





If you can no longer lock or unlock the vehicle with the SmartKey, then the batteries in the SmartKey are discharged, the SmartKey is malfunctioning or the vehicle battery is drained.

- Check the batteries in the SmartKey (▷ page 97) and replace them if necessary (▷ page 377).
- Use the mechanical key to unlock the driver's door (▷ page 374).
- Have the vehicle batteries and their connections checked (▷ page 401).
- Use the mechanical key to lock or unlock the doors (▷ page 376).

If the SmartKey is malfunctioning, contact an authorized Mercedes-Benz Center.

Checking the batteries

- ▶ Press button  or .

Battery check lamp  (▷ page 94) comes on briefly to indicate that the SmartKey batteries are in order.





If battery check lamp  does not come on briefly during check, then the SmartKey batteries are discharged.

- Replace the batteries (▷ page 377).

You can obtain the required batteries at any authorized Mercedes-Benz Center.



If the batteries are checked within signal range of the vehicle, pressing the  or  button will lock or unlock the vehicle accordingly.

Controls in detail

Locking and unlocking

Unlocking the trunk

You can unlock the trunk separately.

A minimum height clearance of 6.2 ft (1.88 m) is required to open the trunk lid.

- ▶ Press and hold button  on the SmartKey until trunk unlocks.



If the vehicle was previously centrally locked, the trunk lid will lock automatically when closed. The turn signals will flash three times to confirm locking.

Loss of SmartKey or mechanical key

If you lose a SmartKey or mechanical key, you should do the following:

- ▶ Have the SmartKey deactivated by an authorized Mercedes-Benz Center.
- ▶ Report the loss of the SmartKey or the mechanical key to your car insurance company immediately.
- ▶ If necessary, have the mechanical lock replaced.

Your authorized Mercedes-Benz Center will be glad to supply you with a replacement.

SmartKey with KEYLESS-GO*

Vehicles equipped with KEYLESS-GO come with two SmartKeys with KEYLESS-GO, each with remote controls and a removable mechanical key.

The locking tabs for the mechanical key portion of the two SmartKeys with KEYLESS-GO are a different color to help distinguish each SmartKey with KEYLESS-GO unit.

The function of the SmartKey overrules the KEYLESS-GO function.



The KEYLESS-GO function is integrated into the SmartKey. On these vehicles, the validity of the SmartKey with KEYLESS-GO is checked every time you grasp a door handle.

If the SmartKey with KEYLESS-GO is valid, your vehicle unlocks

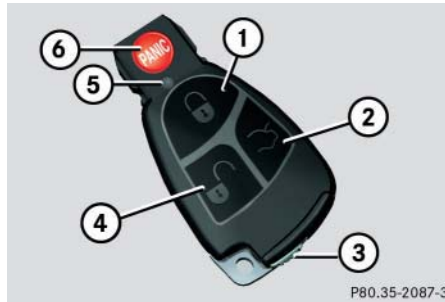
- the doors
- the trunk lid
- the glove box
- the storage compartment under the armrest
- the storage compartment in the rear
- the fuel filler flap



SmartKey with KEYLESS-GO

- ①  Lock button
- ②  Unlock button for the trunk lid
- ③ Mechanical key locking tab
- ④  Unlock button
- ⑤ Battery check lamp
- ⑥ **PANIC** Panic button (▷ page 78)

For information on using the SmartKey buttons, see “SmartKey” (▷ page 94).

Controls in detail

Locking and unlocking

Warning!



When leaving the vehicle, always take the SmartKey with KEYLESS-GO with you and lock the vehicle. Do not leave children unattended in the vehicle, or with access to an unlocked vehicle. Unsupervised use of vehicle equipment may cause an accident and/or serious personal injury.



To prevent possible malfunction, avoid exposing the SmartKey with KEYLESS-GO to high levels of electromagnetic radiation.

Controls in detail

Locking and unlocking



USA only:

This device complies with Part 15 of the FCC Rules. Operation is subject to the following two conditions:

- (1) This device may not cause harmful interference, and
- (2) this device must accept any interference received, including interference that may cause undesired operation.

Any unauthorized modification to this device could void the user's authority to operate the equipment.



Canada only:

This device complies with RSS-210 of Industry Canada. Operation is subject to the following two conditions:

- (1) This device may not cause interference, and
- (2) this device must accept any interference received, including interference that may cause undesired operation of the device.

Any unauthorized modification to this device could void the user's authority to operate the equipment.



You can also close the power windows (▷ page 193) and the retractable hard-top using the SmartKey with KEYLESS-GO (▷ page 200).



When you unlock the vehicle, the SBC brake system is activated.

Important notes on using KEYLESS-GO

- You can also use the SmartKey with KEYLESS-GO like a normal SmartKey (▷ page 94).
- You can combine KEYLESS-GO functions with normal SmartKey functions (e.g. unlocking with KEYLESS-GO and locking with the  button).
- Always carry the SmartKey with KEYLESS-GO with you.
- Never store the SmartKey with KEYLESS-GO together with:
 - Electronic items such as a cellular phone or another SmartKey with KEYLESS-GO
 - Metallic objects such as coins or metal foil

Doing so could impair the function of the KEYLESS-GO system.

- To lock or unlock the vehicle, the SmartKey with KEYLESS-GO must be located outside the vehicle within approximately 3 ft (1 m) of a door or the trunk.
- In order to start the engine with the SmartKey with KEYLESS-GO:
 - The SmartKey with KEYLESS-GO must be located in the vehicle.
 - All doors must be closed.
 - The brake pedal must be firmly depressed. Do not depress the accelerator.
- If you have started the engine with the KEYLESS-GO start/stop button (▷ page 37), you can only turn it off again with this button, even if you have put the SmartKey in the starter switch in the meantime.
- This does not apply if, after starting, the selector lever is still in position **P** and the SmartKey is then inserted in the starter switch. The SmartKey will then have priority over the KEYLESS-GO function and the vehicle's electrical system will operate according to the position of the SmartKey in the starter switch, even stopping the engine.
- If the SmartKey with KEYLESS-GO is positioned farther away from the vehicle, the system may no longer recognize the SmartKey with KEYLESS-GO. The vehicle then cannot be locked or the engine started via the KEYLESS-GO system.

Controls in detail

Locking and unlocking

- If the SmartKey with KEYLESS-GO is removed from the vehicle while the engine is running (e.g. if passenger exits the vehicle with the SmartKey with KEYLESS-GO), the message *Key not recognized!* will appear in the multifunction display while driving off.

Find the SmartKey or change its present location immediately (e.g. place it on the front passenger seat or insert it in shirt pocket).

- Remember that the engine can be started by anyone with a SmartKey with KEYLESS-GO that is left inside the vehicle. If you leave the SmartKey with KEYLESS-GO behind when exiting and locking the vehicle, the message *Key recognized in vehicle!* will appear in the multifunction display.

Factory setting

Global unlocking

- ▶ Grasp the door handle.

All turn signals flash once. The locking knobs in the doors move up. The anti-theft alarm system is disarmed.



If the vehicle has been parked for more than 72 hours, you must pull the outside door handle in order to activate the KEYLESS-GO function.

The vehicle will lock again automatically within approximately 40 seconds of unlocking if neither door nor trunk is opened.



The vehicle could inadvertently unlock if the SmartKey with KEYLESS-GO is within 3 ft (1 m) of the vehicle and

- the door handle is splashed with water
- or
- you attempt to clean the door handle



Global locking

- ▶ Press lock button at door handle (▷ page 60) or trunk (▷ page 104).

All turn signals flash three times. The locking knobs in the doors move down. The anti-theft alarm system is armed.

Selective setting

If you frequently travel alone, you may wish to reprogram the SmartKey with KEYLESS-GO so that grasping a door handle only unlocks the driver's door, interior lockable storage compartments and the fuel filler flap.

- ▶ Press and hold buttons  and  simultaneously for about six seconds until battery check lamp  (▷ page 94) flashes twice.

The SmartKey with KEYLESS-GO will then function as follows:

Unlocking the driver's door and fuel filler flap

- ▶ Grasp the driver's door handle.
All turn signals flash once. The locking knob in the driver's door moves up. The anti-theft alarm system is disarmed.



Global unlocking

- ▶ Grasp the door handle on the passenger side.
All turn signals flash once. The locking knobs in the doors move up. The anti-theft alarm system is disarmed.

Global locking

- ▶ Press lock button at door handle or trunk lid.
All turn signals flash three times. The locking knobs in the doors move down. The anti-theft alarm system is armed.

Restoring to factory setting

- ▶ Press and hold buttons  and  simultaneously for about six seconds until battery check lamp  (▷ page 98) flashes twice.



If you can no longer lock or unlock the vehicle with the SmartKey with KEYLESS-GO, then the battery in the SmartKey is discharged, the SmartKey with KEYLESS-GO is malfunctioning or the vehicle battery is drained.

- Check the battery in the SmartKey with KEYLESS-GO (▷ page 97) and replace it if necessary (▷ page 377).

Controls in detail

Locking and unlocking

- Use the mechanical key to unlock the driver's door (▷ page 374).
- Have the vehicle batteries and their connections checked (▷ page 401).
- Use the mechanical key to lock or unlock the doors (▷ page 376).

If the SmartKey with KEYLESS-GO is malfunctioning, contact an authorized Mercedes-Benz Center.

Global locking using the lock button at trunk lid



Vehicles with KEYLESS-GO*: To prevent a possible inadvertent lockout, the trunk lid will open automatically if a SmartKey with KEYLESS-GO is recognized inside the trunk.

When the hardtop is retracted, it must be completely lowered in the trunk before the trunk lid can be closed (▷ page 235).

- ▶ Press lock button ① at trunk lid.

All turn signals flash three times. The locking knobs in the doors move down. The anti-theft alarm system is armed.



You can also lock the vehicle using the lock button at the outside door handle (▷ page 60).

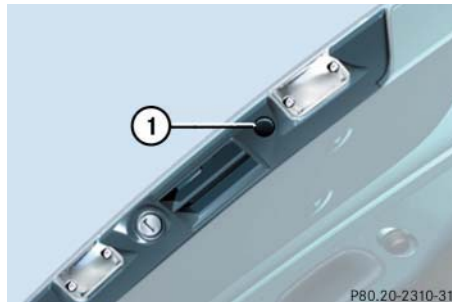

① Lock button at trunk lid

Checking the battery

- ▶ Press button  or .

Battery check lamp ⑤ (▷ page 98) comes on briefly to indicate that the SmartKey batteries are in order.



If battery check lamp ⑤ (▷ page 98) does not come on briefly during check, then the SmartKey battery is discharged.

- Replace the battery (▷ page 377).

You can obtain the required battery at any authorized Mercedes-Benz Center.

Unlocking the trunk

You can unlock the trunk separately.

A minimum height clearance of 6.2 ft (1.88 m) is required to open the trunk lid.

The handle is located above the rear license plate recess.

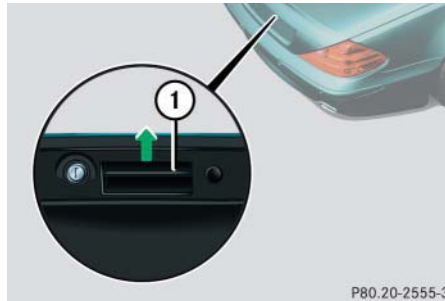

① Handle

- ▶ Pull on handle ①.

The vehicle unlocks the trunk lid only.

Controls in detail

Locking and unlocking



If the vehicle was previously centrally locked, the trunk lid will lock automatically when closed (▷ page 109). The turn signals will flash three times to confirm locking.

To prevent a possible inadvertent lock-out, the trunk lid will open automatically if a SmartKey with KEYLESS-GO is recognized inside the trunk.

Controls in detail

Locking and unlocking

Loss of SmartKey with KEYLESS-GO

If you lose your SmartKey with KEYLESS-GO, you should do the following:

- ▶ Have the SmartKey with KEYLESS-GO deactivated by an authorized Mercedes-Benz Center.
- ▶ Report the loss of the SmartKey with KEYLESS-GO or the mechanical key to your car insurance company immediately.
- ▶ Have the mechanical lock replaced if necessary.

Your authorized Mercedes-Benz Center will be glad to supply you with a replacement.

Opening the doors from the inside

You can open a locked door from the inside. Open door only when conditions are safe to do so.

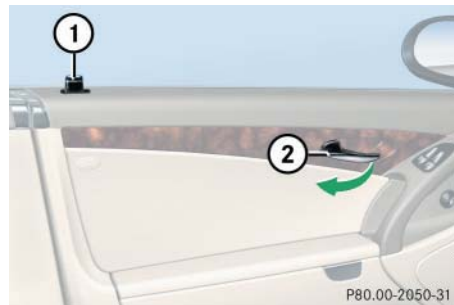

- ① Locking knob
- ② Inside door handle

- ▶ Pull on door handle ②.



If door was locked, locking knob ① will move up.

i

If the vehicle has previously been locked from the outside with the SmartKey, opening a door from the inside will trigger the anti-theft alarm system.

To cancel the alarm, do one of the following:

With the SmartKey

- Insert the SmartKey in the starter switch.
- Press button  or  on the SmartKey.

With KEYLESS-GO*

- Press the KEYLESS-GO* start/stop button (▷ page 49).
- Grasp the outside door handle



If you open a door, the side windows on that side of the vehicle will lower slightly. The windows close again when you close the door.

Opening the trunk

A minimum height clearance of 6.2 ft (1.88 m) is required to open the trunk lid.



Always make sure that there is sufficient overhead clearance.

Opening the trunk from the outside

The handle is located above the rear license plate recess.

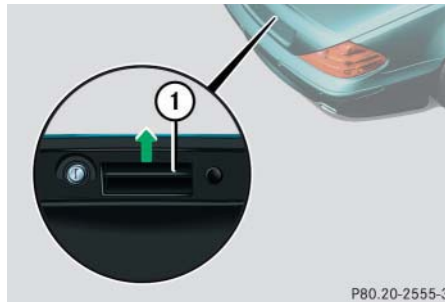

① Handle



Vehicles without KEYLESS-GO*:
The vehicle must be unlocked.

► Pull on handle ① and lift the trunk lid.

Controls in detail

Locking and unlocking



To facilitate trunk loading and unloading when the hardtop is retracted, you can raise the hardtop from its storage position in the trunk using the load assist feature (▷ page 235). You may also unhook the luggage cover.

Remember to resecure the luggage cover after loading/unloading the trunk. Otherwise you will not be able to lower the retractable hardtop.

Vehicles without KEYLESS-GO*:
If the trunk lid does not open, the entire vehicle is still locked globally (▷ page 94).

Controls in detail

Locking and unlocking

The trunk can also be opened using

- the SmartKey, see “Locking and unlocking” (▷ page 94)
- the remote trunk lid release switch, see “Opening the trunk from the inside” (▷ page 108)
- the trunk lid emergency release button, see “Trunk lid emergency release” (▷ page 109)

Opening the trunk from the inside

You can open the trunk from the inside if the vehicle is stationary and the retractable hardtop is fully opened or closed.

The switch is located on the driver’s door.

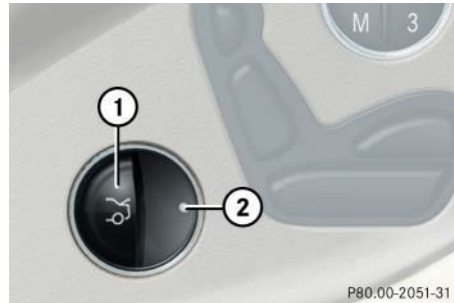

- ① Remote trunk lid release switch
- ② Indicator lamp

- ▶ Pull remote trunk lid release switch ①.

The trunk lid unlocks. Indicator lamp ② comes on and remains lit until the trunk is closed again.

- ▶ Lift the trunk lid.

i

To facilitate trunk loading and unloading when the hardtop is retracted, you can raise the hardtop from its storage position in the trunk using the loading aid feature (▷ page 235). You may also unhook the luggage cover.

Remember to resecure the luggage cover after loading/unloading the trunk. Otherwise you will not be able to lower the retractable hardtop.

The trunk can also be opened using

- the SmartKey, see “Locking and unlocking” (▷ page 94)
- the remote trunk lid release switch, see “Opening the trunk from the inside” (▷ page 108)
- the trunk lid emergency release button, see “Trunk lid emergency release” (▷ page 109)

Closing the trunk

Warning!



To prevent possible personal injury, always keep hands and fingers away from the trunk opening when closing the trunk lid. Be especially careful when small children are around.

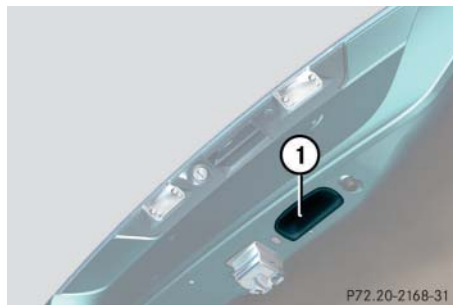

① Handle

- ▶ Lower trunk lid by firmly pulling on handle ①.

- ▶ Close trunk lid with hands placed flat on trunk lid.

Warning!



Only drive with the trunk closed. Among other dangers, such as your view being blocked, exhaust fumes may enter the vehicle interior.



To prevent an inadvertent lockout, do not place the SmartKey in the trunk.

Vehicles with KEYLESS-GO*: To prevent a possible inadvertent lockout, the trunk lid will open automatically if a SmartKey with KEYLESS-GO is recognized inside the trunk.

When the hardtop is retracted, it must be completely lowered in the trunk before the trunk lid can be closed (▷ page 235).

Controls in detail

Locking and unlocking

Trunk lid emergency release

The emergency release button is located on the left side of the trunk.



① Emergency release button

- ▶ Briefly press emergency release button ①.

The trunk unlocks and the trunk lid opens slightly.

- ▶ Push up the trunk lid to fully open. ▷▷

Controls in detail

Locking and unlocking



The emergency release button unlocks the trunk while the vehicle is standing still or in motion.

Illumination of the emergency release button:

- The button flashes for 30 minutes after opening the trunk.
- The button flashes for 60 minutes after closing the trunk.





The emergency release button does not open the trunk lid if the vehicle battery is discharged or disconnected.



If the emergency release button is pressed and the vehicle was centrally locked, the exterior lamps will flash and the alarm will sound as the trunk lid opens.

To cancel the alarm, do one of the following:

With the SmartKey

- Insert the SmartKey in the starter switch.
- Press button  or  on the SmartKey.

With KEYLESS-GO*

- Grasp the outside door handle.
- Press the KEYLESS-GO* start/stop button.

Automatic central locking

The doors and the trunk lid lock automatically when the vehicle is set into motion.

You can open a locked door from the inside. Open door only when conditions are safe to do so.



The doors unlock automatically after an accident if the force of the impact exceeds a preset threshold.

The vehicle locks automatically when the ignition is switched on and the wheels are turning at vehicle speeds of approximately 9 mph (15 km/h) or more. You could therefore lock yourself out when the vehicle

- is pushed
- is on a test stand

You can deactivate the automatic locking using the control system (▷ page 156).

Controls in detail

Locking and unlocking

Locking and unlocking from the inside

You can lock or unlock the vehicle from inside using the central locking switches. This can be useful, for example, if you want to unlock the passenger door from the inside or want to lock the vehicle before starting to drive.

The central locking switch does not lock or unlock the fuel filler flap.

Warning!



When leaving the vehicle, always remove the SmartKey or the SmartKey with KEYLESS-GO* from the starter switch, take it with you, and lock the vehicle. Do not leave children unattended in the vehicle, or with access to an unlocked vehicle. Unsupervised use of vehicle equipment may cause an accident and/or serious personal injury.

Warning!



You can open a locked door from inside at any time. Open door only when conditions are safe to do so.

The switches are located above and between the center air vents of the air conditioning.



Central locking switches

- ① Locking
- ② Unlocking

Locking

- ▶ Press central locking switch ①.

If all the doors are closed, the vehicle locks.

Unlocking

- ▶ Press central locking switch ②.

The vehicle unlocks.

Controls in detail

Locking and unlocking



If the vehicle was previously centrally locked using the SmartKey or the SmartKey with KEYLESS-GO*, it will not unlock using the central locking switch.

If the vehicle was previously locked with the central locking switch

- while in the global remote control mode, the complete vehicle is unlocked when a door is opened from the inside
- while in the selective remote control mode, only the door opened from the inside is unlocked

▼ Seats

For more information on seat adjustment, see “Seat adjustment” (▷ page 40).

Easy-entry / exit feature

This feature allows for easier entry into and exit from the vehicle.

The easy-entry/exit feature can be activated or deactivated in the Convenience sub-menu of the SETTINGS menu of the control system (▷ page 157).

Warning!



You must make sure no one can become trapped or injured by the moving steering wheel and driver's seat when the easy-entry/exit feature is activated.

To cancel seat/steering wheel movement, do one of the following:

- Press seat adjustment switch (▷ page 40).
- Move steering column stalk (▷ page 42).
- Press the memory button (▷ page 120).

Controls in detail

Seats

Do not leave children unattended in the vehicle, or with access to an unlocked vehicle. Children could open the driver's door and unintentionally activate the easy-entry/exit feature, which could result in an accident and/or serious personal injury.

When exiting the vehicle, with the easy-entry/exit feature activated and depending on your selection, the steering wheel tilts upwards and/or the driver's seat moves a few inches to the rear when you

- remove the SmartKey from the starter switch
- or
- open the driver's door with the SmartKey in starter switch position **0** or **1** or the KEYLESS-GO* start/stop button in position **1** (▷ page 37)

Controls in detail

Seats



If the current position for the steering wheel is in the uppermost tilt position, the steering wheel will no longer be able to move upward when the easy-entry/exit feature is activated.

If the current seat position falls into a factory-set position range and the system recognizes the current seat position to be rearward enough for easy entry and exit, the driver's seat will not move to the rear when the easy-entry/exit feature is activated.

When entering the vehicle, with the easy-entry/exit feature activated, the steering wheel or, depending on your selection, the steering wheel and driver's seat will return to their last set memory position or a factory-set maximum forward position when you

- close the driver's door with the ignition switched on
- insert the SmartKey into the starter switch or press the KEYLESS-GO* start stop button once with the driver's door closed



For safety reasons, the driver's seat will not return to its last set position with the easy-entry/exit feature activated if the system recognizes the last set position as an extreme forward position. Instead, the driver's seat will remain at or move to a factory-set maximum forward position. To again fully return the driver's seat to your last set position or to memory position, adjust the seat to the desired position or press and hold the respective memory position button (▷ page 120).

Moving the seats forward and backward

You can move the seats forward and back to facilitate loading and unloading.

Warning!



When moving the seats, be sure that no one can be caught by them. Never place hands under seat or near any moving parts during a seat adjustment procedure. To stop the seat from moving when potential danger exists:

- press the switch again
- move the seat adjustment switch on the door (▷ page 39)



When moving the seats, make sure that there are no items in the footwell or behind the seats. Otherwise you could damage the seats.

The switch is located on the top side of the seat.

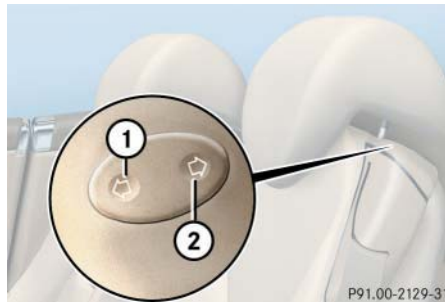

- ① Seat forward
- ② Seat backward

Moving the seat forward

- ▶ Press switch at ①.

Moving the seat backward

- ▶ Press switch at ②.

Controls in detail

Seats

Lumbar support

You can adjust the contour of the seat's lumbar support to best support your spine.

The thumbwheel is located on the lower side of the seat.



- ① Thumb wheel
- ▶ Switch on the ignition (▷ page 36).
- ▶ Set the lumbar support between 0 and 5.

Controls in detail

Seats

Multicontour backrest* (standard on SL 600, SL 55 AMG, and SL 65 AMG)

The multicontour backrest has inflatable air cushions built into the seat backrest to provide additional lumbar and side support.

The seat backrest cushion height and curvature can be continuously varied with switches on the lower side of the seat when the ignition is switched on.



- ① Shoulder region support
- ② Side bolsters adjustment
- ③ Massage function (PULSE)
- ④ Lumbar region support

- ▶ Switch on the ignition (▷ page 36).

Shoulder region support

- ▶ Press **+** or **-** on switch ①.

The air cushion inflates or deflates.

Lumbar region support

- ▶ Press **▽** or **△** on rocker switch ④.

This selects the air cushion you wish to adjust.

- ▶ Press **+** or **-** on rocker switch ④.

The air cushion inflates or deflates.

Side bolsters adjustment

- ▶ Press switch ② to the right or left.

The lateral support increases or decreases.

Massage function (PULSE)

You can reduce muscle tension during long trips by periodically using the massage function.

- ▶ Press button ③.

The indicator lamp on button ③ comes on. The air cushions in the lumbar region inflate and deflate rhythmically.



The massage function switches off automatically after approximately eight minutes. The indicator lamp goes out.

Seat heating

Vehicles without seat ventilation*

The switch is located on the door.



① Normal heating

② Rapid heating

- ▶ Switch on the ignition (▷ page 36).

Switching on seat heating

- ▶ Press lower switch position ①.

A red indicator lamp on the switch comes on.

Switching off seat heating

- ▶ Press lower switch position ① again.



The seat heating will be automatically switched off after approximately 30 minutes.

Switching on rapid seat heating

- ▶ Press upper switch position ②.

Both red indicator lamps on the switch come on.



The system switches to normal heating mode after approximately five minutes. Only the right-hand indicator lamp remains lit.

Switching off rapid seat heating

- ▶ Press upper switch position ② again.



If one or both of the lamps on the seat heating switch are flashing, there is insufficient voltage available since too many electrical consumers are turned on. The seat heating switches off automatically.

The seat heating will switch back on again automatically as soon as sufficient voltage is available.

Controls in detail

Seats

Vehicles with seat ventilation*

The switch is located on the door. The red indicator lamps on the switch indicate the selected heating level:

Level	
off	No indicator lamp on
1	One indicator lamp on
2	Two indicator lamps on



① Seat heating switch

- ▶ Switch on the ignition (▷ page 36).

Switching on seat heating

- ▶ Press upper switch position ① twice.

A red indicator lamp on the switch comes on.

Switching off seat heating

- ▶ Press upper switch position ① again.



The seat heating will be automatically switched off after approximately 30 minutes.

Switching on rapid seat heating

- ▶ Press upper switch position ① once.

Both indicator lamps on the switch come on.



The system switches to normal heating mode after approximately five minutes. Only the right-hand indicator lamp remains lit.

Switching off rapid seat heating

- ▶ Press upper switch position ① twice.



If one or both of the lamps on the seat heating switch are flashing, there is insufficient voltage available since too many electrical consumers are turned on. The seat heating switches off automatically.

The seat heating will switch back on again automatically as soon as sufficient voltage is available.

Seat ventilation* (standard on SL 600 and SL 65 AMG)

The switch is located on the door. The blue indicator lamps on the switch indicate the selected ventilation level:

Level	
3	Three indicator lamps on
2	Two indicator lamps on
1	One indicator lamp on
off	No indicator lamp on



① Seat ventilation switch

- ▶ Switch on the ignition (▷ page 36).

Switching on seat ventilation

- ▶ Press switch ①.
- ▶ Three blue indicator lamps on the switch come on.
- ▶ Continue pressing switch ① until the desired seat ventilation level is reached.

Switching off seat ventilation

- ▶ Press switch ① repeatedly until all indicator lamps go out.



In normal operation the seat ventilation will switch off automatically after about 30 minutes.



If one or all of the lamps on the seat ventilation switch are flashing, there is insufficient voltage available since too many electrical consumers are turned on. The seat ventilation switches off automatically.

The seat ventilation will switch back on again automatically as soon as sufficient voltage is available.

Controls in detail

Memory function



Prior to operating the vehicle, the driver should check and adjust the seat height, seat position fore and aft, and seat backrest angle if necessary, to ensure adequate control, reach and comfort. The head restraint should also be adjusted for proper height. See also the section on airbags (▷ page 63) for proper seat positioning.

In addition, adjust the steering wheel to ensure adequate control, reach, operation and comfort. Both the interior and exterior rear view mirrors should be adjusted for adequate rear vision.

Fasten seat belts. Infants and small children should be seated in a properly secured restraint system that complies with U.S. Federal Motor Vehicle Safety Standard 213 and Canadian Motor Vehicle Safety Standard 213.

With the memory switch you can store up to three different settings per SmartKey or SmartKey with KEYLESS-GO*.

The following settings are saved for each stored position:

- Driver's seat and backrest position
- Steering wheel position
- Driver's side exterior rear view mirror position
- Passenger side exterior rear view mirror position

These key-dependent memory settings can be deactivated if desired (▷ page 158).

Warning!



Do not activate the memory function while driving. Activating the memory function while driving could cause the driver to lose control of the vehicle.

The memory switch is located on the door.



M Memory button

1, 2, 3 Stored positions

- ▶ Switch on the ignition (▷ page 36).
- or
- ▶ Open the respective door.

Storing positions into memory

- ▶ Adjust the seats, steering wheel and exterior rear view mirrors to the desired position (▷ page 39).
- ▶ Press memory button **M**.
- ▶ Release memory button and press a stored position button **1**, **2**, or **3** within three seconds.

All the settings are stored at the selected position.

Recalling positions from memory

- ▶ On memory switch, press and hold stored position button **1**, **2** or **3** until the seat, steering wheel and exterior rear view mirrors have fully moved to the stored positions.



Releasing the button immediately stops movement to the stored positions.

Storing exterior rear view mirror parking position

For easier parking, you can adjust the passenger-side exterior rear view mirror so that you can see the right rear wheel as soon as you engage reverse gear **R**.

For information on activating the parking position feature, see “Setting parking position for exterior rear view mirror” (▷ page 158).



You can store a parking position for the passenger-side exterior rear view mirror for each SmartKey or SmartKey with KEYLESS-GO*.

Controls in detail

Memory function



- ① Passenger-side exterior rear view mirror
- ② Adjustment button
- M** Memory button

- ▶ Stop the vehicle.
- ▶ Switch on the ignition (▷ page 36).
- ▶ Press button ① in center console.

The passenger-side exterior rear view mirror is selected.

- ▶ Adjust the passenger-side exterior rear view mirror with button ② so that you see the rear wheel and the road curb.
- ▶ Press memory button **M**.
- ▶ Within three seconds, press adjustment button ② in the center console.

The parking position is stored if the mirror does not move.



If the mirror does move, repeat the above steps. After the setting is stored, you can move the mirror again.

▼ Lighting

For information on how to switch on the headlamps and use the turn signals, see “Switching on headlamps” (▷ page 51) and “Turn signals” (▷ page 52).



If you drive in countries where vehicles drive on the other side of the road than the country in which the vehicle is registered, you must have the headlamps modified for symmetrical low beams. Relevant information can be obtained at any authorized Mercedes-Benz Center.

Exterior lamp switch







The exterior lamp switch is located on the dashboard to the left of the steering wheel.



- 0** Off
Daytime running lamp mode
(▷ page 125)
- AUTO** Automatic headlamp mode
Daytime running lamp mode
(▷ page 125)

Controls in detail

Lighting

-  Parking lamps (also tail lamps, license plate lamps, side marker lamps, instrument panel lamps)
Canada only: When the engine is running, the low beam headlamps are also switched on.
-  Low beam headlamps (or high beam headlamps when the combination switch is pushed forward) and parking lamps
-  Standing lamps, right (turn left one stop)
-  Standing lamps, left (turn left two stops)
-  Indicator lamp for parking lamps
-  Indicator lamp for front fog lamps
-  Indicator lamp for rear fog lamp

Controls in detail

Lighting



With the SmartKey removed from the starter switch or the engine turned off with KEYLESS-GO* and the driver's door open, a warning sounds if the parking lamps or the low beam headlamps are switched on.

The message Turn off lamps appears in the multifunction display.

Manual headlamp mode

The low beam headlamps and parking lamps can be switched on or off with the exterior lamp switch.



With the daytime running lamp mode activated (mandatory in Canada) and the engine running, the low beam headlamps cannot be switched off manually.

To activate the daytime running lamp mode, see "Setting daytime running lamp mode (USA only)" (▷ page 152).

Automatic headlamp mode

The following lamps switch on and off automatically depending on the brightness of the ambient light:

- Low beam headlamps
- Tail lamps
- Parking lamps
- License plate lamps
- Side marker lamps

Warning!



If the exterior lamp switch is set to **AUTO**,

- the headlamps may switch off unexpectedly when the system senses bright ambient light, for example light from oncoming traffic.
- the headlamps will not be automatically switched on under foggy conditions.

To minimize risk to you and to others, activate headlamps by turning exterior lamp switch to when driving or when traffic and /or ambient lighting conditions require you to do so.

In low ambient lighting conditions, only switch from position **AUTO** to with the vehicle at a standstill. Switching from **AUTO** to will briefly switch off the headlamps. Doing so while driving in low ambient lighting conditions may result in an accident.

The automatic headlamp feature is only an aid to the driver. The driver is responsible for the operation of the vehicle's lights at all times.

- ▶ Turn the exterior lamp switch to position **AUTO**.

With the SmartKey in starter switch position **1** or the KEYLESS-GO start/stop button pressed once, only the parking lamps will switch on and off automatically.

When the engine is running, the low beam headlamps, the tail and parking lamps, the license plate lamps, and the side marker lamps will switch on and off automatically.



The fog lamps cannot be switched on with the exterior lamp switch in position **AUTO**. To switch on the fog lamps, turn the exterior lamp switch to position .

Daytime running lamp mode

- ▶ Turn the exterior lamp switch to position **0** or **AUTO**.

When the engine is running, the low beam headlamps are switched on automatically.

In low ambient light conditions, the following lamps will switch on additionally:

- Tail lamps
- Parking lamps
- License plate lamps
- Side marker lamps

For nighttime driving you should turn the exterior lamp switch to position  to permit activation of the high beam headlamps.



With the daytime running lamp mode activated and the exterior lamp switch in position **0**, the highbeam headlamps cannot be switched on.

The highbeam flasher is available at all times.

Controls in detail



Lighting

Canada only:

The daytime running lamp mode is mandatory and therefore in a constant mode.

When the engine is running and you shift from a driving position to position **N** or **P**, the low beam headlamps will switch off with a three-minute delay.

When the engine is running and you



- turn the exterior lamp switch to position , the parking lamps switch on additionally
- turn the exterior lamp switch to position , the manual headlamp mode has priority over the daytime running lamp mode

The corresponding exterior lamps switch on (▷ page 123).

USA only:

By default, the daytime running lamp mode is deactivated. Activate the daytime running lamp mode using the control system, see “Setting daytime running lamp mode (USA only)” (▷ page 152).

The high beam headlamps can also be activated when driving with the daytime running lamp mode activated and the exterior lamp switch in position .

When the engine is running and you turn the exterior lamp switch to position  or , the manual headlamp mode has priority over the daytime running lamp mode.

The corresponding exterior lamps switch on (▷ page 123).



Locator lighting and night security illumination

Locator lighting and night security illumination are described in the control system section, see “Setting locator lighting” (▷ page 153) and “Setting night security illumination” (▷ page 154).

Fog lamps

Warning!



In low ambient lighting or foggy conditions, only switch from position **AUTO** to  with the vehicle at a standstill. Switching from **AUTO** to  will briefly switch off the headlamps. Doing so while driving in low ambient lighting conditions may result in an accident.



Fog lamps will operate with the parking lamps and/or the low beam headlamps on. Fog lamps should only be used in conjunction with low beam headlamps. Consult your State or Province Motor Vehicle Regulations regarding permissible lamp operation.



The fog lamps cannot be switched on with the exterior lamp switch in position **AUTO**. To switch on the fog lamps, turn the exterior lamp switch to position  first.

Front fog lamps

- ▶ Switch on the low beam headlamps (▷ page 51).
- ▶ Pull out the exterior lamp switch to first stop.

The front fog lamps are switched on.

The green indicator lamp  in the exterior lamp switch comes on (▷ page 123).

- ▶ Push in the exterior lamp switch.

The front fog lamps are switched off.

The green indicator lamp  in the exterior lamp switch goes out.

Controls in detail

Lighting

Rear fog lamp (driver's side only)

- ▶ Switch on the front fog lamps (▷ page 127).
- ▶ Pull out the exterior lamp switch to second stop.

The rear fog lamp is switched on.

The yellow indicator lamp  in the lamp switch comes on (▷ page 123).

- ▶ Push in the exterior lamp switch to first stop.

The rear fog lamp is switched off.

The yellow indicator lamp  in the exterior lamp switch goes out.

The front fog lamps remain lit.

Controls in detail

Lighting

Combination switch

The combination switch is located on the left of the steering column.



Combination switch

- ① High beam
- ② High beam flasher

High beam

- ▶ Turn the exterior lamp switch to  or to **AUTO** (▷ page 123).
- ▶ Push the combination switch in direction of arrow ① to switch on the high beam headlamps.

The high beam indicator lamp  in the instrument cluster comes on.

- ▶ Pull the combination switch in direction of arrow ② to its original position to switch off the high beam headlamps.

The high beam indicator lamp  in the instrument cluster goes out.

High beam flasher

- ▶ Pull the combination switch briefly in direction of arrow ②.

Hazard warning flasher

The hazard warning flasher can be switched on at all times, even with the SmartKey removed from the starter switch or with the SmartKey with KEYLESS-GO* removed from the vehicle.

The hazard warning flasher switches on automatically when an airbag deploys.

The switch is located on the dashboard between the center air vents.



- ① Hazard warning flasher switch

Switching on the hazard warning flasher

- ▶ Press hazard warning flasher switch ①.

All turn signals are flashing.



With the hazard warning flasher activated and the combination switch set for either left or right turn, only the respective turn signals will operate when the ignition is switched on.

Switching off the hazard warning flasher

- ▶ Press hazard warning flasher switch ① again.



If the hazard warning flasher was switched on automatically because of an airbag that has deployed, press hazard warning flasher switch ① once to switch it off.

Interior lighting



- ① Left reading lamp
- ② Right reading lamp
- ③ Interior lighting on/off
- ④ Slide switch for interior lighting control

Automatic control

Activating

- ▶ Slide switch ④ to the left.

Interior lamps are switched on in darkness when you

- unlock the vehicle
- open a door
- remove the SmartKey from the starter switch
- open the trunk

In addition, the entry/exit lamps in the door trays will come on when you open a door.

The interior lamps are switched off after a preset time (▷ page 155).



If the door remains open, the interior lamps switch off automatically after approximately five minutes.

Controls in detail

Lighting

Deactivating

- ▶ Slide switch ④ to the right.
The interior lighting and the entry/exit lamps remain switched off in darkness, even when you
 - unlock the vehicle
 - open a door
 - remove the SmartKey from the starter switch
 - open the trunk

Manual control

Switching lamps on

- ▶ Press switch ③.
The interior lighting switches on.

Switching lamps off

- ▶ Press switch ③ again.
The interior lighting switches off.



The setting selected for the interior lighting is used for the trunk lighting as well.

If you leave the trunk lid open for an extended period of time, the trunk lighting will switch off automatically after approximately ten minutes.

Courtesy lighting

For better orientation in the dark, courtesy lamps will illuminate the interior of your vehicle as follows:

With parking lamps switched on:

- the door handles
- the driver and passenger footwells

With SmartKey in starter switch position 1:

- the door handles
- the center console



If you turn the SmartKey in the starter switch to position 0 and switch off the exterior headlamps, the door handle lamps will remain lit for approximately five minutes.

▼ Instrument cluster

For a full view illustration of the instrument cluster, see “Instrument cluster” (▷ page 24).

The instrument cluster is activated when you

- open a door
- switch on the ignition
- press the reset button (▷ page 24)
- switch on the exterior lamps

Opening a door will activate the instrument cluster only for about 30 seconds.

You can change the instrument cluster settings in the Instrument cluster submenu of the control system (▷ page 148).

Instrument cluster illumination

Use the reset button to adjust the illumination brightness for the instrument cluster and the switches on the center console.



The instrument cluster illumination is dimmed or brightened to suit ambient light conditions.

To brighten illumination

- ▶ Turn the reset button in the instrument cluster (▷ page 24) clockwise.

The instrument cluster illumination will brighten.

To dim illumination

- ▶ Turn the reset button in the instrument cluster (▷ page 24) counterclockwise.

The instrument cluster illumination will dim.

Coolant temperature gauge

Warning



- Driving when your engine is badly overheated can cause some fluids which may have leaked into the engine compartment to catch fire. You could be seriously burned.
- Steam from an overheated engine can cause serious burns and can occur just by opening the hood. Stay away from the engine if you see or hear steam coming from it.

Turn off the engine, get out of the vehicle and do not stand near the vehicle until the engine has cooled down.

Controls in detail

Instrument cluster





Excessive coolant temperature triggers the coolant temperature warning lamp (▷ page 352) and a warning in the multifunction display (▷ page 328).

During severe operating conditions, e.g. stop-and-go traffic, the coolant temperature may rise close to 248°F (120°C).

The engine should not be operated with the coolant temperature above 248°F (120°C). Doing so may cause serious engine damage which is not covered by the Mercedes-Benz Limited Warranty.

Trip odometer

- ▶ Make sure you are viewing the trip odometer display (▷ page 134).
- ▶ If it is not displayed, press the  or  button on the multifunction steering wheel repeatedly until the trip odometer appears.
- ▶ Press and hold reset button  (▷ page 24) until the trip odometer is reset.

Tachometer

The red marking on the tachometer denotes excessive engine speed.



Avoid driving at excessive engine speeds, as it may result in serious engine damage that is not covered by the Mercedes-Benz Limited Warranty.

To help protect the engine, the fuel supply is interrupted if the engine is operated within the red marking.

Outside temperature indicator

Warning!

The outside temperature indicator is not designed to serve as an ice-warning device and is therefore unsuitable for that purpose.

Indicated temperatures just above the freezing point do not guarantee that the road surface is free of ice. The road may still be icy, especially in wooded areas or on bridges.

The outside temperature is displayed in the right multifunction display (▷ page 24). For information on how to select the unit of the displayed temperature, i.e. degrees Celsius (°C) or degrees Fahrenheit (°F), see “Selecting temperature display mode” (▷ page 148).

The temperature sensor is located in the front bumper area. Due to its location, the sensor can be affected by road or engine heat during idling or slow driving. Therefore, the accuracy of the displayed temperature can only be verified by comparison to a thermometer placed next the sensor, not by comparison to external displays, e.g. bank signs, etc.

When moving the vehicle into colder ambient temperatures (e.g. when leaving your garage), you will notice a delay before the lower temperature is displayed.

A delay also occurs when ambient temperatures rise. This prevents inaccurate temperature indications caused by heat radiated from the engine during idling or slow driving.

Controls in detail

Control system

The control system is activated as soon as the SmartKey in the starter switch is turned to position **1** or as soon as the KEYLESS-GO start/stop button is in position **1**. The control system enables you to

- call up information about your vehicle
- change vehicle settings

For example, you can use the control system to find out when your vehicle is next due for service, to set the language for messages in the instrument cluster display, and much more.

Warning!



A driver's attention to the road and traffic conditions must always be his/her primary focus when driving.

For your safety and the safety of others, selecting features through the multifunction steering wheel should only be done by the driver when traffic and road conditions permit it to be done safely.

Bear in mind that at a speed of just 30 mph (approximately 50 km/h), your vehicle is covering a distance of 44 feet (approximately 14 m) every second.

The control system relays information to the multifunction display.

Multifunction display

The multifunction display consists of the display fields in the speedometer and the tachometer. In its default state, the left multifunction display shows the trip and main odometer, while the present outside temperature appears in the right multifunction display. This default setting is referred to as the standard display.

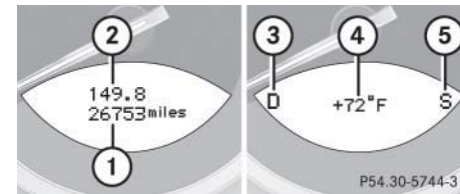

- ① Main odometer
- ② Trip odometer
- ③ Current gear selector lever position
- ④ Outside temperature
- ⑤ Automatic transmission program mode

Controls in detail

Control system

Multifunction steering wheel

The displays in the multifunction display and the settings in the control system are controlled by the buttons on the multifunction steering wheel.



- ① Left multifunction display in the speedometer
- ② Right multifunction display in the tachometer

Operating the control system

- ③ Selecting the submenu or setting the volume:
Press button

— down / to decrease

+ up / to increase

- ④ Telephone*:
Press button

☎ to take a call

☎ to end a call

- ⑤ Menu systems:
Press button

☰ for previous menu

☰ for next menu

- ⑥ Moving within a menu:
Press button

⬆ for next display

⬆ for previous display

Pressing any of the buttons on the multifunction steering wheel will alter what is shown in the multifunction display.





The information available in the multifunction display is arranged in menus, each containing a number of functions or sub-menus.

Controls in detail

Control system

The individual functions are then found within the relevant menu (radio or CD operations under **AUDIO**, for example). These functions serve to call up relevant information or to customize the settings for your vehicle.

It is helpful to think of the menus, and the functions within each menu, as being arranged in a circular pattern.

- If you press button  or  repeatedly, you will pass through each menu one after the other.
- If you press button  or  repeatedly, you will pass through each function display, one after the other, in the current menu.

In the **Settings** menu, instead of functions you will find a number of submenus for calling up and changing settings. For instructions on using these submenus, see “Settings menu” (▷ page 144).

The number of menus available in the system depends on which optional equipment is installed in your vehicle.

The menus are described on the following pages.

Menus

This is what you will see when you scroll through the menus.

The table below provides an overview of the individual menus.

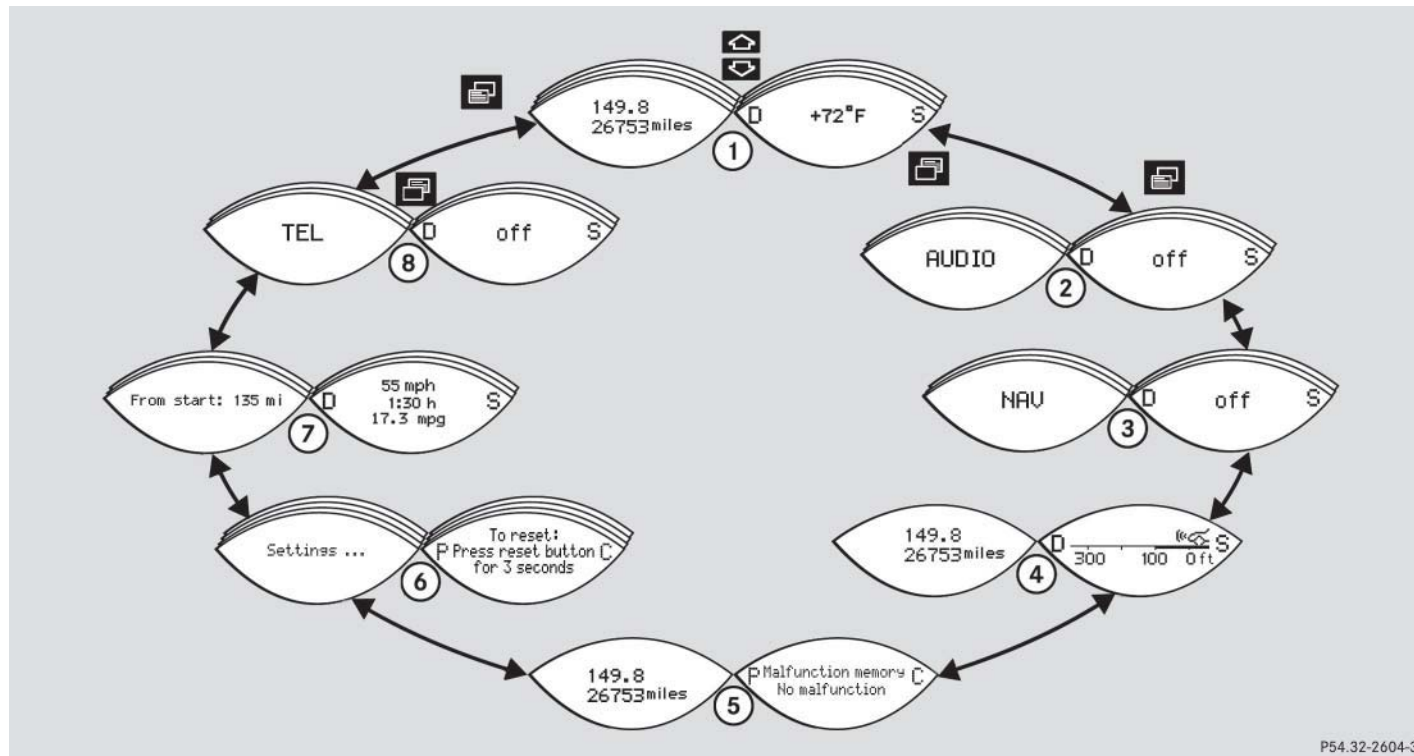

P54.32-2604-31

Controls in detail

Control system

Menus, submenus and functions



	Menu ①	Menu ②	Menu ③	Menu ④	Menu ⑤	Menu ⑥	Menu ⑦	Menu ⑧
	Standard display	AUDIO	NAV	Distronic*	Vehicle status message memory	Settings	Trip computer	Telephone
	(▷ page 139)	(▷ page 139)	(▷ page 142)	(▷ page 142)	(▷ page 143)	(▷ page 144)	(▷ page 159)	(▷ page 161)
Commands/submenus	Digital speedometer	Selecting radio station	Activating route guidance	Calling up settings	Calling up vehicle malfunction, warning and system status messages stored in memory	Resetting to factory settings	Fuel consumption statistics after start	Loading phone book
	Calling up maintenance service indicator	Selecting satellite radio station* (USA only)				Instrument cluster submenu	Fuel consumption statistics since the last reset	Searching for name in phone book
	Checking tire inflation pressure*	Operating CD player				Time submenu	Calling up range	
	Checking engine oil level					Lighting submenu Vehicle submenu Convenience submenu		



The headings used in the menus table are designed to facilitate navigation within the system and are not necessarily identical to those shown in the control system displays.

The first function displayed in each menu will automatically show you which part of the system you are in.

Standard display menu

You can select the functions in the standard display menu with button  or .

The following functions are available:

Function	Page
Calling up digital speedometer	139
Calling up maintenance service indicator	313
Checking tire inflation pressure	290
Checking engine oil level	272

Display digital speedometer

- ▶ Press button  once.

The current vehicle speed is shown in the right multifunction display.

Controls in detail

Control system

AUDIO menu

The functions in the AUDIO menu operate the audio equipment which you currently have turned on.

If no audio equipment is currently turned on, the message AUDIO off is shown in the right display.



The following functions are available:

Function	Page
Selecting radio station	140
Selecting satellite radio station* (USA only)	140
Operating CD player	141

Controls in detail



Control system

Select radio station

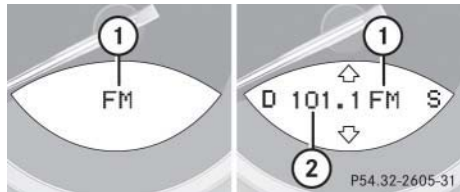
- ▶ Turn on the radio. Refer to the separate operating instructions.
- ▶ Press button  or  repeatedly until you see the currently tuned station in the right display.



- ① Waveband setting
- ② Station frequency

- ▶ Press button  or  repeatedly until the desired station is found.





You can only store new stations using the designated feature on the radio. Refer to the separate operating instructions.

You can also operate the radio in the usual manner.



Select satellite radio station* (USA only)

The satellite radio is treated as a radio application.

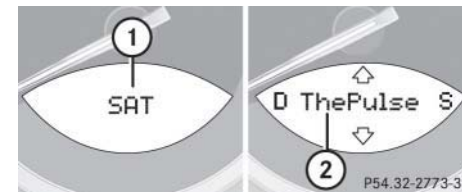
- ▶ Select satellite radio with the corresponding key on the COMAND control panel (SAT).
- ▶ Press button  or  repeatedly until you see the currently tuned station in the right display.



- ① SAT mode
- ② Channel name or number

- ▶ Press button  or  repeatedly until the desired channel is found.



Additional optional satellite radio equipment and a subscription to satellite radio service provider are required for satellite radio operation. Contact an authorized Mercedes-Benz Center for details and availability for your vehicle.

For more information, refer to separate COMAND operating instructions.

Operate the CD player

Selecting CD track

- ▶ Turn on COMAND and select CD. Refer to the separate COMAND operating instructions.
- ▶ Press button or repeatedly until the settings for the CD currently being played appear in the right multifunction display.

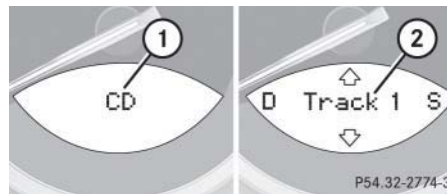

① Current CD (for CD changer)

② Current track

- ▶ Press button or repeatedly until the desired track is selected.

Controls in detail

Control system

Selecting MP3-CD track

- ▶ Turn on COMAND and select MP3-CD. Refer to the separate COMAND operating instructions.
- ▶ Press button or repeatedly until the settings for the MP3-CD currently being played appear in the right multifunction display.

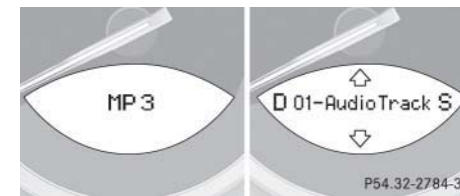



- ▶ Press button or repeatedly until the desired track is selected.

Controls in detail

Control system

NAV menu

The NAV menu contains the functions needed to operate your navigation system.

- ▶ Press button  or  repeatedly until you see the message NAV in the left multifunction display.

The message shown in the multifunction display depends on the status of the navigation system:

- When the navigation system is off, the message NAV off appears in the multifunction display.
- When the navigation system is on, the message HEADING appears in the left multifunction display and the destination in the right multifunction display.



Please refer to the COMAND manual for instructions on how to activate the route guidance system.

Distronic* menu

Use the Distronic menu to display the current settings for your Distronic system.

What information is shown in the left multifunction display depends on whether the Distronic system is active or inactive.

Please refer to the “Driving systems” section of this manual (▷ page 208) for instructions on how to activate Distronic.

- ▶ Press button  or  repeatedly until you see one of the following two pictures in the display.

Distronic deactivated

When Distronic is deactivated you will see the standard display in the left multifunction display.

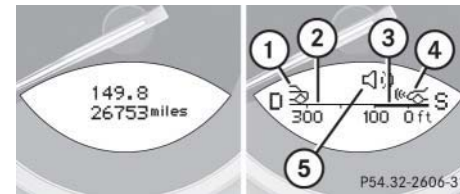

- ① Vehicle ahead, if detected
- ② Actual distance to vehicle ahead
- ③ Preset distance threshold to vehicle ahead
- ④ Your vehicle
- ⑤ Symbol for activated distance warning function

Distronic activated

When Distronic is activated the DTR symbol and the set speed are seen in the left display.

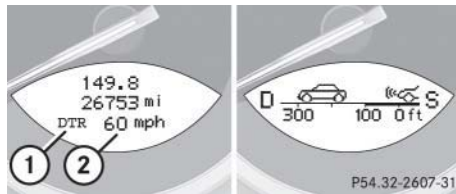

- ① Symbol for activated Distronic
- ② Set speed

Vehicle status message memory menu

Use the vehicle status message memory menu to scan malfunction and warning messages that may be stored in the system. Such messages appear in the multifunction display and are based on conditions or system status the vehicle's system has recorded.

Warning!



Malfunction and warning messages are only indicated for certain systems and are intentionally not very detailed. The malfunction and warning messages are simply a reminder with respect to the operation of certain systems and do not replace the owner's and/or driver's responsibility to maintain the vehicle's operating safety by having all required maintenance and safety checks performed on the vehicle and by bringing the vehicle to an authorized Mercedes-Benz Center to address the malfunction and warning messages (▷ page 335).

Controls in detail

Control system

- ▶ Press button or repeatedly until the vehicle status message memory appears in the multifunction display.

No vehicle status messages

If no conditions have been recorded, the message in the right display is: Malfunction memory, no malfunctions.

Vehicle status messages have been recorded

If conditions have occurred causing status messages to be recorded, the number of messages appears in the right multifunction display:



- ① Number of recorded status messages

Controls in detail

Control system

- ▶ Press button  or .

The stored messages will now be displayed in the order in which they have occurred. For malfunction and warning messages, see “Vehicle status messages in the multifunction display” (▷ page 335).



After you have scrolled through all recorded status messages, the first recorded message appears again.

Should the vehicle’s system record any conditions while driving, the number of messages will reappear in the multifunction display

- when the SmartKey in the starter switch is turned to position **0** or removed from the starter switch
- or
- when you turn off the engine by pressing the KEYLESS-GO* start/stop button on the gear selector lever once and



open the driver’s door (this puts the starter switch in position **0**, same as with the SmartKey removed from the starter switch)



The vehicle status message memory will be cleared when you then turn the SmartKey in the starter switch to position **1** or **2**, or when you press the KEYLESS-GO* start/stop button once or twice without depressing the brake pedal. You will then only see high priority messages in the multifunction display (▷ page 335).

Settings menu

In the *Settings* menu there are two functions:

- The function *Reset*, with which you can reset all the settings to those set at the factory.
 - A collection of submenus with which you can make individual settings for your vehicle.
- ▶ Press button  or  repeatedly until the *Settings...* menu appears in the left display.

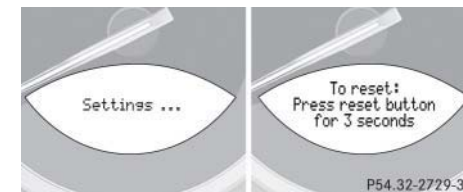

The following settings and submenus are available:

Function	Page
Resetting all settings	145
Submenus in the Settings menu	145
Resetting the functions of a submenu	146
Instrument cluster submenu	148
Time submenu	
Lighting submenu	152
Vehicle submenu	156
Convenience submenu	157

Resetting all settings

You can reset all the functions of all submenus to the factory settings.

- ▶ Press the reset button in the instrument cluster for approximately three seconds.

In the right display you will see the request to press the reset button again to confirm.

- ▶ Press the reset button again.

The functions of all the submenus will reset to factory settings.



The settings you have changed will not be reset unless you confirm the action by pressing the reset button a second time.

Controls in detail

Control system

Submenus in the Settings menu

- ▶ Press button or .

In the right display you see the collection of submenus.

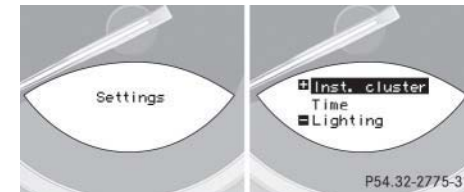

- ▶ Press button .

The selection marker moves to the next submenu.

The submenus are arranged by hierarchy. Scroll down with the button, scroll up with the button.

Move within the submenus with the or button to the individual functions.

The settings themselves are made with button or .

Controls in detail

Control system

Resetting the functions of a submenu

For each submenu you can reset all the functions to the factory settings.

- ▶ Move to a function in the submenu.
- ▶ Press the reset button in the instrument cluster for approximately three seconds.

In the right display you will see the request to press the reset button again to confirm.

- ▶ Press the reset button again.

All functions of the submenu will reset to factory settings.

The table below shows what settings can be changed within the various menus. Detailed instructions on making individual settings can be found on the following pages.

Instrument cluster	Time	Lighting	Vehicle	Convenience
Selecting temperature display mode	Synchronizing time with head unit	Setting daytime running lamp mode (USA only)	Setting station selection mode (radio)	Activating easy-entry/exit feature
Selecting speedometer display mode	Setting the time (hours)	Setting locator lighting	Setting automatic locking	Setting key-dependency
Selecting language	Setting the time (minutes)	Setting night security illumination	Tire inflation pressure display	Setting parking position for exterior rear view mirror
	Selecting time display mode	Setting interior lighting delayed switch-off		

Controls in detail

Control system

Instrument cluster submenu

Access the Inst. cluster subenu via the Settings menu. Use the Inst. cluster submenu to change the instrument cluster display settings. The following functions are available:

Function	Page
Selecting temperature display mode	148
Selecting speedometer display mode	148
Selecting language	149

Selecting temperature display mode

- ▶ Move the selection marker with button **+** or **-** to the Inst. cluster submenu.
- ▶ Press button **↶** or **↷** repeatedly until you see this message in the left display: Temp. indicator.

The selection marker is on the current setting.

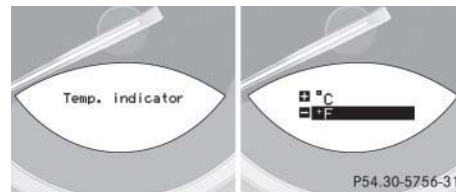

- ▶ Press **+** or **-** to set temperature unit to degrees Celsius (°C) or degrees Fahrenheit (°F).

Selecting speedometer display mode

- ▶ Move the selection marker with button **+** or **-** to the Inst. cluster submenu.
- ▶ Press button **↶** or **↷** repeatedly until you see this message in the left display: Digital speedometer.

The selection marker is on the current setting.

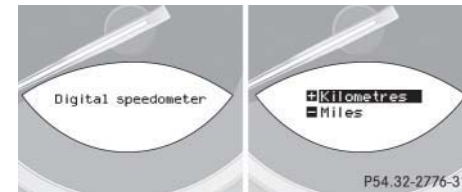

- ▶ Press **+** or **-** to set the speedometer units to Kilometres or Miles.

Selecting language

- ▶ Move the selection marker with button **+** or **-** to the Inst. cluster submenu.
- ▶ Press button **↶** or **↷** repeatedly until the message **Text** appears in the multifunction display.

The selection marker is on the current setting.

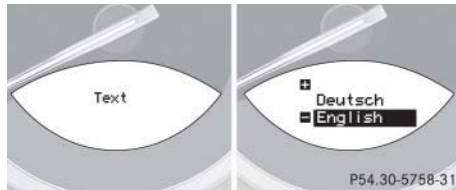

- ▶ Press **+** or **-** to select the language to be used for the multifunction display messages.

Available languages:

- German
- English
- Italian
- French
- Spanish

Time submenu

Access the **Time** submenu via the **Settings** menu. Use the **Time** submenu to change the time and date settings. The following functions are available:

Function	Page
Synchronizing time with head unit	149
Setting the time (hours)	150
Setting the time (minutes)	151
Selecting time display mode	151

Synchronizing time with head unit

- ▶ Move the selection marker with the **+** or **-** button to the **Time** submenu.
- ▶ Press button **↶** or **↷** repeatedly until the message **Time sync. with head unit** appears in the multifunction display.

The selection marker is on the current setting.

Controls in detail

Control system

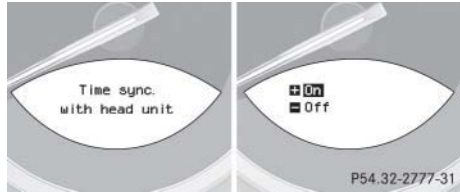

- ▶ Press **+** or **-** enable or disable this feature.

When you set this feature to *On*, the time displayed in the multifunction display is automatically synchronized with the time of the COMAND system



For information on setting the time, refer to the separate COMAND operating instructions.

Setting the time (hours)

This function is only available if the function *Time sync. with head unit* (▷ page 149) has been set to *Off*. The time is then not set automatically by the COMAND and must be set manually if required.

- ▶ Move the selection marker with the **+** or **-** button to the *Time* submenu.
- ▶ Press button **▲** or **▼** repeatedly until the message *Set time Hours* appears in the multifunction display.

The selection marker is on the hour setting.

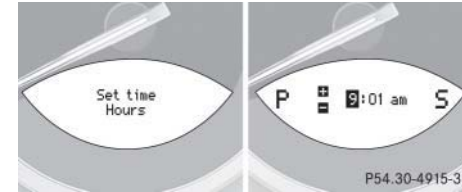

- ▶ Press button **+** or **-** to set the hour.
- ▶ Press the reset button in the instrument cluster (▷ page 25) to confirm the setting.

Setting the time (minutes)

This function is only available if the function Time sync. with head unit (▷ page 149) has been set to Off. The time is then not set automatically by the COMAND and must be set manually if required.

- ▶ Move the selection marker with the **+** or **-** button to the Time submenu.
- ▶ Press button **↶** or **↷** repeatedly until the message Set time Minutes appears in the multifunction display.

The selection marker is on the minute setting.

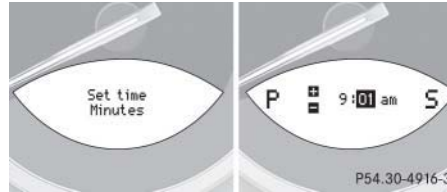

- ▶ Press button **+** or **-** to set the hour.
- ▶ Press the reset button in the instrument cluster (▷ page 25) to confirm the setting.

Selecting time display mode

- ▶ Move the selection marker with the **+** or **-** button to the Inst. cluster submenu.
- ▶ Press button **↶** or **↷** repeatedly until the message Clock appears in the multifunction display.

The selection marker is on the current setting.

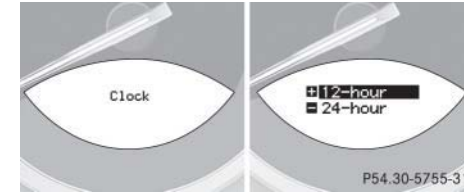

- ▶ Press **+** or **-** to set the 12-hour or 24-hour time display mode.



For information on setting the time, refer to the separate COMAND operating instructions.

Controls in detail

Control system

Lighting submenu

Access the Lighting submenu via the Settings menu. Use the Lighting submenu to change the lamp and lighting settings on your vehicle. The following functions are available:

Function	Page
Setting daytime running lamp mode (USA only)	152
Setting locator lighting	153
Setting night security illumination	154
Setting interior lighting delayed switch-off	155

Setting daytime running lamp mode (USA only)



This function is not available in countries where the daytime running lamp mode is mandatory and therefore in a constant mode.

- ▶ Move the selection marker with button **+** or **-** to the Lighting submenu.
- ▶ Press button **▲** or **▼** repeatedly until you see Light circuit Headlamp mode in the multifunction display.

The selection marker is on the current setting.

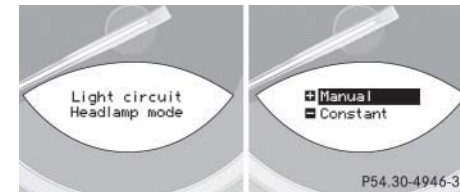

- ▶ Press button **+** or **-** to select manual operation (Manual) or daytime running lamp mode (Constant).

With daytime running lamp mode activated and the exterior lamp switch at position **0** or **AUTO** the low beam headlamps are switched on when the engine is running.

In low ambient light conditions the following lamps will switch on additionally:

- Parking lamps
- Tail lamps
- License plate lamps
- Side marker lamps



For safety reasons, resetting the Lighting submenu to factory settings while driving (▷ page 146) will not deactivate the daytime running lamp mode.

The message following message appears in the multifunction display: Cannot be fully reset to factory settings when driving.

Setting locator lighting

With the locator lighting feature activated and the exterior lamp switch in position **AUTO**, the following lamps will switch on when the vehicle is unlocked with the SmartKey during darkness:

- Parking lamps
- Tail lamps
- License plate lamps
- Front fog lamps

The locator lighting switches off when the driver's door is opened.

If you do not open a door after unlocking the vehicle with the SmartKey, the lamps will switch off automatically after approximately 40 seconds.

Controls in detail

Control system

- ▶ Move the selection marker with button **+** or **-** to the Lighting submenu
- ▶ Press button **↶** or **↷** repeatedly until you see Locator lighting in the multifunction display.

The selection marker is on the current setting.

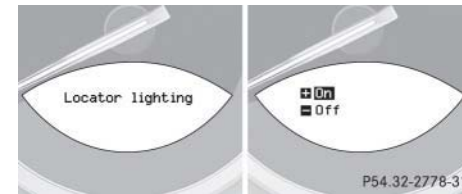

- ▶ Press button **+** or **-** to switch the locator lighting feature to On.
- ▶ Turn the exterior lamp switch to position **AUTO** when exiting the vehicle.

The locator lighting feature is activated.

Controls in detail

Control system

Setting night security illumination (Exterior lamps delayed switch-off)

Use this function to set whether and for how long you would like the exterior lamps to illuminate during darkness after exiting the vehicle and the doors closed. With the delayed switch-off feature activated and the exterior lamp switch in position **AUTO** before the engine is turned off, the following lamps will switch on after you have removed the SmartKey from the starter switch:

- Parking lamps
- Tail lamps
- License plate lamps
- Side marker lamps
- Front fog lamps

If you do not open a door after removing the SmartKey from the starter switch, the lamps will switch off automatically after approximately 60 seconds.



You can reactivate this function within ten minutes by opening a door.

- ▶ Move the selection marker with button **+** or **-** to the Lighting sub-menu.
- ▶ Press button **▲** or **▼** repeatedly until you see **Headlamps delayed switch-off** in the multifunction display.

The selection marker is on the current setting.

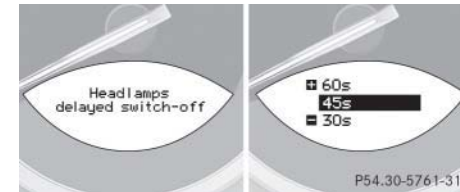

- ▶ Press button **+** or **-** to select the desired lamp-on period.
 - 0 s, the delayed switch-off feature is deactivated.
 - 15 s, 30 s, 45 s or 60 s, select the desired lamp-on period.
- ▶ Turn the exterior lamp switch to position **AUTO** before turning off the engine (> page 48).

You can temporarily deactivate the delayed switch-off feature:

- ▶ Before exiting the vehicle turn the SmartKey in the starter switch to position **0**.
- ▶ Then turn it to position **2** and back to **0**.

The delayed switch-off feature is deactivated. It will reactivate as soon as you reinsert the SmartKey in the starter switch.

Interior lighting delayed switch-off

Use this function to set whether and for how long you would like the interior lighting to remain lit during darkness after you have removed the SmartKey from the starter switch.

- ▶ Move the selection marker with button **+** or **-** to the **Lighting** sub-menu.
- ▶ Press button **▲** or **▼** repeatedly until you see **Int. lighting delayed switch-off** in the multifunction display.

The selection marker is on the current setting.

Controls in detail

Control system

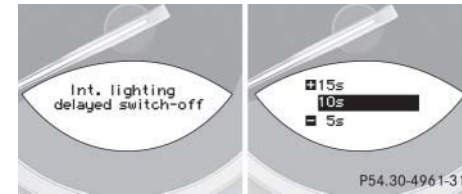

- ▶ Press **+** or **-** to select the desired lamp-on time period.

You can select:

- 0 s, the interior lighting delayed switch-off feature is deactivated.
- 5 s, 10 s, 15 s or 20 s, the interior lighting delayed switch-off feature is activated with the desired lamp-on period.

Controls in detail

Control system

Vehicle submenu

Access the Vehicle submenu via the Settings menu. Use the Vehicle submenu to make general vehicle settings. The following functions are available:

Function	Page
Setting automatic locking	156
Tire inflation pressure display	156

Setting automatic locking

Use this function to activate or deactivate the automatic central locking. With the automatic central locking system activated, the vehicle is centrally locked at vehicle speeds of approximately 9 mph (15 km/h).

- ▶ Move the selection marker with the **+** or **-** button to the Vehicle submenu.

- ▶ Press button **▲** or **▼** repeatedly until you see this message in the left display: Automatic door lock.

The selection marker is on the current setting.

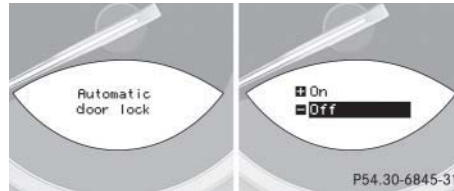

- ▶ Press **+** or **-** to switch Automatic door lock On or Off.

Tire inflation pressure display

Use this function to set the unit for the tire inflation pressure display.

- ▶ Move the selection marker with the **+** or **-** button to the Vehicle submenu.
- ▶ Press button **▲** or **▼** repeatedly until you see this message in the left display: Tire pres. display.

The selection marker is on the current setting.

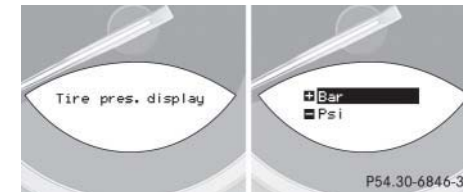

- ▶ Press **+** or **-** to select the desired tire inflation pressure unit.

Convenience submenu

Access the Convenience submenu via the Settings menu. Use the Convenience submenu to change the settings for a number of convenience features. The following functions are available:

Function	Page
Activating easy-entry/exit feature	157
Setting key-dependency	158
Setting parking position for exterior rear view mirror	158

Activating easy-entry/exit feature

Use this function to activate and deactivate the easy-entry/exit feature (▷ page 113).

Warning!



You must make sure no one can become trapped or injured by the moving steering wheel and driver's seat when the easy-entry/exit feature is activated.



To cancel seat/steering wheel movement, do one of the following:

- Press seat adjustment switch (▷ page 40).
- Move steering column stalk (▷ page 42).
- Press the memory button (▷ page 120).

Do not leave children unattended in the vehicle, or with access to an unlocked vehicle. Children could open the driver's door and unintentionally activate the easy-entry/exit feature, which could result in an accident and/or serious personal injury.

Controls in detail

Control system

- ▶ Move the selection marker with the **+** or **-** button to the Convenience submenu.
- ▶ Press button  or  repeatedly until you see this message in the multi-function display: Activate Easy-entry feature.

The selection marker is on the current setting.

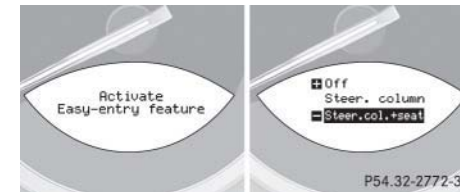

- ▶ Press **+** or **-** to change the easy-entry/exit setting.

Controls in detail

Control system

The following settings are available for the easy-entry/exit feature:

Off	The easy-entry/exit feature is deactivated
Steer. column	Only the steering column is moved
Steer.col. +seat	Both, the steering column and the seat are moved

Setting key-dependency

Use this function to set whether the memory settings for the seats, the steering wheel and the exterior rear view mirrors should be stored separately for each SmartKey (▷ page 120).

- ▶ Move the selection marker with button **+** or **-** to the Convenience sub-menu.
- ▶ Press button **↶** or **↷** repeatedly until you see this message in the left display: Key-dependent.

The selection marker is on the current setting.

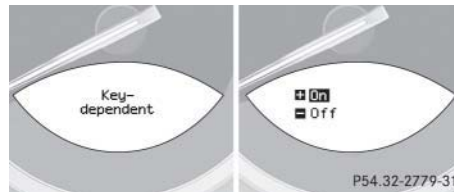

- ▶ Press **+** or **-** to set key-dependency to On or Off.

Setting parking position for exterior rear view mirror

Use the Mirror setting when parking function to select whether the passenger-side exterior rear view mirror should be turned downward during parking maneuvers when reverse gear **R** is engaged. For additional information, see “Activating exterior rear view mirror parking position” (▷ page 179).

- ▶ Move the selection marker with button **+** or **-** to the Convenience sub-menu.
- ▶ Press button **↶** or **↷** repeatedly until you see this message in the left display: Mirror setting when parking.

The selection marker is on the current setting.



- ▶ Press **+** or **-** to switch function On or Off.

Trip computer menu

Use the trip computer menu to call up statistical data on your vehicle. The following information is available:

Function	Page
Fuel consumption statistics after start	159
Fuel consumption statistics since last reset	160
Calling up range (distance to empty)	161



The last function called up will reappear the next time you enter the trip computer menu.

Controls in detail

Control system

Fuel consumption statistics after start

- ▶ Press button or repeatedly until you see the first function of the Trip computer menu.
- ▶ Press button or repeatedly until you see this message in the left display: From start.

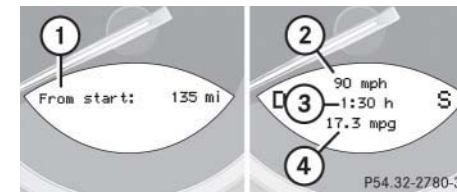

- ① Distance driven since start
- ② Average speed since start
- ③ Time elapsed since start
- ④ Average fuel consumption since start

Controls in detail

Control system



All statistics stored since the last engine start will be reset approximately four hours after the SmartKey in the starter switch is turned to position **0** or removed from the starter switch.

Resetting will not occur if you turn the SmartKey back to position **1** or **2** within this time period.

Fuel consumption since last reset

- ▶ Press button or repeatedly until you see the first function of the Trip computer menu.
- ▶ Press button or repeatedly until you see this message in the left display: From reset.

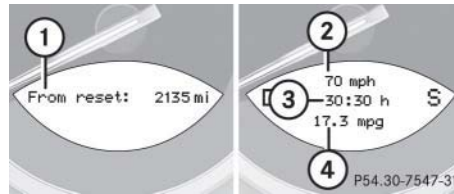





- ① Distance driven since last reset
- ② Average speed since last reset
- ③ Time elapsed since last reset
- ④ Average fuel consumption since last reset

Resetting fuel consumption statistics

- ▶ Press button or repeatedly until you see the first function of the Trip computer menu.
- ▶ Press button or repeatedly until you see the reading that you want to reset in the left display.
- ▶ Press and hold the reset button in the instrument cluster (> page 25) until the value is reset to 0.

Call up range (distance to empty)

- ▶ Press button  or  repeatedly until you see the first function of the Trip computer menu.
- ▶ Press button  or  repeatedly until you see this message in the left display: Range.

In the right display you will see the calculated range based on the current fuel tank level.

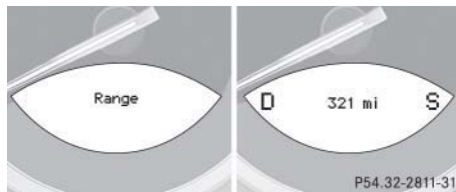

TEL menu*

Warning!



A driver's attention to the road must always be his/her primary focus when driving. For your safety and the safety of others, we recommend that you pull over to a safe location and stop before placing or taking a telephone call. If you choose to use the telephone while driving, please use the hands-free device and only use the telephone when weather, road, and traffic conditions permit.

Some jurisdictions prohibit the driver from using a cellular telephone while driving a vehicle.



Bear in mind that at a speed of just 30 mph (approximately 50 km/h), your vehicle is covering a distance of 44 feet (approximately 14 m) every second.

Controls in detail

Control system

Never operate radio transmitters equipped with a built-in or attached antenna (i.e. without being connected to an external antenna) from inside the vehicle while the engine is running. Doing so could lead to a malfunction of the vehicle's electronic system, possibly resulting in an accident and/or personal injury.

You can use the functions in the TEL menu to operate your telephone, provided it is connected to a hands-free system and switched on.

- ▶ Switch on the telephone and COMAND.
- ▶ Press button  or  on the steering wheel repeatedly until you see the TEL menu in the left display.

Controls in detail

Control system

Which messages will appear in the right multifunction display depends on whether your telephone is switched on or off:

- If the telephone is off, the message in the multifunction display is: TEL Off.
- If the telephone is on:

The telephone will then search for a network. During this time the right display is empty.

As soon as the telephone has found a network, READY is indicated in the right display.

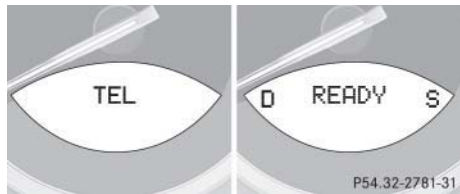

- This standby message indicates that your telephone is ready for use and you can operate it using the control system.

Rejecting a call

If you do not wish to receive the call, you can choose to reject it.

- ▶ Press button .

You have rejected the call. The caller receives a busy signal.

Answering a call

When your telephone is ready to receive calls, you can answer a call at any time. In the right display you will then see the message:

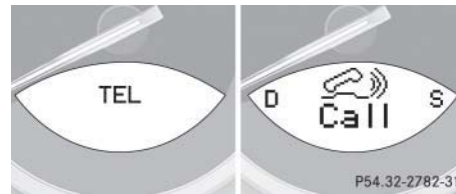

- ▶ Press button .

You have answered the call. In the right display you see the length of the call.



Ending a call

- ▶ Press button .

You have ended the call. In the right display you will again see the standby message.

Dialing a number from the phone book

If your telephone is ready to receive calls, you may select and dial a number from the phone book at any time.

- ▶ Press button  or  repeatedly until you see the TEL menu in the left display.

In the right display you will see the standby message.



Controls in detail

Control system

- ▶ Press button  or .



The control system reads the phone book which is stored in the telephone. This may take up to 30 seconds. In the right display you will see the message `Please wait!`.

When the message `Please wait!` disappears, the phone book has been loaded.

- ▶ Press button  or  repeatedly until the desired name appears in the right display.

The stored names are displayed in ascending or descending alphabetical order.



If you press and hold  or  for longer than one second, the system scrolls rapidly through the list of names until you release the button again.

Cancel the quick search mode by pressing .

- ▶ Press button .

The system dials the selected phone number.

- If the connection is successful, the name of the party you called and the duration of the call will appear in the display.

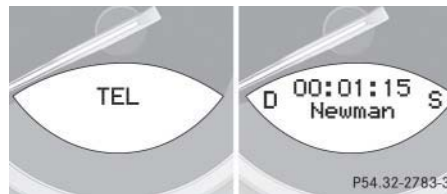

- If no connection is made, the control system stores the dialed number in the redial memory.

Redialing



The control system stores the most recently dialed phone numbers. This eliminates the need to search through your entire phone book.

- ▶ Press button  or  repeatedly until you see the `TEL` menu in the left display.

In the right display you will see the standby message.

- ▶ Press button .

In the right display you see the first number in the redial memory.

- ▶ Press button  or  repeatedly until the desired name appears in the right display.

- ▶ Press button .

The control system dials the selected phone number.

Controls in detail

Automatic transmission

For more information on driving with an automatic transmission see “Automatic transmission” (▷ page 48).

Your vehicle’s transmission adapts its gear shifting process to your individual driving style by continually adjusting the shift points up or down. These shift point adjustments are performed based on current operating and driving conditions.

If the operating conditions change, the automatic transmission reacts by adjusting its shift program.



During the brief warm-up, transmission upshifting is delayed. This allows the catalytic converter to heat up more quickly to operating temperature.

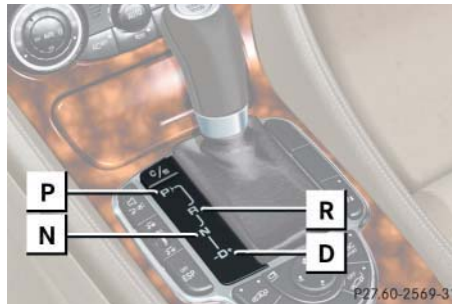

Gearshift pattern for automatic transmission

The automatic transmission selects individual gears automatically, depending on:

- the gear selector lever position **D** (▷ page 168) with gear ranges (▷ page 167)
- the selected program mode:
(C/S) (▷ page 170)
or
(MANUAL/C/S) (SL 55 AMG and SL 65 AMG only) (▷ page 175)
- the position of the accelerator pedal (▷ page 171)
- the vehicle speed

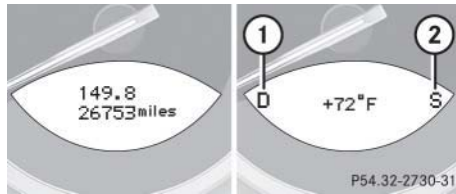

- ① Current gear range/gear selector lever position
- ② Current program mode

The current gear range/gear selector lever position and program mode (C/S) or (M/C/S) appear in the right multifunction display.

Warning!



It is dangerous to shift the gear selector lever out of **P** or **N** if the engine speed is higher than idle speed. If your foot is not firmly on the brake pedal, the vehicle could accelerate quickly forward or reverse. You could lose control of the vehicle and hit someone or something. Only shift into gear when the engine is idling normally and when your right foot is firmly on the brake pedal.

Controls in detail

Automatic transmission



Allow engine to warm up under low load use. Do not place full load on the engine until the operating temperature has been reached.

Shift into reverse gear **R** or parking position **P** only when the vehicle is stopped.

Avoid spinning of a drive wheel for an extended period when driving off on slippery road surfaces. This may cause serious damage to the drivetrain which is not covered by the Mercedes-Benz Limited Warranty.

When the gear selector lever is in position **D**, you can influence transmission shifting by:

- limiting the gear range
- changing gears manually

Controls in detail

Automatic transmission

One-touch gearshifting

Even with an automatic transmission you can change the gears manually when the gear selector lever is in position **D**.

Downshifting

- ▶ Briefly press the gear selector lever to the left in the **D-** direction.

The transmission will shift from the current gear to the next lower gear as permitted by the shift program. This action simultaneously limits the gear range of the transmission (▷ page 167).

Warning!



On slippery road surfaces, never downshift in order to obtain braking action. This could result in drive wheel slip and reduced vehicle control. Your vehicle's ABS will not prevent this type of loss of control.



To avoid overrevving the engine when the gear selector lever is moved to the **D-** direction, the transmission will not shift to a lower gear if the engine's max. speed would be exceeded.

Upshifting

- ▶ Briefly press the gear selector lever to the right in the **D+** direction.

The transmission will shift from the current gear to the next higher gear as permitted by the shift program. This action simultaneously extends the gear range of the transmission.

Canceling gear range limit

- ▶ Press and hold the gear selector lever in the **D+** direction until **D** reappears in the right multifunction display.

The transmission will shift from the current gear range directly to gear range **D**.

Shifting into optimal gear range

- ▶ Press and hold the gear selector lever in the **D-** direction.

The transmission will automatically select the gear range suited for optimal acceleration and deceleration. This will involve shifting down one or more gears.

Gear ranges

With the gear selector lever in position **D**, you can limit the transmission's gear range by pressing the gear selector lever to the left (**D-**), and reverse the gear range limit by pressing the gear selector lever to the right (**D+**).

The selected gear range appears in the right multifunction display (> page 165). If you press on the accelerator when the engine has reached its rpm limit, the transmission will upshift beyond any gear range limit selected.

	Effect
6	The transmission shifts through sixth gear only (applies to vehicles with 7-speed automatic transmission only).
5	The transmission shifts through fifth gear only (applies to vehicles with 7-speed automatic transmission only).
4	The transmission shifts through fourth gear only.
3	The transmission shifts through third gear only. With this selection you can use the braking effect of the engine.

Controls in detail

Automatic transmission

	Effect
2	The transmission shifts through second gear only. Allows the use of engine's braking power when driving: <ul style="list-style-type: none">• on steep downgrades• in mountainous regions• under extreme operating conditions
1	The transmission operates in first gear only. For maximum use of engine's braking effect on very steep or lengthy downgrades.

Controls in detail

Automatic transmission

Gear selector lever position

	Effect
P	Park position Gear selector lever position when the vehicle is parked. Place gear selector lever in position P only when vehicle is stopped. The park position is not intended to serve as a brake when the vehicle is parked. Rather, the driver should always set the parking brake in addition to placing the gear selector lever in position P to secure the vehicle.

	Effect
	The SmartKey can only be removed from the starter switch with the gear selector lever in position P . With the SmartKey removed, the gear selector lever is locked in position P .
R	Reverse gear Place gear selector lever in position R only when vehicle is stopped.

	Effect
N	Neutral No power is transmitted from the engine to the drive axle. When the brakes are released, the vehicle can be moved freely (pushed or towed). To avoid damage to the transmission, never engage N while driving. If the ESP is deactivated or malfunctioning: Move gear selector lever to N only if the vehicle is in danger of skidding, e.g. on icy roads.
D	Drive The transmission shifts automatically. All forward gears are available.



Coasting the vehicle, or driving for any other reason with gear selector lever in **N** can result in transmission damage that is not covered by the Mercedes-Benz Limited Warranty.

Warning!



Getting out of your vehicle with the gear selector lever not fully engaged in position **P** is dangerous. Also, position **P** alone is not intended to or capable of preventing your vehicle from moving, possibly hitting people or objects.

Always set the parking brake in addition to shifting to position **P** (> page 57).

When parked on an incline, turn the front wheels towards the road curb.

Do not park this vehicle in areas where combustible materials such as grass, hay or leaves can come into contact with the hot exhaust system, as these materials could be ignited and cause a vehicle fire.

Controls in detail

Automatic transmission

Warning!



When leaving the vehicle, always remove the SmartKey or SmartKey with KEYLESS-GO* from the starter switch, take it with you, and lock the vehicle. Do not leave children unattended in the vehicle, or with access to an unlocked vehicle. Children could move the gear selector lever from position **P**, which could result in an accident and/or serious personal injury.

Controls in detail

Automatic transmission

Automatic shift program

The program mode selector switch is located on the lower part of the center console.



① Program mode selector switch

C Comfort For comfort driving

S Sport For standard driving

The current gear selector lever position and the selected program mode (C/S) are indicated in the right multifunction display (> page 165).



Never change the program mode when the gear selector lever is out of position **P**. This could result in a change of driving characteristics for which you may not be prepared.



The last selected program mode (**C** or **S**) is switched on when the engine is restarted.

- ▶ Press program mode selector switch ① repeatedly until the letter of the desired program mode appears in the right multifunction display.

Select **C** for comfort driving:

- The vehicle starts out in second gear (both forward and reverse) for gentler starts. This does not apply if full throttle is applied or gear range **1** is selected.
- Traction and driving stability are improved on icy roads.
- Upshifts occur earlier even when you give more gas. The engine then operates at lower rpms and the wheels are less likely to spin.

Driving tips

Accelerator position

Your driving style influences the transmission's shifting behavior:

Less throttle Earlier upshifting

More throttle Later upshifting

Kickdown

Use kickdown when you want maximum acceleration.

- ▶ Press the accelerator past the point of resistance.

The transmission shifts into a lower gear.

- ▶ Ease on the accelerator when you have reached the desired speed.

The transmission shifts up again.

Stopping

When you stop briefly, e.g. at traffic lights:

- ▶ Leave the transmission in gear.
- ▶ Hold the vehicle with the brake.

When you stop longer with the engine idling or on an uphill gradient:

- ▶ Move the gear selector lever to position **P**.
- ▶ Set the parking brake.

Maneuvering

When you maneuver in tight areas, e.g. when pulling into a parking space:

- ▶ Control the vehicle speed by gradually releasing the brakes.
- ▶ Accelerate gently.
- ▶ Never abruptly step on the accelerator.

Working on the vehicle

Warning!



When working on the vehicle, set the parking brake and move gear selector lever to position **P**. Otherwise the vehicle could roll away.

Controls in detail

Automatic transmission

Steering wheel gearshift control (Speedshift)

Steering wheel gearshift control is available on vehicles with Sport Package*, on SL 55 AMG, and on SL 65 AMG only.

When driving in the automatic program modes **C** or **S**, or in the **MANUAL** program mode (SL 55 AMG and SL 65 AMG only), you can change the gears manually on the steering wheel or by using the gear selector lever (> page 166).



To avoid overrevving the engine when downshifting with steering wheel gearshift buttons, the transmission will not shift to a lower gear if the engine's max. speed would be exceeded.



Allow engine to warm up under low load use. Do not place full load on the engine until the operating temperature has been reached.

Shift into reverse gear **R** or parking position **P** only when the vehicle is stopped.

Avoid spinning of a drive wheel for an extended period when driving off on slippery road surfaces. This may cause serious damage to the drivetrain which is not covered by the Mercedes-Benz Limited Warranty.

Steering wheel gearshift control SL 500 with Sport Package* and SL 600 with Sport Package*

The steering wheel gearshift buttons are located to the left and right of the steering wheel.

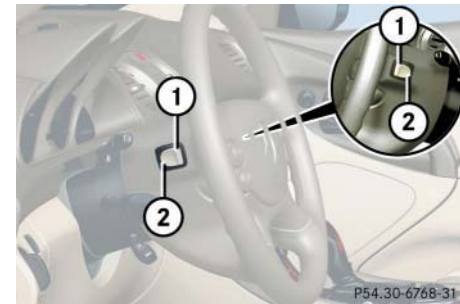

- ① Button, outside: downshift
- ② Button, inside: upshift



You cannot shift with the steering wheel gearshift buttons when the gear selector lever is in position **P**, **N** or **R**.

The last selected program mode (**C** or **S**) is switched on when the engine is restarted.

Downshifting

Warning!



On slippery road surfaces, never downshift in order to obtain braking action. This could result in drive wheel slip and reduced vehicle control. Your vehicle's ABS will not prevent this type of loss of control.

- ▶ Press the inside ① of one of the buttons on the steering wheel.

The transmission will shift to the next lower gear as permitted by the shift program. This action simultaneously limits the gear range of the transmission (▷ page 167).

Controls in detail

Automatic transmission

Upshifting

- ▶ Press the outside of one of the buttons ② on the steering wheel.

The transmission will shift to the next higher gear as permitted by the shift program. This action simultaneously extends the gear range of the transmission.

Controls in detail

Automatic transmission

Steering wheel gearshift control SL 55 AMG and SL 65 AMG

The steering wheel gearshift buttons are located to the left and right of the steering wheel.

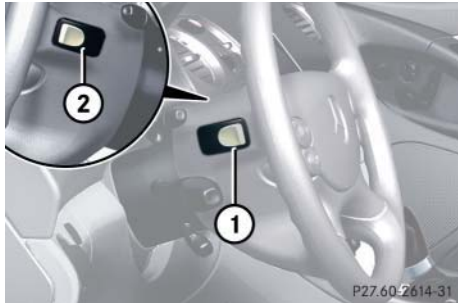

- ① Left button: downshift
- ② Right button: upshift



You cannot shift with the steering wheel gearshift buttons when the gear selector lever is in position **P**, **N** or **R**.

The **MANUAL** program mode will not be stored. When the engine is turned off with the **MANUAL** program mode selected, the transmission will go to the automatic program mode (**C** or **S**) when the engine is restarted.

The last selected program mode (**C** or **S**) is switched on when the engine is restarted in the automatic program mode.

Downshifting

Warning!



On slippery road surfaces, never downshift in order to obtain braking action. This could result in drive wheel slip and reduced vehicle control. Your vehicle's ABS will not prevent this type of loss of control.

- ▶ Press button ① on the left side of the steering wheel.

The transmission will shift to the next lower gear as permitted by the shift program. This action simultaneously limits the gear range of the transmission (▷ page 167) when you are driving in the automatic program mode (**C** or **S**).

Upshifting

- ▶ Press button ② on the right side of the steering wheel.

The transmission will shift to the next higher gear as permitted by the shift program. This action simultaneously extends the gear range of the transmission when you are driving in the automatic program mode (**C** or **S**).

Manual shift program SL 55 AMG and SL 65 AMG

In the **MANUAL** program mode you can change the gears manually on the steering wheel (▷ page 174) or by using the gear selector lever (▷ page 166).



Allow engine to warm up under low load use. Do not place full load on the engine until the operating temperature has been reached.

Shift into reverse gear **R** or parking position **P** only when the vehicle is stopped.

Avoid spinning of a drive wheel for an extended period when driving off on slippery road surfaces. This may cause serious damage to the drivetrain which is not covered by the Mercedes-Benz Limited Warranty.

Controls in detail

Automatic transmission

The program mode selector switch is located on the lower part of the center console.



① Program mode selector switch

MANUAL	For manual gear shifting
C Comfort	For comfort driving
S Sport	For standard driving

The current gear selector lever position and the selected program mode (M/C/S) are indicated in the right multifunction display (▷ page 165).

Controls in detail

Automatic transmission

Activating manual shift program

- ▶ Press program mode selector switch ① repeatedly until the M for **MANUAL** program mode appears in the right multifunction display.

The transmission switches to the **MANUAL** program mode. Automatic shifting is switched off. The gear range is not limited.

You can change the gears manually when the gear selector lever is in position **D**. You can upshift or downshift through the gears in succession.

Downshifting

Warning!



On slippery road surfaces, never downshift in order to obtain braking action. This could result in drive wheel slip and reduced vehicle control. Your vehicle's ABS will not prevent this type of loss of control.

- ▶ Briefly press the gear selector lever to the left in the **D**- direction (▷ page 166).

or

- ▶ Press button ① on the left side of the steering wheel (▷ page 174).

The transmission shifts to the next lower gear.



When you brake or stop, the transmission shifts down to a gear from which you can easily accelerate or take off.

Upshifting



In the **MANUAL** program mode, the transmission will not upshift, even if the engine has reached its overrevving range. Shift up to the next gear before the engine has reached its overrevving range. Make absolutely certain that the engine speed does not reach the red marking on the tachometer (▷ page 24). Otherwise the engine could be damaged which is not covered by the Mercedes-Benz Limited Warranty.

- ▶ Briefly press the gear selector lever to the right in the **D+** direction (▷ page 166).

or

- ▶ Press button ② on the right side of the steering wheel (▷ page 174).

The transmission shifts to the next higher gear.

If, instead of the manual program mode symbol **M**, the symbol  appears in the right multifunction display (▷ page 165), shift to the next higher gear. The fuel supply will otherwise be interrupted to prevent the engine from overrevving.

Kickdown

Using the kickdown when driving in the **MANUAL** program mode is not possible.

Deactivating manual shift program

- ▶ Press the program mode selector switch (▷ page 175) repeatedly until **C** or **S** appears in the right multifunction display.

or

- ▶ Restart the engine.

The transmission will go to the automatic program mode (**C** or **S**).

The **MANUAL** program mode is not stored.

Controls in detail

Automatic transmission

Emergency operation (Limp Home Mode)

If vehicle acceleration worsens or the transmission no longer shifts, the transmission is most likely operating in limp home (emergency operation) mode. In this mode only second gear and reverse gear can be activated.

- ▶ Stop the vehicle.
- ▶ Move gear selector lever to **P**.
- ▶ Turn off the engine.
- ▶ Wait at least ten seconds before restarting.
- ▶ Restart the engine.
- ▶ Move gear selector lever to position **D** (for second gear) or **R**.
- ▶ Have the transmission checked at an authorized Mercedes-Benz Center as soon as possible.

Controls in detail

Good visibility

For information on windshield wiper operation, see “Windshield wipers” (▷ page 53).

Headlamp cleaning system

The switch is located on the left side of the dashboard.



① Headlamp washer button

► Switch on the ignition (▷ page 36).

► Press button ①.

The headlamps are cleaned with a high-pressure water jet.

For information on filling up the washer fluid reservoir, see “Windshield washer system and headlamp cleaning system” (▷ page 278).

Rear window defroster

For information, see “Rear window defroster” (▷ page 189).

Rear view mirrors

For information on setting the rear view mirrors, see “Mirrors” (▷ page 43).

Auto-dimming rear view mirror

The reflection brightness of the exterior rear view mirror on the driver’s side and the interior rear view mirror will respond automatically to glare when

- the ignition is switched on and
- incoming light from headlamps falls on the sensor in the interior rear view mirror.

The interior rear view mirror will not react if

- reverse gear is engaged
- the interior lighting is switched on

Warning!



The auto-dimming function does not react if incoming light is not aimed directly at sensors in the interior rear view mirror.

The interior rear view mirror and the exterior rear view mirror on the driver's side do not react, for example, if the wind screen is installed.

Glare can endanger you and others.

Warning!



In the case of an accident liquid electrolyte may escape from the mirror housing if the mirror glass breaks.

Electrolyte has an irritating effect. Do not allow the liquid to come into contact with eyes, skin, clothing, or respiratory system. In case it does, immediately flush affected area with water, and seek medical help if necessary.



Electrolyte drops coming into contact with the vehicle paint finish can be completely removed only while in the liquid state by applying plenty of water.

Warning!



Exercise care when using the passenger-side exterior rear view mirror. The mirror surface is convex (outwardly curved surface for a wider field of view). Objects in mirror are closer than they appear. Check your interior rear view mirror or glance over your shoulder before changing lanes.

Controls in detail

Good visibility

Activating exterior rear view mirror parking position

Follow these steps to activate the mirror parking position so that the passenger-side exterior rear view mirror will be turned downward to the stored position.

- ▶ Make sure you have stored a parking position for the passenger-side exterior rear view mirror (▷ page 121).
- ▶ Make sure the **Mirror** setting when parking function in the **Convenience** submenu of the control system is switched to **ON** (▷ page 158).
- ▶ Switch on the ignition (▷ page 36).
- ▶ Press button ② for the passenger-side exterior rear view mirror. ▷▷

Controls in detail

Good visibility

- ▷▷ Place the gear selector lever in reverse gear **R**.

The passenger-side exterior rear view mirror will be turned downward to the stored position.

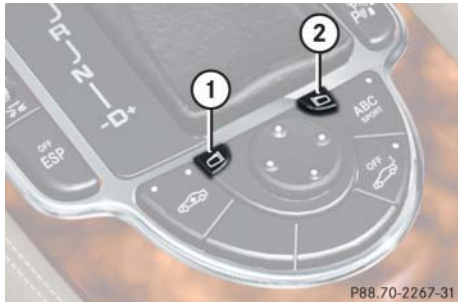

- ① Driver's side exterior rear view mirror button
- ② Passenger-side exterior rear view mirror button

The exterior rear view mirror returns to its previously stored driving position:

- ten seconds after you put the gear selector lever out of position **R**
- immediately once your vehicle exceeds a speed of approximately 6 mph (10 km/h)
- immediately when you press button ① for driver's side mirror.

Sun visors

The sun visors protect you from sun glare while driving.

Warning!



Do not use the vanity mirror while driving.

Keep the mirrors in the sun visors closed while vehicle is in motion. Reflected glare can endanger you and others.

- ▶ Swing sun visors down when you experience glare.

Controls in detail

Good visibility

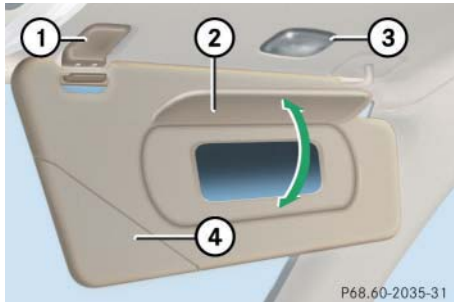

- ① Mounting
- ② Mirror cover
- ③ Mirror lamp
- ④ Holder for gas cards

► To use mirror, lift up cover ②.



If sunlight enters through a side window, disengage sun visor from mounting ① and pivot to the side.

The mirror lamp ③ will switch off.

Controls in detail

Automatic climate control

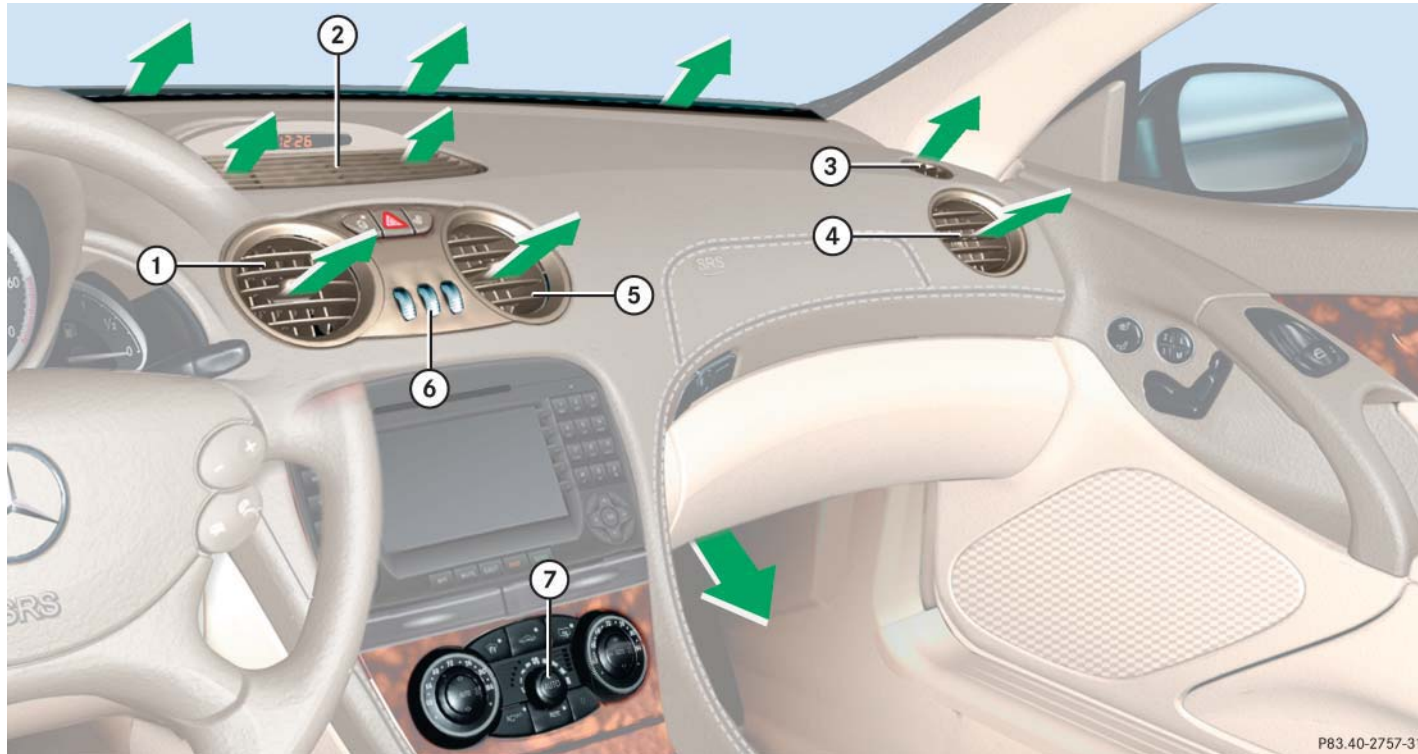

Item
① Center air vent, adjustable
② Center air vent, fixed
③ Side defroster vent
④ Side air vent, adjustable
⑤ Center air vent, adjustable
⑥ Air volume control for center and side air vents
⑦ Automatic climate control panel



For draft-free ventilation, move the sliders for the center air vents to the middle position.



Automatic climate control panel

Controls in detail

Automatic climate control

Item
① Temperature control, left
② Air distribution, left (automatic or manual operation)
③ Defrosting
④ Air recirculation
⑤ Rear window defroster
⑥ Air distribution, right (automatic or manual operation)
⑦ Temperature control, right
⑧ Automatic climate control on/off (complete system)
⑨ Residual heat/ventilation
⑩ Air volume control (automatic, manual)
⑪ AC cooling on/off

Controls in detail

Automatic climate control

The automatic climate control is operational whenever the engine is running. You can operate the climate control system in either the automatic or manual mode. The system cools or heats the interior depending on the selected interior temperature and the current outside temperature.

Warning!



When operating the automatic climate control, the air that enters the passenger compartment through the air vents in the footwell can be very hot or very cold (depending on the set temperature). This may cause burns or frostbite on unprotected skin in the immediate area of the air vents. Always keep sufficient distance between unprotected parts of the body and the footwell air vents. If necessary change the air flow using the air distribution controls to direct the air away from the footwell air vents (▷ page 186).

Nearly all dust particles, pollutants and odors are filtered out before outside air enters the passenger compartment through the air distribution system.

Warning!



Follow the recommended settings for heating and cooling given on the following pages. Otherwise the windows could fog up, impairing visibility and endangering you and others.



If the vehicle interior is hot, ventilate the interior before driving off.

Keep the air intake grille in front of the windshield free of snow and debris.

When the retractable hardtop is closed, do not obstruct air flow by placing objects on the air flow-through exhaust slots below the rear window.

Setting the temperature

Use temperature controls ① and ⑦ to separately adjust the air temperature on each side of the passenger compartment. You should raise or lower the temperature setting in small increments, preferably starting at 72°F (22°C).



When operating the climate control system in automatic mode, you will only rarely need to adjust the temperature, air volume and air distribution.

Increasing

- ▶ Turn the outer adjustment ring slightly to the right.

The automatic climate control system will correspondingly adjust the interior air temperature.

Decreasing

- ▶ Turn the outer adjustment ring slightly to the left.

The automatic climate control system will correspondingly adjust the interior air temperature.

Adjusting air volume

Use air volume control ⑩ (▷ page 183) for both automatic and manual air volume adjustment.

Adjusting manually

- ▶ Press the control knob.

The **AUTO** light on the control knob goes out. You can now select one of nine air volume settings.

Adjusting automatically

- ▶ Press the control knob.





The **AUTO** light on the control knob comes on. The airflow is adjusted automatically.

Controls in detail

Automatic climate control

Adjusting air distribution

Use air distribution controls ② and ⑥ (▷ page 183) to separately adjust the air distribution on each side of the passenger compartment. The following symbols are found on the controls:

Symbol	Function
	Directs air through the center air vents
	Directs air to the windows
	Directs air into the entire vehicle interior
	Directs air to the footwells

Adjusting manually

- ▶ Press the control knob.



The **AUTO** light on the control knob goes out. The air distribution can be adjusted manually.

Adjusting automatically

- ▶ Press the control knob.

The **AUTO** light on the control knob comes on. The air distribution is adjusted automatically.

Windshield fogged on the outside

- ▶ Switch the windshield wipers on.
- ▶ Turn the air distribution control to  or .

Maximum cooling MAXCOOL

If the left and right air distribution controls as well as the airflow volume control are set to **AUTO** and there is a high need for cooling, MAXCOOL is activated.

This provides the fastest possible cooling of the vehicle interior (when retractable hardtop is closed).

Controls in detail

Automatic climate control

Defrosting windshield



These settings should only be selected for a short time.

Activating

- ▶ Press button  (▷ page 183).
The indicator lamp on the button comes on.

Deactivating

- ▶ Press button  (▷ page 183).
The indicator lamp on the button goes out. Defrosting is turned off.

Air recirculation mode

Switch to air recirculation mode to prevent unpleasant odors from entering the vehicle from the outside. This setting cuts off the intake of outside air and recirculates the air in the passenger compartment.

Warning!



When the outside temperature is below 41°F (5°C), only switch to air recirculation mode for short periods to prevent window fogging.

Activating

- ▶ Press button  (▷ page 183).
The indicator lamp on the button comes on.

Warning!



Never operate the side windows if there is the possibility of anyone being harmed by the closing procedure.

In the event that the procedure causes potential danger, the closing of the side windows can be immediately halted by releasing the  button or by pressing or pulling the respective window switch.

Controls in detail

Automatic climate control



If you keep button  pressed, the side windows will close.

The air recirculation mode is activated automatically

- at high outside temperatures
- if the concentration of carbon monoxide and nitrogen oxide in the outside air increases, for example in a tunnel

If you have turned off the air conditioner (▷ page 191) or the outside temperature is below 41°F (5°C), the air recirculation mode will not switch on automatically.

Deactivating

- ▶ Press button  (▷ page 183).

The indicator lamp on the button goes out.



If you keep button  pressed, the side windows will return to their previous position.

The air recirculation mode is deactivated automatically

- after five minutes if the outside temperature is below approximately 41°F (5°C)

- after five minutes if the air conditioner is turned off
- after 30 minutes if the outside temperature is above approximately 41°F (5°C)

At outside temperatures above 79°F (26°C) the system will not automatically switch back to outside air. A quantity of outside air is added after approximately 30 minutes.

Rear window defroster

The rear window defroster uses a large amount of power. To keep the battery drain to a minimum, switch off the defroster as soon as the rear window is clear. The defroster is automatically deactivated after approximately 6 to 17 minutes of operation depending on the outside temperature.

Activating

- ▶ Press button  (▷ page 183).
The indicator lamp on the button comes on.

Deactivating

- ▶ Press button  (▷ page 183) again.
The indicator lamp on the button goes out.

Warning!



Any accumulation of snow and ice should be removed from the rear window before driving. Visibility could otherwise be impaired, endangering you and others.



The rear window defroster cannot be switched on when the retractable hardtop is open. The indicator lamp will start flashing if the hardtop is open.

- Close the retractable hardtop.

The rear window defroster can again be turned on.



If the rear window defroster switches off too soon and the indicator lamp starts flashing, this means that too many electrical consumers are operating simultaneously and there is insufficient voltage in the battery. The system responds automatically by deactivating the rear window defroster.

As soon as the battery has sufficient voltage, the rear window defroster automatically turns itself back on.

Controls in detail

Automatic climate control

Residual heat and ventilation

With the engine switched off, it is possible to continue to heat or ventilate the interior for up to 30 minutes. This feature makes use of the residual heat produced by the engine.



How long the system will provide heating depends on the coolant temperature and the temperature set by the operator. The blower will run at speed setting **1** regardless of the air distribution control setting.

Activating

- ▶ Turn the SmartKey in the starter switch to position **1** or **0** or remove it from the starter switch.
- ▶ Press button **REST** (▷ page 183).
The indicator lamp on button **REST** comes on.

Deactivating

- ▶ Press button **REST** (▷ page 183).

The indicator lamp on button **REST** goes out.

The residual heat is automatically turned off:

- when the ignition is switched on
- after about 30 minutes
- if the battery voltage drops

Deactivating the automatic climate control system



This setting is only recommended when the retractable hardtop is open.

Deactivating

It is possible to completely deactivate the automatic climate control system.

- ▶ Press button **0** (▷ page 183).

The indicator lamp on button **0** comes on.

Reactivating

There are several ways to reactivate the automatic climate control system:

- ▶ Press any button on the automatic climate control panel (▷ page 183).

The indicator lamp on button **0** switches off.

or

- ▶ Turn one of the control knobs on the automatic climate control.

The indicator lamp on button **0** switches off.

Controls in detail

Automatic climate control

Air conditioning

The air conditioning is operational while the engine is running and cools the interior air to the temperature set by the operator.



Condensation may drip out from underneath the vehicle. This is normal and not an indication of a malfunction.

Deactivating

It is possible to deactivate the air conditioning (cooling) function of the automatic climate control system. The air in the vehicle will then no longer be cooled or dehumidified.

- ▶ Press **AC^{OFF}** button (▷ page 183).

The indicator lamp on the **AC^{OFF}** button comes on.

Controls in detail

Automatic climate control

Activating

Moist air can fog up the windows. You can dehumidify the air with the air conditioning.

- ▶ Press **AC^{OFF}** again (▷ page 183).

The indicator lamp on the **AC^{OFF}** button goes out.

The air conditioning uses the refrigerant R134A. This refrigerant is free of CFCs which are harmful to the ozone layer.



If the **AC^{OFF}** button on the automatic climate control panel starts to flash, this indicates that the air conditioning is losing refrigerant. The compressor has turned off. The air conditioning cannot be turned on again.

- Have the air conditioning checked at the nearest authorized Mercedes-Benz Center.

Ventilated storage compartments

The glove box and the armrest storage compartment have their own air vents that allow for cooling ventilation when the automatic climate control system is activated.



You should keep these air vents closed when outside temperatures are low.

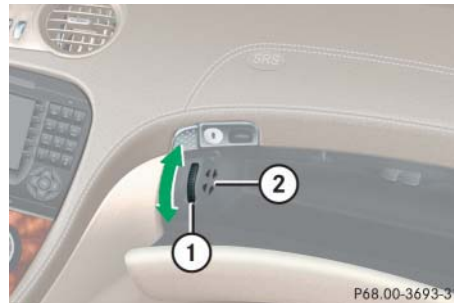

Glove box

- ① Thumbwheel
- ② Air vent

Opening the air vent

- ▶ Turn thumbwheel ① upwards.

Closing the air vent

- ▶ Turn thumbwheel ① downwards.

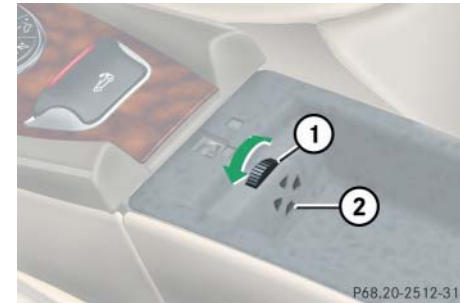

Storage compartment under the armrest

- ① Thumbwheel
- ② Air vent

Opening the air vent

- ▶ Turn thumbwheel ① to the right.

Closing the air vent

- ▶ Turn thumbwheel ① to the left.

▼ Power windows

Opening and closing the windows

The side windows are opened and closed electrically. The switches for all the side windows are on the driver's door. The switch for the passenger side is on the passenger door.

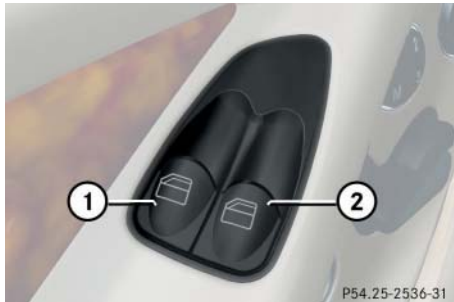

- ① Left front and rear windows
- ② Right front and rear windows

Warning!



When closing the windows, make sure that there is no danger of anyone being injured by the closing procedure.

The closing of the door windows can be immediately halted by releasing the switch or, if the switch was pulled past the resistance point and released, by either pressing or pulling the respective switch.

If the window encounters an obstruction that blocks its path in a circumstance where you pulled the switch past the resistance point and released it to close the window, the automatic reversal function will stop the window and open it slightly.

If the window encounters an obstruction that blocks its path in a circumstance where you are closing the window by pulling and holding the switch, by pressing and holding button  on the SmartKey,

Controls in detail

Power windows

or by pressing and holding the lock button (vehicles with KEYLESS-GO*) on the door handle, the automatic reversal function will not operate.

When leaving the vehicle, always remove the SmartKey or the SmartKey with KEYLESS-GO* from the starter switch, take it with you, and lock the vehicle. Do not leave children unattended in the vehicle, or with access to an unlocked vehicle. Unsupervised use of vehicle equipment can cause an accident and/or serious personal injury.

- Switch on the ignition (▷ page 36).



You can also open or close the windows using the  button on the control panel of the automatic climate control (▷ page 187).

Controls in detail

Power windows

Opening the windows

- ▶ Press switch ① or ② to the resistance point.

The corresponding window will move downwards until you release the switch.



If the hardtop is open, the respective rear window will open automatically as soon as the front window is completely open.

Opening the rear windows if the hardtop is closed:

- ▶ Open the front window.
- ▶ Press switch ① or ② to the resistance point again.

The corresponding rear window will open completely.

Closing the windows

- ▶ Pull switch ① or ② to the resistance point.

The corresponding window will move upwards until you release the switch.

Warning



If you pull and hold the switch up when closing the window, and upward movement of the window is blocked by some obstruction including but not limited to arms, hands, fingers, etc., the automatic reversal will not operate.

Closing the rear windows if the hardtop is closed:

- ▶ Close the front window.
- ▶ Pull switch ① or ② to the resistance point again.

The corresponding rear window will close completely.

Fully opening the windows (Express-open)

- ▶ Press switch ① or ② past the resistance point and release.

The corresponding window opens completely.



If the hardtop is open, the respective rear window will open automatically as soon as the front window is completely open.

Fully closing the windows (Express-close)

- ▶ Pull switch ① or ② past the resistance point and release.

The corresponding window closes completely.

If the upward movement of the window is blocked during the closing procedure, the window will stop and open slightly.

Warning



Driver's door only:
If within five seconds the switch is again pulled past the resistance point and released, the automatic reversal will not operate.

Stopping windows

- ▶ Press or pull the respective switch again.

Closing the windows with the SmartKey with KEYLESS-GO*

- ▶ Press and hold lock button at door (▶ page 60) until the side windows are closed.

Warning!



When closing the windows make sure that there is no danger of anyone being harmed by the closing procedure.

The windows will not automatically re-open if blocked during convenience closing.

If potential danger exists, proceed as follows:

- Release the lock button.
- Pull on the door handle and hold firmly. The side windows open for as long as the door handle is held but the door not opened.

Synchronizing power windows

The power window must be resynchronized each time

- after the battery has been disconnected
- if the power windows cannot be fully opened (Express-open) or closed (Express-close)

Synchronizing the power windows

- ▶ Switch on ignition.
- ▶ Pull the power window switches until the side windows are closed.

Hold the switches for approximately one second.

The power windows are synchronized.

Controls in detail

Retractable hardtop

Opening and closing the retractable hardtop

For safety reasons, the retractable hardtop can only be opened and closed when the vehicle is standing still.

Warning!



Before operating the switch for the retractable hardtop, make sure there is no danger of anyone being injured by the moving parts (retractable roof, roof frame, and trunk lid) due to inattention.

Hands must never be placed near the roof frame, upper windshield area, hardtop, shelf behind roll bars, or trunk lid while the retractable hardtop is being raised or lowered. Serious personal injury may occur.

If potential danger exists, release the retractable hardtop switch. This immediately interrupts the raising or lowering procedure. You then can operate the hardtop switch to raise or lower the hardtop away from the danger zone.

Warning!



When leaving the vehicle, always remove the SmartKey or the SmartKey with KEYLESS-GO* from the starter switch, take it with you, and lock the vehicle. Do not leave children unattended in the vehicle, or with access to an unlocked vehicle. Unsupervised use of vehicle equipment can cause an accident and/or serious personal injury.



Never sit or place heavy objects on the rear shelf. Doing so could cause damage to the retractable hardtop and the rear shelf.



When opening and closing the retractable roof, make sure

- there is sufficient clearance for the hardtop to move up and the trunk lid to move back
- the luggage cover is extended and closed
- the trunk lid is closed
- no roof luggage carrier is installed
- the outside temperature is above +5°F (-15°C)

Otherwise the roof and trunk of the vehicle could be damaged.

Luggage cover

The luggage cover is located in the trunk.

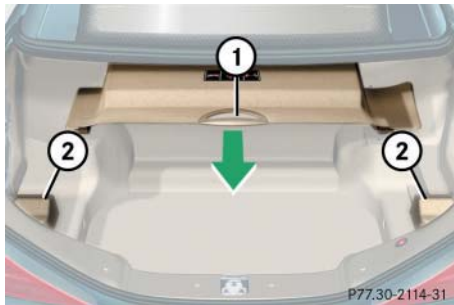

- ① Handle
- ② Holders

Closing luggage cover

- ▶ Pull out the luggage cover using handle ①.
- ▶ Hook the luggage cover into left and right side holders ②.

Opening luggage cover

- ▶ Unhook luggage cover from side holders.
- ▶ While holding on to handle ①, guide luggage cover back into its storage compartment.



To prevent damage to the hardtop or luggage/cargo when lowering the roof:

- Load trunk only to the height of the luggage cover.
- Do not permit luggage/cargo to push up the closed luggage cover.
- Do not load anything on top of or in front of the luggage cover.
- Do not place anything on the shelf behind the roll bar.

Controls in detail

Retractable hardtop

Opening the retractable hardtop with the switch



Hardtop switch

Before pulling on the hardtop switch, you must make sure

- the parking brake is engaged (> page 50)
- the luggage cover is closed, see Luggage cover
- the trunk lid is closed
- the ignition is switched on

Controls in detail

Retractable hardtop

- ▶ Pull up on the hardtop switch as indicated by the arrow until the hardtop is completely lowered into its trunk storage compartment and the indicator lamp in the hardtop switch goes out.

The multifunction display will briefly show the message

 Retractable roof Open.



Be sure that the roof is dry before you open it. Otherwise water may enter the trunk interior.

Closing the retractable hardtop with the switch



Before pressing the hardtop switch, you must make sure

- the parking brake is engaged (▷ page 50)
- the luggage cover is closed (▷ page 197)
- the trunk lid is closed
- the ignition is switched on

- ▶ Press the hardtop switch as indicated by the arrow until the hardtop is completely closed and locked and the indicator lamp in the hardtop switch goes out.

The multifunction display will briefly show the message

 Retractable roof Closed.

Warning!



If the retractable hardtop is not fully opened or closed, a warning will sound after 15 seconds, pressure in the hardtop's hydraulic system will drop and the hardtop will lower.

Be sure to keep the hardtop switch pulled or pressed until the hardtop is fully opened or closed. The hydraulic pump will then shut off.



To prevent possible accidents, drive the vehicle only with the hardtop either completely closed and locked, or fully lowered into its storage compartment.

Locking the retractable hardtop after raising/lowering

Warning!



The hardtop is not fully closed and locked or not fully opened and locked if:

- the indicator light in the hardtop switch remains lit
- the message  in operation is shown in the multifunction display and the indicator lamp in the hardtop switch does not go out
- the indicator lamp flashes and a warning sounds for 10 seconds and the message  Lock retractable roof is shown in the multifunction display when starting to drive

If the retractable hardtop is not properly locked, lock it as described below.

Unlocked status noticed when stopped

- ▶ Switch on ignition.
- ▶ To lock the hardtop in its fully closed position, press hardtop switch forward.

The message

 Retractable roof Closed appears in the multifunction display.

or:

- ▶ To lock the hardtop in its fully opened position, pull up on the hardtop switch.

The message  Retractable roof Open appears in the multifunction display.

Unlocked status noticed while driving

Warning!



Stop the vehicle and lock the hardtop before continuing to drive. You could otherwise endanger yourself and others.

- ▶ Stop the vehicle.
- ▶ Leave the ignition switched on.
- ▶ To lock the hardtop in its fully closed position, press hardtop switch forward.

The message

 Retractable roof Closed appears in the multifunction display.

or:

- ▶ To lock the hardtop in its fully opened position, pull up on the hardtop switch.

The message  Retractable roof Open appears in the multifunction display.

Controls in detail

Retractable hardtop

Controls in detail

Retractable hardtop

Warning!



If the retractable hardtop does not completely open or close, the roof hydraulics will lose pressure and the retractable hardtop is lowered

- after approximately seven minutes when the ignition is switched on
- after approximately 15 seconds when the ignition is switched off

Shortly before the hardtop is lowered, a warning will sound and the hardtop switch lamp will flash. In the speedometer display you will see , in the tachometer display you will see the message `being lowered`.

- Properly lock the retractable hardtop (▷ page 199) before continuing to drive.



Opening the retractable hardtop with the SmartKey (Summer opening feature)

Warning!



Before operating the retractable hardtop, make sure there is no danger of anyone being injured by the moving parts (retractable roof, roof frame, and trunk lid) due to inattention.

Hands must never be placed near the roof frame, upper windshield area, hardtop, shelf behind roll bars, or trunk lid while the retractable hardtop is being raised or lowered. Serious personal injury may occur.

If potential danger exists, release the respective button on the SmartKey. This immediately interrupts the raising or lowering procedure. You then can operate  or  to raise or lower the hardtop away from the danger zone.



- ▶ Aim the transmitter eye at the door handle.
- ▶ Press and hold button  until the retractable hardtop is completely open.

The seat ventilation for the driver's seat switches on. The rear side windows open. In the tachometer display you will see the message `Retractable roof Open`.

- ▶ Release button  to interrupt procedure.

Closing the retractable hardtop with the SmartKey (Convenience feature)

- ▶ Aim the transmitter eye at the door handle.
- ▶ Press and hold button  until the retractable hardtop is completely closed.

The retractable hardtop and the side windows close. In the tachometer display you will see the message *Retractable roof Closed*.

Warning!



If the retractable hardtop does not completely open or close a warning sounds and the retractable hardtop switch flashes. In the speedometer display you will see , in the tachometer display you will see the message *being lowered*. After about 15 seconds the roof hydraulics lose pressure.

Properly lock the retractable hardtop (▷ page 199) before continuing to drive.

Problems when operating the retractable hardtop

Indicator lamp in the retractable hardtop switch is flashing

Several conditions may cause the indicator lamp in the hardtop switch to flash when activated:

- The luggage cover in the trunk is not closed.
 - ▶ Close the luggage cover in the trunk.
- The trunk lid is open.
 - ▶ Close the trunk lid.
- The battery voltage is too low.
 - ▶ Start engine and let run while activating switch.

Controls in detail

Retractable hardtop

- The hardtop drive system has shut itself down. For safety reasons, no more than five consecutive attempts may be made to raise or lower the hardtop.
 - ▶ After about ten minutes you may again attempt to open or close the retractable hardtop.

If the indicator lamp in the retractable hardtop switch flashes when starting off or while driving and you hear a warning sound for a maximum of 10 seconds, the retractable hardtop is not locked.

- ▶ Properly lock the retractable hardtop (▷ page 199) before continuing to drive.

If the indicator lamp continues to flash after you have carried out the above actions, there is a malfunction.

- ▶ Have the retractable hardtop system checked at an authorized Mercedes-Benz Center.

Controls in detail

Retractable hardtop

Indicator lamp in the retractable hardtop switch lights when vehicle is stopped

If the indicator lamp in the retractable hardtop switch lights while the vehicle is standing still and the switch was not activated, then the retractable hardtop is not locked.

- ▶ Properly lock the retractable hardtop (▷ page 199) before continuing to drive.

The retractable hardtop will not lock

There is a malfunction in the retractable hardtop system.

- ▶ Notify an authorized Mercedes-Benz Center.

Wind screen

Warning!



The wind screen can restrict the driver's vision to the rear of the vehicle. To prevent a possible accident when visibility is limited (e.g. in darkness), the upper part of the wind screen should be folded back.

The wind screen deflects drafts away from the driver and passenger when the hardtop is lowered. It is stored in a separate storage bag.

Installing

- ▶ Leave the wind screen folded and place it on the roll bar.

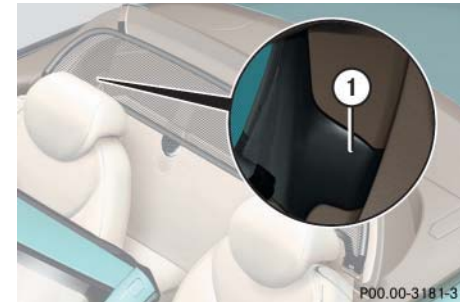

① Guide tabs

- ▶ Slide the wind screen into the roll bar until the guide tabs on each side latch underneath the roll bar. Make sure the fastening straps do not get caught.
- ▶ Raise the roll bar slightly (▷ page 73).

Controls in detail

Retractable hardtop

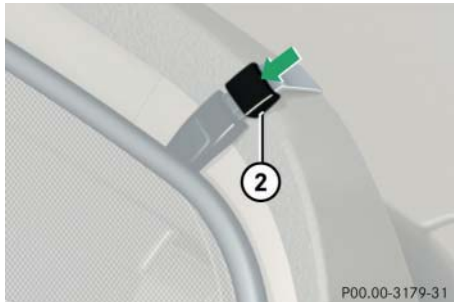

② Buckle

- ▶ Guide the fastening straps around the top of the roll bar and close buckles ②.
- ▶ Tighten the fastening straps if necessary.
- ▶ Lower the roll bar.
- ▶ Fold the upper section of the wind screen up towards the head restraints until it stops.

Removing

- ▶ Fold the upper section of the wind screen back down.
- ▶ Raise the roll bar slightly (▷ page 73).

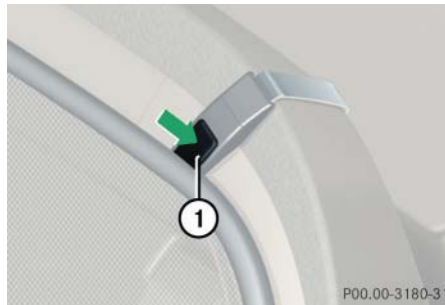

① Release button

- ▶ Undo the buckles on the upper section of the roll bar by pressing release button ①.

- ▶ Lower the roll bar. Make sure the fastening straps do not get caught.
- ▶ Pull the wind screen out towards the front of the vehicle. Be careful not to damage interior trim with the guide tabs.
- ▶ Place the wind screen back into the bag.

Sunshade for panorama roof*

The sunshade protects you from excessive sunlight coming in through the panorama roof.

Warning!



Do not operate the sunshade while driving. Adjusting the sunshade while driving could cause the driver to lose control of the vehicle.

Controls in detail

Retractable hardtop

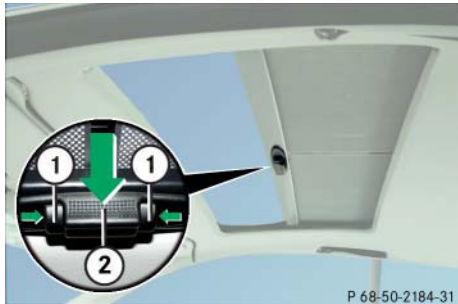

① Stop buttons

② Handle

Opening

- ▶ Squeeze stop buttons ① and guide the sunshade towards the rear.

Closing

- ▶ Using handle ②, slide the sunshade towards the front of the vehicle.

▼ Driving systems

The driving systems of your vehicle are described on the following pages:

- Cruise control and Distronic*, with which the vehicle can maintain a preset speed
- ABC with vehicle level control systems, with which you can change vehicle suspension characteristics
- Parktronic*, which assists the driver during parking maneuvers

For information on the BAS, ABS, and ESP, see “Driving safety systems” (▷ page 79).

Cruise control

The cruise control automatically maintains the speed you set for your vehicle.

Use of cruise control is recommended for driving at a constant speed for extended periods of time. You can set or resume cruise control at any speed above 25 mph (40 km/h).

The cruise control function is operated by means of the cruise control lever.

The cruise control lever is the uppermost lever found on the left-hand side of the steering column (▷ page 22).

Controls in detail

Driving systems

Warning!



The cruise control is a convenience system designed to assist the driver during vehicle operation. The driver is and must remain at all times responsible for the vehicle speed and for safe brake operation.

Only use the cruise control if the road, traffic, and weather conditions make it advisable to travel at a steady speed.

- The use of cruise control can be dangerous on winding roads or in heavy traffic because conditions do not allow safe driving at a steady speed.
- The use of cruise control can be dangerous on slippery roads. Rapid changes in tire traction can result in wheel spin and loss of control.
- Deactivate the cruise control when driving in fog.

The “Resume” function should only be operated if the driver is fully aware of the previously set speed and wishes to resume this particular preset speed.

Controls in detail

Driving systems

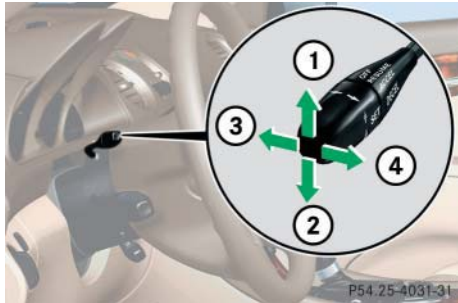

- ① Set current or higher speed
- ② Set current or lower speed
- ③ Cancel cruise control
- ④ Resume at last set speed

Warning



Cruise control brakes automatically so that the set speed is not exceeded.

Keep in mind that cruise control is a convenience system designed to assist the driver during vehicle operation. The driver is and must remain at all times responsible for the vehicle speed and for safe brake operation.

Setting current speed

- ▶ Accelerate or decelerate to the desired speed.
- ▶ Briefly lift ① or depress ② the cruise control lever.
The current speed is set.
- ▶ Remove your foot from the accelerator pedal.

The cruise control is activated.

The selected speed appears in the multi-function display.



On uphill or downhill grades, the cruise control may not be able to maintain the set speed. Once the grade eases, the set speed will be resumed.

On downhill grades, the cruise control maintains the set speed with active braking action. In addition, on longer downhill grades, the automatic transmission will automatically downshift.

Canceling cruise control

There are several ways to cancel the cruise control:

- ▶ Step on the brake pedal.

The cruise control is canceled. The last speed set is stored for later use.

or

- ▶ Briefly push the cruise control lever in direction of arrow ③.

The cruise control is canceled. The last speed set is stored for later use.



The cruise control switches off automatically if

- you step on the brake pedal
- you depress the parking brake pedal

The cruise control also switches off automatically when

- the vehicle speed is below 25 mph (40 km/h)
- the ESP is in operation or switched off with the ESP switch (▷ page 83)
- you move the gear selector lever to position **N** while driving

An acoustic warning sounds and the message **TMP Off** appears in the multifunction display for approximately five seconds.



Depressing the accelerator pedal does not deactivate the cruise control. After brief acceleration (e.g. for passing), the cruise control will resume the last speed set.



The last stored speed is canceled when you turn off the engine.



Moving the gear selector lever to position **N** while driving also cancels cruise control. However, the gear selector lever should not be moved to position **N** while driving except to coast when the vehicle is in danger of skidding (e.g. on icy roads).

Setting a higher speed

- ▶ Lift the cruise control in direction of arrow ① (▷ page 206) and hold it there until the desired speed is reached.
- ▶ Release the cruise control lever.
The new speed is set.

Setting a lower speed

- ▶ Depress the cruise control in direction of arrow ② (▷ page 206) and hold it there until the desired speed is reached.
- ▶ Release the cruise control lever.
The new speed is set.



When you use the cruise control lever to decelerate, the brake system will automatically brake the vehicle if the engine's braking power does not brake the vehicle sufficiently.

Controls in detail

Driving systems

Fine adjustment in 1 mph (Canada: 1 km/h) increments

Faster

- ▶ Briefly tip the cruise control lever in direction of arrow ① (▷ page 206).

Slower

- ▶ Briefly tip the cruise control lever in direction of arrow ② (▷ page 206).

Setting to last stored speed ("Resume" function)

Warning!



The speed stored in memory should only be set again if prevailing road conditions permit. Possible acceleration or deceleration differences arising from returning to the preset speed could cause an accident and/or serious injury to you and others.

- ▶ Briefly pull the cruise control lever in direction of arrow ④ (▷ page 206).

The cruise control will resume the last set speed.

- ▶ Remove your foot from the accelerator pedal.

The selected speed appears in the multifunction display.

Distronic*

When activated, the Distronic adaptive cruise control system increases the driving convenience afforded by the cruise control during travel on expressways and other major roads.

- If the Distronic distance sensor detects a slower moving vehicle directly ahead, your vehicle speed will be reduced so that you follow that vehicle at a preset distance.
- If there is no vehicle directly ahead of you, Distronic will function in the same way as cruise control (▷ page 205).

Warning!



Distronic adaptive cruise control is no substitute for active driving involvement. It does not react to stationary objects, nor recognize or predict the curvature and lane layout or the movement of vehicles ahead. Distronic can only apply a maximum of 20% of the vehicle's braking power.

It is the driver's responsibility at all times to be attentive to road, weather and traffic conditions and to provide the steering, braking and other driving inputs necessary to retain control of the vehicle.

Warning!



Distronic is a convenience system, its speed adjustment reduction capability is intended to make cruise control more effective and usable when traffic speeds vary. It is not however, intended to, nor does it, replace the need for extreme care. The responsibility for the vehicle speed and the distance to the vehicle ahead, including most importantly brake operation to assure safe stopping distance, always rests with the driver. Distronic cannot take street and traffic conditions into account.

Warning!



Distronic requires familiarity with its operational characteristics. We strongly recommend that you review the following information carefully before operating the system.



- USA only:
This device complies with Part 15 of the FCC Rules. Operation is subject to the following two conditions:
- (1) This device may not cause harmful interference, and
 - (2) this device must accept any interference received, including interference that may cause undesired operation.

Any unauthorized modification to this device could void the user's authority to operate the equipment.

Controls in detail

Driving systems



- Canada only:
This device complies with RSS-210 of Industry Canada. Operation is subject to the following two conditions:
- (1) This device may not cause interference, and
 - (2) this device must accept any interference received, including interference that may cause undesired operation of the device.

Any unauthorized modification to this device could void the user's authority to operate the equipment.

Warning!



Distronic cannot take street and traffic conditions into account. Only use Distronic if the weather and traffic conditions make it advisable to travel at a steady speed.

Controls in detail

Driving systems

Warning!



Use of Distronic can be dangerous on slippery roads. Rapid changes in tire traction can result in wheel spin and loss of control.

Distronic does not act upon adverse sight distance conditions. Do not use Distronic during conditions of fog and heavy rain, snow or sleet.

Warning!



Close attention to road and traffic conditions is imperative at all times, regardless of whether or not Distronic is activated.

Use of Distronic can be dangerous on winding roads or in heavy traffic because conditions do not allow safe driving at a steady speed.

Distronic will not react to stationary objects in the roadway (e.g. a stopped vehicle in a traffic jam or a disabled vehicle). Distronic will also not respond to oncoming vehicles.

Switch off Distronic:

- when changing from the left to the right lane if vehicles are moving more slowly in the left lane
- when entering a turn lane or highway off ramp
- in complex driving situations, such as in highway construction zones

In these situations, Distronic will continue to maintain the set speed unless deactivated.

Distronic is designed and intended only to maintain a set speed and keep a set distance from moving objects in front of it.

Warning!



The "Resume" function should only be operated if the driver is fully aware of the previously set speed and wishes to resume this particular preset speed.

Distronic displays in the speedometer dial

If Distronic detects a vehicle directly ahead, the DTR indicator lamp  in the speedometer dial comes on white.

If Distronic calculates that there is a danger of collision

- the DTR warning lamp  in the speedometer comes on red
 - an intermittent warning sounds
- Immediately brake the vehicle to avoid a collision.

Under no circumstances should the driver await the intermittent warning sound before braking. See the following warning note.

The intermittent warning sound ceases and the red DTR warning lamp  goes out when the necessary distance to the vehicle ahead is again established.

Controls in detail

Driving systems



① Red DTR warning lamp 

Warning!



An intermittent warning sounds and the DTR warning lamp (red ) in the speedometer dial is illuminated if the Distronic system calculates that the distance to the vehicle ahead and your vehicle's current speed indicate that Distronic will not be capable of slowing the vehicle sufficiently to maintain the preset following distance, which creates a danger of a collision.

Immediately brake the vehicle to increase the distance to the vehicle in front of you. The warning sound is intended as a final caution that you have not interceded with your own braking inputs to avoid a potentially dangerous situation. Do not wait for the operation of the warning signal to intercede with your own braking, as that will result in potentially dangerous emergency braking which will not always result in an impact being avoided.

Tailgating increases the risk of an accident.

Warning!



The Distronic brakes your vehicle with a maximum of 6.5 ft/s^2 (2 m/s^2). This corresponds to about 20% of the maximum deceleration ability of your vehicle.



Distronic brakes the vehicle in an effort to restore the preset distance or to maintain the speed.

Controls in detail

Driving systems

Distronic menu in the control system

In the DISTRONIC menu you can read the current settings for DISTRONIC. What appears in the left multifunction display depends on whether the DISTRONIC is turned on or off.

- ▶ Press button  or  repeatedly until you see one of the following displays.

Distronic deactivated

When DISTRONIC is deactivated you will see the standard display in the left multifunction display.

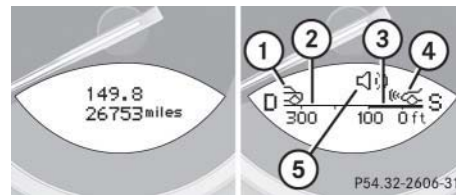

- ① Vehicle ahead, if detected
- ② Actual distance to vehicle ahead
- ③ Preset distance threshold to vehicle ahead
- ④ Your vehicle
- ⑤ Symbol for activated distance warning function

Distronic activated

When DISTRONIC is activated the DTR symbol and the set speed are seen in the left display.

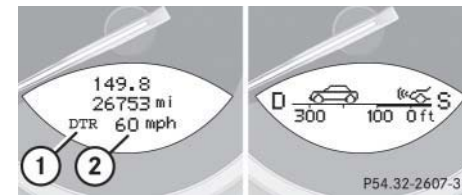

- ① Symbol for activated DISTRONIC
- ② Set speed

Cruise control lever

The Distronic system is operated by means of the cruise control lever.

The cruise control lever is the uppermost lever found on the left-hand side of the steering column.

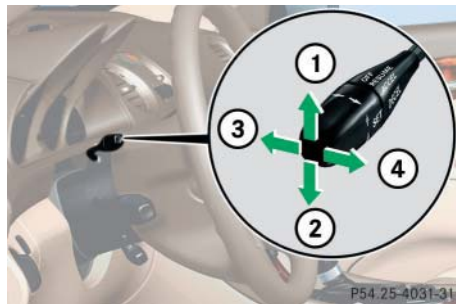

- ① Set current or higher speed
- ② Set current or lower speed
- ③ Deactivate Distronic
- ④ Resume at last set speed

Activating Distronic

You can activate Distronic if

- you are driving between 25 mph (40 km/h) and 110 mph (180 km/h)
- the ESP is activated (▷ page 82)

When Distronic is activated the speedometer display will show a message such as DTR 60 mph.

If Distronic is deactivated, the speedometer display will show the message DTR --- mph.

In the following cases you cannot activate Distronic:

- up to two minutes after starting the engine
- when you brake
- if you have set the parking brake
- if the gear selector lever is in position **P**, **R**, or **N**.
- if the ESP is switched off



- ① Set speed
- ② White DTR indicator lamp 



The vehicle speed displayed on the speedometer can briefly vary from the speed setting on the distronic system.

Controls in detail

Driving systems

Setting the current speed

- ▶ Accelerate or decelerate to the desired speed.
- ▶ Briefly lift or depress the cruise control lever.

The current speed is set.

- ▶ Remove your foot from the accelerator pedal.



If you do not take your foot off of the accelerator completely, the following message will appear in the speedometer display field:

DTR override.

The distance to slower moving vehicles in front of you will not be set. Your vehicle speed will then be determined only by the accelerator pedal position.

Setting a higher speed

- ▶ Briefly tip the cruise control in direction of arrow ① (▷ page 213) to increase the vehicle speed in increments of 5 mph (Canada: 10 km/h).

The new speed is set.



Depressing the accelerator pedal does not deactivate Distronic. After brief acceleration (e.g. for passing), the cruise control will resume the last speed set.

Setting a lower speed

- ▶ Briefly tip the cruise control in direction of arrow ② (▷ page 213) to decrease the vehicle speed in increments of 5 mph (Canada: 10 km/h).

The new speed is set.



When you use the cruise control lever to decelerate, the brakes will be applied to support deceleration.

In addition, the transmission will automatically downshift on long downhill grades.

Fine adjustment in 1 mph (Canada: 1 km/h) increments

Faster

- ▶ Briefly tip the cruise control lever in direction of arrow ④ (▷ page 213).

Setting to last stored speed (“Resume” function)

Warning!



The speed stored in memory should only be set again if prevailing road conditions permit. Possible acceleration or deceleration differences arising from returning to the pre-set speed could endanger yourself and others.

- ▶ Briefly tip the cruise control lever in direction of arrow ④ (▷ page 213).
Distronic is set to the last stored speed.
- ▶ Remove your foot from the accelerator pedal.

Deactivating Distronic

There are several ways to deactivate the Distronic system:

- ▶ Briefly tip the cruise control lever in direction of arrow ③ (▷ page 213).

or

- ▶ Step on the brake pedal.

Distronic will be deactivated. The last speed set will be stored into memory.



The last stored speed is deleted when you turn off the engine.

Controls in detail

Driving systems

Distronic deactivates automatically when

- you set the parking brake
- you drive slower than 25 mph (40 km/h)
- the ESP is active (▷ page 82) or you deactivate the ESP
- You move the gear selector lever into position **N**.

A signal will sound. The *DTR off* message appears in the speedometer display for approximately five seconds.

Warning!



Distronic switches off and releases the brakes when the vehicle decelerates below the minimum speed of 25 mph (40 km/h) by operation of the system. At that time the driver must apply the brakes in order to reduce vehicle speed further or bring it to a stop.

Controls in detail

Driving systems

Setting the following distance in Distronic

You can set the specified following for Distronic by varying the time setting between 1.0 and 2.0 seconds. Using this time setting and the current speed of your vehicle, Distronic calculates and sets the required following distance to the vehicle ahead. The set distance will be shown in the speedometer display field.

The thumbwheel for making the time setting is located on the lower section of the center console.

Warning!



It is up to the driver to exercise discretion to select the appropriate setting given road conditions, traffic, driver's preferred driving style and applicable laws and driving recommendations for safe following distance.



- ① Distance warning function on/off switch
- ② Thumbwheel for setting distance

Increasing distance

Increasing the distance setting tells Distronic to maintain a greater following distance to the vehicle ahead.

- ▶ Turn thumbwheel ② towards

Decreasing distance

Decreasing the distance setting tells Distronic to maintain a smaller following distance to the vehicle ahead.

- ▶ Turn thumbwheel ② towards

Distance warning function

When Distronic is deactivated, this function will continue to warn you when recognizing a stationary obstacle or a slower vehicle moving in your vehicle's path and the danger of a collision exists:

- The DTR warning lamp comes on red.
- An intermittent warning will sound if necessary.

If these warnings are issued, you must brake manually to maintain a safe distance and avoid a collision with the vehicle ahead.

When pressing the brake pedal, the warning sound ceases. The warning sound will also cease, when the distance to the vehicle ahead is sufficient again without applying the brakes. In this case, the distance warning lamp will also go out.

Warning!



If the DTR warning lamp (red  in the speedometer dial comes on while driving and/or an intermittent warning sounds, immediate attention on the part of the driver is required.

As required by the traffic situation, apply the brakes and navigate around a possible obstacle. However, do not drive by relying on the distance warning function, as this will result in an emergency braking application. Especially depending on road surface conditions and driver reaction, this will not always enable you to avoid a collision.



Complex driving situations are not always fully recognized by DISTRONIC. This could result in wrong or missing distance warnings.

Activating

- ▶ Press switch ①.

The indicator lamp on the switch comes on. A loudspeaker symbol appears in the speedometer display (▷ page 212).

Deactivating

- ▶ Press switch ① once more.

The indicator lamp on the switch goes out. No loudspeaker symbol appears in the speedometer display.

Controls in detail

Driving systems

Driving with DISTRONIC

This section describes a number of driving situations where special precaution is required on the part of the driver. Be prepared to brake in such situations. This will deactivate the DISTRONIC system.

Warning!



DISTRONIC works to maintain the speed selected by the driver unless a moving obstacle proceeding directly ahead of it in the same travel direction is detected (e.g. following another vehicle ahead of you at a distance set by DISTRONIC). This means that:

- Your vehicle can pass another vehicle after you change lanes.
- While in a sharp turn or if the vehicle in front is in a sharp turn, DISTRONIC could lose sight of a vehicle traveling in front of it. Your vehicle could then accelerate to the previously selected speed. ▷▷

Controls in detail

Driving systems

▷▷ Distronic regulates only the distance between your vehicle and those directly ahead of it, but does not register stationary objects in the road, e.g.:

- a stopped vehicle in a traffic jam
- a disabled vehicle
- an oncoming vehicle

The driver must always be on the alert, observe all traffic and intercede as required by steering or braking the vehicle.

Warning!



Distronic should not be used in snowy or icy road conditions.

The most likely cause for a malfunctioning system is a dirty sensor (located behind the hood grille), especially at times of snow and ice or heavy rain. In such a case, Distronic will switch off, and the message *Distronic Currently unavailable*. See *Oper. Manual* appears in the multifunction display.

For cleaning and care of the Distronic sensor, see “Cleaning the Distronic* system sensor cover” (▷ page 318).

Turns and bends

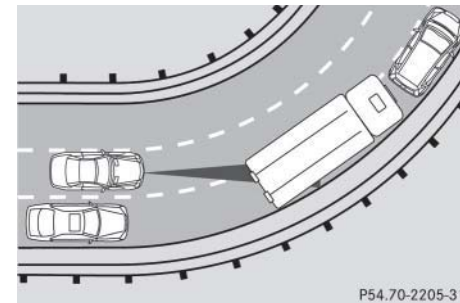

In turns or bends, Distronic may not detect a moving vehicle in front, or it may detect one too soon. This may cause your vehicle to brake late or unexpectedly.

Offset driving

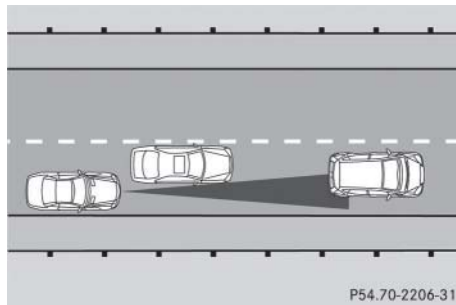

A vehicle traveling in your lane but offset from your direct line of travel may not be detected by Distronic. There will be insufficient distance to the vehicle ahead.

Lane changing

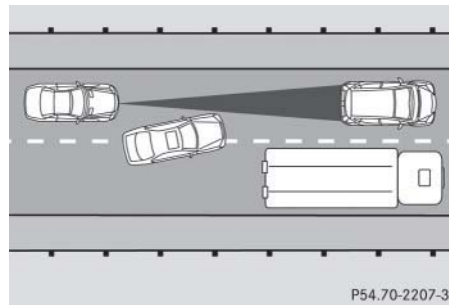

Distronic has not yet detected the vehicle changing lanes. There will be insufficient distance to the vehicle ahead.

Narrow vehicles

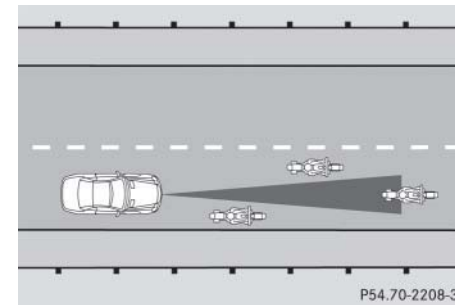

Because of their narrow profile, the vehicles traveling near the outer edges of the lane have not yet been detected by Distronic. There will be insufficient distance to the vehicles ahead.

Controls in detail

Driving systems

Active Body Control (ABC)

The ABC system automatically selects the optimum suspension tuning and ride height for your vehicle.

Suspension tuning

The suspension tuning is set according to:

- Your driving style
- Road surface conditions
- The vehicle loading
- Your choice of suspension style, “sporty” or “regular”, which you select using the ABC switch.

The selected suspension style is stored in memory, even after the SmartKey is removed from the starter switch.

The ABC switch with the indicator lamp is located in the lower section of the center console.



- ① ABC switch
- ② Indicator lamp

- ▶ Start the engine (▷ page 48).

Suspension for sporty driving style

The setting for sporty driving is selected when indicator lamp ② is illuminated.

- ▶ Press switch ①.

Indicator lamp ② comes on.

Suspension for regular driving style

The setting for regular driving is selected when the indicator lamp ② is off.

- ▶ Press switch ①.

Indicator lamp ② goes out.

Vehicle level control

Your vehicle automatically adjusts its ride height to:

- reduce fuel consumption
- increase vehicle safety

The vehicle chassis ride height is raised or lowered according to the selected level setting and to the vehicle speed:

- With increasing speed, ride height is reduced by up to approximately one inch (25 mm).
- With decreasing speed, the ride height is again raised to the selected vehicle level.



These height adjustments are so small that you may not notice any change.

Select the level 1 and 2 settings only when required by current driving conditions.

Otherwise:

- Fuel consumption may increase.
- Handling may be impaired.

Warning!



To help avoid personal injury, keep hands and feet away from wheel housing area, and stay away from under the vehicle when lowering the vehicle chassis.

Controls in detail

Driving systems

The following vehicle level settings can be selected when the vehicle is stationary:

Vehicle level when stationary	Use for	Height increase over normal	Automatic lowering	Indicator lamps (▷ page 222)
Normal	Normal operation	None	Max. approx. 0.5 in (12 mm)	Both lamps off
Level 1	Driving with snow chains (▷ page 310)	Max. 0.6 in (15 mm) ¹	Max. approx. 0.6 in (15 mm)	One lamp on
Level 2	Very rough road surface conditions	Max. 1.0 in (25 mm) ¹	Max. approx. 1.0 in (25 mm)	Both lamps on

¹ Dependent on loading

The switch and the indicator lamps are located in the lower section of the center console.

- ▶ Briefly press switch ③ to change from one level setting to the next. At level 1, indicator lamp ② is illuminated and at level 2 both indicator lamps are illuminated. When the vehicle is at level 2, pressing the switch will return the vehicle to normal level.



- ① Indicator lamp 1
- ② Indicator lamp 2
- ③ Vehicle level control switch



Pressing the switch twice in quick succession will cause the vehicle to immediately raise or lower to the new vehicle level as selected.

The selected vehicle level setting remains stored in memory even if the engine is turned off and restarted.

Parktronic* (Parking assist)

Warning!



Parktronic is a supplemental system. It is not intended to, nor does it replace, the need for extreme care. The responsibility during parking and other critical maneuvers always rests with the driver.

Special attention must be paid to objects with smooth surfaces or low silhouettes (e.g. trailer couplings, painted posts, or road curbs). Such objects may not be detected by the system and can damage the vehicle.

The operational function of the Parktronic system can be affected by dirty sensors, especially at times of snow and ice. See "Cleaning the Parktronic* system sensors" (▷ page 318).

Interference caused by other ultrasonic signals (e.g. working jackhammers, car wash, or the air brakes of trucks) can cause the system to send erratic indications, and should be taken into consideration.

Warning!



Make sure no persons or animals are in the area in which you are maneuvering. Otherwise you run the risk of causing injury.

The Parktronic system is an electronic aid designed to assist the driver during parking maneuvers. It visually and audibly indicates the relative distance between the vehicle and an obstacle.

The Parktronic system is automatically activated when you switch on the ignition, release the parking brake, or place the gear selector lever in Position **D**, **R**, or **N**. The Parktronic system deactivates at speeds above 11 mph (18 km/h). At lower speeds the Parktronic system turns on again. The Parktronic system also deactivates when you place the gear selector lever in Position **P** or depress the brake pedal.

Controls in detail

Driving systems

The Parktronic system monitors the surroundings of your vehicle with six sensors in the front bumper and four sensors in the rear bumper.

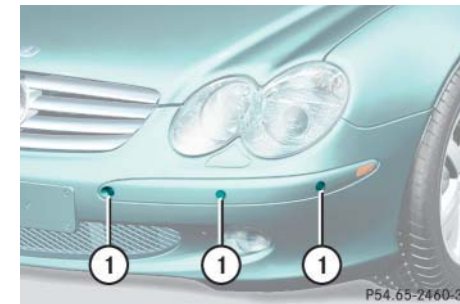

① Sensors in the front bumper

Controls in detail

Driving systems

Range of the sensors

To function properly, the sensors must be free of dirt, ice snow and slush. Clean the sensors regularly, being careful not to scratch or damage the sensors, see “Cleaning the Parktronic system* sensors” (▷ page 318).

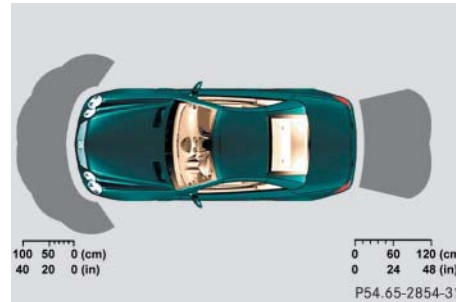
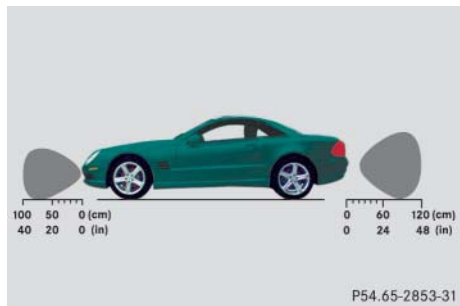

Front sensors

Center	approx. 40 in (100 cm)
Corners	approx. 24 in (60 cm)

Rear sensors

Center	approx. 48 in (120 cm)
Corners	approx. 32 in (80 cm)



During parking maneuvers, pay special attention to objects located above or below the height of the sensors (e.g. planters or trailer hitches). The Parktronic system will not detect such objects at close range and damage to your vehicle or the object may result.

Ultrasonic signals from outside sources (e.g. truck air brakes, car wash, or jackhammers) may impair the operation of the Parktronic system.

Controls in detail

Driving systems

Minimum distance

Center	approx. 8 in (20 cm)
Corners	approx. 6 in (15 cm)

If the system detects an obstacle in this range, all the distance warning segments illuminate and you hear a warning signal. If the obstacle is closer than the minimum distance, the actual distance may no longer be indicated by the system.

Warning indicators

Visual signals indicate to the driver the relative distance between the sensors and an obstacle. The warning indicator for the front area is located above the center air vents in the dashboard. The warning indicator for the rear area is integrated in the rear trim.



Front area warning indicator

- ① Left side of the vehicle
- ② Right side of the vehicle

Each warning indicator is divided into six yellow and two red distance segments for either side of the vehicle. The Parktronic system is ready when the border around the indicator is illuminated.

The position of the gear selector lever determines which warning indicators will be activated.

Gear selector lever position	Warning indicator
D	Front area activated
R or N	Front and rear area activated
P	Neither activated

Controls in detail

Driving systems

As your vehicle approaches an object, one or more distance segments will illuminate, depending on the distance. When the eighth distance segment illuminates, you have reached the minimum distance.

- **Front area:** An intermittent acoustic warning will sound as the first red distance segment illuminates and a constant acoustic warning lasting a maximum of two seconds will sound for the second distance segment. The signal is canceled when the gear selector lever is placed in position **P** or the parking brake is set.
- **Rear area:** An intermittent acoustic warning will sound when the first distance segment illuminates. This signal quickens with each additional distance segment lit. When the eighth distance segment illuminates, the acoustic warning becomes a constant signal. The signal is canceled when the gear selector lever is placed in position **D** or **P** or the parking brake is set.

Switching the Parktronic system on/off

You can switch off the Parktronic system manually.

The Parktronic switch is located in the lower part of the center console (▷ page 30).



- ① Parktronic switch
- ② Indicator lamp

Switching off the Parktronic system

- ▶ Press Parktronic switch ①.
Indicator lamp ② comes on.

Switching on the Parktronic system

- ▶ Press Parktronic switch ① again.
Indicator lamp ② goes out.



The Parktronic system switches on automatically when you switch on the ignition (▷ page 36).

Parktronic system malfunction

If only the red distance segments illuminate and a warning sounds, there is a malfunction in the Parktronic system. The Parktronic system will automatically switch off after 20 seconds and the indicator lamp in the Parktronic switch comes on.

- ▶ Have the Parktronic system checked by an authorized Mercedes-Benz Center as soon as possible.

If only the red distance segments illuminate and no warning sounds, the Parktronic system sensors are dirty or there is an interference from other radio or ultrasonic signals. The Parktronic system will automatically switch off after 20 seconds and the indicator lamp in the Parktronic switch comes on.

- ▶ Switch off the ignition.
- ▶ Clean Parktronic system sensors (▷ page 318).
- ▶ Switch on the ignition (▷ page 36).
or
- ▶ Check the Parktronic system operation at another location to rule out interference from outside radio or ultrasonic signals.

Controls in detail

Useful features

Storage compartments

Warning!



To help avoid personal injury during a collision or sudden maneuver, exercise care when stowing objects in the vehicle. Put luggage or cargo in the trunk if possible. Do not pile luggage or cargo higher than the seat backs. Do not place anything on shelf behind roll bar.

Parcel nets cannot secure hard or heavy objects.

Warning!



Keep compartment lids closed. This will help to prevent stored objects from being thrown about and injuring vehicle occupants during an accident.

Glove box

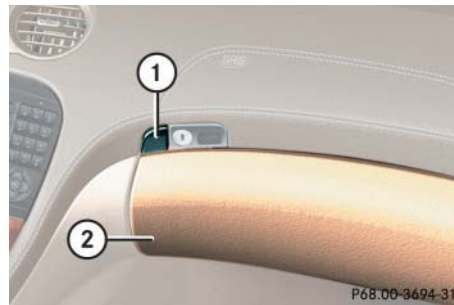

- ① Button to open
- ② Glove box lid

Opening the glove box

- ▶ Press button ①.
- Glove box lid ② opens downward.

Closing the glove box

- ▶ Push glove box lid ② up to close.

Cup holders



- ① Left cup holder
- ② Right cup holder

Opening

- ▶ Briefly press cup holder cover.
- The cup holder opens automatically.

Controls in detail

Useful features

Warning!



In order to help prevent spilling liquids on vehicle occupants, only use containers that fit into the cup holder. Use lids on open containers and do not fill containers to a height where the contents, especially hot liquids, could spill during braking, vehicle maneuvers, or in an accident.

When not in use, keep the cup holder closed. An open cup holder may cause injury to or others when contacted during braking, vehicle maneuvers, or in an accident.

Keep in mind that objects placed in the cup holder may come loose during braking, vehicle maneuvers, or in an accident and be thrown around in the vehicle interior. Objects thrown around in the vehicle interior may cause an accident and/or serious personal injury.

Door storage compartments

Warning!



Keep the door storage compartments closed while vehicle is in motion. Failure to do so may cause the seat belt to catch at the rear and prevent proper positioning of the seat belt.

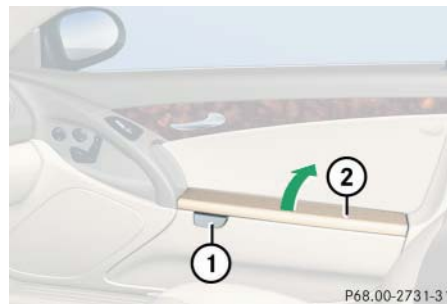

- ① Release button
- ② Lid

Opening

- ▶ Press release button ①.

The lid opens upwards.

Armrest storage compartments

The buttons are located under the cushion of the armrest.



- ① Button to open storage tray
- ② Button to open storage compartment

Controls in detail

Useful features

Opening storage tray

- ▶ Press button ① and lift up the armrest.

Opening storage compartment

- ▶ Press button ② and lift the armrest.

Locking the storage compartments

The storage compartments are centrally locked when you lock the vehicle from the outside.

You can also lock the storage compartments separately, see “Locking the storage compartments separately” (▷ page 230).

Rear storage compartments

The CD changer is located in the left storage compartment.

For instructions on the CD changer, see separate COMAND Operator’s Manual.



- ① Release button
- ② Lid

- ▶ Press release button ①.
The lid opens upwards.

Locking the storage compartments separately

You can lock the storage compartments separately, e.g. when the vehicle is in the shop for service.

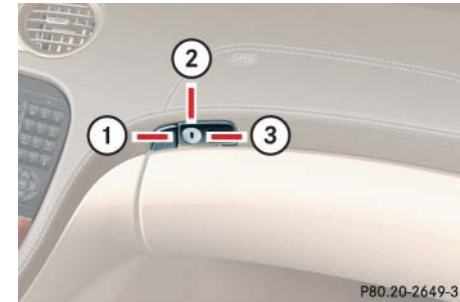

- ① Separately unlock storage compartments
 - ② Centrally lock/unlock storage compartments
 - ③ Separately lock storage compartments
- ▶ Slide mechanical key out of SmartKey housing (▷ page 374).

- ▶ Insert the mechanical key into the glove box lock and turn it to position ③.

The following storage compartments will be locked. They can then not be opened with the SmartKey or with the SmartKey with KEYLESS-GO*:

- Glove box
- Armrest storage compartments
- Rear storage compartments



The separate locking status of these storage compartments can only be canceled by means of the mechanical key.

The storage compartments in the doors cannot be locked.

Unlocking the storage compartments separately

- ▶ Turn the mechanical key in the glove box lock to position ①.

You can now open the storage compartments.

Parcel net in passenger footwell

Warning!



Do not place heavy or fragile objects, or objects having sharp edges, in the parcel net.

In an accident, during hard braking or sudden maneuvers, they could be thrown around inside the vehicle, and cause injury to vehicle occupants.

Controls in detail

Useful features

Parcel net in trunk

There are three nets available in the trunk to secure loads:

- a pocket net on each side of the right and left trunk side walls
 - a trunk floor net
- ▶ Pull the trunk floor net from the trunk back wall towards the front over the luggage.
 - ▶ Hang the hooks of the net on the eyes on the trunk floor.

Controls in detail

Useful features

Luggage compartment in the rear

Warning!



Secure all pieces of luggage in the rear with the luggage straps. Unsecured pieces of luggage can otherwise cause injury during a braking maneuver and can increase the risk of injury in an accident.

Never allow anyone to ride in the rear.

The luggage straps can only secure light luggage items. Carry heavy pieces of luggage in the trunk.

The rear compartment area is not designed or intended to accommodate occupants. Severe personal injury or death may be the result in an accident.



- ① Holder
- ② Strap
- ③ Latch
- ④ Release button

- ▶ Pull strap ② out of holder ①.
- ▶ Secure the luggage with the strap so that it cannot move.
- ▶ Insert strap ② into latch ③.

Releasing the strap

- ▶ Press release button ④ and guide strap ② back to holder ①.

Warning!



The shelf below the rear window should not be used to carry objects. This will avoid such objects from being thrown about and injuring vehicle occupants during an accident or sudden maneuver.

The trunk is the preferred place to carry objects.

Ashtray



- ① Cover plate
- ② Sliding knob

Opening ashtray

- ▶ Briefly touch cover plate ①.
The ashtray opens automatically.

Removing the ashtray insert

Warning!



Remove ashtray only with vehicle standing still. Set the parking brake to secure vehicle from movement. Move gear selector lever to position **N**. With gear selector lever in position **N**, turn off the engine.

- ▶ Secure vehicle from movement by setting the parking brake. Move the gear selector lever to position **N**.

Now you have more room to take out the insert.

- ▶ Press sliding knob ② to the right.
The insert will eject a short distance.

Replacing the ashtray insert

- ▶ Press the insert into the frame until it snaps into place.

Cigarette lighter

The lighter socket can be used to accommodate electrical accessories up to a maximum of 180 W.



- ① Cigarette lighter

- ▶ Switch on the ignition (▷ page 36).
- ▶ Push in cigarette lighter ①.

The lighter will pop out automatically when hot. ▷▷

Controls in detail

Useful features



Warning!



Never touch the heating element or sides of the lighter; they are extremely hot. Hold the knob only.

When leaving the vehicle, always remove the SmartKey or the SmartKey with KEYLESS-GO* from the starter switch, take it with you, and lock the vehicle. Do not leave children unattended in the vehicle, or with access to an unlocked vehicle. Unsupervised use of vehicle equipment may cause serious personal injury.

Heated steering wheel* (SL 500, SL 600)

The steering wheel heating warms up the leather area of the steering wheel.

The lever is on the lower left-hand side of the steering wheel.

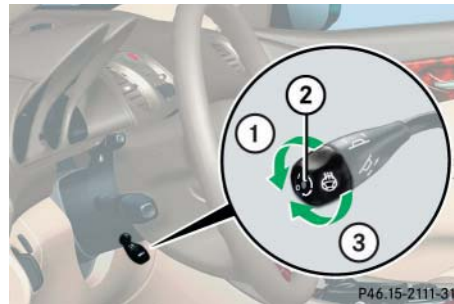

- ① Switching on
- ② Indicator lamp
- ③ Switching off

Switching on

- ▶ Switch on the ignition (▷ page 36).
 - ▶ Turn switch at tip of stalk in the direction of arrow ①.
- The steering wheel is heated. Indicator lamp ② comes on.

Switching off

- ▶ Turn switch at tip of stalk in the direction of arrow ③.
- The steering wheel heating is turned off. Indicator lamp ② goes out.



The steering wheel heating does not turn off automatically.

Controls in detail

Useful features

Load assist in the trunk

To facilitate trunk loading after opening the lid, use the load assist feature to raise the retracted hardtop from its storage position in the trunk.

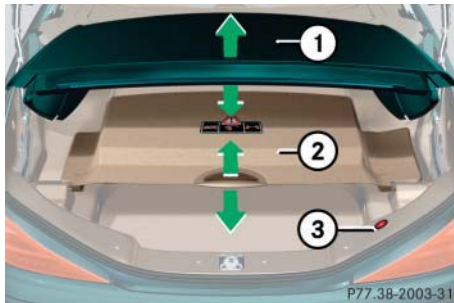

- ① Retracted hardtop
- ② Luggage cover
- ③ Load assist button

Raising the hardtop

Warning!



To prevent injuries, make sure that there is no possibility of body parts getting caught in moving parts. If potential danger exists, press the switch again. This will immediately stop the movement of the hardtop.

The hardtop can only be raised when the luggage cover is closed and the trunk lid is completely opened.

- ▶ Press button ③.

The hardtop rises a short distance. Button ③ comes on brightly. You can now open the luggage cover.

Lowering the hardtop

The hardtop can only be lowered when the luggage cover is closed and the trunk lid is completely opened.

- ▶ Close the luggage cover.
- ▶ Press button ③.

The hardtop lowers. Button ③ is dimly lit.



Only close the trunk if the roof is completely lowered. Otherwise you could damage the hardtop.

If you begin to close the trunk lid before the hardtop is completely lowered, button ③ will flash and a warning will sound.

Controls in detail

Useful features

Electrical outlet



An electrical outlet is located on the right side of the trunk.

- ▶ Switch on the ignition (▷ page 36).
- ▶ Flip up cover and insert electrical plug (cigar lighter type).



The electrical outlet can be used to accommodate electrical consumers (e.g. air pump, auxiliary lamps) up to a maximum of 180 W.

Telephone*

Warning!



Never operate radio transmitters equipped with a built-in or attached antenna (i.e. without being connected to an external antenna) from inside the vehicle while the engine is running. Doing so could lead to a malfunction of the vehicle's electronic system, possibly resulting in an accident and/or serious personal injury.

Radio transmitters, such as a portable telephone or a citizens band unit, should only be used inside the vehicle if they are connected to an antenna that is installed on the outside of the vehicle.

The external antenna must be approved by Mercedes-Benz. Please contact an authorized Mercedes-Benz Center for information on the installation of an approved external antenna. Refer to the radio transmitter operation instructions regarding use of an external antenna.

Warning!





Please do not forget that your primary responsibility is to drive the vehicle. A driver's attention to the road must always be his/her primary focus when driving. For your safety and the safety of others, we recommend that you pull over to a safe location and stop before placing or taking a telephone call.

If you choose to use the telephone¹ while driving, please use the hands-free device and only use the telephone when road, weather, and traffic conditions permit. Some jurisdictions prohibit the driver from using a cellular telephone while driving a vehicle.

Only operate the COMAND (Cockpit Management and Data System)¹ if road, weather, and traffic conditions permit.

¹ Observe all legal requirements

Bear in mind that at a speed of just 30 mph (approximately 50 km/h), your vehicle is covering a distance of 44 feet (approximately 14 m) every second.

You can take and place telephone calls using the  and  buttons on the steering wheel. To carry out other telephone functions, use the control system (▷ page 161).

See separate instruction manual for instructions on how to operate the telephone.

Tele Aid



The initial activation of the Tele Aid system may only be performed by completing the subscriber agreement and placing an acquaintance call using the  button. Failure to complete either of these steps will result in a system that is not activated.

If you have any questions regarding activation, please call the Response Center at 1-800-756-9018 (in the USA) or 1-888-923-8367 (in Canada).

Controls in detail

Useful features



The Tele Aid system



(Telematic Alarm Identification on Demand)

The Tele Aid system consists of three types of response:

- automatic and manual emergency
- roadside assistance
- information

The Tele Aid system is operational providing that the vehicle's battery is charged, properly connected, not damaged and cellular and GPS coverage is available.

The speaker volume of a Tele Aid call can be adjusted when using the volume control on the multifunction steering wheel. To raise, press button  and to lower, press button  or use the volume knob on your COMAND headunit.



- ▶ To activate, press the SOS button, the Roadside Assistance button  or the Information button , depending on the type of response required.

Controls in detail

Useful features



The SOS button is located above the interior rear view mirror.



The Roadside Assistance button  and the Information button  are located below the center armrest cover.

Shortly after the completion of your Tele Aid acquaintance call, you will receive a user ID and password. By visiting www.mbusa.com and selecting “Tele Aid” (USA only), you will have access to account information, remote door unlock, and more.



The Tele Aid system utilizes the cellular network for communication and the GPS (Global Positioning System) satellites for vehicle location. If either of these signals are unavailable, the Tele Aid system may not function and if this occurs, assistance must be summoned by other means.

System self-check

Initially, after switching on the ignition, malfunctions are detected and indicated (the indicator lamps in the SOS button, the Roadside Assistance button  and the Information button  stay on longer than ten seconds or do not come on). The message `TeleAid malfunction - Visit workshop` appears for approximately ten seconds in the multifunction display.

Warning!



If the indicator lamps in the SOS button, in the Roadside Assistance button, and/or in the Information button do not come on during the system self-check, or if any of these indicators remain illuminated continuously in red and/or the message `TeleAid malfunction - Visit workshop` is displayed in the multifunction display after the system self-check, a malfunction in the system has been detected.

If a malfunction is indicated as outlined above, the system may not operate as expected. Have the system checked at the nearest Mercedes-Benz Center as soon as possible

Emergency calls

An emergency call is initiated automatically following an accident in which the emergency tensioning devices (ETDs) or airbags deploy.

An emergency call can also be initiated manually by opening the cover next to the interior rear view mirror labeled SOS, then briefly pressing the button located under the cover. See (▷ page 240) for instructions on initiating an emergency call manually.

Once the emergency call is in progress, the indicator lamp in the SOS button will begin to flash. The message `Connecting call` appears in the multifunction display and the audio system is muted. When the connection is established, the message `Call connected` appears in the multifunction display. All information relevant to the emergency, such as the location of the vehicle (determined by the GPS satellite location system), vehicle model, identification number and color are generated.

A voice connection between the Response Center and the occupants of the vehicle will be established automatically soon after the emergency call has been initiated. The Response Center will attempt to determine more precisely the nature of the emergency provided they can speak to an occupant of the vehicle.

The Tele Aid system is available if

- it has been activated and is operational
Activation requires a subscription for monitoring services, connection and cellular air time.
- the relevant cellular phone network and GPS signals are available and pass the information on to the Response Center



Location of the vehicle on a map is only possible if the vehicle is able to receive signals from the GPS satellite network and pass the information on to the Response Center.

Warning!



If the indicator lamp in the SOS button is flashing continuously and there was no voice connection to the Response Center established, then the Tele Aid system could not initiate an emergency call (e.g. the relevant cellular phone network is not available). The message `Call failed` appears in the multifunction display for approximately ten seconds.

Should this occur, assistance must be summoned by other means.

Controls in detail

Useful features

Initiating an emergency call manually



- ① Cover
- ② SOS button

- ▶ Briefly press on cover ①.
The cover opens.
- ▶ Press SOS button ② briefly.
The indicator lamp in SOS button ② will flash until the emergency call is concluded.
- ▶ Wait for a voice connection to the Response Center.
- ▶ Close cover ① after the emergency call is concluded.

Warning!



If you feel at any way in jeopardy when in the vehicle (e.g. smoke or fire in the vehicle, vehicle in a dangerous road location), please do not wait for voice contact after you have pressed the emergency button. Carefully leave the vehicle and move to a safe location. The Response Center will automatically contact local emergency officials with the vehicle's approximate location if they receive an automatic SOS signal and cannot make voice contact with the vehicle occupants.

Roadside Assistance button

The Roadside Assistance button  is located below the center armrest cover.

- ▶ Press and hold the button (for longer than two seconds)

A call to a Mercedes-Benz Roadside Assistance dispatcher will be initiated. The button will flash while the call is in progress. The message `Connecting call` will appear in the multifunction display and the audio system is muted.

When the connection is established, the message `Call connected` appears in the multifunction display. The Tele Aid system will transmit data generating the vehicle identification number, model, color and location (subject to availability of cellular and GPS signals).

Controls in detail

Useful features

A voice connection between the Roadside Assistance dispatcher and the occupants of the vehicle will be established.



- ▶ Describe the nature of the need for assistance.

The Mercedes-Benz Roadside Assistance dispatcher will either dispatch a qualified Mercedes-Benz technician or arrange to tow your vehicle to the nearest authorized Mercedes-Benz Center. For services such as labor and / or towing, charges may apply. Refer to the Roadside Assistance Manual for more information.

The following is only available in the USA:

- Sign and Drive services: Services such as jump start, a few gallons of fuel or the replacement of a flat tire with the vehicle spare tire are obtainable.



The indicator lamp in the Roadside Assistance button  remains illuminated in red for approximately ten seconds during the system self-check after switching on the ignition (together with the SOS button and the Information button .

See system self-check (> page 238) if the indicator lamp does not come on in red or stays on longer than approximately ten seconds.

If the indicator lamp in the Roadside Assistance button  is flashing continuously and there was no voice connection to the Response Center established, then the Tele Aid system could not initiate a Roadside Assistance call (e.g. the relevant cellular phone network is not available). The message *Call failed* appears in the multifunction display.

Roadside Assistance calls can be terminated using the  button on the multifunction steering wheel or the respective button for ending a telephone call on the COMAND headunit.

Controls in detail

Useful features

Information button

The Information button  is located below the center armrest cover.

- ▶ Press and hold the button (for longer than two seconds).



A call to the Customer Assistance Center will be initiated. The button will flash while the call is in progress. The message `Connecting call` will appear in the multifunction display and the audio system is muted.

When the connection is established, the message `Call connected` appears in the multifunction display. The Tele Aid system will transmit data generating the vehicle identification number, model, color and location (subject to availability of cellular and GPS signals).

A voice connection between the Customer Assistance Center representative and the occupants of the vehicle will be established. Information regarding the operation of your vehicle, the nearest Mercedes-Benz Center or Mercedes-Benz USA products and services is available to you.

For more details concerning the Tele Aid system, please visit www.mbusa.com and use your ID and password (sent to you separately) to learn more (USA only).



The indicator lamp in the Information button  remains illuminated in red for approximately ten seconds during the system self-check after switching on the ignition (together with the SOS button and the Roadside Assistance button ).

See system self-check (▷ page 238) if the indicator lamp does not come on in red or stays on longer than approximately ten seconds.

If the indicator lamp in the Information button  is flashing continuously and no voice connection to the

Controls in detail

Useful features

Response Center was established, then the Tele Aid system could not initiate an Information call (e.g. the relevant cellular phone network is not available). The message *Call failed* appears in the multifunction display.

Information calls can be terminated using the  button on the multifunction steering wheel or the respective button for ending a telephone call on the COMAND headunit.



If the indicator lamps do not start flashing after pressing one of the buttons or remain illuminated (in red) at any time, the Tele Aid system has detected a malfunction or the service is currently not active, and may not initiate a call. Visit your Mercedes-Benz Center and have the system checked or contact the Response Center at 1-800-756-9018 (in the USA) or 1-888-923-8367 (in Canada) as soon as possible.

Upgrade scenario

An emergency call is possible even if other services are active.



If the indicator lamp continues to flash or the system does not reset, contact the Response Center at 1-800-756-9018 (in the USA) or 1-888-923-8367 (in Canada), or Mercedes-Benz Customer Assistance at 1-800-FOR-MERCEdes (1-800-367-6372) in the USA or Customer Service at 1-800-387-0100 in Canada.

Controls in detail

Useful features



The indicator lamp in the respective button flashes until the call is concluded. Calls can only be terminated by a Response Center or Customer Assistance Center representative except Roadside Assistance and Information calls, which can also be terminated by pressing button  on the multifunction steering wheel or the respective button for ending a telephone call on the COMAND headunit.



When a Tele Aid call has been initiated, the COMAND system audio is muted and the selected mode (radio or CD) pauses. The optional cellular phone (if installed) switches off. If you must use this phone, the vehicle must be parked. Disconnect the coiled cord and place the call. The COMAND navigation system (if engaged) will continue to run. The display in the instrument cluster is available for use and spoken commands are only available by pressing the RPT button on the COMAND unit. A pop-up window will appear in the COMAND display to indicate that a Tele Aid call is in progress.

Remote door unlock

In case you have locked your vehicle unintentionally (e.g. SmartKey inside vehicle), and the reserve SmartKey is not handy:

- ▶ Contact the Mercedes-Benz Response Center at 1-800-756-9018 (in the USA) or 1-888-923-8367 (in Canada).

You will be asked to provide your password which you provided when you completed the subscriber agreement.

- ▶ Then return to your vehicle and pull the trunk recessed handle for a minimum of 20 seconds until the SOS button is flashing.

The message **Call connected** appears in the multifunction display.

As an alternative, you may unlock the vehicle via Internet using the ID and password sent to you shortly after the completion of your acquaintance call.

The Response Center will then unlock your vehicle with the remote door unlocking feature.



The remote door unlock feature is available if the relevant cellular phone network is available.

The SOS button will flash and the message **Call connected** will appear in the multifunction display to indicate receipt of the door unlock command.

Once the vehicle is unlocked, a Response Center specialist will attempt to establish voice contact with the vehicle occupants.

If the trunk recessed handle was pulled for more than 20 seconds before door unlock authorization was received by the Response Center, you must wait 15 minutes before pulling the trunk recessed handle again.

Stolen Vehicle Recovery services

In the event your vehicle was stolen:

- ▶ Report the incident to the police
The police will issue a numbered incident report.
- ▶ Pass this number on to the Mercedes-Benz Response Center along with your password issued to you when you subscribed to the service.

The Response Center will then attempt to covertly contact the vehicle's Tele Aid system. Once the vehicle is located, the Response Center will contact the local law enforcement and you. The vehicle's location will only be provided to law enforcement.



If the anti-theft alarm or the tow-away alarm stays on for more than 30 seconds, a call to the Response Center is initiated automatically by the Tele Aid system provided Tele Aid service was subscribed to and properly activated, and that necessary cellular service and GPS coverage are available. See anti-theft alarm system (▷ page 88) and tow away alarm (▷ page 90).

Controls in detail

Useful features

Garage door opener

The built-in remote control is capable of operating up to three separately controlled devices, for example garage door openers, gate openers, or other devices compatible with HomeLink[®] or some other systems.

You can program the signal transmitter buttons.

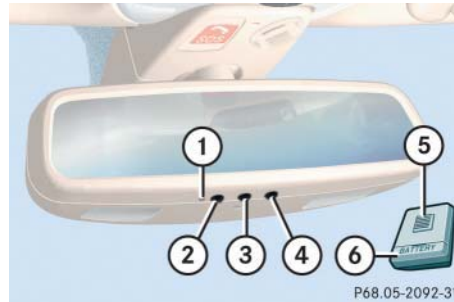

Remote control integrated into the interior rear view mirror

- ① Indicator lamp
- ② ③ ④ Signal transmitter button
- ⑤ Hand-held transmitter button
- ⑥ Hand-held remote control transmitter (not part of the vehicle equipment)

Warning!



Before programming the integrated remote control to a garage door opener or gate operator, make sure people and objects are out of the way of the device to prevent potential harm or damage. When programming a garage door opener, the door moves up or down. When programming a gate operator, the gate opens or closes.

Do not use the integrated remote control with any garage door opener that lacks safety stop and reverse features as required by U.S. federal safety standards (this includes any garage door opener model manufactured before April 1, 1982). A garage door that cannot detect an object - signaling the door to stop and reverse - does not meet current U.S. federal safety standards.

Controls in detail

Useful features



Certain types of garage door openers are incompatible with the integrated opener. If you should experience difficulties with programming the transmitter, contact an authorized Mercedes-Benz Center, or call Mercedes-Benz Customer Assistance Center (in the USA only) at 1-800-FOR-MERCEdes, or Customer Service (in Canada) at 1-800-387-0100.



USA only:
This device complies with Part 15 of the FCC Rules. Operation is subject to the following two conditions:

- (1) This device may not cause harmful interference, and
- (2) this device must accept any interference received, including interference that may cause undesired operation.

Any unauthorized modification to this device could void the user's authority to operate the equipment.



Canada only:
This device complies with RSS-210 of Industry Canada. Operation is subject to the following two conditions:

- (1) This device may not cause interference, and
- (2) this device must accept any interference received, including interference that may cause undesired operation of the device.

Any unauthorized modification to this device could void the user's authority to operate the equipment.

Controls in detail

Useful features

Programming or reprogramming the integrated remote control

Step 1:

- ▶ Switch on the ignition (▷ page 36).

Step 2:

- ▶ If you have previously programmed an integrated signal transmitter button and wish to retain its programming, proceed to step 3. Otherwise, press and hold the two outer signal transmitter buttons ② and ④ and release them only when indicator lamp ① begins to flash after approximately 20 seconds (do not hold the button for longer than 30 seconds). This procedure erases any previous settings for all three channels and initializes the memory. If you later wish to program a second and/or third hand-held transmitter to the remaining two signal transmitter buttons, do not repeat this step and begin directly with step 3.

Step 3:

- ▶ Hold the end of the hand-held remote control transmitter ⑥ of the device you wish to train approximately 2 to 5 in (5 to 12 cm) away from the surface of the integrated remote control located on the interior rear view mirror, keeping the indicator lamp ① in view.

Step 4:

- ▶ Using both hands, simultaneously press the hand-held transmitter button ⑤ and the desired integrated signal transmitter button (②, ③ or ④). Do not release the buttons until completing step 5.

The indicator lamp ① on the integrated remote control will flash, first slowly and then rapidly.

i

The indicator lamp ① flashes the first time the signal transmitter button is programmed. If this button has already been programmed, the indicator lamp will only start flashing after 20 seconds.

Step 5:

- ▶ When the indicator lamp ① flashes rapidly, release both buttons.

Step 6:

- ▶ Press and hold the just-trained integrated signal transmitter button and observe the indicator lamp ①.

If the indicator lamp ① stays on constantly, programming is complete and your device should activate when the integrated signal transmitter button is pressed and released.



If the indicator lamp ① blinks rapidly for about two seconds and then turns to a constant light, continue with programming steps 8 through 12 as your garage door opener may be equipped with the “rolling code” feature.

Step 7:

- ▶ To program the remaining two buttons, repeat the steps above starting with step 3.

Rolling code programming

To train a garage door opener (or other rolling code devices) with the rolling code feature, follow these instructions after completing the “Programming” portion (steps 1 through 6) of this text. (A second person may make the following training procedures quicker and easier.)

Step 8:

- ▶ Locate “training” button on the garage door opener motor head unit.

Exact location and color of the button may vary by garage door opener brand. Depending on manufacturer, the “training” button may also be referred to as “learn” or “smart” button. If there is difficulty locating the transmitting button, refer to the garage door opener operator’s manual.

Step 9:

- ▶ Press “training” button on the garage door opener motor head unit.

The “training light” is activated.

You have 30 seconds to initiate the following step.

Step 10:

- ▶ Firmly press, hold for two seconds and release the programmed integrated signal transmitter button (②, ③ or ④).

Step 11:

- ▶ Press, hold for two seconds and release same button a second time to complete the training process.

Some garage door openers (or other rolling code equipped devices) may require you to perform this procedure a third time to complete the training.

Step 12:

- ▶ Confirm the garage door operation by pressing the programmed integrated signal transmitter button (②, ③ or ④). >>

Controls in detail

Useful features

▷▷ Step 13:

- ▶ To program the remaining two buttons, repeat the steps above starting with step 3.

Gate operator/Canadian programming

Canadian radio-frequency laws require transmitter signals to “time-out” (or quit) after several seconds of transmission which may not be long enough for the integrated signal transmitter to pick up the signal during programming. Similar to this Canadian law, some U.S. gate operators are designed to “time-out” in the same manner.

If you live in Canada or if you are having difficulties programming a gate operator (regardless of where you live) by using the programming procedures, replace step 4 with the following:

Step 4:

- ▶ Continue to press and hold the integrated signal transmitter button (②, ③ or ④) while you press and re-press (“cycle”) your hand-held remote control transmitter (⑥) every two seconds until the frequency signal has been learned. Upon successful training, the indicator lamp (①) will flash slowly and then rapidly after several seconds.
- ▶ Proceed with programming step 5 and step 6 to complete.

Operation of integrated remote control

- ▶ Switch on ignition.
- ▶ Select and press the appropriate integrated signal transmitter button (②, ③ or ④) to activate the remote controlled device.

The integrated remote control transmitter continues to send the signal as long as the button is pressed – up to 20 seconds.

Erasing the integrated remote control memory

- ▶ Switch on ignition.
- ▶ Simultaneously hold down the signal transmitter buttons (②) and (④), for approximately 20 seconds, until the indicator lamp (①) blinks rapidly. Do not hold for longer than 30 seconds.

The codes of all three channels are erased.



If you sell your vehicle, erase the codes of all three channels.

Reprogramming a single integrated signal transmitter button

To program a device using a signal transmitter button previously trained, follow these steps:

- ▶ Press and hold the desired signal transmitter button (②, ③ or ④). Do not release the button.
- ▶ The indicator lamp will begin to flash after 20 seconds. Without releasing the integrated signal transmitter button, proceed with programming starting with step 3.



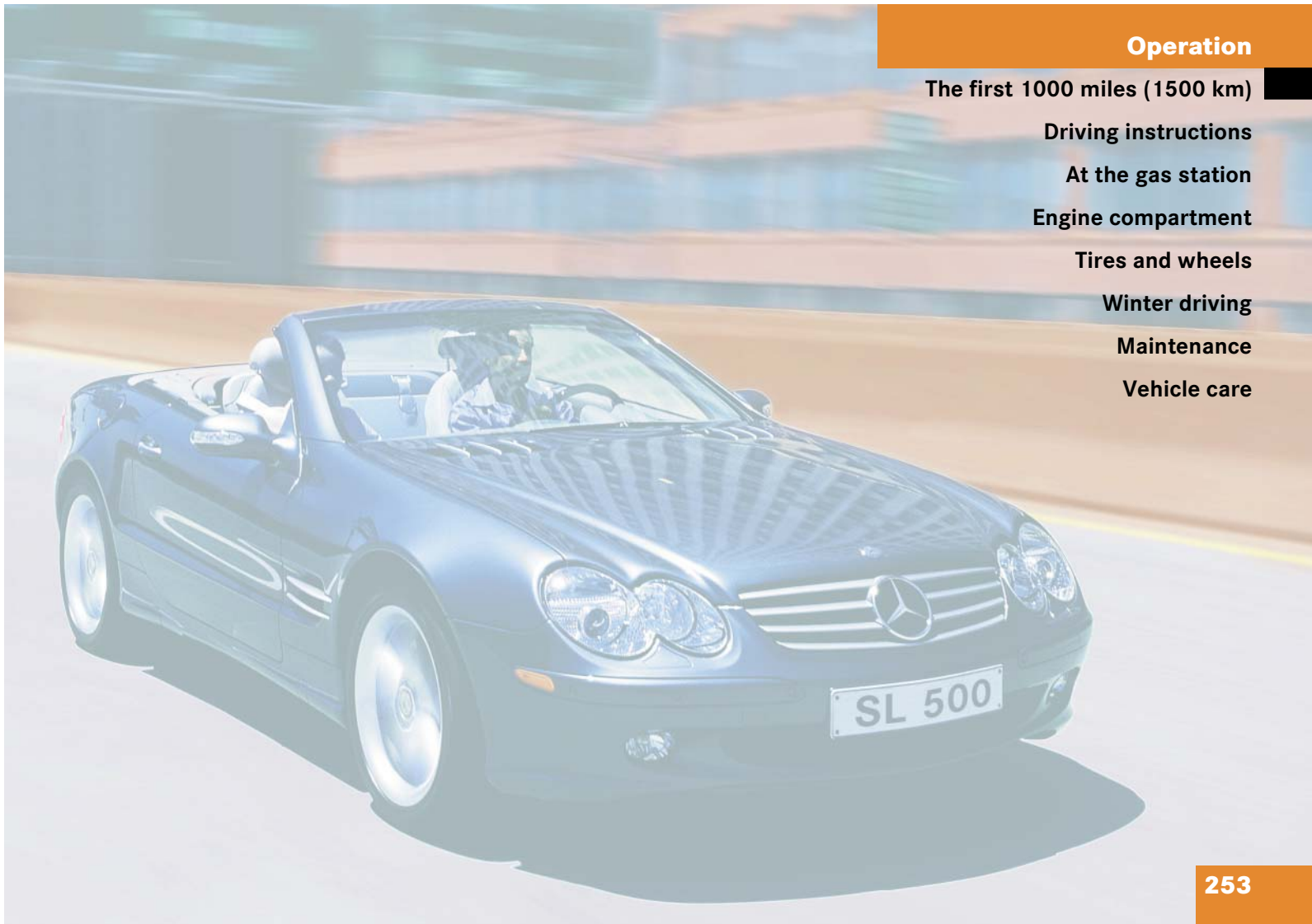

Operation

The first 1000 miles (1500 km)

Driving instructions

At the gas station

Engine compartment

Tires and wheels

Winter driving

Maintenance

Vehicle care

Operation

The first 1000 miles (1500 km)

In the “Operation” section you will find detailed information on operating, maintaining and caring for your vehicle.

The more cautiously you treat your vehicle during the break-in period, the more satisfied you will be with its performance later on.

- Drive your vehicle during the first 1000 miles (1500 km) at varying but moderate vehicle and engine speeds.
- During this period, avoid heavy loads (full throttle driving) and excessive engine speeds (no more than $\frac{2}{3}$ of maximum rpm in each gear).
- Avoid accelerating by kickdown.
- Do not attempt to slow the vehicle down by shifting to a lower gear using the gear selector lever.
- Select positions **3**, **2** or **1** only when driving at moderate speeds (for hill driving).
- Select **C** as the preferred shift program (▷ page 165) for the first 1000 miles (1500 km).

After 1000 miles (1500 km), you may gradually increase vehicle and engine speeds to the permissible maximum.



Additional instructions for AMG vehicles:

- During the first 1000 miles (1500 km), do not exceed a speed of 85 mph (140 km/h).
- During this period, avoid engine speeds above 4500 rpm (SL 55 AMG) or 4000 rpm (SL 65 AMG) in each gear.

All of the above instructions, as may apply to your vehicle type, also apply when driving the first 1000 miles (1500 km) after the engine or the rear differential has been replaced.



Always obey applicable speed limits.

▼ **Driving instructions**

Drive sensibly – save fuel

Fuel consumption, to a great extent, depends on driving habits and operating conditions.

To save fuel you should:

- Keep tires at the recommended inflation pressures.
- Remove unnecessary loads
- Allow engine to warm up under low load use.
- Avoid frequent acceleration and deceleration.
- Have all maintenance work performed at the intervals specified in the Maintenance Booklet and as required by the maintenance system. Contact an authorized Mercedes-Benz Center.

Fuel consumption is also increased by driving in cold weather, in stop-and-go traffic, on short trips and in hilly area.

Drinking and driving

Warning!



Drinking and driving and/ or taking drugs and driving are a very dangerous combination. Even a small amount of alcohol or drugs can affect your reflexes, perceptions and judgement.

The possibility of a serious or even fatal accident are greatly increased when you drink or take drugs and drive.

Do not drink or take drugs and drive or allow anyone to drive who has been drinking or taking drugs.

Pedals

Warning!



Keep driver's foot area clear at all times. Objects stored in this area may impair pedal movement.

Operation

Driving instructions

Power assistance

Warning!



The brake system requires electrical energy for operation.

A malfunction in the vehicle's power supply or electrical system may impair brake system operation and switch it into its emergency operation mode. In such a case, the red brake warning lamp (▷ page 326) and warning messages (▷ page 335) in the instrument cluster come on while driving. To brake, the driver must then apply significantly greater brake pedal pressure and depress the pedal much further to obtain the expected braking effect. If necessary, apply full pressure to the brake pedal. Brakes are only applied to the front wheels. Stopping distance is increased! If there is a malfunction in the SBC brake system, we recommend that the vehicle be transported with all wheels off the ground using flatbed or appropriate wheel lift/dolly equipment.

A tow bar must be used if circumstances do not permit the use of the recommended towing methods and the vehicle requires towing with all four wheels on the ground. Towing the vehicle with all four wheels on the ground is only permissible for distances up to 30 miles (50 km) and at a speed not to exceed 30 mph (50 km/h). For more information, see "Towing the vehicle" (▷ page 408).

With the engine not running, there is no power assistance for the brake and steering systems. In this case, it is important to keep in mind that a considerably higher degree of effort is necessary to brake and steer the vehicle.

Brakes

Warning!



After driving in heavy rain for some time without applying the brakes or through water deep enough to wet brake components, the first braking action may be somewhat reduced and increased pedal pressure may be necessary to obtain expected braking effect. Maintain a safe distance from vehicles in front.

Resting your foot on the brake pedal will cause excessive and premature wear of the brake pads.

It can also result in the brakes overheating thereby significantly reducing their effectiveness. It may not be possible to stop the vehicle in sufficient time to avoid an accident.

To help prevent brake disk corrosion after driving on wet road surfaces (particularly salted roads), it is advisable to brake the vehicle with considerable force prior to parking. The heat generated serves to dry the brakes.

If your brake system is normally only subjected to moderate loads, you should occasionally test the effectiveness of the brakes by applying above-normal braking pressure at higher speeds. This will also enhance the grip of the brake pads.



Be very careful not to endanger other road users when you apply the brakes.

Refer to the description of the Brake Assist System (BAS) (▷ page 81).

If the parking brake is released and the brake warning lamp in the instrument cluster stays on, there is a malfunction in the SBC brake system (▷ page 85) or the brake fluid level in the reservoir is too low.

Brake pad wear or a leak in the system may be the reason for low brake fluid in the reservoir.

Have the brake system inspected immediately.

All checks and service work on the brake system should be carried out by qualified technicians only. Contact an authorized Mercedes-Benz Center.

Only install brake pads and brake fluid recommended by Mercedes-Benz.

Warning!



If other than recommended brake pads are installed, or other than recommended brake fluid is used, the braking properties of the vehicle can be degraded to an extent that safe braking is substantially impaired. This could result in an accident.

Be certain to read and observe the warning notices on brake pad replacement (▷ page 86).



When driving down long and steep grades, relieve the load on the brakes by shifting into a lower gear to use the engine's braking power. This helps prevent overheating of the brakes and reduces brake pad wear.

After hard braking, it is advisable to drive on for some time, rather than immediately parking, so the air stream will cool down the brakes faster.

Operation

Driving instructions

High-performance brake system (SL 65 AMG only)

The high-performance brake system is designed to operate under the extremely high operating demands required to accommodate the performance capabilities of the vehicle. The brakes may produce a squeaking-type noise depending on the

- vehicle speed
- brake force applied
- ambient conditions, e.g. temperature and humidity

As with any brake system, the wear of individual brake system components such as brake pads or disks strongly depends on your driving style and the conditions under which you operate the vehicle. Thus, a driving style calling for high demand braking will cause your vehicle's brakes to wear more quickly.

Warning!



New vehicle brake pads and discs, and replacement brake pads and discs may take several hundred miles of driving until they provide optimum braking efficiency. Until that time, you may need to use increased brake pedal pressure while braking. Please be aware of this and adjust your driving and braking accordingly during this break-in period.

Excessive high demand braking will cause correspondingly high brake wear. Please be attentive to the brake warning lamp in the instrument cluster and brake condition messages in the multifunction display. Especially for high performance driving, it is important to maintain and have the brake system checked regularly.

Driving off

Apply the brakes to test them briefly after driving off. Perform this procedure only when the road is clear of other traffic.

Warm up the engine smoothly. Do not place full load on the engine until the operating temperature has been reached.

When starting off on a slippery surface, do not allow a drive wheel to spin for an extended period with the ESP switched off. Doing so may cause serious damage to the drivetrain which is not covered by the Mercedes-Benz Limited Warranty.



Simultaneously depressing the accelerator pedal and applying the brake reduces engine performance and causes premature brake and drivetrain wear.

Parking

Warning!



Do not park this vehicle in areas where combustible materials such as grass, hay or leaves can come into contact with the hot exhaust system, as these materials could be ignited and cause a vehicle fire.

To reduce the risk of personal injury as a result of vehicle movement, before turning off the engine and leaving the vehicle always:

- Keep right foot on brake pedal.
- Firmly depress parking brake pedal.
- Move the gear selector lever to position **P**.
- Slowly release brake pedal.

- When parked on an incline, turn front wheels towards the road curb.
- Turn the SmartKey in the starter switch to position **0** and remove the SmartKey from the starter switch, or press the start / stop button (vehicles with KEYLESS-GO*).
- Take the SmartKey or the SmartKey with KEYLESS-GO* and lock vehicle when leaving



Set the parking brake whenever parking or leaving the vehicle. In addition, move gear selector lever to position **P**. When parking on hills, turn front wheels towards the road curb.

Tires

Warning!



If you feel a sudden significant vibration or ride disturbance, or you suspect that possible damage to your vehicle has occurred, you should turn on the hazard warning flashers, carefully slow down, and drive with caution to an area which is a safe distance from the road.

Inspect the tires and the vehicle underbody for possible damage. If the vehicle or tires appear unsafe, have it towed to the nearest Mercedes-Benz Center or tire dealer for repairs.

Treadwear indicators (TWI) are required by law. These indicators are located in six places on the tread circumference and become visible at a tread depth of approximately $\frac{1}{16}$ in (1.6 mm), at which point the tire is considered worn and should be replaced.

Operation

Driving instructions

The treadwear indicator appears as a solid band across the tread.

Warning!



Although the applicable federal motor vehicle safety laws consider a tire to be worn when the treadwear indicators (TWI) become visible at approximately $\frac{1}{16}$ in (1.6 mm), we recommend that you do not allow your tires to wear down to that level. As tread depth approaches $\frac{1}{8}$ in (3 mm), the adhesion properties on a wet road are sharply reduced.

Depending upon the weather and/or road surface (conditions), the tire traction varies widely.

Specified tire inflation pressures must be maintained. This applies particularly if the tires are subjected to extreme operating conditions (e.g. high speeds, heavy loads, high ambient temperatures).

Warning!



Do not drive with a flat tire. A flat tire affects the ability to steer or brake the vehicle. You may lose control of the vehicle. Continued driving with a flat tire or driving at high speed with a flat tire will cause excessive heat build-up and possibly a fire.

Hydroplaning

Depending on the depth of the water layer on the road, hydroplaning may occur, even at low speeds and with new tires. Reduce vehicle speed, avoid track grooves in the road and apply brakes cautiously in the rain.

Tire traction

The safe speed on a wet, snow covered or icy road is always lower than on a dry road.

You should pay particular attention to the condition of the road whenever the outside temperatures are close to the freezing point.

Warning!



If ice has formed on the road, tire traction will be substantially reduced. Under such weather conditions, drive, steer and brake with extreme caution.

Mercedes-Benz recommends M+S rated radial-ply tires with a minimum tread depth of approximately $\frac{1}{6}$ in (4 mm) on all four wheels for the winter season to ensure normal balanced handling characteristics. On packed snow, they can reduce your stopping distance as compared with summer tires. Stopping distance, however, is still considerably greater than when the road is not covered with snow or ice. Exercise appropriate caution.



Avoid spinning of a drive wheel. This may cause serious damage to the drivetrain which is not covered by the Mercedes-Benz Limited Warranty.

Tire speed rating

Regardless of the tire speed rating, local speed limits should be obeyed. Use prudent driving speeds appropriate to prevailing conditions.

Warning!



Even when permitted by law, never operate a vehicle at speeds greater than the maximum speed rating of the tires.

Exceeding the maximum speed for which tires are rated can lead to sudden tire failure, causing loss of vehicle control and possibly resulting in an accident and/or personal injury and possible death, for you and for others.

Operation

Driving instructions

SL 500

SL 500 with Sport Package*

Your vehicle is factory equipped with “W”-rated tires, which have a speed rating of 168 mph (270 km/h).

An electronic speed limiter prevents your vehicle from exceeding a speed of 155 mph (250 km/h).

SL 600

SL 600 with Sport Package*

SL 65 AMG

Your vehicle is factory equipped with “Y”-rated tires, which have a speed rating of 186 mph (300 km/h).

An electronic speed limiter prevents your vehicle from exceeding a speed of 155 mph (250 km/h).

SL 55 AMG

Your vehicle is factory equipped with “Y”-rated tires, which have a speed rating of 186 mph (300 km/h).

An electronic speed limiter prevents your vehicle from exceeding a speed of 155 mph (250 km/h).



For information on tire speed rating for winter tires, see “Winter driving” (▷ page 309).

For additional general information on tire speed markings on tire sidewall, see “Tire speed rating” (▷ page 297).

Winter driving instructions

The most important rule for slippery or icy roads is to drive sensibly and to avoid abrupt acceleration, braking and steering maneuvers. Do not use the cruise control system under such conditions.

When the vehicle is in danger of skidding, move gear selector lever to position **N**. Try to keep the vehicle under control by corrective steering action.



For information on driving with snow chains, see “Snow chains” (▷ page 310).

Warning!



On slippery road surfaces, never downshift in order to obtain braking action. This could result in drive wheel slip and reduced vehicle control. Your vehicle’s ABS will not prevent this type of control loss.

Road salts and chemicals can adversely affect braking efficiency. Increased pedal force may become necessary to produce the normal brake effect.

Depressing the brake pedal periodically when traveling at length on salt-strewn roads can bring road-salt-impaired braking efficiency back to normal.

If the vehicle is parked after being driven on salt-treated roads, the braking efficiency should be tested as soon as possible after driving is resumed.

Warning



Make sure not to endanger any other road users when carrying out these braking maneuvers.

Warning!



If the vehicle becomes stuck in snow, make sure that snow is kept clear of the exhaust pipe and from around the vehicle with the engine running. Otherwise, deadly carbon monoxide (CO) gases may enter vehicle interior resulting in unconsciousness and death.

To assure sufficient fresh air ventilation, open a window slightly on the side of the vehicle not facing the wind.

Warning!



The outside temperature indicator is not designed to serve as an Ice-Warning Device and is therefore unsuitable for that purpose. Indicated temperatures just above the freezing point do not guarantee that the road surface is free of ice.

For more information, see “Winter driving” (▷ page 309).

Standing water



Do not drive through flooded areas or water of unknown depth. Before driving through water, determine its depth. Never accelerate before driving into water. The bow wave could force water into the engine and auxiliary equipment, thus damaging them.

If you must drive through standing water, drive slowly to prevent water from entering the passenger compartment or the engine compartment. Water in these areas could cause damage to electrical components or wiring of the engine or transmission, or could result in water being ingested by the engine through the air intake, causing severe internal engine damage. Any such damage is not covered by the Mercedes-Benz Limited Warranty.

Operation

Driving instructions

Passenger compartment

Warning!



Always fasten items being carried as securely as possible.

In an accident, during hard braking or sudden maneuvers, loose items will be thrown around inside the vehicle, and cause injury to vehicle occupants unless the items are securely fastened in the vehicle.

The trunk is the preferred place to carry objects.

Driving abroad

Abroad, there is an extensive Mercedes-Benz service network at your disposal. If you plan to drive into areas which are not listed in the index of your Mercedes-Benz Center directory, you should request pertinent information from an authorized Mercedes-Benz Center.

Control and operation of radio transmitters

COMAND, radio and telephone

Warning!



Please do not forget that your primary responsibility is to drive the vehicle safely. Only operate the COMAND (Cockpit Management and Data System), radio or telephone¹ if road, weather, and traffic conditions permit.

Bear in mind that at a speed of just 30 mph (approximately 50 km/h), your vehicle is covering a distance of 44 feet (approximately 14 m) every second.

¹ Observe all legal requirements.

Telephones and two-way radios

Warning!



Never operate radio transmitters equipped with a built-in or attached antenna (i.e. without being connected to an external antenna) from inside the vehicle while the engine is running. Doing so could lead to a malfunction of the vehicle's electronic system, possibly resulting in an accident and/or personal injury.

Radio transmitters, such as a portable telephone or a citizens band unit should only be used inside the vehicle if they are connected to an antenna that is installed on the outside of the vehicle.

Refer to the radio transmitter operation instructions regarding use of an external antenna.

Catalytic converter

Your Mercedes-Benz is equipped with monolithic-type catalytic converters, an important element in conjunction with the oxygen sensors to achieve substantial control of the pollutants in the exhaust emissions. Keep your vehicle in proper operating condition by following our recommended maintenance instructions as outlined in your Maintenance Booklet.



To prevent damage to the catalytic converters, only use premium unleaded gasoline in this vehicle.

Any noticeable irregularities in engine operation should be repaired promptly. Otherwise, excessive unburned fuel may reach the catalytic converter causing it to overheat and potentially start a fire.

Warning!



As with any vehicle, do not idle, park or operate this vehicle in areas where combustible materials such as grass, hay or leaves can come into contact with the hot exhaust system, as these materials could be ignited and cause a vehicle fire.

Emission control

Certain systems of the engine serve to keep the toxic components of the exhaust gases within permissible limits required by law.

These systems, of course, will function properly only when maintained strictly according to factory specifications. Any adjustments on the engine should therefore be carried out only by qualified Mercedes-Benz Center authorized technicians. Engine adjustments should not be altered in any way. Moreover, the specified service jobs must be carried out regularly according to Mercedes-Benz servicing requirements. For details refer to the Maintenance Booklet.

Operation

Driving instructions

Warning!



Inhalation of exhaust gas is hazardous to your health. All exhaust gas contains carbon monoxide, and inhaling it can cause unconsciousness and lead to death.

Do not run the engine in confined areas (such as a garage) which are not properly ventilated. If you think that exhaust gas fumes are entering the vehicle while driving, have the cause determined and corrected immediately. If you must drive under these conditions, drive only with at least one window fully open at all times.

Coolant temperature

During severe operating conditions, e.g. stop-and-go city traffic, the coolant temperature may rise close to approx. 266°F (130°C).

The engine should not be operated with the coolant temperature over 248°F (120°C). Doing so may cause serious engine damage which is not covered by the Mercedes-Benz Limited Warranty.

Warning!



- Driving when your engine is badly overheated can cause some fluids, which may have leaked into the engine compartment, to catch fire. You could be seriously burned.
- Steam from an overheated engine can cause serious burns and can occur just by opening the engine hood. Stay away from the engine if you see or hear steam coming from it. Turn off the engine, get out of the vehicle and do not stand near the vehicle until the engine has cooled down.

▼ At the gas station

Refuelling

Warning!



Gasoline is highly flammable and poisonous. It burns violently and can cause serious injury. Whenever you are around gasoline, avoid inhaling fumes and skin contact, extinguish all smoking materials. Never allow sparks, flame or smoking materials near gasoline!

The fuel filler flap is located on the right-hand side of the vehicle towards the rear. Locking/unlocking the vehicle with the SmartKey or the SmartKey with KEYLESS-GO* automatically locks/unlocks the fuel filler flap.



- ▶ Turn off the engine
 - by turning the SmartKey to position **0**. Remove the SmartKey from the starter switch.
 - by pressing the KEYLESS-GO* start/stop button. Open the driver's door (with the driver's door open, starter switch is in position **0**, same as SmartKey removed from starter switch).

Operation

At the gas station

- ▶ Open the fuel filler flap by pushing at the point indicated by the arrow. The fuel filler flap springs open.
- ▶ Turn the fuel cap to the left and hold on to it until possible pressure is released.
- ▶ Take off the cap and set it in the recess on the fuel filler flap.
- ▶ Only fill your tank until the filler nozzle unit cuts out – **do not top up or over-fill.** ▷▷

Operation

At the gas station



Warning!



Overfilling of the fuel tank may create pressure in the system which could cause a gas discharge. This could cause the gas to spray back out when removing the fuel pump nozzle, which could cause personal injury.

- ▶ Replace the fuel cap by turning it to the right.
You will hear when the fuel cap is tightened.
- ▶ Close the fuel filler flap.
You should hear the latch close shut.





Only use premium unleaded gasoline with a minimum Posted Octane Rating of 91 (average of 96 RON / 86 MON).

Information on gasoline quality can normally be found on the fuel pump.

For more information on gasoline, see “Premium unleaded gasoline” (▷ page 434) or the Factory Approved Service Pamphlet.



Leaving the engine running and the fuel cap open can cause the engine malfunction indicator lamp  (USA only) or the engine malfunction indicator lamp  (Canada only) to illuminate.

For more information, see the “Practical hints” section (▷ page 327).

Check regularly and before a long trip

For information on quantities and requirements of operating agents, see “Fuels, coolants, lubricants, etc.” (▷ page 431).

► Open the hood (▷ page 270).

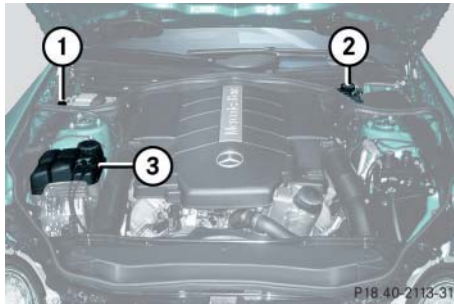

- ① Windshield washer and headlamp cleaning system
- ② Brake fluid
- ③ Coolant level

Windshield washer and headlamp cleaning system

For information on refilling the reservoir, see “Windshield washer system and headlamp cleaning system” (▷ page 278).

Brake fluid

For information on brake fluid, see “Fuels, coolants, lubricants, etc.” (▷ page 431).



If you find that the brake fluid in the brake fluid reservoir has fallen to the minimum mark or below, have the brake system checked for brake pad thickness and leaks immediately. Notify an authorized Mercedes-Benz Center immediately. Do not add brake fluid as this will not solve the problem. For more information, see the “Practical hints” section (▷ page 349).

Coolant level

For information on checking the coolant level, see “Coolant” (▷ page 276).

Engine oil level

For more information on checking the engine oil level, see “Checking engine oil level with the control system” (▷ page 272).

Vehicle lighting

Check function and cleanliness. For more information, see “Replacing bulbs” (▷ page 380).

Exterior lamp switch see “Switching on headlamps” (▷ page 51).

Tire inflation pressure

For information on checking the tire inflation pressure, see “Checking tire inflation pressure” (▷ page 290).

Operation

Engine compartment

Hood

Warning!



Do not pull the release lever while the vehicle is in motion. Otherwise the hood could be forced open by passing air flow.

Opening

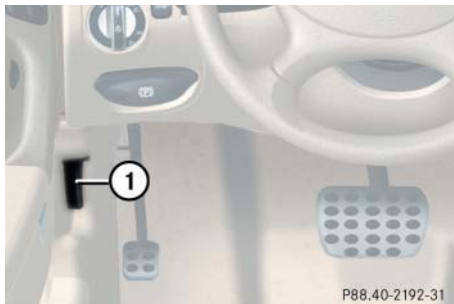

① Hood release

- ▶ Pull lever ① downwards.
The hood is unlocked.



To avoid damage to the windshield wipers or hood, never open the hood if the wiper arms are folded forward away from the windshield.



② Lever for opening the hood

- ▶ Push lever ② on the hood upwards.
- ▶ Pull up on the hood and then release it.

The hood will be automatically held open at shoulder height by gas-filled struts.

Warning!



To help prevent personal injury, stay clear of moving parts when the hood is open and the engine is running. Make sure the hood is properly closed before driving. When closing the hood, use extreme caution not to catch hands or fingers.

The radiator fan may continue to run for approximately 30 seconds or may even restart after the engine has been turned off. Stay clear of fan blades.

Operation

Engine compartment

Warning!



If you see flames or smoke coming from the engine compartment, or if the coolant temperature gauge indicates that the engine is overheated, do not open the hood. Move away from the vehicle and do not open the hood until the engine has cooled. If necessary, call the fire department.

Warning!



The engine is equipped with a transistorized ignition system. Because of the high voltage it is dangerous to touch any components (ignition coils, spark plug sockets, diagnostic socket) of the ignition system

- with the engine running
- while starting the engine
- if ignition is “on” and the engine is turned manually

Closing

Warning!



Be careful that you do not close the hood on anyone.

- ▶ Let the hood drop from a height of approximately 1¹/₂ ft (50 cm).

The hood will lock audibly.

- ▶ Check to make sure the hood is fully closed.

If you can raise the hood at a point above the headlamps, then it is not properly closed. Open it again and let it drop with somewhat greater force.

Operation

Engine compartment

Engine oil

The amount of oil your engine needs will depend on a number of factors, including driving style. Higher oil consumption can occur when

- the vehicle is new
- the vehicle is driven frequently at higher engine speeds

Engine oil consumption checks should only be made after the vehicle break-in period.



Do not use any special lubricant additives, as these may damage the drive assemblies. Using special additives not approved by Mercedes-Benz may cause damage not covered by the Mercedes-Benz Limited Warranty. More information on this subject is available at any Mercedes-Benz Center.

Checking engine oil level with the control system



When checking the oil level

- the vehicle must be parked on level ground
- with the engine at operating temperature, the vehicle must have been stationary for at least five minutes with the engine turned off
- with the engine not at operating temperature, the vehicle must have been stationary for at least 30 minutes with the engine turned off

To check the engine oil level via the multifunction display, do the following:

- ▶ Switch on the ignition (▷ page 36).

The standard display (▷ page 134) should appear in the multifunction display.

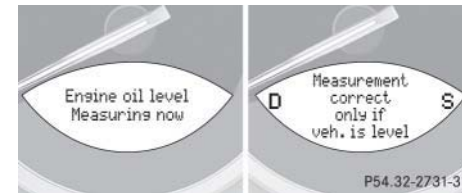

- ▶ Press button  or  on the steering wheel until the following message appears in the multifunction displays:



One of the following messages will subsequently appear in the right multi-function display:

- Engine oil level OK
- Add 1.0 qt. to reach max. oil level
(Canada: 1.0 l)
- Add 1.5 qts. to reach max. oil level
(Canada: 1.5 l)
- Add 2.0 qts. to reach max. oil level
(Canada: 2.0 l)



If you want to interrupt the checking procedure, press the  or  button on the multifunction steering wheel.

- ▶ If necessary, add engine oil.

For adding engine oil see (▷ page 274).

For more information on engine oil, see the “Technical data” section (▷ page 431) and (▷ page 433).

Other display messages

If the SmartKey or the KEYLESS-GO* start/stop button is not in position 2, the following message will appear:

Turn ignition on to measure engine oil level

- ▶ Switch on the ignition (▷ page 36).

If you see the message:

Observe waiting time

- ▶ If the engine is at operating temperature, wait five minutes before repeating the check procedure.
- ▶ If the engine is not at operating temperature yet, wait 30 minutes before repeating the check procedure.

If you see the message:

Engine oil level
Not when engine on

- ▶ Turn off the engine.
- ▶ If the engine is at operating temperature, wait five minutes before checking oil.
- ▶ If the engine is at operating temperature yet, you must wait 30 minutes before checking oil.

Operation

Engine compartment

If there is excess engine oil with the engine at normal operating temperature, the following message will appear:

Engine oil level
Reduce
oil level

- ▶ Have excess oil siphoned or drained off. Contact an authorized Mercedes-Benz Center



Excess oil must be siphoned or drained off. It could cause damage to the engine and catalytic converter not covered by the Mercedes-Benz Limited Warranty.

For more information on messages in the display concerning engine oil, see the "Practical hints" section (▷ page 355).

Adding engine oil



Only use approved engine oils and oil filters required for vehicles with Maintenance System (U.S. vehicles) or FSS (Canada vehicles). For a listing of approved engine oils and oil filters, refer to the Factory Approved Service Products pamphlet in your vehicle literature portfolio, or contact an authorized Mercedes-Benz Center.

Using engine oils and oil filters of specification other than those expressly required for the Maintenance System (U.S. vehicles) or FSS (Canada vehicles), or changing of oil and oil filter at change intervals longer than those called for by the Maintenance System (U.S. vehicles) or FSS (Canada vehicles) will result in engine damage not covered by the Mercedes-Benz Limited Warranty.



SL 500 and SL 55 AMG

① Filler cap



SL 600

① Filler cap



SL 65 AMG

① Filler cap

- ▶ Unscrew filler cap ① from filler neck.
- ▶ Add engine oil as required. Be careful not to overfill with oil.

Be careful not to spill any oil when adding. Avoid environmental damage caused by oil entering the ground or water.



Excess oil must be siphoned or drained off. It could cause damage to the engine and catalytic converter not covered by the Mercedes-Benz Limited Warranty.

- ▶ Screw filler cap ① back on filler neck.

For more information on engine oil, see the “Technical data” section (▷ page 431) and (▷ page 433).

Transmission fluid level

The transmission fluid level does not need to be checked. If you notice transmission fluid loss or gear shifting malfunctions, have an authorized Mercedes-Benz Center check the automatic transmission.

Oil level in the ABC system

The oil level in the ABC system does not need to be checked. If there is visible oil loss or if malfunction messages appear in the display, have an authorized Mercedes-Benz Center check the ABC system.

Operation

Engine compartment

Coolant

Warning!



In order to avoid any possibly serious burns:

- Use extreme caution when opening the hood if there are any signs of steam or coolant leaking from the cooling system, or if the coolant temperature gauge indicates that the coolant is overheated.
- Do not remove pressure cap on coolant reservoir if coolant temperature is above 158°F (70°C). Allow engine to cool down before removing cap. The coolant reservoir contains hot fluid and is under pressure.
- Using a rag, slowly open the cap approximately 1/2 turn to relieve excess pressure. If opened immediately, scalding hot fluid and steam will be blown out under pressure.
- Do not spill antifreeze on hot engine parts. Antifreeze contains ethylene glycol which may burn if it comes into contact with hot engine parts.

The engine coolant is a mixture of water and anticorrosion/antifreeze. To check the coolant level, the vehicle must be parked on level ground and the engine must be cool.

The coolant expansion tank is located on the passenger side of the engine compartment.

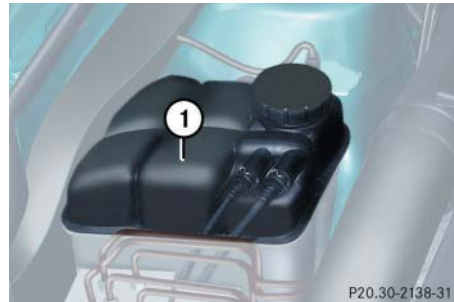

① Coolant expansion tank

- ▶ Using a rag, turn the cap slowly approximately one half turn to the left to release any excess pressure.

- ▶ Continue turning the cap to the left and remove it.

The coolant level is correct if the level

- for cold coolant: is up to the upper mark on the bracing rib of the coolant expansion tank (translucent)
 - for warm coolant: is approx. 0.6 in (1.5 cm) higher
- ▶ Add coolant as required.
 - ▶ Replace and tighten cap.



SL 600 and SL 65 AMG: Only open the cap on coolant expansion tank ①. Never open the cap between the two charge-air coolers. Otherwise, the engine could be damaged.

For more information, see “Coolants” (▷ page 435).

Battery

Your vehicle is equipped with two batteries:

- The starter battery (located in the engine compartment)
- The battery for electrical consumers (located in the trunk)

These batteries should always be sufficiently charged in order to achieve their rated service life. Refer to Maintenance Booklet for battery maintenance intervals.

If you use your vehicle mostly for short-distance trips, you will need to have the battery charge checked more frequently.

When replacing batteries, always use batteries approved by Mercedes-Benz.

If you do not intend to operate your vehicle for an extended period of time, consult an authorized Mercedes-Benz Center about steps you need to observe.

	Observe all safety instructions and precautions when handling automotive batteries.
	Risk of explosion
	Keep flames or sparks away from battery. Do not smoke.
	Battery acid is caustic. Do not allow it to come into contact with skin, eyes or clothing. In case it does, immediately flush affected area with clear water and seek medical help if necessary.
	Wear eye protection.
	Keep children away.
	Follow the instructions in this Operator's Manual.

Batteries contain materials that can harm the environment if disposed of improperly. Recycling of batteries is the preferred method of disposal. Many states require sellers of batteries to accept old batteries for recycling.

Operation

Engine compartment

Windshield washer system and headlamp cleaning system

The windshield washer reservoir is located in the engine compartment.

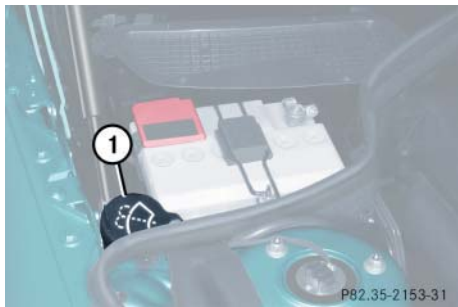

① Washer fluid reservoir

Fluid for the windshield washer system and the headlamp cleaning system is supplied from the windshield washer reservoir. It has a capacity of approx. 7.4 US qt. (7 l).

During all seasons, add MB Windshield Washer Concentrate “S” to water. Pre-mix the windshield washer fluid in a suitable container.

- ▶ Refill the reservoir with MB Windshield Washer Concentrate and water (or commercially available pre-mixed windshield washer solvent / antifreeze, depending on ambient temperatures).

Always use washer solvent/antifreeze where temperatures may fall below freezing point. Failure to do so could result in damage to the washer system/reservoir.

Warning!



Washer solvent / antifreeze is highly flammable. Do not spill washer solvent / antifreeze on hot engine parts, because it may ignite and burn. You could be seriously burned.



Only use washer fluid which is suitable for plastic lenses. Improper washer fluid can damage the plastic lenses of the headlamps.

For more information, see “Windshield and headlamp washer system” (▷ page 438).

▼ Tires and wheels

See an authorized Mercedes-Benz Center for information on tested and recommended rims and tires for summer and winter operation. They can also offer advice concerning tire service and purchase.

Warning!



Replace rims or tires with the same designation, manufacturer and type as shown on the original part. See an authorized Mercedes-Benz Center for further information. If incorrectly sized rims and tires are mounted:

- The wheel brakes or suspension components can be damaged.
- The operating clearance of the wheels and the tires may no longer be correct.

Warning!



Worn, old tires can cause accidents. If the tire tread is badly worn, or if the tires have sustained damage, replace them.

When replacing rims, only use genuine Mercedes-Benz wheel bolts specified for the particular rim type. Failure to do so can result in the bolts loosening and possibly an accident.

Retreaded tires are not tested or recommended by Mercedes-Benz, since previous damage cannot always be recognized on retreads. The operating safety of the vehicle cannot be assured when such tires are used.

See an authorized Mercedes-Benz Center for information on tested and recommended rims and tires for summer and winter operation.

Operation

Tires and wheels

Important guidelines

- Only use sets of tires and rims of the same type and make.
- Tires must be of the correct size for the rim.
- Break in new tires for approximately 60 miles (100 km) at moderate speeds.
- Regularly check the tires and rims for damage. Dented or bent rims can cause tire inflation pressure loss and damage to the tire beads.
- If vehicle is heavily loaded, check tire inflation pressure and correct as required.
- Do not allow your tires to wear down too far. Adhesion properties on wet roads are sharply reduced at tread depths under $\frac{1}{8}$ in (3 mm).
- When replacing individual tires, you should mount new tires on the front wheels first (on vehicles with same-sized wheels all around).

Operation

Tires and wheels

Tire care and maintenance

Warning!



Regularly check the tires for damage. Damaged tires can cause tire inflation pressure loss. As a result, you could lose control of your vehicle.

Worn, old tires can cause accidents. If the tire tread is badly worn, or if the tires have sustained damage, replace them.

Regularly check your tire inflation pressure at least once a month. For more information on checking tire inflation pressure see “Recommended tire inflation pressure” (▷ page 288).

Tire inspection

Every time you check your tire inflation pressure, you should also inspect your tires for the following:

- excessive tread wear (▷ page 281)
- cord or fabric showing through the tire’s rubber
- bumps, bulges, cuts, cracks or splits in the tread or side of the tire

Replace the tire if you find any of the above conditions.

Make sure you also inspect the spare tire periodically for condition and inflation. Spare tires will age and become worn over time even if never used, and thus should be inspected and replaced when necessary.

Life of tire

The service life of a tire is dependent upon varying factors including but not limited to:

- Driving style
- Tire inflation pressure
- Distance driven

Warning!



Tires and spare tire should be replaced after six years, regardless of the remaining tread.

Tread depth

Do not allow your tires to wear down too far. Adhesion properties on wet roads are sharply reduced at tread depths under $\frac{1}{8}$ in (3 mm).

Tread wear indicators (TWI) are required by law. These indicators are located in six places on the tread circumference and become visible at a tread depth of approximately $\frac{1}{16}$ in (1.6 mm), at which point the tire is considered worn and should be replaced.

Recommended minimum tire tread depth:

- Summer tires $\frac{1}{8}$ in (3 mm)
- Winter tires $\frac{1}{6}$ in (4 mm)

Warning!



Although the applicable federal motor safety laws consider a tire to be worn when the tread wear indicators (TWI) become visible at approximately $\frac{1}{16}$ in (1.6 mm), we recommend that you do not allow your tires

to wear down to that level. As tread depth approaches $\frac{1}{8}$ in (3 mm), the adhesion properties on a wet road are sharply reduced.

Depending upon the weather and/or road surface (conditions), the tire traction varies widely.

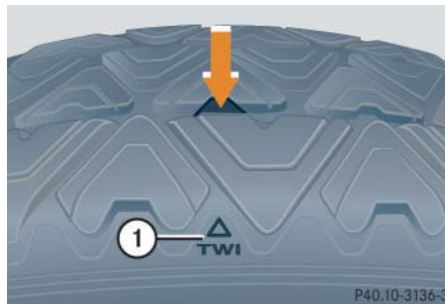

① TWI (Tread Wear Indicator)

The tread wear indicator appears as a solid band across the tread.

Storing tires



Keep unmounted tires in a cool, dry place with as little exposure to light as possible. Protect tires from contact with oil, grease and gasoline.

Cleaning tires



Never use a round nozzle to power wash tires. The intense jet of water can result in damage to the tire.

Always replace a damaged tire.

Operation

Tires and wheels

Direction of rotation

Unidirectional tires offer added advantages, such as better hydroplaning performance. To benefit, however, you must make sure the tires rotate in the direction specified.

An arrow on the sidewall indicates the intended direction of rotation (spinning) of the tire.



Spare wheels may be mounted against the direction of rotation (spinning) even with a unidirectional tire for temporary use only until the regular drive wheel has been repaired or replaced. Always observe and follow applicable temporary use restrictions and speed limitations indicated on the spare wheel.

Loading the vehicle

Two labels on your vehicle show how much weight it may properly carry.

- The Tire and Loading Information placard (Example A) or the Vehicle Tire Information placard (Example B) can be found on the driver's door B-pillar. This placard tells you important information about the number of people that can be in the vehicle and the total weight that can be carried in the vehicle. It also contains information on the proper size and recommended tire inflation pressures for the original equipment tires on your vehicle.
- The Certification label, also found on the driver's door B-pillar tells you about the gross weight capacity of your vehicle, called the Gross Vehicle Weight Rating (GVWR). The GVWR includes the weight of the vehicle, all occupants, fuel and cargo. The Certification label also tells you about the front and rear axle weight capacity, called the Gross Axle Weight Rating (GAWR). The GAWR is the total allowable weight that can be carried by a single axle (front or rear). Never exceed the GVWR or GAWR for either the front axle or rear axle.

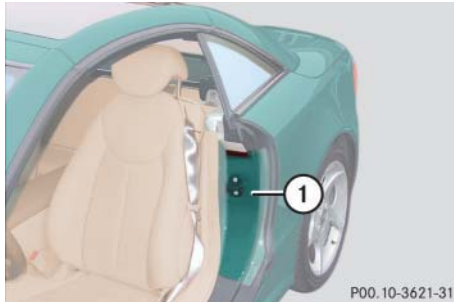

① Driver's door B-pillar

Following is a discussion on how to work with the information contained on the two placards with regards to loading your vehicle.

Tire and Loading Information

Warning!



Do not overload the tires by exceeding the specified load limit or vehicle capacity weight as indicated on the placard on the driver's door B-pillar. Overloading the tires can overheat them, possibly causing a blowout. Overloading the tires can also result in handling or steering problems, or brake failure.

Your vehicle is equipped with either the Tire and Loading Information placard (Example A) or the Vehicle Tire Information placard (Example B).



Data shown on placard examples is for illustration purposes only. Load limit data is specific to each vehicle and may vary from data shown in the illustrations below. Refer to placard on vehicle for actual data specific to your vehicle.

Placard (Example A)

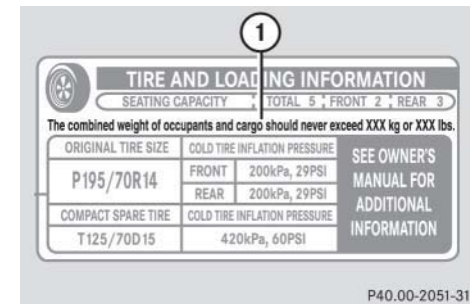

① Load limit information on the Tire and Loading Information placard

The placard showing the load limit information is located on the driver's door B-pillar. If your vehicle is equipped with the Tire and Loading Information placard (Example A), locate the statement "The combined weight of occupants and cargo should never exceed XXX kg or XXX lbs." on this placard. The combined weight of all occupants, cargo / luggage and trailer tongue load (if applicable) should never exceed the weight referenced in that statement.

Operation

Tires and wheels

Placard (Example B)

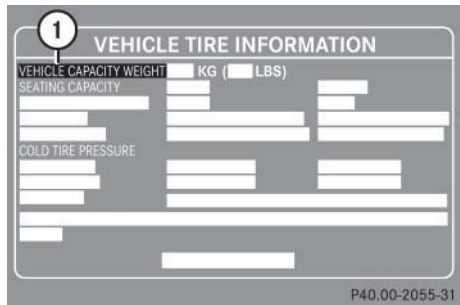

- ① Load limit information on the Vehicle Tire Information placard

The placard showing the load limit information is located on the driver's door B-pillar. If your vehicle is equipped with the Vehicle Tire Information placard (Example B), locate the heading "Vehicle Capacity Weight" on this placard. The combined weight of all occupants, cargo/luggage and trailer tongue (if applicable) should never exceed the weight listed next to vehicle capacity weight.

Seating capacity

The seating capacity gives you important information on the number of occupants that can be in the vehicle. Observe front and rear seating capacity. Your vehicle is equipped with either placard Example A or placard Example B located on the driver's door B-pillar (▷ page 283).



Data shown on placard examples is for illustration purposes only. Seating data is specific to each vehicle and may vary from data shown in the illustrations below. Refer to placard on vehicle for actual data specific to your vehicle.

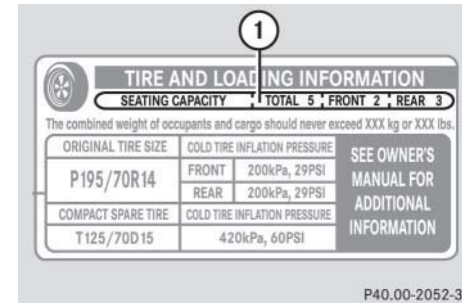

Placard (Example A)

- ① Seating capacity

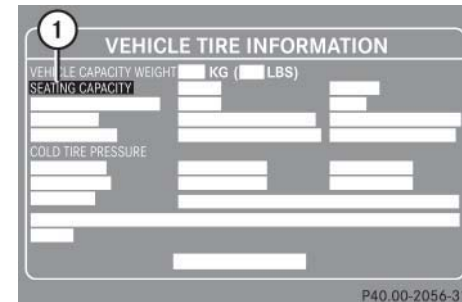

Placard (Example B)

- ① Seating capacity

Steps for determining correct load limit

The following steps have been developed as required of all manufacturers under Title 49, Code of U.S. Federal Regulations, Part 575 pursuant to the “National Traffic and Motor Vehicle Safety Act of 1966”.

Step 1 (Vehicles equipped with placard Example A)

- ▶ Locate the statement “The combined weight of occupants and cargo should never exceed XXX kg or XXX lbs.” on your vehicle’s placard.

Step 1 (Vehicles equipped with placard Example B)

- ▶ Locate the heading “Vehicle Capacity Weight” on your vehicle’s placard.

Step 2

- ▶ Determine the combined weight of the driver and passengers that will be riding in your vehicle.

Step 3

- ▶ Subtract the combined weight of the driver and passengers from XXX kilograms or XXX lbs.

Step 4

- ▶ The resulting figure equals the available amount of cargo and luggage load capacity. For example, if the “XXX” amount equals 1400 lbs. and there will be five 150 lbs. passengers in your vehicle, the amount of available cargo and luggage load capacity is 650 lbs. (1400-750 (5 x150) = 650 lbs.)

Step 5

- ▶ Determine the combined weight of luggage and cargo being loaded on the vehicle. That weight may not safely exceed the available cargo and luggage load capacity calculated in step 4.

Step 6 (if applicable)

- ▶ If your vehicle will be towing a trailer, load from your trailer will be transferred to your vehicle. Consult this manual to determine how this reduces the available cargo and luggage load capacity of your vehicle (▷ page 287).

The following table shows examples on how to calculate total and cargo load capacities with varying seating configurations and number and size of occupants. The following examples use a load limit of 1500 lbs. **This is for illustration purposes only.** Make sure you are using the actual load limit for your vehicle stated on the vehicle’s placard (▷ page 283).

Operation

Tires and wheels

Example	Combined weight limit of occupants and cargo from placard	Number of occupants (driver and passengers)	Seating configuration	Occupants weight	Combined weight of all occupants	Available cargo/luggage and trailer tongue weight (total load limit or vehicle capacity weight from placard minus combined weight of all occupants)
1	1500 lbs	5	front: 2 rear: 3	Occupant 1: 150 lbs Occupant 2: 180 lbs Occupant 3: 160 lbs Occupant 4: 140 lbs Occupant 5: 120 lbs	750 lbs	1500 lbs - 750 lbs = 750 lbs
2	1500 lbs	3	front: 1 rear: 2	Occupant 1: 200 lbs Occupant 2: 190 lbs Occupant 3: 150 lbs	540 lbs	1500 lbs - 540 lbs = 960 lbs
3	1500 lbs	1	front:1	Occupant 1: 150 lbs	150 lbs	1500 lbs - 150 lbs = 1350 lbs

The higher the weight of all occupants, the less cargo and luggage load capacity is available.

For more information, see "Trailer tongue load" (> page 287).

Certification label

Even after careful determination of the combined weight of all occupants, cargo and the trailer tongue load (if applicable) (▷ page 287) as to not exceed the permissible load limit, you must make sure that your vehicle never exceeds the Gross Vehicle Weight Rating (GVWR) and the Gross Axle Weight Rating (GAWR) for either the front or rear axle. You can obtain the GVWR and GAWR from the Certification label. The Certification Label can be found on the driver's door B-pillar, see "Technical data" (▷ page 418).

Gross Vehicle Weight Rating (GVWR): The total weight of the vehicle, all occupants, all cargo, and the trailer tongue load (▷ page 287) must never exceed the GVWR.

Gross Axle Weight Rating (GAWR): The total allowable weight that can be carried by a single axle (front or rear).

To assure that your vehicle does not exceed the maximum permissible weight limits (GVWR and GAWR for front and rear axle), have the loaded vehicle (including driver, passengers and all cargo and, if applicable, trailer fully loaded) weighed on a suitable commercial scale.

Trailer tongue load

The tongue load of any trailer is an important weight to measure because it affects the load you can carry in your vehicle. If a trailer is towed, the tongue load must be added to the weight of all occupants riding and any cargo you are carrying in the vehicle. The tongue load typically is ten percent of the trailer weight and everything loaded in it.

Your Mercedes-Benz has been designed primarily to carry passengers and their cargo. Mercedes-Benz does not recommend trailer towing with your vehicle.

Operation

Tires and wheels

Recommended tire inflation pressure

Warning!



Follow recommended tire inflation pressures.

Do not underinflate tires. Underinflated tires wear excessively and /or unevenly, adversely affect handling and fuel economy, and are more likely to fail from being overheated.

Do not overinflate tires. Overinflated tires can adversely affect handling and ride comfort, wear unevenly, increase stopping distance, and result in sudden deflation (blowout) because they are more likely to become punctured or damaged by road debris, potholes etc.

Your vehicle is equipped with either the Tire and Loading Information placard (Example A) or the Vehicle Tire Information placard (Example B) located on the driver's door B-pillar (> page 283).

The tire inflation pressure should be checked regularly and should only be adjusted on cold tires. The tires can be considered cold if the vehicle has been parked for at least three hours or driven less than one mile (1.6 km).

Follow recommended cold tire inflation pressures listed on placard.

Keeping the tires properly inflated provides the best handling, tread life and riding comfort.

In addition to the tire placard on the driver's door B-pillar, also consult the fuel filler flap for any additional information pertaining to special driving situations. For more information, see "Important notes on tire inflation pressure" (> page 289).



Data shown on placard examples is for illustration purposes only. Tire data is specific to each vehicle and may vary from data shown in the illustrations below. Refer to placard on vehicle for actual data specific to your vehicle.

Placard (Example A)

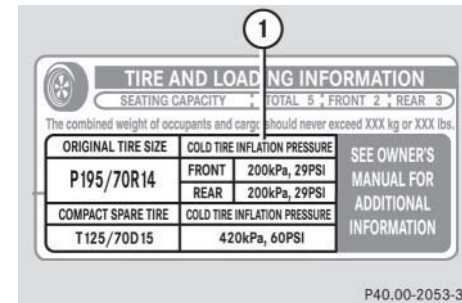

- ① Tire and Loading Information placard with recommended cold tire inflation pressures

Placard (Example A) lists the recommended cold tire inflation pressures for maximum loaded vehicle weight. The tire inflation pressures listed apply to the tires installed as original equipment.

Placard (Example B)

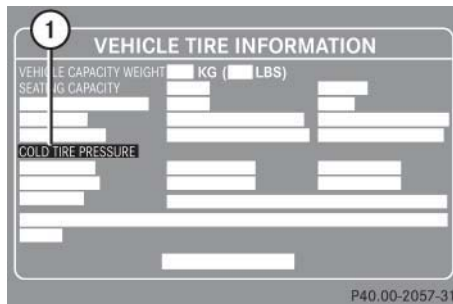

- ① Vehicle Tire Information placard with recommended cold tire inflation pressures

Placard (Example B) lists the recommended cold tire inflation pressures for maximum loaded vehicle weight. The tire inflation pressures listed apply to the tires installed as original equipment.



Placard (Example B) may list recommended cold tire inflation pressures for different vehicle loads.

Important notes on tire inflation pressure

Warning!



If the tire inflation pressure repeatedly drops:

- Check the tires for punctures from foreign objects.
- Check to see whether air is leaking from the valves or from around the rim.

Tire temperature and tire inflation pressure are also increased while driving, depending on the driving speed and the tire load.

If you will be driving your vehicle at high speeds of 100 mph (160 km/h) or higher, where it is legal and conditions allow, consult the placard on the inside of the fuel filler flap on how to adjust the cold tire inflation pressure. If you do not adjust the tire inflation pressure, excessive heat can build up and result in sudden tire failure.

Be sure to readjust the tire inflation pressure for normal driving speeds. You should wait until the tires are cold before adjusting the tire inflation pressure.

Some vehicles may have supplemental tire pressure information for vehicle loads less than the maximum loaded vehicle condition. If such information is provided, it can be found on the placard located on the inside of the fuel filler flap.

Tire inflation pressure changes by approximately 1.5 psi (0.1 bar) per 18°F (10°C) of air temperature change. Keep this in mind when checking tire inflation pressure where the temperature is different from the outside temperature.

Checking tire inflation pressure

Regularly check your tire inflation pressure at least once a month.

Check and adjust the tire inflation pressure when the tires are cold. The tires can be considered cold if the vehicle has been parked for at least three hours or driven less than one mile (1.6 km).

If you check the tire inflation pressure when the tires are warm (the vehicle has been driven for several miles or sitting less than three hours), the reading will be approximately 4 psi (0.3 bar) higher than the cold reading. This is normal. Do not let air out to match the specified cold tire inflation pressure. Otherwise, the tire will be underinflated.

Checking tire inflation pressure manually

Follow the steps below to achieve correct tire inflation pressure:

- ▶ Remove the cap from the valve on one tire.
- ▶ Firmly press a tire gauge onto the valve.
- ▶ Read tire inflation pressure on tire gauge and check against the recommended tire inflation pressure on the placard on the driver's door B-pillar (> page 288). If necessary, add air to achieve the recommended tire inflation pressure.



If you have overfilled the tire, release tire inflation pressure by pushing the metal stem of the valve with e.g. a tip of a pen. Then recheck the tire inflation pressure with the tire gauge.

- ▶ Install the valve cap.
- ▶ Repeat this procedure for each tire.

Checking tire inflation pressure electronically

The tire inflation pressure monitor only functions on wheels that are equipped with the proper electronic sensors. It monitors the tire inflation pressure, as selected by the driver, in all four tires. A warning is issued to alert you to a decrease in tire inflation pressure in one or more of the tires.

You can call up the tire inflation pressure monitoring display using the control system (> page 156).



After you have reactivated the tire inflation pressure monitor, the current tire inflation pressures will only be shown after a few minutes driving time.

During this time, you will see the following message in the display:

Tire pressure
displayed only
after driving
a few minutes



Possible differences between the readings of a tire inflation pressure gauge of an air hose, e.g. gas station equipment, and the vehicle's control system can occur. The readings issued by the control system are more precise.

- ▶ Switch on the ignition (▷ page 36).

- ▶ Press button or on the multifunction steering wheel repeatedly until the standard display menu appears in the multifunction display (▷ page 134).
- ▶ Press button or repeatedly until the current tire inflation pressures for each tire appear in the multifunction display.

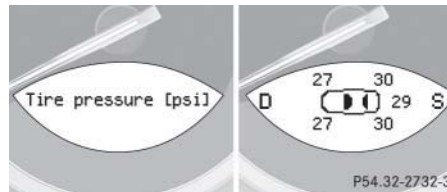

You can select the unit of measure (Bar/Psi) used for the tire inflation pressure by changing the setting in the control system (▷ page 156).

Operation

Tires and wheels

Warning!



When the tire inflation pressure monitoring system warning light is lit, one or more of your tires is significantly under-inflated. You should stop and check your tires as soon as possible, and inflate them to the proper tire inflation pressure as indicated on the vehicle's tire information placard. Driving on a significantly under-inflated tire causes the tire to overheat and can lead to tire failure. Under-inflation also reduces fuel efficiency and tire tread life, and may affect the vehicle's handling and stopping ability. Each tire, including the spare, should be checked monthly when cold and set to the recommended tire inflation pressure as specified in the vehicle placard and owner's manual.

Operation

Tires and wheels



The recommended tire inflation pressures for your vehicle can be found on the tire placard located on the driver's door B-pillar. The tire inflation pressures are not listed in the owner's manual.



Operating radio transmission equipment (e.g. wireless headsets, two-way radios) in or near the vehicle could cause the tire inflation pressure monitor to malfunction.

Warning!



The tire inflation pressure monitor does not indicate a warning for wrongly selected tire inflation pressures. Always adjust tire inflation pressure according to the placard on the driver's door B-pillar or, if available, the inside of the fuel filler flap.

The tire inflation pressure monitor is not able to issue a warning due to a sudden dramatic loss of tire inflation pressure (e.g. tire blowout caused by a foreign object). In this case bring the vehicle to a halt by carefully applying the brakes and avoiding abrupt steering maneuvers.

Warning!



Follow recommend tire inflation pressures.



Do not overinflate tires. Overinflating tires can result in sudden deflation (blowout) because they are more likely to become punctured or damaged by road debris, potholes, etc.

Do not underinflate tires. Underinflated tires wear unevenly, adversely affect handling and fuel economy, and are more likely to fail from being overheated.

Do not overload the tires by exceeding the specified load limit or vehicle capacity weight as indicated on the placard on the driver's door B-pillar. Overloading the tires can overheat them, possibly causing a blowout.

Reactivating the tire inflation pressure monitor

The tire inflation pressure monitor must be reactivated in the following situations:

- If you have changed the tire inflation pressure
 - If you have replaced the wheels or tires
 - If you have installed new wheels or tires
- ▶ Using the tire placard on the driver's door B-pillar or, if available, the inside of the fuel filler flap, make sure the tire inflation pressure of all four tires is correct.
- ▶ Press button  or  repeatedly until you see the current tire inflation pressures for each tire appear in the multifunction display or the following message appears in the multifunction display:
Tire pressure
displayed only
after driving
a few minutes



If you are transporting a deflated tire in the vehicle, do not activate the tire inflation pressure monitor until

- the deflated tire is no longer in the vehicle
 - you have inflated the tire to the correct tire inflation pressure
- ▶ Press the reset button on the instrument cluster (▷ page 24).
- The following message will appear in the multifunction display:
Monitor current
tire pressure?

- ▶ Press the  button.

The following message will appear in the multifunction display:

Tire pres. monitor
reactivated

The tire inflation pressure monitor will now monitor the tire inflation pressure values of all four tires.

The following message will appear in the multifunction display field:

Tire pressure
displayed only
after driving
a few minutes

This display appears until the individual tire inflation pressure values are matched with the tires. The individual values are then displayed (▷ page 291).

Operation

Tires and wheels

If you wish to cancel activation:

- ▶ Press the  button.

If one of the following messages appears in the multifunction display:

- Reactivate tire pressure monitor after rectifying pressure
- Tire pressure Please rectify
- ▶ Check the tire inflation pressures and correct them if necessary.
- ▶ Reactivate the tire inflation pressure monitor.

Potential problems associated with underinflated and overinflated tires

Underinflated tire inflation pressure

Underinflated tires can:

- cause excessive and uneven tire wear
- adversely affect fuel economy
- lead to tire failure from being overheated
- adversely affect handling characteristics

Warning!



Follow recommended tire inflation pressures.

Do not underinflate tires. Underinflated tires wear excessively and / or unevenly, adversely affect handling and fuel economy, and are more likely to fail from being overheated.

Overinflated tire inflation pressure

Overinflated tires can:

- adversely affect handling characteristics
- cause uneven tire wear
- be more prone to damage from road hazards
- adversely affect ride comfort
- increase stopping distance

Warning!



Follow recommended tire inflation pressures.

Do not overinflate tires. Overinflated tires can adversely affect handling and ride comfort, wear unevenly, increase stopping distance, and result in sudden deflation (blowout) because they are more likely to become punctured or damaged by road debris, potholes etc.

Tire labeling

Besides tire name (sales designation) and manufacturer name, a number of markings can be found on a tire.

Following are some explanations for the markings on your vehicle's tires:

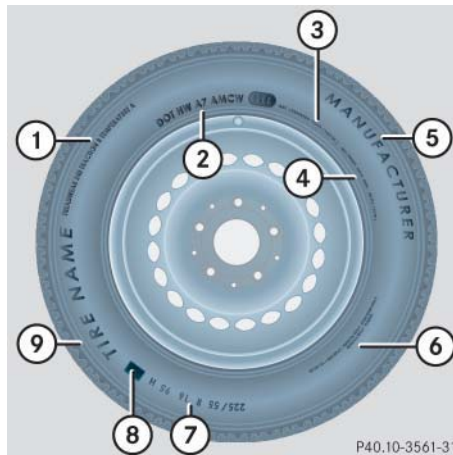

- ① Uniform Quality Grading Standards (▷ page 302)
- ② DOT, Tire Identification Number (TIN) (▷ page 300)
- ③ Maximum tire load (▷ page 301)
- ④ Maximum tire inflation pressure (▷ page 302)
- ⑤ Manufacturer
- ⑥ Tire ply material (▷ page 304)
- ⑦ Tire size designation, load and speed rating (▷ page 295)
- ⑧ Load identification (▷ page 299)
- ⑨ Tire name



For illustration purposes only. Actual data on tires is specific to each vehicle and may vary from data shown in above illustration.

For more information, see “Rims and tires” (▷ page 422).

Tire size designation, load and speed rating

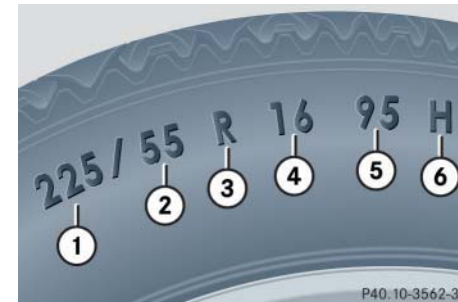

- ① Tire width
- ② Aspect ratio in %
- ③ Radial tire code
- ④ Rim diameter
- ⑤ Tire load rating
- ⑥ Tire speed rating



For illustration purposes only. Actual data on tires is specific to each vehicle and may vary from data shown in above illustration.

Operation

Tires and wheels

General:

Depending on the design standards used, the tire size molded into the sidewall may have no letter or a letter preceding the tire size designation.

No letter preceding the size designation (as illustrated above): Passenger car tire based on European design standards.

Letter "P" preceding the size designation: Passenger car tire based on U.S. design standards.

Letter "LT" preceding the size designation: Light Truck tire based on U.S. design standards.

Letter "T" preceding the size designation: Temporary spare tires which are high pressure compact spares designed for temporary emergency use only.

Tire width

The tire width ① (▷ page 295) indicates the nominal tire width in mm.

Aspect ratio

The aspect ratio ② (▷ page 295) is the dimensional relationship between tire section height and section width and is expressed in percentage. The aspect ratio is arrived at by dividing section height by section width.

Tire code

The tire code ③ (▷ page 295) indicates the tire construction type. The "R" stands for radial tire type. Letter "D" means diagonal or bias ply construction; letter "B" means belted-bias ply construction.

At the tire manufacturer's option, any tire with a speed capability above 149 mph (240 km/h) can include a "ZR" in the size designation (for example: 245/40 ZR 18). For additional information, see "Tire speed rating" (▷ page 297).

Rim diameter

The rim diameter ④ (▷ page 295) is the diameter of the bead seat, not the diameter of the rim edge. Rim diameter is indicated in inches (in).

Tire load rating

The tire load rating ⑤ (▷ page 295) is a numerical code associated with the maximum load a tire can support.

For example, a load rating of 91 corresponds to a maximum load of 1356 lbs (615 kg) the tire is designed to support. See also "Maximum tire load" (▷ page 301) where the maximum load associated with the load index is indicated in kilograms and lbs.

Warning



The tire load rating must always be at least half of the GAWR (▷ page 305) of your vehicle. Otherwise, tire failure may be the result which may cause an accident and/or serious personal injury to you or others.

Always replace rims and tires with the same designation, manufacturer and type as shown on the original part.

Warning!



Do not overload the tires by exceeding the specified load limit or vehicle capacity weight as indicated on the placard located on the driver's door B-pillar. Overloading the tires can overheat them, possibly causing a blowout. Overloading the tires can also result in handling or steering problems, or brake failure.

For additional information on tire load rating, see "Load identification" (▷ page 299).



Tire load rating ⑤ (▷ page 295) and Tire speed rating ⑥ (▷ page 295) are also referred to as "service description".

Tire speed rating

The tire speed rating ⑥ (▷ page 295) indicates the approved maximum speed for the tire.

Warning!



Even when permitted by law, never operate a vehicle at speeds greater than the maximum speed rating of the tires.

Exceeding the maximum speed for which tires are rated can lead to sudden tire failure, causing loss of vehicle control and possibly resulting in an accident and/or personal injury and possible death, for you and for others.



Tire load rating ⑤ (▷ page 295) and Tire speed rating ⑥ (▷ page 295) are also referred to as "service description".

Operation

Tires and wheels

Summer tires

Index	Speed rating
Q	up to 100 mph (160 km/h)
R	up to 106 mph (170 km/h)
S	up to 112 mph (180 km/h)
T	up to 118 mph (190 km/h)
H	up to 130 mph (210 km/h)
V	up to 149 mph (240 km/h)
W	up to 168 mph (270 km/h)
Y	up to 186 mph (300 km/h)
(Y)	above 186 mph (300 km/h)
ZR	above 149 mph (240 km/h)

- At the tire manufacturer's option, any tire with a speed capability above 149 mph (240 km/h) can include a "ZR" in the size designation (for example: 245/40 ZR18). To determine the maximum speed capability of the tire, the service description for the tire must be referred to. The service description

is comprised of the tire load rating ⑤ (▷ page 295) and the tire speed rating ⑥ (▷ page 295).

If your tire includes "ZR" in the size designation and no service description ⑤ and ⑥ (▷ page 295) is given, the tire manufacturer must be consulted for the maximum speed capability.

If a service description ⑤ and ⑥ (▷ page 295) is given, the speed capability is limited by the speed symbol in the service description.

Example: 245/40 ZR18 97Y.

In this example, "97Y" is the service description. The letter "Y" designates the speed rating and the speed capability of the tire is limited to 186 mph (300 km/h).

- Any tire with a speed capability above 186 mph (300 km/h) must include a "ZR" in the size designation AND the service description must be placed in parenthesis. Example: 275/40 ZR 18 (99Y). The "(Y)" speed rating in parenthesis designates the maximum speed capability of the tire as being above 186 mph (300 km/h). Consult the tire manufacturer for the actual maximum permissible speed of the tire.

All-season and winter tires

Index	Speed rating
Q M+S	up to 100 mph (160 km/h)
T M+S	up to 118 mph (190 km/h)
H M+S	up to 130 mph (210 km/h)
V M+S	up to 149 mph (240 km/h)



The marking “M+S” next to the service description designates tires with mud and snow capabilities.

Load identification



① Load identification



For illustration purposes only. Actual data on tires is specific to each vehicle and may vary from data shown in above illustration.

In addition to tire load rating, special load information may be molded into the tire sidewall following the letter designating the tire speed rating ① (▷ page 299).

No specification given: absence of any text (like in above example) indicates a standard load (SL) tire.

XL or Extra Load: designates an extra load (or reinforced) tire.

Light Load: designates a light load tire.

C, D, E: designates load range associated with the maximum load a tire can carry at a specified pressure.

Operation

Tires and wheels

DOT, Tire Identification Number (TIN)

U.S. tire regulations require each new tire manufacturer or tire retreader to mold a TIN into or onto a sidewall of each tire produced.

The TIN is a unique identifier which facilitates efforts by tire manufacturers to notify purchasers in recall situations or other safety matters concerning tires and gives purchasers the means to easily identify such tires.

The TIN is comprised of “Manufacturer’s identification mark”, “Tire size”, “Tire type code” and “Date of manufacture”.

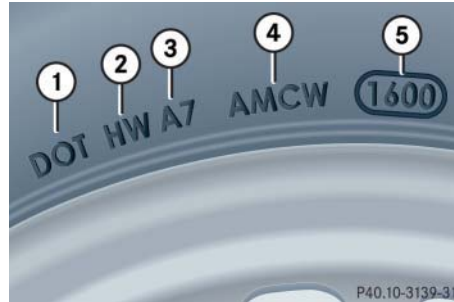

- ① DOT
- ② Manufacturer’s identification mark
- ③ Tire size
- ④ Tire type code (at the option of the tire manufacturer)
- ⑤ Date of manufacture



For illustration purposes only. Actual data on tires is specific to each vehicle and may vary from data shown in above illustration.

DOT (Department of Transportation)

A tire branding symbol ① (▷ page 300) which denotes the tire meets requirements of the U.S. Department of Transportation.

Manufacturer’s identification mark

The manufacturer’s identification mark ② (▷ page 300) denotes the tire manufacturer.

New tires have a mark with two symbols.

Retreaded tires have a mark with four symbols. For more information on retreaded tires, see (▷ page 279).

Tire size

The code ③ (▷ page 300) indicates the tire size.

Tire type code

The code ④ (▷ page 300) may, at the option of the manufacturer, be used as a descriptive code for identifying significant characteristics of the tire.

Date of manufacture

The date of manufacture ⑤ (▷ page 300) identifies the week and year of manufacture.

The first two figures identify the week, starting with “01” to represent the first full week of the calendar year. The second two figures represent the year.

For example, “3202” represents the 32nd week of 2002.

Maximum tire load



① Maximum tire load rating



For illustration purposes only. Actual data on tires is specific to each vehicle and may vary from data shown in above illustration.

The maximum tire load is the maximum weight the tires are designed to support.

Warning!



Do not overload the tires by exceeding the specified load limit or vehicle capacity weight as indicated on the placard located on the driver’s door B-pillar. Overloading the tires can overheat them, possibly causing a blowout. Overloading the tires can also result in handling or steering problems, or brake failure.

For more information on tire load rating (▷ page 296).

For information on calculating total and cargo load capacities (▷ page 285).

Operation

Tires and wheels

Maximum tire inflation pressure



- ① Maximum permissible tire inflation pressure



For illustration purposes only. Actual data on tires is specific to each vehicle and may vary from data shown in above illustration.

This is the maximum permissible tire inflation pressure for the tire.

Always follow the recommended tire inflation pressure (▷ page 288) for proper tire inflation.

Warning!



Never exceed the max. tire inflation pressure. Follow recommended tire inflation pressures.

Do not underinflate tires. Underinflated tires wear excessively and / or unevenly, adversely affect handling and fuel economy, and are more likely to fail from being overheated.

Do not overinflate tires. Overinflated tires can adversely affect handling and ride comfort, wear unevenly, increase stopping distance, and result in sudden deflation (blowout) because they are more likely to become punctured or damaged by road debris, potholes etc.

Uniform Tire Quality Grading Standards (U.S. vehicles)

Tire manufacturers are required to grade tires based on three performance factors: treadwear, traction and temperature resistance.

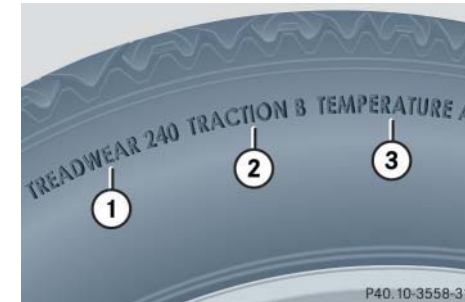

- ① Treadwear
- ② Traction
- ③ Temperature resistance



For illustration purposes only. Actual data on tires is specific to each vehicle and may vary from data shown in above illustration.

Quality grades can be found, where applicable, on the tire sidewall between tread shoulder and maximum section width. For example:

Treadwear	Traction	Temperature
200	AA	A

All passenger car tires must conform to federal safety requirements in addition to these grades.

Treadwear

The treadwear grade is a comparative rating based on the wear rate of the tire when tested under controlled conditions on a specified government test course. For example, a tire graded 150 would wear one and one-half (1 1/2) times as well on the government course as a tire graded 100. The relative performance of tires depends upon the actual conditions of their use, however, and may depart significantly from the norm due to variations in driving habits, service practices and differences in road characteristics and climate.

Traction

The traction grades, from highest to lowest, are AA, A, B, and C. Those grades represent the tire’s ability to stop on wet pavement as measured under controlled conditions on specified government test surfaces of asphalt and concrete. A tire marked C may have poor traction performance.

Warning!



The traction grade assigned to this tire is based on straight-ahead braking traction tests, and does not include acceleration, cornering, hydroplaning, or peak traction characteristics.

Operation

Tires and wheels

Temperature

The temperature grades are A (the highest), B, and C, representing the tire's resistance to the generation of heat and its ability to dissipate heat when tested under controlled conditions on a specified indoor laboratory test wheel. Sustained high temperature can cause the material of the tire to degenerate and reduce tire life, and excessive temperature can lead to sudden tire failure. The grade C corresponds to a level of performance which all passenger car tires must meet under the Federal Motor Vehicle Safety Standard No. 109. Grades B and A represent higher levels of performance on the laboratory test wheel than the minimum required by law.

Warning!



The temperature grade for this tire is established for a tire that is properly inflated and not overloaded. Excessive speed, underinflation, or excessive loading, either separately or in combination, can cause excessive heat build-up and possible tire failure.

Tire ply material

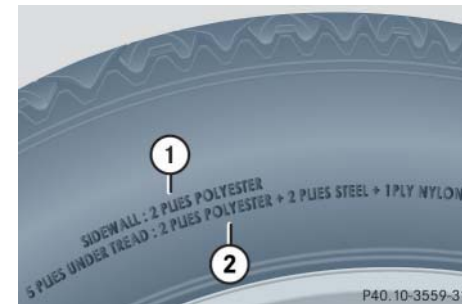

- ① Plies in sidewall
- ② Plies under tread



For illustration purposes only. Actual data on tires is specific to each vehicle and may vary from data shown in above illustration.

This marking tells you about the type of cord and number of plies in the sidewall and under the tread.

Tire and loading terminology

Accessory weight

The combined weight (in excess of those standard items which may be replaced) of automatic transmission, power steering, power brakes, power windows, power seats, radio, and heater, to the extent that these items are available as factory-installed equipment (whether installed or not).

Air pressure

The amount of air inside the tire pressing outward on each square inch of the tire. Air pressure is expressed in pounds per square inch (psi), or kilopascal (kPa) or bars.

Aspect ratio

Dimensional relationship between tire section height and section width expressed in percentage.

Bar

Another metric unit for air pressure. There are 14.5038 pounds per square inch (psi) to 1 bar; there are 100 kilopascals (kPa) to 1 bar.

Bead

The tire bead contains steel wires wrapped by steel cords that hold the tire onto the rim.

Cold tire inflation pressure

Tire inflation pressure when your vehicle has been sitting for at least three hours or driven no more than one mile (1.6 km).

Curb weight

The weight of a motor vehicle with standard equipment including the maximum capacity of fuel, oil, and coolant, and, if so equipped, air conditioning and additional optional equipment, but without passengers and cargo.

DOT (Department of Transportation)

A tire branding symbol which denotes the tire meets requirements of the U.S. Department of Transportation.

GAWR (Gross Axle Weight Rating)

The GAWR is the maximum permissible axle weight. The gross vehicle weight on each axle must never exceed the GAWR for the front and rear axle indicated on the certification label located on the driver's door B-pillar.

GVW (Gross Vehicle Weight)

The GVW comprises the weight of the vehicle including fuel, tools, spare wheel, installed accessories, passengers and cargo and, if applicable, trailer tongue load. The GVW must never exceed the GVWR indicated on the certification label located on the driver's door B-pillar.

Operation

Tires and wheels

GVWR (Gross Vehicle Weight Rating)

This is the maximum permissible vehicle weight of the fully loaded vehicle (weight of the vehicle including all options, passengers, fuel, and cargo and, if applicable, trailer tongue load). It is indicated on certification label located on the driver's door B-pillar.

Kilopascal (kPa)

The metric unit for air pressure. There are 6.9 kPa to one psi; another metric unit for air pressure is bars. There are 100 kilopascals (kPa) to one bar.

Maximum load rating

The maximum load in kilograms and pounds that can be carried by the tire.

Maximum loaded vehicle weight

The sum of curb weight, accessory weight, vehicle capacity weight and production options weight.

Maximum tire inflation pressure

This number is the greatest amount of air pressure that should ever be put in the tire under normal driving conditions.

Normal occupant weight

The number of occupants the vehicle is designed to seat, multiplied by 68 kilograms (150 lbs).

Occupant distribution

The distribution of occupants in a vehicle at their designated seating positions.

Production options weight

The combined weight of those installed regular production options weighing over 5 lbs (2.3 kilograms) in excess of those standard items which they replace, not previously considered in curb weight or accessory weight, including heavy duty brakes, ride levelers, roof rack, heavy duty battery, and special trim.

PSI (Pounds per square inch)

A standard unit of measure for air pressure -> bar, kilopascal (kPa).

Recommended tire inflation pressure

Recommended tire inflation pressure listed on placard located on driver's door B-pillar for normal driving conditions. Provides best handling, tread life and riding comfort.

Rim

A metal support for a tire or a tire and tube assembly upon which the tire beads are seated.

Sidewall

The portion of a tire between the tread and the bead.

TIN (Tire Identification Number)

Unique identifier which facilitates efforts by tire manufacturers to notify purchasers in recall situations or other safety matters concerning tires and gives purchasers the means to easily identify such tires. The TIN is comprised of "Manufacturer's identification mark", "Tire size", "Tire type code" and "Date of manufacture".

Tire load rating

Numerical code associated with the maximum load a tire can support.

Tire ply composition and material used

This indicates the number of plies or the number of layers of rubber-coated fabric in the tire tread and sidewall. Tire manufacturers also must indicate the ply materials in the tire and sidewall, which include steel, nylon, polyester, and others.

Tire speed rating

Part of tire designation; indicates the speed range for which a tire is approved.

Traction

Force exerted by the vehicle on the road via the tires. The amount of grip provided.

Tread

The portion of a tire that comes into contact with the road.

Treadwear indicators

Narrow bands, sometimes called "wear bars" that show across the tread of a tire when only $\frac{1}{6}$ in (1.6 mm) of tread remains.

Uniform Tire Quality Grading Standards

A tire information system that provides consumers with ratings for a tire's traction, temperature and treadwear. Ratings are determined by tire manufacturers using government testing procedures. The ratings are molded into the sidewall of the tire.

Vehicle capacity weight

Rated cargo and luggage load plus 68 kilograms (150 lbs) times the vehicle's designated seating capacity.

Vehicle maximum load on the tire

Load on an individual tire that is determined by distributing to each axle its share of the maximum loaded vehicle weight and dividing it by two.

Operation

Tires and wheels

Rotating tires

Warning!



Rotate front and rear wheels only if the tires are of the same dimension.

If your vehicle is equipped with mixed-size tires (different tire dimensions front vs. rear), tire rotation is not possible.

Tire rotation can be performed on vehicles with tires of the same dimension all around. If your vehicle is equipped with tires of the same dimension all around, tires can be rotated, observing a front-to-rear rotation pattern that will maintain the intended rotation (spinning) direction of the tire (▷ page 282).

In some cases, such as when your vehicle is equipped with mixed-size tires (different tire dimension front vs. rear), tire rotation is not possible.

If applicable to your vehicle's tire configuration, tires can be rotated according to the tire manufacturer's recommended intervals in the tire manufacturer's warranty pamphlet located in your vehicle literature portfolio. If none is available, tires should be rotated every 3000 to 6000 miles (5000 to 10000 km), or sooner if necessary, according to the degree of tire wear. The same rotation (spinning) direction must be maintained (▷ page 282).

Rotate tires before the characteristic tire wear pattern becomes visible (shoulder wear on front tires and tread center wear on rear tires).

Thoroughly clean the mounting face of wheels and brake disks, i.e. the inner side of the wheels/tires, during each rotation. Check for and ensure proper tire inflation pressure.

Warning!



Have the tightening torque checked after changing a wheel. Wheels could become loose if not tightened with a torque of 96 lb-ft (130 Nm).

Only use genuine Mercedes-Benz wheel bolts specified for your vehicle's rims.

For information on wheel change, see the "Practical hints" section (▷ page 372) and (▷ page 388).

▼ Winter driving

Before the onset of winter, have your vehicle winterized at an authorized Mercedes-Benz Center. This service includes:

- Check of anticorrosion and antifreeze concentration.
- Addition of cleaning concentrate to the water of the windshield and headlamp cleaning system. Add MB Concentrate "S" to a pre-mixed windshield washer solvent / antifreeze which is formulated for temperatures below freezing point (▷ page 437).
- Battery test. Battery capacity drops with decreasing ambient temperature. A well charged battery helps to ensure that the engine can be started and the SBC brake system will be fully operational even at low ambient temperatures.
- Tire change. Mercedes-Benz recommends M+S rated radial-ply tires with a minimum tread depth of approximately $\frac{1}{6}$ in (4 mm) on all four wheels for the winter season.



When scraping ice or snow from the rear window, be careful not to damage the sealing strip or apertures along the side of the window.

Operation

Winter driving

Winter tires

Always use winter tires at temperatures below 45°F (7°C) and whenever wintry road conditions prevail. Use of winter tires is the only way to achieve the maximum effectiveness of the ABS and ESP in winter operation.

For safe handling, make sure all winter tires mounted are of the same make and have the same tread design.

Warning!



Winter tires with a tread depth of less than $\frac{1}{6}$ in (4 mm) must be replaced. They are no longer suitable for winter operation.

Operation

Winter driving

Always observe the speed rating of the winter tires installed on your vehicle. If the maximum speed for which your tires are rated is below the speed rating of your vehicle, you must place a notice to this effect where it will be seen by the driver. Such notices are available at your tire dealer or any authorized Mercedes-Benz Center.

Warning!



If you use your spare tire when winter tires are fitted on the other wheels, be aware that the difference in tire characteristics may very well impair turning stability and that overall driving stability may be reduced. Adapt your driving style accordingly.

Have the spare tire replaced with a winter tire at the nearest authorized Mercedes-Benz Center.

Block heater (Canada only)

The engine is equipped with a block heater.

The electrical cable may be installed at an authorized Mercedes-Benz Center.



Block heater not available for SL 55 AMG and SL 65 AMG.

Snow chains



When driving with snow chains, always select setting 1 of the level control system (▷ page 221). Other settings may result in damage to your vehicle.

Snow chains should only be driven on snow-covered roads at speeds not to exceed 30 mph (50 km/h). Remove chains as soon as possible when driving on roads without snow.



When driving with snow chains, you may wish to deactivate the ESP (▷ page 83) before setting the vehicle in motion. This will improve the vehicle's traction.

Please observe the following guidelines when using snow chains:

- Use of snow chains is not permissible with all wheel/tire combinations.
- Snow chains should only be used on the rear wheels. Follow the manufacturer's mounting instructions.
- Only use snow chains that are approved by Mercedes-Benz. Your authorized Mercedes-Benz Center will be glad to advise you on this subject.
- Use of snow chains may be prohibited depending on location. Always check local and state laws before installing snow chains.



Use of snow chains is not permissible with the spare wheel and with tire size

- 255/35 R19
- 255/35 ZR19
- 285 / 30 ZR19
- 285 / 35 R18
- 285 / 35 ZR18

Operation

Maintenance

We strongly recommend that you have your vehicle serviced by an authorized Mercedes-Benz Center, in accordance with the Maintenance Booklet at the times called for by the maintenance service indicator display.

Failure to have the vehicle maintained in accordance with the Maintenance Booklet and the maintenance service indicator at the designated times /mileage may result in vehicle damage not covered by the Mercedes-Benz Limited Warranty.

The maintenance service indicator will notify you when your next maintenance service is due.

Starting approximately one month before your next maintenance service is due, one of the following messages will appear in the multifunction display while you are driving or when you switch on the ignition (example service A):

Service A in xx days
Service A in xx miles (km)
Service A Due now

The type of service due is indicated in the left multifunction display:



Basic service (A)



Extended service (B)



Vehicles equipped with FSS (Flexible Service System) only (Canada vehicles):

The interval between services depends on your driving habits. A gentle driving style, moderate engine speeds and the avoidance of short-distance trips will lengthen the interval between services.

Clearing the maintenance service indicator

The maintenance service indicator is automatically cleared after approximately 30 seconds. You can also clear it yourself.

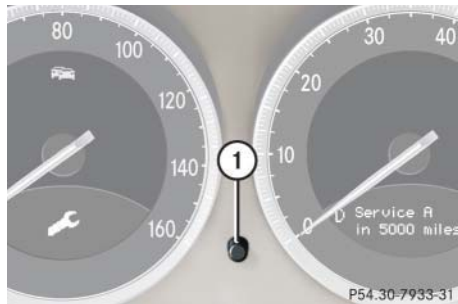

① Reset button

- ▶ Press reset button ① on the instrument cluster.

The maintenance service indicator is cleared and the standard display appears in the multifunction display.

Maintenance service term exceeded

If you have exceeded the suggested service term, you will see the following message in the right multifunction display:

Service A exceeded by xx days
Service A exceeded by xx miles (km)





In addition, a signal sounds when the message appears.

Any authorized Mercedes-Benz Center will reset the maintenance service indicator following a completed maintenance service.

Calling up the maintenance service indicator

- ▶ Switch on the ignition (▷ page 36).

The standard display of the control system appears (▷ page 134).

- ▶ Press button  or  on the multifunction steering wheel until the maintenance service indicator symbol  or  appears in the left multifunction display and the service deadline appears in the right multifunction display. ▷▷



If the battery supplying the vehicle's electrical consumers is disconnected, the days of disconnection will not be included in the count shown by the service indicator. To arrive at the true service deadline, you will need to subtract these days from the days shown in the service indicator.

Do not confuse the service indicator with the engine oil level indicator .

Resetting the maintenance service indicator

In the event that the maintenance service on your vehicle is not carried out by an authorized Mercedes-Benz Center, you can have the maintenance service indicator reset. The automotive maintenance facility carrying out the maintenance service will find the information for resetting the maintenance service indicator in the maintenance-relevant information for your vehicle. Such information is available either from an authorized Mercedes-Benz Center or directly from Mercedes-Benz.



If the maintenance service indicator was inadvertently reset, have an authorized Mercedes-Benz Center correct it.

Only reset if the proper service has been performed. Resetting the system without performing proper service as called for by the maintenance service indicator will result in engine damage not covered by the Mercedes-Benz Limited Warranty.

▼ Vehicle care

Cleaning and care of the vehicle

Warning!



Many cleaning products can be hazardous. Some are poisonous, others are flammable. Always follow the instructions on the particular container. Always open your vehicle's doors or windows when cleaning the inside. Never use fluids or solvents that are not designed for cleaning your vehicle.

While in operation, even while parked, your vehicle is subjected to varying external influences which, if gone unchecked, can attack the paintwork as well as the underbody and cause lasting damage.

Such damage is caused not only by extreme and varying climatic conditions, but also by:

- Air pollution
- Road salt
- Tar
- Gravel and stone chipping

To avoid paint damage, you should immediately remove:

- Grease and oil
- Fuel
- Coolant
- Brake fluid
- Bird droppings
- Insects
- Tree resins, etc.

Frequent washing reduces and /or eliminates the aggressiveness and potency of the above adverse influences.

More frequent washings are necessary to deal with unfavorable conditions:

- near the ocean
- in industrial areas (smoke, exhaust emissions)
- during winter operation

You should check your vehicle from time to time for stone chipping or other damage. Any damage should be repaired as soon as possible to prevent corrosion.

In doing so, do not neglect the underbody of the vehicle. A prerequisite for a thorough check is a washing of the underbody followed by a thorough inspection. Damaged areas need to be re-undercoated.

Your vehicle has been treated at the factory with a wax-base rustproofing in the body cavities which will last for the lifetime of the vehicle. Post-production treatment is neither necessary nor recommended by Mercedes-Benz because of the possibility of incompatibility between materials used in the production process and others applied later.

Operation

Vehicle care

We have selected car-care products and compiled recommendations which are specially matched to our vehicles and which always reflect the latest technology. You can obtain Mercedes-Benz approved car-care products at an authorized Mercedes-Benz Center.

Scratches, corrosive deposits, corrosion or damage due to negligent or incorrect care cannot always be removed or repaired with the car-care products recommended here. In such cases it is best to seek aid at an authorized Mercedes-Benz Center.

The following topics deal with the cleaning and care of your vehicle and give important "how-to" information as well as references to Mercedes-Benz approved car-care products.

Power washer

When using a power washer for cleaning the vehicle, always observe manufacturer's operating instructions.



Vehicles with KEYLESS-GO*:

If a door handle is hit by a strong jet of water, and a SmartKey with KEYLESS-GO* is in close proximity, i.e. within approximately 3 ft (1 m), the vehicle could be inadvertently locked or unlocked.



Never use a round nozzle to power-wash tires. The intense jet of water can result in damage to the tire.

Always replace a damaged tire.

Always keep the jet of water moving across the surface. Do not aim directly at electrical parts, electrical connectors, seals, or other rubber parts.

Tar stains

Quickly remove tar stains before they dry and become more difficult to remove. A tar remover is recommended.

Paintwork, painted body components

Mercedes-Benz approved Paint Care should be applied when water drops on the paint surface do not "bead up", normally every three to five months, depending on climate and washing detergent used.

Mercedes-Benz approved Paint Cleaner should be applied if the paint surface shows signs of embedded dirt (i.e. loss of gloss).

Do not apply any of these products or wax if your vehicle is parked in the sun or if the hood is still hot.

Use the appropriate MB-Touch-Up Stick for quick and provisional repairs of minor paint damage (i.e. chips from stones, vehicle doors, etc.).

Engine cleaning

Prior to cleaning the engine compartment, make sure to protect electrical components and connectors from contact with water and cleaning agents.

Corrosion protection, such as MB Anticorrosion Wax, should be applied to the engine compartment after every engine cleaning. Before applying, all control linkage bushings and joints should be lubricated. The poly-V-belt and all pulleys should be protected from any wax.

Vehicle washing

Do not use hot water or wash your vehicle in direct sunlight. Only use a mild car wash detergent, such as Mercedes-Benz approved Car Shampoo.

Thoroughly spray the vehicle with a diffused jet of water. Direct only a very weak spray towards the ventilation intake. Use plenty of water and rinse the sponge and chamois frequently.

Rinse with clear water and thoroughly dry with a chamois. Do not allow cleaning agents to dry on the finish.

Due to the width of the vehicle, fold in exterior rear view mirrors prior to running the vehicle through an automatic car wash to prevent damage to the mirrors.

In the winter, thoroughly remove all traces of road salt as soon as possible.

When washing the underbody, do not forget to clean the inner sides of the wheels.



Vehicles with KEYLESS-GO*:

If a door handle is hit by a strong jet of water, and a SmartKey with KEYLESS-GO* is in close proximity, i.e. within approximately 3 ft (1 m), the vehicle could be inadvertently locked or unlocked.

Ornamental moldings

For regular cleaning and care of very dirty chrome-plated parts, use a chrome cleaner.

Headlamps, side markers, tail lamps, turn signal lenses

Use a mild car wash detergent, such as Mercedes-Benz approved Car Shampoo, with plenty of water.

To prevent scratches, never apply strong force and only use a soft, non-scratchy cloth when cleaning the lenses. Do not attempt to wipe dirty lenses with a dry cloth or sponge.

Operation

Vehicle care

Cleaning the DISTRONIC* system sensor cover



① DISTRONIC* system sensor cover

- ▶ Use a mild car wash detergent, such as Mercedes-Benz approved Car Shampoo, with plenty of water to clean sensor cover ①.

To prevent scratches, never apply strong force and use only a soft, non-scratchy cloth when cleaning the sensor cover. Do not attempt to wipe dirty sensors with a dry cloth or sponge.

Cleaning the Parktronic system* sensors

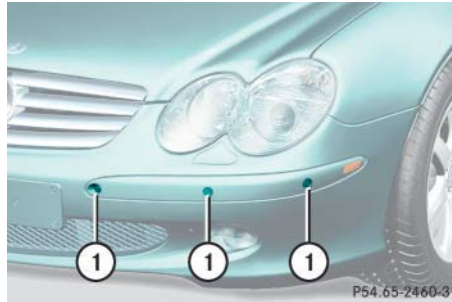

① Parktronic system* sensors in front bumper

- ▶ Clean sensors ① on the bumpers using a mild car wash detergent, such as Mercedes-Benz approved Car Shampoo, with plenty of water and a soft, non-scratchy cloth.

When using a steam cleaner or power washer, aim nozzle only briefly from a minimum distance of 12 in (30 cm) at sensors ①.



Do not apply strong pressure to the sensor covers. Applying strong pressure may damage the sensor covers.



To prevent scratches, never apply strong force and only use a soft, non-scratchy cloth when cleaning the sensors. Do not attempt to wipe dirty sensors with a dry cloth or sponge.

Wiper blades



The windshield wipers must be in a vertical position before folding them away from the windshield. They could otherwise damage the hood.

- ▶ Turn on the wipers and place them in a vertical position.

For information on how to position the wipers in a vertical position, see "Replacing wiper blades" (▷ page 386).

Warning!



For safety reasons, switch off wipers and remove SmartKey from starter switch (vehicles with KEYLESS-GO*: Make sure the vehicle's on-board electronics have status **0**) before cleaning the wiper blades. Otherwise the wiper motor could suddenly turn on and cause injury.

- Clean the wiper blade inserts with a clean cloth and detergent solution.



Fold the windshield wiper arms back onto the windshield before turning the SmartKey in the starter switch.

Hold on to the wiper when folding the wiper arm back. If released, the force of the impact from the tensioning spring could crack the windshield.

Window cleaning



The windshield wipers must be in a vertical position before folding them away from the windshield. They could otherwise damage the hood.

- Turn on the wipers and place them in a vertical position.

For information how to position the wipers in a vertical position, see "Replacing wiper blades" (▷ page 386).

Warning!



For safety reasons, switch off wipers and remove SmartKey from starter switch (vehicles with KEYLESS-GO*: Make sure the vehicle's on-board electronics have status **0**) before cleaning the windshield. Otherwise the wiper motor could suddenly turn on and cause injury.

- Use a window cleaning solution on all glass surfaces.

An automotive glass cleaner is recommended.



Fold the windshield wiper arm back onto the windshield before turning the SmartKey in the starter switch.

Hold on to the wiper when folding the wiper arm back. If released, the force of the impact from the tensioning spring could crack the windshield.

Operation

Vehicle care

Light alloy wheels

Mercedes-Benz approved Wheel Care should be used for regular cleaning of the light alloy wheels.

If possible, clean wheels once a week with Mercedes-Benz approved Wheel Care, using a soft bristle brush and a strong spray of water.

Follow the instructions on container.



Only use acid-free cleaning materials. Acid may cause corrosion or damage to the clear coat.

Instrument cluster

Use a gentle dishwashing detergent or mild detergent for delicate fabrics as a washing solution. Wipe with a cloth moistened in lukewarm solution. Do not use scouring agents.

Steering wheel and gear selector lever

Wipe with a damp cloth and dry thoroughly or clean with Mercedes-Benz approved Leather Care.

Cup holder

Use a gentle dishwashing detergent or mild detergent for delicate fabrics as a washing solution. Wipe with a cloth moistened in lukewarm solution. Do not use scouring agents.

Hard plastic trim items

Pour Mercedes-Benz approved Interior Care onto soft lint-free cloth and apply with light pressure.

Headliner

Clean with soft bristle brush, or use a dry-shampoo cleaner in case of excessive dirt.

Seat belts

The webbing must not be treated with chemical cleaning agents. Use only clear, lukewarm water and soap. Do not dry the webbing at temperatures above 176°F (80°C) or in direct sunlight.

Warning!



Do not bleach or dye seat belts as this may severely weaken them. In a crash they may not be able to provide adequate protection.

Upholstery

Using aftermarket seat covers or wearing clothing that have the tendency to give off coloring (e.g. when wet, etc.) may cause the upholstery to become permanently discolored. By lining the seats with a proper intermediate cover, contact-discoloration will be prevented.

Leather upholstery

Wipe leather upholstery with a damp cloth and dry thoroughly or clean with Mercedes-Benz approved Leather Care. Exercise particular care when cleaning perforated leather as its underside should not become wet.

Plastic and rubber parts

Do not use oil or wax on these parts.

Wood trims

Dampen cloth using water and use damp cloth to clean wood trims in your vehicle. Do not use solvents like tar remover or wheel cleaner nor polishes or waxes as these may be abrasive.



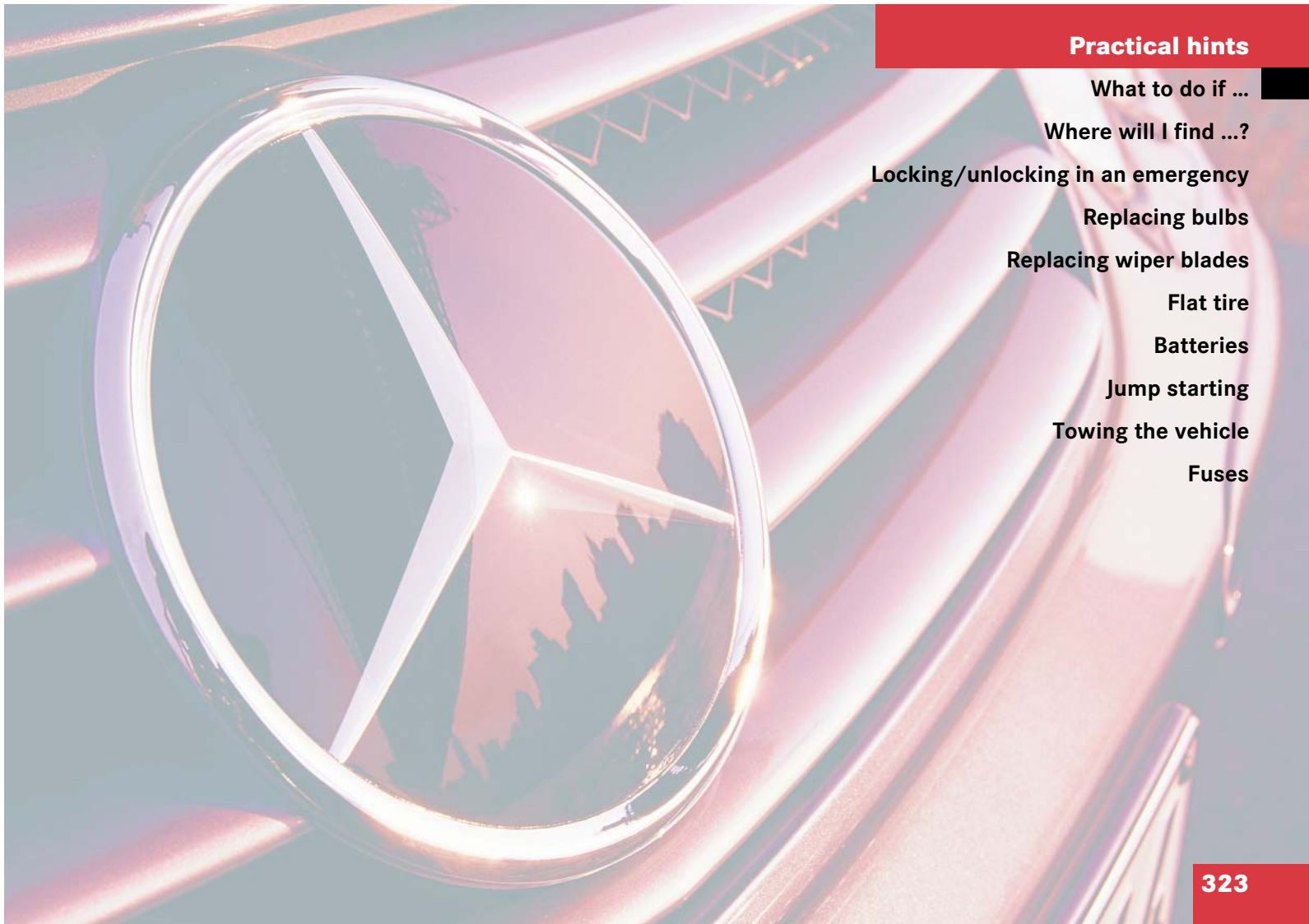

Practical hints

What to do if ...

Where will I find ...?

Locking/unlocking in an emergency

Replacing bulbs

Replacing wiper blades

Flat tire

Batteries

Jump starting

Towing the vehicle

Fuses

Practical hints



What to do if ...

Lamps in the instrument cluster

General information:

If any of the following lamps in the instrument cluster fails to come on during the

bulb self-check when switching on the ignition, have the respective bulb checked and replaced if necessary.

Problem	Possible cause	Suggested solution
 The yellow ABS/ESP warning lamp comes on while driving.	The ESP is deactivated. Risk of accident! Adapt your speed and driving to the prevailing road and weather conditions.	▶ Switch the ESP back on (▷ page 84). If the ESP cannot be switched back on, have the system checked at an authorized Mercedes-Benz Center as soon as possible.
 The yellow ABS/ESP warning lamp flashes while driving.	The ESP, ABS, or traction control has come into operation because of detected traction loss in at least one tire. Distronic* is deactivated.	▶ When driving off, apply as little throttle as possible. ▶ While driving, ease up on the accelerator. ▶ Adapt your speed and driving to the prevailing road and weather conditions. ▶ Do not deactivate the ESP. Exceptions: (▷ page 83). Failure to follow these instructions increases the risk of an accident.

Practical hints

What to do if ...

Problem	Possible cause	Suggested solution
 The yellow ABS indicator lamp comes on while driving.	<p>The ABS has detected a malfunction and has switched off. The BAS and the ESP are also switched off (see messages in display).</p> <p>The SBC brake system is still functioning normally but without ABS available.</p> <p>If the ABS control unit is malfunctioning, other systems such as Parktronic*, Distronic*, or the automatic transmission may also be malfunctioning.</p>	<ul style="list-style-type: none"> ▶ Continue driving with added caution. Wheels may lock during hard braking, reducing steering capability. ▶ Have the system checked at an authorized Mercedes-Benz Center as soon as possible. <p>Failure to follow these instructions increases the risk of an accident.</p> <ul style="list-style-type: none"> ▶ Read and observe messages in the display (▷ page 335).
	<p>The charging voltage has fallen below 10 volts and the ABS was switched off.</p> <p>The battery may not be sufficiently charged.</p>	<ul style="list-style-type: none"> ▶ Switch off electrical consumers that are currently not needed, e.g. seat heating. ▶ If necessary, have the generator and battery checked. <p>When the voltage is above this value again, the ABS is operational again.</p>

Practical hints

What to do if ...

Problem	Possible cause	Suggested solution
<p>BRAKE (USA only)</p> <p> (Canada only)</p> <p>The red brake warning lamp comes on while driving and you hear a warning sound.</p> <p>The red brake warning lamp comes on while driving</p>	<p>You are driving with the parking brake set, or</p> <p>there is a malfunction in the SBC brake system.</p> <p>There is insufficient brake fluid in the reservoir.</p>	<ul style="list-style-type: none"> ▶ Release the parking brake (▷ page 50). ▶ Read and observe messages in the display (▷ page 335). ▶ Risk of accident! Carefully stop the vehicle and notify an authorized Mercedes-Benz Center. Do not add brake fluid! This will not solve the problem.

Warning!



Driving with the brake warning lamp illuminated can result in an accident. Have your brake system checked immediately if the brake warning lamp stays on. Do not add brake fluid before checking the brake system.



Overfilling the brake fluid reservoir can result in spilling brake fluid on hot engine parts and the brake fluid catching fire. You can be seriously burned.



If you find that the brake fluid in the brake fluid reservoir has fallen to the minimum mark or below, have the brake system checked for brake pad thickness and leaks.





Practical hints

What to do if ...

Problem	Possible cause	Suggested solution
 (USA only)  (Canada only) The yellow engine malfunction indicator lamp comes on while driving.	<p>There is a malfunction in:</p> <ul style="list-style-type: none">• The fuel injection system• The ignition system• The emission control system• Systems which effect emissions <p>Such malfunctions may result in excessive emissions values and may switch the engine to its limp-home (emergency operation) mode.</p>	<p>▶ Have the vehicle checked as soon as possible by an authorized Mercedes-Benz Center.</p> <p>An on-board diagnostic connector is used by the service station to link the vehicle to the shop diagnostics system. It allows the accurate identification of system malfunctions through the readout of diagnostic trouble codes. It is located in the front left area of the footwell next to the parking brake.</p>
	<p>The fuel cap is not closed tightly.</p>	<p>▶ Check the fuel cap (▷ page 267).</p> <p>If it is not closed properly:</p> <p>▶ Close the fuel cap.</p> <p>If it is closed properly:</p> <p>▶ Have the fuel system checked by an authorized Mercedes-Benz Center.</p>

Practical hints

What to do if ...

Problem	Possible cause	Suggested solution
 (USA only)  (Canada only) The yellow engine malfunction indicator lamp comes on while driving.	Your fuel tank is empty.	<ul style="list-style-type: none"> ▶ After refuelling, start, turn off, and restart the engine three or four times in succession. The limp-home mode is canceled. You do not need to have your vehicle checked.
 The red coolant warning lamp comes on when the engine is running.	There is insufficient coolant in the reservoir. If this warning lamp comes on frequently, there is a leak in the cooling system. If the coolant level is correct, the electric radiator fan may be broken.	<ul style="list-style-type: none"> ▶ Immediately add coolant to prevent engine from overheating (▷ page 276). ▶ Have the cooling system checked. ▶ If the coolant temperature is below 248 °F (120 °C), you can continue driving to the nearest authorized Mercedes-Benz Center. ▶ Avoid high engine loads (e.g. driving uphill) and stop-and-go driving.
 The red coolant warning lamp comes on while driving and you hear a warning sound.	The coolant temperature has exceeded 248 °F (120 °C).	<ul style="list-style-type: none"> ▶ Stop as soon as possible and allow the engine and coolant to cool down.

Warning!





Driving when your engine is badly overheated can cause some fluids which may have leaked into the engine compartment to catch fire. You could be seriously burned.

Steam from an overheated engine can cause serious burns and can occur just by opening the engine hood. Stay away from the engine if you see or hear steam coming from it.

Turn off the engine, get out of the vehicle and do not stand near the vehicle until the engine has cooled down.

Practical hints

What to do if ...

Problem	Possible cause	Suggested solution
 The red DTR indicator lamp comes on while driving and you hear a warning sound.	<ul style="list-style-type: none">• You are gaining too rapidly on the vehicle ahead of you.• The distance warning system has recognized a stationary obstacle on your probable line of travel.	<ul style="list-style-type: none">▶ Apply the brakes immediately.▶ Carefully observe the traffic situation. You may need to brake or maneuver to avoid hitting an obstacle.
 The white DTR indicator lamp comes on while driving.	The Distronic* distance sensor has recognized a vehicle in front of you.	
 The yellow fuel tank reserve warning lamp lights while driving.	The fuel level has dropped below the reserve mark.	▶ Refuel at the next gas station (▷ page 267).
	The fuel cap is not closed tightly.	▶ Check the fuel cap (▷ page 267).

Practical hints

What to do if ...

Problem	Possible cause	Suggested solution
 The yellow roll bar warning lamp comes on or flickers when the engine is running.	The roll bar is not operational.	<ul style="list-style-type: none">▶ For safety reasons, always have the roll bar raised when driving with the retractable hardtop open. Attempt to raise the roll bar manually.▶ Have the roll bar checked by an authorized Mercedes-Benz Center.

Warning!



If the roll bar warning lamp does not come on, does not go out after a long time, flickers or comes on while driving as described above, then the roll bar system is not operating properly and may not activate in an accident. In this case, raise the roll bar manually (▷ page 73) before continuing to drive.

Practical hints

What to do if ...

Problem	Possible cause	Suggested solution
 The red seat belt telltale comes on briefly after starting the engine.	The seat belt telltale reminds you to fasten seat belts.	► Fasten your seat belt. The seat belt telltale goes out.
SRS The red SRS indicator lamp comes on while driving.	There is a malfunction in the restraint systems. The airbags or emergency tensioning device (ETD) could deploy unexpectedly or fail to activate in an accident.	► Drive with added caution to the nearest authorized Mercedes-Benz Center.

Warning!



In the event that a malfunction of the SRS is indicated as outlined above, the SRS may not be operational. For your safety, we strongly recommend that you visit an authorized Mercedes-Benz Center immediately to have the system checked; otherwise the SRS may not be activated when needed in an accident, which could result in serious or fatal injury, or it might deploy unexpectedly and unnecessarily which could also result in an accident and/or injury to you or to others.

Practical hints

What to do if ...

Problem	Possible cause	Suggested solution
 The yellow warning lamp for the tire pressure monitoring system comes on.	The tire pressure monitoring system detects a loss of pressure in at least one tire.	<ul style="list-style-type: none">▶ Bring the vehicle to a halt, avoiding abrupt steering and braking maneuvers. Observe the traffic situation around you.▶ Take note of the messages in the multi-function display. <p>The warning lamp goes out once the tire inflation pressure monitor has been reactivated after the tire inflation pressure has been corrected.</p>

Warning!



When the tire pressure monitoring system warning light is lit, one or more of your tires is significantly under-inflated. You should stop and check your tires as soon as possible, and inflate them to the proper pressure as indicated on the vehicle's tire information placard. Driving on a significantly under-inflated tire causes the tire to overheat and can lead to tire failure.

Under-inflation also reduces fuel efficiency and tire tread life, and may affect the vehicle's handling and stopping ability. Each tire, including the spare, should be checked monthly when cold and set to the recommended inflation pressure as specified in the vehicle placard and owner's manual.





The recommended tire inflation pressures for your vehicle can be found on the tire placard on the driver's door B-pillar, not in the owner's manual.

Practical hints

What to do if ...

AIRBAG OFF indicator lamp

Problem	Possible cause	Suggested solution
 The AIRBAG OFF indicator lamp comes on.	A BabySmart ^{TM1} child seat is installed on the front passenger seat. Therefore the passenger front airbag is switched off. The system is malfunctioning if the  indicator lamp comes on with no BabySmart TM child seat installed on the front passenger seat.	<ul style="list-style-type: none">▶ Have the system checked at an authorized Mercedes-Benz Center as soon as possible.
 The AIRBAG OFF indicator lamp does not come on with a BabySmart TM child seat properly installed on the front passenger seat.	The system is malfunctioning.	<ul style="list-style-type: none">▶ Make sure there is nothing between seat cushion and child seat.▶ Check installation of the child seat. If the indicator lamp remains out: <ul style="list-style-type: none">▶ Have the system checked at an authorized Mercedes-Benz Center as soon as possible. Do not use the BabySmart TM restraint to transport children on the front passenger seat until the system has been repaired.

¹ BabySmartTM is a trademark of Siemens Automotive Corp.

Vehicle status messages in the multifunction display





Warning and malfunction messages appear in the multifunction display located in the instrument cluster.





Certain warning and malfunction messages are accompanied by an audible signal.

Address these messages accordingly and follow the additional instructions given in this Operator's Manual.

Selecting the vehicle status message memory menu in the control system (▷ page 143) displays both cleared and uncleared messages.

High-priority messages appear in the multifunction display in red color.

Certain messages of high priority cannot be cleared from the multifunction display using the reset button (▷ page 24) or button , , , or  on the multifunction steering wheel.

Other messages of high priority and messages of less immediate priority can be cleared from the multifunction display using the reset button or button , , , or  on the multifunction steering wheel. They are then stored in the vehicle status message memory (▷ page 143). Remember that clearing a message will not correct the condition that caused the message to appear.

Practical hints

What to do if ...

Warning!



All categories of messages contain important information which should be taken note of and, where a malfunction is indicated, addressed as soon as possible at an authorized Mercedes-Benz Center.

Failure to repair condition noted may cause damage not covered by the Mercedes-Benz Limited Warranty, or result in property damage or personal injury.

Warning!



No messages will be displayed if either the instrument cluster or the multifunction display is inoperative. Contact your nearest authorized Mercedes-Benz Center.

Practical hints

What to do if ...



Switching on the ignition causes all instrument cluster lamps (except high beam headlamp indicator lamp and turn signal indicator lamps unless activated) as well as the multifunction display to come on. Make sure the lamps and the multifunction display are in working order before starting your journey.

On the pages that follow, you will find a compilation of the most important warning and malfunction messages that may appear in the multifunction display.

For your convenience the messages are divided into two sections:

- Text messages (> page 337)
- Symbol messages (> page 345)

Text messages

Left display	Right display	Possible cause	Possible solution
ABC	Drive carefully!	The capability of the ABC system is restricted. This can impair handling.	<ul style="list-style-type: none"> ▶ Do not exceed a speed of 50 mph (80 km/h). ▶ Visit an authorized Mercedes-Benz Center as soon as possible.
		The vehicle is losing oil.	<ul style="list-style-type: none"> ▶ Stop your vehicle as soon as it is safe to do so.
	Stop, car too low	The car is parked on an extremely uneven surface.	<ul style="list-style-type: none"> ▶ Press the vehicle level control button to select level 2 (▷ page 222).
		ABC is malfunctioning.	<ul style="list-style-type: none"> ▶ Stop and press the ABC button to select a higher vehicle level (▷ page 222). ▶ Do not turn steering wheel too far to avoid damaging the front fenders. ▶ Listen for scraping noises. ▶ Do not exceed a speed of 50 mph (80 km/h). ▶ Visit an authorized Mercedes-Benz Center as soon as possible.

Practical hints

What to do if ...

Left display	Right display	Possible cause	Possible solution
ABC	Display malfunction Visit workshop	The ABC display or the ABC system itself is malfunctioning.	▶ Visit an authorized Mercedes-Benz Center as soon as possible.
	Visit workshop	The capability of the ABC system is restricted.	▶ Do not exceed a speed of 50 mph (80 km/h). ▶ Visit an authorized Mercedes-Benz Center as soon as possible.
ABS	Malfunction! Visit workshop!	The ABS has detected a malfunction and has switched off. The ESP and the BAS are also deactivated. The SBC brake system is still functioning normally but without the ABS available.	▶ Continue driving with added caution. Wheels may lock during hard braking, reducing steering capability. ▶ Have the system checked at an authorized Mercedes-Benz Center as soon as possible. Failure to follow these instructions increases the risk of an accident.

Practical hints

What to do if ...

Left display	Right display	Possible cause	Possible solution
ABS	Display malfunction Visit workshop!	The ABS or the ABS display is malfunctioning.	<ul style="list-style-type: none">▶ Continue driving with added caution. Wheels may lock during hard braking, reducing steering capability.▶ Have the system checked at an authorized Mercedes-Benz Center as soon as possible. <p>Failure to follow these instructions increases the risk of an accident.</p>
Cruise control	Visit workshop	Cruise control or DISTRONIC* is malfunctioning.	<ul style="list-style-type: none">▶ Have the cruise control or DISTRONIC* checked at an authorized Mercedes-Benz Center as soon as possible.

Practical hints

What to do if ...

Left display	Right display	Possible cause	Possible solution
Distronic	Currently unavailable. See Oper. Manual	Distronic* is switched off because <ul style="list-style-type: none"> the DISTRONIC* cover in the radiator grille is dirty functionality is impaired by heavy rain or thick fog 	<ul style="list-style-type: none"> Clean the DISTRONIC* cover in the radiator grille (▷ page 318). Restart the vehicle. or DISTRONIC* becomes operational again without the engine being started again when the conditions that had impaired the functionality no longer prevail, e.g. lessening rain or slush or snow has fallen off the DISTRONIC* cover while driving. You can then operate DISTRONIC* as usual again.
	Drive to workshop	Distronic* is malfunctioning or the display is malfunctioning.	<ul style="list-style-type: none"> Visit an authorized Mercedes-Benz Center as soon as possible.
ESP	Malfunction Visit workshop	The ESP has detected a malfunction and switched off. The ABS may not be operational. The SBC brake system is still functioning normally but without the ESP available.	<ul style="list-style-type: none"> Continue driving with added caution. Have the system checked at an authorized Mercedes-Benz Center as soon as possible. Failure to follow these instructions increases the risk of an accident.

Practical hints

What to do if ...

Left display	Right display	Possible cause	Possible solution
ESP	Display malfunction Visit workshop	The ESP or the ESP display is malfunctioning.	<ul style="list-style-type: none"> ▶ Continue driving with added caution. ▶ Have the system checked at an authorized Mercedes-Benz Center as soon as possible. <p>Failure to follow these instructions increases the risk of accident.</p>
	Unavailable See Oper. Manual	<p>The ESP is deactivated because the power supply has been interrupted.</p> <p>The SBC brake system is still functioning normally but without the ESP available.</p>	<ul style="list-style-type: none"> ▶ Synchronize the ESP. With the vehicle stationary, turn the steering wheel completely to the left and then to the right. If the ESP message does not go out: <ul style="list-style-type: none"> ▶ Continue driving with added caution. ▶ Have the system checked at an authorized Mercedes-Benz Center as soon as possible. <p>Failure to follow these instructions increases the risk of an accident.</p>



When synchronizing the ESP, make sure you can turn the steering wheel in both directions as far as it will go without the

wheels hitting any objects, e.g. a road curb.

Practical hints

What to do if ...

Left display	Right display	Possible cause	Possible solution
P	Gear selector lever to P	<p>You have tried to start the engine with the KEYLESS-GO* start/stop button with the gear selector lever not in P.</p> <p>You have tried to turn off the engine with the KEYLESS-GO* start/stop button with the gear selector lever not in P.</p> <p>You have opened the driver's door while engine is running with the gear selector lever not in P.</p>	▶ Place the gear selector lever in position P .

Practical hints

What to do if ...

Left display	Right display	Possible cause	Possible solution
Tire pres. monitor	reactivated	The tire pressure monitoring system is using the current pressure values as the basis for monitoring.	
Tire pressure	displayed only after driving a few minutes	The tire inflation pressure is being checked.	
Tire pres. monitor	temporarily unavailable	<p>The tire inflation pressure monitor is unable to monitor the tire inflation pressure due to</p> <ul style="list-style-type: none">• the presence of several wheel sensors in the vehicle.• excessive wheel sensor temperatures.• a nearby radio interference source.• unrecognized wheel sensors mounted.	<p>► Remove any extra wheel sensors from the vehicle</p> <p>As soon as the causes of the malfunction have been removed, the tire pressure monitoring system automatically becomes active again.</p>

Practical hints

What to do if ...

Left display	Right display	Possible cause	Possible solution
Reactivate tire pressure monitor	after rectifying pressure	There was a tire inflation pressure warning message. The yellow warning lamp for the tire pressure monitoring system comes on and you have not reactivated the system since the last tire inflation pressure warning message.	▶ Reactivate the tire pressure monitoring system after correcting the tire inflation pressure values (▷ page 293).
Tire pres. monitor inoperative	Drive to workshop	The tire inflation pressure monitor is malfunctioning. A wheel without proper sensor was installed.	▶ Have the tire inflation pressure monitor checked by an authorized Mercedes-Benz Center. ▶ Have the wheel checked.

Warning!



Do not drive with a flat tire. A flat tire affects the ability to steer or brake the vehicle.



You may lose control of the vehicle. Continued driving with a flat tire will cause excessive heat build-up and possibly a fire.

Symbol messages

Left display	Right display	Possible cause	Possible solution
	Battery/Alternator Stop vehicle	The battery is malfunctioning. The SBC brake system requires electrical energy and therefore has only limited operation. Considerably greater brake pedal force is required and the stopping distance is increased.	<ul style="list-style-type: none"> ▶ Stop the vehicle as soon as it is safe to do so. Adjust driving to be consistent with reduced braking responsiveness. ▶ Notify an authorized Mercedes-Benz Center.
	Visit workshop!	The battery is no longer charging. Possible causes: <ul style="list-style-type: none"> • alternator malfunctioning • broken poly-V-belt Do not forget that the brake system requires electrical energy and may be operating with restricted capability. Considerably greater brake pedal force is required and the stopping distance is increased.	<ul style="list-style-type: none"> ▶ Stop immediately and check the poly-V-belt. If it is broken: <ul style="list-style-type: none"> ▶ Do not continue to drive. Otherwise, the engine will overheat due to an inoperative water pump which may result in damage to the engine. Notify an authorized Mercedes-Benz Center. If it is in order: <ul style="list-style-type: none"> ▶ Drive immediately to the nearest authorized Mercedes-Benz Center. Adjust driving to be consistent with reduced braking responsiveness.

Practical hints

What to do if ...



Left display	Right display	Possible cause	Possible solution
	Visit workshop!	There is a malfunction in the electronic system.	► Have the system checked at an authorized Mercedes-Benz Center as soon as possible.
	Electric consumers offline!	The consumer battery has insufficient voltage and can no longer supply the convenience functions such as seat ventilation*.	The electrical consumers will come back online as soon as on-board voltage is sufficient.
	Brake wear Visit workshop	The brake pads have reached their wear limit.	► Have the brake pads replaced as soon as possible.



Brake pad thickness must be visually checked by a qualified technician at the intervals specified in the Maintenance Booklet.

Practical hints

What to do if ...

Left display	Right display	Possible cause	Possible solution
	Reduced braking power! Depress brake pedal fully!	The SBC brake system is in emergency operation mode. Considerably greater brake pedal force is required and the stopping distance is increased. The maximum speed is limited to 55 mph (90 km/h).	<ul style="list-style-type: none"> ▶ Do not drive any further. ▶ Stop the vehicle and notify an authorized Mercedes-Benz Center. ▶ Prevent the vehicle from rolling away by blocking the wheels with wheel chocks or other sizable objects. ▶ Call for roadside assistance.
USA only:  Canada only: 	Reduced brake effect Start engine	The battery has insufficient voltage and cannot supply sufficient power to the SBC brake system.	<ul style="list-style-type: none"> ▶ Start the engine. <p>The message disappears when sufficient voltage is available</p>

Warning!





Inhalation of exhaust gas is hazardous to your health. All exhaust gas contains carbon monoxide, and inhaling it can cause unconsciousness and lead to death.

Do not run the engine in confined areas (such as a garage) which are not properly ventilated.

Practical hints

What to do if ...

Left display	Right display	Possible cause	Possible solution
USA only:  Canada only: 	Reduced brake effect Visit workshop	The SBC brake system is in emergency operation mode. Considerable brake pedal force is required and the stopping distance is increased.	<ul style="list-style-type: none"> ▶ Continue driving with added caution. ▶ Adjust driving to be consistent with reduced braking responsiveness. ▶ Visit an authorized Mercedes-Benz Center immediately. Adjust driving to be consistent with reduced braking responsiveness.

Warning!



Driving while these messages are displayed can result in an accident. Have your brake system checked immediately.

If there is a malfunction in the SBC brake system, we recommend that the vehicle be transported with all wheels off the ground using flatbed or appropriate wheel lift/dolly equipment.

A tow bar must be used if circumstances do not permit the use of the recommended towing methods and the vehicle requires towing with all four wheels on the ground.

Towing the vehicle with all four wheels on the ground is only permissible for distances up to 30 miles (50 km) and at a speed not to exceed 30 mph (50 km/h). For more information, see "Towing the vehicle" (> page 408).

If the SBC brake system enters its emergency operation mode, the driver must apply significantly greater brake pedal pressure and depress the pedal much further than normal to obtain braking effect.

If necessary, apply full pressure to the brake pedal. Brakes are only applied to the front wheels. Stopping distance is increased!

Practical hints

What to do if ...

Left display	Right display	Possible cause	Possible solution
USA only: BRAKE Canada only: 	Brake fluid below min. level Visit workshop	There is insufficient brake fluid in the reservoir.	► Risk of accident! Stop the vehicle as soon as it is safe to do so and notify an authorized Mercedes-Benz Center. Do not add brake fluid! This will not solve the problem.



If you find that the brake fluid in the brake fluid reservoir has fallen to the minimum mark or below, have the brake system checked for brake pad thickness and leaks.







Warning



Driving with this message displayed can result in an accident. Have your brake system checked immediately. Do not add brake fluid before checking the brake system. Overfilling the brake fluid reservoir can result in spilling brake fluid on hot engine parts and the brake fluid catching fire. You can be seriously burned.



Practical hints

What to do if ...

Left display	Right display	Possible cause	Possible solution
USA only:  Canada only: 	Service brake Visit workshop	There are malfunctions, but the SBC brake system is operating normally.	<ul style="list-style-type: none"> ▶ Visit an authorized Mercedes-Benz Center as soon as possible.
USA only:  Canada only: 	Brakes overheated Drive carefully	The brake system is overheated due to an excessive load on the brakes.	<ul style="list-style-type: none"> ▶ Relieve the load on the brake system. ▶ Drive more smoothly and think ahead to avoid unnecessary braking. ▶ When driving down steep grades, shift into a lower gear to use the engine's braking power (> page 166). ▶ Cautiously continue driving so that the air stream will cool down the brakes.
USA only:  Canada only: 	Release parking brake	You are driving with the parking brake set.	<ul style="list-style-type: none"> ▶ Release the parking brake (> page 57).

Practical hints

What to do if ...

Left display	Right display	Possible cause	Possible solution
	Engine Service	There may be a malfunction in the <ul style="list-style-type: none">• fuel injection system• ignition system• exhaust system• fuel system	<ul style="list-style-type: none">▶ Have the engine checked as soon as possible by an authorized Mercedes-Benz Center (▷ page 327).
	Coolant Check level	The coolant level is too low.	<ul style="list-style-type: none">▶ Add coolant (▷ page 276).▶ If you have to add coolant frequently, have the cooling system checked by an authorized Mercedes-Benz Center.

Warning!



Do not spill antifreeze on hot engine parts. Antifreeze contains ethylene glycol which may burn if it comes into contact with hot engine parts. You can be seriously burned.



Do not ignore the low engine coolant level warning. Extended driving with this message and symbol displayed may cause serious engine damage not covered by the Mercedes-Benz Limited Warranty. Do not drive without sufficient amount of coolant in the cooling system. The engine will overheat, causing major engine damage.

Practical hints

What to do if ...

Left display	Right display	Possible cause	Possible solution
	Coolant Stop, put engine off!	The coolant is too hot.	<ul style="list-style-type: none">▶ Stop the vehicle and turn off the engine.▶ Only start the engine again after the message disappears. You could otherwise damage the engine.

Warning!



Driving when your engine is badly overheated can cause some fluids which may have leaked into the engine compartment to catch fire. You could be seriously burned.

Steam from an overheated engine can cause serious burns and can occur just by opening the engine hood. Stay away from the engine if you see or hear steam coming from it.

Turn off the engine, get out of the vehicle and do not stand near the vehicle until the engine has cooled down.



During severe operating conditions, e.g. stop-and-go traffic, the coolant temperature may rise close to 248°F (120°C).



The engine should not be operated with the coolant temperature above 248°F (120°C). Doing so may cause serious engine damage which is not covered by the Mercedes-Benz Limited Warranty.





Practical hints

What to do if ...

Left display	Right display	Possible cause	Possible solution
	Coolant Stop, put engine off!	The poly-V-belt could be broken.	<ul style="list-style-type: none">▶ Stop immediately and check the poly-V-belt. If it is broken: <ul style="list-style-type: none">▶ Do not continue to drive. Otherwise, the engine will overheat due to an inoperative water pump which may result in damage to the engine. Notify an authorized Mercedes-Benz Center. If it is intact: <ul style="list-style-type: none">▶ Do not continue to drive with this message displayed. Doing so could result in serious engine damage that is not covered by the Mercedes-Benz Limited Warranty.
	Coolant Visit workshop	The cooling fan for the coolant is malfunctioning.	<ul style="list-style-type: none">▶ Observe the coolant temperature gauge.▶ Have the fan replaced as soon as possible.

Practical hints

What to do if ...

Left display	Right display	Possible cause	Possible solution
	Display malfunction Visit workshop!	The displays for several systems have malfunctioned. Some systems themselves may also have malfunctioned.	<ul style="list-style-type: none"> ▶ Continue driving with added caution. When the display is malfunctioning, warnings and malfunction messages might not be displayed. ▶ Have the electronic systems checked by an authorized Mercedes-Benz Center.
	Display malfunction Visit workshop	<p>Certain electronic systems are unable to relay information to the control system. The following systems may have failed:</p> <ul style="list-style-type: none"> • Coolant temperature gauge • Tachometer • Cruise control display 	▶ Have the electronic systems checked by an authorized Mercedes-Benz Center (> page 327).
	Door open	You are attempting to drive with one or more doors open.	▶ Close the doors.
	Entry position Do not drive	Seat, mirrors and steering wheel have not yet moved into their preset driving positions.	<ul style="list-style-type: none"> ▶ Wait until the seat, mirrors and steering wheel have moved to their driving positions. The message disappears.

Practical hints

What to do if ...

Left display	Right display	Possible cause	Suggested solution
	<p>USA only: Add 1 qt. engine oil at next refueling</p> <p>Canada only: Add 1 liter engine oil at next refueling</p>	The engine oil level is too low.	<ul style="list-style-type: none"> ▶ Add engine oil (▷ page 274) and check the engine oil level (▷ page 272).
	<p>Engine oil level Stop, put engine off</p>	There is no oil in the engine. There is a danger of engine damage.	<ul style="list-style-type: none"> ▶ Carefully bring the vehicle to a halt as soon as possible. ▶ Turn off the engine. ▶ Add engine oil (▷ page 274) and check the engine oil level (▷ page 272).
	<p>Engine oil level Reduce oil level</p>	You have added too much engine oil. There is a risk of damaging the engine or the catalytic converter.	<ul style="list-style-type: none"> ▶ Have excess oil siphoned or drained off. Observe all legal requirements with respect to its disposal.

Practical hints

What to do if ...

Left display	Right display	Possible cause	Suggested solution
	Engine oil Visit workshop!	It may be that there is water in the engine oil.	▶ Have the engine oil checked.
	Engine oil level Visit workshop	The engine oil has dropped to a critical level.	▶ Check the engine oil level (▷ page 272) and add oil as required (▷ page 274). ▶ If you must add engine oil frequently, have the engine checked for possible leaks.
		The measuring system is malfunctioning.	▶ Have the measuring system checked by an authorized Mercedes-Benz Center.

When the message Add 1 qt engine oil at next refueling (Canada: 1 l) appears while the engine is running and at operating temperature, the engine oil level has dropped to approximately the minimum level.

When this occurs, the warning will first come on intermittently and then stay on if the oil level drops further.





If no oil leaks are noted, continue to drive to the nearest service station where the engine oil should be topped to the required level with an approved oil specified in the Factory Approved Service Products pamphlet.



The engine oil level warnings should not be ignored. Extended driving with the symbol displayed could result in serious engine damage that is not covered by the Mercedes-Benz Limited Warranty.

Practical hints

What to do if ...

Left display	Right display	Possible cause	Possible solution
	Reserve fuel	The fuel level has dropped below the reserve mark.	▶ Refuel at the next gas station (▷ page 267).
	Check fuel cap See Oper. Manual	A loss of pressure has been detected in the fuel system. The fuel cap may not be closed properly or the fuel system may be leaky.	▶ Check the fuel cap (▷ page 267). If it is not closed properly: ▶ Close the fuel cap. If it is closed properly: ▶ Have the fuel system checked by an authorized Mercedes-Benz Center.
	Visit workshop	The retractable hardtop is malfunctioning.	▶ Have the retractable hardtop checked by an authorized Mercedes-Benz Center.
	Lock retractable roof	The retractable hardtop is not locked properly.	▶ Push or pull on the retractable hardtop switch until the indicator lamp in the switch goes out and the retractable hardtop is completely open or closed (▷ page 196).
	Close hood	You are driving with the hood open.	▶ Close the hood (▷ page 271).
	Remove key	You have forgotten to remove the SmartKey from the starter switch.	▶ Remove the SmartKey from the starter switch.
	Replace key	The batteries in the SmartKey are discharged.	▶ Change the batteries (▷ page 377).



Practical hints

What to do if ...

Left display	Right display	Possible cause	Possible solution
	Key Check battery	The batteries in the SmartKey with KEYLESS-GO* are discharged.	► Change the batteries (▷ page 377).
	Don't forget key	This message appears (for a maximum of 60 seconds) if the driver's door is opened with the engine shut off and no SmartKey in the starter switch. Message is only a reminder.	► Insert SmartKey in the starter switch. ► Take the SmartKey with KEYLESS-GO* with you when leaving the vehicle.
	KEYLESS GO Check system	The KEYLESS-GO* system is malfunctioning.	► Visit an authorized Mercedes-Benz Center as soon as possible.
	KEYLESS-GO Drive to workshop	The KEYLESS-GO* system is malfunctioning.	► Visit an authorized Mercedes-Benz Center as soon as possible.

Practical hints

What to do if ...

Left display	Right display	Possible cause	Possible solution
	Key not detected	The SmartKey with KEYLESS-GO* is not recognized while the engine is running because <ul style="list-style-type: none"> the SmartKey with KEYLESS-GO* is not in the vehicle there is strong radio-frequency interference 	<ul style="list-style-type: none"> Stop the vehicle as soon as it is safe to do so. Search for the SmartKey with KEYLESS-GO* or continue to operate the vehicle with the SmartKey. <p>Otherwise the vehicle cannot be centrally locked nor can the engine be started again after the engine is stopped.</p>
		The SmartKey with KEYLESS-GO* is momentarily not recognized.	<ul style="list-style-type: none"> Change the position of the SmartKey with KEYLESS-GO* in the vehicle. Operate the vehicle with the SmartKey if necessary.
	Key still in vehicle	A SmartKey with KEYLESS-GO* left in the vehicle was recognized while locking the vehicle from the outside.	<ul style="list-style-type: none"> Take the SmartKey with KEYLESS-GO* out of the vehicle.
	3rd brake lamp	The high mounted brake lamp is malfunctioning.	<ul style="list-style-type: none"> Visit an authorized Mercedes-Benz Center as soon as possible.
	Brake lamp Left Auxiliary lamp on!	The left brake lamp is malfunctioning. An auxiliary lamp has been brought into use.	<ul style="list-style-type: none"> Visit an authorized Mercedes-Benz Center as soon as possible.

Practical hints

What to do if ...

Left display	Right display	Possible cause	Possible solution
	Brake lamp Right Auxiliary lamp on!	The right brake lamp is malfunctioning. An auxiliary lamp has been brought into use.	► Visit an authorized Mercedes-Benz Center as soon as possible.
	Brake lamp! Drive to workshop!	Brake lamp illumination is delayed or lamp is permanently on.	► Visit an authorized Mercedes-Benz Center as soon as possible.
	Front foglamp Left	The left front fog lamp is malfunctioning.	► Replace the bulb as soon as possible.
	Front foglamp Right	The right front fog lamp is malfunctioning.	► Replace the bulb as soon as possible.
	Rear foglamp Left	The left rear fog lamp is malfunctioning.	► Replace the bulb as soon as possible.
	High beam Left	The left high beam lamp is malfunctioning.	► Replace the bulb as soon as possible.
	High beam Right	The right high beam lamp is malfunctioning.	► Replace the bulb as soon as possible.
	Left turn signal Mirror	The left turn signal in the side mirror is malfunctioning. This message will only appear if all light emitting diodes have stopped working.	► Have the LEDs replaced as soon as possible.

Practical hints

What to do if ...

Left display	Right display	Possible cause	Possible solution
	License plate lamp, L	The left license plate lamp is malfunctioning.	<ul style="list-style-type: none"> ▶ Replace the bulb as soon as possible.
	License plate lamp, R	The right license plate lamp is malfunctioning.	<ul style="list-style-type: none"> ▶ Replace the bulb as soon as possible.
	Light sensor Drive to workshop!	The light sensor is malfunctioning. The headlamps switch on automatically.	<ul style="list-style-type: none"> ▶ In the control system, set lamp operation to manual (▷ page 152). ▶ Switch on headlamps using the exterior lamp switch. ▶ Visit an authorized Mercedes-Benz Center as soon as possible.
	Low beam Left	The left low beam lamp is malfunctioning.	Halogen headlamp: <ul style="list-style-type: none"> ▶ Replace the bulb as soon as possible. Bi-Xenon* headlamp: <ul style="list-style-type: none"> ▶ Visit an authorized Mercedes-Benz Center as soon as possible.
Low beam Right	The right low beam lamp is malfunctioning.	Halogen headlamp: <ul style="list-style-type: none"> ▶ Replace the bulb as soon as possible. Bi-Xenon* headlamp: <ul style="list-style-type: none"> ▶ Visit an authorized Mercedes-Benz Center as soon as possible. 	

Practical hints

What to do if ...

Left display	Right display	Possible cause	Possible solution
	Marker lamp Front left	The front left side marker lamp is malfunctioning.	▶ Replace the bulb as soon as possible.
	Marker lamp Front right	The front right side marker lamp is malfunctioning.	▶ Replace the bulb as soon as possible.
	Marker lamp Rear left	The rear left side marker lamp is malfunctioning.	▶ Replace the bulb as soon as possible.
	Marker lamp Rear right	The rear right side marker lamp is malfunctioning.	▶ Replace the bulb as soon as possible.
	Parking lamp Front left	The front left parking or standing lamp is malfunctioning.	▶ Replace the bulb as soon as possible.
	Parking lamp Front right	The front right parking or standing lamp is malfunctioning.	▶ Replace the bulb as soon as possible.
	Rear foglamp Left	The left rear fog lamp is malfunctioning.	▶ Replace the bulb as soon as possible.
	Reverse lamp Left	The left backup lamp is malfunctioning.	▶ Replace the bulb as soon as possible.
	Reverse lamp Right	The right backup lamp is malfunctioning.	▶ Replace the bulb as soon as possible.







Practical hints

What to do if ...

Left display	Right display	Possible cause	Possible solution
	Right turn signal Mirror	The right turn signal in the side mirror is malfunctioning. This message will only appear if all light emitting diodes have stopped working.	► Have the LEDs replaced as soon as possible.
	Tail lamp Left Auxiliary lamp on!	The left tail lamp is malfunctioning. An auxiliary lamp has been brought into use.	► Visit an authorized Mercedes-Benz Center as soon as possible.
	Tail lamp Right Auxiliary lamp on!	The right tail lamp is malfunctioning. An auxiliary lamp has been brought into use.	► Visit an authorized Mercedes-Benz Center as soon as possible.
	Turn off lamps	You have removed the SmartKey from the starter switch and opened the driver's door or removed the SmartKey with KEYLESS-GO* from the vehicle and left the headlamps on.	Turn the exterior lamp switch to 0 .
	Turn signal Rear left Auxiliary lamp on!	The left rear turn signal lamp is malfunctioning. An auxiliary lamp has been brought into use.	► Replace the bulb as soon as possible.

Practical hints

What to do if ...

Left display	Right display	Possible cause	Possible solution
	Turn signal Rear right Auxiliary lamp on!	The right rear turn signal lamp is malfunctioning. An auxiliary lamp has been brought into use.	► Replace the bulb as soon as possible.
	Visit workshop!	The display for the lights is malfunctioning.	► Visit an authorized Mercedes-Benz Center as soon as possible.
	Raise roll-over bar	The roll bar is malfunctioning.	► Raise the roll bar using the roll bar button (▷ page 73). ► Have the roll bar checked by an authorized Mercedes-Benz Center.
	Seat belt system Drive to workshop	The seat belt system is malfunctioning.	► Visit an authorized Mercedes-Benz Center as soon as possible.
	TeleAid Drive to workshop	One or more main functions of the Tele Aid system are malfunctioning.	► Have the Tele Aid system checked by an authorized Mercedes-Benz Center.
	Function unavailable	This display appears if button  or  on the multifunction steering wheel is pressed and the vehicle is not equipped with a telephone.	

Practical hints

What to do if ...

Left display	Right display	Possible cause	Possible solution
	Tire pressure Please rectify	The tire inflation pressure is too low in one or more tires.	▶ Check and correct tire inflation pressure as required (▷ page 290).
	Tire pressure Caution Tire defect	One or more tires is deflating.	▶ Carefully bring the vehicle to a halt, avoiding abrupt steering and braking maneuvers. Observe the traffic situation around you. ▶ Change the wheel (▷ page 388). ▶ Vehicles with Tirefit: Temporarily repair tire using TIREFIT (▷ page 388) or contact Roadside Assistance. If tire cannot be temporarily repaired using TIREFIT, contact Roadside Assistance. ▶ Have the damaged wheel repaired or replaced at an authorized Mercedes-Benz Center.

Warning!



Do not drive with a flat tire. A flat tire affects the ability to steer or brake the vehicle.

You may lose control of the vehicle. Continued driving with a flat tire will cause excessive heat build-up and possibly a fire.

Practical hints

What to do if ...

Left display	Right display	Possible cause	Possible solution
	Tire pressure Check tires	The tire inflation pressure in one or more tires is already below the minimum value. The tire inflation pressure in one or more tires is low.	<ul style="list-style-type: none">▶ Carefully bring the vehicle to a halt, avoiding abrupt steering and braking maneuvers. Observe the traffic situation around you.▶ If necessary, change the wheel (> page 388).▶ Vehicles with Tirefit: If necessary, temporarily repair tire using TIREFIT (> page 388) or contact Roadside Assistance. If tire cannot be temporarily repaired using TIREFIT, contact Roadside Assistance.▶ Have the damaged wheel repaired or replaced at an authorized Mercedes-Benz Center.

Warning!



Do not drive with a flat tire. A flat tire affects the ability to steer or brake the vehicle. You may lose control of the vehicle. Continued driving with a flat tire will cause excessive heat build-up and possibly a fire.

Practical hints

What to do if ...

Left display	Right display	Possible cause	Possible solution
	Tire pressure, FL Caution Tire defect	The left front tire is deflating.	<ul style="list-style-type: none"> ▶ Carefully bring the vehicle to a halt, avoiding abrupt steering and braking maneuvers. Observe the traffic situation around you. ▶ Change the wheel (> page 388). ▶ Vehicles with Tirefit: Temporarily repair tire using TIREFIT (> page 388) or contact Roadside Assistance. If tire cannot be temporarily repaired using TIREFIT, contact Roadside Assistance. ▶ Have the damaged wheel repaired or replaced at an authorized Mercedes-Benz Center.
	Tire pressure, FL Check tires	The left front tire inflation pressure is low.	<ul style="list-style-type: none"> ▶ Carefully bring the vehicle to a halt. ▶ Check the tire. ▶ Check and adjust the tire inflation pressure. ▶ If necessary, change the wheel (> page 388).

Warning!



Do not drive with a flat tire. A flat tire affects the ability to steer or brake the vehicle.

You may lose control of the vehicle. Continued driving with a flat tire will cause excessive heat build-up and possibly a fire.

Practical hints

What to do if ...

Left display	Right display	Possible cause	Possible solution
	Tire pressure, FR Caution Tire defect	The right front tire is deflating.	<ul style="list-style-type: none"> ▶ Carefully bring the vehicle to a halt, avoiding abrupt steering and braking maneuvers. Observe the traffic situation around you. ▶ Change the wheel (▷ page 388). ▶ Vehicles with Tirefit: Temporarily repair tire using TIREFIT (▷ page 388) or contact Roadside Assistance. If tire cannot be temporarily repaired using TIREFIT, contact Roadside Assistance. ▶ Have the damaged wheel repaired or replaced at an authorized Mercedes-Benz Center.
	Tire pressure, FR Check tires	The right front tire inflation pressure is low.	<ul style="list-style-type: none"> ▶ Carefully bring the vehicle to a halt. ▶ Check the tire. ▶ Check and adjust the tire inflation pressure. ▶ If necessary, change the wheel (▷ page 388).

Warning!



Do not drive with a flat tire. A flat tire affects the ability to steer or brake the vehicle.

You may lose control of the vehicle. Continued driving with a flat tire will cause excessive heat build-up and possibly a fire.

Practical hints

What to do if ...

Left display	Right display	Possible cause	Possible solution
	Tire pressure, RL Caution Tire defect	The left rear tire is deflating.	<ul style="list-style-type: none"> ▶ Carefully bring the vehicle to a halt, avoiding abrupt steering and braking maneuvers. Observe the traffic situation around you. ▶ Change the wheel (▷ page 388). ▶ Vehicles with Tirefit: Temporarily repair tire using TIREFIT (▷ page 388) or contact Roadside Assistance. If tire cannot be temporarily repaired using TIREFIT, contact Roadside Assistance. ▶ Have the damaged wheel repaired or replaced at an authorized Mercedes-Benz Center.
	Tire pressure, RL Check tires	The left rear tire inflation pressure is low.	<ul style="list-style-type: none"> ▶ Carefully bring the vehicle to a halt. ▶ Check the tire. ▶ Check and adjust the tire inflation pressure. ▶ If necessary, change the wheel (▷ page 388).

Warning!



Do not drive with a flat tire. A flat tire affects the ability to steer or brake the vehicle.

You may lose control of the vehicle. Continued driving with a flat tire will cause excessive heat build-up and possibly a fire.

Practical hints

What to do if ...

Left display	Right display	Possible cause	Possible solution
	Tire pressure, RR Caution Tire defect	The right rear tire is deflating.	<ul style="list-style-type: none"> ▶ Carefully bring the vehicle to a halt, avoiding abrupt steering and braking maneuvers. Observe the traffic situation around you. ▶ Change the wheel (▷ page 388). ▶ Vehicles with Tirefit: Temporarily repair tire using TIREFIT (▷ page 388) or contact Roadside Assistance. If tire cannot be temporarily repaired using TIREFIT, contact Roadside Assistance. ▶ Have the damaged wheel repaired or replaced at an authorized Mercedes-Benz Center.
	Tire pressure, RR Check tires	The right rear tire inflation pressure is low.	<ul style="list-style-type: none"> ▶ Carefully bring the vehicle to a halt. ▶ Check the tire. ▶ Check and adjust the tire inflation pressure. ▶ If necessary, change the wheel (▷ page 388).

Warning!





Do not drive with a flat tire. A flat tire affects the ability to steer or brake the vehicle.

You may lose control of the vehicle. Continued driving with a flat tire will cause excessive heat build-up and possibly a fire.

Practical hints

What to do if ...

Left display	Right display	Possible cause	Possible solution
	Close trunk lid	This message will appear whenever the trunk lid is open.	▶ Close the trunk lid.
	Close trunk partition	You are trying to open or close the retractable hardtop even though the luggage cover in the trunk is not pulled out.	▶ Pull out the luggage cover and secure it (▷ page 197).
	Washer fluid Check level	The fluid level has dropped to about $\frac{1}{3}$ of total reservoir capacity.	▶ Add washer fluid (▷ page 278).

Warning!



Do not spill antifreeze on hot engine parts. Antifreeze contains ethylene glycol which may ignite when it comes into contact with hot engine parts. You could be seriously burned.

Practical hints

Where will I find ...?

First aid kit

The first aid kit is located in storage compartment under the passenger seat.

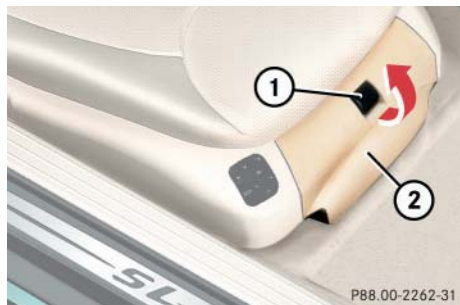

- ① Handle
- ② Lid

- ▶ Pull handle ① up.
- ▶ Fold lid ② down.

You can now remove the first-aid kit.



Check expiration dates and contents for completeness at least once a year and replace missing/expired items.

Vehicle tool kit, jack, and spare wheel

The vehicle tool kit, jack, and spare wheel are stored in the space underneath the trunk floor.

- ▶ Lift up the trunk floor cover.

You can now remove the tools and accessories.

The vehicle tool kit includes

- One pair of universal pliers
- Two open-end wrenches
- One hex-socket wrench
- One interchangeable slot/Phillips screwdriver

- One towing eye bolt
- One alignment bolt
- One fuse extractor
- One fuse chart for the main fuse box
- Spare fuses

The jack is exclusively designed for lifting the vehicle during a wheel change. Always lower the vehicle on sufficient capacity jack stands before working under the vehicle.

Practical hints

Where will I find ...?

Vehicles with spare wheel

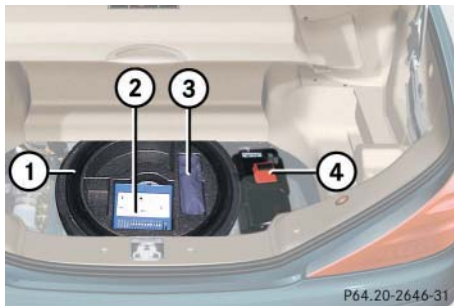

- ① Spare wheel
- ② Electric air pump
- ③ Vehicle tool kit
- ④ Battery for electrical consumers



- ⑤ Jack (under spare wheel)
- ⑥ Wheel wrench (under spare wheel)

Vehicles with TIREFIT kit (SL 65 AMG only)

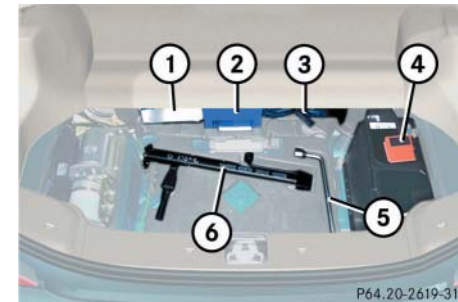

- ① TIREFIT kit
- ② Electric air pump
- ③ Vehicle tool kit
- ④ Battery for electrical consumers
- ⑤ Wheel wrench
- ⑥ Jack

Practical hints

Locking/unlocking in an emergency

Unlocking the vehicle

If you are unable to unlock the driver's door using the SmartKey, open the door using the mechanical key.



Unlocking your vehicle with the mechanical key will trigger the anti-theft alarm system. To cancel the alarm, do one of the following:

- Press button or on the SmartKey.
- Insert the SmartKey in the starter switch.
- Press the KEYLESS-GO* start/stop button (▷ page 37).
- Grasp the outside door handle (vehicles with KEYLESS-GO* only).



① Mechanical key locking tab

② Mechanical key

- ▶ Move locking tab ① direction of arrow and slide the mechanical key ② out of the housing.

Unlocking the driver's door

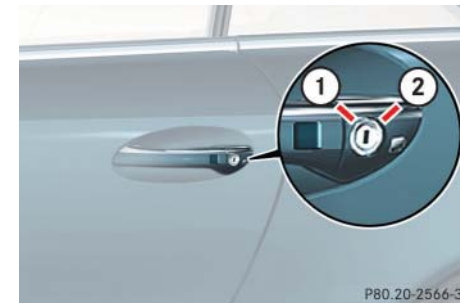

① Unlocking

② Locking

- ▶ Unlock the door with the mechanical key. To do so, push the mechanical key in the lock until it stops and turn it to the left.

Unlocking the trunk

A minimum height clearance of 6.2 ft (1.89 m) is required to open the trunk lid.

If you are unable to unlock the trunk with the SmartKey, open the trunk with the mechanical key.

The handle is located above the rear license plate recess.

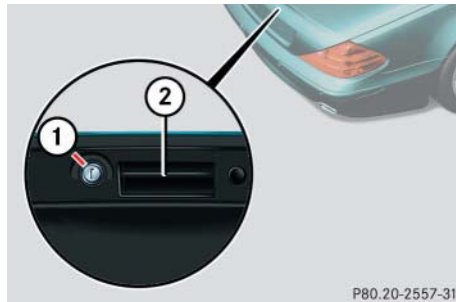

P80.20-2557-31



Trunk lid lock

- ① Unlocking
- ② Handle

- ▶ Insert the mechanical key into the trunk lid lock.
- ▶ Turn the mechanical key counterclockwise to position ① and hold it in this position.
- ▶ Pull the trunk lid handle ② and lift lid.



Unlocking your vehicle with the mechanical key will trigger the anti-theft alarm system. To cancel the alarm, do one of the following:

- Press button  or  on the SmartKey.
- Insert the SmartKey in the starter switch.
- Press the KEYLESS-GO* start/stop button (▷ page 37).
- Grasp the outside door handle (vehicles with KEYLESS-GO* only).

Unlocking interior storage compartments

Locking storage areas in the passenger compartment include:

- the glove box
- the storage compartment under the armrest
- the rear storage compartments

If these cannot be unlocked by means of the SmartKey, the SmartKey with KEYLESS-GO*, or the central locking button, use the mechanical key to open the glove box.



The storage compartment under the armrest and the rear storage compartments can only be unlocked at the glove box lock using the mechanical key.

Practical hints

Locking/unlocking in an emergency

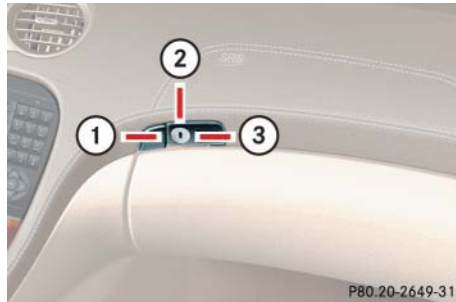

- ① Separately unlock storage compartments
 - ② Centrally lock/unlock storage compartments
 - ③ Separately lock storage compartments
- ▶ Slide mechanical key out of SmartKey housing (▷ page 374).
 - ▶ Insert the mechanical key into the glove box lock and turn it to position ②.

All storage compartments are now unlocked.

Locking the vehicle

If you are unable to lock the vehicle with the SmartKey, lock it with the mechanical key as follows:

- ▶ Close the passenger door and the trunk lid.
- ▶ Press the central locking switch in the center console (▷ page 110).
- ▶ Check to see whether the locking knob on the passenger door is still visible. If necessary push it down manually.
- ▶ Slide the mechanical key out of the SmartKey.
- ▶ Lock the driver's door with the mechanical key.

Lowering the load assist manually

If the load assist feature does not fully lower the retractable hardtop into the trunk compartment and you are unable to close the trunk lid, follow the instructions below.

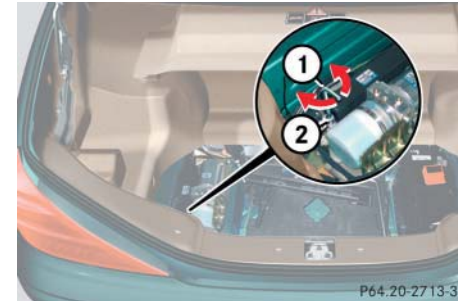

- ① Hex-socket wrench
- ② Locking screw

- ▶ Remove the trunk floor from the trunk.
- ▶ Lift up the lid located at the lower left side of the trunk.
- ▶ Have a second person lift and hold the retracted hardtop.

- ▶ Using the hex-socket wrench provided in the vehicle tool kit, carefully turn the locking screw ② approximately one quarter turn.
- ▶ Hook luggage cover into holders (▷ page 197).
- ▶ Let go of the hardtop. It should gradually lower into the trunk.
- ▶ When top is completely lowered, return locking screw ② to its original position.



Do not overtighten the screw.

- ▶ Close the lid.
- ▶ Replace the trunk floor.
- ▶ Visit an authorized Mercedes-Benz Center as soon as possible.

Replacing batteries in the SmartKey/ SmartKey with KEYLESS-GO*

If the batteries in the SmartKey or the SmartKey with KEYLESS-GO* are discharged, the vehicle can no longer be locked or unlocked. It is recommended to have the batteries replaced at an authorized Mercedes-Benz Center.

Warning!



Keep the batteries out of reach of children.

If a battery is swallowed, seek medical help immediately.

Batteries contain materials that can harm the environment if disposed of improperly. Recycling of batteries is the preferred method of disposal. Many states require sellers of batteries to accept old batteries for recycling.

SmartKey



When replacing batteries, always replace both batteries. The required replacement batteries are available at any Mercedes-Benz Center.

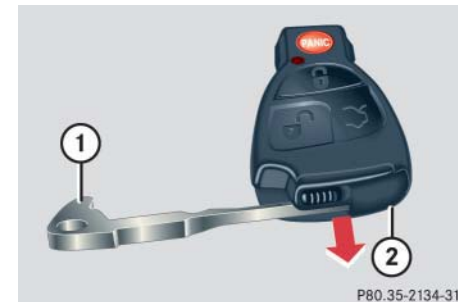

- ① Mechanical key
- ② Battery compartment

Replacement batteries: Lithium, type CR 2025 or equivalent.

Practical hints

Locking/unlocking in an emergency

- ▶ Remove mechanical key (▷ page 374).
- ▶ Insert the mechanical key ① in side opening and push gray slide.
The battery compartment is unlatched.
- ▶ Pull battery compartment ② out of the SmartKey housing in direction of arrow.
- ▶ Remove the batteries.
- ▶ Using a lint-free cloth, insert new batteries under the contact spring with the plus (+) side facing up.
- ▶ Return battery compartment into housing until it locks into place.

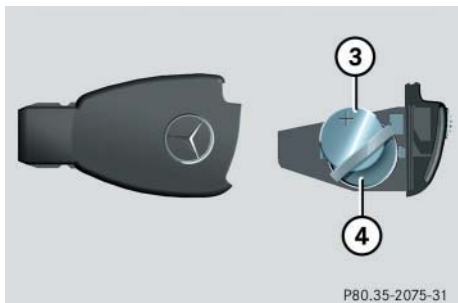

- ③ Battery
- ④ Contact spring

SmartKey with KEYLESS-GO*

i

The required replacement batteries are available at any Mercedes-Benz Center.

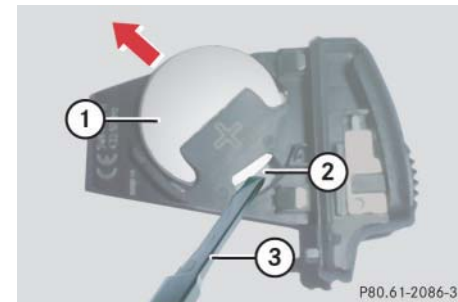

- ① Battery
- ② Tilt battery up
- ③ Mechanical key

Replacement batteries: Lithium, type CR 2025 or equivalent.

- ▶ Remove mechanical key (▷ page 374).
- ▶ Insert the mechanical key in side opening and push gray slide.
The battery compartment is unlatched.
- ▶ Pull the battery compartment out of the SmartKey housing.
- ▶ Using mechanical key ③, apply pressure to position ②.
Battery ① tilts up slightly.
- ▶ Pull battery ① out in direction of arrow.
- ▶ Using a lint-free cloth, insert new batteries under the contact spring with the plus (+) side facing up.
- ▶ Return battery compartment into housing until it locks into place.

Practical hints

Replacing bulbs

Bulbs

Safe vehicle operation depends on proper exterior lighting and signaling. It is therefore essential that all bulbs and lamp assemblies are in good working order at all times.

Correct headlamp adjustment is extremely important. Have headlamps checked and readjusted at regular intervals and when a bulb has been replaced. See an authorized Mercedes-Benz Center for headlamp adjustment.



If the headlamps or front fog lamps are fogged up on the inside as a result of high humidity, driving the vehicle a distance with the lights on should clear up the fogging.



Backup lamps will be brought into use when the following lamps malfunction:

- Turn signal lamps
- Brake lamps
- Parking lamps
- Tail lamps

Observe the messages in the multi-function display (▷ page 335).

Practical hints

Replacing bulbs

Front lamps

Lamp	Type
① Additional turn signal	LED
② Turn signal lamp	1156 NA
③ Low beam ¹	D2S-35W
④ Xenon headlamps: High beam, high beam flasher	H7 (55W)
Bi-Xenon* head- lamps: High beam flasher	H7 (55W)
Parking and standing lamps	W 5 W
⑤ Fog lamp	HB4 (51W)
⑥ Side marker lamp	W 5 W

¹ Vehicles with Bi-Xenon* headlamps: Low beam and high beam use the same D2S-35W lamp. Do not replace the Xenon and Bi-Xenon* bulbs yourself. See an authorized Mercedes-Benz Center.

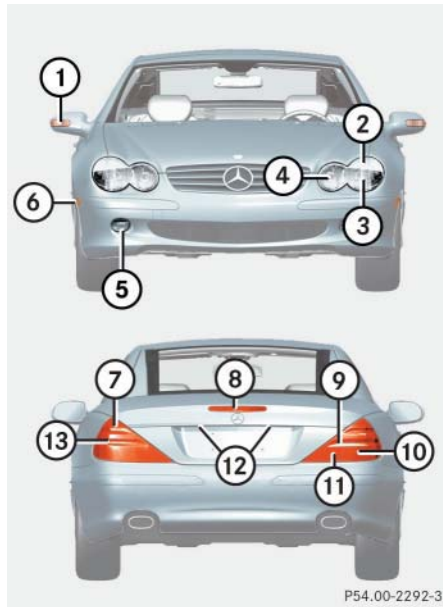

Rear lamps

Lamp	Type
⑦ Rear fog lamp (driver's side only); replacement	P 21 W 1156/32 cp
⑧ High mounted brake lamp	LED
⑨ Backup lamp; replacement	P 21 W 1156/32 cp
⑩ Tail, parking and standing lamp, side marker lamp	LED
⑪ Tail, parking and standing lamp, brake lamp	LED
⑫ License plate lamps	C 5 W
⑬ Turn signal lamp; replacement	P 21 W 1156/32 cp

Practical hints

Replacing bulbs

Warning!



Bulbs and bulb sockets can be very hot. Allow the lamp to cool down before changing a bulb.

Keep bulbs out of reach of children.

Halogen lamps contain pressurized gas. A bulb can explode if you:

- touch or move it when hot
- drop the bulb
- scratch the bulb

Wear eye and hand protection.

Because of high voltage in Xenon lamps, it is dangerous to replace the bulb or repair the lamp and its components. We recommend that you have such work done by a qualified technician.

Notes on bulb replacement

- Only use 12-volt bulbs of the same type and with the specified watt rating.
- Switch the lights off before changing a bulb to prevent short circuits.
- Always use a clean lint-free cloth when handling bulbs.
- Your hands should be dry and free of oil and grease.
- If the newly installed bulb does not come on, visit an authorized Mercedes-Benz Center.

Have the LEDs and bulbs for the following lamps replaced by an authorized Mercedes-Benz Center:

- the additional turn signals in the exterior or rear view mirrors
- the high mounted brake lamp
- the brake lamps
- the parking lamps and the side marker lamps in the tail lamp unit
- the rear fog lamps
- the low beam (Xenon or Bi-Xenon*) lamps
- the front fog lamps



Have the headlamp adjustment checked regularly.

Replacing bulbs for front lamps

Before you start to replace a bulb for a front lamp, do the following first:

- ▶ Turn the exterior lamp switch to position **0** (▷ page 123).
- ▶ Open the hood (▷ page 270) (except for side marker lamps).

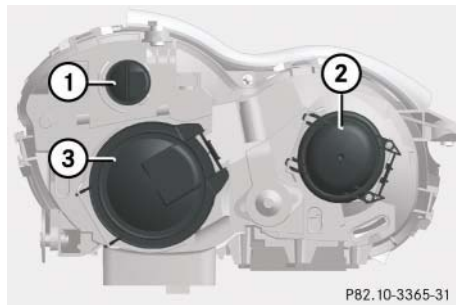

- ① Bulb socket for turn signal lamp
- ② High beam headlamp cover
- ③ Low beam headlamp cover (Xenon or Bi-Xenon* lamp). **Do not remove.**



- ④ High beam bulbs
- ⑤ Locking mechanism
- ⑥ Parking and standing lamps

Warning!



Do not remove the cover for the Xenon or Bi-Xenon* headlamp. Because of high voltage in Xenon and Bi-Xenon* lamps, it is dangerous to replace the bulb or repair the lamp and its components. We recommend that you have such work done by a qualified technician.

Practical hints

Replacing bulbs

Front turn signal bulb

- ▶ Turn bulb socket ① counterclockwise and pull it out.
- ▶ Push the bulb into socket ①, turn socket ① counterclockwise and remove it.
- ▶ Insert the new bulb in socket ①, push and turn bulb socket ① clockwise.
- ▶ Reinsert bulb socket ① in lamp and turn bulb socket ① clockwise.

Practical hints

Replacing bulbs

High beam/ high beam flasher bulbs

- ▶ Press ends of headlamp cover tab together and remove high beam headlamp cover ②.
- ▶ Pull the electrical connector off.
- ▶ Turn locking mechanism ⑤ counterclockwise and take out the bulb.
- ▶ Insert the new bulb so that the base locates in the recess on the holder.
- ▶ Turn locking mechanism ⑤ clockwise.
- ▶ Plug the connector onto the bulb.
- ▶ Align high beam headlamp cover ② and click it into place.

Parking and standing lamp bulbs

- ▶ Press ends of cover tab together and remove high beam headlamp cover ②.
- ▶ Pull out bulb socket ⑥ with the bulb.
- ▶ Pull the bulb out of bulb socket ⑥.
- ▶ Insert a new bulb in bulb socket ⑥.
- ▶ Reinstall bulb socket ⑥.
- ▶ Align high beam headlamp cover ② and click it into place.

Side marker bulbs

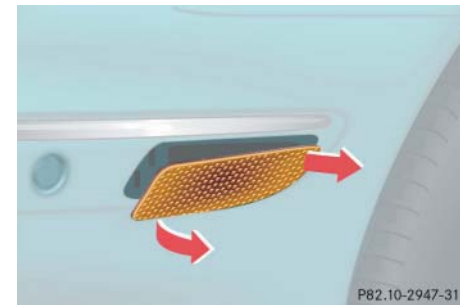

- ▶ Carefully slide the side marker lamp towards rear.
- ▶ Remove the front end first.
- ▶ Turn the bulb socket counterclockwise and pull it out.
- ▶ Pull the bulb out of the bulb socket.
- ▶ Insert the new bulb in socket.
- ▶ Reinstall the bulb socket, push it in, and turn it clockwise.
- ▶ To reinstall the side marker lamp, set the rear end in bumper and let the front end snap into place.

Replacing bulbs for rear lamps

Before you start to replace a bulb for a rear lamp, do the following first:

- ▶ Turn the exterior lamp switch to position **0** (▷ page 123).
- ▶ Open the trunk (▷ page 107).

Tail lamp unit

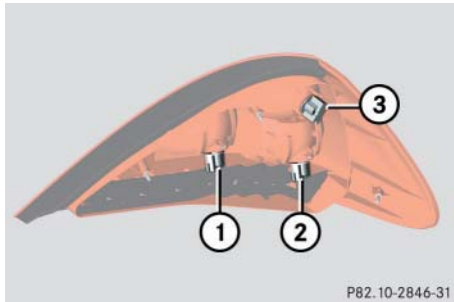

- ① Backup lamp
- ② Turn signal lamp
- ③ Driver's side: Rear fog lamp
Passenger's side: Substitute lamp

- ▶ Fold the trim to the side and remove it.
- ▶ Turn the bulb socket counterclockwise and pull it out.
- ▶ Gently push the bulb into the socket, turn it counterclockwise and remove it.
- ▶ Insert the new bulb and reinstall the bulb socket.
The bulb socket should audibly click into place.
- ▶ Reinstall the trim.

Practical hints

Replacing bulbs

License plate lamp

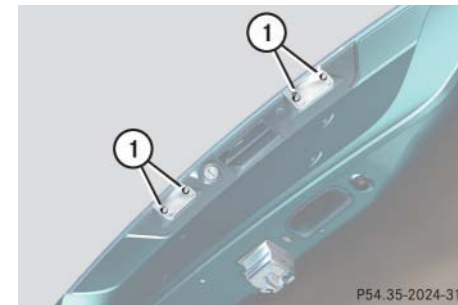

- ① Screws
- ▶ Loosen both screws ①.
- ▶ Remove the license plate lamp.
- ▶ Replace the bulb.
- ▶ Reinstall the license plate lamp.
- ▶ Retighten screws ①.

Practical hints

Replacing wiper blades



To avoid damage to the hood, the wiper arms should only be folded forward when in the vertical position.



Removing wiper blades

Warning!



For safety reasons, switch off wipers and remove SmartKey from starter switch (vehicles with KEYLESS-GO*): Make sure the vehicle's on-board electronics have status **0** before replacing a wiper blade. Otherwise the wiper motor could suddenly turn on and cause injury.

- ▶ Turn SmartKey in starter switch to position **1**.
- ▶ Turn combination switch to wiper setting **II** (▷ page 53).
- ▶ With wiper arms in the vertical position, turn SmartKey in starter switch to position **0**.

- ▶ Fold the wiper arm forward until it snaps into place.

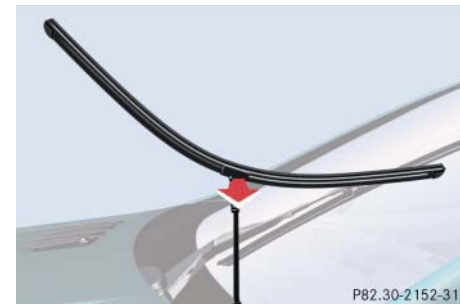

- ▶ Turn wiper blade at a right angle to the wiper arm.
- ▶ Slide the wiper blade sideways out of the retainer.

Installing wiper blades

- ▶ Slide the wiper blade onto the wiper arm until it locks in place.
- ▶ Rotate the wiper blade into a position parallel to the wiper arm.
- ▶ Fold the wiper arm backward to rest on the windshield. Make sure you hold on to the wiper when folding the wiper arm back.



Never open the hood when the wiper arms are folded forward.

Hold on to the wiper when folding the wiper arm back. If released, the force of the impact from the tensioning spring could crack the windshield.

Do not allow the wiper arms to contact the windshield glass without a wiper blade inserted.

Make sure the wiper blades are properly installed. Improperly installed wiper blades may cause windshield damage.

For your convenience, we recommend that you have this work carried out by an authorized Mercedes-Benz Center.

Practical hints

Flat tire

Your SL 65 AMG is be equipped with a TIREFIT kit.

Preparing the vehicle

- ▶ Park the vehicle as far as possible from moving traffic on a hard surface.
- ▶ Turn on the hazard warning flashers.
- ▶ Turn the steering wheel so that the front wheels are in a straight ahead position.
- ▶ Set the parking brake.
- ▶ Move the gear selector lever to **P**.

Vehicles with SmartKey:

- ▶ Turn off the engine (▷ page 58).
- ▶ Remove the SmartKey from the starter switch.

Vehicles with KEYLESS-GO*:

- ▶ Turn off the engine by pressing the KEYLESS-GO* button on the gear selector lever once (▷ page 59).
- ▶ Open the driver's door (this puts the starter switch in position **0**, same as with the SmartKey removed from the starter switch). The driver's door then can be closed again.



Open door only when conditions are safe to do so.

- ▶ Have any passenger exit the vehicle at a safe distance from the roadway.

Sealing tires with TIREFIT

Warning!



Keep TIREFIT away from sparks, open flame or heat source.

Do not smoke.

Small tire punctures, particularly those in the tread, can be sealed with TIREFIT. TIREFIT can be used in ambient temperatures down to -4 °F (-20 °C).

Practical hints

Flat tire

Warning!



TIREFIT is a limited repair device. TIREFIT cannot be used for cuts or punctures larger than approx. 0.16 in (4 mm) and tire damage caused by driving with extremely low tire inflation pressure, or on a flat tire, or a damaged wheel.

Do not drive the vehicle under such circumstances.

Contact your nearest Mercedes-Benz Center for assistance or call Roadside Assistance.

- ▶ Foreign objects (e.g. screws or nails) should not be removed from the tire.
- ▶ Take TIREFIT, the sticker, and the electric air pump out of the trunk.
- ▶ Attach the sticker where it will be easily seen by the driver on the instrument cluster.

Warning!



Take care not to allow the contents of TIREFIT to come in contact with hair, eyes or clothing. TIREFIT is harmful if inhaled, swallowed or absorbed through the skin - causes skin, eye and respiratory irritation.

Any contact with eyes or skin should be flushed immediately with plenty of water.

If clothing comes in contact with TIREFIT, change clothing as soon as possible.

In case of allergic reaction or rash, consult a physician immediately.

Warning!



Keep TIREFIT out of reach of children. If swallowed, rinse mouth immediately with plenty of water and drink plenty of water. Do not induce vomiting! Consult a physician immediately. Keep away from open flame or heat source.

i

If sealant has leaked out, let it dry. You can then peel it off.

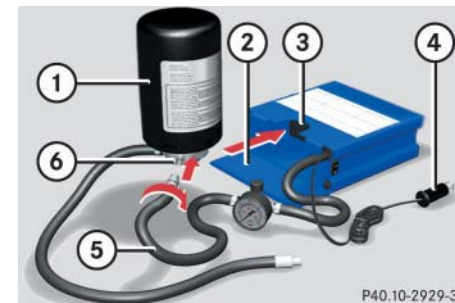

P40.10-2929-31

- ① TIREFIT container
- ② Flap
- ③ Notch
- ④ Electrical plug
- ⑤ Air hose
- ⑥ Flange

- ▶ Open flap ② on the electric air pump.
- ▶ Pull plug ④ and air hose ⑤ out of the pump housing. ▷▷

Practical hints

Flat tire

- ▶▶ Screw the air pump's air hose ⑤ onto flange ⑥ of the TIREFIT container.
- ▶ Stick TIREFIT container ① upside down into notch ③ of the electric air pump.

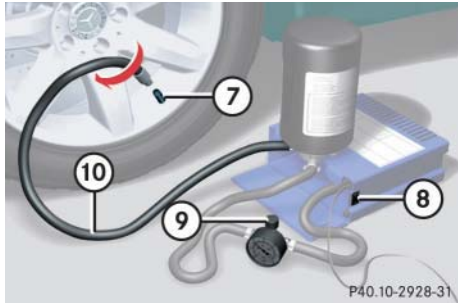

- ⑦ Tire valve
- ⑧ Electric air pump switch
- ⑨ Air hose with pressure gauge and vent screw
- ⑩ Filler hose

Warning!



Observe safety instructions on air pump label.

- ▶ Unscrew the valve cap from tire valve ⑦.
- ▶ Screw filler hose ⑩ onto tire valve ⑦.
- ▶ Insert electrical plug ④ into vehicle cigarette lighter socket.
- ▶ Turn the SmartKey in the starter switch to position 1 (▶ page 36).
- or
- ▶ Press the KEYLESS-GO* start/stop button (▶ page 37) on the gear selector lever once. Do not depress brake pedal.
- ▶ Press I on electric air pump switch ⑧.

The electric air pump should now switch on and inflate the tire.



Do not operate the electric air pump longer than eight minutes without interruption. Otherwise it may overheat.

You may operate the air pump again after it has cooled off.

After 5 minutes, the pressure gauge must display at least 26 psi (1.8 bar). The air hose can become hot during inflation. Please exercise appropriate caution.

- ▶ If this tire inflation pressure is not attained, turn off the electric air pump, detach the filler hose from the tire valve, and drive vehicle back and forth very slowly approximately 30 ft (10 m).

This serves to better distribute the TIREFIT sealant material inside the tire.

- ▶ Unscrew the air pump's air hose ⑤ from flange ⑥ of the TIREFIT container.
- ▶ Screw air hose ⑤ onto tire valve ⑦.
- ▶ Inflate the tire again.

Warning!



If a tire inflation pressure of 26 psi (1.8 bar) is not attained, tire is too severely damaged for TIREFIT to provide a reliable tire repair.

In this case, TIREFIT cannot properly seal the tire.

Do not drive the vehicle.

Contact the nearest Mercedes-Benz Center or call Roadside Assistance.

- ▶ After attaining a tire inflation pressure of 26 psi (1.8 bar), press 0 on electric air pump switch ⑧.

The electric air pump should now be switched off.

- ▶ Turn the SmartKey in the ignition to position 0 (▷ page 36).
or
- ▶ Press the KEYLESS-GO* start/stop button (▷ page 37) on the gear selector lever twice. Do not depress brake pedal.
- ▶ Detach the electric air pump.
The air hose may still be hot. Please exercise appropriate caution.
- ▶ Store the electrical plug and the air hose behind the flap and place the air pump back in the trunk.
- ▶ Close the trunk lid.
- ▶ Drive away immediately.
The TIREFIT sealant will distribute itself evenly inside the tire.

Practical hints

Flat tire

Warning!



Do not exceed vehicle speed of 50 mph (80 km/h). A TIREFIT repair is not designed to operate at higher speeds.

The sticker must be attached on the instrument cluster where it will be easily seen by the driver.

Vehicle handling characteristics may change. Adapt your driving accordingly.



Practical hints

Flat tire

- ▶▶ After driving vehicle for an initial 10 minutes, check tire inflation pressure using the pressure gauge on the air pump.

Warning!



If tire inflation pressure has fallen below 20 psi (1.3 bar) do not continue to drive the vehicle.

Park your vehicle safely away from the roadway and contact the nearest authorized Mercedes-Benz Center or Roadside Assistance.

If tire inflation pressure is at least 20 psi (1.3 bar), inflate tire to correct pressure (see placard on the driver's door B-pillar), and drive vehicle to nearest tire repair facility to have tire repaired or replaced.

Recommended duration of use:
300 miles (500 km) at 50 mph (80 km/h)
with the recommended tire inflation pressure.

Warning!



Follow recommend inflation pressures.

Do not overinflate tires. Overinflating tires can result in sudden deflation (blowout) because they are more likely to become punctured or damaged by road debris, potholes, etc.

Do not underinflate tires. Underinflated tires wear unevenly, adversely affect handling and fuel economy, and are more likely to fail from being overheated.

Do not overload the tires by exceeding the specified vehicle capacity weight (as indicated by the label on the pillar in the driver's door opening). Overloading the tires can overheat them, possibly causing a blowout.

- ▶ Visit an authorized Mercedes-Benz Center as soon as possible to obtain a new TIREFIT kit.
- ▶ Bring used TIREFIT materials to an authorized Mercedes-Benz Center for proper disposal.

Warning!



Do not exceed vehicle speed of 50 mph (80 km/h). A TIREFIT repair is not designed to operate at higher speeds.

The sticker must be attached on the instrument cluster where it will be easily seen by the driver.

Vehicle handling characteristics may change. Adapt your driving accordingly.

- ▶ Replace your TIREFIT container every four years. Replacement containers are available at your authorized Mercedes-Benz Center.

Mounting the spare wheel

Warning!



The dimensions of the spare wheel are different from those of the road wheels. As a result, the vehicle handling characteristics change when driving with a mounted spare wheel. Adapt your driving style accordingly.

The spare wheel is for temporary use only. When driving with spare wheel mounted, ensure proper tire inflation pressure and do not exceed vehicle speed of 50 mph (80 km/h).

Drive to the nearest Mercedes-Benz Center as soon as possible to have the spare wheel replaced with a regular road wheel.

Never operate the vehicle with more than one spare wheel mounted.

Preparing the vehicle

Prepare the vehicle as described (▷ page 388).

- ▶ Turn spare wheel bracket counter-clockwise to loosen.
- ▶ Take the spare wheel out of the trunk.

Lifting the vehicle

- ▶ Prevent the vehicle from rolling away by blocking wheels with wheel chocks (not included) or other sizable objects.

When changing wheel on a level surface:

- ▶ Place one chock in front of and one behind the wheel that is diagonally opposite to the wheel being changed.

When changing wheel on a hill:

- ▶ Place chocks on the downhill side blocking both wheels of the other axle.

Practical hints

Flat tire

- ▶ Take the vehicle tool kit and the jack out of the storage compartment under the trunk floor (▷ page 372).

Warning!



The jack is designed exclusively for jacking up the vehicle at the jack tubes built into both sides of the vehicle. To help avoid personal injury, use the jack only to lift the vehicle during a wheel change. Never get beneath the vehicle while it is supported by the jack. Keep hands and feet away from the area under the lifted vehicle. Always firmly set parking brake and block wheels before raising vehicle with jack.

Do not disengage parking brake while the vehicle is raised. Be certain that the jack is always vertical (plumb line) when in use, especially on hills. Always try to use the jack on level surface. Be sure that the jack arm is fully inserted in the jack tube. Always lower the vehicle onto sufficient capacity jack-stands before working under the vehicle. ▷▷

Practical hints

Flat tire

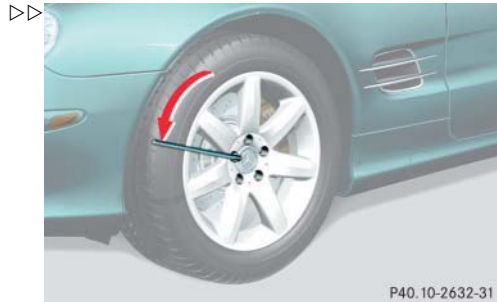

- ▶ On wheel to be changed, loosen but do not yet remove the wheel bolts (approximately one full turn with wrench).

The jack support tubes are located behind the front wheel housings and in front of the rear wheel housings.

Warning



When turning the wheel wrench to loosen the wheel bolts, make sure you position hands on the wrench in such a way that you avoid injury to yourself, such as scraping your hands against the wheel. Make sure turning the wheel wrench will not scratch or damage the wheel rim.

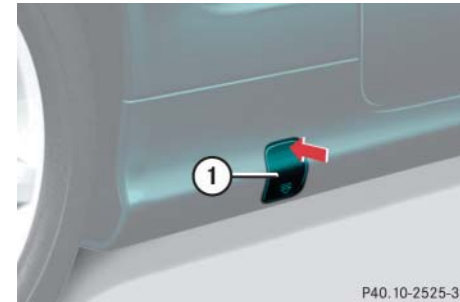

- ① Jack support tube cover (except SL 55 AMG, SL 65 AMG and vehicles with Sport Package*)
- ▶ Open cover ① by pressing at point indicated by arrow.
- ▶ Remove cover ①, taking care not to damage the locking tabs.

Practical hints

Flat tire

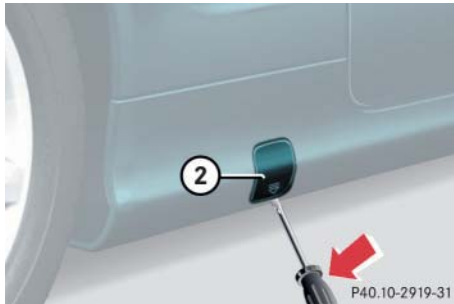

- ② Jack support tube hole (SL 55 AMG, SL 65 AMG and vehicles with Sport Package* only)
- ▶ Insert a flat blade screwdriver in the opening of cover ② and pry it out.
- ▶ Remove cover ②, taking care not to damage the locking tabs.

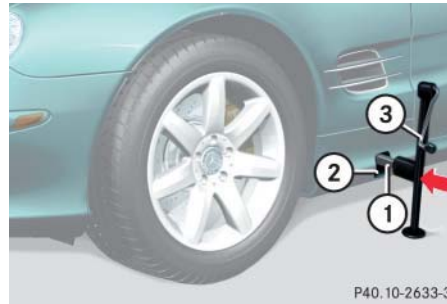

- ① Jack arm
- ② Jack support tube hole
- ③ Crank
- ▶ Insert jack arm ① fully into tube hole ② up to the stop.

Warning!



Insert the jack arm fully into the jack support tube hole up to the stop. Otherwise the vehicle may fall from the jack and cause personal injury or damage to the vehicle.

- ▶ Keeping jack in this position, turn crank ③ clockwise until the jack base meets the ground. Make sure the jack is vertical (plumb line).
- ▶ Continue to turn the crank until the tire is a maximum of 1.2 in (3 cm) from the ground.

Practical hints

Flat tire

Removing the wheel

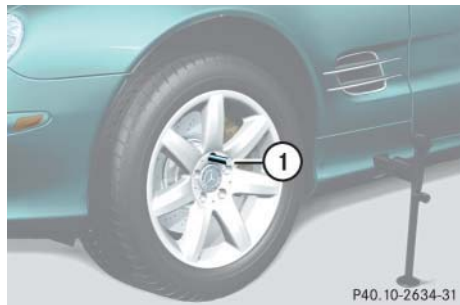

- ① Alignment bolt
- ▶ Unscrew upper-most wheel bolt and remove.
- ▶ Replace this wheel bolt with alignment bolt ① supplied in the tool kit.
- ▶ Remove the remaining bolts.



Do not place wheel bolts in sand or dirt. This could result in damage to the bolt and wheel hub threads.

- ▶ Remove the wheel.

Mounting the new wheel

Warning!



Inflate spare wheel tire only after the wheel is properly mounted.

Inflate the spare wheel tire using the electric pump (> page 397) before lowering the vehicle.

- ▶ Clean contact surfaces of wheel and wheel hub.
- ▶ Guide the spare wheel onto the alignment bolt and push it on.
- ▶ Insert wheel bolts and tighten them slightly.

Warning!



Always replace wheel bolts that are damaged or rusted.

Never apply oil or grease to wheel bolts.

Damaged wheel hub threads should be repaired immediately. Do not continue to drive under these circumstances! Contact an authorized Mercedes-Benz Center or call Roadside Assistance.

Incorrect wheel bolts or improperly tightened wheel bolts can cause the wheel to come off. This could cause an accident. Be sure to use the correct wheel bolts.

Warning!



Only use genuine equipment Mercedes-Benz wheel bolts. They are identified by the Mercedes star. Other wheel bolts may come loose.

Do not tighten the wheel bolts when the vehicle is raised. Otherwise the vehicle could tip over.

- ▶ Unscrew the alignment bolt, install last wheel bolt and tighten slightly.

Inflating the spare tire



Do not lower the vehicle before inflating the spare wheel tire. Otherwise the rim may be damaged.

- ▶ Take the electric air pump out of the trunk (▷ page 372).

Warning!



Observe instructions on air pump label.

Practical hints

Flat tire

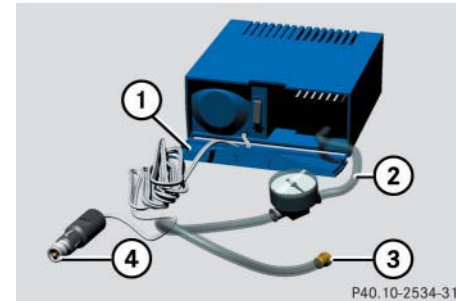

- ① Flap
- ② Air hose with pressure gauge and vent screw
- ③ Union nut
- ④ Electrical plug

- ▶ Open flap ① on air pump.
- ▶ Pull out electrical plug ④ and air hose with the pressure gauge ②.
- ▶ Remove the valve cap from the tire valve.
- ▶ Screw air hose ② onto the tire valve.
- ▶ Insert electrical plug ④ into vehicle cigar lighter socket. ▷▷

Practical hints

Flat tire

- ▷▷▶ Turn the SmartKey in the starter switch to position **1**.
or
- ▶ Press the KEYLESS-GO* start/stop button on the gear selector lever once without depressing the brake pedal.
- ▶ Press **I** on the electric air pump switch.
The electric air pump should now switch on and inflate the tire.
- ▶ Inflate the tire to approx. 36 psi (2.5 bar).

This takes about five minutes for the spare tire. Air hose ② and union nut ③ can become hot during inflation. Exercise proper caution to avoid burning yourself when using the equipment.



Do not operate the air pump longer than eight minutes without interruption. Otherwise it may overheat.

You may operate the air pump again after it has cooled off.

- ▶ Press **0** on the electric air pump switch.
- ▶ Turn the SmartKey in the starter switch to position **0**.
or
- ▶ Press KEYLESS-GO* start/stop button on the gear selector lever twice without depressing the brake pedal.
The electric air pump should now be switched off.
- ▶ If the tire inflation pressure is above 36 psi (2.5 bar), release excess tire inflation pressure using the vent screw.

Warning!



Follow recommend inflation pressures.

Do not overinflate tires. Overinflating tires can result in sudden deflation (blowout) because they are more likely to become punctured or damaged by road debris, potholes, etc.

Do not underinflate tires. Underinflated tires wear unevenly, adversely affect handling and fuel economy, and are more likely to fail from being overheated.

- ▶ Detach the electric air pump.
- ▶ Stow the electrical plug and the air hose behind the flap and place the air pump back in the trunk.



The flat tire may be transported in the trunk when the retractable hardtop is raised. Use the protective sheet provided with the spare wheel. Do not activate the tire inflation pressure monitor until the deflated tire has been removed from the vehicle.

Lowering the vehicle

- ▶ Lower vehicle by turning crank counterclockwise until the full weight of the vehicle is resting on the ground.
- ▶ Pull the jack out of the jack support tube.

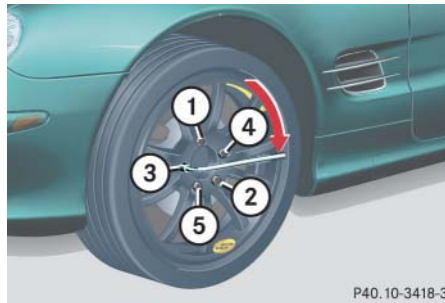

① - ⑤ Wheel bolts

- ▶ Tighten the five wheel bolts evenly, following the diagonal sequence illustrated (① to ⑤), until all bolts are tight. Observe a tightening torque of 96 lb-ft (130 Nm).

Practical hints

Flat tire

Warning!



Have the tightening torque checked after changing a wheel. The wheels could come loose if they are not tightened to a torque of 96 lb-ft (130 Nm).

Warning



When turning the wheel wrench to tighten the wheel bolts, make sure you position hands on the wrench in such a way that you avoid injury to yourself, such as scraping your hands against the wheel. Make sure turning the wheel wrench will not scratch or damage the wheel rim.

- ▶ Before storing the jack in the trunk, crank back to storage position and fold in the arm.

Practical hints

Flat tire

Replacing jack support tube cover

- ▶ Slide tongue of cover under the upper edge of the tube opening.
- ▶ Applying even pressure, press cover until it snaps into place.

Be careful not to damage the locking tabs or clamp the plastic retaining strap.

▼ Batteries

For more information on batteries, see “Battery” (▷ page 277).

Your vehicle is equipped with two batteries:

- The starter battery
- The battery for electrical consumers (consumer battery), located in the trunk

The starter battery is located on the right-hand side of the engine compartment.

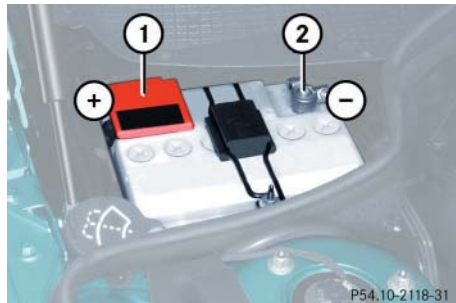

- ① Positive terminal
- ② Negative terminal



The starter battery, its filler caps, and the vent tube must always be securely installed when the vehicle is in operation.

The consumer battery is located on the right-hand side of the trunk.

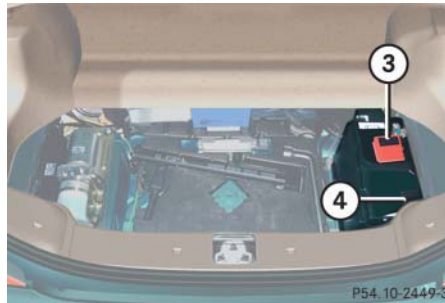

- ③ Positive terminal
- ④ Negative terminal



The consumer battery located in the trunk is valve-regulated lead acid (VRLA) battery, also referred to as “fleece” battery. Such batteries do not

require topping-up of the electrolyte level. VRLA batteries therefore do not have cell caps and the battery cover is non-removable. Do not attempt to open the consumer battery as otherwise the battery will be damaged.

Even though VRLA batteries do not require topping-up of the electrolyte level and cannot be opened to check the electrolyte level, the battery condition must be checked periodically by performing a battery conductance test. Refer to Maintenance Booklet for battery condition testing intervals.

As with any other battery, disconnect the consumer battery if you do not intend to operate your vehicle for an extended period of time to prevent battery discharge. Contact an authorized Mercedes-Benz Center for further information.

Practical hints

Batteries

Warning!



Failure to follow these instructions can result in severe injury or death.

Never lean over batteries while connecting, you might get injured.

Battery fluid contains sulfuric acid. Do not allow this fluid to come in contact with eyes, skin or clothing. In case it does, immediately flush affected area with water and seek medical help if necessary.

A battery will also produce hydrogen gas, which is flammable and explosive. Keep flames or sparks away from battery, avoid improper connection of jumper cables, smoking, etc.



Never loosen or detach battery terminal clamps while the engine is running or the SmartKey is in the starter switch. Otherwise the alternator and other electronic components could be severely damaged.

Have the starter battery checked regularly by an authorized Mercedes-Benz Center.

Refer to Maintenance Booklet for maintenance intervals or contact an authorized Mercedes-Benz Center for further information.

Warning!



Do not place metal objects on the battery as this could result in a short circuit.

Use leak-proof batteries only to avoid the risk of acid burns in the event of an accident.

Warning!



The brake system requires electrical power to operate.

A malfunction in the vehicle's power supply or electrical system may impair brake system operation and switch it into its emergency operation mode. The same applies if battery is disconnected. To brake, the driver must then apply significantly greater brake pedal pressure and depress the pedal much further to obtain the expected braking effect. If necessary, apply full pressure to the brake pedal. Brakes are only applied to the front wheels. Stopping distance is increased! Adjust your driving style accordingly. For more information, see "SBC brake system" (▷ page 85).

Warning!



With a disconnected battery

- you will no longer be able to turn the SmartKey in the starter switch and pressing the KEYLESS-GO* start/stop button on the gear selector lever will have no effect
- the gear selector lever will remain locked in position **P**

Practical hints

Batteries

Disconnecting the batteries



Always disconnect the batteries in the order described below, even if you only want to charge the starter battery, for example. Otherwise the vehicle's electronics can be damaged.

- ▶ Make sure the gear selector lever is set to position **P**.
- ▶ Close the retractable hardtop (▷ page 196).
- ▶ Turn off the engine (▷ page 58).
- ▶ Turn off all electrical consumers.
- ▶ Remove the SmartKey from the starter switch.
or
- ▶ Vehicles with KEYLESS-GO*: Open the driver's door.
- ▶ Depress the parking brake.
- ▶ Open the trunk. ▷▷

Practical hints

Batteries

- ▷▷▶ Unhook the luggage cover in the trunk.
 - ▶ Remove the trunk floor.

The battery for electrical consumers is located in the right hand area of the trunk (▷ page 372).
 - ▶ Use the 10 mm open-end wrench from the vehicle tool kit to disconnect the negative lead from negative terminal ④ of the consumer battery.
 - ▶ Open the hood (▷ page 270).
 - ▶ Use the 10 mm open-end wrench from the vehicle tool kit to disconnect the negative lead from negative terminal ② of the starter battery.
 - ▶ Remove the covers from the positive terminals ① and ③.
 - ▶ Disconnect the positive lead from positive terminal ③ of the consumer battery.
 - ▶ Disconnect the positive lead from positive terminal ① of the starter battery.

Removing the batteries

Removing the consumer battery

- ▶ Remove the screws securing the battery in the trunk.
- ▶ Remove the battery support and bracket.
- ▶ Take out the battery.

Removing the starter battery

- ▶ Remove the screws securing the starter battery in the engine compartment.
- ▶ Lift the retaining bracket.
- ▶ Remove the battery.

Charging and reinstalling batteries

- ▶ Charge batteries in accordance with the instructions of the battery charger manufacturer.
- ▶ Reinstall the charged batteries. Follow the previously described steps in reverse order.

Warning!



Never charge a battery while still installed in the vehicle. Gases may escape during charging and cause explosions that may result in paint damage, corrosion or personal injury.

Reconnecting the batteries



Always connect the batteries in the order described below. Otherwise the vehicle's electronics can be damaged.

- ▶ Turn off all electrical consumers.
- ▶ Install starter battery in the designated location in the engine compartment.
- ▶ Install consumer battery in the designated location in the trunk.
- ▶ Attach supports and brackets.
- ▶ Tighten support and bracket screws.



Never invert the terminal connections!

- ▶ Connect positive lead ③ of the consumer battery and positive lead ① of the starter battery and fasten covers.

- ▶ Connect negative lead ② of the starter battery.
- ▶ Connect negative lead ④ of the consumer battery.
- ▶ Reinstall the trunk floor.
- ▶ Rehook trunk luggage cover into holders.



The following procedures must be carried out following any interruption of battery power (e.g. due to reconnection):

- Resynchronize the ESP (▷ page 341).
- Resynchronize side windows (▷ page 195).

Practical hints

Jump starting

Warning!



Failure to follow these directions will cause damage to the electronic components, and can lead to a battery explosion and severe injury or death.

Never lean over batteries while connecting or jump starting, you might get injured.

Battery fluid contains sulfuric acid. Do not allow this fluid to come in contact with eyes, skin or clothing. In case it does, immediately flush affected area with water, and seek medical help if necessary.

A battery will also produce hydrogen gas, which is flammable and very explosive. Keep flames or sparks away from battery, avoid improper connection of jumper cables, smoking, etc.

Attempting to jump start a frozen battery can result in it exploding, causing personal injury.

Read all instructions before proceeding.

If the starter battery is discharged, the engine can be started with jumper cables and the battery of another vehicle. Observe the following:

- Jump starting should only be performed when the engine and catalytic converter are cold.
- Do not start the engine if the battery is frozen. Let the battery thaw out first.
- Only jump start from batteries with the same voltage rating (12V). Jump starting with a more powerful battery could damage the vehicle's electrical system, which will not be covered by the Mercedes-Benz Limited Warranty.
- Only use jumper cables with sufficient cross section and insulated terminal clamps.
- Always make sure the jumper cables are not on or near pulleys, fans, or other parts that move when an engine is started or running.



Jump starting may only be performed on the battery installed in the engine compartment.

Avoid repeated and lengthy starting attempts.

Do not attempt to start the engine using a battery quick charge unit.

If the engine does not run after several unsuccessful starting attempts, have it checked at the nearest authorized Mercedes-Benz Center.

Excessive unburned fuel generated by repeated failed starting attempts may damage the catalytic converter and may present a fire risk.

Make sure the jumper cables do not have loose or missing insulation.

Make sure the cable clamps do not touch any other metal part while the other end is still attached to a battery.

Warning!



Keep flames or sparks away from battery.
Do not smoke.

Observe all safety instructions and precautions when handling automotive batteries (▷ page 277).

The starter battery is located on the right side of the engine compartment.

- ▶ Make sure the two vehicles do not touch.
- ▶ Turn off all electrical consumers.
- ▶ Apply parking brake.
- ▶ Shift gear selector lever to position **P**.
- ▶ Remove the red cover from positive terminal on both vehicles (▷ page 401).

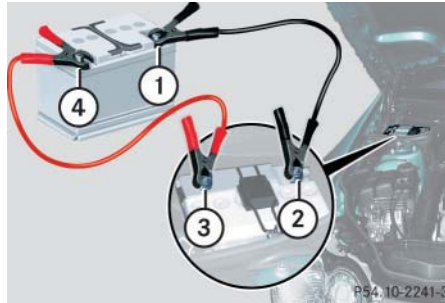

- ① Negative terminal of charged battery
 - ② Negative terminal of discharged battery
 - ③ Positive terminal of discharged battery
 - ④ Positive terminal of charged battery
- ▶ Connect positive terminals ③ and ④ of the batteries with the jumper cables. Clamp cable to charged battery ④ first.



Never invert the terminal connections.

Practical hints

Jump starting

- ▶ Start the engine of the vehicle with the charged battery and run at idle speed.
- ▶ Connect negative terminals ① and ② of the batteries with the jumper cables. Clamp cable to charged battery ① first.
- ▶ Start the engine of the disabled vehicle.

You can now turn on the electrical consumers. Do not turn on the lights under any circumstances.

- ▶ Remove the jumper cables first from negative terminals ① and ② and then from positive terminals ③ and ④.

You can now turn on the lights.

- ▶ Have the battery checked at the nearest Mercedes-Benz Center.



Do not tow-start the vehicle.

Practical hints

Towing the vehicle

Mercedes-Benz recommends that the vehicle be transported with all wheels off the ground using flatbed or appropriate wheel lift/dolly equipment.



Use flatbed or wheel lift/dolly equipment with SmartKey in starter switch turned to position **0**.

Do not tow with sling-type equipment. Towing with sling-type equipment over bumpy roads will damage radiator and supports.

To prevent damage during transport, do not tie down vehicle by its chassis or suspension parts.

Switch off the tow-away alarm and the automatic central locking.

When circumstances do not permit the recommended towing methods, the vehicle may be towed with all wheels on the ground or front wheels raised only so far as necessary to have the vehicle moved to a safe location where the recommended towing methods can be employed.



If the vehicle is towed with the front axle raised, the engine must be shut off (SmartKey in starter switch position **0** or **1**). Otherwise, the ESP will immediately be engaged and will apply the rear wheel brakes.

When towing the vehicle with all wheels on the ground, the gear selector lever must be in position **N** and the SmartKey must be in starter switch position **2**.

When towing the vehicle with all wheels on the ground or the front axle raised, the vehicle may be towed only for distances up to 30 miles (50 km) and at a speed not to exceed 30 mph (50 km/h).



To be certain to avoid a possibility of damage to the transmission, however, we recommend the drive shaft be disconnected at the rear axle drive flange for any towing beyond a short tow to a nearby garage.

Warning!



If circumstances require towing the vehicle with all wheels on the ground, always tow with a tow bar if:

- the engine will not run
- there is a malfunction in the SBC brake system
- there is a malfunction in the power supply or in the vehicle's electrical system

as that will be necessary to adequately control the towed vehicle.

Prior to towing the vehicle with all wheels on the ground, make certain that the SmartKey is in starter switch position **2**.

If the SmartKey is left in starter switch position **0** for an extended period of time, it can no longer be turned in the switch. In this case, the steering is locked. To unlock, remove SmartKey from starter switch and reinsert.

Practical hints

Towing the vehicle



To signal turns while being towed with the hazard warning flasher in use, turn SmartKey in starter switch to position **2** and activate the combination switch for the left or right turn signal in the usual manner – only the selected turn signal will operate.

Upon canceling the turn signal, the hazard warning flasher will operate again.

Practical hints

Towing the vehicle

Warning!



The brake system requires electrical power to operate.

A malfunction in the vehicle's power supply or electrical system may impair brake system operation and switch it into its emergency operation mode. To brake, the driver must then apply significantly greater brake pedal pressure and depress the pedal much further to obtain the expected braking effect. If necessary, apply full pressure to the brake pedal. Brakes are only applied to the front wheels. Stopping distance is increased! Adapt your driving style accordingly. For more information, see "SBC brake system" (▷ page 85).

With the engine not running, there is no power assistance for the brake and steering systems. In this case, it is important to keep in mind that a considerably higher degree of effort is necessary to brake and steer the vehicle. Adapt your driving accordingly.



When towing the vehicle with all wheels on the ground, please note the following:

With the automatic central locking activated and the SmartKey in starter switch position **2**, or KEYLESS-GO* start/stop button in position **2**, the vehicle doors lock if the left front wheel as well as the right rear wheel are turning at vehicle speeds of approx. 9 mph (15 km/h) or more.

To prevent the vehicle door locks from locking, deactivate the automatic central locking (▷ page 110).

Towing of the vehicle should only be done using the properly installed towing eye bolt. Never attach tow cable, tow rope or tow rod to the vehicle chassis, frame or suspension parts.



If the battery is disconnected or discharged

- the SmartKey will not turn in the starter switch
- the gear selector lever will remain locked in position **P**.

For more information, see "Batteries" (▷ page 401) and "Jump starting" (▷ page 406).

Installing towing eye bolt

Front of vehicle

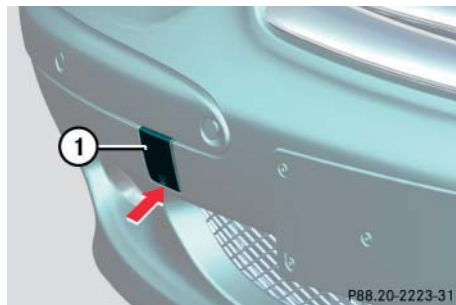

① Cover on right side of front bumper.

To remove cover:

- ▶ Press mark on cover ① in direction of arrow.
- ▶ Lift cover ① off to reveal threaded hole for towing eye bolt.

The towing eye bolt is supplied with the tool kit (located in the storage compartment under the trunk floor).

- ▶ Screw towing eye bolt in to its stop and tighten with lug wrench.

To reinstall cover:

- ▶ Fit cover and snap into place.

Practical hints

Towing the vehicle

Rear of vehicle

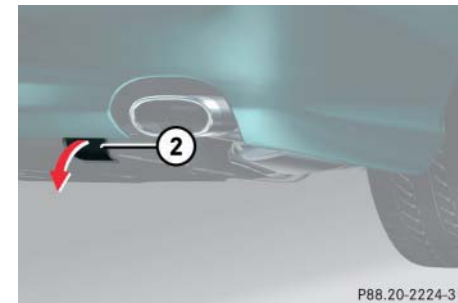

② Cover on right side of rear bumper

To remove cover:

- ▶ Pull cover ② in the direction of arrow.
- ▶ Fold cover ② down to reveal threaded hole for the towing eye bolt.

The towing eye bolt is supplied with the tool kit (located in the storage compartment under the trunk floor).

- ▶ Screw towing eye bolt in to its stop and tighten with lug wrench.

To reinstall cover:

- ▶ Fit cover ② and snap into place.

Practical hints

Fuses

The fuses in your vehicle serve to interrupt the power supply to electrical device that are malfunctioning. This helps to prevent damage to other vehicle electronics.

The following aids are available to help you replace fuses. They are located in the trunk with the vehicle tool kit (▷ page 372).

- Fuse chart

The fuse chart explains the fuse allocation and fuse amperages.

- Spare fuses
- Fuse extractor

Warning



Only use fuses approved for Mercedes-Benz with the specified amperage for the system in question. Otherwise, a short circuit could result and cause a fire.



Only install fuses that have been tested and approved by Mercedes-Benz and that have the specified amperage rating.

Otherwise, electrical parts or components could be damaged.

Never attempt to repair or bridge a blown fuse. Have the cause determined and remedied by an authorized Mercedes-Benz Center.

Main fuse box

The main fuse box is located in the engine compartment on the driver's side in front of the bulkhead (wall separating the engine and passenger compartment).

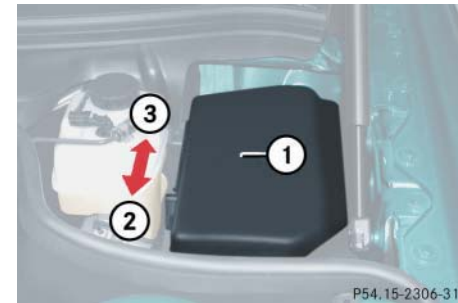

- ① Main fuse box cover
- ② Unlocking
- ③ Locking

Opening

- ▶ Open the hood (▷ page 270).
- ▶ Move slide to position ② and lift cover ①.

Closing

- ▶ Hook cover ① onto tabs and close it.
- ▶ Move slide to position ③.



The fuse box cover must be properly positioned with the slide at the  symbol to prevent moisture or dirt from entering the fuse box and possibly impairing fuse operation.



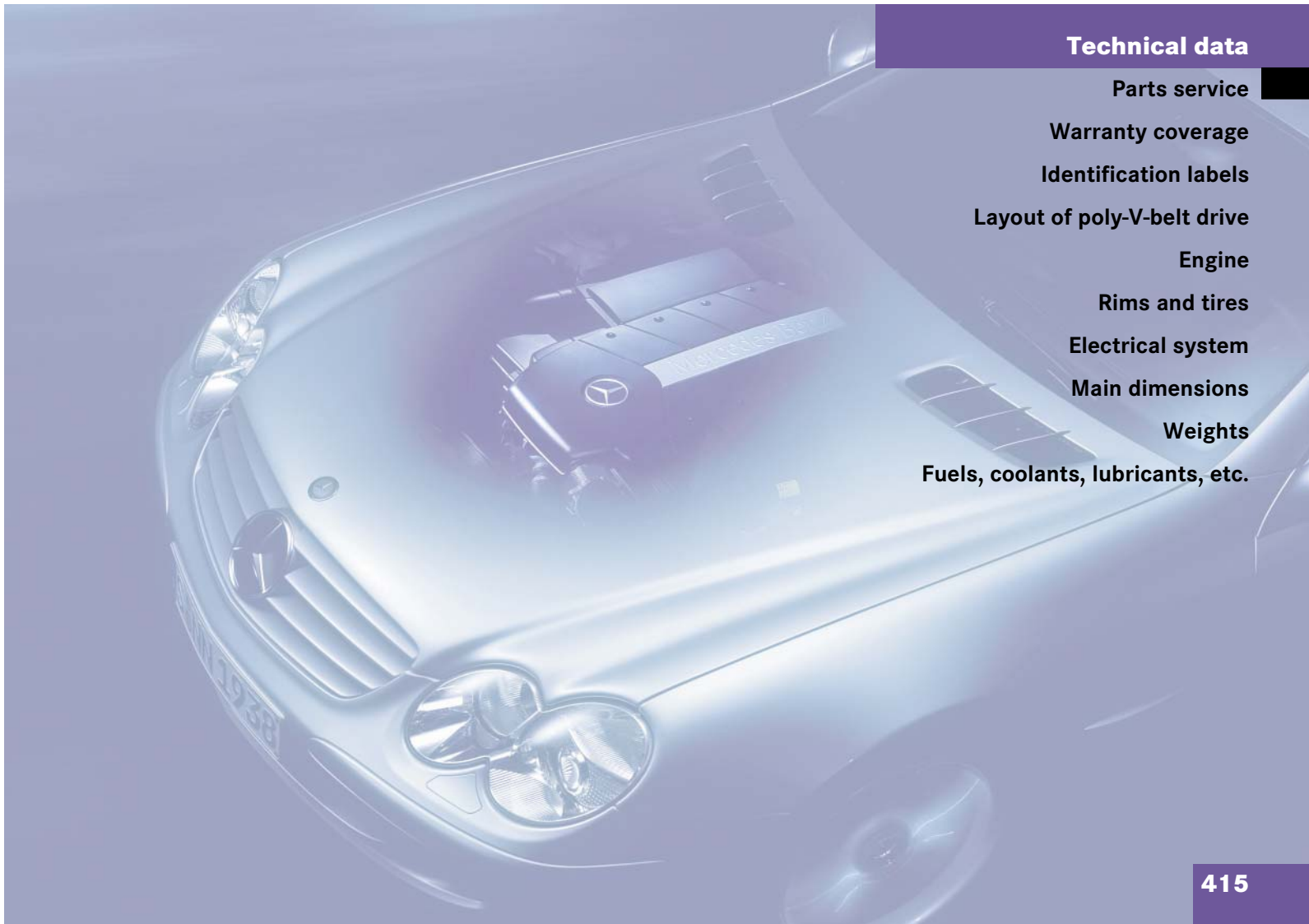

Technical data

Parts service

Warranty coverage

Identification labels

Layout of poly-V-belt drive

Engine

Rims and tires

Electrical system

Main dimensions

Weights

Fuels, coolants, lubricants, etc.

Technical data

Parts service

The “Technical data” section provides the necessary technical data for your vehicle.

All authorized Mercedes-Benz Centers maintain a stock of genuine Mercedes-Benz parts required for maintenance and repair work. In addition, strategically located parts distribution centers provide quick and reliable parts service.

More than 300 000 different parts for Mercedes-Benz models are available.

Mercedes-Benz genuine parts are subjected to stringent quality inspections. Each part has been specifically developed, manufactured or selected for and adapted to Mercedes-Benz vehicles.

Therefore, genuine Mercedes-Benz parts should be installed.



The use of non-genuine Mercedes-Benz parts and accessories not authorized by Mercedes-Benz could damage the vehicle, which is not covered by the Mercedes-Benz Limited Warranty, or could compromise the vehicle’s durability or safety.

▼ Warranty coverage

Your vehicle is covered under the terms of the warranties printed in the Service and Warranty Information booklet. Your authorized Mercedes-Benz Center will exchange or repair any defective parts originally installed in the vehicle in accordance with the terms of the following warranties:

- New Vehicle Limited Warranty
- Emission System Warranty
- Emission Performance Warranty
- California, Maine, Massachusetts, and Vermont Emission Control Systems Warranty

Replacement parts and accessories are covered by the Mercedes-Benz Parts and Accessories warranties, copies of which are available at any Mercedes-Benz Center.

Loss of Service and Warranty Information Booklet

Should you lose your Service and Warranty Information booklet, have an authorized Mercedes-Benz Center arrange for a replacement. It will be mailed to you.

Technical data

Identification labels



- ① Certification label
(includes Paintwork code)

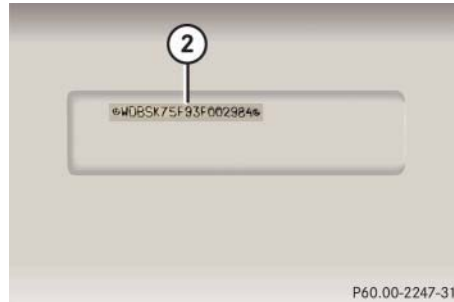

- ② Vehicle Identification Number (VIN)
(below right rear storage compartment)

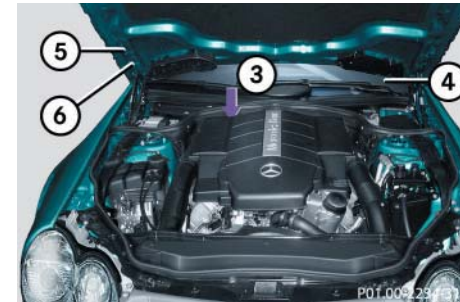

- ③ Engine number (engraved on engine)
④ VIN, visible (lower edge of windshield)
⑤ Emission control information label,
includes both federal and California
certification exhaust emission stan-
dards
⑥ Vacuum line routing diagram label

i

When ordering parts, please specify ve-
hicle identification and engine num-
bers.

▼ Layout of poly-V-belt drive

SL 500

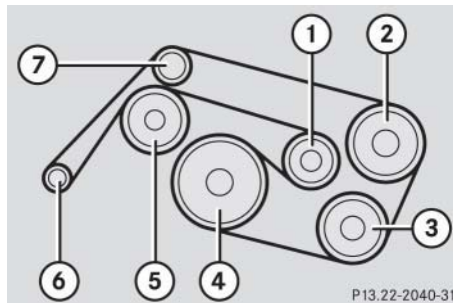

- ① Automatic belt tensioner
- ② ABC tandem pump (pump for power-steering assistance and ABC chassis)
- ③ Air conditioning compressor
- ④ Crankshaft
- ⑤ Coolant pump
- ⑥ Generator (alternator)
- ⑦ Idler pulley

SL 55 AMG

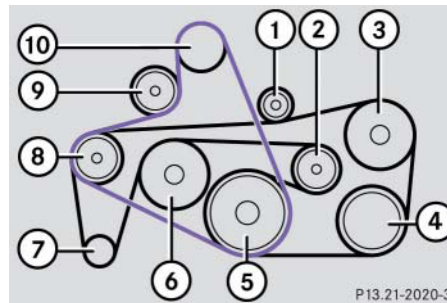

The SL 55 AMG has two poly-V-belts (belt one shown in purple/belt two shown in black).

- ① Idler pulley
- ② Automatic belt tensioner
- ③ ABC tandem pump (pump for power-steering assistance and ABC chassis)
- ④ Air conditioning compressor
- ⑤ Crankshaft
- ⑥ Coolant pump
- ⑦ Generator (alternator)
- ⑧ Idler pulley
- ⑨ Automatic belt tensioner
- ⑩ Supercharger

SL 600, SL 65 AMG

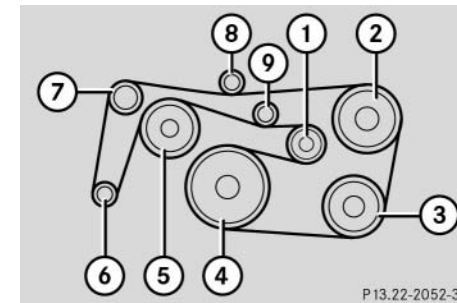

- ① Automatic belt tensioner
- ② ABC tandem pump (pump for power-steering assistance and ABC chassis)
- ③ Air conditioning compressor
- ④ Crankshaft
- ⑤ Coolant pump
- ⑥ Generator (alternator)
- ⑦ Idler pulley
- ⑧ Idler pulley
- ⑨ Idler pulley

Technical data

Engine

Model	SL 500 (230.475) ¹	SL 600 (230.476) ¹
Engine	113	275
Mode of operation	4-stroke engine, gasoline injection	4-stroke engine, gasoline injection
No. of cylinders	8	12
Bore	3.82 in (97.00 mm)	3.23 in (82.00 mm)
Stroke	3.31 in (84.00 mm)	3.43 in (87.00 mm)
Total piston displacement	303.0 cu in (4966 cm ³)	336.4 cu in (5513 cm ³)
Compression ratio	10:1	9:1
Output acc. to SAE J 1349	302 hp / 5600 rpm ² (225 kW / 5600 rpm)	493 hp / 5000 rpm ² (368 kW / 5000 rpm)
Maximum torque acc. to SAE J 1349	339 lb-ft / 2700 rpm (460 Nm / 2700 rpm)	590 lb-ft / 3500 rpm (800 Nm / 3500 rpm)
Maximum engine speed	6000 rpm	5750 rpm
Firing order	1-5-4-2-6-3-7-8	1-12-5-8-3-10-6-7-2-11-4-9
Poly-V-belt	2390 mm	2335 mm

¹ The quoted data apply only to the standard vehicle. See an authorized Mercedes-Benz Center for the corresponding data of all special bodies and special equipment.

² Premium fuel required. Performance may vary with fuel octane rating.

Technical data

Engine

Model	SL 55 AMG (230.474) ¹	SL 65 AMG (230.479) ¹
Engine	113	275
Mode of operation	4-stroke engine, gasoline injection	4-stroke engine, gasoline injection
No. of cylinders	8	12
Bore	3.82 in (97.00 mm)	3.25 in (82.60 mm)
Stroke	3.60 in (92.00 mm)	3.66 in (93.00 mm)
Total piston displacement	331.8 cu in (5439 cm ³)	364.9 cu in (5980 cm ³)
Compression ratio	9:1	9:1
Output acc. to SAE J 1349	493 hp / 6 100 rpm ² (368 kW / 6 100 rpm)	603 hp / 4 400-5 100 rpm ² (450 kW / 4 800-5 100 rpm)
Maximum torque acc. to SAE J 1349	516 lb-ft / 2 750-4 000 rpm (700 Nm / 2 750-4 000 rpm)	738 lb-ft / 2 000-4 000 rpm (1 000 Nm / 2 000-4 000 rpm)
Maximum engine speed	6 500 rpm	5 950 rpm
Firing order	1-5-4-2-6-3-7-8	1-12-5-8-3-10-6-7-2-11-4-9
Poly-V-belt	2 462 mm / 1 289 mm	2 335 mm

¹ The quoted data apply only to the standard vehicle. See an authorized Mercedes-Benz Center for the corresponding data of all special bodies and special equipment.

² Premium fuel required. Performance may vary with fuel octane rating.

Technical data

Rims and tires

Only use tires and rims which have been specifically developed for your vehicle and tested and approved by Mercedes-Benz. Other tires and rims can have detrimental effects, such as

- Poor handling characteristics
- Increased noise
- Increased fuel consumption



Moreover, tires and rims not approved by Mercedes-Benz may, under load, exhibit dimensional variations and different tire deformation characteristics that could cause them to come into contact with the vehicle body or axle parts. Damage to the tires or the vehicle may be the result.



Further information on tires and rims is available at any authorized Mercedes-Benz Center. A placard with the recommended tire inflation pressures is located on the driver's door B-pillar. Some vehicles may have supplemental tire pressure information for driving at high speeds (> page 289) or for vehicle loads less than the maximum loaded vehicle condition. If such information is provided, it can be found on the placard located on the inside of the fuel filler flap. The tire inflation pressure should be checked regularly and should only be adjusted on cold tires. Follow tire manufacturer's maintenance recommendation included with vehicle.

Same size tires

17" tires

	SL 500*	SL 600	SL 55 AMG	SL 65 AMG
Rims (light alloy)	8 ¹ / ₂ J x 17 H2	-	-	-
Wheel offset	1.38 in (35 mm)	-	-	-
Summer tires (radial-ply tires)	255/45 R17 98W	-	-	-
Winter tires (radial-ply tires)	255/45 R17 102V XL or Extra Load M+S	-	-	-

18" tires

	SL 500	SL 600	SL 55 AMG	SL 65 AMG
Rims (light alloy)	8 ¹ / ₂ J x 18 H2	8 ¹ / ₂ J x 18 H2	8 ¹ / ₂ J x 18 H2	-
Wheel offset	1.38 in (35 mm)	1.38 in (35 mm)	1.18 in (30 mm)	-
Summer tires (radial-ply tires)	-	-	-	-
Winter tires (radial-ply tires)	255/40 R18 95V M+S	255/40 R18 95V M+S	255/40 R18 95V M+S	-

Technical data

Rims and tires

19" tires

	SL 500*	SL 600	SL 55 AMG	SL 65 AMG
Rims (light alloy)	-	-	-	8 ¹ / ₂ J x 19 EH2
Wheel offset	-	-	-	1.18 in (30 mm)
Summer tires (radial-ply tires)	-	-	-	-
Winter tires (radial-ply tires)	-	-	-	255/35 R19 96V XL or Extra Load M+S ¹

¹ Must not be used with snow chains.

Technical data

Rims and tires

Mixed size tires

	SL 500	SL 500 (Sport Package*)	SL 600
Front axle:			
Rims (light alloy)	8 ¹ / ₂ J x 18 H2	8 ¹ / ₂ J x 18 H2	8 ¹ / ₂ J x 18 H2
Wheel offset	1.38 in (35 mm)	1.38 in (35 mm)	1.38 in (35 mm)
Summer tires (radial-ply tires)	255/40 R18 95W	255/40 R18 95W	255/40 R18 95Y
Rear axle:			
Rims (light alloy)	9 ¹ / ₂ J x 18 H2	9 ¹ / ₂ J x 18 H2	9 ¹ / ₂ J x 18 H2
Wheel offset	1.57 in (40 mm)	1.57 in (40 mm)	1.57 in (40 mm)
Summer tires (radial-ply tires)	285/35 R18 97W ¹	285/35 R18 97W ¹	285/35 R18 97Y ¹

¹ Must not be used with snow chains.

Technical data

Rims and tires

	SL 600 (Sport Package*)	SL 55 AMG	SL 65 AMG
Front axle:			
Rims (light alloy)	8 ¹ / ₂ J x 18 H2	8 ¹ / ₂ J x 18	8 ¹ / ₂ J x 19 EH2
Wheel offset	1.38 in (35 mm)	1.18 in (30 mm)	1.18 in (30 mm)
Summer tires (radial-ply tires)	255/40 ZR18 95Y	255/40 ZR18 95Y	255/35 ZR19 96Y XL or Extra Load ¹
Rear axle:			
Rims (light alloy)	9 ¹ / ₂ J x 18 H2	9 ¹ / ₂ J x 18	9 ¹ / ₂ J x 19 EH2
Wheel offset	1.57 in (40 mm)	1.30 in (33 mm)	1.22 in (31 mm)
Summer tires (radial-ply tires)	285/35 ZR18 97Y ¹	285/35 ZR18 97Y ¹	285/30 ZR19 98Y XL or Extra Load ¹

¹ Must not be used with snow chains.

Spare wheel

	SL 500	SL 600	SL 55 AMG
Rim	6 B x 17 H2	6 B x 18	6 B x 18
Wheel offset	0.98 in (25 mm)	0.98 in (25 mm)	0.98 in (25 mm)
Collapsible tire	185/60-17 93P ¹	175/55-18 91P ¹	175/55-18 91P ¹

¹ Must not be used with snow chains.



The SL 65 AMG does not have a spare wheel. The SL 65 AMG is equipped with TIREFIT (▷ page 388).

Technical data

Electrical system

Model	SL 500	SL 600	SL 55 AMG	SL 65 AMG
Generator (alternator)	14 V/150 A	14 V/180 A	14 V/180 A	14 V/180 A
Starter motor	12 V/1.7 kW	12 V/1.7 kW	12 V/1.7 kW	12 V/1.7 kW
Battery				
Starter battery	12 V/35 Ah	12 V/35 Ah	12 V/35 Ah	12 V/35 Ah
Battery for electrical consumers	12 V/70 Ah	12 V/70 Ah	12 V/70 Ah	12 V/70 Ah
Spark plugs	Bosch F 8 DPER NGK PFR5R11	NGK IFR6QG	NGK ILFR6A	NGK IFR6QG
Electrode gap	0.039 in (1.0 mm)	0.028 in (0.7 mm)	0.031 in (0.8 mm)	0.028 in (0.7 mm)
Tightening torque	15 – 22 lb-ft (20 – 30 Nm)	15 – 22 lb-ft (20 – 30 Nm)	18 – 22 lb-ft (25 – 30 Nm)	15 – 22 lb-ft (20 – 30 Nm)

Technical data

Main dimensions

▼ Main dimensions

Model	SL 500	SL 600	SL 55 AMG	SL 65 AMG
Overall vehicle length	178.5 in (4535 mm)	178.5 in (4535 mm)	178.5 in (4535 mm)	178.5 in (4535 mm)
Overall vehicle length when opening/ closing hardtop	185.4 in (4709 mm)	185.4 in (4709 mm)	185.4 in (4709 mm)	185.4 in (4709 mm)
Overall vehicle width	71.9 in (1827 mm)	71.9 in (1827 mm)	71.9 in (1827 mm)	71.9 in (1827 mm)
Overall vehicle height	51.0 in (1295 mm)	51.0 in (1295 mm)	51.0 in (1295 mm)	51.0 in (1295 mm)
Overall vehicle height when opening/ closing hardtop	65.9 in (1674 mm)	65.9 in (1674 mm)	65.9 in (1674 mm)	65.9 in (1674 mm)
Wheelbase	100.8 in (2560 mm)	100.8 in (2560 mm)	100.8 in (2560 mm)	100.8 in (2560 mm)
Track, front	61.4 in (1559 mm)	61.4 in (1559 mm)	61.8 in (1569 mm)	61.8 in (1569 mm)
Track, rear	60.5 in (1537 mm)	60.5 in (1537 mm)	61.1 in (1551 mm)	61.1 in (1551 mm)

Technical data

Weights

Trunk load max. 220 lb (100 kg)

▼ Fuels, coolants, lubricants, etc.

Capacities

Vehicle components and their respective lubricants must match. Therefore use only products tested and approved by Mercedes Benz.

Please refer to the Factory Approved Service Products pamphlet, or inquire at your Mercedes-Benz Center.

	Model	Capacity	Fuels, coolants, lubricants, etc.
Engine with oil filter	SL 500 SL 600 SL 55 AMG SL 65 AMG	7.9 US qt (7.5 l) 8.5 US qt (8.0 l) 9.0 US qt (8.5 l) 8.5 US qt (8.0 l)	Approved engine oils
Automatic transmission	SL 500 SL 600 SL 55 AMG SL 65 AMG	10.3 US qt (9.7 l) 8.0 US qt (7.5 l) 9.1 US qt (8.6 l) 8.0 US qt (7.5 l)	MB Automatic Transmission Fluid
Rear axle	SL 500 SL 600 SL 55 AMG SL 65 AMG	1.5 US qt (1.4 l) 1.3 US qt (1.2 l) 1.5 US qt (1.4 l) 1.3 US qt (1.2 l)	Hypoid gear oil SAE 85 W 90 Hypoid gear oil SAE 85 W 90 Hypoid gear oil SAE 85 W 90 Hypoid gear oil SAE 75 W 140
Hydraulic system for active body control (ABC)		approx. 4.3 US qt (4.0 l)	MB Hydraulic Fluid
Power steering		approx. 1.1 US qt (1.0 l)	MB Power Steering Fluid (Pentosin CHF 11S)
Front wheel hubs		approx. 3.0 oz (85 g) each	High temperature roller bearing grease
Brake system		1.1 US qt (1.05 l)	MB Brake Fluid (DOT 4+)

Technical data

Fuels, coolants, lubricants, etc.

	Model	Capacity	Fuels, coolants, lubricants, etc.
Cooling system	SL 500 SL 600 SL 55 AMG SL 65 AMG	approx. 12.3 US qt (11.6 l) approx. 13.6 US qt (12.9 l) approx. 14.5 US qt (13.7 l) approx. 16.4 US qt (15,5 l)	MB 325.0 Anticorrosion / Antifreeze
Low temperature cooling system	SL 600 SL 65 AMG	approx. 2.2 US qt (2.1 l) approx. 3.1 US qt (2.9 l)	MB 325.0 Anticorrosion / Antifreeze
Fuel tank including a reserve of	All models SL 500 SL 600 SL 55 AMG SL 65 AMG	21.1 US gal (80.0 l) 2.6 US gal (10.0 l) 2.6 US gal (10.0 l) 3.7 US gal (14.0 l) 3.7 US gal (14.0 l)	Premium unleaded gasoline: Minimum Posted Octane 91 (Avg. of 96 RON /86 MON)
Air conditioning system			R-134a refrigerant and special PAG lubricant oil (never R-12)
Hydraulic system for retractable hardtop		0.42 US qt (0.4 l)	MB Hydraulic Fluid
Windshield washer and headlamp cleaning system		7.4 US qt (7 l)	MB Windshield Washer Concentrate ¹

¹ Use MB Windshield Washer Concentrate "S" and water for temperatures above freezing or MB Windshield Washer Concentrate "S" and commercially available pre-mixed windshield washer solvent / antifreeze for temperatures below freezing. Follow suggested mixing ratios (▷ page 437).

Engine oils

Engine oils are specifically tested for their suitability in our engines and durability for our service intervals. Therefore, only use approved engine oils and oil filters required for vehicles with Maintenance System (U.S. vehicles) or FSS (Canada vehicles). For a listing of approved engine oils and oil filters, refer to the Factory Approved Service Products pamphlet, or contact an authorized Mercedes-Benz Center.

Using engine oils and oil filters of specification other than those expressly required for the Maintenance System (U.S. vehicles) or FSS (Canada vehicles), or changing oil and oil filter at change intervals longer than those called for by the Maintenance System (U.S. vehicles) or FSS (Canada vehicles) will result in engine damage not covered by the Mercedes-Benz Limited Warranty.

Engine oil additives

Do not blend oil additives with engine oil. They may damage the engine.

Damage or malfunctions resulting from blending oil additives are not covered by the Mercedes-Benz Limited Warranty.

Air conditioner refrigerant

R-134a (HFC) refrigerant and special PAG lubricating oil are used in the air conditioning system.

Never use R-12 (CFC) or mineral-based lubricating oil. Otherwise damage to the system will occur.

Brake fluid

During vehicle operation, the boiling point of the brake fluid is continuously reduced through the absorption of moisture from the atmosphere. Under extremely strenuous operating conditions, this moisture content can lead to the formation of bubbles in the system, thus reducing the system's efficiency.

Therefore, the brake fluid must be replaced every two years, preferably in the spring.

Only brake fluid approved by Mercedes-Benz is recommended. Your authorized Mercedes-Benz Center will provide you with additional information.

Technical data

Fuels, coolants, lubricants, etc.

Premium unleaded gasoline



To maintain the engine's durability and performance, premium unleaded gasoline must be used. If premium unleaded is not available and low octane fuel is used, follow these precautions:

- have the fuel tank only partially filled with unleaded regular and fill up with premium unleaded as soon as possible
- avoid full throttle driving and abrupt acceleration
- do not exceed an engine speed of 3000 rpm if the vehicle is loaded with a light load such as two persons and no luggage
- do not exceed $\frac{2}{3}$ of maximum accelerator pedal position if the vehicle is fully loaded or operating in mountainous terrain

Fuel requirements

Only use premium unleaded fuel:

- The octane number (posted at the pump) must be 91 min. It is an average of both the Research (R) octane number and the Motor (M) octane number: $(R+M) / 2$. This is also known as the ANTI-KNOCK INDEX.

Unleaded gasoline containing oxygenates such as ethanol, IPA, IBA and TBA can be used provided the ratio of any one of these oxygenates to gasoline does not exceed 10%; MTBE must not exceed 15%.

The ratio of methanol to gasoline must not exceed 3% plus additional cosolvents.

Using mixtures of ethanol and methanol is not allowed. Gasohol, which contains 10% ethanol and 90% unleaded gasoline, can be used.

These blends must also meet all other fuel requirements, such as resistance to spark knock, boiling range, vapor pressure, etc.

Gasoline additives

A major concern among engine manufacturers is carbon build-up caused by gasoline. Mercedes-Benz recommends only the use of quality gasoline containing additives that prevent the build-up of carbon deposits.

After an extended period of using fuels without such additives carbon deposits can build up, especially on the intake valves and in the combustion area, leading to engine performance problems such as:

- Warm-up hesitation
- Unstable idle
- Knocking/pinging
- Misfire
- Power loss

In areas where carbon deposits may be encountered due to lack of availability of gasolines which contain these additives, Mercedes-Benz recommends the use of additives approved by us for use on Mercedes-Benz vehicles. Refer to Factory Approved Service Products pamphlet for a listing of approved product(s). Follow directions on product label.

Do not blend other specific fuel additives with fuel. This only results in unnecessary cost and may be harmful to the engine operation.

Damage or malfunction resulting from poor fuel quality or from blending additional fuel additives other than those tested and approved by us for use on Mercedes-Benz vehicles listed in the Factory Approved Service Products pamphlet are not covered by the Mercedes-Benz Limited Warranty.

Coolants

The engine coolant is a mixture of water and anticorrosion / antifreeze, which provides:

- corrosion protection
- freeze protection
- boiling protection (by increasing the boiling point)

The cooling system was filled at the factory with a coolant providing freeze protection to approximately -22°F (-30°C) and corrosion protection.

If the antifreeze mixture is effective to -22°F (-30°C), the boiling point of the coolant in the pressurized cooling system is reached at approximately 266°F (130°C).

The coolant solution must be used year round to provide the necessary corrosion protection and increase in the boil-over protection. Refer to Maintenance Booklet for replacement interval.

Technical data

Fuels, coolants, lubricants, etc.

Coolant system design and coolant used stipulate the replacement interval. The replacement interval published in the Maintenance Booklet is only applicable if MB 325.0 anticorrosion/antifreeze solution or other Mercedes-Benz approved products of equal specification (see Factory Approved Service Products pamphlet) are used to renew the coolant concentration or bring it back up to the proper level.

To provide important corrosion protection, the solution must be at least 45% anticorrosion/antifreeze (equivalent to freeze protection to approx. - 22°F [-30°C]). If you use a solution that is more than 55% anticorrosion/antifreeze (freeze protection to approx. - 49°F [-45°C]), the engine temperature will increase due to the lower heat transfer capability of the solution. Therefore, do not use more than this amount of anticorrosion/antifreeze.

If the coolant level is low, water and MB 325.0 Anticorrosion /Antifreeze should be used to bring it up to the proper level (have cooling system checked for signs of leakage). Please make sure the mixture is in accordance with label instructions.

The water in the cooling system must meet minimum requirements, which are usually satisfied by normal drinking water. If you are not sure about the water quality, consult an authorized Mercedes-Benz Center.

Technical data

Fuels, coolants, lubricants, etc.

Anticorrosion/antifreeze

Your vehicle contains a number of aluminum parts. The use of aluminum components in motor vehicle engines necessitates that anticorrosion/antifreeze coolant used in such engines be specifically formulated to protect the aluminum

parts. (Failure to use such anticorrosion/antifreeze coolant will result in a significantly shortened service life.)

Therefore, the following product is strongly recommended for use in your vehicle: Mercedes-Benz 325.0 anticorrosion/antifreeze agent.

Before the start of the winter season (or once a year in hot southern regions), you should have the anticorrosion/antifreeze concentration checked. The coolant is also regularly checked each time you bring your vehicle to an authorized Mercedes-Benz Center for service.

Anticorrosion / antifreeze quantity

Model	Approx. freeze protection	
	- 35°F (- 37°C)	- 49°F (- 45°C)
SL 500	6.1 US qt (5.8 l)	6.8 US qt (6.4 l)
SL 600 (main cooling system)	6.9 US qt (6.5 l)	7.5 US qt (7.1 l)
SL 600 (low temperature cooling system)	1.2 US qt (1.1 l)	1.3 US qt (1.2 l)
SL 55 AMG	7.3 US qt (6.9 l)	7.9 US qt (7.5 l)
SL 65 AMG (main cooling system)	8.2 US qt (7.75 l)	9.0 US qt (8.5 l)
SL 65 AMG (low temperature cooling system)	1.5 US qt (1.45 l)	1.7 US qt (1.6 l)

Technical data

Fuels, coolants, lubricants, etc.

Windshield and headlamp washer system

Both the windshield and headlamp washer systems are supplied from the windshield washer fluid reservoir.

The windshield and headlamp washer fluid reservoir has a capacity of approx. 7.4 US qt (7 l).

- ▶ Refill the reservoir with MB Windshield Washer Concentrate and water (or concentrate and commercially available premixed windshield washer solvent / antifreeze, depending on ambient temperatures).

Warning!



Washer solvent/antifreeze is highly flammable. Do not spill washer solvent/antifreeze on hot engine parts because it may ignite and burn. You could be seriously burned.

Windshield and headlamp washer fluid mixing ratio

For temperatures above freezing point, use MB Windshield Washer Concentrate “S” and water:

- 1 part “S” to 100 parts water
(1.34 fl oz [40 ml] “S” to 1 gal [4.0 l] water)

For temperatures below freezing point, use MB Windshield Washer Concentrate “S” and commercially available premixed windshield washer solvent / antifreeze:

- 1 part “S” to 100 parts solvent
(1.34 fl oz [40 ml] “S” to 1 gal [4.0 l] solvent).

ABS

(Antilock Brake System)

Prevents the wheels from locking up during braking so that the vehicle can continue to be steered.

ABC

(Active Body Control)

Active, computer-controlled system that hydraulically adjusts the suspension at all four wheels in response to various driving situations.

Alignment bolt

Metal pin with thread. The alignment bolt, or centering bolt, is an aid used when changing a tire to align the wheel with the wheel hub.

BabySmart^{TM1} airbag deactivation system

This system detects if a special system compatible child restraint seat is installed on the front passenger seat. The system will automatically deactivate the passenger front airbag when such a seat is properly installed (indicator lamp  on the glove box comes on).

BabySmartTM compatible child seats

Special restraint system for children. The sensor system for the passenger seat prevents deployment of the passenger front airbag if a BabySmartTM compatible child seat is installed. See your authorized Mercedes-Benz Center for availability.

BAS

(Brake Assist System)

System for potentially reducing braking distances in emergency braking situations. The system is activated when it senses an emergency based on how fast the brake is applied.

Bi-Xenon headlamps*

Headlamps which use an electric arc as the light source and produce a more intense light than filament headlamps. Bi-Xenon headlamps produce low beam and high beam.

CAC

(Customer Assistance Center)

Mercedes-Benz customer service center, which can help you with any questions about your vehicle and provide assistance in the event of a breakdown.

¹ BabySmartTM is a trademark of Siemens Automotive Corp.

Technical terms

CAN system

(Controller Area Network)
Data bus network serving to control vehicle functions such as door locking or windshield wiping depending on vehicle settings and/or ambient conditions.

Cockpit

All instruments, switches, buttons and indicator/warning lamps in the passenger compartment needed for vehicle operation and monitoring.

Collapsible tire

An especially compact spare tire that must be inflated with a provided air pump before using. It should only be used to bring the vehicle to the nearest service station.

COMAND

(Cockpit Management and Data System)
Information and operating center for vehicle sound and communications systems, including the radio, CD changer and navigation system, as well as other optional equipment (e.g. telephone).

Control system

The control system is used to call up vehicle information and to change component settings. Information and messages appear in the multifunction display. The driver uses the buttons on the multifunction steering wheel to navigate through the system and to adjust settings.

Cruise control

Driving convenience system for automatically maintaining the vehicle speed set by the driver.

Distronic*

A driving convenience cruise control system which helps the driver maintain a pre-selected speed:

- If there is no vehicle directly ahead, the system operates in the same way as conventional cruise control.
- If a slower moving vehicle is ahead, Distronic* will reduce your vehicle speed to the extent permitted by reduced throttle and up to 20% braking power to maintain the preset minimum following distance.

DTR

(->Distronic*)

Engine number

The number set by the manufacturer and placed on the cylinder block to uniquely identify each engine produced.

ESP

(Electronic Stability Program)
Improves vehicle handling and directional stability.

ETD

(Emergency Tensioning Device)
Device which deploys in certain frontal and rear collisions exceeding the system's threshold to tighten the seat belts.
->SRS

FSS (Canada vehicles)

(Flexible Service System)
Service indicator in the multifunction display that informs the driver when the next vehicle maintenance service is due.

Gear range

Number of gears which are available to the automatic transmission for shifting. The automatic gear shifting process can be adapted to specific operating conditions using the gear selector lever.

GPS

(Global Positioning System)
Satellite-based system for relaying geographic location information to and from vehicles equipped with special receivers. Employs CD digital maps for navigation.

Head-thorax airbag

Installed in the doors, these airbags protect occupants during side impact collisions exceeding a preset threshold. Unlike normal side airbags, head-thorax airbags are also designed to provide protection for the head area.

Instrument cluster

The displays and indicator/warning lamps in the driver's field of vision, including the tachometer, speedometer, engine temperature and fuel gauge.

KEYLESS-GO*

System for entering and operating the vehicle without the use of a key.

Kickdown

Depressing the accelerator past the point of resistance shifts the transmission down to the lowest possible gear. This very quickly accelerates the vehicle and should not be used for normal acceleration needs.

Lock button

Button on the door which indicates whether the door is locked or unlocked. Pushing the lock button down on an individual door from inside will lock that door.

Maintenance System (U.S. vehicles)

Maintenance service indicator in the multifunction display that informs the driver when the next vehicle maintenance service is due. The Maintenance system tracks distance driven and time elapsed since the last maintenance service, calculates other maintenance service work required, and calls for the next service accordingly.

Technical terms

Memory function

Used to store three individual seat, steering wheel and mirror positions for each SmartKey or SmartKey with KEYLESS-GO*.

MON

The Motor Octane Number for gasoline as determined by a standardized method. It is an indication of a gasoline's ability to resist undesired detonation (knocking). The average of both the MON (Motor Octane Number) and RON (Research Octane Number) is posted at the pump, also known as ANTI-KNOCK INDEX.

Multifunction display

Two display fields in the instrument cluster used to present information provided by the control system.

Multifunction steering wheel

Steering wheel with buttons for operating the control system.

Overspeed range

Engine speeds within the red marking on the tachometer dial, see "Tachometer" (▷ page 132). Avoid this engine speed range, as it may result in serious engine damage that is not covered by the Mercedes-Benz Limited Warranty.

Parktronic (Parking assist)*

System which uses visual and acoustic signals to assist the driver during parking maneuvers.

Poly-V-belt drive

Drives engine-components (alternator, AC compressor, etc.) from the engine.

Power train

Collective term designating all components used to generate and transmit motive power to the drive axles, including

- engine
- clutch/torque converter
- transmission
- transfer case
- drive shaft
- differential
- axle shafts/axles

Program mode selector switch

Used to switch the automatic transmission between standard operation (S) and comfort operation (C).

SL 55 AMG with steering wheel gear-shift control and manual shift program: in addition to S and C (for regular S or comfort C operation, see above), you can use MANUAL for manual shift program

REST

(Residual Engine Heat Utilization)
Feature that uses the engine heat stored in the coolant to heat the vehicle interior for a short time after the engine has been turned off.

Retractable hardtop

Hardtop roof that can be opened and closed at the push of a button and stored in the trunk.

Roll bar

Occupant protection system which consists of tubular steel sheathed in plastic. The roll bar is lowered into the car body during normal driving conditions and raised automatically. It may also be manually raised and lowered by operating a button during critical driving situations.

RON

The Research Octane Number for gasoline as determined by a standardized method. It is an indication of a gasoline's ability to resist undesired detonation (knocking). The average of both the MON (Motor Octane Number) and RON (Research Octane Number) is posted at the pump, also known as ANTI-KNOCK INDEX.

SBC

(Sensotronic Brake Control)
Electronically controlled hydraulic braking system for increased braking safety and comfort.

Shift lock

When the vehicle is parked, this lock prevents the gear selector lever from being inadvertently moved out of position P without SmartKey turned and brake pedal depressed.

SRS

(Supplemental Restraint System)
Seat belts, emergency tensioning device and airbags. Though independent systems, they are closely interfaced to provide effective occupant protection.

Tele Aid System

(Telematic Alarm Identification on Demand)
The Tele Aid system consists of three types of response: automatic and manual emergency, roadside assistance and information. Tele Aid is initially activated by completing a subscriber agreement and placing an acquaintance call.
The Tele Aid system is operational provided that the vehicle's battery is charged, properly connected, not damaged and cellular and GPS coverage is available.

Technical terms

Tightening torque

Force times lever arm (e.g. a lug wrench) with which threaded fasteners such as wheel bolts are tightened.

Tire speed rating

Part of tire designation; indicates the speed range for which a tire is approved.

Traction

Force exerted by the vehicle on the road via the tires.

Vehicle level control

The ground clearance of the vehicle is automatically controlled according to a selected setting and speed. The driver can choose manually within a range of ground clearance, for example on very rough roads.

VIN

(Vehicle Identification Number)

The number set by the manufacturer and placed on the body to uniquely identify each vehicle produced.

Voice control system*

Voice control system for car phones, portable cell phones and audio systems (radio, CD, etc.).

Wind screen

Screen for deflecting wind from the vehicle interior when the hardtop is lowered.

Xenon headlamps

Headlamps which use an electric arc as the light source and produce a more intense light than filament headlamps.

A

- ABC 220, 439
 - Messages in display 337
 - Oil level 275
 - Setting vehicle level 221
- ABC switch 30
- ABS 79, 80, 439
 - ABS control 80
 - Messages in display 338
 - Warning lamp 27, 325
- ABS/ESP
 - Warning lamp 25, 324
- Accelerator position, automatic transmission 171
- Accessory weight 305
- Activating
 - Air circulation mode 187
 - Air conditioning (cooling) 192
 - Anti-theft alarm system 89
 - Central locking (control system) 156
 - Distance warning function* 217
- Distronic* 213
- Easy-entry/exit feature 157
- Electric air pump 398
- ESP 84
- Exterior lamps 123
- Exterior rear view mirror parking position 179
- Hazard warning flasher 129
- High beams 128
- Ignition 36
- Immobilizer 58
- Parktronic* 226
- Rear window defroster 189
- Residual heat 190
- Seat heating 117, 118
- Seat ventilation* 119
- Tow-away alarm 90
- Windshield wipers 53
- Active Body Control (ABC) switch 30
- Active Body Control see ABC
- Adding
 - Engine oil 274
- Adjusting
 - Air distribution 186
 - Air volume 185
 - Backrest tilt 40, 41
 - Exterior rear view mirrors 43
 - Head restraint height 41
 - Head restraint tilt 41
 - Interior rear view mirror 43
 - Lumbar support 115
 - Mirrors 43
 - Multicontour backrest* 116
 - Seat cushion depth 41
 - Seat cushion tilt 41
 - Seat height 41
 - Seat in the lumbar region 116
 - Seat in the shoulder region 116
 - Seats 39
 - Steering column in/out 42
 - Steering column up/down 42
 - Steering wheel 42

Index

- Air conditioner refrigerant 433
- Air conditioning (cooling)
 - Turning off 191
 - Turning on 191
- Air pressure 305
- Air pressure see Tire inflation pressure
- Air pump, electric 373
 - Turning on 398
- Air recirculation mode 187
- Air volume adjustment 185
- AIRBAG OFF
 - Warning lamp 334
- Airbags 63
 - Children 64
 - Front 68
 - Head-thorax 68, 69
 - Kneebag 68
 - Passenger 68
- Alarm
 - Audible 78, 88
 - Canceling 90
 - Visual 88
- Alignment bolt 439
- Alignment bolt (vehicle tool kit) 396
- Anticorrosion/antifreeze 432, 437
- Anti-theft alarm system 88
 - Arming 89
 - Canceling the alarm 90
 - Disarming 89
- Anti-theft systems
 - Anti-theft alarm system 88
 - Tow-away alarm 90
- Aquaplaning see Hydroplaning
- Armrest
 - Storage compartment 229
- Ashtray 29, 233
- Aspect ratio 305
- At the gas station 267
- ATF (automatic transmission fluid) 275
- Automatic climate control 29, 182
 - Center air vents 29
 - Deactivating 191
 - Residual heat utilization 190
 - Side air vents 29
 - Temperature sensor 31
- Automatic shift program 170
- Automatic transmission 164
 - Accelerator position 171
 - Comfort program mode 170
 - Emergency operation (Limp Home Mode) 177
 - Gear ranges 167
 - Gear selector lever 30, 164
 - Gear selector lever position 164, 168
 - Gear shifting malfunctions 177
 - Kickdown 171
 - Manual shifting 166
 - One-touch gearshifting 166
 - Program mode selector switch 30, 170
 - Transmission fluid 275

B

BabySmart™ airbag deactivation system 76, 439
 BabySmart™ compatible child seats 439
 Backrest supports
 Lumbar region 116
 Shoulder region 116
 Backrest tilt 40
 Backup lamp bulbs 381
 Backup lamps 385
 Bar 305
 BAS 79, 81, 439
 Batteries, SmartKey
 Changing 377
 Batteries, SmartKey with KEYLESS-GO*
 Changing 378
 Check lamp 105
 Batteries, vehicle 277
 Charging 404
 Disconnecting 403
 For electrical consumers 277, 373, 401

 For starter 277, 401
 Messages in display 345, 346
 Reconnecting 405
 Removing 404
 Service 401
 Battery
 For electrical consumers 373
 Bead 305
 Bi-Xenon* 439
 Bi-Xenon* headlamps 439
 Block heater 310
 Brake fluid 269, 431, 433
 Brake lamp bulb, high mounted 381
 Brake lamp bulbs, left and right 381
 Brake pads
 Message in display 346
 Brake system
 Messages in display 350
 Brakes 256
 High-performance brake system (SL 65 AMG only) 258
 Warning lamp 326

Break-in period 254
 Bulbs, replacing
 Backup lamps 385
 Brake lamps 381
 Front lamps 380, 383
 License plate lamps 385
 Parking lamps 384
 Rear fog lamp 385
 Standing lamps 384
 Tail lamp assemblies 385
 Turn signal lamps, front 383
 Turn signal lamps, rear 385

C

CAC see Customer Assistance Center
 CAN System 440
 Capacities
 Fuels, coolants, lubricants etc. 431
 Catalytic converter 265
 CD player
 Operating 141

Index

- Center air vents 29
- Center console
 - Lower part 30
 - Upper part 29
- Centigrade
 - Setting temperature units 148
- Central locking
 - Automatic 110
 - Central locking switch 111
 - Switching on/off (control system) 156
 - Unlocking from inside 111
- Central locking switch 29
- Central unlocking switch 29
- Changing
 - Batteries (SmartKey with KEYLESS-GO*) 378
 - Batteries (SmartKey) 377
 - SmartKey setting 96
 - SmartKey with KEYLESS-GO* settings 103
 - Vehicle level 222
- Charging
 - Vehicle batteries 404
- CHECK ENGINE
 - Messages in display 351
- CHECK ENGINE malfunction indicator lamp 27, 327, 328
- Checking
 - Coolant level 276
 - Oil level 269, 272
 - Tire inflate pressure 269
 - Vehicle lighting 269
- Child safety
 - Airbags 64
 - Automatic child seat recognition 76
 - Infant and child restraint systems 62
- Cigarette lighter 29, 233
- Cleaning
 - Cup holder 320
 - Gear selector lever 320
 - Hard plastic trim items 320
 - Headlamps 178
- Headliner 320
- Leather upholstery 321
- Plastic and rubber parts 321
- Seat belts 320
- Steering wheel 320
- Upholstery 321
- Windshield 53
- Wood trims 321
- Cleaning tires 281
- Clock 23
- Closing
 - Hood 271
 - Power window with KEYLESS-GO* 195
 - Retractable hardtop (SmartKey) 201
 - Retractable hardtop (switch) 198
 - Side windows 194, 195
 - Sunshade 204
 - Trunk lid 109
 - Windows 193
 - Windows with KEYLESS-GO* 195

- Cockpit 440
- Cold tire inflation pressure 305
- Collapsible tire 440
- COMAND 29, 440
- COMAND, radio and telephone 264
- Combination switch 23, 52, 128
- Comfort driving
 - Transmission program mode 170
- Control system 134, 137, 440
 - AUDIO menu 139
 - Convenience submenu 157
 - Distronic* menu 142
 - Functions 136
 - Instrument cluster submenu 148, 149
 - Lighting submenu 152
 - Menus 136
 - Multifunction display 134
 - Multifunction steering wheel 135
 - NAVI menu 142
 - Standard display menu 134, 139
- Submenus 138
- TEL* menu 161
- Time submenu 149
- Trip computer menu 159
- Vehicle status message memory menu 143
 - Vehicle submenu 156
- Convenience feature 201
- Coolant 435
 - Adding 276
 - Anticorrosion/antifreeze quantity 437
 - Checking level 276
 - Messages in display 351, 352, 353
 - Temperature 266
 - Temperature gauge 131
 - Temperature warning lamp 25
 - Warning lamp 328
- Coolant temperature gauge 25
- Cooling see Air conditioner
- Courtesy lighting 130
- Cruise control 205, 440
 - “Resume” function 208
 - Canceling 206
 - Driving downhill 206
 - Driving uphill 206
 - Fine adjustment 208
 - Setting a higher speed 207
 - Setting current speed 206
 - Setting to last stored speed 208
- Cruise control lever 23, 205
 - For cruise control 205
 - For Distronic* 213
- Cup holder 29, 228
 - Cleaning 320
- Curb weight 305
- Customer Assistance Center 439
- D**
- Daytime running lamp mode 125
 - Setting 152
- Deactivating
 - Air conditioning (cooling) 191

Index

- Air recirculation mode 188
- Alarm 90
- Anti-theft alarm system 89
- Automatic climate control 191
- Central locking (control system) 156
- Cruise control 206
- Distance warning function* 217
- Distronic* 215
- Engine with KEYLESS-GO* 59
- Engine with the SmartKey 58
- ESP 83
- Exterior lamps 123
- Hazard warning flasher 129
- Headlamps 57, 123
- Immobilizer 88
- Interior light delayed switch-off 155
- Parktronic* 226
- Rear window defroster 189
- Residual heat 190
- Seat heating 117, 118
- Seat ventilation* 119
- Tow-away alarm 90
- Deactivating manual shift program 177
- Deep water see Standing water
- Defrosting windshield 187
- Delayed switch-off
 - Exterior lamps 154
 - Interior lighting 155
- Department of Transportation see DOT
- Digital clock 23
- Direction of rotation (tires) 282
- Displays
 - Distronic* 210
 - Maintenance service indicator 312
 - Messages 273, 354
 - Parktronic* 225
- Distance to empty (range)
 - Calling up 161
- Distance warning function* 216
 - Activating 217
 - Deactivating 217
 - Intermittent warning sound 216
 - Symbol 142, 212
- Distance warning function* switch 30
- Distronic indicator lamp* 25
- Distronic* 208, 440
 - “Resume” function 215
 - Activating 213
 - Calling up settings 142, 212
 - Cleaning system sensors 318
 - Cruise control lever 213
 - Deactivating 215
 - Deceleration 211
 - Decreasing time interval 216
 - Displays 210
 - Distance warning function 216
 - Distance warning function switch 30
 - Driving hints 217
 - DTR warning lamp 210
 - Increasing time interval 216

- Intermittent signal tone 211
- Setting a higher speed 214
- Setting a slower speed 214
- Setting distance 30
- Setting last stored speed 215
- Setting speed 214
- System sensor cover 318
- Warning and indicator lamps 210
- Distronic* warning lamp 25
- Door control panel 23, 32
- Door handle 32
- Doors
 - Message in display 354
 - Opening from inside vehicle 106
 - Storage compartments 229
- DOT 305
- Downhill driving
 - Cruise control 206
- Downshifting 166
- Drinking and driving 255
- Drive sensibly - save fuel 255
- Driving 45, 50
- Driving abroad 264
- Driving hints
 - Distronic* 217
 - SBC brake system 87
- Driving instructions 255
- Driving off 258
- Driving safety systems 79
 - ABS 79, 80
 - BAS 81
 - ESP 82
- Driving systems 205
 - ABC 220
 - Cruise control 205
 - Distronic* 208
 - Parktronic* 223
 - Vehicle level control 221
- DTR see Distronic
- E**
- Easy-entry/exit 157
 - Messages in display 354
- Easy-entry/exit feature 113
- Electric air pump 373, 397
- Electrical consumer battery 277
- Electrical outlet 236
- Electronic Stability Program see ESP
- Emergency call system*
 - Initiating emergency call 240
 - Requirements 237
- Emergency engine shut-down 60
- Emergency operation
 - Locking the vehicle 376
 - Lowering load assist 376
 - Unlocking storage compartments 375
 - Unlocking the trunk 375
 - Unlocking the vehicle 374
- Emergency operation (Limp Home Mode) 177
- Emergency Tensioning Device (ETD) 72, 440

Index

- Emission control 265
- Emission control label 418
- Engine
 - Compartment 270
 - Starting with KEYLESS-GO* 49
 - Starting with the SmartKey 48
 - Turning off 58
 - Turning off with KEYLESS-GO* 59
 - Turning off with the SmartKey 58
- Engine number 440
- Engine oil 272, 433
 - Adding 274
 - Additives 433
 - Checking level 272
 - Consumption 272
 - Display messages 355
 - Filler neck 274
 - Messages in display 273
- Engine oil level see Oil level
- ESP 79, 82, 440
 - Control switch 30
 - Switching off 83
 - Switching on 84
 - Synchronizing 341
 - Warning lamp 82
- ESP/ABS warning lamp 25
- ETD see Emergency Tensioning Device
- Express-close front side windows 195
- Express-open front side windows 194
- F**
- Fahrenheit
 - Setting temperature units 148
- Fastening the seat belts 45
- Fine adjustment
 - Cruise control 208
- First aid kit 372
- Flat tire 388
 - Spare wheel 393
 - TIREFIT kit 388
- Flexible Service System (FSS), Canada only 312, 441
- Fluid level 275
- Fog lamp, rear 127, 381
 - Replacing bulb 385
- Fog lamps 127
- Fog lamps, front 127
 - Replacing bulbs 381
- Front airbags 68
- Front lamps 381
 - Replacing bulbs 383
- FSS (Flexible Service System, Canada only) 312, 441
- Fuel 267
 - Additives 435
 - Fuel reserve warning lamp 27, 330
 - Gasoline additives 435
 - Premium unleaded gasoline 268, 432, 434
 - Requirements 434
- Fuel consumption statistics
 - After start 159
 - Since reset 160

Fuel filler flap 267
 Locking 267
 Opening 267
 Unlocking 267
 Fuel requirements 434
 Fuel reserve tank
 Message in display 357
 Fuel tank
 Filler flap 267
 Fuels, coolants, lubricants etc. -
 capacities 431
 Functions (control system) 136
 Fuse chart 412
 Fuse chart see Vehicle tool kit
 Fuses 412
 Fuse chart 412
 Fuse extractor 412
 Main fuse box 412
 Spare fuses 412

G

Garage door opener 31, 246
 Gasoline see Fuel
 GAWR 305
 Gear range
 Automatic transmission 167
 Indicator 27
 Limiting 167
 Shifting into optimal 166
 Gear range limit
 Canceling 166
 Gear selector lever 30, 164
 Cleaning 320
 Lock 48, 443
 Position (Automatic
 transmission) 164, 168
 Glove box 23, 228
 GPS 441
 Gross Axle Weight Rating see GAWR
 Gross Vehicle Weight Rating see GVWR
 Gross Vehicle Weight see GVW
 GVW 305
 GVWR 306

H

Hands-free microphone 31
 Hard plastic trim items
 Cleaning 320
 Hardtop open/close control 30
 Hardtop see Retractable hardtop
 Hardtop switch 197
 Hazard warning flasher 128
 Hazard warning flasher switch 29
 Headlamp switch-off delay see Delayed
 switch-off, exterior lamps
 Headlamps
 Automatic mode 124
 Headlamp cleaning system 178, 278
 Manual mode 124
 Refilling washer fluid 278
 Headliner
 Cleaning 320
 Head-thorax airbag 76, 441
 Heated steering wheel* 234

Index

- Height adjustment
 - Head restraints 41
- Height adjustments
 - Vehicle level 221
- High beam flasher 128
- High beam headlamp indicator 27
- High beam headlamps 52, 123, 381
 - Replacing bulbs 383
 - Switching on 128
- High-performance brake system (SL 65 AMG only) 258
- Hood 270
 - Messages in display 357
- Horn 23
- Hydroplaning 260
- I**
- Identification labels 418
- Ignition 36, 38
 - Switching on 36
- Immobilizer 88
 - Activating 58, 88
 - Deactivating 88
- Indicator lamps see Lamps, indicator and warning
- Infant and child restraint systems 74
- Instrument cluster 24, 131, 441
 - Select language 149
- Instrument lighting 131
- Interior lighting 129
 - Automatic control 129
 - Delayed switch-off 155
- Interior lighting control 31
 - Manual operation 130
- Intermittent wiping 53
- J**
- Jack 373
- K**
- Key, Mechanical 374
- Key-dependent memory 158
- KEYLESS-GO* 441
 - Closing power window with 195
 - Closing windows with 195
 - Important notes 101
 - Key positions 35
 - Starting the engine 49
 - Turning off the engine 59
- KEYLESS-GO* start/stop button 29, 37, 49
- Keys
 - Loss of 98
- Kickdown 171, 441
- Kilometers/miles in speedometer 148
- Kilopascal 306
- Kneebag 68
- L**
- Labels, identification 418
- Lamp bulbs, exterior 380
- Lamps, exterior
 - Delayed switch-off 154
 - Exterior lamp switch 23, 51
 - Front 381
 - Headlamps 317

- Light sensor 361
- Replacing bulbs for rear 381, 385
- Switching off 123
- Switching on 123
- Lamps, indicator and warning
 - ABS 27, 325
 - ABS/ESP 324
 - AIRBAG OFF 334
 - Airbag Off 68
 - Brakes 326
 - CHECK ENGINE 327, 328
 - Coolant 328
 - DTR* 210
 - Engine diagnostics 327, 328
 - ESP 82
 - Fuel reserve 330
 - SBC 85
 - Seat belts 332
 - SRS 63, 332
 - Turn signals 25
- Language
 - Multifunction display 149
- Leather upholstery
 - Cleaning 321
- License plate lamps 153, 381
 - Replacing bulbs 385
- Light sensor 361
- Lighter see Cigarette lighter
- Lighting
 - Instruments 131
 - Interior 129
 - Settings (control system) 152
 - Trunk 130
- Limiting the gear range 167
- Limp Home Mode 177
- Load assist 235
 - Lowering manually 376
- Loading terminology 305
- Loading the vehicle 282
- Lock buttons 34
 - Door handle (KEYLESS-GO*) 60
 - Trunk (KEYLESS-GO*) 104
- Locking 56
 - Automatic while driving 110
 - Centrally from inside 111
 - Fuel filler flap 267
 - Global (SmartKey with KEYLESS-GO*) 102
 - Global (SmartKey) 96
 - Storage compartments 230
 - Vehicle in an emergency 376
- Low beam headlamps 51, 123, 381
 - Replacing bulbs 383
- Lowering
 - Load assist manually 376
 - Roll bar 74
- Luggage compartment, rear 232
- Luggage cover 197
 - Messages in display 371
 - Opening/closing 197
- Lumbar support adjustment 115

Index

M

- Main fuse box 412
- Maintenance service
 - Overdue 313
 - When due 312
- Maintenance service indicator 312
 - Clearing 313
- Maintenance System (U.S. vehicles) 312, 441
- Malfunction memory 143
 - Calling up 143
 - Clearing 144
- Manual operation
 - Interior lighting control 130
 - Locking the vehicle 376
 - Lowering load assist 376
 - Unlocking storage compartments 375
 - Unlocking the driver's door 374
 - Unlocking the trunk 375
- Manual shift program SL 55 AMG and SL 65 AMG 175
- Massage function 116
- Maximum cooling MAXCOOL 186
- Maximum inflation pressure 306
- Maximum load rating 306
- Maximum loaded vehicle weight 306
- Memory function 441
 - Storing exterior rear view mirror parking positions 121
 - Storing key-dependent settings 158
- Menus 136
 - AUDIO 139
 - Distronic* 142
 - NAVI 142
 - Standard display 139
 - TEL* 161
 - Trip computer 159
 - Vehicle status message memory 143
- Microphone
 - Hands-free microphone 31
- Miles/kilometers in speedometer 148
- Minimum distance (Parktronic*) 225
- Mirrors 43, 178
 - Activating exterior rear view mirror parking position 179
 - Adjusting interior rear view mirror 43
 - Auto-dimming rear view mirror 178
 - Exterior rear view mirror parking position 158
 - Exterior rear view mirrors 43
 - Storing exterior rear view mirror parking position 121
- Misfiring 55
- MON 268, 441
- Mph or km/h in speedometer 148
- Multicontour backrest* 116
- Multifunction display 134, 442
 - Displaying gear range 167
 - Left display field 25
 - Right display field 27
 - Selecting language 149
 - Standard display 134

Multifunction display messages

- ABC 337
- ABS 338
- Battery 345, 346
- Brake pads 346
- Brake system 350
- CHECK ENGINE 351
- Coolant 352
- Coolant level 351, 353
- Display malfunction 354
- Doors 354
- Easy-entry/exit feature 354
- Fuel reserve tank 357
- Hood 357
- Luggage cover 371
- Retractable hardtop 357
- Roll bar 364
- SBC brake system 347, 348
- Seat belts 364
- SmartKey 357
- SmartKey with KEYLESS-GO* 359
- Tele Aid 364
- Telephone* 364

- Tires 365

- Trunk 371

- Washer fluid 371

- Multifunction steering wheel 28, 135, 442

- Buttons 135

N

- Navigation system

- Operating 142

- Night security illumination 154

- Normal occupant weight 306

O

- Occupant distribution 306

- Octane number 443

- Odometer, main 25

- Oil

- Adding 274

- Consumption 272

- Filler neck 274

- Oil level

- Checking 269

- One-touch gearshifting 166

- Canceling gear range limit 166

- Downshifting 166

- Upshifting 166

- Opening

- Doors from the inside 106

- Fuel filler flap 267

- Hood 270

- Luggage cover 197

- Retractable hardtop (SmartKey) 200

- Retractable hardtop (switch) 197

- Side windows 194

- Storage compartment in the

- armrest 230

- Storage compartment in the center

- console 230

- Sunshade 204

- Trunk from inside vehicle 108

- Trunk lid 107

- Windows 193

Index

- Operating
 - CD player 141
 - Navigation system 142
 - Radio 140
 - Telephone* 161
- Overhead control panel 31
- Overspeed range 132, 442
- P**
- Panic alarm 78
 - Panic button on SmartKey 78
- Panorama roof*
 - Sunshade 203
 - Sunshade closing 204
 - Sunshade opening 204
- Parcel net in passenger footwell 231
- Parcel net in trunk 231
- Parktronic* deactivation switch 30
- Parking 259
- Parking assistance (Parktronic*) 223
- Parking brake
 - Engaging 57
 - Releasing 50
- Parking brake pedal 23
- Parking lamps 381
 - Replacing the bulbs 384
 - Switching on 123
- Parking position
 - Exterior rear view mirrors 121, 158, 179
- Parktronic* 30, 223, 442
 - Activating 226
 - Cleaning system sensors 318
 - Deactivating 226
 - Malfunctioning 227
 - Minimum distance 225
 - Range 224
 - Rear sensors 225
 - System sensors 318
 - Warning indicators 23, 225
- Parts service 416
- Passenger side
 - Front airbag 68
 - Head-thorax airbag 69
 - Parcel net in footwell 231
- Pedals 255
- Phone book* 162
 - Loading 163
 - Quick search 163
- Phone number*
 - Dialing 162
 - Redialing 163
- Plastic and rubber parts
 - Cleaning 321
- Poly-V-belt drive 442
 - Layout 419
- Potential problems associated with under-inflated and overinflated tires 294
- Power assistance 256
- Power seat
 - Adjusting backrest tilt 41
 - Adjusting head restraint height 41
 - Adjusting head restraint tilt 41
 - Adjusting seat cushion depth 41
 - Adjusting seat cushion tilt 41
 - Adjusting seat height 41

- Power train 442
- Power window
 - Closing with KEYLESS-GO* 195
- Power windows 193
 - Side windows 193
 - Synchronizing 195
- Problems while driving 55
- Production options weight 306
- Program mode selector switch 443
 - Automatic transmission 30, 170
- PSI 306
- PULSE function (Massage function) 116
- Q**
- Quick search
 - Phone book* 163
- R**
- Radio
 - Satellite* 140
 - Select station 140
- Radio transmitters
 - Control and operation 264
- Range (distance to empty)
 - Calling up 161
- Reading lamp 31
- Rear lamps see Tail lamps
- Rear luggage compartment 232
- Rear view mirrors see Mirrors
- Rear window defroster 178, 189
- Recommended inflation pressure 306
- Redial memory 163
- Refuelling 267
- Regular checks 269
- Regular driving style 220
- Replacing
 - Backup lamp bulbs 385
 - Brake lamp bulbs 381
 - Bulbs 380
 - Front lamp bulbs 383
 - Front turn signal bulbs 383
 - Fuses 412
- High beam bulbs 383
- License plate lamp bulbs 385
- Low beam bulbs 383
- Rear fog lamp bulb 385
- Rear lamp bulbs 381, 385
- Rear turn signal bulbs 385
- Wiper blades 386
- Reset button 25
- Resetting
 - All functions (control system) 145
 - Fuel consumption statistics 160
 - Maintenance service indicator (FSS) 314
 - Trip odometer 132
- Residual heat utilization 190
- Restraint systems 62
 - Airbags 62
 - Child seat recognition 62
 - Child seats 62
 - Emergency Tensioning Device (ETD) 62, 72
 - Seat belts 62, 69

Index

- Resume function
 - Cruise control 208
 - Distronic* 215
- Retractable hardtop 443
 - Closing (SmartKey) 201
 - Closing (switch) 198
 - Convenience feature 201
 - Locking after raising/lowering 199
 - Message in display 357
 - Opening (SmartKey) 200
 - Opening (switch) 197
 - Problems when operating 201
 - Summer opening feature 200
- Rim 306
- Roll bar 73, 443
 - Lowering 74
 - Messages in display 364
 - Raising 73
 - Warning lamp 27
- Roll bar buttons 30
- RON 268, 443
- Roof see Retractable hardtop
- Rubber parts
 - Cleaning 321
- S**
- Satellite-radio* 140
- SBC brake system 79, 85, 443
 - Activation 86
 - Deactivation 87
 - Driving hints 87
 - Messages in display 347, 348
 - Self-check 86
 - Warning lamp 85
- Seat belt force limiter 72
- Seat belts 45, 62, 69
 - Cleaning 320
 - Messages in display 364
 - Telltale 332
- Seat heating
 - Switching off 117
 - Switching on 117
- Seat ventilation*
 - Switching off 119
 - Switching on 119
- Seating capacity 284
- Seats
 - Adjusting height 40
 - Adjusting lumbar support 116
 - Adjusting shoulder support 116
 - Easy entry/exit feature 113
 - Heating 117
 - Massage function 116
 - Moving 115
- Service
 - Basic service (Service A) 312
 - Batteries 401
 - Calling up the maintenance service indicator 313
 - Extended service (Service B) 312
 - Types 312
- Service life (tires) 280

- Service System see Vehicle Maintenance System
- Setting 150
 - Convenience functions 157
 - Daytime running lamp mode 152
 - Digital clock 23
 - Distronic* time interval 216
 - Exterior rear view mirror parking position 158
 - Instrument lighting 131
 - Interior lighting delayed switch-off 155
 - Key-dependent memory 158
 - Lamps and lighting (control system) 152
 - Locator lighting 153
 - Lower speed in cruise control 207
 - Miles/kilometers in speedometer 148
 - Multifunction display language 149
 - Night security illumination 154
 - Radio station 140
 - Slower speed in cruise control 207
- Speedometer display mode 148
- Suspension tuning 220
- Temperature (interior) 185
- Temperature indicator 148
- Time (control system) 149
- Time display mode 151
- Tire inflation pressure units 156
 - Units
 - Temperature 148
 - Tire inflation pressure 156
 - Units in speedometer 148
 - Vehicle level control 221
- Setting current speed
 - Cruise control 206
- Setting last stored speed
 - Distronic* 215
- Setting speed
 - Cruise control 207
 - Distronic* 214
- Setting the time (hours) 150
- Setting the time (minutes) 151
- Setting to last stored speed
 - Cruise control 208
- Settings
 - Calling up DISTRONIC* 142, 212
 - Convenience functions 157
 - Factory (SmartKey) 96
 - Resetting all (control system) 145
 - Selective (SmartKey) 96
- Settings menu
 - Individual vehicle settings 144
 - Submenus 145
- Shifting
 - Gear selector lever 164
 - Gear selector lever positions 168
 - Into optimal gear range (Automatic transmission) 166
- Shoulder support
 - Seat adjustment 116
- Side air vents 29
- Side marker lamps 381, 384

Index

- Side windows
 - Automatic closing 195
 - Automatic opening 194
 - Closing 193, 194
 - Closing fully 195
 - Closing with KEYLESS-GO* 195
 - Express-close 195
 - Express-open 194
 - Opening 193, 194
 - Opening fully 194
 - Stopping 195
 - Synchronizing power windows 195
- Sidewall 306
- SmartKey 94
 - Changing the batteries 377
 - Checking the batteries 97
 - Closing retractable hardtop 201
 - Factory setting 96
 - Global locking 96, 97
 - Global unlocking 96
 - Messages in display 357
 - Opening retractable hardtop 200
 - Positions in starter switch 36
 - Reprogramming 96
 - Restoring factory settings 97, 103
 - Selective setting 96
 - Starting the engine 48
 - Turning off the engine 58
 - Unlocking 34
- SmartKey positions 36
- SmartKey with KEYLESS-GO* 98
 - Changing the batteries 378
 - Checking the battery 105
 - Factory setting 102
 - Global locking 102, 103
 - Global unlocking 102
 - Locking 104
 - Loss of 106
 - Messages in display 359
 - Reprogramming 103
 - Selective setting 103
 - Unlocking 35, 99
- SmartKey with remote control 95
- Snow chains 310
- Spare fuses 412
- Spare fuses see Vehicle tool kit
- Spare tire see Spare wheel 388
- Spare wheel 372, 373, 393, 427
 - Inflating tire 397
 - Tire inflation pressure 397
- Speed settings
 - Cruise control 207
 - Distronic* 214
- Speedometer 25
 - Setting units 148
- Sporty driving style 220
- SRS 443
 - Indicator lamp 332
- Standing lamps 123, 381
 - Replacing bulbs 384
- Standing water
 - Driving instructions 263

- Starter battery 277, 401
- Starter switch 23, 36
- Starter switch positions 36
 - SmartKey 36
 - SmartKey with KEYLESS-GO* 37
- Starting difficulties 49
- Starting position 36
- Starting the engine
 - With the SmartKey 48
 - With the SmartKey with KEYLESS-GO* 49
- Steering column
 - In/out adjustment 42
 - Length adjustment 42
 - Up/down adjustment 42
- Steering wheel
 - Adjusting 42
 - Buttons 28
 - Cleaning 320
 - Heating* 234
 - Height adjustment 42
- Steering wheel adjustment lever 23
- Steering wheel gearshift control 172
 - Vehicles with Sport Package* 172
 - SL 55 AMG and SL 65 AMG 174
- Stopping
 - Windows 195
- Storage compartments 228
 - Armrest 229
 - Cup holder 228
 - Glove box 228
 - In door 229
 - In rear 230
 - Locking compartments separately 230
 - Locking storage compartments 230
 - Rear 230
 - Storage tray 230
 - Unlocking compartments separately 231
 - Unlocking storage compartments 231, 375
 - Ventilated compartments 192
- Storing tires 281
- Submenus 138
 - Convenience 157
 - Instrument cluster 148, 149
 - Lighting 152
 - Resetting functions 146
 - Selecting 145
 - Settings menus 145
 - Time 149
 - Vehicle 156
- Summer opening feature 200
- Sun blind see Sunshade
- Sun visors 180
- Sunshade 203
 - Closing 204
 - Opening 204
- Suspension tuning
 - For regular driving style 220
 - For sporty driving style 220
 - Setting 220

Index

- Switching on
 - Front fog lamps 127
 - Rear fog lamp 127
- Switching on headlamps 51
- Symbol
 - Distance warning function* 142, 212
- Synchronizing
 - ESP 341
 - Power windows 195
- Synchronizing time with head unit 149
- T**
- Tachometer 27, 132
- Tail lamps 381, 385
- Technical data
 - Electrical system 428
 - Main dimensions 429
 - Rims and tires 422
 - Weights 430
 - Windshield and headlamp washer system 438
- Tele Aid 237
 - Emergency calls 239
 - Information 242
 - Initiating an emergency call manually 240
 - Messages in display 364
 - Roadside Assistance 240
 - SOS button 31, 240
 - Tele Aid system 237
- Tele Aid System 444
- Telephone* 28, 236
 - Answering a call 162
 - Dialing 162
 - Ending a call 163
 - Hands-free microphone 31
 - Loading phone book* 163
 - Messages in display 364
 - Operating 161
 - Redialing 163
- Telephones and two-way radios 264
- Temperature
 - Outside temperature indicator 133
 - Sensor 31
 - Setting interior temperature 185
 - Setting units in display 148
 - Tires 289
- Tightening torque 399, 444
- Time
 - Settings (control system) 149
- Time display mode
 - Setting 151
- TIN 307
- Tire
 - Vehicle maximum load on 307
- Tire and Loading Information 283
- Tire and loading terminology 305
- Tire care and maintenance 280
- Tire Identification Number see TIN
- Tire inflation pressure 390
 - Checking 269, 288, 290
 - Setting units 156

- Tire inflation pressure see the placard on the fuel filler flap
- Tire inspection 280
- Tire load rating 307
- Tire ply composition and material used 307
- Tire speed rating 261, 297, 307, 444
- Tire terminology 305
- Tire traction 261
- TIREFIT
 - Instructions for use 388
- TIREFIT kit 373, 388
- Tires 279
 - Direction of rotation 282
 - Driving instructions 259
 - Messages in display 365
 - Messages in the display 343, 344
 - Retreads 279
 - Rims and tires 422
 - Rotating 308
 - Service life 280
- Temperature 289, 304
- Tire pressure monitor warning lamp* 333
- Tread depth 281, 309
- Wear pattern 308
- Winter 309
- Tools 372
- Tow-away alarm 90
 - Arming 90
 - Disarming 90
 - Disarming for transport 90
- Tow-away alarm switch 30
- Towing eye bolt (vehicle tool kit)
 - Installing 411
- Towing eye bolt see Vehicle tool kit
- Towing the vehicle 408
- Traction 170, 307, 444
- Transmission see Automatic transmission
- Tread 307
- Tread depth 281
- Treadwear indicators 307
- Trip computer 159
- Trip odometer 25
 - Resetting 132
- Trunk
 - Closing the lid 109
 - Lighting 130
 - Load assist 235
 - Lock button (KEYLESS-GO*) 104
 - Messages in display 371
 - Opening from inside vehicle 108
 - Parcel net 231
 - Trunk lid lock 375
 - Unlocking (KEYLESS-GO*) 105
 - Unlocking in an emergency 375
 - Unlocking separately 98
- Trunk lid
 - Opening 107
- Trunk lid emergency release 109

Index

- Turn signals 23, 52
 - Additional in mirrors 381
 - Front bulbs 381
 - Indicator lamps 25
 - Rear bulbs 381
- Turning off the engine 58

U

- Uniform Tire Quality Grading Standards 307
- Units
 - Setting speedometer units 148
 - Setting temperature units 148
 - Setting tire inflation pressure units 156
- Unlocking 34
 - Centrally from inside 111
 - Driver's door in an emergency 374
 - Fuel filler flap 267
 - Storage compartments 231, 375
 - Trunk 98, 108
 - Trunk (KEYLESS-GO*) 105
 - Trunk in an emergency 375
 - Vehicle in an emergency 374
 - With the SmartKey 34

- With the SmartKey with KEYLESS-GO* 35, 99
- Uphill driving
 - Cruise control 206
- Upholstery
 - Cleaning 321
- Upshifting 166

V

- Vehicle
 - Individual settings 144
 - Locking 29
 - Locking in an emergency 376
 - Minimum distance (Parktronic*) 225
 - Towing 408
 - Unlocking 29
 - Unlocking in an emergency 374
- Vehicle capacity weight 307
- Vehicle care
 - Cup holder 320
 - Gear selector lever 320
 - Hard plastic trim items 320
- Headliner 320
- Leather upholstery 321
- Plastic and rubber parts 321
- Seat belts 320
- Steering wheel 320
- Upholstery 321
 - Wood trims 321
- Vehicle level 221, 444
 - Changing 222
 - Setting 222
- Vehicle level control 444
- Vehicle level control switch 30
- Vehicle lighting
 - Checking 269
- Vehicle loading terminology 305
- Vehicle maximum load on the tire 307
- Vehicle status messages 335
- Vehicle tool kit 372
- Ventilation and residual heat 190
- VIN (vehicle identification number) 418, 444
- Voice control system* 23, 444
 - Hands-free microphone 31

W

Warning lamps see Lamps, indicator and warning
 Warning sounds
 Distance warning function* 216
 Distronic* 211
 Drivers seat belts 69
 Warranty coverage 417
 Washing the vehicle 317
 Wear pattern (tires) 308
 Wheel bolts
 Tightening torque 399
 Wheel change 393
 Tightening torque 399
 Wheel wrench 373
 Wheels
 Tires and wheels 279
 Wind screen 202, 444
 Installing 202
 Removing 203

Windows see Side windows

Windshield
 Defrosting 187
 Refilling washer fluid 278
 Washer fluid 54, 278
 Washer system 278
 Windshield and headlamp washer system 438
 Windshield washer and headlamp cleaning system 269
 Windshield washer fluid 54
 Filler neck 278
 Messages in display 371
 Mixing ratio 438
 Refilling 278
 Windshield wipers 23, 53
 Fast wiper speed 53
 Intermittent wiping 53
 Replacing wiper blades 386
 Wiping with windshield washer fluid 54

Winter driving
 Snow chains 310
 Tires 309
 Winter driving instructions 262
 Winter tires 309
 Wood trims
 Cleaning 321
 Wrench, wheel (vehicle tool kit) 373
X
 Xenon headlamps 444



Service and Literature

Your authorized Mercedes-Benz Center has trained technicians and original Mercedes-Benz parts to service your vehicle properly. For expert advice and quality service, see an authorized Mercedes-Benz Center.

If you are interested in obtaining service literature for your vehicle, please contact an authorized Mercedes-Benz Center. We consider this the best way for you to obtain accurate information for your vehicle.

For further information you can find us on the Mercedes-Benz web-site www.mbusa.com or www.mercedes-benz.ca.

Warning



To help avoid personal injury, be extremely careful when performing any service work or repairs. Improper or incomplete service or the use of incorrect or inappropriate parts or materials may damage the vehicle or its equipment, which may in turn result in personal injury.

If you have any questions about carrying out any type of service, turn to the advice of an authorized Mercedes-Benz Center.

We reserve the right to modify the technical details of the vehicle as given in the data and illustrations of this Operator's Manual. Re-printing, translation and copying, even of excerpts, is not permitted without our prior authorization in writing.

Title illustration no. P00.01-2257-31

Press time May 7, 2004 GSP/TIP Printed in Germany

Free Manuals Download Website

<http://myh66.com>

<http://usermanuals.us>

<http://www.somanuals.com>

<http://www.4manuals.cc>

<http://www.manual-lib.com>

<http://www.404manual.com>

<http://www.luxmanual.com>

<http://aubethermostatmanual.com>

Golf course search by state

<http://golfingnear.com>

Email search by domain

<http://emailbydomain.com>

Auto manuals search

<http://auto.somanuals.com>

TV manuals search

<http://tv.somanuals.com>