

SLK 230 Kompressor
SLK 320
SLK 32 AMG

Our company and staff congratulate you on the purchase of your new Mercedes-Benz.

Your selection of our product is a demonstration of your trust in our company name. Furthermore, it exemplifies your desire to own an automobile that will be as easy as possible to operate and provide years of service.

Your Mercedes-Benz represents the efforts of many skilled engineers and craftsmen. To help assure your driving pleasure, and also the safety of you and your passengers, we ask you to make a small investment of time:

- Please read this manual carefully, then return it to your vehicle where it will be handy for your reference.
- Please follow the recommendations contained in this manual. They are designed to acquaint you with the operation of your Mercedes-Benz.

- Please pay attention to the warnings and cautions contained in this manual. They are designed to help improve the safety of the vehicle operator and occupants.

We extend our best wishes for many miles of safe, pleasurable driving.

Mercedes-Benz USA, LLC
A DaimlerChrysler Company

Contents

Introduction	7	At a glance	17	Parking and locking	47
Product information	7	Cockpit	18	Parking brake	47
Operator's Manual	8	Instrument cluster	20	Switching off headlamps	48
Service and warranty information	8	Center console	23	Turning off engine	48
Important notice for California		Upper part	23		
retail buyers and lessees of		Lower Part	24		
Mercedes-Benz automobiles	9	Overhead control panel	25		
Maintenance	10				
Roadside Assistance	10	Getting started	27	Safety and Security	51
Change of address or ownership	10	Unlocking	28	Occupant safety	52
Operating your vehicle outside the		Unlocking with the remote control ..	28	Airbags	53
USA or Canada	11	Adjusting	30	Seat belts	57
Where to find it	12	Seats	30	Children in the vehicle	60
Symbols	13	Telescoping steering column*	34	Panic alarm	65
Operating safety	14	Mirrors	35	Activating	65
Proper use of the vehicle	14	Driving	37	Deactivating	65
Problems with your vehicle	15	Fastening the seat belts	37	Driving safety systems	66
Reporting safety defects	16	Starting the engine	40	ABS	66
Reporting safety defects	16	Switching on headlamps	43	BAS	67
		Turn signals and high beam	43	ESP	68
		Windshield wipers	44	Anti-theft systems	71
		Problems while driving	45	Immobilizer	71
				Anti-theft alarm system	71
				Tow-away alarm	72

Contents

Controls in detail	73	Setting clock	91	Deactivating the climate control system	110
Locking and unlocking	74	Manual transmission	92	Audio system	111
Keys	74	Shifting into reverse	92	Audio and telephone, operation ...	111
Opening the doors from the inside .	77	Automatic transmission*	93	Operating safety	111
Opening the trunk	77	One-touch gearshifting.....	94	Operating and display elements...	112
Closing the trunk	78	Gear ranges.....	95	Anti-theft system	114
Trunk lid emergency release	78	Gear selector lever position	95	Button and soft key operation.....	115
Automatic central locking	79	Program mode selector switch.....	97	Operation	115
Locking and unlocking from the inside	80	Accelerator position	98	Radio mode.....	116
Seats.....	81	Emergency operation (Limp Home Mode).....	98	Cassette mode.....	118
Removing and installing head restraints.....	81	Good visibility	99	CD mode.....	121
Heated seats*	82	Headlamp cleaning system*	99	Telephone* operation	125
Lighting.....	83	Rear view mirror.....	99	Power windows	128
Exterior lamp switch.....	83	Sun visors	100	Opening and closing the windows	128
Combination switch.....	85	Rear window defroster	101	Retractable hardtop.....	130
Hazard warning flasher.....	86	Climate control	102	Opening and closing the retractable hardtop	130
Interior lighting.....	87	Setting the temperature.....	104	Wind screen	135
Instrument cluster	89	Adjusting air volume	105	Driving systems	136
Instrument cluster illumination.....	89	Adjusting air distribution	105	Cruise control	136
Coolant temperature gauge.....	89	Air recirculation mode.....	106	Useful features	139
Trip odometer.....	90	Air conditioning.....	106	Interior storage spaces	139
Tachometer	90	Residual heat	107	Ashtray	142
Outside temperature indicator	91	Basic settings.....	108	Cigarette lighter	143
		Special settings.....	109	Telephone*	143

Contents

Tele Aid	144	Coolant temperature.....	170	Calling up the service indicator	191
Garage door opener	153	At the gas station	171	Resetting the service indicator	191
<hr/>		Refueling.....	171	Vehicle care	192
Operation	159	Check regularly and before a		Cleaning and care of vehicle.....	192
The first 1000 miles (1500 km)	160	long trip	172	<hr/>	
Driving instructions.....	161	Engine compartment	174	Practical hints	199
Drive sensibly – save fuel.....	161	Hood	174	What to do if	200
Drinking and driving.....	161	Engine oil	175	Lamps in instrument cluster	200
Pedals	161	Transmission fluid level.....	180	Additional indicators in the	
Power assistance	162	Coolant	180	speedometer display	210
Brakes.....	162	Battery	183	Lamp in center console	211
Driving off	163	Windshield washer system and		Where will I find ...?	212
Parking.....	163	headlamp cleaning system*	184	First aid kit.....	212
Tires	164	Tires and wheels.....	185	Vehicle tool kit, vehicle jack	212
Hydroplaning.....	165	Important guidelines	185	Spare wheel (SLK 230	
Tire traction	165	Life of tire	186	Kompressor, SLK 320).....	213
Tire speed rating	166	Direction of rotation.....	186	TIREFIT kit (SLK 32 AMG only).....	214
Winter driving instructions	167	Checking tire inflation pressure	186	Unlocking/locking in an emergency ..	216
Standing water.....	168	Rotating wheels	187	Unlocking the vehicle	216
Passenger compartment.....	168	Winter driving	188	Locking the vehicle	217
Driving abroad.....	168	Winter tires	188	Changing batteries in remote	
Control and operation of radio		Block heater (Canada only)	189	control	218
transmitter	168	Snow chains.....	189	Synchronizing remote control.....	219
Catalytic converter.....	169	Maintenance.....	190	Fuel filler flap.....	219
Emission control	170	Clearing the service indicator	190		
		Service term exceeded	191		

Contents

Manually unlocking the transmission selector lever	220	Towing the vehicle	256	Fuels, coolants, lubricants etc.....	277
Opening/closing in an emergency	221	Towing eye	258	Capacities	277
Raising retractable hardtop manually.....	221	Installing towing eye bolt	259	Engine oils	279
Replacing bulbs	226	Fuses	260	Engine oil additives	279
Bulbs	226	Main fuse box.....	260	Air conditioning refrigerant	279
Replacing bulbs for front lamps....	228	Auxiliary fuse box.....	261	Brake fluid.....	279
Replacing bulbs for rear lamps.....	230			Premium unleaded gasoline.....	280
Adjusting headlamp aim (Halogen headlamps only)	231	Technical data	263	Fuel requirements.....	280
Replacing wiper blades	233	Spare parts service.....	264	Gasoline additives.....	280
Removing wiper blades	233	Warranty coverage.....	265	Coolants	281
Installing wiper blades.....	234	Loss of Service and Warranty Information Booklet	265	Windshield washer system and headlamp washer system*	283
Flat tire	235	Identification labels	266	Consumer information.....	284
Preparing the vehicle.....	235	Layout of poly-V-belt drive	267	Uniform tire quality grading	284
Sealing tires with TIREFIT kit 1	235	SLK 230 Kompressor	267		
Sealing tires with TIREFIT kit 2	240	SLK 320	267	Technical terms	287
Mounting the spare wheel.....	244	SLK 32 AMG.....	267		
Battery	251	Engine.....	268	Index	293
Disconnecting the battery	252	Rims and Tires	269		
Removing the battery	252	Same size tires.....	270		
Charging and reinstalling battery .	252	Mixed size tires	271		
Reconnecting the battery	252	Spare wheel with collapsible tire..	273		
Jump starting	254	Electrical system	274		
		Main Dimensions	275		
		Weights.....	276		

▼ **Product information**

Please observe the following in your own best interest:

We recommend using genuine Mercedes-Benz parts as well as conversion parts and accessories explicitly approved by us for your vehicle model.

We have tested these parts to determine their reliability, safety and special suitability for Mercedes-Benz vehicles.

We are unable to make an assessment for other products and therefore cannot be held responsible for them, even if in individual cases an official approval or authorization by governmental or other agencies should exist. Use of such parts and accessories could adversely affect the safety, performance or reliability of your vehicle. Please do not use them.

Genuine Mercedes-Benz parts as well as conversion parts and accessories approved by us are available at your authorized Mercedes-Benz Center where you will receive comprehensive information, also on permissible technical modifications, and where proper installation will be performed.

Introduction

Operator's Manual

▼ Operator's Manual

This Operator's Manual contains a great deal of useful information. We urge you to read it carefully and familiarize yourself with the vehicle before driving.

For your own safety and longer service life of the vehicle, we urge you to follow the instructions and warnings contained in this manual. Ignoring them could result in damage to the vehicle or personal injury to you or others. Vehicle damage caused by failure to follow instructions is not covered by the Mercedes-Benz Limited Warranty.

Your vehicle may have some or all of the equipment described in this manual. Therefore, you may find explanations for optional equipment not installed in your vehicle. If you have any questions about the operation of any equipment, your authorized Mercedes-Benz Center will be glad to demonstrate the proper procedures.

We continuously strive to improve our product, and ask for your understanding that we reserve the right to make changes in design and equipment. Therefore, information, illustrations and descriptions in this Operator's Manual might differ from your vehicle.

Optional equipment is also described in this manual, including operating instructions wherever necessary. Since they are special-order items, the descriptions and illustrations herein may vary slightly from the actual equipment of your vehicle.

If there are any equipment details that are not shown or described in this Operator's Manual, your authorized Mercedes-Benz Center will be glad to inform you of correct care and operating procedures.

The Operator's Manual and Service Booklet are important documents and should be kept with the vehicle.

Service and warranty information

The Service and Warranty Information Booklet contains detailed information about the warranties covering your Mercedes-Benz, including:

- New Car Limited Warranty,
- Emission System Warranty,
- Emission Performance Warranty,
- California, Maine, Massachusetts, and Vermont Emission Control System Warranty (California, Maine, Massachusetts, and Vermont only),
- State Warranty Enforcement Laws (Lemon Laws).

Important notice for California retail buyers and lessees of Mercedes-Benz automobiles

Under California law you may be entitled to a replacement of your vehicle or a refund of the purchase price or lease price, if Mercedes-Benz USA, LLC and / or its authorized repair or service facilities fail to fix one or more substantial defects or malfunctions in the vehicle that are covered by its express warranty after a reasonable number of repair attempts. During the period of 18 months from original delivery of the vehicle or the accumulation of 18000 miles (approx. 29000 km) on the odometer of the vehicle, whichever occurs first, a reasonable number of repair attempts is presumed for a retail buyer or lessee if one or more of the following occurs:

- (1) the same substantial defect or malfunction results in a condition that is likely to cause death or serious bodily injury if the vehicle is driven, that defect or malfunction has been subject to repair two or more times, and you have directly notified Mercedes-Benz USA, LLC in writing of the need for its repair,
- (2) the same substantial defect or malfunction of a less serious nature than category (1) has been subject to repair four or more times and you have directly notified us in writing of the need for its repair, or
- (3) the vehicle is out of service by reason of repair of the same or different substantial defects or malfunctions for a cumulative total of more than 30 calendar days. Written notification should be sent to us, not a dealer, at Mercedes-Benz USA, LLC, Customer Assistance Center, One Mercedes Drive, Montvale, NJ 07645-0350.

Introduction

Operator's Manual

Maintenance

The Service Booklet describes all the necessary maintenance work which should be performed at regular intervals.

Always have the Service Booklet with you when you take the vehicle to your authorized Mercedes-Benz Center for service. The service advisor will record each service in the booklet for you.

Roadside Assistance

The Mercedes-Benz Roadside Assistance Program provides factory-trained technical help in the event of a breakdown. Calls to the toll-free Roadside Assistance number

1-800-FOR-MERCEdes (in the USA)
1-800-387-0100 (in Canada)

will be answered by Mercedes-Benz Customer Assistance Representatives 24 hours a day, 365 days a year.

For additional information refer to the Mercedes-Benz Roadside Assistance Program Brochure in your glove box.

Change of address or ownership

If you change your address, be sure to send in the "Change of Address Notice" found in the Service and Warranty Information Booklet, or simply call the Mercedes-Benz Customer Assistance Center (in the USA) at 1-800-FOR-MERCEdes, or Customer Service (in Canada) at 1-800-387-0100. It is in your own interest that we can contact you should the need arise.

If you sell your Mercedes, please leave all literature with the vehicle to make it available to the next operator.

If you bought this vehicle used, be sure to send in the "Notice of Purchase of Used Car" found in the Service and Warranty Information Booklet, or call the Mercedes-Benz Customer Assistance Center (in the USA) at 1-800-FOR-MERCEdes, or Customer Service (in Canada) at 1-800-387-0100.

Operating your vehicle outside the USA or Canada

If you plan to operate your vehicle in foreign countries, please be aware that:

- service facilities or replacement parts may not be readily available,
- unleaded gasoline for vehicles with catalytic converters may not be available; the use of leaded fuels will damage the catalysis,
- gasoline may have a considerably lower octane rating, and improper fuel can cause engine damage.

Certain Mercedes-Benz models are available for delivery in Europe under our European Delivery Program. For details, consult your authorized Mercedes-Benz Center or write to:

In the USA:

Mercedes-Benz USA, LLC
European Delivery Department
One Mercedes Drive
Montvale, NJ 07645-0350

In Canada:

Mercedes-Benz Canada, Inc.
European Delivery Department
849 Eglinton Avenue East
Toronto, Ontario M4G 2L5

Introduction

Where to find it

▼ Where to find it

This Operator's Manual is designed to provide comprehensive support information for you, the vehicle operator. Each section has its own reference color so you can find information quickly.

At a glance

Here you will find an overview of all the controls that can be operated from the driver's seat.

Getting started

Here you will find all the information you need for your first drive. You should read this section first if this is your first Mercedes-Benz vehicle or if you are renting or borrowing this vehicle.

Safety and Security

Here you will find descriptions of the safety features of your vehicle.

Controls in detail

Here you will find detailed information about the equipment installed in your vehicle. This section expands on the "Getting started" section and also describes technical innovations. If you are already familiar with the basic functions of your vehicle, this section will be of particular interest to you.

Operation

Here you will find all the information you need for the proper operation of your vehicle.

Practical hints

This section provides fast assistance for dealing with problems you may encounter.

Technical data

All important technical data for your vehicle can be found in this section.

Indexes

The glossary provides explanations of the most important technical terms.

The table of contents and the index are designed to help you find information quickly and easily.

The following publications are part of your vehicle documentation:

- this Operator's Manual
- the Service Booklet

Separate operating instructions will be provided as required depending on the equipment options installed in your vehicle.

▼ Symbols

The following symbols are found in this Operator's Manual:

- * Optional equipment is identified with an asterisk. Since standard equipment varies between models, the descriptions and illustrations in this manual may differ slightly from the actual equipment of your vehicle.

Warning!



Warning notices draw your attention to hazards that may endanger your health or life, or the health or life of others.



Highlights hazards that may result in damage to your vehicle.



Helpful hints or further information you may find useful.

- ▶ This symbol points to instructions for you to follow.
- ▶ A number of these symbols appearing in succession indicates a multiple-step procedure.
 - ▷ Page This symbol tells you where to look for further information on a topic.
 - ▷▷ This continuation symbol marks an interrupted procedure which will be continued on the next page.
 - > In the glossary of technical terms, this symbol is used to indicate cross-references to term definitions.
 - Display Words appearing in the multi-function display are printed in the type shown here.

Introduction

Operating safety

▼ Operating safety

Warning!



Work improperly carried out on electronic components and associated software could cause them to cease functioning. Because the vehicle's electronic components are interconnected, any modification made may produce an undesired effect on other systems.

See your authorized Mercedes-Benz Center for repairs or modifications to electronic components.

Other improper work or modifications on the vehicle could also have a negative impact on the operating safety of the vehicle.

Some safety systems only function while the engine is running. You should therefore never turn off the engine while driving.

Warning!



Heavy blows against the vehicle underbody or tires/ wheels, for example when running over an obstacle, road debris or a pothole, may cause serious damage and impair the operating safety of your vehicle. If you feel a sudden significant vibration or ride disturbance, or you suspect that damage to your vehicle has occurred, you should turn on your hazard warning flashers, carefully slow down, and drive with caution to an area which is a safe distance from the road.

Inspect the vehicle underbody or tires/wheels for possible damage. If the vehicle appears unsafe, have it towed to the nearest authorized Mercedes-Benz Center or other qualified maintenance or repair facility for further inspection or repairs.

Proper use of the vehicle

Proper use of the vehicle requires that you are familiar with the following information and rules:

- the safety precautions in this manual
- the "Technical data" section in this manual
- traffic rules and regulations
- motor vehicle laws and safety standards

Warning!



Various labels are attached to your vehicle. These warning labels are intended to make you and others aware of various risks. You should not remove any of these warning labels unless explicitly instructed to do so by information on the label itself. Removal of any of these labels may cause you and others to be unaware of certain risks which may result in an accident and/or personal injury.

▼ **Problems with your vehicle**

If you should experience a problem with your vehicle, particularly one that you believe may affect its safe operation, we urge you to immediately contact your authorized Mercedes-Benz Center to have the problem diagnosed and corrected if required. If the matter is not handled to your satisfaction, please discuss the problem with the Mercedes-Benz Center management, or if necessary contact us at one of the following addresses:

In the USA:

Customer Assistance Center
Mercedes-Benz USA, LLC
One Mercedes Drive
Montvale, NJ 07645-0350

In Canada:

Customer Relations Department
Mercedes-Benz Canada, Inc.
849 Eglinton Avenue East
Toronto, Ontario, M4G 2L5

Introduction

Reporting safety defects

▼ Reporting safety defects

For the USA only:

The following text is published as required of manufacturers under Title 49, Code of U.S. Federal Regulations, Part 575 pursuant to the “National Traffic and Motor Vehicle Safety Act of 1966”.

Reporting safety defects

If you believe that your vehicle has a defect which could cause a crash or could cause injury or death, you should immediately inform the National Highway Traffic Safety Administration (NHTSA) in addition to notifying Mercedes-Benz USA, LLC.

If NHTSA receives similar complaints, it may open an investigation, and if it finds that a safety defect exists in a group of vehicles, it may order a recall and remedy campaign. However, NHTSA cannot become involved in individual problems between you, your dealer, or Mercedes-Benz USA, LLC.

To contact NHTSA, you may either call the Auto Safety Hotline toll-free at 1-888-327-4236 (or 366-0123 in Washington, D.C. area) or write to: NHTSA, U.S. Department of Transportation, Washington, D.C. 20590. You can also obtain other information about motor vehicle safety from the Hotline.



At a glance

Cockpit

Instrument cluster

Center console

Overhead control panel

At a glance

Cockpit

▼ Cockpit

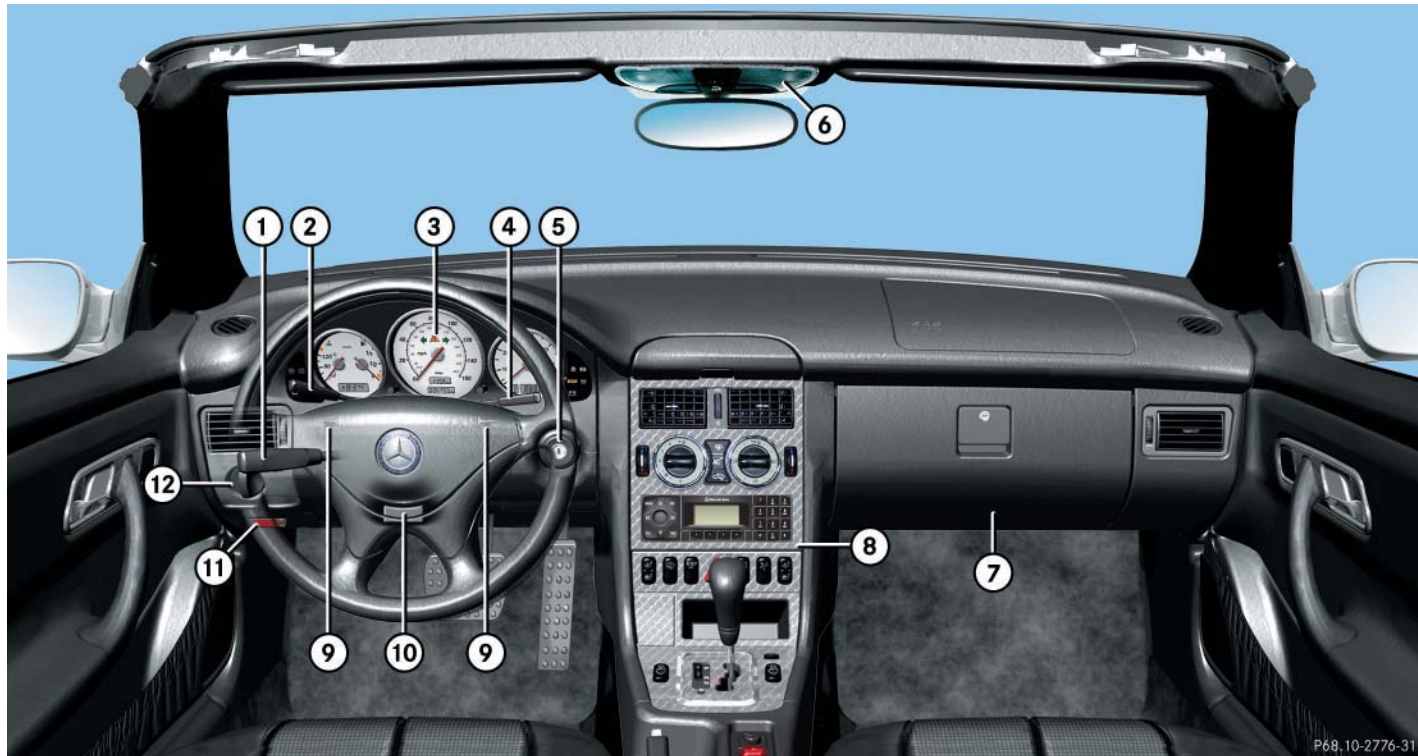

	Item	Page
①	Combination switch	
	• Turn signals	43
	• Windshield wipers	44
	• High beam	43
②	Cruise control lever	136
③	Instrument cluster	20, 89
④	Voice control system* lever (see separate operating instructions)	
⑤	Steering lock with ignition	29
⑥	Overhead control panel	25
⑦	Glove box	139
⑧	Center console	23, 24
⑨	Horn	
⑩	Steering wheel adjustment handle*	34
⑪	Hood lock release	174
⑫	Exterior lamp switch	43

At a glance







Instrument cluster



▼ Instrument cluster





At a glance

Instrument cluster







Item	Page
① Left indicator lamps with:	
 Low windshield washer and head lamp washer* system fluid level warning lamp	206
 Low engine coolant level warning lamp	207
 Low engine oil level warning lamp	206
 Supplemental Restraint System (SRS) indicator lamp	52, 203
 Brake pad wear indicator lamp	209
 Engine malfunction indicator lamp	205
 Telescoping steering column warning lamp	206

Item	Page
② Display with:	
 Coolant temperature gauge	89
 Fuel gauge	207
Outside temperature indicator	91
③ Knob for:	
• Instrument cluster illumination	89
• Resetting trip odometer	90
• Activating Flexible Service System (FSS) indicator	190

Item	Page
④ Speedometer with:	
 Left turn signal indicator lamp	
 Right turn signal indicator lamp	
 Electronic Stability Program (ESP) warning lamp	68, 200
Trip odometer	90
Main odometer	
⑤ Knob for:	
• Setting clock	91
⑥ Tachometer with:	
Selector lever position	41, 90
Clock	91

At a glance

Instrument cluster

	Item	Page
⑦	Right indicator lamps with:	
	 Exterior lamp failure indicator lamp	209
	 High beam head-lamp indicator	43, 85
	 Charge indicator lamp	208
	 Brake warning lamp, except Canada	47, 204
	 Brake warning lamp, Canada only	
	 Brake Assist System (BAS)/Electronic Stability Program (ESP) malfunction indicator lamp	67, 200
	 Antilock Brake System (ABS) warning lamp	66, 201

	Item	Page
	 Seat belt non-usage warning lamp	57, 205

▼ Center console

Upper part



P68.20-2654-31

Item	Page
① Cup holder	140
② Center air vent adjustment	98
Side air vent adjustment	98
③ Climate control	102
Rear window defroster	102
④ Audio system	111
⑤ Seat heater* passenger side	82
⑥ Anti-theft alarm system indicator lamp	71
Tow-away alarm switch	72
⑦ Central locking switch	79
⑧ Hazard warning flasher switch - switching on/off	86
⑨ ESP control switch	68
⑩ Headlamp washer* switch	99
⑪ Seat heater* driver's side	82

At a glance

Center console

Lower Part



Item	Page	Item	Page
① Selector lever for automatic transmission*	93	⑧ Parking brake lever	42
Gearshift lever for manual transmission	92	⑨ Switch for opening/closing windows on the driver's side	128
② Storage compartment		⑩ Program mode selector for automatic transmission*	93
③ Indicator lamp 	62	⑪ Ashtray	142
④ Switch for opening/closing windows on passenger side	128	Coin holder	142
⑤ Exterior rear view mirror adjustment	35		
⑥ Switch for opening/closing the hardtop	130		
⑦ Storage compartment	140		
Cigarette lighter	143		

▼ Overhead control panel

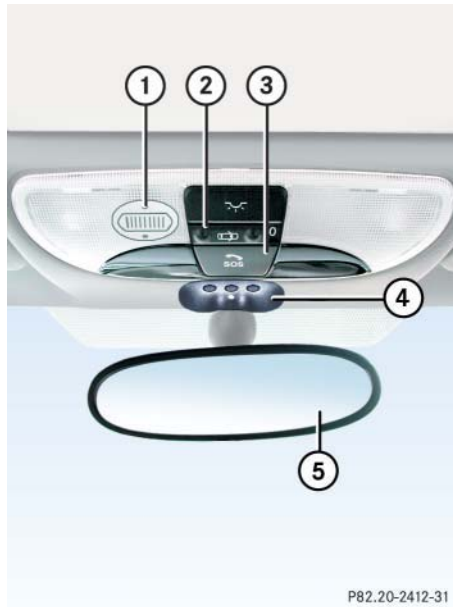

Item	Page
① Hands-free microphone for Tele Aid (emergency call system), telephone* and voice control system* (see separate operating instructions)	
② Interior lighting control	87
③ Tele Aid (emergency call system) button	144
④ Garage door opener	153
⑤ Rear view mirror	35, 99



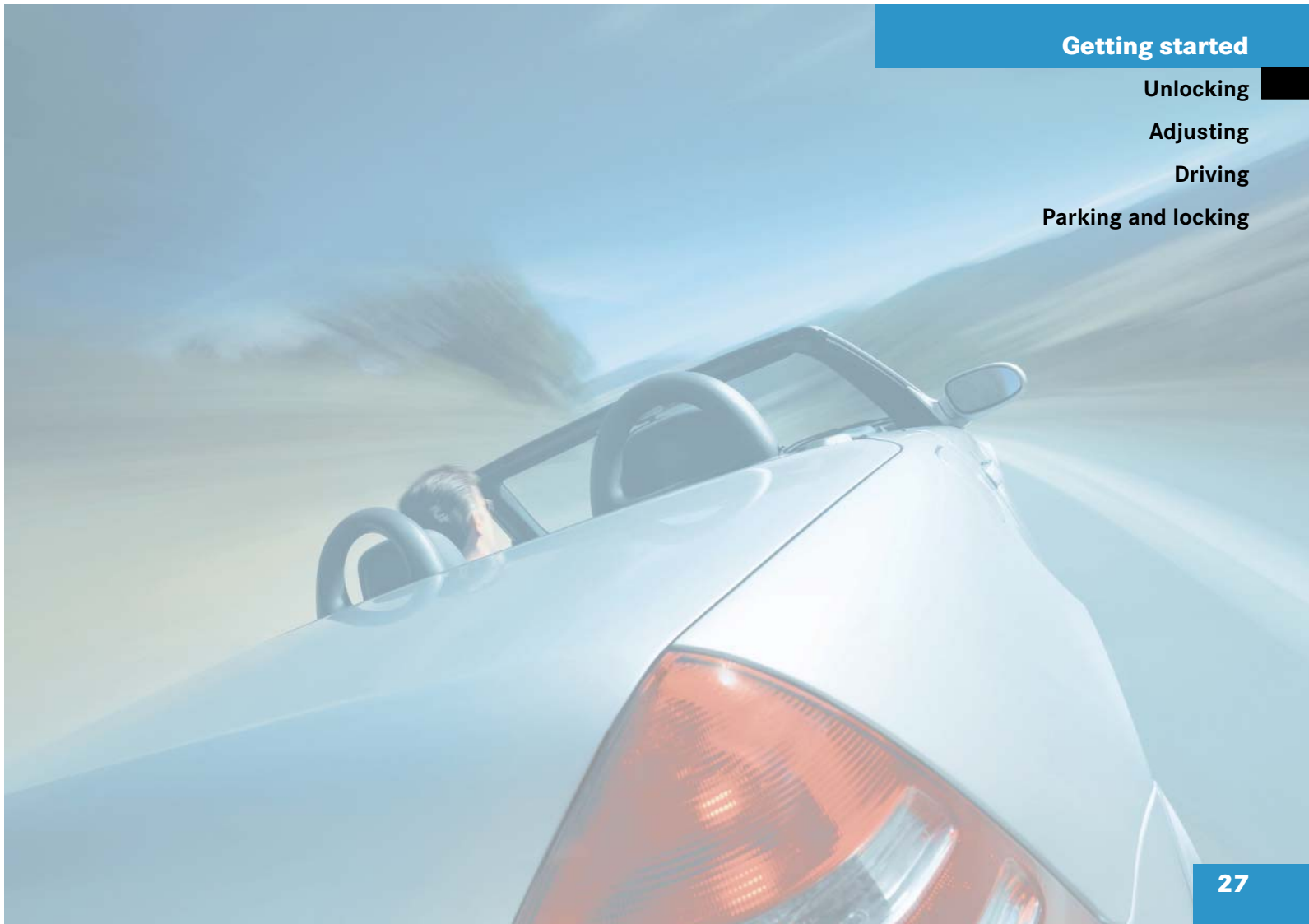

Getting started

Unlocking

Adjusting

Driving

Parking and locking

Getting started

Unlocking

The “Getting started” section provides an overview of the vehicle’s most basic functions. First-time Mercedes-Benz owners should pay special attention to the information given here.



If you are already familiar with the basic functions described here, the “Controls in detail” section will help you with further information. The corresponding page references are at the end of each segment.

▼ Unlocking

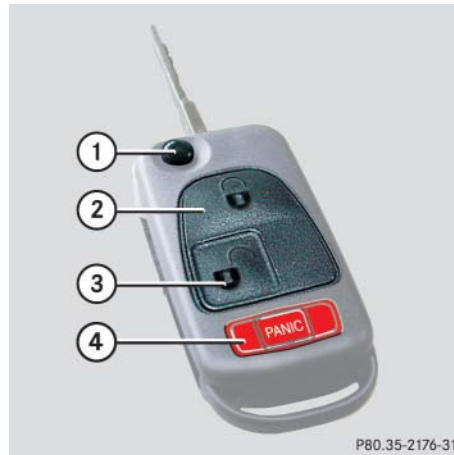
Unlocking with the remote control



Remote control with folding key

- ① Release button for key
- ②  Lock button
- ③  Unlock button
- ④  Panic button (▷ page 65)

- ▶ Press unlock button  on the remote control.

All turn signal lamps blink once. The locking knobs in the doors move up.

- ▶ Press release button ① on the remote control.

The key folds out.

- ▶ Get in the vehicle and insert the key in the steering lock (▷ page 29).

More information can be found in the “Controls in detail” section (▷ page 74).

Steering lock positions

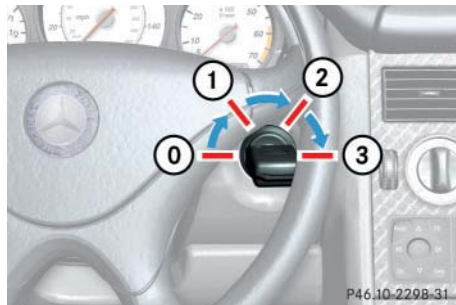

Steering lock

- 0** For removing key
The steering is locked when the key is removed from the steering lock. If necessary, move steering wheel slightly to allow the locking mechanism to engage.
- 1** Power supply to some electrical consumers, such as seat adjustment
- 2** Ignition (power supply for all electrical consumers) and driving position
- 3** Starting position

Warning!

When leaving the vehicle, always remove the key from the steering lock and lock the vehicle. Do not leave children unattended in the vehicle, or with access to an unlocked vehicle. Unsupervised use of vehicle equipment may cause an accident and/or serious personal injury.



The key can only be withdrawn in position **0**.

If necessary, move steering wheel slightly to allow the key to be turned clockwise to position **1**.

Vehicles with automatic transmission:
The key can only be removed from the steering lock with the gear selector lever in position **P**.



To prevent accelerated battery discharge and a possible dead battery, always remove the key from the steering lock when the engine is not in operation.

Getting started

Adjusting

▼ Adjusting

Warning!



All seat, head restraint, steering wheel, and rear view mirror adjustments, as well as fastening of seat belts, must be done before the vehicle is put into motion.

Seats

The seats can be adjusted either manually or electrically, depending on the vehicle's equipment.

Warning!



Do not adjust the driver's seat while driving. Adjusting the seat while driving could cause the driver to lose control of the vehicle.

Never ride in a moving vehicle with the seat back reclined. Sitting in an excessively reclined position can be dangerous. You could slide under the seat belt in a collision. If you slide under it, the belt would apply force at the abdomen or neck. That could cause serious or fatal injuries. The seat back and seat belts provide the best restraint when the wearer is in an upright position and belts are properly positioned on the body. Your seat must be adjusted so that you can correctly fasten your seat belt (> page 37).

Never place hands under the seat or near any moving parts while a seat is being adjusted.

Warning!



When leaving the vehicle, always remove the key from the steering lock and lock your vehicle.

The power seats* can also be operated with the driver's or passenger door open. Do not leave children unattended in the vehicle, or with access to an unlocked vehicle. Unsupervised use of vehicle equipment may cause an accident and/or serious personal injury.

Getting started

Adjusting

Warning!



Children 12 years old and under must never ride in this vehicle, except in a Mercedes-Benz authorized BabySmartTM¹ compatible child seat, which operates with the BabySmartTM system installed in the vehicle to deactivate the passenger front airbag when it is properly installed. Otherwise they will be struck by the airbag when it inflates in a crash. If this happens, serious or fatal injury will result.

Infants and small children must be seated in an appropriate infant or child restraint system, which is properly secured with the vehicle's seat belt, fully in accordance with the child seat manufacturer's instructions.

A child's risk of serious or fatal injuries is significantly increased if the child restraints are not properly secured in the vehicle and the child is not properly secured in the child restraint.

¹ BabySmartTM is a trademark of Siemens Automotive Corp.

Manual seat



- ① Head restraint height
- ② Backrest tilt
- ③ Seat height
- ④ Seat fore and aft adjustment

Seat height

- ▶ Pull up on handle ③.
- ▶ Use your body weight to push the seat downwards.
- ▶ Lift your weight off the seat to obtain a higher seat position.
- ▶ Let go of handle ③.

Seat fore and aft adjustment

- ▶ Pull up on handle ④.
- ▶ Move the seat forward or backward.
- ▶ Check for proper engagement before driving.

Adjust to a comfortable seating position that still allows you to reach the accelerator / brake pedal safely. The position should be as far rearward as possible, consistent with ability to properly operate controls.

Getting started

Adjusting



When moving the seat, ensure there are no items in the footwell or behind the seats. Otherwise you could damage the seats.

- ▶ Let go of handle ④. The seat should make an audible click.

Backrest tilt

- ▶ Turn handwheel ② forward or backward until your arms are slightly angled when holding the steering wheel.

Head restraint height

Warning!



For your protection, drive only with properly positioned head restraints.

Adjust head restraint so that the head restraint supports the back of the head at eye level. This will reduce the potential for injury to the head and neck in the event of an accident or similar situation.

Do not drive the vehicle without the seat head restraints. Head restraints are intended to help reduce injuries during an accident.

- ▶ Adjust the height of the head restraints by pulling them upwards manually.
- ▶ For a lower position, press release button ① and push down on the head restraints manually.

More information can be found in the “Controls in detail” section (▷ page 73).

Power seat*

- ▶ Switch on the ignition by turning the key in the steering lock to position **2**, or
- ▶ Open the driver's or passenger door.

The seat adjustment switches are located on the outer sides of the seats.

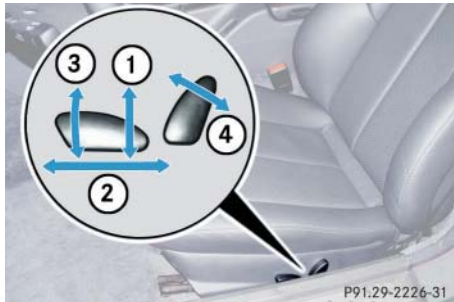

- ① Seat height
- ② Seat fore and aft adjustment
- ③ Seat cushion tilt
- ④ Backrest tilt

Seat height

- ▶ Press the switch up or down in the direction of arrow ①.

Seat fore and aft adjustment

- ▶ Press the switch forward or backward in the direction of arrow ②.

Adjust to a comfortable seating position that still allows you to reach the accelerator / brake pedal safely. The position should be as far to the rear as possible, consistent with ability to properly operate controls.



When moving the seat, ensure there are no items in the footwell or behind the seats. Otherwise you could damage the seats.

Seat cushion tilt

- ▶ Press the switch up or down in the direction of arrow ③ until your upper legs are lightly supported.

Backrest tilt

- ▶ Press the switch forward or backward in the direction of arrow ④ until your arms are slightly angled when holding the steering wheel.

Head restraint height**Warning!**

For your protection, drive only with properly positioned head restraints.

Adjust head restraint so that the head restraint supports the back of the head at eye level. This will reduce the potential for injury to the head and neck in the event of an accident or similar situation.

Do not drive the vehicle without the seat head restraints. Head restraints are intended to help reduce injuries during an accident.

Getting started

Adjusting

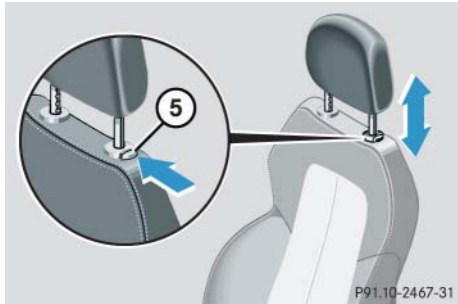

⑤ Release button

- ▶ Adjust the height of the head restraints by pulling them upwards manually.
- ▶ For a lower position, press release button ⑤ and push down on the head restraints manually.

More information can be found in the “Controls in detail” section (▶ page 81).

Telescoping steering column*

Warning!



Do not adjust the steering wheel while driving. Adjusting the steering wheel while driving, or driving without the adjustment locked could cause the driver to lose control of the vehicle.

When leaving the vehicle, always remove the key from the steering lock and lock your vehicle.

Do not leave children unattended in the vehicle, or with access to an unlocked vehicle. Unsupervised use of vehicle equipment may cause an accident and/or serious personal injury.

Steering wheel adjustment



① Adjustment handle

- ▶ To unlock the steering column, pull out handle ① as far as it will go.
- ▶ Move the steering wheel to the desired position.
- ▶ Push handle ① back to its original position to relock the steering wheel. You should hear an audible click.

The steering wheel is again fixed into place.



Do not drive the vehicle until you have properly locked the steering column.

If the indicator lamp  comes on while the engine is running, the steering column is not locked properly (▷ page 206).

Mirrors

Adjust the interior and exterior rear view mirrors before driving so that you have a good view of the road and traffic conditions.

Warning!



In the case of an accident, liquid electrolyte may escape the mirror housing if the mirror glass breaks.

Electrolyte has an irritating effect. Do not allow the liquid to come into contact with eyes, skin, clothing, or the respiratory system. In case it does, immediately flush affected area with water, and seek medical help if necessary.

Getting started

Adjusting

Interior rear view mirror

- ▶ Manually adjust the interior rear view mirror.

Exterior rear view mirror

Warning!



Exercise care when using the passenger side exterior rear view mirror. The mirror surface is convex (outwardly curved surface for a wider field of view). Objects in mirror are closer than they appear. Check your interior rear view mirror or glance over your shoulder before changing lanes.



Electrolyte drops coming into contact with the vehicle paint finish can only be completely removed while in their liquid state and by applying plenty of water.

Getting started

Adjusting

The switch is located on the center console.

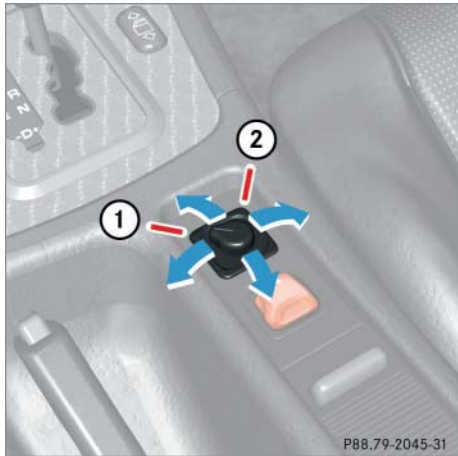

- ① Driver's side mirror
- ② Passenger side mirror

- ▶ Make sure the ignition is switched on. All the lights in the instrument cluster light up.
- ▶ Turn switch to position ① for the left mirror or to position ② for the right mirror.
- ▶ Toggle switch up, down, left or right according to the setting desired.



At low ambient temperatures, the exterior mirrors will be heated automatically.



If an exterior rear view mirror housing is forcibly pushed forward or rearward, reposition it by applying firm pressure until it snaps into place. The mirror housing is now properly positioned and you can adjust the mirror normally.

More information can be found in the "Controls in detail" section (▷ page 99).

▼ Driving

Warning!

Do not lay any objects in the driver's footwell. Be careful that floor mats or carpets in the driver's footwell have sufficient clearance for the pedals.

During sudden driving or braking maneuvers the objects could get caught between the pedals. You could then no longer brake or accelerate.

Fastening the seat belts**Warning!**

Always fasten your seat belt before driving off. Always make sure your passengers are properly restrained, even pregnant women.

Failure to wear and properly fasten and position your seat belt greatly increases your risk of injuries and their likely severity in an accident. You and your passenger should always wear seat belts.

If you are ever in an accident, your injuries can be considerably more severe without your seat belt properly buckled. Without your seat belt buckled, you are much more likely to hit the interior of the vehicle or be ejected from it. You can be seriously injured or killed.

In the same crash, the possibility of injury or death is lessened if you are wearing your seat belt. The airbags can only protect as expected if the occupants are using their seat belts (▷ page 52).

Warning!

Children 12 years old and under must never ride in this vehicle, except in a Mercedes-Benz authorized BabySmartTM¹ compatible child seat, which operates with the BabySmartTM system installed in the vehicle to deactivate the passenger front airbag when it is properly installed. Otherwise they will be struck by the airbag when it inflates in a crash. If this happens, serious or fatal injury will result.

A child's risk of serious or fatal injuries is significantly increased if the child restraints are not properly secured in the vehicle and the child is not properly secured in the child restraint.

¹ BabySmartTM is a trademark of Siemens Automotive Corp.

Getting started

Driving

Warning!



Never ride in a moving vehicle with the seat backrest reclined. Sitting in an excessively reclined position can be dangerous. You could slide under the seat belt in a collision. If you slide under it, the belt would apply force at the abdomen or neck. That could cause serious or even fatal injuries. The seat backrest and seat belt provide the best restraint when the wearer is in an upright position and the belt is properly positioned on the body.

Warning!



Never let more people ride in the vehicle than there are seat belts available. Be sure everyone riding in the vehicle is correctly restrained with a separate seat belt.

Warning!



Read and observe the additional warning notices printed in the “Safety and Security” section (▷ page 55) and (▷ page 57).

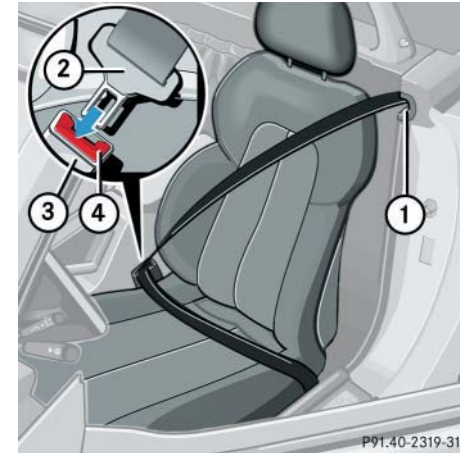

- ① Seat belt housing
- ② Latch plate
- ③ Buckle
- ④ Release button

- ▶ With a smooth motion, pull the belt from seat belt housing ①.
- ▶ Place the belt over your shoulder.
- ▶ Push latch plate ② into buckle ③ until it clicks.
- ▶ If necessary, tighten the lap portion to a snug fit by pulling shoulder portion up.

Proper use of seat belts

- Do not twist the belt when fastening.
- Adjust the seat belt so that the shoulder portion is located as close as possible to the middle of the shoulder (it should not touch the neck or pass under the arm).
- Position the lap belt as low as possible on your hips (over hip joint) and not across the abdomen.
- Place the seat backrest in a nearly upright position.
- Never use a seat belt for more than one person at a time.
- Do not fasten a seat belt around a person and another object at the same time.
- Check your seat belt during travel to ensure it is properly positioned.
- Make sure the seat belt is always fitted snugly. You should avoid wearing bulky clothing, such as winter coats, when traveling in the vehicle.

Getting started

Driving

Warning!



Do not pass belts over sharp edges. They could tear.

Do not allow the belt to get caught in the door or in the seat adjustment mechanism. This could damage the belt.

Never attempt to make modifications to seat belts. This could impair the effectiveness of the belts.

Damaged seat belts or belts that were highly stressed in an accident must be replaced. Contact an authorized Mercedes-Benz Center.

Getting started

Driving

Starting the engine

Warning!



Inhalation of exhaust gas is hazardous to your health. All exhaust gas contains carbon monoxide, and inhaling it can cause unconsciousness and lead to death.

Do not run the engine in confined areas (such as garage) which are not properly ventilated. If you think that exhaust gas fumes are entering the vehicle while driving, have the cause determined and corrected immediately. If you must drive under these conditions, drive only with at least one window fully open.

Manual transmission



Gearshift pattern for manual transmission

- ▶ Depress the brake pedal.
- ▶ Make sure the gearshift lever is in neutral position.

- ▶ Fully depress clutch pedal.

Otherwise the engine cannot be started due to the integrated safety interlock.

More information can be found in the “Controls in detail” section (▷ page 92).

Starting

- ▶ Do not depress the accelerator.
- ▶ Turn the key in the steering lock to position **3** and hold until the engine starts (▷ page 29).

For information on turning off the engine (▷ page 48).

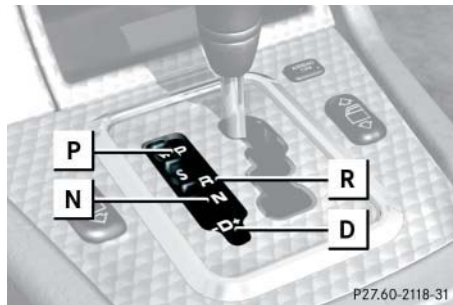
Automatic transmission***Gearshift pattern for automatic transmission**

- P** Park position with selector lever lock
- R** Reverse gear
- N** Neutral
- D** Drive position

More information can be found in the “Controls in detail” section (▷ page 93).

Starting

- ▶ Make sure the gear selector lever is set to **P**.
- ▶ Do not depress the accelerator.
- ▶ Turn the key in the steering lock to position **3**. Release when the engine is firing regularly (▷ page 29).
- ▶ Depress the brake pedal.

The selector lever lock is released.

For information on turning off the engine (▷ page 48).

More information can be found in the “Controls in detail” section (▷ page 92).

Starting difficulties

If the engine does not start as described, carry out the following steps:

- ▶ Turn the key in steering lock to position **0** and repeat starting procedure.
Remember that extended starting attempts can drain the battery
- ▶ Get a jump start (▷ page 254).

If the engine does not start after several starting attempts, there could be a malfunction in the engine electronics or in the fuel supply system.

- ▶ Notify an authorized Mercedes-Benz Center.

Getting started

Driving

Parking brake

Warning!



When leaving the vehicle, always remove the key from the steering lock and lock the vehicle. Do not leave children unattended in the vehicle, or with access to an unlocked vehicle. Children could release the parking brake, which could result in an accident and/or serious injury.

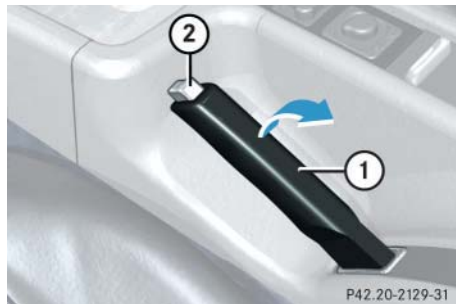

- ① Brake lever
- ② Release button

- ▶ Pull up slightly on brake lever ① and press release button ②.

Return brake lever ① down to its original position.

The indicator lamp **BRAKE** (USA only) or **(P)** (Canada only) in the instrument cluster goes out.

Driving

- ▶ Move selector lever to position **D** or **R** (manual transmission: first or reverse gear)
- ▶ Release the brake pedal.
- ▶ Carefully depress the accelerator pedal.

Once the vehicle is in motion, the automatic central locking system engages and the locking knobs drop down.



You can open a locked door from the inside. Open door only when conditions are safe to do so.



If you hear a warning signal when driving off, you have forgotten to release the parking brake.

Release the parking brake.

After a cold start, the automatic transmission shifts at a higher engine revolution. This allows the catalytic converter to reach its operating temperature earlier.



Vehicles with automatic transmission: Wait for the gear selection process to complete before setting the vehicle in motion.

Warning!

Vehicles with automatic transmission: It is dangerous to shift the selector lever out of **P** or **N** if the engine speed is higher than idle speed. If your foot is not firmly on the brake pedal, the vehicle could accelerate quickly forward or in reverse. You could lose control of the vehicle and hit someone or something. Only shift into gear when the engine is idling normally and when your right foot is firmly on the brake pedal.



Simultaneously depressing the accelerator pedal and applying the brake reduces engine performance and causes premature brake and drivetrain wear.

Warning!

On slippery road surfaces, never downshift in order to obtain braking action. This could result in drive wheel slip and reduced vehicle control. Your vehicle's ABS will not prevent this type of loss of control.

Switching on headlamps**Exterior lamp switch**

- ① Off
 - ② Low beam headlamps on
- Turn the switch to .

More information can be found in the “Controls in detail” section (▷ page 83).

Turn signals and high beam

The combination switch is on the left of the steering column.

**Combination switch**

- ① Turn signals, right
- ② Turn signals, left

► Press the combination switch up ① or down ②. ▷▷

Getting started

Driving



To signal minor directional changes, move combination switch to point of resistance only and release. The turn signal blinks three times.

High beam

- ▶ Push the combination switch forward.

The high beam symbol  in the instrument cluster lights up.

More information can be found in the “Controls in detail” section (▶ page 85).

Windshield wipers

The combination switch is on the left of the steering column.



Combination switch

- ① Switching on windshield wipers
- ② Single wipe

- ▶ Make sure the ignition is switched on.

Switching on windshield wipers

- ▶ Turn the combination switch to the desired position depending on the intensity of the rain.

- 0 Windshield wipers off
- I Intermittent wiping
- II Normal wiper speed
- III Fast wiper speed



Fast wiper speed III goes to setting II when the vehicle is standing still.

Single wipe

- ▶ Press combination switch briefly in the direction of arrow ②.

The windshield wipers wipe one time without washer fluid.

Wiping with windshield washer fluid

- ▶ Push switch in the direction of arrow ② past the resistance point.

The windshield wiper operates with washer fluid.

For information on filling up the washer reservoir, see "Windshield washer system and headlamp cleaning system*" (▷ page 184).



If anything blocks the windshield wipers (snow, etc.), switch them off immediately.

- For safety reasons, withdraw the key from the steering lock before attempting to remove any blockage.
- Remove blockage.
- Turn the windshield wipers on again.

If windshield wipers fail to function at all in switch position I,

- set the combination switch to the next highest wiper speed.
- have the windshield wipers checked at the nearest authorized Mercedes-Benz Center.

Problems while driving

The engine runs erratically and misfires

- An ignition cable may be damaged.
- The engine electronics may not be operating properly.
- Unburned gasoline may have entered the catalytic converter and damaged it.
- ▶ Give very little gas.
- ▶ Have the problem repaired by an authorized Mercedes-Benz Center as soon as possible.

Getting started

Driving

The coolant temperature is over 248°F (120°C)

The coolant is too hot and is no longer cooling the engine.

- ▶ Stop the vehicle as soon as possible and turn off the engine. Allow engine and coolant to cool down.
- ▶ Check the coolant level and add coolant if necessary (▷ page 180).

In case of accident

If the vehicle is leaking gasoline:

- ▶ Do not start the engine under any circumstances.
- ▶ Notify local fire and/or police authorities.

If the extent of the damage cannot be determined:

- ▶ Notify an authorized Mercedes-Benz Center.

If no damage can be determined on the

- major assemblies
 - fuel system
 - engine mount
- ▶ Start the engine in the usual manner.

▼ Parking and locking

You have now completed your first drive. You have properly stopped and parked your vehicle. End your drive as follows.

Warning!



Wait until the vehicle is stationary before removing the key from the starter switch. The vehicle cannot be steered when the key is removed.

Warning!



With the engine not running, there is no power assistance for the brake and steering system. In this case, it is important to keep in mind that a considerably higher degree of effort is necessary to brake and steer the vehicle.

Warning!



Do not park this vehicle in areas where combustible materials such as grass, hay or leaves can come into contact with the hot exhaust system, as these materials could be ignited and cause a vehicle fire.

To reduce the risk of personal injury as a result of vehicle movement, before turning off the engine and leaving the vehicle always:

- Keep right foot on brake pedal.
- Pull up the brake lever firmly.
- Move the selector lever to position **P** (manual transmission: first or reverse gear).
- Slowly release brake pedal.
- When parked on an incline, turn front wheels towards the road curb.
- Turn the key to steering lock position **0** and remove.

Getting started

Parking and locking

Parking brake

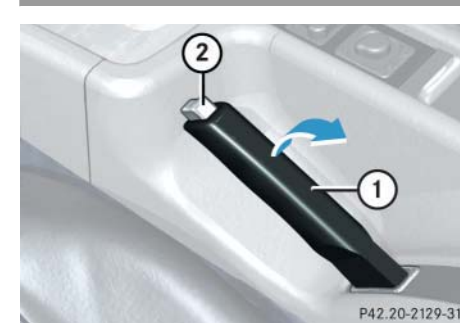

- ① Brake lever
- ② Release button

- Pull up brake lever ① firmly.

When the engine is running, the indicator lamp **BRAKE** (USA only) or  (Canada only) in the instrument cluster will be illuminated.

Getting started

Parking and locking

Warning!



When leaving the vehicle, always remove the key from the steering lock and lock the vehicle. Do not leave children unattended in the vehicle, or with access to an unlocked vehicle. Children could release the parking brake and/or move the gear selector lever from position **P**, either of which could result in an accident and/or serious injury.

Warning!



Getting out of your vehicle with the selector lever not fully engaged in position **P** is dangerous. Also, when parked on an incline, position **P** alone may not prevent your vehicle from moving, possibly hitting people or objects.

Always set the parking brake in addition to shifting to position **P** (manual transmission: first or reverse gear).

When parked on an incline, turn front wheel towards the road curb.

Switching off headlamps

- ▶ Turn the exterior lamp switch to **0** (▷ page 43).

More information can be found in the “Controls in detail” section (▷ page 83).

Turning off engine

- ▶ Place the gear selector lever in position **P** (manual transmission: first or reverse gear).



Always set the parking brake in addition to shifting to position **P** (manual transmission: first or reverse gear).

On steep slopes, turn the front wheels towards the road curb.

- ▶ Turn the key in the steering lock to position **0** (▷ page 29) and remove it. The immobilizer is activated.



Vehicles with automatic transmission:
The key can only be removed from the steering lock with the gear selector lever in position **P**.

- ▶ Press the seat belt release button (▷ page 38).

Allow the retractor to completely rewind the seat belt by guiding the latch plate.



With the key removed and the driver's door open, a warning sounds if the vehicle's exterior lamps (except standing lamps) are not switched off.

Warning!



To prevent possible personal injury, always keep hands and fingers away from the door openings when closing the doors. Be especially careful when small children are around.

Before closing doors, make sure there is no possibility of someone getting caught in a door during closing.

- ▶ After exiting the vehicle, press the lock button  on the remote control (▷ page 28).

The turn signal lamps blink three times.
The locking knobs on the doors move down.

Warning!



When leaving the vehicle, always remove the key from the steering lock and lock your vehicle. Do not leave children unattended in the vehicle, or with access to an unlocked vehicle. Unsupervised use of vehicle equipment may cause an accident and/or serious personal injury.

More information can be found in the "Controls in detail" section (▷ page 74).





Safety and Security

Occupant safety

Panic alarm

Driving safety systems

Anti-theft systems

Safety and Security

Occupant safety

▼ Occupant safety

In this section you will learn the most important facts about the restraint systems of the vehicle.

The restraint systems are

- Seat belts
- Emergency tensioning device
- Airbags
- Child seats
- Child seat recognition

As independent systems their protective effects work in conjunction with each other.



For information on infants and children traveling with you in the vehicle and restraint systems for infants and children, see “Children in the vehicle” (▷ page 60).

The **SRS** indicator lamp in the instrument cluster lights up for about four seconds when you turn the key in the steering lock to position **1** or **2**. It goes out when you start the engine. This shows that the restraint systems are operational.

If the lamp does not come on at all or if it fails to extinguish after approximately four seconds or if it comes on thereafter, a malfunction in the system has been detected.

More information can be found in the “Practical hints” section (▷ page 203).

Warning!



In the event that the SRS malfunction indicator lamp lights up during driving or does not come on at all, the SRS may not be operational. For your safety, we strongly recommend that you visit an authorized Mercedes-Benz Center immediately to have the system checked; otherwise the SRS may not be activated when needed in an accident, which could result in serious or fatal injury, or it might deploy unexpectedly and unnecessarily which could also result in injury.

Improper work on the restraint systems, including incorrect installation and removal, can lead to possible injury through an unintended activation of the SRS.

In addition, through improper work there is a risk of rendering the SRS inoperative or causing unintended airbag deployment. Work on the SRS must therefore only be performed by qualified technicians. Contact your authorized Mercedes-Benz Center.

Airbags

Warning!



Airbags are designed to reduce the potential of injury in certain frontal (front airbags) impacts, or side (side impact airbags) impacts which may cause significant injuries. However, no system available today can totally eliminate injuries and fatalities.

The activation of the SRS temporarily releases a small amount of dust from the airbags. This dust, however, is neither injurious to your health, nor does it indicate a fire in the vehicle. The dust might cause some temporary breathing difficulty for people with asthma or other breathing trouble. To avoid this, you may wish to get out of the vehicle as soon as it is safe to do so. If you have any breathing difficulty but cannot get out of the vehicle after the airbag inflates, then get fresh air by opening a window or door.

Warning!



To reduce the risk of injury when the front airbags inflate, it is very important for the driver and passenger to always be in a properly seated position and to wear your seat belts.

For maximum protection in the event of a collision always be in normal seated position with your back against the backrest. Fasten your seat belt and ensure it is properly positioned on your body.

Since the airbag inflates with considerable speed and force, a proper seating and hands on steering wheel position will help to keep you at a safe distance from the airbag. Occupants who are unbelted, out of position or too close to the airbag can be seriously injured by an airbag as it inflates with great force in the blink of an eye:

- Sit properly belted in an upright position with your back against the seat backrest.

- Adjust the driver seat as far as possible rearward, still permitting proper operation of vehicle controls. The distance from the center of the driver's breastbone to the center of the airbag cover on the steering wheel must be at least ten inches (25 cm) or more. You should be able to accomplish this by a combination of adjustments to the seat and steering wheel. If you have any problems, please see your authorized Mercedes-Benz Center.
- Do not lean with your head or chest close to the steering wheel or dashboard.
- Keep hands on the outside of steering wheel rim. Placing hands and arms inside the rim can increase the risk and potential severity of hand/arm injury when driver front airbag inflates.
- Adjust the passenger seat as far as possible rearward from the dashboard when the seat is occupied. ▷▷

Safety and Security

Occupant safety



- Occupants, especially children, should never lean their heads in the area of the door where the side impact airbag inflates. This could result in serious injuries or death should the airbag be triggered. Always sit upright, properly use the seat belts and appropriate size infant or child restraint system.
- Children 12 years old and under must never ride in this vehicle, except in a Mercedes-Benz authorized BabySmart™ compatible child seat, which operates with the BabySmart™ system installed in the vehicle to deactivate the passenger side front airbag when it is properly installed. Otherwise they will be struck by the airbag when it inflates in a crash. If this happens, serious or fatal injury will result.

Failure to follow these instructions can result in severe injuries to you or other occupants.

If you sell your vehicle, you are responsible to make the buyer aware of these points. Be sure to give the buyer this Operator's Manual.

Warning!



Should you choose to place a child 12 years old or under in the passenger seat of your vehicle, you must properly use a BabySmart™¹ child restraint which will turn off the front passenger airbag. BabySmart™ will not, however, turn off any side impact airbag.

It should be noted that with respect to both side impact airbags there is a possibility for a side impact airbag related injury if occupants, especially children, are not properly seated or restrained when next to a side impact airbag which needs to deploy rapidly in a side impact in order to do its job.

To help avoid the possibility of injury, please follow these guidelines:

- (1) Occupants, especially children, should never place their bodies or lean their heads in the area of the door where the side impact airbag inflates. This could

result in serious injuries or death should the side impact airbag be activated.

- (2) Always sit upright, properly use the seat belts and use an appropriately sized infant or child restraint system for all children 12 years old or under.
- (3) Always wear seat belts properly.

If you believe that, even with the use of these guidelines, it would be safer for your passenger seat occupants to have the passenger side impact airbag deactivated, then deactivation can be accomplished upon your written request to do so at your authorized Mercedes-Benz Center at an additional cost.

Please contact your local authorized Mercedes-Benz Center or call our Customer Assistance Center at 1-800-FOR-MERCEDES (1-800-367-6372) for details.

¹ BabySmart™ is a trademark of Siemens Automotive Corp.

Safety and Security

Occupant safety



Airbags are designed to activate only in certain frontal (front airbags) impacts, or side (side impact airbags) impacts which exceed preset thresholds.

Only during these types of impacts, if of sufficient severity to meet the deployment thresholds, will they provide their supplemental protection.

The driver and passenger should always wear their seat belts. Otherwise it is not possible for the airbags to provide their supplemental protection.

In cases of other frontal impacts, angled impacts, roll-overs, other side impacts, rear collisions, or other accidents the airbags will not be activated. The driver and passengers will then be protected by the fastened seat belts.

We caution you not to rely on the presence of the airbags in order to avoid wearing your seat belt.

Your vehicle was originally equipped with airbags that are designed to activate in certain impacts exceeding a preset threshold to reduce the potential and severity of injury. It is important to your safety and that of your passengers that you replace deployed airbags and repair any malfunctioning airbags to ensure the vehicle will continue to provide supplemental crash protection for occupants.

Safety guidelines for the seat belt, emergency tensioning device and airbag

Warning!



- Damaged seat belts or belts that were highly stressed in an accident must be replaced and their anchoring points must also be checked. Use only belts installed or supplied by an authorized Mercedes-Benz Center.

- Airbags and emergency tensioning devices (ETDs) are designed to function on a one-time only basis. An airbag or ETD that was activated must be replaced.
- No modifications of any kind may be made to any components or wiring of the SRS. This includes changing or removing any component or part of the SRS, the installation of additional trim material, badges etc. over the steering wheel hub, passenger airbag cover, door trim panels, or door frame trims, and installation of additional electrical/electronic equipment on or near SRS components and wiring. Keep area between airbags and occupants free from objects (e.g. packages, purses, umbrellas, etc.).
- Do not pass belts over sharp edges. They could tear.
- Do not make any modification that could change the effectiveness of the belts. ▷▷

Safety and Security

Occupant safety



- An airbag system component within the steering wheel gets hot after the airbag has inflated. Do not touch.
- Improper work on the system, including incorrect installation and removal, can lead to possible injury through an unintended activation of the SRS.
- In addition, through improper work there is a risk of rendering the SRS inoperative or causing unintended airbag deployment. Work on the SRS must therefore only be performed by qualified technicians. Contact your authorized Mercedes-Benz Center.
- For your protection and the protection of others, when scrapping the airbag unit or emergency tensioning device, our safety instructions must be followed. These instructions are available from your authorized Mercedes-Benz Center.
- Given the considerable deployment speed and the textile structure of the airbags, there is the possibility of abrasions or other injuries resulting from airbag deployment.

When you sell your vehicle, we strongly urge you to give notice to the subsequent owner that it is equipped with an SRS by alerting them to the applicable section in the Operator's Manual.

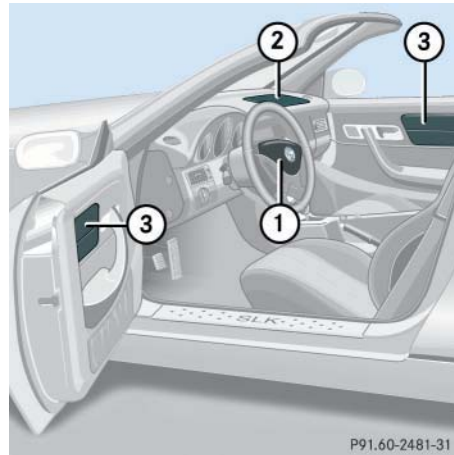

- ① Driver airbag
- ② Passenger airbag
- ③ Side impact airbags

Front airbags

Driver and passenger airbags are deployed:

- in the event of a frontal impact
- if impact exceeds a preset deployment threshold
- independently of the side impact airbags

The airbags will not deploy in impacts which do not exceed the system's deployment thresholds. You will then be protected by the fastened seat belts.

The passenger airbag will only be deployed if:

- the passenger seat is occupied
- the  indicator lamp in the center console is not lit (▷ page 62).
- the impact exceeds a preset deployment threshold



Do not place objects heavier than 20 lbs (9 kg) on the passenger seat. This could cause the front or side impact airbag on the passenger side to deploy in a crash which exceeds the system's deployment threshold.

Side impact airbags



The side impact airbags are deployed:

- on the impacted side of the vehicle
- in impacts exceeding a preset deployment threshold
- independently of the front airbags

The side impact airbags will not deploy in impacts which do not exceed the system's deployment threshold.

The passenger side impact airbag will only be deployed if the system senses that the passenger seat is occupied.

Seat belts

When the engine is started, the seat belt non-usage warning lamp  illuminates to remind you and your passengers to fasten your seat belts. If the driver's seat belt is not fastened before the engine is started, the seat belt non-usage warning lamp  illuminates and a warning chime sounds for approximately six seconds when the engine is started.

The use of seat belts and infant and child restraint systems is required by law in most states and all Canadian provinces. Even where this is not the case, all vehicle occupants should have their seat belts fastened whenever the vehicle is in motion.

Information on fastening seat belts is found in the "Getting started" section ([▷ page 37](#)).



For information on infants and children traveling with you in the vehicle and restraint systems for infants and children, see "Children in the vehicle" ([▷ page 60](#)).

Safety and Security

Occupant safety

Warning!



Always fasten your seat belt before driving off. Always make sure your passengers are properly restrained, even pregnant women.

Failure to wear and properly fasten and position your seat belt greatly increases your risk of injuries and their likely severity in an accident. You and your passenger should always wear seat belts.

If you are ever in an accident, your injuries can be considerably more severe without your seat belt properly buckled. Without your seat belt buckled, you are much more likely to hit the interior of the vehicle or be ejected from it. You can be seriously injured or killed.

In the same crash, the possibility of injury or death is lessened if you are properly wearing your seat belt. Airbags can only protect as they are designed if the occupants are properly wearing their seat belts.

Warning!



Never ride in a moving vehicle with the seat backrest reclined. Sitting in an excessively reclined position can be dangerous. You could slide under the seat belt in a collision. If you slide under it, the belt would apply force at the abdomen or neck. That could cause serious or even fatal injuries. The seat backrest and seat belt provide the best restraint when the wearer is in an upright position and the belt is properly positioned on the body.

Warning!



Never let more people ride in the vehicle than there are seat belts available. Be sure everyone riding in the vehicle is correctly restrained with a separate seat belt.

Warning!



Damaged seat belts or belts that were highly stressed in an accident must be replaced and their anchoring points must also be checked.

Only use seat belts which have been approved by Mercedes-Benz.

Do not make any modifications to the seat belts. This can lead to unintended activation or to failure.

Have all work carried out only by qualified technicians. Contact your authorized Mercedes-Benz Center.

Safety and Security

Occupant safety

Warning!



USE SEAT BELTS PROPERLY

- Seat belts can only work when used properly. Never wear seat belts in any other way than as described in this section, as that could result in serious injuries in case of an accident.
 - Each occupant should wear their seat belt at all times, because seat belts help reduce the likelihood of and potential severity of injuries in accidents, including rollovers. The integrated restraint system includes SRS (driver airbag, passenger airbag, side impact airbags, ETD (seat belt emergency tensioning device), and driver knee bolster. The system is designed to enhance the protection offered to properly belted occupants in certain frontal (front airbags) and side (side impact airbags) impacts which exceed preset deployment thresholds.
- Never wear the shoulder belt under your arm, against your neck or off your shoulder. In a crash, your body would move too far forward. That would increase the chance of head and neck injuries. The belt would also apply too much force to the ribs or abdomen, which could severely injure internal organs such as your liver or spleen.
 - Never wear belts over rigid or breakable objects in or on your clothing, such as eyeglasses, pens, keys, etc., as these might cause injuries.
 - Position the lap belt as low as possible on your hips and not across the abdomen. If the belt is positioned across your abdomen, it could cause serious injuries in a crash.
- Never use a seat belt for more than one person at a time. Do not fasten a seat belt around a person and another person or other objects.
 - Belts should not be worn twisted. In a crash, you wouldn't have the full width of the belt to manage impact forces. The twisted belt against your body could cause injuries.
 - Pregnant women should also use a lap-shoulder belt. The lap belt portion should be positioned as low as possible on the hips to avoid any possible pressure on the abdomen.
 - Never place your feet on the instrument panel or on the seat. Always keep both feet on the floor in front of the seat.

Safety and Security

Occupant safety

Emergency tensioning device (ETD)

The seat belts are equipped with emergency tensioning devices.

The ETD is designed to activate in the following cases when the seat belts are fastened:

- in frontal or rear-end impacts exceeding a preset severity level
- if the restraint systems are operational and functioning correctly, see **SRS** indicator lamp (▷ page 52).

In an impact, emergency tensioning devices remove slack from the belts in such a way that the seat belts fit more snugly against the body.

Warning!



An emergency tensioning device (ETD) that was activated must be replaced.

When disposing of the emergency tensioning device, our safety instructions must be followed. These are available at your authorized Mercedes-Benz Center.



Do not place objects heavier than 20 lbs (9 kg) on the passenger seat. This could cause the front or side impact airbag on the passenger side to deploy in a crash which exceeds the system's deployment threshold.

Children in the vehicle

If an infant or child is traveling with you in the vehicle:

- Secure the child using an infant or child restraint appropriate to the age and size of the child and recommended for use by Mercedes-Benz.
- Ensure the infant or child is properly secured by a belt at all times while the vehicle is in motion.

Infant and child restraint seats and information on choosing an appropriate restraint system can be obtained from any Mercedes-Benz Center.

Infant and child restraint systems

Use only a BabySmart™ compatible child restraint for the passenger seat in this vehicle.

We recommend all infants and children be properly restrained at all times while the vehicle is in motion.

Safety and Security

Occupant safety

The passenger lap-shoulder belt has a special seat belt retractor for secure fastening of child restraints.

To fasten a child restraint, follow child restraint instructions for mounting. Then pull the shoulder belt out completely and let it retract. During seat belt retraction, a ratcheting sound can be heard to indicate that the special seat belt retractor is activated. The belt is now locked. Push down on child restraint to take up any slack.

To deactivate, release seat belt buckle and let seat belt retract completely. The seat belt can again be used in the usual manner.

Warning!



Never release the seat belt buckle while the vehicle is in motion, since the special seat belt retractor will be deactivated.



The use of infant or child restraints is required by law in all 50 states, the District of Columbia, the U.S. territories and all Canadian provinces.

Infants and small children should be seated in an appropriate infant or child restraint system properly secured by a lap shoulder belt that complies with U.S. Federal Motor Vehicle Safety Standard 213 and Canadian Motor Vehicle Safety Standard 213.

A statement by the child restraint manufacturer of compliance with this standard can be found on the instruction label on the restraint and in the instruction manual provided with the restraint.

When using any infant or child restraint system, be sure to carefully read and follow all manufacturer's instructions for installation and use.

Please read and observe warning labels affixed to inside of vehicle and to infant or child restraints.

Warning!



Children 12 years old and under must never ride in this vehicle, except in a Mercedes-Benz authorized BabySmartTM compatible child seat, which operates with the BabySmartTM system installed in the vehicle to deactivate the passenger side front airbag when it is properly installed. Otherwise they will be struck by the airbag when it inflates in a crash. If this happens, serious or fatal injury can result.

Infants and small children must be seated in an appropriate BabySmartTM compatible infant or child restraint system, which is properly secured with the vehicle's seat belt, fully in accordance with the child seat manufacturer's instructions. >>

¹ BabySmartTM is a trademark of Siemens Automotive Corp.

Safety and Security

Occupant safety



Infants and small children should never share a seat belt with another occupant. During an accident, they could be crushed between the occupant and seat belt.

Children too big for child restraint systems should use regular seat belts. Position the shoulder belt across chest and shoulder, not face or neck. A booster seat may be necessary to achieve proper belt positioning for children from 41 lbs. until they reach a height where a lap/shoulder belt fits properly without a booster.

A child's risk of serious or fatal injuries is significantly increased if the child restraints are not properly secured in the vehicle and the child is not properly secured in the child restraint.

When the child restraint is not in use, remove it from the vehicle or secure it with the seat belt to prevent the child restraint from becoming a projectile in the event of an accident.

Do not leave children unattended in the vehicle; even if the children are secured in a child restraint system. Unsupervised children in a child restraint system may use vehicle equipment and may cause serious personal injury.

BabySmart™¹ airbag deactivation system



① AIRBAG OFF indicator lamp

Special BabySmart™ compatible child seats, designed for use with the Mercedes-Benz system and available at any authorized Mercedes-Benz Center are required for use with the BabySmart™ airbag deactivation system. With the special child seat properly installed, the passenger front airbag will not deploy.

¹ BabySmart™ is a trademark of Siemens Automotive Corp.

The  indicator lamp ① located in the center console will be illuminated, except with the key removed or in the steering lock position **0**.



The system does not deactivate the side impact airbag and the emergency tensioning device.

Self-test BabySmart™ without special child seat installed

After turning the key in the steering lock to position **1** or **2**, the  indicator lamp located in the center console lights up for approx. six seconds and then goes out.

If the indicator lamp should not come on or is continuously lit, the system is not functioning. You must see an authorized Mercedes-Benz Center before seating any child on the passenger seat.

More information can be found in the “Practical hints” section (> page 211).

Safety and Security

Occupant safety

Warning!



The BabySmart™ airbag deactivation system will **ONLY** work with a special child seat designed to operate with it. It will not work with child seats which are not BabySmart™ compatible.

Never place anything between seat cushion and child seat (e.g. pillow), since it reduces the effectiveness of the deactivation system. The bottom of the child seat must make full contact with the passenger seat cushion. An incorrectly mounted child seat could cause injuries to the child in case of an accident, instead of protecting the child.

Follow the manufacturer’s instructions for installation of special child seats.

Safety and Security

Occupant safety

Warning!



When using a BabySmart™ compatible child seat on the passenger seat, the front passenger airbag will not deploy only if the  indicator lamp remains illuminated.

Please be sure to check the indicator every time you use the special system child seat. Should the light go out while the restraint is installed, please check installation. If the light remains out, do not use the BabySmart™ restraint to transport children on the passenger seat until the system has been repaired.

Warning!



Do not place powered-on laptops, cell phones and like electronic devices on the passenger seat. Signals from such devices may interfere with the BabySmart™ system. Such signal interference may cause the  indicator lamp not to come on during self-test or be continuously lit, indicating that the system is not functioning.

▼ Panic alarm

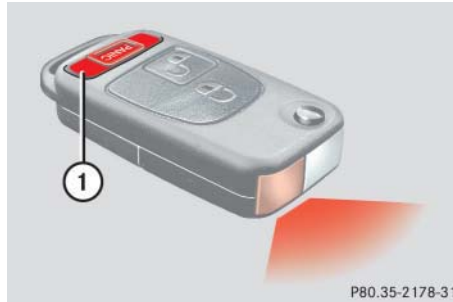

① **PANIC** button

An audible alarm and blinking exterior lamps will operate for approximately 2½ minutes.

Activating

- ▶ Press and hold button ① for at least one second.

Deactivating

- ▶ Press button ① again
- or
- ▶ Insert key in steering lock and turn to position **2**.

i

For operation in the USA only: This device complies with Part 15 of the FCC Rules. Operation is subject to the following two conditions:

- (1) This device may not cause harmful interference, and
- (2) this device must accept any interference received, including interference that may cause undesired operation.

Any unauthorized modification to this device could void the user's authority to operate the equipment.

Safety and Security

Driving safety systems

▼ Driving safety systems

In this section you will find information on the following driving safety systems:

- ABS (Antilock Brake System)
- BAS (Brake Assist System)
- ESP (Electronic Stability Program)



In winter operation, the maximum effectiveness of the ABS and ESP is only achieved with winter tires (M+S tires), or snow chains as required.

Warning!



The following factors increase the risk of accidents:

- Excessive speed, especially in turns
- Wet and slippery road surfaces
- Following another vehicle too closely

The ABS, BAS and ESP cannot reduce this risk.

Always adjust your driving style to the prevailing road and weather conditions.

ABS

Warning!



Do not pump the brake pedal. Use firm, steady brake pedal pressure instead. Pumping the brake pedal defeats the purpose of the ABS and significantly reduces braking effectiveness.

The Antilock Brake System (ABS) regulates the brake pressure so that the wheels do not lock during braking. This allows you to maintain the ability to steer your vehicle.

The ABS is functional above a speed of approximately 5 mph (8 km/h) independent of road surface conditions.

On slippery road surfaces, the ABS will respond even with light brake pressure.

The  malfunction indicator lamp in the instrument cluster (▷ page 20) lights up when you turn the key in the steering lock to position **2**. It goes out when the engine is running.

Braking

At the instant one of the wheels is about to lock up, a slight pulsation can be felt in the brake pedal, indicating that the ABS is in the regulating mode.

- ▶ Keep firm and steady pressure on the brake pedal while experiencing the pulsation.

Continuous, steady brake pedal pressure yields the advantages provided by the ABS, namely braking power and the ability to steer the vehicle.

The pulsating brake pedal can be an indication of hazardous road conditions and functions as a reminder to take extra care while driving.

Emergency brake maneuver

- ▶ Keep continuous full pressure on the brake pedal.

Warning!



The ABS cannot prevent the natural laws of physics from acting on the vehicle, nor can it increase braking or steering efficiency beyond that afforded by the condition of the vehicle brakes and tires or the traction. The ABS cannot prevent accidents, including those resulting from excessive speed in turns, following another vehicle too closely, or hydroplaning. Only a safe, attentive, and skillful driver can prevent accidents. The capabilities of an ABS equipped vehicle must never be exploited in a reckless or dangerous manner which could jeopardize the user's safety or the safety of others.

For more information, see "Practical hints" (▷ page 199).

BAS

The Brake Assist System (BAS) operates in emergency situations. If you apply the brakes very quickly, the BAS automatically provides full brake boost, thereby potentially reducing braking distance. Apply continuous full braking pressure until the emergency braking situation is over. The ABS will prevent the wheels from locking.

When you release the brake pedal, the brakes function again as normal. The BAS is then deactivated.

The malfunction indicator lamp for the ESP is combined with that of the BAS.

The  malfunction indicator lamp in the instrument cluster lights up when you turn the key in the steering lock to position **2**. It goes out when the engine is running.

For more information, see "Practical hints" (▷ page 199).

Safety and Security

Driving safety systems

Warning!





The BAS cannot prevent the natural laws of physics from acting on the vehicle, nor can it increase braking efficiency beyond that afforded by the condition of the vehicle brakes and tires or the traction. The BAS cannot prevent accidents, including those resulting from excessive speed in turns, following another vehicle too closely, or hydroplaning. Only a safe, attentive, and skillful driver can prevent accidents. The capabilities of a BAS equipped vehicle must never be exploited in a reckless or dangerous manner which could jeopardize the user's safety or the safety of others.

ESP

The Electronic Stability Program (ESP) monitors the vehicle's traction (force of adhesive friction between the tires and the road surface) and handling.

The ESP recognizes when a wheel is spinning or if the vehicle starts to skid. By applying brakes to the appropriate wheel and by limiting engine output, the ESP works to stabilize the vehicle. The ESP is especially useful while driving off and on wet or slippery road surfaces.

The ESP warning lamp  in the speedometer dial flashes when the ESP is engaged.

The warning lamp  in the speedometer dial lights up when you turn the key in the steering lock to position **2**. It goes out when the engine is running.

Warning!



Never switch off the ESP when you see the ESP warning lamp  flashing in the speedometer dial. In this case, proceed as follows:

- While driving off, apply as little throttle as possible
- While driving, ease up on the accelerator
- Adapt your speed and driving style to the prevailing road conditions

Failure to observe these guidelines could cause the vehicle to skid.

The ESP cannot prevent accidents resulting from excessive speed.

Warning!



The ESP cannot prevent the natural laws of physics from acting on the vehicle, nor can it increase the traction afforded. The ESP cannot prevent accidents, including those resulting from excessive speed in turns, or hydroplaning. Only a safe, attentive, and skillful driver can prevent accidents. The capabilities of an ESP equipped vehicle must never be exploited in a reckless or dangerous manner which could jeopardize the user's safety or the safety of others.



Because of the ESP's automatic operation, the engine must be shut off (key in steering lock position **0** or **1**) when

- the parking brake is being tested on a brake test dynamometer
- the vehicle is being towed with the front axle raised

Active braking action through the ESP may otherwise seriously damage the brake system.

The ESP will only function properly if you use wheels of the recommended tire size (▷ page 269).

For more information, see "Practical hints" (▷ page 199).

Switching off the ESP

Warning!



The ESP should not be switched off during normal driving other than in the circumstances described below. Disabling of the system will reduce vehicle stability in standard driving maneuvers.

To improve the vehicle's traction, turn off the ESP in driving situations where it would be advantageous to have the drive wheels spin and thus cut into surfaces for better grip such as:

- starting out on slippery surfaces and in deep snow in conjunction with snow chains
- sand or gravel

Safety and Security

Driving safety systems

The switch is located on the center console.



- ① ESP off
- ② ESP on

- ▶ Press upper half ① of the ESP switch until the ESP warning lamp  in the speedometer lights up.

The ESP is deactivated.

If one or more drive wheels are spinning, the ESP warning lamp  in the speedometer flashes, regardless of the speed.

Traction control brakes a spinning wheel even when the ESP is deactivated.

The ESP always operates when you are braking, even when it has been deactivated.



Avoid spinning of a drive wheel for an extended period with the ESP switched off. This may cause serious damage to the drivetrain which is not covered by the Mercedes-Benz Limited Warranty.

Warning!



When the ESP warning lamp  is illuminated continuously, the ESP is switched off.

Adapt your speed and driving to the prevailing road conditions and to the non-operating status of the ESP.

Switching on the ESP

- ▶ Press lower half ② of the ESP switch until the ESP warning lamp  in the speedometer goes out.

You are now again in normal driving mode.

▼ Anti-theft systems

Immobilizer

The immobilizer prevents unauthorized persons from starting your vehicle.

Activating

- Removing the key from the steering lock activates the immobilizer.

Deactivating

- Inserting the key in the steering lock deactivates the immobilizer.



In case the engine cannot be started (yet the vehicle's battery is charged), the system is not operational. Contact an authorized Mercedes-Benz Center or call 1-800-FOR-MERCEdes (in the USA), or 1-800-387-0100 (in Canada).

Anti-theft alarm system

Once the alarm system has been armed, a visual and audible alarm is triggered when someone opens

- a door
- the trunk
- the hood

The alarm system will also be triggered when

- someone attempts to raise the vehicle.



If the alarm stays on for more than 20 seconds, an emergency call is initiated automatically by the Tele Aid system provided Tele Aid service was subscribed to and properly activated, and that necessary cellular service and GPS coverage are available.

Arming the alarm system



The alarm system is armed within approximately ten seconds after locking the vehicle. The indicator lamp in the switch for the tow-away alarm (▷ page 72) will then blink.

Disarming the alarm system

The alarm system is disarmed when you unlock your vehicle with the remote control.

Canceling the alarm

To cancel the alarm:

- ▶ Insert the key in the steering lock.
- or
- ▶ Press the  or  button.

The alarm is canceled.

Safety and Security

Anti-theft systems

Tow-away alarm

Once the tow-away alarm is armed, a visual and audible alarm will be triggered when someone attempts to raise the vehicle.



The tow-away protection alarm is triggered, for example, if the vehicle is lifted on one side.

If the alarm stays on for more than 20 seconds, an emergency call is initiated automatically by the Tele Aid system provided Tele Aid service was subscribed to and properly activated, and that necessary cellular service and GPS coverage are available.

Arming tow-away alarm

When you lock your vehicle, the tow-away alarm is automatically armed after about 30 seconds.

When you unlock your vehicle, the tow-away protection disarms automatically.

Disarming tow-away alarm

To prevent triggering the tow-away alarm feature, switch off the tow-away alarm before towing the vehicle, or when parking on a surface subject to movement, such as a ferry or auto train.



- ① Tow-away alarm off switch
- ② Indicator lamp

The switch is located on the center console.

- ▶ Turn off the ignition and remove the key.





You cannot disarm the tow-away alarm while the ignition is turned on.

- ▶ Press upper half ① of the switch.
Indicator lamp ② in the switch lights up briefly.
- ▶ Lock your vehicle with the key or remote control.

The tow-away alarm remains disarmed until you lock your vehicle again.

Canceling tow-away alarm

To cancel the alarm:

- ▶ Insert the key in the steering lock.
- or
- ▶ Press the  or  button.

The alarm is canceled.

Controls in detail

Locking and unlocking

Seats

Lighting

Instrument cluster

Manual transmission

Automatic transmission*

Good visibility

Climate control

Audio system

Power windows

Retractable hardtop

Driving systems

Useful features



Controls in detail

Locking and unlocking

In the “Controls in detail” section you will find detailed information on how to operate the equipment installed in your vehicle. If you are already familiar with the basic functions of your vehicle, this section will be of particular interest to you.

To quickly familiarize yourself with the basic functions of the vehicle, refer to the “Getting started” section of this manual. The corresponding page numbers are given at the beginning of each segment.

▼ Locking and unlocking

Keys

Your vehicle comes supplied with two remote controls with folding key.

The remote control provides an extended operating range. To prevent theft, however, it is advisable to only unlock the vehicle when you are in close proximity to it.



The remote control centrally locks and unlocks:

- the doors
- the trunk
- the fuel filler flap
- the storage compartment in armrest

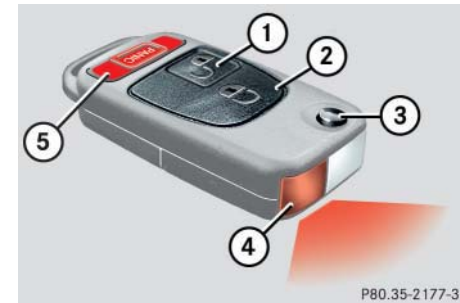
You can lock and unlock each individual lock with the key.



Remote control with folding key

- ①  Unlock button
- ②  Lock button
- ③ Release button for key
- ④ Battery check lamp
- ⑤  PANIC Panic button (▷ page 65)



To prevent possible malfunction, avoid exposing the remote control to high levels of electromagnetic radiation.

Factory setting

Global unlocking

- ▶ Press button .

All turn signal lamps flash once. The locking knobs in the doors move up.

The vehicle will lock again automatically within approximately 40 seconds of unlocking if neither door nor trunk is opened, the key is not inserted in the steering lock, or the central locking switch is not activated.

Global locking

- ▶ Press button .

All turn signal lamps flash three times. The locking knobs in the doors move down.







If the turn signal lamps do not flash three times, one of the following elements may not be properly closed:

- a door
- the trunk

Close the respective element and lock the vehicle again.

Selective setting

If you frequently travel alone, you may wish to reprogram the remote control so that pressing  only unlocks the driver's door, the storage compartment in the armrest and the fuel filler flap.

- ▶ Press and hold buttons  and  simultaneously for about five seconds until battery check lamp  flashes twice.

The remote control will then function as follows:

Unlocking driver's door, storage compartment in armrest and fuel filler flap

Controls in detail

Locking and unlocking

- ▶ Press button  once.



Global unlocking

- ▶ Press button  twice.

Global locking

- ▶ Press button .

Restoring to factory setting

- ▶ Press and hold buttons  and  simultaneously for about six seconds until battery check lamp  flashes twice.

Warning!



When leaving the vehicle, always remove the key from the steering lock and lock the vehicle. Do not leave children unattended in the vehicle, or with access to an unlocked vehicle. It is possible for children to open a locked door from the inside, which could result in an accident and/or serious injury.

Controls in detail

Locking and unlocking



If you can no longer lock or unlock the vehicle with the remote control, then either the batteries in the remote control are discharged, the remote control is malfunctioning, or the vehicle battery is drained.

- Check the batteries in the remote control and replace them if necessary (▷ page 216)
- Synchronize the remote control (▷ page 219)
- Check the vehicle battery (▷ page 251)
- Use the folding key to unlock the doors (▷ page 216) and the trunk (▷ page 216) as required. Lock the vehicle using the folding key (▷ page 217).

If the remote control is malfunctioning, contact an authorized Mercedes-Benz Center.

Checking the batteries

- ▶ Press button or longer than one second.

The battery check lamp ④ comes on briefly to indicate that the key batteries are in order.



If battery check lamp ④ does not light up briefly during the check, then the remote control batteries are discharged.

Replace the batteries (▷ page 218).

You can obtain the required batteries at any authorized Mercedes-Benz Center.



If the batteries are checked within signal range of the vehicle, pressing the or button will lock or unlock the vehicle accordingly.

Loss of remote control with folding key

If you lose a remote control or the folding key, you should do the following:

- ▶ Have the remote control deactivated by an authorized Mercedes-Benz Center.
- ▶ Report the loss of the remote control or the folding key immediately to your car insurance company.
- ▶ If necessary have the mechanical lock replaced.

Your authorized Mercedes-Benz Center will be glad to supply you with a replacement.

Controls in detail

Locking and unlocking

Opening the doors from the inside

You can open a locked door from the inside. Open door only when conditions are safe to do so.

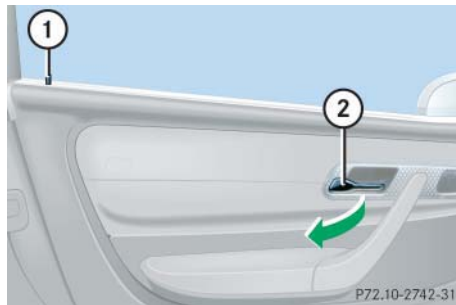

- ① Locking knob
- ② Inside door handle

► Pull on door handle ②.

If a door was locked, the locking knob ① will move up.

Opening the trunk

A minimum height clearance of 5.97 ft (1.82 m) is required to open the trunk lid.

The handle is located above the rear license plate recess.

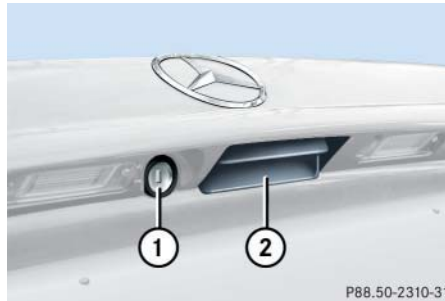

- ① Trunk lid lock
- ② Handle

► Pull on handle ② and lift the trunk lid.



Always make sure there is sufficient overhead clearance.



The vehicle must be unlocked.

The trunk can also be opened from its inside in an emergency, see “Trunk lid emergency release” (► page 78).

Controls in detail

Locking and unlocking

Closing the trunk

The recess is located on the inner side of the trunk lid.



① Recess

- ▶ Lower trunk lid by pulling firmly on recess ①.
- ▶ Close trunk lid with hands placed flat on it.

Warning!



To prevent possible personal injury, always keep hands and fingers away from the trunk opening when closing the trunk. Be especially careful when small children are around.

Warning!



Only drive with the trunk closed as, among other dangers such as visibility blockage, exhaust fumes may enter the vehicle interior.



To prevent an inadvertent lockout, do not place the key in the trunk.

Trunk lid emergency release

The handle for the trunk lid emergency release is located on the inside of the trunk lid.



① Handle



- ▶ Pull handle ① in direction of arrow to open the trunk lid.



The emergency release handle unlocks and opens the trunk while the vehicle is standing or driving.



Opening the trunk from the inside will trigger the anti-theft alarm system. To cancel the alarm, do one of the following:

- Press button  or  on the key.
- Insert the key in the steering lock and turn it to position **2**.

Automatic central locking

The doors and the trunk automatically lock when the ignition is switched on and the left front wheel turns at vehicle speeds of approximately 9 mph (15 km/h) or more.

You can open a locked door from the inside. Open door only when conditions are safe to do so.



The doors unlock automatically after an accident if the force of the impact exceeds a preset threshold.

To prevent the vehicle door locks from locking, deactivate the automatic central locking when the vehicle

- is pushed or towed
- is on a test stand

Controls in detail

Locking and unlocking

Information on towing the vehicle can be found in the “Practical hints” section (▷ page 199).

The switch is located on the upper center console.



Central locking switch

- ① Locking
- ② Unlocking

Controls in detail

Locking and unlocking

Activating

- ▶ Check that the ignition is switched on. All the lamps in the instrument cluster light up.
- ▶ Press and hold upper part ① of the central locking switch for approximately five seconds.

The automatic central locking is activated.

Deactivating

- ▶ Check that the ignition is switched on. All the lamps in the instrument cluster light up.
- ▶ Press and hold lower part ② of the central locking switch for approximately five seconds.

The automatic central locking is deactivated.

Locking and unlocking from the inside

You can lock or unlock the vehicle from inside using the central locking switch. This can be useful, for example, if you want to unlock the passenger door from the inside or want to lock the vehicle before starting to drive.

Warning!



When leaving the vehicle, always remove the key from the steering lock and lock the vehicle. Do not leave children unattended in the vehicle, or with access to an unlocked vehicle. Unsupervised use of vehicle equipment may cause an accident and/or serious personal injury.

Locking

- ▶ Press upper part ① of central locking switch (▷ page 79).

If all the doors are closed, the vehicle locks.

Unlocking

- ▶ Press lower part ② of central locking switch (▷ page 79).

The vehicle unlocks.



You can open a locked door from the inside. Open door only when conditions are safe to do so.

If the vehicle was previously centrally locked using the remote control, it will not unlock using the central locking switch.

▼ Seats

Information on seat adjustment can be found in the “Getting started” section (▷ page 27).

Removing and installing head restraints

Warning!



For your protection, drive only with properly positioned head restraints.

Adjust head restraint so that the head restraint supports the back of the head at eye level. This will reduce the potential for injury to the head and neck in the event of an accident or similar situation.

Do not drive the vehicle without the seat head restraints. Head restraints are intended to help reduce injuries during an accident.



SLK 32 AMG has integrated, non-removable head restraints.

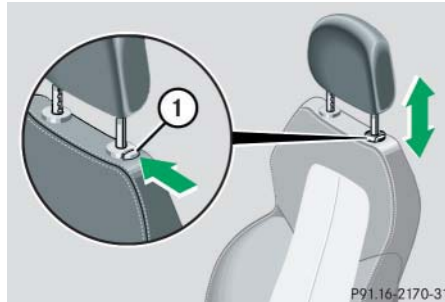

① Release button

Removing head restraint

- ▶ Open the retractable hardtop (▷ page 130).
- ▶ Pull head restraint to its highest position.
- ▶ Push button ① and pull out head restraint.

Controls in detail

Seats

Installing head restraint

Warning!



Be sure to install the head restraint so that it is facing in the right direction. Otherwise you could damage the mounting.

In addition, a head restraint installed in the wrong direction will not provide the intended protection and can cause injury in an accident or similar situation.

- ▶ Insert head restraint and push it down to the stop.
- ▶ Push button ① and adjust head restraint to desired position.

Controls in detail

Seats

Heated seats*

Both switches are located in the center console.



- ① Normal heating
- ② Rapid heating

- ▶ Make sure the ignition is switched on.
All the lights in the instrument cluster come on.

Switching on seat heating

- ▶ Press upper switch position ①.

A red indicator lamp on the switch lights up.

Switching off seat heating

- ▶ Press upper switch position ① again.



The seat heater will be automatically switched off after approximately 30 minutes.

Switching on rapid seat heating

- ▶ Press lower switch position ②.

Both red indicator lamps on the switch light up.



The system switches over to normal heating mode after approximately five minutes. Only one indicator lamp remains lit.

Switching off rapid seat heating

- ▶ Press lower switch position ② again.



If one or both of the indicator lamps on the seat heater switch are blinking, there is insufficient voltage available since too many electrical consumers are turned on. The seat heater switches off automatically.

The seat heater will switch back on again automatically as soon as sufficient voltage is available.



▼ Lighting

For notes on how to switch on the headlamps and use the turn signals, see the “Getting started” section (▷ page 43).

Exterior lamp switch



The exterior lamp switch is located on the dashboard to the left of the steering wheel.



- 0** Off
-  Parking lamps (also side marker lamps, tail lamps, license plate lamps, instrument panel lamps)
Canada only: When engine is running, the low beam is also switched on.
-  Low beam plus parking lamps or high beam headlamps (combination switch pushed forward).

Controls in detail

Lighting

-  Standing lamps, right (turn left one stop)
-  Standing lamps, left (turn left two stops)



If you remove the key and open the driver's door while the parking lamps or low beam headlamps are switched on, a warning sounds.



With the daytime running lamp mode activated and the engine running, the low beam headlamps cannot be switched off manually.

Controls in detail

Lighting

Daytime running lamp mode (Canada only)

Vehicles with automatic transmission

When the engine is running, the low beam headlamps are automatically switched on. In low ambient light conditions the parking lamps will also switch on.

When you shift from a driving position to position **N** or **P**, the low beam switches off (two seconds delay).

Vehicles with manual transmission

With the engine running, the low beam headlamps are automatically switched on.

For nighttime driving you should turn the exterior lamp switch to position  to permit activation of the high beam headlamps.



The high beam flasher is always available.

Switching on front fog lamps

- ▶ Make sure the low beam headlamps are switched on.
- ▶ Pull out exterior lamp switch to first stop.

The green indicator lamp  in the lamp switch lights up.



Fog lamps will operate with the parking lamps and/or low beam headlamps on. Fog lamps should only be used in conjunction with low beam headlamps. Consult your State or Province Motor Vehicle Regulations regarding allowable lamp operation.

Switching on rear fog lamp

- ▶ Make sure the low beam headlamps are switched on.
- ▶ Pull out exterior lamp switch to second stop.

The yellow indicator lamp  in the lamp switch lights up.

Combination switch

The combination switch is located on the left side of the steering column.



- ① High beam
- ② High beam flasher

Switching on high beams

- ▶ Turn exterior lamp switch to position .
- ▶ Push the combination switch in direction ①.

The high beam symbol is illuminated on the instrument cluster.

High beam flasher

- ▶ Pull the combination switch briefly in direction ②.

Controls in detail

Lighting

Hazard warning flasher

The hazard warning flasher can be activated with the ignition switched on or off. It is activated automatically when an airbag is deployed.

The switch is located on the center console.



① Hazard warning flasher switch

Switching on hazard warning flasher

- ▶ Press hazard warning flasher switch ①.

All the turn signals will blink.

Switching off hazard flasher

- ▶ Press hazard warning flasher switch ① again.

Interior lighting

The controls are located in the overhead control panel.

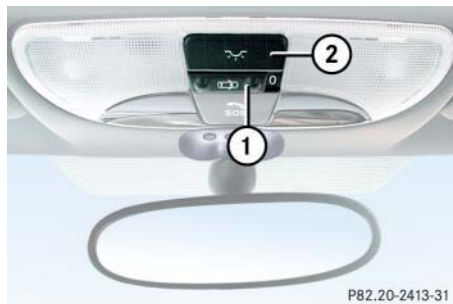

- ① Switch for automatic control
- ② Switch for interior lighting

Activating Automatic control

- ▶ Turn switch ① to the right.

Interior lighting is switched on in darkness, even when you:

- unlock the vehicle
- open a door
- open the trunk lid

The interior lighting switches itself off again after a short pause.



If the door remains open, the interior lamps switch off automatically after approximately five minutes, when the key is removed or in the starter switch position **0**.

An interior lamp switched on manually does not go out automatically.

Deactivating Automatic control

- ▶ Turn switch ① to the left.

The interior lighting remains switched off in darkness, even when you:

- unlock the vehicle
- open a door
- open the trunk lid

Controls in detail

Lighting

Manual control



If the interior lighting is switched on manually, it will not go out automatically. This could cause the battery to become discharged.

Activating and deactivating

- ▶ Press switch ②.

The interior lighting is switched on.

- ▶ Press switch ② again.

The interior lighting is switched off.



The trunk lighting is switched on and off simultaneously with the interior lighting.

Night security illumination

If you exit the vehicle after driving with the exterior lighting on, it switches on again for added security for approximately 30 seconds after closing the last door.

▼ Instrument cluster

A full view illustration of the instrument cluster can be found in the “At a glance” section of this manual (▷ page 20).

The instrument cluster is activated when you

- open the driver’s door
- turn the key in steering lock to position **2** (▷ page 29)
- press left knob ③ (▷ page 20)

Instrument cluster illumination

Instrument lamps

To brighten illumination

- ▶ Turn knob ③ (▷ page 20) clockwise.
The instrument lamps will brighten.

To dim illumination

- ▶ Turn knob ③ counterclockwise.
The instrument lamps will dim.

Display illumination

- ▶ Press knob ③.

With key removed or in steering lock position **0** or **1** (▷ page 29), the display is illuminated for a short time.

Coolant temperature gauge

Under normal driving conditions, the coolant temperature may rise to 248°F (120°C). The coolant temperature may climb to the red marking:

- at high outside temperatures
- during stop-and-go traffic
- when driving on hilly terrain

The engine should not be operated with the coolant temperature in the red zone. Doing so may cause serious engine damage which is not covered by the Mercedes-Benz Limited Warranty.

Controls in detail

Instrument cluster

Warning!



Driving when your engine is badly overheated can cause some fluids which may have leaked into the engine compartment to catch fire. You could be seriously burned.

Steam from an overheated engine can cause serious burns and can occur just by opening the engine hood. Stay away from the engine if you see or hear steam coming from it.

Turn off the engine, get out of the vehicle and do not stand near the vehicle until the engine has cooled down.

Trip odometer

- ▶ Press left knob ③ (▷ page 20) once with key in steering lock position **2** (▷ page 29) until the trip odometer is reset
- or
- ▶ Press left knob ③ (▷ page 20) twice with key removed or in steering lock position **0** or **1** (▷ page 29) until the trip odometer is reset.

Tachometer

The red marking on the tachometer (▷ page 20) denotes excessive engine speed.



Avoid driving at excessive engine speeds, as it may result in serious engine damage that is not covered by the Mercedes-Benz Limited Warranty.

To help protect the engine, the fuel supply is interrupted if the engine is operated within the red marking.

Outside temperature indicator

Warning!

The outside temperature indicator is not designed to serve as an ice-warning device and is therefore unsuitable for that purpose.

Indicated temperatures just above the freezing point do not guarantee that the road surface is free of ice. The road may still be icy, especially in wooded areas or on bridges.

When moving the vehicle into colder ambient temperatures (e.g. when leaving your garage), you will notice a delay before the lower temperature is displayed.

A delay also occurs when ambient temperatures rise. This prevents inaccurate temperature indications caused by heat radiated from the engine during idling or slow driving.

Setting clock

Hour

- ▶ Pull out right knob ⑤ in the instrument cluster (▷ page 20) and turn it counter-clockwise.

Minutes

- ▶ Pull out right knob ⑤ in the instrument cluster and turn it clockwise.



To adjust the time by a single hour or a few minutes, turn knob ⑤ just a few degrees in the direction indicated for hours or minutes.

Controls in detail

Manual transmission

▼ Manual transmission

Information on driving with a manual transmission is found in the “Getting started” section (▷ page 40).

Do not exceed the maximum speed in the individual gears. Refer to tachometer (▷ page 90) for engine speeds.

Warning!



For vehicles equipped with a manual transmission, getting out of your vehicle with the gearshift lever not engaged in first or reverse gear and parking brake engaged is dangerous. Also, when parked on an incline, an engaged first or reverse gear alone may not prevent your vehicle from moving, possibly hitting people or objects.

Always set the parking brake in addition to engaging first or reverse gear (▷ page 47).

When parked on an incline, turn front wheels towards the road curb.

Do not park this vehicle in areas where combustible materials such as grass, hay or leaves can come into contact with the hot exhaust system, as these materials could be ignited and cause a vehicle fire.

Warning!



When leaving the vehicle, always remove the key from the steering lock, and lock the vehicle. Do not leave children unattended in the vehicle, or with access to an unlocked vehicle. Children could move the gearshift lever, which could result in an accident and/or serious injury.

On slippery road surfaces as well as high engine speeds, never downshift in order to obtain braking action. This could result in drive wheel slip and reduced vehicle control. Your vehicle's ABS will not prevent this type of loss of control.



Downshifting gears leading to overrevving the engine can result in engine damage that is not covered by the Mercedes-Benz Limited Warranty.

Never hold the vehicle stopped on a hill by using the clutch pedal. The clutch may be damaged which is not covered by the Mercedes-Benz Limited Warranty.

Do not exceed the engine speed limits (▷ page 90).

Shifting into reverse

- ▶ Stop the vehicle completely.
- ▶ Pull gearshift lever up and shift in **R** reverse.

▼ Automatic transmission*

Information on driving with an automatic transmission is found in the “Getting started” section (▷ page 27).

Your vehicle’s transmission adapts its gear shifting process to your individual driving style by continually adjusting the shift points up or down. These shift point adjustments are performed based on current operating and driving conditions.

If the operating conditions change, the automatic transmission reacts by adjusting its gear shift program.



During the brief warm-up, transmission upshifting is delayed. This allows the catalytic converter to heat up more quickly to operating temperature.

The automatic transmission selects individual gears automatically, depending on:

- the gear selector lever position **D** with gear ranges **4, 3, 2, 1** (▷ page 95)
- the selected shift program (**W/S**) (▷ page 97)
- the position of the accelerator pedal (▷ page 98)
- the vehicle speed

The current gear selector lever position appears in the tachometer display see “Getting started” (▷ page 27).

Controls in detail

Automatic transmission*

Warning!



It is dangerous to shift the gear selector lever out of **P** or **N** if the engine speed is higher than idle speed. If your foot is not firmly on the brake pedal, the vehicle could accelerate quickly forward or reverse. You could lose control of the vehicle and hit someone or something. Only shift into gear when the engine is idling normally and when your right foot is firmly on the brake pedal.

When the gear selector lever is in position **D**, you can influence transmission shifting by:

- limiting the gear range
- changing gears manually

Controls in detail

Automatic transmission*

One-touch gearshifting

Even with an automatic transmission you can change the gears manually when the gear selector lever is in position **D**.

Downshifting

- ▶ Briefly press the gear selector lever to the left in the **D-** direction.

The transmission will shift from the current gear to the next lower gear. This action simultaneously limits the gear range of the transmission (▷ page 95).

Warning!



On slippery road surfaces, never downshift in order to obtain braking action. This could result in drive wheel slip and reduced vehicle control. Your vehicle's ABS will not prevent this type of loss of control.



To avoid overrevving the engine when the gear selector lever is moved to the **D-** direction, the transmission will not shift to a lower gear if the engine's max. speed would be exceeded.

Upshifting

- ▶ Briefly press the gear selector lever to the right in the **D+** direction.

The transmission will shift from the current gear to the next higher gear as permitted by the shift program. This action simultaneously extends the gear range of the transmission.

Canceling gear range limit

- ▶ Press and hold the gear selector lever in the **D+** direction until **D** reappears in the tachometer display.

The transmission will shift from the current gear range directly to gear range **D**.

Shifting into optimal gear range

- ▶ Press and hold the gear selector lever in the **D-** direction.

The transmission will automatically select the gear range suited for optimal acceleration and deceleration. This will involve shifting down one or more gears.

Controls in detail

Automatic transmission*

Gear ranges

With the gear selector lever in position **D**, you can limit the transmission's gear range by pressing the gear selector lever to the left (**D-**), and reverse the gear range limit by pressing the gear selector lever to the right (**D+**).

The selected gear range appears in the tachometer display. If you press on the accelerator when the engine has reached its rpm limit, the transmission will upshift beyond any gear range limit selected.

	Effect
4	The transmission shifts through fourth gear only.
3	The transmission shifts through third gear only. With this selection you can use the braking effect of the engine.

	Effect
2	The transmission shifts through second gear only. Allows the use of engine's braking power when driving: <ul style="list-style-type: none">• on steep downgrades• in mountainous regions• under extreme operating conditions
1	The transmission operates in first gear only. For maximum use of engine's braking effect on very steep or lengthy downgrades.

Gear selector lever position

	Effect
P	Park position Gear selector lever position when the vehicle is parked. Place gear selector lever in position P only when vehicle is stopped. The park position is not intended to serve as a brake when the vehicle is parked. Rather, the driver should always set the parking brake in addition to placing the gear selector lever in position P to secure the vehicle.

Controls in detail

Automatic transmission*

	Effect
	<p>The key can only be removed from the steering lock with the gear selector lever in position P. With the key removed, the gear selector lever is locked in position P.</p> <p>If the vehicle's electrical system is malfunctioning, the gear selector lever could remain locked in position P.</p>
R	Reverse gear <p>Place gear selector lever in position R only when vehicle is stopped.</p>

	Effect
N	Neutral <p>No power is transmitted from the engine to the drive axle. When the brakes are released, the vehicle can be moved freely (pushed or towed).</p> <p>To avoid damage to the transmission, never engage N while driving.</p> <p>If the ESP is deactivated or malfunctioning: Move gear selector lever to N only if the vehicle is in danger of skidding, e.g. on icy roads.</p>
D	Drive <p>The transmission shifts automatically. All five forward gears are available.</p>



Coasting the vehicle, or driving for any other reason with gear selector lever in **N** can result in transmission damage that is not covered by the Mercedes-Benz Limited Warranty.

Warning!



Getting out of your vehicle with the gear selector lever not fully engaged in position **P** is dangerous. Also, position **P** alone is not intended to or capable of preventing your vehicle from moving, possibly hitting people or objects.

Always set the parking brake in addition to shifting to position **P** (▷ page 42).

When parked on an incline, turn the front wheels towards the road curb.

Do not park this vehicle in areas where combustible materials such as grass, hay or leaves can come into contact with the hot exhaust system, as these materials could be ignited and cause a vehicle fire.

Warning!



When leaving the vehicle, always remove the key from the steering lock, take it with you and lock the vehicle. Do not leave children unattended in the vehicle, or with access to an unlocked vehicle. Children could move the gear selector lever from position **P**, which could result in an accident and/or serious personal injury.

Program mode selector switch

The program mode selector switch is located on the lower part of the center console.

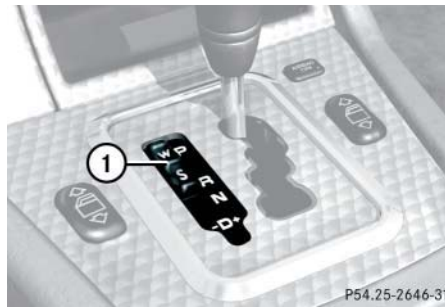

① Program mode selector switch

S Standard For regular driving

W Winter For winter driving



Never change the program mode when the gear selector lever is out of position **P**. This could result in a change of driving characteristics for which you may not be prepared.

Controls in detail

Automatic transmission*

► Press program mode selector switch ①.

Select **W** for winter driving:

- The vehicle starts out in second gear (both forward and reverse) for gentler starts. This does not apply if full throttle is applied or gear range **1** is selected.
- Traction and driving stability are improved on icy roads.
- Upshifts occur earlier even when you give more gas. The engine then operates at lower rpms and the wheels are less likely to spin.
- The power transmission ratio for gear selector lever position **R** changes depending on the program mode selected (**S** or **W**).

Controls in detail

Automatic transmission*

Accelerator position

Your driving style influences the transmission's shifting behavior:

Less throttle	Earlier upshifting
More throttle	Later upshifting

Kickdown

Use kickdown when you want maximum acceleration.

- ▶ Press the accelerator past the point of resistance.
The transmission shifts into a lower gear.
- ▶ Ease on the accelerator when you have reached the desired speed.
The transmission shifts up again.

Emergency operation (Limp Home Mode)

If vehicle acceleration worsens or the transmission no longer shifts, the transmission is most likely operating in limp home (emergency operation) mode. In this mode only second gear and reverse gear can be activated.

- ▶ Stop the vehicle.
- ▶ Move gear selector lever to **P**.
- ▶ Turn off the engine.
- ▶ Wait at least ten seconds before restarting.
- ▶ Restart the engine.
- ▶ Move gear selector lever to position **D** (for second gear) or **R**.
- ▶ Have the transmission checked at an authorized Mercedes-Benz Center as soon as possible.

▼ Good visibility

Information on the windshield wipers (▷ page 44) and for adjusting the rear view mirrors see "Adjusting" (▷ page 30) is found in the "Getting started" section.

Headlamp cleaning system*

The switch is located on the center console.



① Headlamp washer switch

- ▶ Switch on ignition.
- ▶ Briefly press upper part of switch ①.

The headlamps will be cleaned with a high-pressure water jet.

For information on filling up the washer reservoir, see "Windshield washer system and headlamp cleaning system*" (▷ page 184).

Controls in detail

Good visibility

Rear view mirror

Automatic antiglare rear view mirror

The reflection brightness of the exterior rear view mirror on the driver's side and the interior rear view mirror will respond automatically to glare when

- the ignition is switched on and
- incoming light from headlamps falls on the sensor in the interior rear view mirror

The rear view mirror will not react if

- reverse gear is engaged
- the interior lighting is turned on
- the wind screen is installed (▷ page 135)

Controls in detail

Good visibility

Warning!



The automatic antiglare function does not react if incoming light is not aimed directly at sensors in the interior rear view mirror.

The interior rear view mirror and the exterior rear view mirror on the driver's side do not react, for example, if the wind screen is installed.

Glare can endanger you and others.

Warning!



In the case of an accident, liquid electrolyte may escape from the mirror housing if the mirror glass breaks.

Electrolyte has an irritating effect. Do not allow the liquid to come into contact with eyes, skin, clothing, or the respiratory system. In case it does, immediately flush affected area with water, and seek medical help if necessary.

Warning!



Exercise care when using the passenger side exterior rear view mirror. The mirror surface is convex (outwardly curved surface for a wider field of view). Objects in mirror are closer than they appear. Check your interior rear view mirror or glance over your shoulder before changing lanes.



Electrolyte drops coming into contact with the vehicle paint finish can be completely removed only while in the liquid state by applying plenty of water.

Sun visors

The sun visors protect you from sun glare while driving.

Warning!



Do not use the vanity mirror while driving.

Keep the mirrors in the sun visors closed while vehicle is in motion. Reflected glare can endanger you and others.



- ① Mirror cover
- ▶ Swing sun visors down when you experience glare.
- ▶ Push mirror cover ① to the side, as required.

Rear window defroster

The rear window defroster uses a large amount of power. To keep the battery drain to a minimum, switch off the defroster as soon as the rear window is clear. The defroster is automatically deactivated after a maximum of 12 minutes.

Activating

- ▶ Switch on the ignition.
- ▶ Press button  (▷ page 102).
The indicator lamp on the button lights up.

Deactivating

- ▶ Press button  (▷ page 102) again.
The indicator lamp on the button goes out.

Controls in detail

Good visibility

Warning!



Any accumulation of snow and ice should be removed from the rear window before driving. Visibility could otherwise be impaired, endangering you and others.



If the rear window defroster switches off too soon and the indicator lamp starts blinking, this means that too many electrical consumers are operating simultaneously and there is insufficient voltage in the battery. The system responds automatically by deactivating the rear window defroster.

As soon as the battery has sufficient voltage, the rear window defroster automatically turns itself back on.

	Item
①	Windshield defroster vent
②	Side window defroster vent, adjustable
③	Thumbwheel for air volume control for side air vent
④	Side air vent, adjustable
⑤	Temperature controls for left and right side passenger compartment
⑥	Air distribution control
⑦	Air recirculation/residual heat
⑧	AC cooling on/off (AC^{OFF})
⑨	Air volume control
⑩	Rear window defroster
⑪	Center air vents, adjustable
⑫	Thumbwheel for air volume control for center air vents



For draft-free ventilation, move the sliders for the center air vents ⑪ to the middle position.

The climate control is operational whenever the engine is running. The system cools or heats the interior depending on the selected interior temperature and the current outside temperature.

Nearly all dust particles, pollutants and odors are filtered out before outside air enters the passenger compartment through the air distribution system.

The air conditioning will not engage (no cooling) if the **AC^{OFF}** mode is selected.

Controls in detail

Climate control

Warning



When operating the climate control, the air that enters the passenger compartment through the air vents in the footwell can be very hot or very cold (depending on the set temperature). This may cause burn or frostbite to unprotected skin in the immediate area of the air vents. Always keep sufficient distance between unprotected parts of the body and the footwell air vents. If necessary change the air flow using the air distribution controls to direct the air away from the footwell air vents.

Warning!



Follow the recommended settings for heating and cooling given on the following pages. Otherwise the windows could fog up, impairing visibility and endangering you and others.

Controls in detail

Climate control



The selected temperature is reached as quickly as possible.

Severe conditions (e.g. strong air pollution) may require replacement of the filter before its scheduled interval. A clogged filter will reduce the air volume to the interior.

If the vehicle interior is hot, ventilate the interior before driving off.

Keep the air intake grille in front of the windshield free of snow and debris.

Setting the temperature

Use temperature controls ⑤ (▷ page 103) to separately adjust the air temperature on each side of the passenger compartment. You should raise or lower the temperature setting in small increments, preferably starting at 72°F (22°C).



If you use the standard settings for heating or cooling the passenger compartment (▷ page 102), you will rarely need to change the temperature, air volume or air distribution.

Increasing

- ▶ Turn the temperature control ⑤ slightly upwards.

A red marking will be visible and the climate control system will correspondingly adjust the interior air temperature.

Controls in detail

Climate control

Decreasing

- ▶ Turn the temperature control ⑤ slightly downwards.

A blue marking will be visible and the climate control system will correspondingly adjust the interior air temperature.





Adjusting air volume

Use air volume control ⑨ (▷ page 103) to adjust the air volume. The following symbols are found on the control:

Symbol	Function
0	No ventilation
between 0 and 	Ventilation without a blower, depending on the speed driven
between 1 and 5	Ventilation with blower

Adjusting air distribution

Use air distribution control ⑥ (▷ page 103) to adjust the air distribution. The following symbols are found on the control:

Symbol	Function
 	Directs air to the windows
	Directs air into the passenger compartment
	Directs air to the footwells
	Directs air through the center, side and rear passenger compartment air vents

Controls in detail

Climate control

Air recirculation mode

Switch to air recirculation mode to prevent unpleasant odors from entering the vehicle from the outside. This setting cuts off the intake of outside air and recirculates the air in the passenger compartment.

Warning!



When the outside temperature is below 41°F (5°C), only switch to air recirculation mode for short periods to prevent window fogging.

Activating

- ▶ Press button  (▷ page 102).

The indicator lamp on the  button comes on.



The air recirculation mode is activated automatically at high outside temperatures.

Deactivating

- ▶ Press button  (▷ page 102).

The indicator lamp on the  button goes out.

The air recirculation mode is deactivated automatically:

- after five minutes if the outside temperature is below approximately 41°F (5°C)
- after five minutes if the air conditioning is turned off
- after 30 minutes if the outside temperature is above approximately 41°F (5°C)

At outside temperatures above 79°F (26°C), the system will not automatically switch back to outside air. A quantity of outside air is added after approximately 30 minutes.

Air conditioning

The air conditioning is operational while the engine is running and cools the interior air to the temperature set by the operator.



Condensation may drip out from underneath the vehicle. This is normal and not an indication of a malfunction.



Deactivating

It is possible to deactivate the air conditioning (cooling) function of the climate control system. The air in the vehicle will then no longer be cooled or dehumidified.

Warning!





While driving, deactivate the air conditioning only temporarily to prevent window fogging.

- ▶ Press button  (▷ page 102).
The indicator lamp on the button  lights up.

Activating

Moist air can fog up the windows. You can dehumidify the air with the air conditioning.

- ▶ Press button  again (▷ page 102).
The indicator lamp on the  button goes out.

The air conditioning uses the refrigerant R134a. This refrigerant is free of CFCs which are harmful to the ozone layer.



Controls in detail

Climate control

Residual heat

With the engine switched off, it is possible to continue to heat or ventilate the interior for up to 30 minutes. This feature makes use of the residual heat produced by the engine.

Activating

- ▶ Turn the key in the steering lock to position **1** or **0**, or remove it from the starter switch.
- ▶ Press button  (▷ page 102).
The indicator lamp on the button  comes on.

Controls in detail

Climate control

Deactivating

- ▶ Press button  (▷ page 102).

The indicator lamp on the button  goes out.

The residual heat is automatically turned off:

- when the ignition is switched on
- after about 30 minutes
- if the battery voltage drops



How long the system will provide heating depends on the coolant temperature and the temperature set by the operator. The blower will run at speed setting **1** regardless of the air volume control setting.

Basic settings

Heater



- ▶ Select temperature for each side of the passenger compartment with temperature controls ①.
- ▶ Select air volume with air volume control ②, set at least to position **2** to prevent window fogging.

- ▶ Set air distribution control ③ to position shown above.
- ▶ Turn side window defroster vents (▷ page 103) to the detent position.
- ▶ Open center air vents (▷ page 103) as desired.

Controls in detail

Climate control

Air conditioning



- ▶ Select temperature for each side of the passenger compartment with temperature controls ①.
- ▶ Select air volume with air volume control ②, set at least to position 1 to start the air conditioning.
- ▶ Set air distribution control ③ to position .
- ▶ Open center air vents (▷ page 103).
- ▶ Open left and right side air vents.

Special settings



Use special settings only for a short duration.

Defrosting



- ▶ Set temperature controls ①, air volume control ② and air distribution control ③ to position .
- ▶ Close center air vents (▷ page 103).
- ▶ Open left and right side air vents (▷ page 103).
- ▶ Turn side window defroster vents (▷ page 103) to the detent position.



Controls in detail

Climate control

Defogging windows



Windows fogged up on inside



- ▶ Press button **AC^{OFF}** to switch on the air conditioning.
The indicator lamp on button **AC^{OFF}** goes out.
- ▶ Press button  to switch off the air recirculation.
The indicator lamp on button  goes out.

- ▶ Increase air volume with air volume control ②.
- ▶ Set air distribution control ③ to position .
- ▶ Close center air vents.
- ▶ Close left and right side air vents.
- ▶ Turn side window defroster vents to the detent position.

Windshield fogged up on outside

- ▶ Switch on the windshield wipers (▷ page 44).
- ▶ Set air distribution control ③ to position  or .

Deactivating the climate control system

Deactivating

- ▶ Set air volume control ② to position **0**.
The fresh air supply to the passenger compartment is shut off.

Reactivating

- ▶ Set air volume control ② to any speed.
The fresh air supply to the passenger compartment is switched on.

Warning!



While driving, deactivate the climate control only temporarily to prevent window fogging.

▼ Audio system

Audio and telephone, operation

These instructions are intended to help you become acquainted with your Mercedes-Benz car radio. They contain useful tips and a detailed description of the user functions.

Warning!



In order to avoid distraction which could lead to an accident, the driver should enter system settings with the vehicle at a standstill and operate the systems only when road and traffic conditions permit. Always pay full attention to traffic conditions first before operating system controls while driving.

Bear in mind that at a speed of just 30 mph (approximately 50 km/h), your car is covering a distance of approximately 50 feet (approximately 14 m) every second.

Controls in detail

Audio system

Operating safety

Warning!



Any alterations made to electronic components can cause malfunctions.

The radio, cassette deck, CD changer*, telephone* and voice control system* are interconnected. When one of the components is not operational or has not been removed / replaced properly, the function of other components may be impaired.

This conditions might seriously impair the operating safety of your vehicle.

We recommend that you have any service work on electronic components carried out by an authorized Mercedes-Benz Center.

Controls in detail

Audio system

Operating and display elements

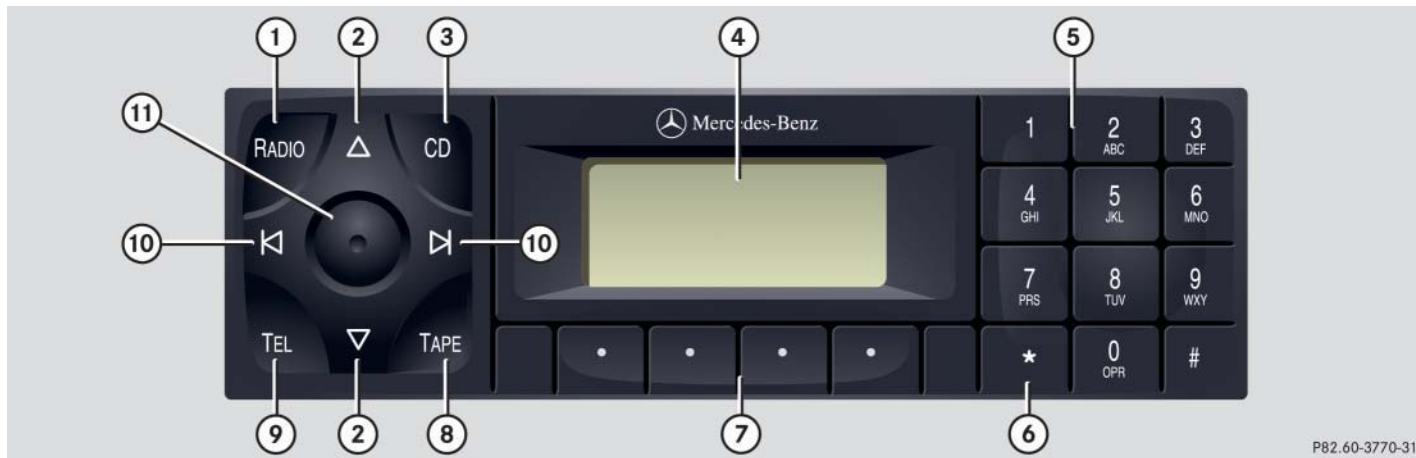

Controls in detail

Audio system

	Item	Page
①	Radio mode selector	116
②	Tuning	116
	Fast forward / reverse	120, 124
③	CD mode selector*	123
④	Display panel	118
⑤	Alpha-numeric keypad for station storage and frequency entry	117
	CD/Track access	123, 125
	Telephone*	125

	Item	Page
⑥	Function button	117, 125
⑦	Soft keys for radio band selection	115
	Tone controls	115
	Scan tuning	117
	Cassette eject	119
	Cassette track select	119
	Dolby	120
	CD random/repeat	124

	Item	Page
⑧	Tape mode selector	118
⑨	Telephone mode selector	125
⑩	Seek tuning	117, 119, 124
⑪	On/off, volume	115

Controls in detail

Audio system

Anti-theft system

CODE

If the power supply to the radio has been interrupted, **CODE** will appear on the display when it is next switched on. The radio will only work after the five-digit code has been entered using the buttons on the right-hand control panel.



The code number is shown on the Radio Code Card, supplied with the radio.



Never leave the Radio Code Card in the vehicle. Keep it in a safe place.

Entering the code number

- ▶ Switch on the radio.
CODE will appear on the display.
- ▶ Using the buttons on the alpha-numeric keypad, enter the five digit code.
- ▶ Confirm by pressing the OK key.

If an incorrect code has been entered and confirmed, **CODE** will reappear on the display. The correct code must be entered once again.

WAIT

If an incorrect code is entered three times, **WAIT** will appear on the display and the radio will be locked out for about ten minutes.



The lock out time will only count down if the radio is left switched on.

Button and soft key operation

In these instructions, the alpha-numeric keypad (right side of radio face) and the function buttons (left side of radio face) are referred to as “buttons” and the four keys under the display are referred to as “soft keys”.



Do not press directly on the radio display face.

Operation

Switching on and off

- ▶ Press control knob .

The radio is switched off when you turn the key in the steering lock to position **0** or remove it from the steering lock. The radio is switched on again when you turn the key in the steering lock to position **1** or **2**.



The radio can also be switched on even if the key is not inserted in the steering lock, but will switch itself off automatically after one hour to conserve vehicle battery power.

Adjusting the volume

- ▶ Turn the control knob.

Turning the knob clockwise will increase the volume, counterclockwise will decrease the volume.

Audio functions

The AUD key is used to select the BASS, TREBLE and BALANCE functions. Settings for bass and treble are stored separately for the cassette and CD modes. Tone level settings are identified by the vertical bars. The center (flat) setting is shown by one longer bar in the center of the display.

Controls in detail

Audio system

Bass



FM1 BASS
.....|.....
<- AUD +>

- ▶ Press the AUD key repeatedly until BASS appears in the display.

Treble



FM1 TREBLE
.....|.....
<- AUD +>

- ▶ Press the AUD key repeatedly until TREBLE appears in the display.
- ▶ Press the + key to increase or the - key to decrease the level.

Controls in detail

Audio system

Balance

```
BALANCE
.....|.....
<L   AUD R>
```

- ▶ Press the **AUD** key repeatedly until **BALANCE** appears in the display.
- ▶ Press the **L** key to move the sound to the left speaker or the **R** key to move the sound to the right speaker.

Centering all audio functions

```
RESET
```

- ▶ Push and hold down the **AUD** key.
All audio functions (bass, treble and balance) are set to center or flat positions, and the volume is adjusted to a pre-set level.

Radio mode

Selecting radio mode

- ▶ Press **RADIO** button.

Analog station frequencies

Selecting the band

```
FMS ST
 95.5 MHz
AM WB AUD SC
```

- ▶ Press the key located below the desired band.

The band selected is shown in the top line of the display.

```
AM4
 880 kHz
FM WB AUD SC
```



FM frequency band:
FM 87.7.....107.9 MHz
AM frequency band:
MW (medium wave) 530.....1710 KHz

Manual tuning

```
WB1
CH 1
FM AM AUD SC
```



- ▶ Press either the **▲** or **▼** button.
Step-by-step tuning in ascending or descending order of frequency will take place.

The first three tuning steps will take place without muting. The radio will then be muted and high-speed tuning will take place until the button is released.

Controls in detail

Audio system

Seek tuning





- ▶ Press either the  or  button. The radio will tune to the next receivable station.

Scan tuning

```
FM
 95.5 MHz
AM WB AUD SC
```

- ▶ Press the SC key.

Each station with a strong signal on the band selected will be tuned in for eight seconds. The first scan will tune only the stations with a high signal strength. The second scan will tune every receivable station.

By pressing either the , ,  or  buttons, or the SC key, the scan mode can be cancelled.

Station memory

```
FM ST
 95.5 MHz
AM WB AUD
```

Ten stations can be stored in the AM and FM bands via the alpha-numeric keypad. The "0" button corresponds to location 10. Weatherband (WB) channels 1 to 7 can be retrieved via the alpha-numeric keypad and are preset at the factory.

Storing stations

- ▶ Hold the number button down for approximately two seconds.

The currently displayed frequency is stored on the selected station button. The storage procedure is confirmed by a short signal tone.

Retrieving a station from memory

- ▶ Press the desired station button.

Direct frequency input (AM and FM only)

```
FM ST
--*-- MHz
AM WB AUD SC
```

- ▶ Select the band.
- ▶ Press the  button and enter the desired frequency using the alpha-numeric keypad.

Frequencies outside of the frequency ranges (frequencies specified on [▷ page 116](#)) will not be accepted. The frequency input mode is cancelled if no button is pressed within four seconds.

Controls in detail

Audio system

Cassette mode

Playing cassettes

- ▶ Press the “TAPE” button.
- ▶ Press the eject (EJ) key.

The display folds down and the cassette slot becomes visible.

- ▶ Push the cassette into the slot until it engages.

The cassette will be pulled in automatically.



Do not press directly on the radio display face.

Return the display panel to its normal position by folding it back up and pressing gently on the display frame to lock in place.

When playing mono recorded tapes (e.g. books) through a stereo system, the sound from one track might bleed to the other track, despite setting the balance to the full left or full right speakers.



If the display is in the down position for more than 20 seconds, two successive beeps will be heard. This will continue at 5 second intervals until the display is returned to its normal position.

```
TAPE NR  
SIDE 1  
TRK EJ AUD SC
```

The radio will switch to cassette mode. Track 1 will be played and *SIDE 1* displayed. Track 1 is the side of the cassette which is facing upwards. The cassette deck will automatically detect the type of tape and switch the equalization automatically. A cassette symbol in the display indi-

cates that a tape is in the mechanism. This symbol appears in all modes but not in cassette mode.

The cassette will not be ejected when the radio is switched off or another mode is selected.

```
NR  
NO TAPE  
EJ
```

If a cassette is in the mechanism, cassette mode can be selected by using the “TAPE” button. If no cassette has been inserted, the display will show *NO TAPE*.

Cassette eject

- ▶ Press the eject (EJ) key.
The display will fold down and the cassette will be ejected.
- ▶ Remove the cassette.
- ▶ Fold the display back up manually.
The radio will switch back to radio mode automatically.



The cassette will not be ejected when the radio is switched off.



If the display is in the down position for more than 20 seconds, two successive beeps will be heard. This will continue at 5 second intervals until the display is returned to its normal position.

Track selection

```
TAPE NR  
SIDE 1  
TRK EJ AUD SC
```

- ▶ Press the track selection (TRK) key.
The current track will be displayed as SIDE 1 or SIDE 2. The track will be changed automatically at the end of the tape.

Track search forwards/backwards

```
TAPE NR  
SEEK FWD  
TRK EJ AUD SC
```

- ▶ Press the button.
SEEK FWD will be shown on the display and the track search will run the tape forwards to the start of the next track.

Controls in detail

Audio system

```
TAPE NR  
SEEK RWD  
TRK EJ AUD SC
```

- ▶ Press the button.
SEEK RWD will be shown on the display and the track search will run the tape backwards to the start of the track currently playing.
- ▶ Press the same button again to interrupt track search.



The beginning of a track can only be located if there is a break of at least four seconds between tracks.

Controls in detail

Audio system

Fast forward/reverse

```
TAPE NR  
FORWARD  
TRK EJ AUD SC
```

- ▶ Press the  button.

FORWARD will appear on the display and fast forward will start.

```
TAPE NR  
REWIND  
TRK EJ AUD SC
```

- ▶ Press the  button.

REWIND will appear on the display and fast reverse will start.

- ▶ Press the same button again to stop fast forward/reverse, or it will stop automatically at the beginning or the end of the tape. The track will automatically change at the end or beginning of the tape and play will begin.

Scanning





```
TAPE NR  
SCAN FWD  
TRK EJ AUD SC
```

- ▶ Press the SC key.

Each track on the cassette will be played for eight seconds in ascending order.



The beginning of a track can only be located if there is a break of at least four seconds between tracks.

Scan will be interrupted if the , , ,  buttons or the SC key is pressed.

Dolby NR¹ (noise reduction system)

```
TAPE BASS  
.....|.....  
<- NR AUD +>
```

To enable optimum reproduction of cassettes recorded using the Dolby B system, press the AUD key followed by the NR key. NR is shown in the display in inversed-color format. To turn off Dolby B noise reduction, press the NR key again. The NR in the display will be shown in the original color format.

¹ Dolby and the double-D symbol  are trademarks of Dolby Laboratories Licensing Corporation. The Dolby noise reduction system is manufactured under license from Dolby Laboratories Licensing Corporation.

CD mode

General notes on CD mode

Should excessively high temperatures occur while the audio system is in CD mode, TEMP HIGH will appear in the display and muting will take place. The unit will then switch back to radio mode until the temperature has decreased to a safe operating level.

Should excessively low temperatures occur while the audio system is in CD mode, TEMP LOW will be displayed, but the CD will still be played. It will be sensitive to skipping if you are driving over rough roads.

Handle CDs carefully to prevent interference during playback.

Avoid fingerprints and dust on CDs. Do not write on the CDs or apply any label to the CDs.

Clean CDs from time to time with a commercially available cleaning cloth. No solvents, anti-static sprays, etc. should be used.

Replace the CD in its container after use. Protect CDs from heat and direct sunlight.



Only use CDs which bear the label shown and that conform to the compact disc digital audio standard (IEC 60908). You can therefore only use CDs with a maximum thickness of 1.3 mm.



Your CD drive has been designed to play CDs which correspond to the EN 60908 standard. If you insert thicker data carriers, e.g. ones that have data on both sides (one side with DVD data, the other side with audio data), they cannot be ejected and will damage the drive.

Use of CDs which do not meet this standard may cause damage to the CD changer. Do not play single-CDs (80 mm) with an adapter.

Controls in detail

Audio system

Warning!



The CD changer* is a Class 1 laser product. There is a danger of invisible laser radiation if the cover is opened or damaged.

Do not remove the cover. The CD changer* does not contain any parts which can be serviced by the user. For safety reasons, have any service work which may be necessary performed only by qualified personnel.

Controls in detail

Audio system

Installing and removing the CD changer*

The CD changer is located in the trunk on the right side.

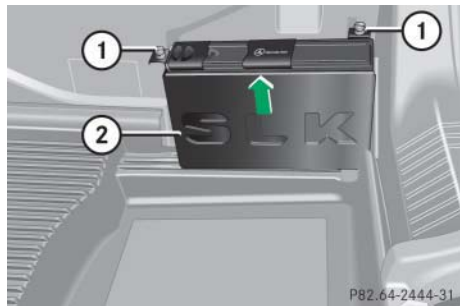

- ① Fastener
- ② CD changer (with protective cover)

Removing



If your CD changer holder does not have the fasteners ① as shown in above illustration, your vehicle may be equipped with a non-factory installed CD changer holder. The CD changer holder then does not need to be removed as there should be enough room between the CD changer holder and the right side trim panel in the trunk to remove the cover and gain access to the screw for hydraulic pump (▷ page 221) should you need to raise the retractable hardtop manually.

- ▶ Release fasteners ① by turning them counterclockwise with a screwdriver.
- ▶ Carefully lift CD changer up and place it to the side.

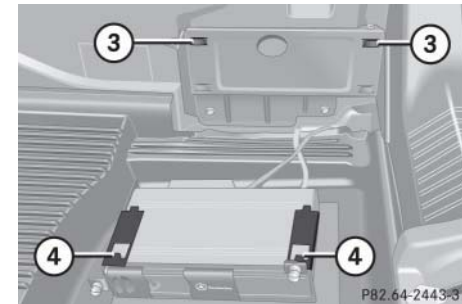

- ③ Mounting fixture
- ④ Retainer

Installing

- ▶ Insert CD changer from above into mounting fixture until retainers ④ engage in mounting fixture ③.
- ▶ Press fasteners ① down with a screwdriver and turn them clockwise to lock.

CD changer* installed

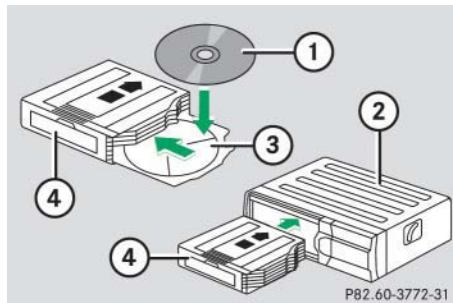

- ① CD
- ② CD changer
- ③ CD tray
- ④ CD magazine

If a CD changer is installed, it can be operated from the front control panel of the radio. A loaded magazine must be installed for CD playing.

Loading/unloading the CD magazine

- ▶ Slide the changer door to the right.
- ▶ Press the eject button . The magazine will be ejected.
- ▶ Remove the magazine.
- ▶ Pull out the CD tray until its stop is reached.
- ▶ Place the CDs in the recess of the tray, label side up.
- ▶ Push the tray into the magazine in the direction shown by the arrow.
- ▶ Insert the loaded magazine into the changer.



Close the door after the magazine has been inserted.

Playing CDs

- ▶ Press the CD button.

The CD most recently played will start at the point where it was last switched off. CDs stored in the magazine can be selected by using the station preset buttons 1-6.

```
CD1
TRACK 1
RDM RPT AUD SC
```

The magazine slot number of the selected CD will then be displayed after CD. The number of the track being played will be displayed after TRACK.



```
CD1
NO CD3
RDM RPT AUD SC
```

If there is no CD in the selected magazine slot, NO CD and the corresponding slot number will be displayed (e.g. NO CD3). After the last track on a CD has been played, the next CD will automatically be selected and played.

Controls in detail

Audio system



Skipping tracks forwards/backwards

- ▶ Press the  button.
The next track on the CD will be played.
- ▶ Press the  button.

If the track has been playing for more than ten seconds, it will revert to the start of that track. If it has been playing for less than ten seconds, it will revert to the preceding track.

To skip several tracks, the respective button must be pressed until the desired track is reached. If the beginning or end of the CD is reached during the search, the first or last track will be played.





Fast forward/reverse

- ▶ Press the  button and hold it down for audible fast forward.
- ▶ Press the  button and hold it down for audible reverse.

```
CD1
02:46
RDM RPT AUD SC
```

The search will stop when the button is released. The relative time of the track will be displayed during the search. The search mode will cancel if the beginning or end of the CD is reached.

Scanning

- ▶ Press the **SC** key.
Each track will be played for eight seconds in ascending order.
The search will stop at the track in question if the , , ,  buttons or the **SC** key are pressed.

Random play/repeat function

The tracks of the current CD are played in random order when the random feature (RDM) is selected.

- ▶ Press the **RDM** key to switch on, and press **RDM** again to switch off.

```
CD1
TRACK 10
RDM RPT AUD SC
```

When the repeat function (RPT) has been selected, a particular track can be played for as many times as desired.

- ▶ Press the **RPT** key to switch on.
- ▶ Press **RPT** again to switch off.



Both functions cannot be used simultaneously.

Direct track selection

Tracks can be selected directly using the buttons on the alpha-numeric keypad.

- ▶ Press the ***** function button, followed by the track number.

Telephone* operation

Various functions of the Mercedes-Benz integrated cellular telephone can be performed and displayed via the car radio. Further instructions for operating the car telephone can be found in the operation guide for the cellular telephone*.

Switching the telephone on and off

```
FM5 ST TEL  
95.5 MHz  
FM WB AUD SC
```

Switching on:

- ▶ Press the **TEL** button, TEL appears in the corner of the display.

Switching off:

- ▶ Press and hold the **TEL** button until the telephone symbol TEL no longer appears in the display, or
- ▶ Press the “PWR” button on the phone’s keypad.

Entering telephone number and starting dialing process

```
S.. ROAM  
READY  
SND END
```

- ▶ Enter the desired telephone number using the alpha-numeric keypad.
The number can have up to 32 digits, but only 13 of these can be displayed.
- ▶ Press the **SND** button to start the dialing process.

The entered number can be corrected using the **CLR** key.

Controls in detail

Audio system

```
S.. ROAM  
5551212  
SND CLR END
```

- ▶ Press the **CLR** key briefly.
The last digit will be deleted.
- ▶ Press the **CLR** key longer.
The complete number will be deleted.

Calling up the phone book

The numbers stored in telephone memory can be called up via either name or number entries. The memory contents from the portable phone must be downloaded and the telephone menu must be selected in order to call up the phone book. Refer to the “Memory download” section of the cellular telephone operation guide for more information.

Controls in detail

Audio system





Switching between name search and number search

- ▶ Press ABC key for name search.
- ▶ Press NUM key for number search.

Searching and selecting phone book entries by name

- ▶ Press the ABC key.





The current name is shown on the display.

- ▶ Press the  or  button to select the stored entries in alphabetical order.
- ▶ Press the  or  button to select the stored entries according to alphabetical initial letters (e.g. A-Adam, B-Brown, M-Miller).

Searching and selecting phone book entries by number

- ▶ Press the NUM key.

The current number is shown on the display.

- ▶ Press the  or  button to select the stored entries in numerical order.
- ▶ Press the  or  button to select the stored entries in increments of 5 (e.g. Entry no. 2, Entry no. 7, etc.).

Placing a call

```
S.. ROAM
5551212
SND CLR END
```

- ▶ Press the SND key when a number or a name has been selected using the method described above.

Manual repeat dialing (redial)

- ▶ Press the **SND** key once to re-select the last entered number.

The last dialed telephone number is shown on the display.

- ▶ Use the **▲**, **▼**, **▶** or **◀** button to select the numbers stored in the re-dial memory of the telephone.
- ▶ Press the **SND** key a second time to place the call.

```
S.. ROAM L2  
5551212  
SND CLR END
```

The abbreviation L and the number in the memory are shown in the top line of the display.

Accepting an incoming call in telephone mode

With an incoming call, the ringing tone will be heard and the message **CALL** appears in the display.

- ▶ Press the **SND** key to answer the call.

Accepting an incoming call in tape, CD or radio mode

If the telephone is activated in the background (telephone symbol in the display), the audio system will automatically switch to telephone mode when an incoming call is received. The audio source is muted, the ringing tone is heard and the message **CALL** appears. After the call has been terminated, the previously selected audio source is resumed.

Terminating call

- ▶ Press the **END** key to terminate a current call.

Component malfunctions

The radio, CD changer* and Mercedes-Benz integrated cellular telephone* are part of a fiberoptic networked system. Failure of one of the components can lead to malfunctions of the other components. Please contact your authorized Mercedes-Benz Center or call 1-800-FOR-MERCEdes for more information in the event of a malfunction.

Controls in detail

Power windows

▼ Power windows

Opening and closing the windows

The side windows can be opened and closed electrically. The switches for the side windows are on the lower part of the center console.



① Power window switch

Warning!



When closing the windows, make sure there is no danger of anyone being harmed by the closing procedure.

The closing of the door windows can be immediately halted by releasing .

When leaving the vehicle, always remove the key from steering lock and lock your vehicle. Do not leave children unattended in the vehicle, or with access to an unlocked vehicle. Unsupervised use of vehicle equipment can cause an accident and/or serious personal injury.

- ▶ Turn key in the steering lock to position **1** or **2**.



The power windows can also be operated with the retractable hardtop switch (▶ page 132).

Opening the windows

- ▶ Press switch at the symbol  to the resistance point.

The corresponding window will move downwards until you release the switch.

Closing the windows

- ▶ Press switch at the symbol .

The corresponding window will move upwards until you release the switch.

Fully opening the windows (Express-open)

- ▶ Press switch at the symbol  past the resistance point and release.

The corresponding window opens completely.

Stopping windows

- ▶ Briefly press switch at  or .

Synchronizing power windows

The side power windows must be synchronized

- after the battery has been disconnected
- if the windows cannot be fully opened or closed
- ▶ Switch ignition on.
- ▶ Press switch at the symbol  until the window is completely closed and hold down for approximately 1 second. Repeat procedure for each window.

Controls in detail

Retractable hardtop

▼ Retractable hardtop

Opening and closing the retractable hardtop

For safety reasons, the retractable hardtop can only be opened and closed when the vehicle is standing still.

Warning!



Before operating the switch for the retractable hardtop make sure no persons are injured by the moving parts (retractable hardtop, roof frame, and trunk lid) due to inattention.

Hands must never be placed near the roof frame, upper windshield area, retractable hardtop, shelf behind roll bars, or trunk lid while the retractable hardtop is being raised or lowered. Serious personal injury may occur.

If potential danger exists, release the retractable hardtop switch. This immediately interrupts the raising or lowering procedure. You then can operate the retractable hardtop switch to raise or lower the retractable hardtop away from the danger zone.



Never sit or place heavy objects on the rear shelf. Doing so could cause damage to the retractable hardtop and the rear shelf.

Warning!



When leaving the vehicle, always remove the key from the steering lock and lock the vehicle. Do not leave children unattended in the vehicle, or with access to an unlocked vehicle. Unsupervised use of vehicle equipment may cause an accident and/or serious personal injury.



When opening and closing the retractable hardtop, make sure

- there is sufficient clearance for the retractable hardtop to move up and the trunk lid to move back
- the luggage cover is extended and closed
- the trunk lid is closed
- no roof luggage carrier is installed
- the outside temperature is above +5°F (-15°C)

Otherwise the retractable hardtop and trunk of the vehicle could be damaged.



Keep luggage cover in trunk in the open position to prevent closing the retractable hardtop unintentionally while a roof luggage carrier is installed.

Luggage cover

The luggage cover is located in the trunk.

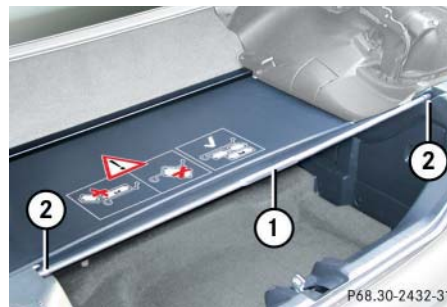

- ① Handle
- ② Holders

Closing luggage cover

- ▶ Pull out the luggage cover using handle ①.
- ▶ Hook the luggage cover into left and right side holders ②.

Controls in detail

Retractable hardtop

Opening luggage cover

- ▶ Unhook luggage cover from side holders ②.
- ▶ While holding onto handle ①, guide luggage cover back into its storage compartment.



To prevent damage to the retractable hardtop or luggage/cargo when lowering the retractable hardtop

- load trunk only to the height of the luggage cover
- do not permit luggage/cargo to push up the closed luggage cover
- do not load anything on top of or in front of the luggage cover
- do not place anything on the shelf behind the roll bars

Controls in detail

Retractable hardtop

Opening the retractable hardtop



Retractable hardtop switch

Before pulling on the retractable hardtop switch, you must ensure

- the parking brake is engaged (▷ page 47)
- the luggage cover is closed, see luggage cover
- the trunk lid is closed
- the ignition is switched on (key in steering lock position 2)

- ▶ Pull the retractable hardtop switch as indicated by the arrow until the retractable hardtop is completely lowered into its trunk storage compartment and the indicator lamp in the retractable hardtop switch goes out.

If you continuously pull on the retractable hardtop switch or release and pull it again within approximately 30 seconds, the door windows will close.

However, the door windows can also be closed/opened later on.

- ▶ Pull on the retractable hardtop switch twice forward/backward. Pull on the switch only briefly the first time. The second time, pull on the switch until the door windows have reached the desired height.

The rear quarter windows cannot be raised with the retractable hardtop lowered.



For safety reasons, the retractable hardtop cannot be opened while driving.

Make sure the retractable hardtop is dry before you open it. Otherwise water may enter the trunk interior.



If the indicator lamp in the retractable hardtop switch flashes slowly, a malfunction has occurred in the system.

If the indicator lamp in the retractable hardtop switch flashes rapidly, the trunk lid and/or luggage cover may be open and need to be closed.

Warning!



To prevent possible accidents, drive the vehicle only with the retractable hardtop either completely closed and locked, or fully lowered into its storage compartment.

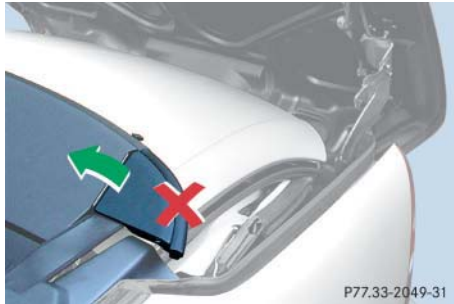

Do not manually move corner flaps or rear shelf. Doing so will result in damage to the retractable hardtop folding mechanism that is not covered by the Mercedes-Benz Limited Warranty.

Prior to cleaning the rear window, read and observe the instructions in the “Operation” section (▷ page 159).

Closing the retractable hardtop



Retractable hardtop switch

Before pushing on the retractable hardtop switch, you must ensure

- the parking brake is engaged (▷ page 47)
- the luggage cover is closed, see luggage cover
- the trunk lid is closed
- the ignition is switched on (key in steering lock position 2)

Controls in detail

Retractable hardtop

- ▶ Push the retractable hardtop switch as indicated by the arrow until the retractable hardtop is completely closed and locked and the indicator lamp in the retractable hardtop switch goes out.

If you continuously push on the retractable hardtop switch or release and push it again within approximately 30 seconds, the door windows will close.

However, the door windows can also be closed/opened later on.

- ▶ Pull on the retractable hardtop switch twice forward/backward. Pull on the switch only briefly the first time. The second time, pull on the switch until the door windows have reached the desired height.



For safety reasons, the retractable hardtop cannot be closed while driving.

Controls in detail

Retractable hardtop



If the indicator lamp in the retractable hardtop switch flashes slowly, a malfunction has occurred in the system.

If the indicator lamp in the retractable hardtop switch flashes rapidly, the trunk lid and/or the luggage cover may be open, and need to be closed.

Warning!



To prevent possible accidents, drive the vehicle only with the retractable hardtop either completely closed and locked, or fully lowered into its storage compartment.

Locking the retractable hardtop after raising/lowering

Warning!



The retractable hardtop is not fully closed and locked:

- if the indicator lamp in the retractable hardtop switch remains lit (key in steering lock position **2**).
- if the indicator lamp flashes, and a warning sounds for ten seconds when starting to drive.

If the retractable hardtop is not properly locked, lock it as described below.

Problems when operating the retractable hardtop

Unlocked status noticed when stopped

- ▶ Switch on the ignition.
- ▶ To lock the retractable hardtop in its fully closed position, push the retractable hardtop switch forward.

Unlocked status noticed while driving

Warning!



Stop the vehicle and lock the retractable hardtop before continuing to drive. You could otherwise endanger yourself and others.

- ▶ Stop the vehicle.
- ▶ Leave the ignition switched on
- ▶ To lock the retractable hardtop in its fully closed position, push the retractable hardtop switch forward.

Wind screen

Installing



- ① Storage bag
- ② Pin
- ③ Snap button
- ④ Coat hook

Warning!



The wind screen can restrict the driver's vision to the rear of the vehicle. To prevent a possible accident when visibility is limited (e. g. in darkness), the upper part of the wind screen should be folded back.

- ▶ Remove wind screen from its storage bag ① and unfold.

The storage bag is located on the wall behind the seat backrests.

- ▶ Attach straps to pins ②.
- ▶ Close snap buttons ③.
- ▶ Pull wind screen on molding over roll bars.



You can hang clothing on coat hooks ④ between the seat backrests.

Removing

- ▶ Pull wind screen on molding back over roll bars.
- ▶ Open snap buttons ③.



Pull on snap button head to open the snap button.

- ▶ Loosen straps from pins ②.
- ▶ Fold wind screen and put it back into storage bag ①.

Controls in detail

Driving systems

▼ Driving systems

The driving system of your vehicle is described on the following pages:

- Cruise control, with which the vehicle can maintain a preset speed

The BAS, ABS and ESP driving systems are described in the “Safety and Security” section (▷ page 66).

Cruise control

Cruise control automatically maintains the speed you set for your vehicle.

Use of cruise control is recommended for driving at a constant speed for extended periods of time. You can set or resume cruise control at any speed over 20 mph (30 km/h).

The cruise control function is operated by means of the cruise control lever.

The cruise control lever is the uppermost lever found on the left-hand side of the steering column (▷ page 18).

Warning!



Cruise control is a convenience system designed to assist the driver during vehicle operation. The driver is and must always remain responsible for the vehicle speed and for safe brake operation.

Only use cruise control if the road, traffic and weather conditions make it advisable to travel at a steady speed.

- The use of cruise control can be dangerous on winding roads or in heavy traffic because conditions do not allow safe driving at a steady speed.
- The use of cruise control can be dangerous on slippery roads. Rapid changes in tire traction can result in wheel spin and loss of control.
- Deactivate cruise control when driving in fog.

The “Resume” function should only be operated if the driver is fully aware of the previously set speed and wishes to resume this particular preset speed.



- ① Set current or higher speed
- ② Set current or lower speed
- ③ Cancel cruise control
- ④ Resume at last set speed

Setting current speed

- ▶ Accelerate or decelerate to the desired speed.
- ▶ Briefly lift ① or depress ② the cruise control lever.
The current speed is set.
- ▶ Remove your foot from the accelerator pedal.
Cruise control is activated.



On uphill or downhill grades, cruise control may not be able to maintain the set speed. Once the grade eases, the set speed will be resumed.

Canceling cruise control

There are several ways to cancel cruise control:

- ▶ Step on the brake pedal.
- or
- ▶ Briefly push the cruise control lever to position ③.

Cruise control will be canceled. The last speed set will be stored for later use.



Moving gear selector lever to position **N** while driving also cancels cruise control. However, the gear selector lever should not be moved to position **N** while driving except to coast when the vehicle is in danger of skidding (e.g. on icy roads).

Vehicles with manual transmission:

The set cruise controlled speed is switched off when declutching exceeds four seconds during downshifting a gear.



The last stored speed is canceled when you turn off the engine.

Controls in detail

Driving systems

Setting a higher speed

- ▶ Lift the cruise control lever to position ① and hold it up until the desired speed is reached.
- ▶ Release the cruise control lever.
The new speed is set.



Depressing the accelerator pedal does not deactivate cruise control. After brief acceleration (e.g. for passing), cruise control will resume the last speed set.

Setting a lower speed

- ▶ Depress the cruise control lever to position ② and hold it down until the desired speed is reached.
- ▶ Release the cruise control lever.
The new speed is set.



Vehicles with automatic transmission: When you use the cruise control lever to decelerate, the transmission will automatically downshift if the engine's braking power does not brake the vehicle sufficiently.

Fine adjustment in 1 mph (Canada: 1 km/h) increments

Faster

- ▶ Briefly tip the cruise control lever in the direction of arrow ①.

Slower

- ▶ Briefly tip the cruise control lever in the direction of arrow ②.

Setting to last stored speed ("Resume" function)

Warning!



The speed stored in memory should only be set again if prevailing road conditions permit. Possible acceleration or deceleration differences arising from returning to preset speed could endanger yourself and others.

- ▶ Briefly push the cruise control lever to position ④.
Cruise control will resume the last previously set speed.
- ▶ Remove your foot from the accelerator pedal.

▼ Useful features

Interior storage spaces

Warning!



To help avoid personal injury during a collision or sudden maneuver, exercise care when stowing objects in the vehicle. Put luggage or cargo in the cargo compartment if possible. Do not pile luggage or cargo higher than the seat backs. Do not place anything on shelf behind the roll bars.

Parcel nets cannot secure hard or heavy objects.

Keep compartment lids closed. This will help to prevent stored objects from being thrown about and injuring vehicle occupants during an accident.

Glove box



- ① Glove box lid release
- ② Glove box

Opening the glove box

- ▶ Pull lid release ①.
The glove box lid opens downward.

Closing the glove box

- ▶ Push lid up to close.

Controls in detail

Useful features

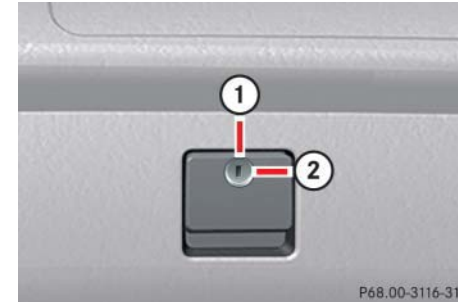

Locking the glove box

- ▶ Insert key into the glove box lock and turn it to position ①. Remove key from the lock while in position ①.

Unlocking the glove box

- ▶ Turn key in the glove box lock to position ②. Remove key from the lock while in position ②.

Controls in detail

Useful features

Cup holder

Warning!



When not in use, keep the cup holder closed. Place only containers that fit into the cup holder to prevent spills. Use lids on open containers and do not fill containers to a height where the contents, especially hot liquids, could spill during vehicle maneuvers.



- ① Cup holder
- ② Release button

Opening cup holder

- ▶ Push release button ②.
The cup holder ① opens automatically.

Closing cup holder

- ▶ Push cup holder against dashboard until it engages.

Storage compartments

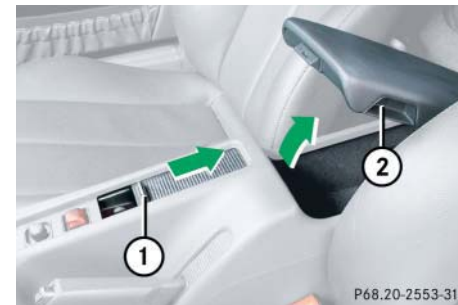

- ① Storage compartment in center console
- ② Storage compartment in armrest

Opening compartment in center console

- ▶ Slide cover ① rearward.
The compartment contains a cigarette lighter (▷ page 143).

Closing compartment in center console

- ▶ Slide cover ① forward.

Opening compartment in armrest

- ▶ Lift lid with handle ②.

Closing compartment in armrest

- ▶ Lower lid until it engages in lock.



The storage compartment in the armrest can be locked with the remote control (▷ page 74).

The storage compartment cannot be locked with the central locking switch (▷ page 79).

There are additional storage pockets behind the seats and in the door panels.

Parcel net in front passenger footwell

A small convenience parcel net is located in the front passenger footwell. It is for small and light items, such as road maps, mail, etc.

Warning!



Do not place heavy or fragile objects, or objects having sharp edges, in the parcel net.

In an accident, during hard braking or sudden maneuvers, they could be thrown around inside the vehicle, and cause injury to vehicle occupants.

Shelf behind roll bars

Warning!



The shelf behind the roll bars should not be used to carry objects. This will prevent such objects from being thrown around and injuring vehicle occupants during an accident or sudden maneuver.

The trunk is the preferred place to carry objects.

Controls in detail

Useful features

Ashtray



① Cover plate

Opening ashtray

- ▶ Briefly touch cover plate ①.
The ashtray opens automatically.

Removing ashtray insert

Warning!



Remove front ashtray only with vehicle standing still. Set the parking brake to secure vehicle from movement. Move gear selector lever to position **P** (manual transmission: in first gear). With gear selector lever in position **P** (manual transmission: in first gear) turn off the engine.

- ▶ Secure vehicle from movement by setting the parking brake. Move the selector lever to position **P** (manual transmission: in first gear).
- ▶ Pull ashtray past detent.
- ▶ Hold left and right side ② of ashtray insert and pull up.

Reinstalling the ashtray insert

- ▶ Place the ashtray insert into the ashtray frame.
- ▶ Push the ashtray insert down until it engages.

Coin holder

- ▶ Open the ashtray.
- ▶ Pull at the top of cover plate ① and fold it under ③.

Cigarette lighter



- ① Cigarette lighter
- ② Cover

- ▶ Turn key in the steering lock to position **1** or **2** (▷ page 29).
- ▶ Slide cover ② rearward.
- ▶ Push in cigarette lighter ①.

The cigarette lighter will pop out automatically when hot.

Warning!



Never touch the heating element or sides of the cigarette lighter; they are extremely hot. Hold the knob only.

When leaving the vehicle, always remove the key from the steering lock, and lock your vehicle. Do not leave children unattended in the vehicle, or with access to an unlocked vehicle. Unsupervised use of vehicle equipment may cause an accident and/or serious personal injury.



The cigarette lighter socket can be used to accommodate electrical accessories up to a maximum 85 W.

Telephone*

Warning!



Never operate radio transmitters equipped with a built-in or attached antenna (i.e. without being connected to an external antenna) from inside the vehicle while the engine is running. Doing so could lead to a malfunction of the vehicle's electronic system, possibly resulting in an accident and/or serious personal injury.

Radio transmitters, such as a portable telephone or a citizens band unit, should only be used inside the vehicle if they are connected to an antenna that is installed on the outside of the vehicle.

The external antenna must be approved by Mercedes-Benz. Please contact an authorized Mercedes-Benz Center for information on the installation of an approved external antenna. Refer to the radio transmitter operation instructions regarding use of an external antenna.

Controls in detail

Useful features

Warning!



Please do not forget that your primary responsibility is to drive the vehicle. A driver's attention to the road must always be his/her primary focus when driving. For your safety and the safety of others, we recommend that you pull over to a safe location and stop the vehicle before placing or taking a telephone call.

If you choose to use the telephone¹ while driving, please use the hands-free device and only use the telephone when road, weather and traffic conditions permit. Some jurisdictions prohibit the driver from using a cellular telephone while driving a vehicle.

Bear in mind that at a speed of just 30 mph (approximately 50 km/h), your vehicle is covering a distance of approx. 44 feet (approximately 13.5 m) every second.

¹ Observe all legal requirements.

See separate operating manual for instructions on how to use the telephone.

Warning!



Some jurisdictions prohibit the driver from using a cellular telephone while driving a vehicle. Whether or not prohibited by law, for safety reasons, the driver should not use the cellular telephone while the vehicle is in motion.

Stop the vehicle in a safe location before answering or placing a call.

Tele Aid



The initial activation of the Tele Aid system may only be performed by completing the subscriber agreement and placing an acquaintance call using the SOS button. Failure to complete either of these steps will result in a system that is not activated. If the system is not activated, the indicator lamp in the SOS button stays on after turning the key in steering lock to position **2**.

If you have any questions regarding activation, please call the Response Center at 1-800-756-9018 (in the USA) or 1-888-923-8367 (in Canada).



The Tele Aid system

(Telematic Alarm Identification on Demand)



The Tele Aid system consists of three types of response:

- automatic and manual emergency
- roadside assistance and
- information.

The Tele Aid system is operational providing that the vehicle's battery is charged, properly connected, not damaged and cellular and GPS coverage is available.

- ▶ To activate, press the SOS button, the Roadside Assistance button  or the Information button , depending on the type of response required.





The SOS button is located in the overhead control panel. The Roadside Assistance button  and the Information button  are located below the center armrest cover.

Shortly after the completion of your Tele Aid acquaintance call, you will receive a user ID and password via first call mail. By visiting www.mbusa.com and selecting "Tele Aid" (USA only), you will have access to account information, remote door unlock and more.



The Tele Aid system utilizes the cellular network for communication and the GPS (Global Positioning System) satellites for vehicle location. If either of these signals are unavailable, the Tele Aid system may not function and if this occurs, assistance must be summoned by other means.

System self-check

Initially, after turning the key in the steering lock to position 2, malfunctions are detected and indicated (the indicator lamps in the SOS button, the Roadside Assistance button  and the Information button  stay on longer than ten seconds or do not come on).

Controls in detail

Useful features

Warning!



If the indicator lamps in the SOS button, in the Roadside Assistance button, and/or in the Information button do not come on during the system self-check or if any of these indicators remain illuminated constantly in red after the system self-check, a malfunction in the system has been detected.

If a malfunction is indicated as outlined above, the system may not operate as expected. Have the system checked at the nearest Mercedes-Benz Center as soon as possible.

Controls in detail

Useful features

Warning!



The Tele Aid control unit is located under the driver's seat. If there is accumulation of water or other liquid in this area, the Tele Aid control unit could suffer an electrical short circuit making the system inoperative. In this case the indicator lamp in the SOS button does not illuminate during or remains illuminated after the system self-check. Have the system checked at the nearest Mercedes-Benz Center as soon as possible.

Emergency calls

An emergency call is initiated automatically:

- following an accident in which the emergency tensioning detractors (ETDs) or airbags deploy,
- if the anti-theft alarm or the tow-away alarm stays on for more than 20 seconds. See anti-theft alarm system (▷ page 71) and tow-away alarm (▷ page 72).

An emergency call can also be initiated manually by opening the cover next to the interior rear view mirror labeled SOS, then briefly pressing the button located under the cover. See below for instructions on initiating an emergency call manually.

Once the emergency call is in progress, the indicator lamp in the SOS button will begin to flash. All information relevant to the emergency, such as the location of the vehicle (determined by the GPS satellite location system), vehicle model, identification number and color are generated.

A voice connection between the Response Center and the occupants of the vehicle will be established automatically soon after the emergency call has been initiated. When a voice connection is established the audio system mutes. The Response Center will attempt to determine more precisely the nature of the accident provided they can speak to an occupant of the vehicle.

The Tele Aid system is available if:

- it has been activated and is operational. Activation requires a subscription for monitoring services, connection and cellular air time
- the relevant cellular phone network and GPS signals are available and pass the information on to the response center.



Location of the vehicle on a map is only possible if the vehicle is able to receive signals from the GPS satellite network and pass the information on to the response center.

Warning!



If the indicator lamp in the SOS button is illuminated continuously and there was no voice connection to the Response Center established, then the Tele Aid system could not initiate an emergency call (e.g. the relevant cellular phone network is not available). Should this occur, assistance must be summoned by other means.

Controls in detail

Useful features

Initiating an emergency call manually

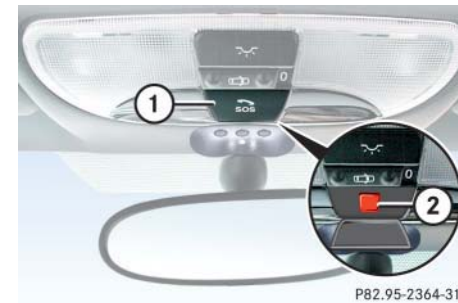

P82.95-2364-31

① Cover

② SOS button

- ▶ Briefly press on cover ①.

The cover will open.

- ▶ Press SOS button ② briefly.

The indicator lamp in SOS button ② will flash until the emergency call is concluded.

- ▶ Wait for a voice connection to the Response Center.

- ▶ Close cover ① after the emergency call is concluded.

Controls in detail

Useful features

Warning!



If you feel at any way in jeopardy when in the vehicle (e.g. smoke or fire in the vehicle, vehicle in a dangerous road location), please do not wait for voice contact after you have pressed the emergency button. Carefully leave the vehicle and move to a safe location. The Response Center will automatically contact local emergency officials with the vehicle's approximate location if they receive an automatic SOS signal and cannot make voice contact with the vehicle occupants.

Roadside Assistance button

Located below the center armrest cover is the Roadside Assistance button

- ▶ Press and hold the button (for longer than two seconds).

A call to a Mercedes-Benz Roadside Assistance dispatcher will be initiated. The button will flash while the call is in progress.

The Tele Aid system will transmit data generating the vehicle identification number, model, color and location (subject to availability of cellular and GPS signals).

A voice connection between the Roadside Assistance dispatcher and the occupants of the vehicle will be established.

- ▶ Describe the nature of the need for assistance.



The Mercedes-Benz Roadside assistance dispatcher will either dispatch a qualified Mercedes-Benz technician or arrange to tow your vehicle to the nearest Mercedes-Benz Center. For services such

as labor and/or towing, charges may apply. Refer to the Roadside Assistance manual for more information.

These programs are only available in the USA:

- Sign and Drive services: Services such as jump start, a few gallons of fuel or the replacement of a flat tire with the vehicle spare tire are obtainable.
- Remote Vehicle Diagnostics: This function permits the Mercedes-Benz Roadside Assistance dispatcher to download malfunction codes and actual vehicle data.



The indicator lamp in the Roadside Assistance button  remains illuminated in red for approx. ten seconds during the system self-check after turning the key in the steering lock to position **2** (together with the SOS button and the Information button ).

See System self-check (> page 145) when the indicator lamp does not light up in red or stays on longer than approximately ten seconds.

If the indicator lamp in the Roadside Assistance button  is illuminated continuously and there was no voice connection to the Response Center established, then the Tele Aid system could not initiate a Roadside Assistance call (e.g. the relevant cellular phone network was not available).

Information button

Located below the center armrest cover is the Information button .

- ▶ Press and hold the button (for longer than two seconds).

A call to the Customer Assistance Center will be initiated. The button will flash while the call is in progress.

The Tele Aid system will transmit data generating the vehicle identification number, model, color and location (subject to availability of cellular and GPS signals).



A voice connection between the Customer Assistance Center representative and the occupants of the vehicle will be established. Information regarding the operation of your vehicle, the nearest Mercedes-Benz Center or Mercedes-Benz USA products and services is available to you.

For more details concerning the Tele Aid system, please visit www.mbusa.com and use your ID and password (sent to you separately) to learn more (USA only).

Controls in detail

Useful features



The indicator lamp in the Information button  remains illuminated in red for approx. ten seconds during the system self-check after turning key in the steering lock to position **2** (together with the SOS button and the Roadside Assistance button ).

See System self-check (> page 145) when the indicator lamp does not light up in red or stays on longer than approximately ten seconds.

If the indicator lamp in the Information button  is illuminated continuously and there was no voice connection to the Response Center established, then the Tele Aid system could not initiate an Information call (e.g. the relevant cellular phone network is not available).

Controls in detail

Useful features



If the indicator lamps do not start flashing after pressing one of the buttons or remain illuminated (in red) at any time, the Tele Aid system has detected a fault or the service is not currently active, and may not initiate a call. Visit your Mercedes-Benz Center and have the system checked or contact the Response Center at 1-800-756-9018 (in the USA) or 1-888-923-8367 (in Canada) as soon as possible.

Upgrade signals

The Tele Aid system processes calls using the following priority.

- Automatic emergency – First priority
- Manual emergency – Second priority
- Roadside assistance – Third priority
- Information – Fourth priority

Should a higher priority call be initiated while you are connected, an upgrade (alternating) tone will be heard, and the appropriate indicator lamp will flash. If certain information such as vehicle identification number or customer information is not available, the operator may need to retransmit.

During this time you will hear a beep and voice contact will be interrupted. Voice contact will resume once the retransmission is completed. Once a call is concluded, a beep will be heard and the respective indicator lamp will stop flashing. Audio system operation will resume.



If the indicator lamp continues to flash or the system does not reset, contact the Response Center at 1-800-756-9018 (in the USA) or 1-888-923-8367 (in Canada), or Mercedes-Benz Customer Assistance at 1-800-FOR-MERCEdes (1-800-367-6372) in the USA or Customer Service at 1-800-387-0100 in Canada.



The indicator lamp in the respective button flashes until the call is concluded. Calls can only be terminated by a Response Center or Customer Assistance Center representative, except Roadside Assistance and Information calls.



When a Tele Aid call has been initiated, the audio system is muted and the selected mode (radio, tape or CD) pauses. The optional cellular phone (if installed) switches off. If you must use this phone, the vehicle must be parked. Disconnect the coiled cord and place the call.

Remote door unlock

In case you have locked your vehicle unintentionally (e.g. key inside vehicle), and the reserve key is not handy:

- ▶ Contact the Mercedes-Benz Response Center at 1-800-756-9018 (in the USA) or 1-888-923-8367 (in Canada).

You will be asked to provide your password which you provided when you completed the subscriber agreement.

- ▶ Then return to your vehicle and pull outside trunk handle for minimum of 20 seconds until the SOS button is flashing.

As an alternative, you may unlock the vehicle via Internet using the ID and password sent to you shortly after the completion of your acquaintance call.

The Response Center will then unlock your vehicle with the remote door unlocking feature.

Controls in detail

Useful features



The remote door unlock feature is available if the relevant cellular phone network is available.

The SOS button will flash to indicate receipt of the door unlock command.

Once the vehicle is unlocked, a Response Center specialist will attempt to establish voice contact with the vehicle occupants.

If the trunk handle was pulled for more than 20 seconds before door unlock authorization was received by the Response Center, you must wait 15 minutes before pulling the trunk handle again.

Controls in detail

Useful features

Stolen vehicle tracking services

In the event your vehicle was stolen:

- ▶ Report the incident to the police.
The police will issue a numbered incident report.
- ▶ Pass this number on to the Mercedes-Benz Response Center along with your password issued to you when you subscribed to the service.

The Response Center will then attempt to covertly contact the vehicle's Tele Aid system. Once the vehicle is located, the Response Center will contact the local law enforcement and you. The vehicle's location will only be provided to law enforcement.

Garage door opener

The built-in remote control is capable of operating up to three separately controlled devices, for example garage door openers, gate openers, or other devices compatible with HomeLink® or some other systems.

You can program the signal transmitter buttons.

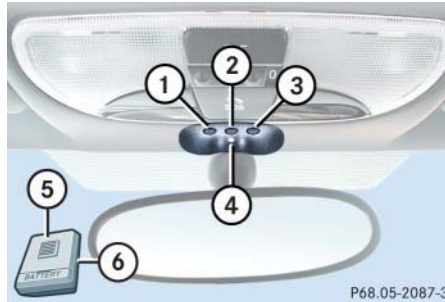

Remote control integrated into the interior rear view mirror

- ① ② ③ Signal transmitter button
- ④ Indicator lamp
- ⑤ Hand-held transmitter button
- ⑥ Hand-held remote control transmitter (not part of the vehicle equipment)

Controls in detail

Useful features

Warning!



Before programming the integrated remote control to a garage door opener or gate operator, make sure people and objects are out of the way of the device to prevent potential harm or damage.

When programming a garage door opener, the door moves up or down. When programming a gate operator, the gate opens or closes.

Do not use the integrated remote control with any garage door opener that lacks safety stop and reverse features as required by U.S. federal safety standards (this includes any garage door opener model manufactured before April 1, 1982). A garage door that cannot detect an object - signaling the door to stop and reverse - does not meet current U.S. federal safety standards.

Controls in detail

Useful features



Certain types of garage door openers are incompatible with the integrated opener. If you should experience difficulties with programming the transmitter, contact your authorized Mercedes-Benz Center, or call Mercedes-Benz Customer Assistance Center (in the USA only) at 1-800-FOR-MERCEdes, or Customer Service (in Canada) at 1-800-387-0100.



For operation in the USA only: This device complies with Part 15 of the FCC Rules. Operation is subject to the following two conditions:

- (1) This device may not cause harmful interference, and
- (2) this device must accept any interference received, including interference that may cause undesired operation.

Any unauthorized modification to this device could void the user's authority to operate the equipment.

Programming or reprogramming the integrated remote control

Step 1:

- ▶ Switch on ignition.

Step 2:

- ▶ If you have previously programmed an integrated signal transmitter button and wish to retain its programming, proceed to step 3. Otherwise, press and hold the two outer signal transmitter buttons ① and ③ and release them only when the indicator light begins to flash after approximately 20 seconds (do not hold the button for longer than 30 seconds). This procedure erases any previous settings for all three channels and initializes the memory. If you later wish to program a second and/or third hand-held transmitter to the remaining two signal transmitter buttons, do not repeat this step and begin directly with step 3.

Controls in detail

Useful features

Step 3:

- ▶ Hold the end of the hand-held remote control transmitter ⑥ of the device you wish to train approximately 2 to 5 in (5 to 12 cm) away from the surface of the integrated remote control located on the interior rear view mirror, keeping the indicator lamp ④ in view.

Step 4:

- ▶ Using both hands, simultaneously press the hand-held transmitter button ⑤ and the desired integrated signal transmitter button (①, ② or ③). Do not release the buttons until completing step 5.

The indicator lamp ④ on the integrated remote control will flash, first slowly and then rapidly.



The indicator lamp ④ flashes the first time the signal transmitter button is programmed. If this button has already been programmed, the indicator lamp will only start flashing after 20 seconds.

Step 5:

- ▶ When the indicator lamp ④ flashes rapidly, release both buttons.

Step 6:

- ▶ Press and hold the just-trained integrated signal transmitter button and observe the indicator lamp ④.

If the indicator lamp ④ stays on constantly, programming is complete and your device should activate when the integrated signal transmitter button is pressed and released.



If the indicator lamp ④ blinks rapidly for about two seconds and then turns to a constant light, continue with programming steps 8 through 12 as your garage door opener may be equipped with the “rolling code” feature.

Step 7:

- ▶ To program the remaining two buttons, repeat the steps above starting with step 3.

Controls in detail

Useful features

Rolling code programming

To train a garage door opener (or other rolling code devices) with the rolling code feature, follow these instructions after completing the “Programming” portion (steps 1 through 6) of this text. (A second person may make the following training procedures quicker and easier.)

Step 8:

- ▶ Locate “training” button on the garage door opener motor head unit.

Exact location and color of the button may vary by garage door opener brand. Depending on manufacturer, the “training” button may also be referred to as “learn” or “smart” button. If there is difficulty locating the transmitting button, refer to the garage door opener operator’s manual.

Step 9:

- ▶ Press “training” button on the garage door opener motor head unit.

The “training light” is activated.

You have 30 seconds to initiate the following step.

Step 10:

- ▶ Firmly press, hold for two seconds and release the programmed integrated signal transmitter button (①, ② or ③).

Step 11:

- ▶ Press, hold for two seconds and release same button a second time to complete the training process.

Some garage door openers (or other rolling code equipped devices) may require you to perform this procedure a third time to complete the training.

Step 12:

- ▶ Confirm the garage door operation by pressing the programmed integrated signal transmitter button (①, ② or ③).

Step 13:

- ▶ To program the remaining two buttons, repeat the steps above starting with step 3.

Gate operator/Canadian programming

Canadian radio-frequency laws require transmitter signals to “time-out” (or quit) after several seconds of transmission which may not be long enough for the integrated signal transmitter to pick up the signal during programming. Similar to this Canadian law, some U.S. gate operators are designed to “time-out” in the same manner.

If you live in Canada or if you are having difficulties programming a gate operator (regardless of where you live) by using the programming procedures, replace step 4 with the following:

Step 4:

- ▶ Continue to press and hold the integrated signal transmitter button (①, ② or ③) while you press and re-press (“cycle”) your hand-held remote control transmitter ⑥ every two seconds until the frequency signal has been learned. Upon successful training, the indicator lamp ④ will flash slowly and then rapidly after several seconds.
- ▶ Proceed with programming step 5 and step 6 to complete.

Operation of integrated remote control

- ▶ Switch on ignition.
- ▶ Select and press the appropriate integrated signal transmitter button (①, ② or ③) to activate the remote controlled device.

The integrated remote control transmitter continues to send the signal as long as the button is pressed – up to 20 seconds.

Erasing the integrated remote control memory

- ▶ Switch on ignition.
- ▶ Simultaneously hold down the signal transmitter buttons ① and ③, for approximately 20 seconds, until the indicator lamp ④ blinks rapidly. Do not hold for longer than 30 seconds.

The codes of all three channels are erased.



If you sell your vehicle, erase the codes of all three channels.

Controls in detail

Useful features

Reprogramming a single integrated signal transmitter button

To program a device using a signal transmitter button previously trained, follow these steps:

- ▶ Press and hold the desired signal transmitter button (①, ② or ③). Do not release the button.
- ▶ The indicator lamp will begin to flash after 20 seconds. Without releasing the integrated signal transmitter button, proceed with programming starting with step 3.

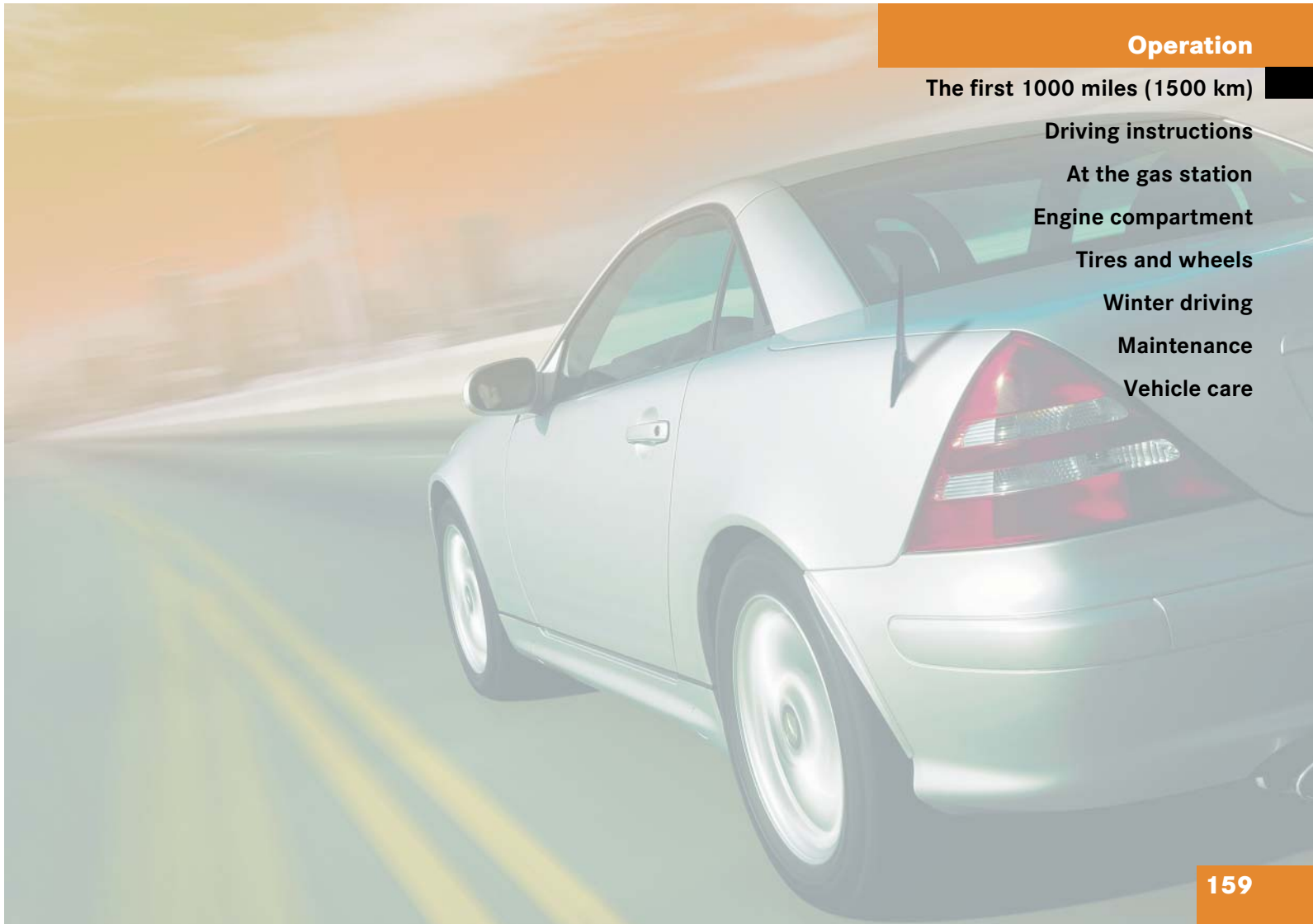

Operation

The first 1000 miles (1500 km)

Driving instructions

At the gas station

Engine compartment

Tires and wheels

Winter driving

Maintenance

Vehicle care

Operation

The first 1000 miles (1500 km)

In the “Operation” section you will find detailed information on operating, maintaining and caring for your vehicle.

▼ The first 1000 miles (1500 km)

The more cautiously you treat your vehicle during the break-in period, the more satisfied you will be with its performance later on.

- Drive your vehicle during the first 1000 miles (1500 km) at varying but moderate vehicle and engine speeds.
- During this period, avoid heavy loads (full throttle driving) and excessive engine speeds (no more than $\frac{2}{3}$ of maximum rpm in each gear).
- Do not attempt to slow the vehicle down by shifting to a lower gear using the selector lever or the gearshift lever.
- Shift gears in a timely manner.
- Avoid accelerating by kick-down.
- Select positions **3**, **2** or **1** only when driving at moderate speeds (for hill driving).

After 1000 miles (1500 km) you may gradually increase vehicle and engine speeds to the permissible maximum.



Additional instructions for AMG vehicles:

- During the first 1000 miles (1500 km), do not exceed a speed of 85 mph (140 km/h).
- During this period, avoid engine speeds above 4500 rpm in each gear.

All of the above, as may apply to your vehicle type, also apply when driving the first 1000 miles (1500 km) after the engine or the rear differential has been replaced.



Always obey applicable speed limits.

▼ **Driving instructions**

Drive sensibly – save fuel

Fuel consumption, to a great extent, depends on driving habits and operating conditions.

To save fuel you should:

- Keep tires at the recommended inflation pressures.
- Remove unnecessary loads.
- Allow engine to warm up under low load use.
- Avoid frequent acceleration and deceleration.
- Have all maintenance work performed at the intervals specified in the Service Booklet and as required by the FSS. Contact your authorized Mercedes-Benz Center.

Fuel consumption is also increased by driving in cold weather, in stop-and-go traffic, on short trips and in hilly country.

Drinking and driving

Warning!



Drinking and driving and/or taking drugs and driving can be a very dangerous combination. Even a small amount of alcohol or drugs can affect your reflexes, perceptions and judgement.

The possibility of a serious or even fatal accident are greatly increased when you drink or take drugs and drive.

Do not drink or take drugs and drive or allow anyone to drive who has been drinking or taking drugs.

Pedals

Warning!



Keep driver's foot area clear at all times. Objects stored in this area may impair pedal movement.

Operation

Driving instructions

Power assistance

Warning!



With the engine not running, there is no power assistance for the brake and steering systems. In this case, it is important to keep in mind that a considerably higher degree of effort is necessary to brake and steer the vehicle.

Brakes

Warning!



After driving in heavy rain for some time without applying the brakes or through water deep enough to wet brake components, the first braking action may be somewhat reduced and increased pedal pressure may be necessary to obtain expected braking effect. Maintain a safe distance from vehicles in front.

Resting your foot on the brake pedal will cause excessive and premature wear of the brake pads.

It can also result in the brakes overheating, thereby significantly reducing their effectiveness. It may not be possible to stop the vehicle in sufficient time to avoid an accident.

To help prevent brake disk corrosion after driving on wet road surfaces (particularly salted roads), it is advisable to brake the vehicle with considerable force prior to parking. The heat generated serves to dry the brakes.

If your brake system is normally only subjected to moderate loads, you should occasionally test the effectiveness of the brakes by applying above-normal braking pressure at higher speeds. This will also enhance the grip of the brake pads.



Be very careful not to endanger other road users when you apply the brakes.

Refer to the description of the Brake Assist System (BAS) (▷ page 67).

If the parking brake is released and the brake warning lamp in the instrument cluster stays on, the brake fluid level in the reservoir is too low.

Brake pad wear or a leak in the system may be the reason for low brake fluid in the reservoir.

Have the brake system checked immediately. Contact your authorized Mercedes-Benz Center.

All checks and service work on the brake system should be carried out by qualified technicians only. Contact your authorized Mercedes-Benz Center.

Install only brake pads and brake fluid recommended by Mercedes-Benz.

Warning!



If other than recommended brake pads are installed, or other than recommended brake fluid is used, the braking properties of the vehicle can be degraded to an extent that safe braking is substantially impaired. This could result in an accident.



When driving down long and steep grades, relieve the load on the brakes by shifting into a lower gear to use the engine's braking power. This helps prevent overheating of the brakes and reduces brake pad wear.

After hard braking, it is advisable to drive on for some time, rather than immediately parking, so that the air stream will cool down the brakes faster.

Driving off

Apply the brakes to test them briefly after driving off. Perform this procedure only when the road is clear of other traffic.

Warm up the engine smoothly. Do not place full load on the engine until the operating temperature has been reached.

When starting off on a slippery surface, do not allow a drive wheel to spin for an extended period with the ESP switched off. Doing so may cause serious damage to the drivetrain which is not covered by the Mercedes-Benz Limited Warranty.



Simultaneously depressing the accelerator pedal and applying the brake reduces engine performance and causes premature brake and drivetrain wear.

Parking

Warning!



Do not park this vehicle in areas where combustible materials such as grass, hay or leaves can come into contact with the hot exhaust system, as these materials could be ignited and cause a vehicle fire.

To reduce the risk of personal injury as a result of vehicle movement, before turning off the engine and leaving the vehicle always:

- Keep right foot on brake pedal.
- Firmly depress parking brake pedal.
- Move the selector lever to position **P** (manual transmission: first or reverse gear).
- Slowly release brake pedal.
- When parked on an incline, turn front wheels towards the road curb.
- Turn the key to steering lock position **0**.
- Take the key and lock vehicle when leaving.

Operation

Driving instructions



Set the parking brake whenever parking or leaving the vehicle. In addition, move selector lever to position **P** (manual transmission: first or reverse gear).

In addition, when parking on hills, turn front wheel towards the road curb.

Tires

Warning!



If you feel a sudden significant vibration or ride disturbance, or you suspect that possible damage to your vehicle has occurred, you should turn on the hazard warning flashers, carefully slow down, and drive with caution to an area which is a safe distance from the road.

Inspect the tires and the vehicle underbody for possible damage. If the vehicle or tires appear unsafe, have it towed to the nearest Mercedes-Benz Center or tire dealer for repairs.

Tread wear indicators (TWI) are required by law. These indicators are located in six places on the tread circumference and become visible at a tread depth of approximately $\frac{1}{16}$ in (1.6 mm), at which point the tire is considered worn and should be replaced.

The tread wear indicator appears as a solid band across the tread.

Warning!



Although the applicable federal motor vehicle safety laws consider a tire to be worn when the tread wear indicators (TWI) become visible at approximately $\frac{1}{16}$ in (1.6 mm), we recommend that you do not allow your tires to wear down to that level. As tread depth approaches $\frac{1}{8}$ in (3 mm), the adhesion properties on a wet road are sharply reduced.

Depending upon the weather and/or road surface (conditions), the tire traction varies widely.

Specified tire pressures must be maintained. This applies particularly if the tires are subject to high loads (e.g. high speeds, heavy loads, high ambient temperatures).

Warning!



Do not drive with a flat tire. A flat tire affects the ability to steer or brake the vehicle. You may lose control of the vehicle. Continued driving with a flat tire or driving at high speed with a flat tire will cause excessive heat build-up and possibly a fire.

Hydroplaning

Depending on the depth of the water layer on the road, hydroplaning may occur, even at low speeds and with new tires. Reduce vehicle speed, avoid track grooves in the road and apply brakes cautiously in the rain.

Tire traction

The safe speed on a wet, snow covered or icy road is always lower than on a dry road.

You should pay particular attention to the condition of the road whenever the outside temperatures are close to the freezing point.

Warning!



If ice has formed on the road, tire traction will be substantially reduced. Under such weather conditions, drive, steer and brake with extreme caution.

Mercedes-Benz recommends M+S rated radial-ply tires with a minimum tread depth of approximately $\frac{1}{8}$ in (4 mm) on all four wheels for the winter season to ensure normal balanced handling characteristics. On packed snow, they can reduce your stopping distance as compared with summer tires. Stopping distance, however, is still considerably greater than when the road is not covered with snow or ice. Exercise appropriate caution.



Avoid spinning of a drive wheel. This may cause serious damage to the drivetrain which is not covered by the Mercedes-Benz Limited Warranty.

Operation

Driving instructions

Tire speed rating

Regardless of the tire speed rating, local speed limits should be obeyed. Use prudent driving speeds appropriate to prevailing conditions.

Warning!



Even when permitted by law, never operate a vehicle at greater than the maximum speed rating of the tires.

Exceeding the maximum speed for which tires are rated can lead to sudden tire failure causing loss of vehicle control and resulting in an accident and/or personal injury and possible death, for you and for others.

SLK 230 Kompressor (except Sport Package)

Your vehicle is factory equipped with “V”-rated tires, which have a speed rating of 149 mph (240 km/h).

An electronic speed limiter prevents your vehicle from exceeding a speed of 130 mph (210 km/h).

SLK 320 (except Sport Package)

Your vehicle is factory equipped with “W”-rated tires, which have a speed rating of 168 mph (270 km/h).

An electronic speed limiter prevents your vehicle from exceeding a speed of 130 mph (210 km/h).

SLK 230 Kompressor/SLK 320 with Sport Package*

Your vehicle is factory equipped with “Y”-rated tires, which have a speed rating of 186 mph (300 km/h).

An electronic speed limiter prevents your vehicle from exceeding a speed of 130 mph (210 km/h).

SLK 32 AMG

Your vehicle is factory equipped with “Y”-rated tires, which have a speed rating of 186 mph (300 km/h).

An electronic speed limiter prevents your vehicle from exceeding a speed of 155 mph (250 km/h).



For information on tire speed rating for winter tires, see “Winter driving” (▷ page 188).

Winter driving instructions

The most important rule for slippery or icy roads is to drive sensibly and to avoid abrupt acceleration, braking and steering maneuvers. Do not use the cruise control system under such conditions.

When the vehicle is in danger of skidding, move gear selector lever to position **N** or declutch in case of manual transmission. Try to keep the vehicle under control by corrective steering action.



For information on driving with snow chains, see “Snow chains” (▷ page 189).

Warning!



On slippery road surfaces, never downshift in order to obtain braking action. This could result in drive wheel slip and reduced vehicle control. Your vehicle’s ABS will not prevent this type of control loss.

Road salts and chemicals can adversely affect braking efficiency. Increased pedal force may become necessary to produce the normal brake effect.

Depressing the brake pedal periodically when traveling at length on salt-strewn roads can bring road-salt-impaired braking efficiency back to normal.

If the vehicle is parked after being driven on salt-treated roads, the braking efficiency should be tested as soon as possible after driving is resumed.

Warning



Make sure not to endanger any other road users when carrying out these braking maneuvers.

Warning!



If the vehicle becomes stuck in snow, make sure snow is kept clear of the exhaust pipe and from around the vehicle with the engine running. Otherwise, deadly carbon monoxide (CO) gases may enter vehicle interior resulting in unconsciousness and death.

To assure sufficient fresh air ventilation, open a window slightly on the side of the vehicle not facing the wind.

Warning!



The outside temperature indicator is not designed to serve as an ice-warning device and is therefore unsuitable for that purpose. Indicated temperatures just above the freezing point do not guarantee that the road surface is free of ice.

For more information, see “Winter driving” (▷ page 188).

Operation

Driving instructions

Standing water



Do not drive through flooded areas or water of unknown depth. Never accelerate before driving into water. The wave could force water into the engine and auxiliary equipment, thus damaging them.

If you must drive through standing water, drive slowly to prevent water from entering the passenger compartment or the engine compartment. Water in these areas could cause damage to electrical components or wiring of the engine or transmission, or could result in water being ingested by the engine through the air intake causing severe internal engine damage. Any such damage is not covered by the Mercedes-Benz Limited Warranty.

Passenger compartment

Warning!



Always fasten items being carried as securely as possible.

In an accident, during hard braking or sudden maneuvers, loose items will be thrown around inside the vehicle, and cause injury to vehicle occupants unless the items are securely fastened in the vehicle.

The trunk is the preferred place to carry objects.

Driving abroad

Abroad, there is a widely-spread Mercedes-Benz service network at your disposal. If you plan to drive into areas which are not listed in the index of your Mercedes-Benz Center directory, you should request pertinent information from your authorized Mercedes-Benz Center.

Control and operation of radio transmitter

Radio and telephone*

Warning!



Please do not forget that your primary responsibility is to drive the vehicle. Only operate the radio or telephone¹ if road, traffic and weather conditions permit.

Bear in mind that at a speed of just 30 mph (approximately 50 km/h), your vehicle is covering a distance of approximately 44 feet (approximately 13.5 m) every second.

¹ Observe all legal requirements

Telephones and two-way radios

Warning!



Never operate radio transmitters equipped with a built-in or attached antenna (i.e. without being connected to an external antenna) from inside the vehicle while the engine is running. Doing so could lead to a malfunction of the vehicle's electronic system, possibly resulting in an accident and/or personal injury.

Radio transmitters, such as a portable telephone or a citizens band unit should only be used inside the vehicle if they are connected to an antenna that is installed on the outside of the vehicle.

Refer to the radio transmitter operation instructions regarding use of an external antenna.

Catalytic converter

Your Mercedes-Benz is equipped with monolithic type catalytic converters, an important element in conjunction with the oxygen sensors to achieve substantial control of the pollutants in the exhaust emissions. Keep your vehicle in proper operating condition by following our recommended maintenance instructions as outlined in your Service Booklet.



To prevent damage to the catalytic converters, use only premium unleaded gasoline in this vehicle.

Any noticeable irregularities in engine operation should be repaired promptly. Otherwise, excessive unburned fuel may reach the catalytic converter, causing it to overheat and start a fire.

Warning!



As with any vehicle, do not idle, park or operate this vehicle in areas where combustible materials such as grass, hay or leaves can come into contact with the hot exhaust system, as these materials could be ignited and cause a vehicle fire.

Operation

Driving instructions

Emission control

Certain engine systems serve to keep the toxic components of the exhaust gases within permissible legal limits.

These systems, of course, will function properly only when maintained strictly according to factory specifications. Any adjustments on the engine should, therefore, be carried out only by qualified Mercedes-Benz Center authorized technicians. Engine adjustments should not be altered in any way. Moreover, the specified service jobs must be carried out regularly according to Mercedes-Benz servicing requirements. For details refer to the Service Booklet.

Warning!



Inhalation of exhaust gas is hazardous to your health. All exhaust gas contains carbon monoxide, and inhaling it can cause unconsciousness and lead to death.

Do not run the engine in confined areas (such as a garage) which are not properly ventilated. If you think that exhaust gas fumes are entering the vehicle while driving, have the cause determined and corrected immediately. If you must drive under these conditions, drive only with at least one window fully open at all times.

Coolant temperature

During severe operating conditions and stop-and-go city traffic, the coolant temperature may rise to approx. 248°F (120°C).

The engine should not be operated with the coolant temperature over 248°F (120°C). Doing so may cause serious engine damage which is not covered by the Mercedes-Benz Limited Warranty.

Warning!



- Driving when your engine is badly overheated can cause some fluids, which may have leaked into the engine compartment, to catch fire. You could be seriously burned.
- Steam from an overheated engine can cause serious burns and can occur just by opening the engine hood. Stay away from the engine if you see or hear steam coming from it.

Turn off the engine, get out of the vehicle and do not stand near the vehicle until the engine has cooled down.

▼ At the gas station

Refueling

Warning!



Gasoline is highly flammable and poisonous. It burns violently and can cause serious injury. Whenever you are around gasoline, avoid inhaling fumes and skin contact, extinguish all smoking materials. Never allow sparks, flame or smoking materials near gasoline!

Failure to remove the cap slowly could result in personal injury.

The fuel filler flap is located on the right-hand side of the vehicle towards the rear. Locking/unlocking the vehicle with the remote control automatically locks/unlocks the fuel filler flap.



Fuel filler flap

- ▶ Remove the key from the steering lock.
- ▶ Open the fuel filler flap by pushing at the point indicated by the arrow.
The fuel filler flap springs open.
- ▶ Turn the fuel cap to the left and hold on to it until possible pressure is released.

Operation

At the gas station

- ▶ Take off the cap and set it in the recess on the fuel filler flap.

To prevent fuel vapors from escaping into open air, fully insert filler nozzle unit.



Use only premium unleaded gasoline with a minimum Posted Octane Rating of 91 (average of 96 RON / 86 MON). Information on gasoline quality can normally be found on the fuel pump.

More information on gasoline can be found in the Factory Approved Service Products pamphlet.

- ▶ Only fill your tank until the filler nozzle unit cuts out – do not top up or overfill. ▷▷

Operation

At the gas station



Warning!



Overfilling of the fuel tank may create pressure in the system which could cause a gas discharge. This could cause the gas to spray back out when removing the fuel pump nozzle, which could cause personal injury.

- ▶ Replace the fuel cap by turning it to the right.
You will hear when the fuel cap is tightened.
- ▶ Close the fuel filler flap.
You should hear the latch close shut.



Leaving the engine running and the fuel cap open can cause the **CHECK ENGINE** lamp to illuminate.

More information can be found in the “Practical hints” section (▷ page 205).

Check regularly and before a long trip

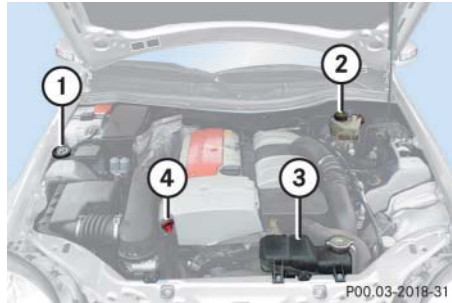

- ① Windshield washer and headlamp cleaning system*
More information on filling up the reservoir can be found in the “Operation” section (▷ page 184).
- ② Brake fluid

- ③ Coolant level
More information on coolant can be found in the “Operation” section (▷ page 180).
- ④ Engine oil level
More information on engine oil can be found in the “Operation” section (▷ page 175).
Opening hood (▷ page 174).



If you find that the brake fluid in the brake fluid reservoir has fallen to the minimum mark or below, have the brake system checked for brake pad thickness and leaks immediately. Notify an authorized Mercedes-Benz Center immediately. Do not add brake fluid as this will not solve the problem. For more information, (▷ page 204).

Coolant

For normal replenishing, use water (potable water quality). More information on coolant can be found in the “Operation” section (▷ page 180).

Exterior lamp switch (▷ page 83).

Vehicle lighting

Check function and cleanliness. For information on replacing light bulbs, see “Practical hints” section (▷ page 226).

Exterior lamp switch (▷ page 83).

Tire inflation pressure

More information on tire inflation pressure can be found in the “Operation” section (▷ page 186).

Operation

Engine compartment

▼ Engine compartment

Hood

Warning!



Do not pull the release lever while the vehicle is in motion. Otherwise the hood could be forced open by passing air flow.

Opening

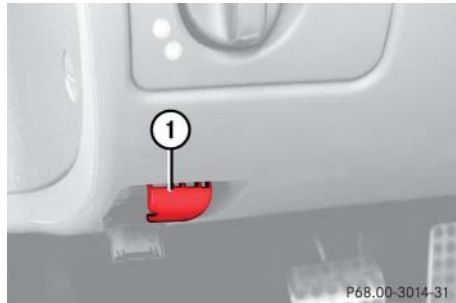

① Hood release

- ▶ Pull hood release ① downwards.
The hood is unlocked.



To avoid damage to the windshield wipers or hood, never open the hood if the wiper arms are folded forward away from the windshield.



② Lever for opening the hood

- ▶ Push lever ② on the hood upwards.

- ▶ Open the hood (do not pull up on the lever) and then release it.

The hood will be automatically held open at shoulder height by gas-filled struts.

Warning!



To help prevent personal injury, stay clear of moving parts when the hood is open and the engine is running. Make sure the hood is properly closed before driving. When closing the hood, use extreme caution not to catch hands or fingers.

The radiator fan may continue to run for approximately 30 seconds or even restart after the engine has been turned off. Stay clear of fan blades.

Warning!



If you see flames or smoke coming from the engine compartment, or if the coolant temperature gauge indicates that the engine is overheated, do not open the hood. Move away from vehicle and do not open the hood until the engine has cooled down. If necessary, call the fire department.

Warning!



The engine is equipped with a transistorized ignition system. Because of the high voltage it is dangerous to touch any components (ignition coils, spark plug sockets, diagnostic socket) of the ignition system

- with the engine running
- while starting the engine
- if ignition is “on” and the engine is turned manually

Closing

Warning!



Be careful that you do not close the hood on anyone.

- ▶ Let the hood drop from a height of approximately 1 ft (30 cm).

The hood will lock audibly.

- ▶ Make sure the hood is fully closed.

If you can raise the hood at a point above the headlamps, then it is not properly closed. Open it again and let it drop with somewhat greater force.

Engine oil

The amount of oil your engine needs will depend on a number of factors, including driving style. Higher oil consumption can occur when

- the vehicle is new
- the vehicle is driven frequently at higher engine speeds

Engine oil consumption checks should only be made after the vehicle break-in period.



Do not use any special lubricant additives, as these may damage the drive assemblies. Using special additives not approved by Mercedes-Benz will restrict your warranty entitlement.

More information on this subject is available at any authorized Mercedes-Benz Center.

Operation

Engine compartment

Checking engine oil level via display (SLK 320, SLK 32 AMG only)

When checking the oil level the vehicle must



- be parked on level ground
- be at normal operating temperature
- have been stationary for at least five minutes with the engine turned off

To check the engine oil level via the display in the speedometer, do the following:

- ▶ Turn the key in the steering lock to position **2**.



① Button

- ▶ Wait until the symbols  and  appear in the speedometer display.
- ▶ Within one second press button ① twice.

One of the following messages will subsequently appear in the display:

- OK
The oil level is correct. Engine oil does not to be added.
- -1.0 Q
(Canada: -1.0 L)
 - ▶ Add 1.0 quart (Canada: 1.0 liter) of engine oil.
- -1.5 Q
(Canada: -1.5 L)
 - ▶ Add 1.5 quarts (Canada: 1.5 liters) of engine oil.
- -2.0 Q
(Canada: -2.0 L)
 - ▶ Add 2.0 quarts (Canada: 2.0 liters) of engine oil.



If the message -2.0 Q (Canada: -2.0 L) blinks and a signal sounds, add oil according to amount displayed.

For adding engine oil see (▷ page 179).

More information on engine oil can be found in the “Technical data” section (▷ page 277) and (▷ page 279).

Other display messages

If there is excess engine oil with the engine at normal operating temperature, a signal sounds and the following message will blink in the display:

HI

The oil level is too high.

- ▶ Have excess oil siphoned or drained off. Contact your authorized Mercedes-Benz Center.



Excess oil must be siphoned or drained off. It could cause damage to the engine and catalytic converter not covered by the Mercedes-Benz Limited Warranty.

The  symbol flashes in the speedometer display if a proper oil level check cannot be performed.



- ▶ If engine is at normal operating temperature, wait five minutes before repeating check procedure.
- ▶ If engine is not yet at normal operating temperature, wait 30 minutes before repeating check procedure.



Perform the engine oil level check with the dipstick if it cannot be completed via the speedometer display (▷ page 177).

In this case we recommend that you have the system checked at a Mercedes-Benz Center.



If the  and  symbols are continuously illuminated after pressing button ① (▷ page 176) twice, and if there is no change in the speedometer display or the low engine oil level warning lamp comes on, a malfunction has occurred to the system.

Perform the engine oil level check with the dipstick (▷ page 177).

Visually check for oil leaks. If no obvious oil leaks are noted, drive to the nearest authorized Mercedes-Benz Center to have the system checked.

Operation

Engine compartment

See the “Practical hints” section (▷ page 199) if the low engine oil level warning lamp in the instrument cluster comes on.

Checking engine oil level with the oil dipstick

When checking the oil level the vehicle must

- be parked on level ground
- be at normal operating temperature
- have been stationary for at least five minutes with the engine turned off



The engine oil level can be checked by either the oil dipstick or via the speedometer display (SLK 320, SLK 32 AMG only) in the instrument cluster (▷ page 176). The amount of engine oil needed is shown more precisely in the speedometer display.

Operation

Engine compartment

To check the engine oil level with the oil dipstick, do the following:

- ▶ Open the hood (▷ page 174).
- ▶ Pull out oil dipstick ① (▷ page 179)
- ▶ Wipe oil dipstick ① clean.
- ▶ Fully insert oil dipstick ① into the dipstick guide tube.
- ▶ Pull out oil dipstick ① again after approximately three seconds to obtain accurate reading.

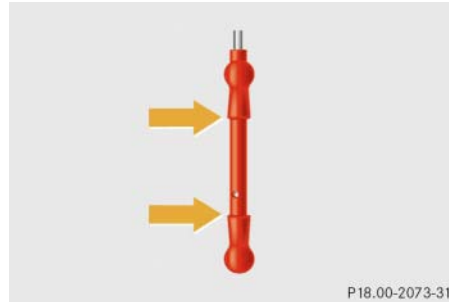

Oil dipstick

The oil level is correct when it is between the lower (min) and upper (max) mark of the oil dipstick.



The filling quantity between the upper and lower marks on the oil dipstick is approximately 2.1 US qt. (2.0 l).

- ▶ If necessary, add engine oil.

For adding engine oil see (▷ page 179).

More information on engine oil can be found in the “Technical data” section (▷ page 277) and (▷ page 279).

See the “Practical hints” section (▷ page 199) if the low engine oil level warning lamp in the instrument cluster comes on.

Adding engine oil



Only use approved engine oils. For a listing of approved engine oils, refer to the Factory Approved Service Products pamphlet in your vehicle literature portfolio.

In addition, check the oil filler cap for important information pertaining to the engine oil needing to meet a specific Mercedes-Benz specification (e.g. MB 229.5). If such information is printed on the oil filler cap, only use an engine oil from the list of approved engine oils in the Factory Approved Service Products pamphlet that meets the specification indicated on the oil filler cap. Using engine oils of other specification may cause the FSS to incorrectly determine the next service interval and will result in engine damage not covered by the Mercedes-Benz Limited Warranty.

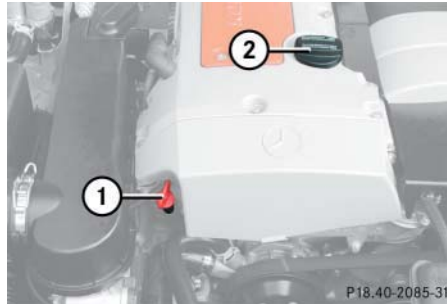

SLK 230 Kompressor

- ① Oil dipstick
- ② Filler cap

- ▶ Unscrew filler cap ② from filler neck.
- ▶ Add engine oil as required. Be careful not to overfill with oil.

Be careful not to spill any oil when adding. Avoid environmental damage caused by oil entering the ground or water.

Operation

Engine compartment



Excess oil must be siphoned or drained off. It could cause damage to the engine and catalytic converter not covered by the Mercedes-Benz Limited Warranty.

- ▶ Screw filler cap ② back on filler neck.

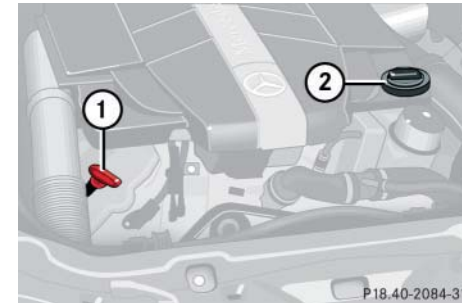

SLK 320, SLK 32 AMG

- ① Oil dipstick
- ② Filler cap

- ▶ Unscrew filler cap ② from filler neck.
- ▶ Add engine oil as required. Be careful not to overfill with oil.



Operation

Engine compartment

- ▷▷ Be careful not to spill any oil when adding. Avoid environmental damage caused by oil entering the ground or water.



Excess oil must be siphoned or drained off. It could cause damage to the engine and catalytic converter not covered by the Mercedes-Benz Limited Warranty.

- ▶ Screw filler cap ② back on filler neck.

More information on engine oil can be found in the “Technical data” section (▷ page 277) and (▷ page 279).

Transmission fluid level

The transmission fluid level does not need to be checked. If you notice transmission fluid loss or gear shifting malfunctions, have an authorized Mercedes-Benz Center check the transmission.

Coolant

The engine coolant is a mixture of water and anticorrosion/antifreeze. To check the coolant level, the vehicle must be parked on level ground and the engine must be cool.

The coolant expansion tank is located on the passenger side of the engine compartment.

Warning!



In order to avoid any possibly serious burns:

- Use extreme caution when opening the hood if there are any signs of steam or coolant leaking from the cooling system, or if the coolant temperature gauge indicates that the coolant is overheated.
- Do not remove pressure cap on coolant reservoir if engine temperature is above 194°F (90°C). Allow engine to cool down before removing cap. The coolant reservoir contains hot fluid and is under pressure.
- Using a rag, slowly open the cap approximately ½ turn to relieve excess pressure. If opened immediately, scalding hot fluid and steam will be blown out under pressure.
- Do not spill antifreeze on hot engine parts. Antifreeze contains ethylene glycol which may burn if it comes into contact with hot engine parts.

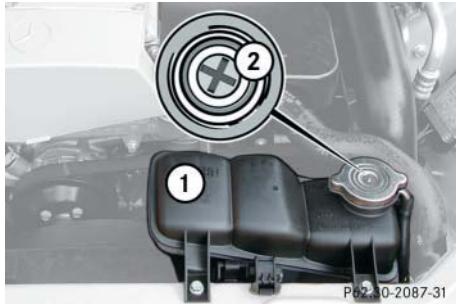

SLK 230 Kompressor

- ① Coolant expansion tank
- ② Float in the filler neck

- ▶ Using a rag, turn the cap to the left to the first detent position. Allow any excess pressure to escape.

- ▶ Continue turning the cap to the left and remove it.

The coolant level is correct if float ② can be seen at the top through the filler neck.

- ▶ Add coolant as required.
- ▶ Turn the cap back, past the first detent position, as far as it will go.



The drain plugs for the cooling system are located on the right side of the engine block and at the bottom of the radiator.

More information on coolant can be found in the “Technical data” section (▷ page 281).

Operation

Engine compartment

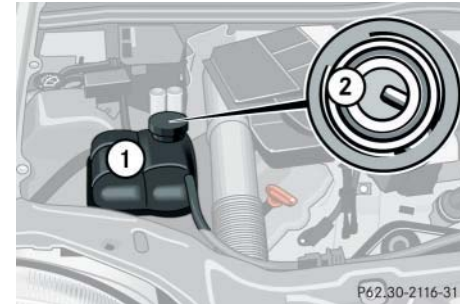

SLK 320, SLK 32 AMG

- ① Coolant expansion tank
- ② Marker in the filler neck

- ▶ Using a rag, turn the cap slowly approximately one half turn to the left to release any excess pressure.
- ▶ Continue turning the cap to the left and remove it. ▷▷

Operation

Engine compartment

- ▷▷ The coolant level is correct if the level
 - for cold coolant: the level must reach marker ② in the filler neck of the expansion tank.
 - for warm coolant: is approx. 0.6 in (1.5 cm) higher
- ▶ Add coolant as required.
- ▶ Replace and tighten cap.



The drain plugs for the cooling system are located on the right side of the engine block and at the bottom of the radiator.

More information on coolant can be found in the “Technical data” section (▷ page 281).

Battery

Your vehicle's battery is located in the engine compartment.

The battery should always be sufficiently charged in order to achieve its rated service life. Refer to Service Booklet for battery maintenance intervals.

If you use your vehicle mostly for short distance trips, you will need to have the battery charge checked more frequently.

When replacing the battery, always use batteries approved by Mercedes-Benz.

If you do not intend to operate your vehicle for an extended period of time, consult an authorized Mercedes-Benz Center about steps you need to observe.



Observe all safety instructions and precautions when handling automotive batteries.



Risk of explosion



Keep flames or sparks away from battery. Do not smoke.



Battery acid is caustic. Do not allow it to come into contact with skin, eyes or clothing.

In case it does, immediately flush affected area with clear water and seek medical help if necessary.

Operation

Engine compartment



Wear eye protection.



Keep children away.



Follow the instructions in this Operator's Manual.

Batteries contain materials that can harm the environment if disposed of improperly. Recycling of batteries is the preferred method of disposal. Many states require sellers of batteries to accept old batteries for recycling.

Operation

Engine compartment

Windshield washer system and headlamp cleaning system*

The windshield washer reservoir is located in the engine compartment.

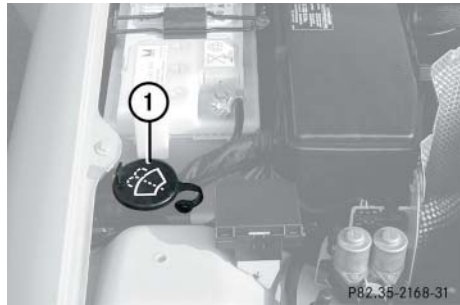

① Washer fluid reservoir

Fluid for the windshield washer system and the headlamp cleaning system* is supplied from the windshield washer reservoir. It has a capacity of approx. 7.4 US qt (7 l).

During all seasons, add MB Windshield Washer Concentrate "S" to water. Premix the windshield washer fluid in a suitable container.

- ▶ Refill the reservoir with MB Windshield Washer Concentrate and water (or commercially available premixed windshield washer solvent / antifreeze, depending on ambient temperatures).

Always use washer solvent / antifreeze where temperatures may fall below freezing. Failure to do so could result in damage to the washer system / reservoir.



Only use washer fluid which is suitable for plastic lenses. Improper washer fluid can damage the plastic lenses of the headlamps.



The windshield washer system on this vehicle is heated, so a fluid mixture produced to resist freezing at temperatures of approximately 14°F (-10°C) should be sufficient.

Warning!



Washer solvent / antifreeze is highly flammable. Do not spill washer solvent / antifreeze on hot engine parts, because it may ignite and burn. You could be seriously burned.

For information, see Windshield washer system and headlamp cleaning system* (▷ page 283).

▼ Tires and wheels

See your authorized Mercedes-Benz Center for information on tested and recommended rims and tires for summer and winter operation. They can also offer advice concerning tire service and purchase.

Warning!



Replace rims or tires with the same designation, manufacturer and type as shown on the original part. See your authorized Mercedes-Benz Center for further information. If incorrectly sized rims and tires are mounted:

- The wheel brakes or suspension components can be damaged.
- The correct operating clearance of the wheels and the tires are no longer guaranteed.

Warning!



Worn, old tires can cause accidents. If the tire tread is badly worn, or if the tires have sustained damage, replace them.

When replacing rims, use only genuine Mercedes-Benz wheel bolts specified for the particular rim type. Failure to do so can result in the bolts loosening and possibly an accident.

Retreaded tires are not tested or recommended by Mercedes-Benz, since previous damage cannot always be recognized on retreads. Mercedes-Benz can therefore not assure the operating safety of the vehicle when such tires are used.

See your authorized Mercedes-Benz Center for information on tested and recommended rims and tires for summer and winter operation.

Operation

Tires and wheels

Important guidelines

- Use only sets of tires and rims of the same type and make.
- Tires must be of the correct size for the rim.
- Break in new tires for approximately 60 miles (100 km) at moderate speeds.
- Regularly check the tires and rims for damage. Dented or bent rims can cause tire pressure loss and damage to the tire beads.
- If vehicle is heavily loaded, check tire pressure and correct as required.
- Do not allow your tires to wear down too far. Adhesion properties on wet roads are sharply reduced at tread depths under $\frac{1}{8}$ in (3 mm).
- When replacing individual tires, you should mount new tires on the front wheels first (on vehicles with same-sized wheels all around).

Operation

Tires and wheels

Life of tire

The service life of a tire is dependent upon varying factors including but not limited to:

- Driving style
- Tire pressure
- Distance driven

Warning!



Tires and spare tire should be replaced after six years, regardless of the remaining tread.



Keep unmounted tires in a cool, dry place with as little exposure to light as possible. Protect tires from contact with oil, grease and gasoline.

Direction of rotation

Unidirectional tires offer added advantages, such as better hydroplaning performance. To benefit, however, you must ensure the tires rotate in the direction specified.

An arrow on the sidewall indicates the intended direction of tire rotation.

Checking tire inflation pressure

Warning!



If the tire pressure repeatedly drops:

- Check the tires for punctures from foreign objects.
- Check to see whether air is leaking from the valves or from around the rim.

Correct the tire pressure only when tires are cold.

Regularly check your tire pressure at intervals of no more than 14 days.

If the tires are warm, you should only correct the tire pressure if it is too low for current operating conditions.

A table on the fuel filler flap lists the specified tire inflation pressures for warm and cold tires as well as for various operating conditions.



The pressures listed for light loads are minimum values offering high driving comfort.

Increased inflation pressures listed for heavier loads may also be used for light loads. These higher pressures produce favorable handling characteristics. The ride of the vehicle, however, will be somewhat harder. Never exceed the max. values or inflate tires below the min. values listed in the fuel filler flap.

Tire pressure changes by approximately 1.5 psi (0.1 bar) per 18°F (10°C) of air temperature change. Keep this in mind when checking tire pressure where the temperature is different from the outside temperature.

The tire temperature and with it the tire pressure is increased also while driving, depending on the driving speed and the tire load.

Warning!



Follow recommended inflation pressure.

Do not overinflate tires. Overinflated tires can result in sudden deflation (blowout) because they are more likely to become punctured or damaged by road debris, potholes, etc.

Do not underinflate tires. Underinflated tires wear unevenly, adversely affect handling and fuel economy, and are more likely to fail from being overheated.

Do not overload the tires by exceeding the specified vehicle capacity weight (as indicated by the label on the pillar in the driver's door opening). Overloading the tires can overheat them, possibly causing a blowout.

Check the spare tire periodically for condition and inflation. Spare tires will age and become worn over time even if never used, and thus should be inspected and replaced when necessary.

Rotating wheels

Warning!



Rotate front and rear wheels only if they are of the same size.

The wheels can be rotated every 3000 to 6000 miles (5000 to 10000 km), or sooner if necessary, according to the degree of tire wear. The same direction of tire rotation must be retained.

Rotate the wheels before the characteristic tire wear pattern becomes visible (shoulder wear on front wheels and tread center wear on rear wheels).

Thoroughly clean the inner side of the wheels after each rotation. Check and ensure proper tire inflation pressure.

Warning!



Have the tightening torque checked after changing a wheel. Wheels could become loose if not tightened with a torque of 80 lb-ft (110 Nm).

Use only genuine Mercedes-Benz wheel bolts specified for your vehicle's rims.

Operation

Winter driving

▼ Winter driving

Before the onset of winter, have your vehicle winterized at an authorized Mercedes-Benz Center. This service includes:

- Check of anticorrosion and antifreeze concentration.
- Addition of cleaning concentrate to the water of the windshield and headlamp* cleaning system. Add MB Concentrate "S" to a premixed windshield washer solvent / antifreeze which is formulated for temperatures below freezing point (▷ page 277).
- Battery test. Battery capacity drops with decreasing ambient temperature. A well charged battery helps to ensure the engine can be started, even at low ambient temperatures.
- Tire change. Mercedes-Benz recommends M+S rated radial-ply tires with a minimum tread depth of approximately $\frac{1}{6}$ in (4 mm) on all four wheels for the winter season.

Winter tires

Always use winter tires at temperatures below 45°F (7°C) and whenever wintry road conditions prevail. Use of winter tires is the only way to achieve the maximum effectiveness of the ABS and ESP in winter operation.

For safe handling, make sure all mounted winter tires are of the same make and have the same tread design.

Warning!



Winter tires with a tread depth under $\frac{1}{6}$ in (4 mm) must be replaced. They are no longer suitable for winter operation.

Always observe the speed rating of the winter tires installed on your vehicle. If the maximum speed for which your tires are rated is below the speed rating of your vehicle, you must place a notice to this effect where it will be seen by the driver. Such notices are available at your tire dealer or any authorized Mercedes-Benz Center.

Warning!



If you use your spare tire when winter tires are fitted on the other wheels, be aware that the difference in tire characteristics may very well impair turning stability and that overall driving stability may be reduced. Adapt your driving style accordingly.

Have the spare tire replaced with a winter tire at the nearest authorized Mercedes-Benz Center.

Block heater (Canada only)

The engine is equipped with a block heater.

The electrical cable may be installed at your authorized Mercedes-Benz Center.

Snow chains

Snow chains should only be driven on snow-covered roads at speeds not to exceed 30 mph (50 km/h). Remove chains as soon as possible when driving on roads without snow.



When driving with snow chains, you may wish to deactivate the ESP (▷ page 69) before setting the vehicle in motion. This will improve the vehicle's traction.

Please observe the following guidelines when using snow chains:

- Use of snow chains is not permissible with all wheel/tire combinations.
- Use of snow chains may be prohibited depending on location. Always check local and state laws before installing snow chains.
- Snow chains should only be used on the rear wheels. Follow the manufacturer's mounting instructions.
- Only use snow chains that are approved by Mercedes-Benz. Your authorized Mercedes-Benz Center will be glad to advise you on this subject.



Use of snow chains is not permissible with the collapsible tire in general and with tire sizes:

- 225/45 R17 91H M+S
- 225/50 R16 92V
- 225/50 R16 92W
- 245/40 R17 91Y (Sport Package*)

Operation

Maintenance

▼ Maintenance

We strongly recommend that you have your vehicle serviced by your authorized Mercedes-Benz Center, in accordance with the Service Booklet at the times called for by the FSS (Flexible Service System).



Failure to have the vehicle maintained in accordance with the Service Booklet at the designated times /mileage called for by the FSS may result in vehicle damage not covered by the Mercedes-Benz Limited Warranty.

FSS will notify you when your next service is due.





- ① Knob
- ② Display in the speedometer

Approximately one month before your next service is due, the type of service is indicated in the speedometer display ②:

-  Minor service (A)
-  Major service (B)

Depending on operating conditions throughout the year, one of the following service symbols is also shown:

-  1000 Calculated distance remaining, e. g. service in 1000 miles (km)

-  10 Calculated remaining time in days, e. g. service in 10 days

i

The interval between services depends on your driving habits. A gentle driving style, moderate engine speeds and the avoidance of short distance trips will lengthen the interval between services.

Clearing the service indicator

The service indicator is automatically cleared



- after ten seconds when you switch on the ignition or when reaching the service threshold while driving
- after 30 seconds, once the suggested service term has passed

You can also clear it yourself.

- ▶ Press knob ①.

Service term exceeded

If you have exceeded the suggested service term:

- the  or  appears in the display ② for 30 seconds and a signal sounds after switching on the ignition.
- it is preceded by a “-” (minus symbol)

The Mercedes-Benz Center will reset the service indicator following a completed service.

Calling up the service indicator

- ▶ Within one second press knob ① (▷ page 190) twice.

The service symbol and the service deadline appear in the display ②.

Resetting the service indicator

In the event that the service on your vehicle is not carried out by an authorized Mercedes-Benz Center, you can reset the service indicator yourself.

- ▶ Switch ignition on (key in steering lock position 2) and immediately press knob ① (▷ page 190) twice within 1 second.

The present status for days or distance is displayed.

- ▶ Within ten seconds turn key in steering lock to position 0.
- ▶ Press and hold knob ① while turning key in steering lock to position 2 again.

The present status for days and distance is displayed once more.

Continue to hold knob ① until you hear a signal.

- ▶ Release knob ①.

The service indicator now displays the reset interval.



If the service indicator was inadvertently reset, have a Mercedes-Benz Center correct it.

Only reset if the proper service has been performed. Resetting the system without performing proper service as called for by the FSS will cause the FSS to incorrectly determine the next service interval which will result in engine damage not covered by the Mercedes-Benz Limited Warranty.

If the battery is disconnected, the days of disconnection will not be included in the count shown by the service indicator. To arrive at the true service deadline, you will need to subtract these days from the days shown in the service indicator.

Do not confuse the service indicator with the engine oil level indicator .

Operation

Vehicle care

▼ Vehicle care

Cleaning and care of vehicle

Warning!



Many cleaning products can be hazardous. Some are poisonous, others are flammable. Always follow the instructions on the particular container. Always open your vehicle's doors or windows when cleaning the inside. Never use fluids or solvents that are not designed for cleaning your vehicle.

In operation, your vehicle is subjected to varying external influences which, if gone unchecked, can attack the paintwork as well as the underbody and cause lasting damage.

Such damage is caused not only by extreme and varying climatic conditions, but also by:

- Air pollution
- Road salt
- Tar
- Gravel and stone chipping

To avoid paint damage, you should immediately remove:

- Grease and oil
- Fuel
- Coolant
- Brake fluid
- Bird droppings
- Insects
- Tree resins, etc.

Frequent washing reduces and /or eliminates the aggressiveness and potency of the above adverse influences.

More frequent washings are necessary to deal with unfavorable conditions:

- near the ocean
- in industrial areas (smoke, exhaust emissions)
- during winter operation

You should check your vehicle from time to time for stone chipping or other damage. Any damage should be repaired as soon as possible to prevent the start of corrosion.

In doing so, do not neglect the underbody of the vehicle. A prerequisite for a thorough check is a washing of the underbody followed by a thorough inspection. Damaged areas need to be re-undercoated.

Your vehicle has been treated at the factory with a wax-base rustproofing in the body cavities which will last for the lifetime of the vehicle. Post-production treatment is neither necessary nor recommended by Mercedes-Benz because of the possibility of incompatibility between materials used in the production process and others applied later.

We have selected car-care products and compiled recommendations which are specially matched to our vehicles and which always reflect the latest technology. You can obtain Mercedes-Benz approved car-care products at your authorized Mercedes-Benz Center.

Scratches, corrosive deposits, corrosion or damage due to negligent or incorrect care cannot always be removed or repaired with the car-care products recommended here. In such cases it is best to seek aid at your authorized Mercedes-Benz Center.

The following topics deal with the cleaning and care of your vehicle and give important "how-to" information as well as references to Mercedes-Benz approved car-care products.

Additional information can be found in the booklet "Vehicle Care Guide".

Power washer

When using a power washer for cleaning the vehicle, always observe manufacturer's operating instructions.



Never use a round nozzle to power wash tires. The intense jet of water can result in damage to the tire.

Always replace a damaged tire.

Always keep the jet of water moving across the surface. Do not aim directly at electrical parts, electrical connectors, seals, or other rubber parts.

Tar stains

Quickly remove tar stains before they dry and become more difficult to remove. A tar remover is recommended.

Paintwork, painted body components

Mercedes-Benz approved Paint Care should be applied when water drops on the paint surface do not "bead up", normally every 3 to 5 months, depending on climate and washing detergent used.

Mercedes-Benz approved Paint Cleaner should be applied if the paint surface shows signs of embedded dirt (i.e. loss of gloss).

Do not apply any of these products or wax if your vehicle is parked in the sun or if the hood is still hot.

Use the appropriate MB-Touch-Up Stick for quick and provisional repairs of minor paint damage (i.e. chips from stones, vehicle doors, etc.).

Engine cleaning

Prior to cleaning the engine compartment, make sure to protect electrical components and connectors from contact with water and cleaning agents.

Corrosion protection, such as MB Anticorrosion Wax should be applied to the engine compartment after every engine cleaning. Before applying, all control linkage bushings and joints should be lubricated. The poly-V-belt and all pulleys should be protected from any wax.

Vehicle washing

Do not use hot water or wash your vehicle in direct sunlight. Use only a mild car wash detergent, such as Mercedes-Benz approved Car Shampoo.

Thoroughly spray the vehicle with a diffused jet of water. Direct only a very weak spray towards the ventilation intake. Use plenty of water and rinse the sponge and chamois frequently.

Rinse with clear water and thoroughly dry with a chamois. Do not allow cleaning agents to dry on the finish.

Due to the width of the vehicle, fold in outside mirrors prior to running the vehicle through an automatic car wash to prevent damage to the mirrors.

In the winter, thoroughly remove all traces of road salt as soon as possible.

When washing the underbody, do not forget to clean the inner sides of the wheels.

Ornamental moldings

For regular cleaning and care of very dirty chrome-plated parts, use a chrome cleaner.

Headlamps, side makers, tail lamps, turn signal lenses

Use a mild car wash detergent, such as Mercedes-Benz approved Car Shampoo, with plenty of water.

To prevent scratches, never apply strong force and use only a soft, non-scratchy cloth when cleaning the lenses. Do not attempt to wipe dirty lenses with a dry cloth or sponge.

Wiper blades

- ▶ Fold wiper arm forward.

Warning!



For safety reasons, switch off wipers and remove Key from starter switch before cleaning the wiper blades, otherwise the wiper motor might suddenly turn on and cause injury.

- ▶ Clean the wiper blade inserts with a clean cloth and detergent solution.



Fold the windshield wiper arms back onto the windshield before turning the key in the starter switch.

Hold onto the wiper when folding the wiper arm back. If released, the force of the impact from the tensioning spring could crack the windshield.

Window cleaning

- ▶ Fold wiper arm forward.

Warning!



For safety reasons, switch off wipers and remove Key from starter switch before cleaning the wiper blades, otherwise the wiper motor might suddenly turn on and cause injury.

- ▶ Use a window cleaning solution on all glass surfaces.

An automotive glass cleaner is recommended.



Fold the windshield wiper arms back onto the windshield before turning the key in the steering lock.

Hold onto the wiper when folding the wiper arm back. If released, the force of the impact from the tensioning spring could crack the windshield.

Rear window cleaning

The corner flaps of the rear shelf partially cover the rear window. This prevents the window from being fully cleaned with the hardtop closed.



Do not manually move corner flaps or rear shelf. Doing so will result in damage to the roof folding mechanism that is not covered by the Mercedes-Benz Limited Warranty.

Warning!



If a warning sounds and the indicator lamp in the hardtop switch blinks, immediately stop cleaning and move back from window to prevent possible injury.

The hardtop is lowered into its storage compartment.

Operation

Vehicle care

- ▶ Prior to cleaning the inside of the rear window, turn key in steering lock to position **2**.

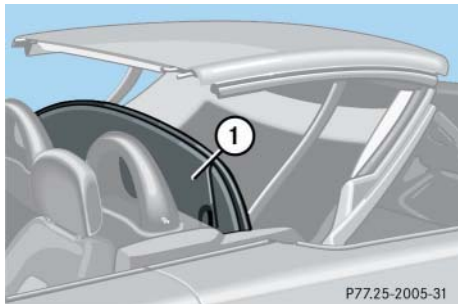

- ① Rear shelf in vertical position
 - ▶ Operate hardtop via the switch (▷ page 130) until rear shelf ① is in a vertical position.
- The roof will remain in this position for approximately 7 minutes, sufficient time for cleaning the inside of the rear window.



The roof will only stay in this position when the key is in steering lock position **2**.

If you pull on the hardtop switch again, you can continue to clean the rear window for another 7 minutes.

Light alloy wheels

Mercedes-Benz approved Wheel Care should be used for regular cleaning of the light alloy wheels.

If possible, clean wheels once a week with Mercedes-Benz approved Wheel Care, using a soft bristle brush and a strong spray of water.

Follow instructions on container.



Only use acid-free cleaning materials. Acid may cause corrosion or damage the clear coat.

Instrument cluster

Use a gentle dishwashing detergent or mild detergent for delicate fabrics as a washing solution. Wipe with a cloth moistened in lukewarm solution. Do not use scouring agents.

Steering wheel and gear selector lever

Wipe with a damp cloth and dry thoroughly or clean with Mercedes-Benz approved Leather Care.

Cup holder

Use a gentle dishwashing detergent or mild detergent for delicate fabrics as a washing solution. Wipe with a cloth moistened in lukewarm solution. Do not use scouring agents.

Hard plastic trim items

Pour Mercedes-Benz approved Interior Care onto a soft lint-free cloth and apply with light pressure.

Headliner

Clean with soft bristle brush, or use a dry-shampoo cleaner in case of excessive dirt.

Seat belts

The webbing must not be treated with chemical cleaning agents. Use only clear, lukewarm water and soap. Do not dry the webbing at temperatures above 176°F (80°C) or in direct sunlight.

Warning!

Do not bleach or dye seat belts as this may severely weaken them. In a crash they may not be able to provide adequate protection.

Upholstery

Using aftermarket seat covers or wearing clothing that have the tendency to give off coloring (e.g. when wet, etc.) may cause the upholstery to become permanently discolored. By lining the seats with a proper intermediate cover, contact-discoloration will be prevented.

Leather upholstery

Wipe leather upholstery with a damp cloth and dry thoroughly or clean with Mercedes-Benz approved Leather Care. Exercise particular care when cleaning perforated leather as its underside should not become wet.

Cloth upholstery

Clean with soft bristle brush, or use a dry-shampoo cleaner in case of excessive dirt.

Plastic and rubber parts

Do not use oil or wax on these parts.



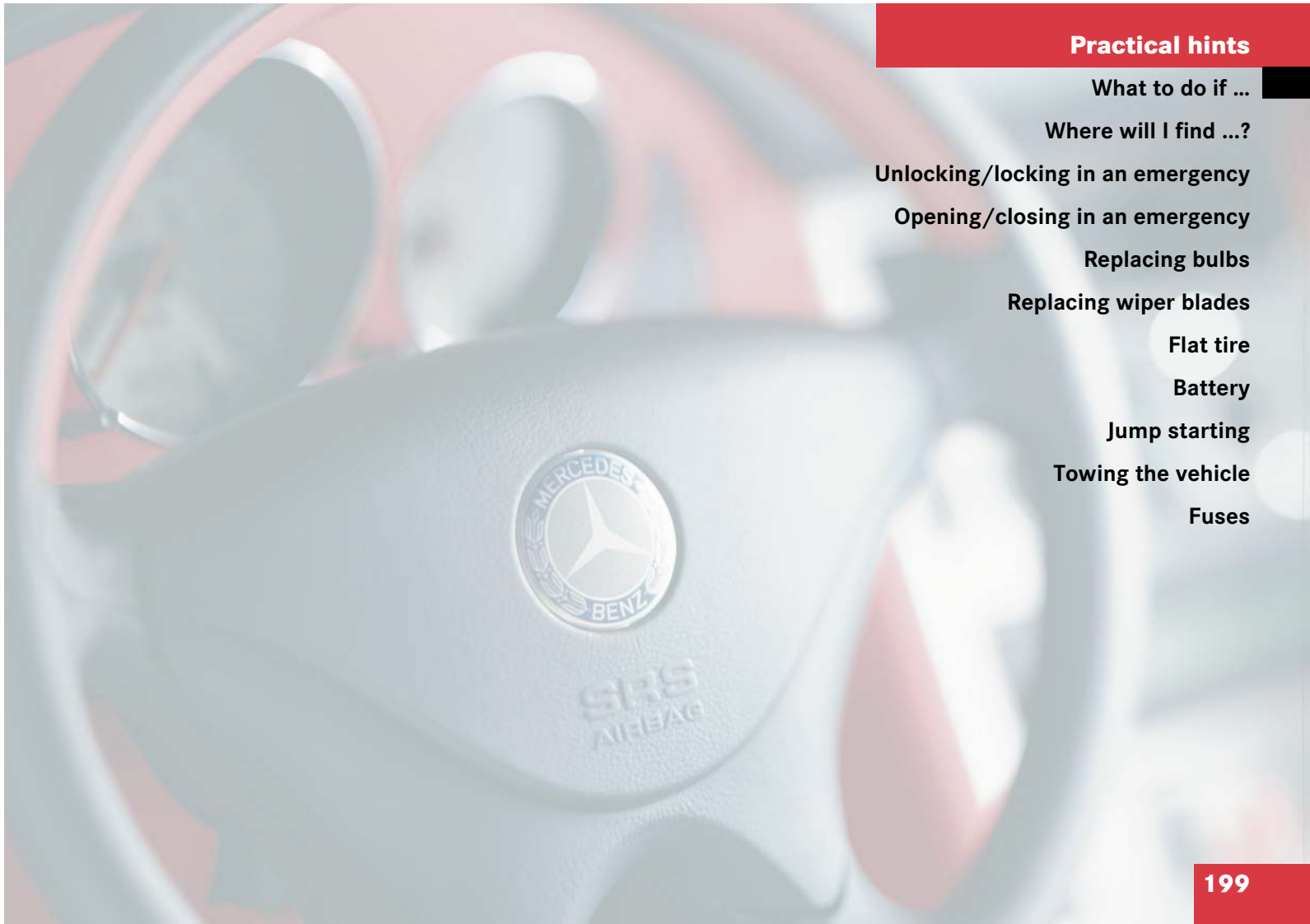

Practical hints

What to do if ...

Where will I find ...?

Unlocking/locking in an emergency

Opening/closing in an emergency

Replacing bulbs

Replacing wiper blades

Flat tire

Battery

Jump starting

Towing the vehicle

Fuses

Practical hints

What to do if ...



▼ What to do if ...

Lamps in instrument cluster

General information:

If a bulb in the instrument cluster fails to light up during the bulb self-check when

turning the key in steering lock to position **2**, have it checked and replaced if necessary.

Problem	Possible cause	Suggested solution
 The yellow ESP warning lamp flashes while driving.	The ESP or traction control has come into operation because of detected traction loss in at least one tire.	<ul style="list-style-type: none"> ▶ When driving off apply as little throttle as possible. ▶ While driving, ease up on the accelerator. ▶ Adapt your speed and driving to the prevailing road and weather conditions. ▶ Do not deactivate the ESP. Exceptions: (▷ page 68) <p>Failure to follow these instructions increases the risk of accidents.</p>
 The yellow BAS/ESP malfunction indicator lamp comes on while driving.	The ESP has detected a malfunction and switched off. Risk of accident! Adapt your speed and driving to the prevailing road conditions.	<ul style="list-style-type: none"> ▶ Turn the ESP back on (▷ page 68). <p>If the ESP cannot be turned back on, have the system checked at an authorized Mercedes-Benz Center as soon as possible.</p>

Practical hints

What to do if ...

Problem	Possible cause	Suggested solution
 The yellow ABS malfunction indicator lamp and warning comes on while driving.	<p>The ABS has detected a malfunction and has switched off. The BAS and ESP are also switched off. Both indicator lamps come on with the engine running.</p> <p>The brake system is still functioning normally but without the ABS available.</p>	<ul style="list-style-type: none">▶ Continue driving with added caution. Wheels will lock during hard braking reducing steering capability.▶ Have the system checked at an authorized Mercedes-Benz Center as soon as possible. <p>Failure to follow these instructions increases the risk of an accident.</p>
	<p>The charging voltage has fallen below 10 volts and the ABS has switched off.</p>	<ul style="list-style-type: none">▶ When the voltage is above this value again, the ABS is operational again.▶ If necessary, have the alternator and battery checked.

Practical hints

What to do if ...

Problem	Possible cause	Suggested solution
 The yellow BAS/ESP malfunction indicator lamp comes on while driving.	The ESP is deactivated because of an interrupted power supply. The ABS may still be operational.	<ul style="list-style-type: none">▶ Synchronize the ESP. With vehicle stationary and the engine running, turn the steering wheel completely to the left and then to the right to synchronize the ESP.
	The BAS has detected a malfunction and switched off. The brake system is still functioning normally but without the BAS available.	<ul style="list-style-type: none">▶ Continue driving with added caution.▶ Have the system checked at an authorized Mercedes-Benz Center as soon as possible. <p>Failure to follow these instructions increases the risk of accident.</p>



When synchronizing the ESP, make sure you can turn the steering wheel in both directions as far as it will go without the wheels hitting any objects, e.g. a road curb.

Practical hints

What to do if ...

Problem	Possible cause	Suggested solution
BAS ESP The yellow BAS/ESP malfunction indicator lamp comes on while driving.	The charging voltage has fallen below 10 volts and the BAS has switched off.	<ul style="list-style-type: none">▶ When the voltage is above this value again, the BAS is operational again.▶ If necessary, have the alternator and battery checked.
SRS The red SRS indicator lamp lights up while driving.	There is a malfunction in the restraint systems. The airbags or emergency tensioning device (ETDs) could deploy unexpectedly or fail to activate in an accident.	<ul style="list-style-type: none">▶ Drive with added caution to the nearest authorized Mercedes-Benz Center.



Warning!



In the event a malfunction of the SRS is indicated as outlined above, the SRS may not be operational. For your safety, we strongly recommend that you visit an authorized Mercedes-Benz Center immediately to have the system checked. Otherwise the SRS may not be activated when needed in an accident, which could result in serious or fatal injury, or it might deploy unexpectedly and unnecessarily which could also result in an accident and/or injury to you or to others.

Practical hints

What to do if ...

Problem	Possible cause	Suggested solution
 (Canada only)  (USA only)	The red brake warning lamp comes on while driving and you hear a warning sound.	▶ Release the parking brake (▷ page 42).
	The red brake warning lamp comes on while driving.	▶ Risk of accident! Carefully stop the vehicle and notify an authorized Mercedes-Benz Center. Do not add brake fluid! This will not solve the problem.

Warning!





Driving with the brake warning lamp illuminated can result in an accident. Have your brake system checked immediately if the brake warning lamp stays on. Don't add brake fluid before checking the brake system. Overfilling the brake fluid reservoir can result in spilling brake fluid on hot engine parts and the brake fluid catching fire. You can be seriously burned.



If you find that the brake fluid in the brake fluid reservoir has fallen to the minimum mark or below, have the brake system checked for brake pad thickness and leaks.



Practical hints

What to do if ...

Problem	Possible cause	Suggested solution
 The yellow "CHECK ENGINE" malfunction indicator lamp comes on while driving.	There is a malfunction in: <ul style="list-style-type: none"> • The fuel management system • The ignition system • The emission control system • Systems which affect emissions Such malfunctions may result in excessive emissions values and may switch the engine to its limp-home (emergency operation) mode.	► Have the vehicle checked as soon as possible by an authorized Mercedes-Benz Center. An on-board diagnostic connector is used by the service station to link the vehicle to the shop diagnostics system. It allows the accurate identification of system malfunctions through the readout of diagnostic trouble codes. It is located in the passenger compartment near the engine hood release.
	The fuel cap is not closed tight.	► Check the fuel cap.
	Your gas tank is empty.	► After refuelling, start the engine three or four times in succession. The limp-home mode is canceled. You do not need to have your vehicle checked.
 The red seat belt warning lamp illuminates for a brief period after starting the engine.	The warning lamp reminds you to fasten seat belts.	► Fasten your seat belt.

Practical hints

What to do if ...

Problem	Possible cause	Suggested solution
 The red telescoping steering column* warning lamp remains lit after starting the engine.	The adjustable steering column is not locked properly.	<ul style="list-style-type: none"> ▶ Lock the steering column (▷ page 34).
 The yellow low windshield and headlamp* washer system fluid level warning lamp remains lit after starting the engine or lights up while driving.	The fluid level has dropped to about $\frac{1}{3}$ of total reservoir capacity.	<ul style="list-style-type: none"> ▶ Add washer fluid (▷ page 184).
 The yellow low engine oil level warning lamp remains lit after starting the engine or comes on while driving.	The engine oil level has sunk to the minimum level.	<ul style="list-style-type: none"> ▶ Check the engine oil level (▷ page 175) and add oil as required (▷ page 179). ▶ If you must add engine oil frequently, have the engine checked for possible leaks.

When the low engine oil level warning lamp does not go out after starting the engine, or comes on while the engine is running and at operating temperature, the engine oil level has dropped to approximately the minimum mark on the dipstick.

When this occurs, the warning lamp will first come on intermittently and then stay on if the oil level drops further.

If no oil leaks are noted, continue to drive to the nearest service station where the engine oil should be topped to the “full” mark on the dipstick with an approved oil.



The low engine oil level warning light should not be ignored. Extended driving with the light illuminated could result in serious engine damage that is not covered by the Mercedes-Benz Limited Warranty.

Practical hints

What to do if ...

Problem	Possible cause	Suggested solution
The fuel reserve and fuel cap placement warning lamp: <ul style="list-style-type: none"> lights up while driving blinks 	The fuel level has gone below the reserve mark.	▶ Refuel at the next gas station (▷ page 171).
	The fuel cap is not closed tight.	▶ Check the fuel cap.
	A fuel system leak has been detected.	▶ Have the fuel system checked as soon as possible by an authorized Mercedes-Benz Center
 The yellow low engine coolant level warning lamp remains lit after starting the engine or lights up while driving.	The coolant level is too low.	▶ Add coolant (▷ page 180). ▶ If you have to add coolant frequently, have the cooling system checked by an authorized Mercedes-Benz Center.

Warning!



Do not spill antifreeze on hot engine parts. Antifreeze contains ethylene glycol which may burn if it comes into contact with hot engine parts. You can be seriously burned.



Do not ignore the low engine coolant level warning light. Extended driving with the light illuminated may cause serious engine damage not covered by the Mercedes-Benz Limited Warranty.

Do not drive without sufficient amount of coolant in the cooling system. The engine will overheat, causing major engine damage.



Practical hints

What to do if ...

Problem	Possible cause	Suggested solution
 The red charge indicator lamp lights up while the engine is running.	The battery was charged with a battery charger or jump started.	▶ Have the battery checked at a service station.
	The battery is no longer charging. Possible causes: <ul style="list-style-type: none">• alternator malfunctioning• broken poly-V-belt	▶ Stop immediately and check the poly-V-belts. If one is broken: ▶ Do not continue to drive. Otherwise the engine will overheat due to an in-operative water pump which may result in damage to the engine. Notify an authorized Mercedes-Benz Center. If it is intact: ▶ Drive immediately to the nearest authorized Mercedes-Benz Center. Adjust driving to be consistent with reduced braking responsiveness.

Practical hints

What to do if ...

Problem	Possible cause	Suggested solution
 The yellow brake pad wear indicator lamp lights up while braking.	The brake pads have reached their wear limit.	▶ Have the brake pads replaced as soon as possible.
 The yellow exterior lamp failure indicator lamp lights up while applying the brake and stays on until the engine is turned off.	One of the brake lamps is malfunctioning.	▶ Replace the bulb as soon as possible (▷ page 226).
 The yellow exterior lamp failure indicator lamp remains lit after starting the engine or lights up while driving.	One of the following lamps is malfunctioning: <ul style="list-style-type: none"> • parking lamp • tail lamp • brake lamp • low beam head lamp 	▶ Replace the bulb as soon as possible (▷ page 226).



Brake pad thickness must be visually checked by a qualified technician at the intervals specified in the Service booklet.



Additional lighting equipment, if not properly installed (e.g. auxiliary headlamps etc.), could cause the failure indicator monitoring unit to malfunction. We therefore recommend that an authorized Mercedes-Benz Center install such equipment for you.









If an exterior lamp fails, the indicator lamp will come on only when that lamp is switched on.



Practical hints

What to do if ...

Additional indicators in the speedometer display

Display	Possible cause	Suggested solution
	Perform minor service (A) (▷ page 190).	▶ Visit an authorized Mercedes-Benz Center to perform service.
	Perform major service (B) (▷ page 190).	▶ Visit an authorized Mercedes-Benz Center to perform service.
 1000	Perform service (A) or (B) after calculated distance remaining in miles (km) (▷ page 190). For example: Service in 1000 miles (km).	▶ Visit an authorized Mercedes-Benz Center to perform service.
 10	Perform service (A) or (B) after calculated remaining time in days (▷ page 190). For example: Service in 10 days.	▶ Visit an authorized Mercedes-Benz Center to perform service.
 Start  Error The Start message lights up in addition to the Error message.	The immobilizer is not operational.	▶ Contact an authorized Mercedes-Benz Center or call 1-800-FOR-MERCEdes (in the USA), or 1-800-387-0100 (in Canada).

Lamp in center console

Problem	Possible cause	Suggested solution
 The indicator lamp lights up.	A BabySmart™ child seat is installed on the passenger seat. Therefore the front passenger airbag is switched off.	
	The system is malfunctioning when there is no BabySmart™ child seat installed on the passenger seat.	<ul style="list-style-type: none"> ▶ Have the system checked as soon as possible by an authorized Mercedes-Benz Center.
 The indicator lamp does not light up when a BabySmart™ child seat is properly installed on the front passenger seat.	The system is malfunctioning.	<ul style="list-style-type: none"> ▶ Make sure there is nothing between seat cushion and child seat and check installation of the child seat. ▶ If the light remains out, have the system checked as soon as possible by an authorized Mercedes-Benz Center. <p>Do not use the BabySmart™ restraint to transport children on the passenger seat until the system has been repaired.</p>

Practical hints

Where will I find ...?

▼ Where will I find ...?

First aid kit

The first aid kit is located on the left side of the trunk.



① First aid kit

- ▶ Loosen the fastening strap.
- ▶ Remove first aid kit ①.



Check expiration dates and contents for completeness at least once a year and replace missing/expired items.

Vehicle tool kit, vehicle jack

The following is included:

- Towing eye bolt
- Wheel wrench
- Alignment bolt
- Wheel bolts
- Special fuse puller
- Vehicle jack

Vehicle jack

Warning!



The jack is designed exclusively for jacking up the vehicle at the jack tubes built into either side of the vehicle. To help avoid personal injury, use the jack only to lift the vehicle during a wheel change. Never get beneath the vehicle while it is supported by the jack. Keep hands and feet away from the area under the lifted vehicle.

Always firmly set parking brake and block wheels before raising vehicle with jack.

Do not disengage parking brake while the vehicle is raised. Be certain that the jack is always vertical (plumb line) when in use, especially on hills. Always try to use the jack on level surface. Make sure the jack arm is fully inserted in the jack tube. Always lower the vehicle onto sufficient capacity jackstands before working under the vehicle.

The jack is exclusively designed for lifting the vehicle during a wheel change. Always lower the vehicle on sufficient capacity jackstands before working under the vehicle.

Spare wheel (SLK 230 Kompressor, SLK 320)

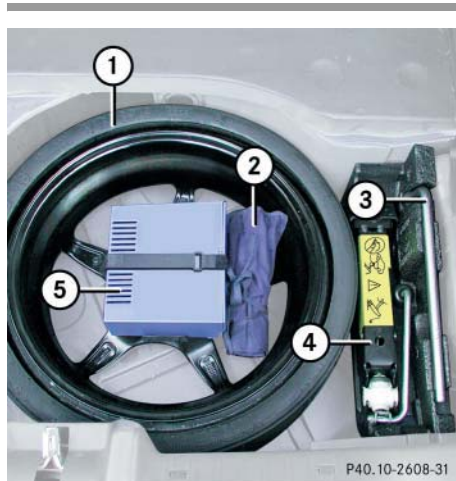

- ① Spare wheel with collapsible tire
- ② Vehicle tool kit
- ③ Wheel wrench
- ④ Jack
- ⑤ Electric air pump, bolts for spare wheel rim

Sparewheel, vehicle tool kit, wheel wrench, jack and electric air pump are located under the trunk floor cover.

- ▶ Lift trunk floor cover.

You can take out vehicle tool kit ②, wheel wrench ③ and jack ④.

Electric air pump ⑤ is secured with a belt.

- ▶ Loosen the belt.
- ▶ Remove electric air pump from pump holder.

Spare wheel ① is secured with the pump holder.

- ▶ Turn pump holder counterclockwise.
- ▶ Remove pump holder.
- ▶ Remove spare wheel out of the wheel well.

Practical hints

Where will I find ...?

Spare wheel bolts

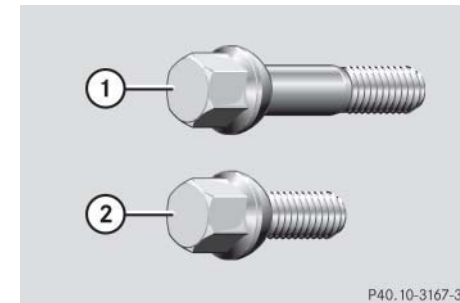

Wheel bolts

① Wheel bolt for

- wheel rim size 7 J x 16 H2 and 8 J x 16 H2
- AMG wheel rim size 7½ J x 17 H2 and 8½ J x 17 H2
- spare wheel rim size 4.5 B x 16 H2

② Wheel bolt for

- spare wheel rim size 4.5 B x 15 H2 (located with electric air pump)

Practical hints

Where will I find ...?



Wheel bolts ② must be used when mounting spare wheel rim size 4.5 B x 15 H2.

The use of any wheel bolts other than wheel bolts ② for spare wheel rim size 4.5 B x 15 H2 can cause physical damage to the vehicle.

Warning!



Make sure to use original length wheel bolts when remounting the original wheel after it has been repaired.

More information can be found in the "Technical data" section (▷ page 263).

TIREFIT kit (SLK 32 AMG only)

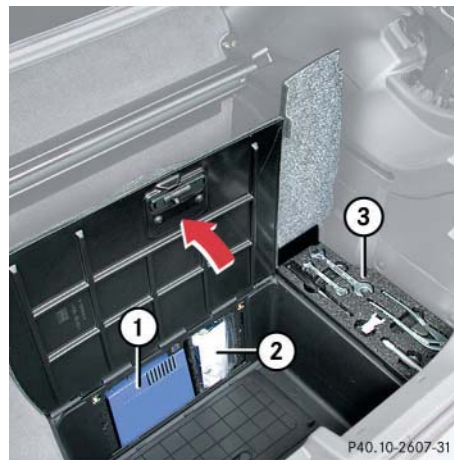

- ① Electric air pump
- ② TIREFIT kit
- ③ Vehicle tool kit, jack, wheel wrench

The electric air pump and TIREFIT kit are located in the storage box under the trunk floor cover.

The vehicle tool kit, jack and wheel wrench are located below the rug on the right side.

- ▶ Lift trunk floor cover.
- ▶ Open storage box cover.

You can take out vehicle tool kit ③ and accessories.

- ▶ Pull down the flap on the storage box.
- ▶ Remove electric air pump ① and TIREFIT kit ②.

Practical hints

Where will I find ...?

Vehicles with TIREFIT kit (SLK 32 AMG) and CD changer* in trunk



- ① Storage box cover
- ② CD changer*

The vehicle tool kit, jack and wheel wrench are located underneath the CD changer ②.

- ▶ Lift trunk floor cover.
- ▶ Open storage box cover ①.



③ Latch

- ▶ Slide latch ③ forward to disengage storage box.
- ▶ Remove storage box.

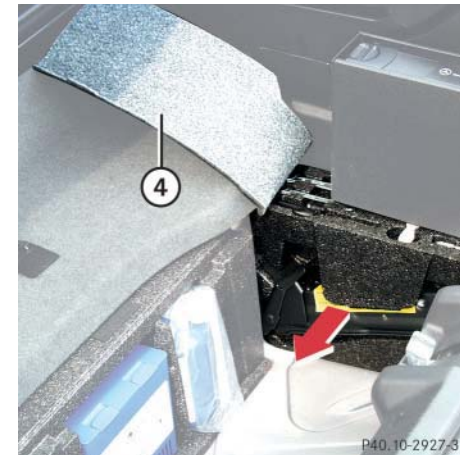

④ Carpet cover

- ▶ Slide small carpet cover ④ from underneath the CD changer* ② and flip backwards for easier access to tool kit, jack and wrench.
- ▶ Slide out tool kit and jack in the direction of arrow. The wheel wrench is located behind the tool kit and jack.

Practical hints

Unlocking/locking in an emergency

▼ Unlocking/locking in an emergency

Unlocking the vehicle

Unlocking the driver's door

If you are unable to unlock the driver's door with the remote control, open the door using the key as follows:

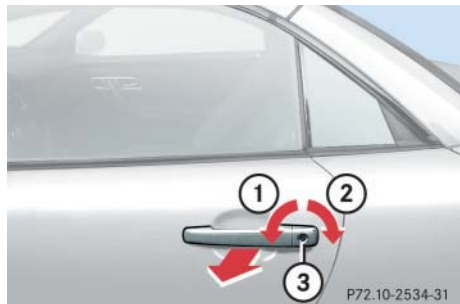



- ① Unlocking
- ② Locking
- ③ Driver's door lock

- ▶ Remove protective cap ③ from driver's door lock.
- ▶ Unlock the door with the key. To do so, push key into the lock until it stops and turn it to the left ①.



Unlocking your vehicle with the key will trigger the anti-theft alarm system. To cancel the alarm, do one of the following:

- Press button  or  on the remote control.
- Insert the key in the steering lock and turn it to position 1.



Using the key does not operate the central locking system.

Unlocking the trunk

A minimum height clearance of 5.97 ft (1.82 m) is required to open the trunk lid.

If you are unable to unlock the trunk with the remote control, open the trunk using the key.

The lock is located next to the recessed handle.

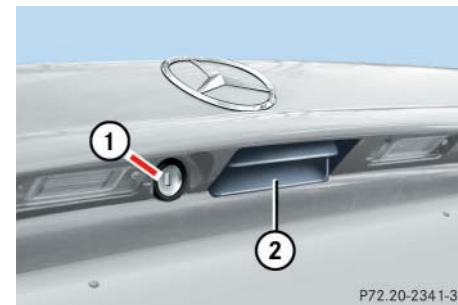

- ① Unlocking in an emergency
- ② Handle



- ▶ Insert the mechanical key into the trunk lid lock.
- ▶ Turn the mechanical key counterclockwise to position ① and hold it in this position.
- ▶ Pull trunk lid handle ② and lift the trunk lid.



Always make sure there is sufficient overhead clearance.



Unlocking your vehicle with the key will trigger the anti-theft alarm system. To cancel the alarm, do one of the following:

- Press button  or  on the key.
- Insert the key in the steering lock and turn it to position 2.

Locking the vehicle

If you are unable to lock the vehicle with the remote control, lock it with the key as follows:

- ▶ Close the passenger door and the trunk lid.
 - ▶ Press the central locking switch in the upper center console (▷ page 79).
 - ▶ Check to see whether the locking knob on the passenger door is still visible. If necessary, push it down manually.
- ▶ Lock the driver's door with the key. To do so, push key into the lock until it stops and turn it to the right ② (▷ page 216).
 - ▶ Lock the trunk, if necessary with the key. To do so, push key into the trunk lid lock until it stops and turn it to the right.

Practical hints

Unlocking/locking in an emergency

Changing batteries in remote control

If the batteries in the remote control are discharged, the vehicle can no longer be locked or unlocked. It is recommended to have the batteries replaced at an authorized Mercedes-Benz Center.

Warning!



Keep the batteries out of reach of children.

If a battery is swallowed, seek medical help immediately.

Batteries contain materials that can harm the environment if disposed of improperly. Recycling of batteries is the preferred method of disposal. Many states require sellers of batteries to accept old batteries for recycling.



When changing batteries, always replace both batteries.

When changing batteries, make sure new batteries are clean and free of lint.

The required replacement batteries are available at any Mercedes-Benz Center.

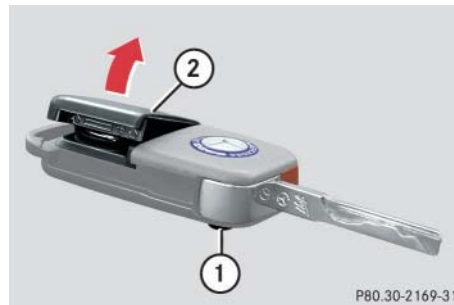

① Release button for key

② Battery cover

Replacement batteries: Lithium, type CR 2025 or equivalent.

► Press release button ① on the remote control.

The key folds out.

► Pull off battery cover ② in direction of arrow.

► Remove the batteries.



► Insert new batteries with the plus (+) side facing up.



► Press battery cover onto housing until it engages.



Afterwards, test the remote control to see if it is functioning properly. If you still cannot lock or unlock the vehicle, synchronize the remote control (> page 219).

Synchronizing remote control

If you are unable to lock or unlock the vehicle with the remote control, the remote control may have to be resynchronized.

- ▶ Aim transmitter eye at vehicle and briefly press transmit button  or  twice.
- ▶ Within approximately 30 seconds insert key in steering lock and turn it to position **2** (▷ page 29).

The remote control should once again be operational.

If the remote control is still malfunctioning, contact an authorized Mercedes-Benz Center.

Fuel filler flap

In case the central locking system does not release the fuel filler flap, you can open it manually.

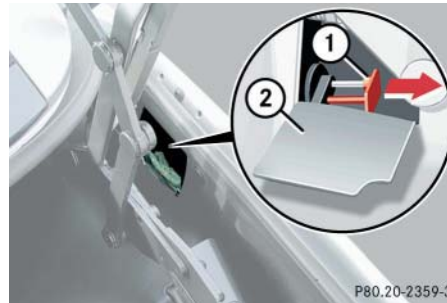

- ① Release knob
- ② Cover

- ▶ Open the trunk lid.
- ▶ Open cover ② in the right side trunk panel.
The cover is located behind the trunk lid hinge.
- ▶ Pull release knob ① in the direction of arrow.
The fuel filler flap is opened simultaneously.

Practical hints

Unlocking/locking in an emergency

Manually unlocking the transmission selector lever

In the case of power failure, the transmission selector lever can be manually unlocked, e.g. to tow the vehicle.

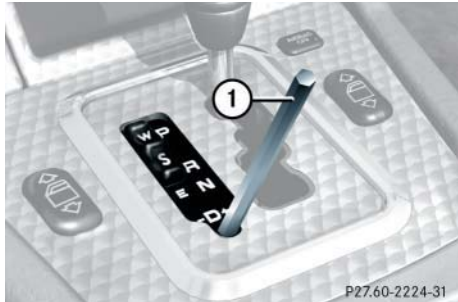

① Pin

- ▶ Insert a pin ①, e.g. ball point pen, into the covered opening below position **D** of the shift pattern.

- ▶ Perform the following two steps simultaneously:

- ▶ Push pin ① down.
 - ▶ Move selector lever from position **P**.
- ▶ Remove pin ①.

The cover returns to its closed position after moving the selector lever to positions **D+** and **D-**.



The selector lever is locked again when moving it to position **P**.

▼ **Opening/closing in an emergency**

Raising retractable hardtop manually

If the retractable hardtop cannot be closed automatically, make certain that all points listed under the “Retractable hardtop” section (▷ page 130) were observed.

If the automatic operation still does not function properly, you can close the retractable hardtop manually.

This procedure should be performed with great care by two persons.



Manually closing the retractable hardtop is a complicated and technically demanding procedure. Close the retractable hardtop manually in emergency cases only. Otherwise, visit an authorized Mercedes-Benz Center.

Warning!



- It is important that a second person helps you. Otherwise, you could become trapped or injured.
- Remove any wristwatches or jewelry such as rings or bracelets. Otherwise, they could get caught in the vehicle mechanism, causing personal injury to yourself or damage to the vehicle.
- Always use the grips provided. Otherwise you could injure yourself.

- ▶ Open doors or lower windows (▷ page 128).
- ▶ Set parking brake (▷ page 47).
- ▶ Remove key from steering lock (▷ page 29).
- ▶ Open trunk lid (▷ page 78).
- ▶ Remove CD changer (▷ page 122).



If your CD changer holder does not have the fasteners ① as shown under “Installing and removing the CD changer*” (▷ page 122), your vehicle may be equipped with a non-factory installed CD changer holder. The holder then does not need to be removed as there should be enough room between the CD changer holder and the right side trim panel in the trunk to remove the cover and gain access to the screw for hydraulic pump should you need to raise the retractable hardtop manually.

- ▶ Open the right side trim panel in the trunk. Remove cover, if necessary. ▷▷

Practical hints

Opening/closing in an emergency

▷▷

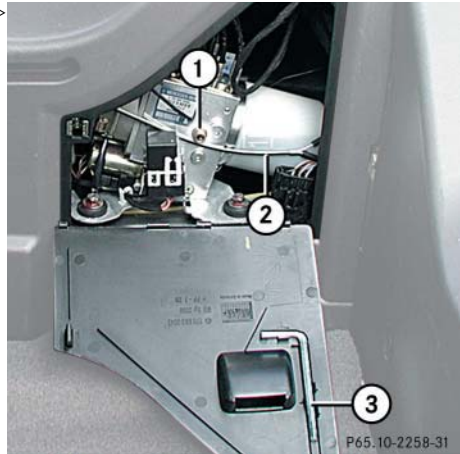

- ① Screw of hydraulic pump
- ② Control cable, right
- ③ Hex-socket wrench

- ▶ Remove hex-socket wrench ③ from cover.
- ▶ Using wrench ③ turn screw ① of the hydraulic pump counterclockwise as far as it will go.



Vehicles with factory-installed CD changer:

Guide hex-socket wrench through the available opening in the CD changer holder to access and turn the screw of the hydraulic pump.



Do not operate the hardtop switch with screw ① in opened position, otherwise the hydraulic pump could be damaged.

- ▶ Keep wrench with you for later use in closing and locking the retractable hardtop.
- ▶ Pull the loop of right control cable ② out of the opening.
- ▶ Remove first aid kit (▷ page 212).
- ▶ Open the left side trim panel in the trunk.

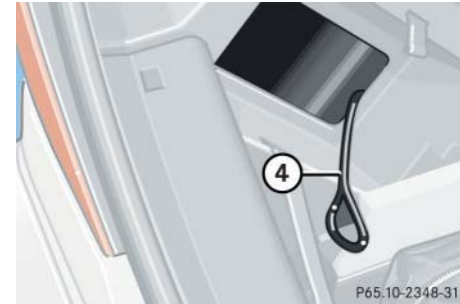

④ Control cable, left

- ▶ Pull the loop of left control cable ④ out of the opening.



If you cannot find the control cable, carefully insert a finger into the opening to feel for the cable.

Warning!



At this point, the remaining procedure needs to be done by two people. Otherwise you could be injured.

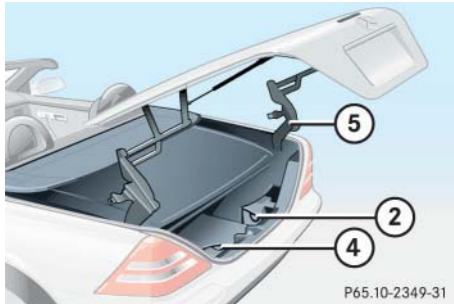

- ② Control cable, right
- ④ Control cable, left
- ⑤ Hinge

- ▶ Complete the following steps simultaneously:

First person:

- ▶ Pull on control cables ② and ④ at the same time.

With the control cables, you release the catch of the trunk lid.

Second person:

- ▶ Push the trunk lid and hinge ⑤ to the rear.

The trunk lid tilts backward.

Warning!



While doing this, move backwards carefully. Otherwise, you could injure yourself on the trunk lid lock.

Practical hints

Opening/closing in an emergency

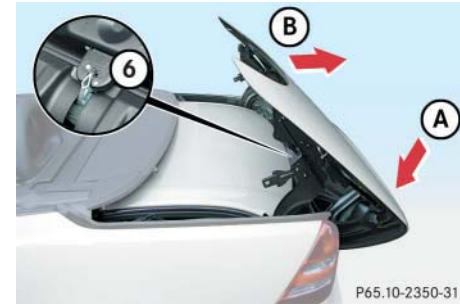

- ⑥ Striker eye

- ▶ Carefully fold down trunk lid in the direction of arrow **A**.

The trunk lid lock engages audibly in striker eye ⑥.

- ▶ Pull the trunk lid as far as it will go in the direction of arrow **B**.



Practical hints

Opening/closing in an emergency



Warning!



Do not place your hands near the upper windshield area, trunk lid, or between roof panels while the retractable hardtop is being raised and locked. Serious personal injury may occur.



⑦ Bottom half of retractable hardtop

- ▶ One person should stand on the left side of the vehicle and the other on the right side.

- ▶ At the same time, reach from each side of the trunk underneath the bottom half of retractable hardtop ⑦.
- ▶ In a smooth motion, pull up on the retractable hardtop in the direction of the arrow until the bottom half of the retractable hardtop is standing vertically.

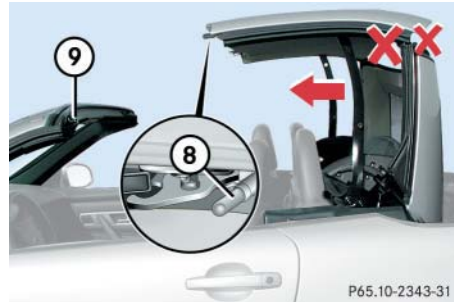

⑧ Pins for the retractable hardtop locking mechanism

⑨ Holes for the pins

- ▶ Complete the next steps simultaneously. One person should stand on the left side of the vehicle and the other on the right side.
- ▶ Move the retractable hardtop with one hand in the direction of the arrow.
- ▶ With the other hand, guide pins ⑧ belonging to the retractable hardtop locking mechanism into corresponding holes ⑨ located in the upper edges of the windshield.

Warning!



Do not place your hands in areas marked X. Serious personal injury may occur.

Practical hints

Opening/closing in an emergency

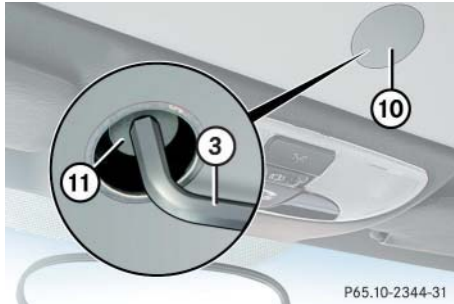

- ③ Hex-socket wrench
- ⑩ Protective cap
- ⑪ Screw for the retractable hardtop locking mechanism

- ▶ Take off protective cap ⑩ on the inner side of the retractable hardtop.
- ▶ Turn the retractable hardtop's locking mechanism screw ⑪ with hex-socket wrench ③ clockwise as far as it will go. The screw will be difficult to turn.

The clasp will open and the retractable hardtop will engage audibly.

- ▶ Turn the retractable hardtop's locking mechanism screw ⑪ with hex-socket wrench ③ counterclockwise as far as it will go.

The retractable hardtop will be locked.

- ▶ Put protective cap ⑩ back into the opening and press down on it firmly.



- ▶ Place flat hands near edges (arrows) and close trunk lid.

i

After you have closed the retractable hardtop manually, you can no longer

- lock the trunk lid
- close the rear quarter windows

The trunk lid will also no longer seal properly.

Have the retractable hardtop operation checked at your authorized Mercedes-Benz Center as soon as possible.

Practical hints

Replacing bulbs

▼ Replacing bulbs

Safe vehicle operation depends on proper exterior lighting and signaling. It is therefore essential that all bulbs and lamp assemblies are in good working order at all times.

Correct headlamp adjustment is extremely important. Have headlamps checked and readjusted at regular intervals and when a bulb has been replaced. See your authorized Mercedes-Benz Center for headlamp adjustment (▷ page 231).

Bulbs

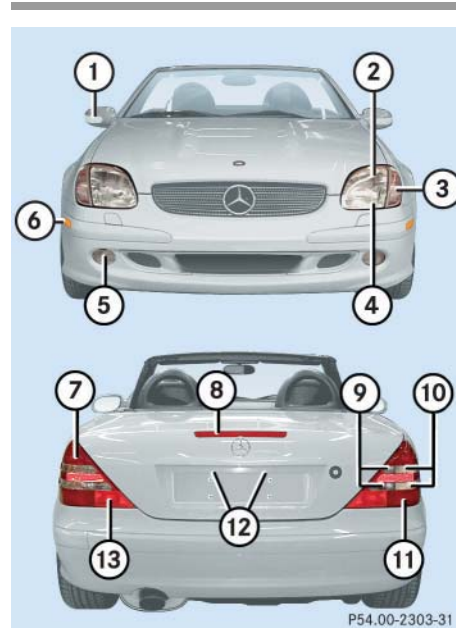

Front lamps

Lamp	Type
① Additional turn signal lamps	LED
② Low beam headlamps	H7 (55 W) Xenon* D2R-35 W ¹
③ Parking, standing and turn signal lamps	2357 NA
④ High beam headlamps	H7 (55 W)
⑤ Fog lamp	HB4 (55 W)
⑥ Side marker lamps	W 5 W

¹ Vehicles with Xenon headlamps* do not replace the Xenon bulbs yourself.

Practical hints

Replacing bulbs

Rear lamps

	Lamp	Type
⑦	Brake lamp	1154/32 cp
⑧	High mounted brake lamp	LED
⑨	Backup lamp	1154/32 cp
⑩	Turn signal lamp	1156 NA
⑪	Tail, parking, standing and side marker lamp	67/4 cp
⑫	License plate lamps	C 5 W
⑬	Rear fog lamp, driver's side	1155/32 cp

Notes on bulb replacement

Warning!



Keep bulbs out of reach of children.

Bulbs and bulb sockets can be very hot. Allow the lamp to cool down before changing a bulb.

Halogen lamps contain pressurized gas. A bulb can explode if you:

- touch or move it when hot
- drop the bulb
- scratch the bulb

Wear eye and hand protection.

Because of high voltage in xenon lamps, it is dangerous to replace the bulb or repair the lamp and its components. We recommend that you have such work done by a qualified technician.

- Use only 12-volt bulbs of the same type and with the specified watt rating.
- Switch lights off before changing a bulb to prevent short circuits.
- Always use a clean lint-free cloth when handling bulbs.
- Your hands should be dry and free of oil and grease.
- If the newly installed bulb does not light up, visit an authorized Mercedes-Benz Center.
- Have the LEDs and bulbs for the following lamps replaced by an authorized Mercedes-Benz Center.
 - Additional turn signals in the exterior rear view mirrors
 - High mounted brake lamp
 - Xenon* lamps
 - Front fog lamps

Practical hints

Replacing bulbs

Replacing bulbs for front lamps

Low and high beam headlamps (Halogen headlamps only)

- ▶ Switch off the lights.
- ▶ Open the hood (▷ page 174).

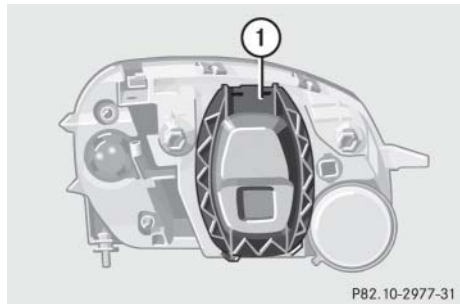

- ① Headlamp cover with locking tab
- ▶ Push down locking tab at top and end of headlamp cover ① and remove.

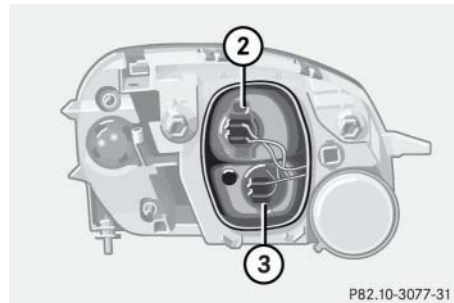

- ② Electrical connector for low beam headlamp bulb
- ③ Electrical connector for high beam headlamp bulb
- ▶ Pull off electrical connector ② or ③.
- ▶ Unhook clamping ring and pull out the bulb together with clamping ring.
- ▶ Remove bulb.
- ▶ Insert new bulb so that bulb sits properly in cutouts of bulb socket.
- ▶ Mount clamping ring and reinstall.
- ▶ Plug electrical connector onto the bulb.
- ▶ Reinstall headlamp cover ①.

Low and high beam headlamps (Xenon* headlamps only)

Warning!



Do not remove the cover for the xenon headlamp. Because of high voltage in xenon lamps, it is dangerous to replace the bulb or repair the lamp and its components. We recommend that you have such work done by a qualified technician.

Parking, standing and turn signal lamp

- ▶ Switch off the lights.
- ▶ Open the hood (▷ page 174).



- ① Release opening
- ▶ Insert the screwdriver from the vehicle tool kit into release opening ①.
- ▶ Press the top of the screwdriver toward the middle of the vehicle and toward the rear.

The turn signal lamp will be lifted out.

- ▶ Pull the turn signal lamp slightly out of its mounting.
- ▶ Pull off the electrical connector from the turn signal lamp.
- ▶ Take the turn signal lamp completely out of its mounting.
- ▶ Twist bulb socket counterclockwise and pull out.
- ▶ Gently push bulb into socket, turn counterclockwise and remove.
- ▶ Insert new bulb in socket, push in and twist clockwise.
- ▶ Reinstall bulb socket, push in and twist clockwise.
- ▶ Plug electrical connector back into the turn signal lamp.

Practical hints

Replacing bulbs

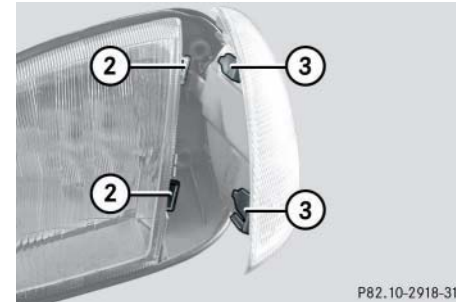

- ② Guides
- ③ Tabs

- ▶ Slide the turn signal lamp with tabs ③ into guides ② and press it toward the rear into the mounting until it engages.

Practical hints

Replacing bulbs

Side marker lamp bulb

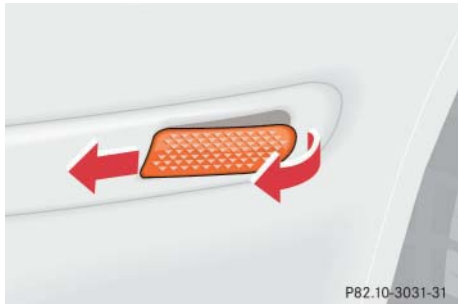

- ▶ Switch off the lights.
- ▶ Carefully slide lamp towards front.
- ▶ Remove rear end first.
- ▶ Twist bulb socket counterclockwise and pull out.
- ▶ Gently push bulb into socket, turn counterclockwise and remove.
- ▶ Insert new bulb in socket, push in and twist clockwise.

- ▶ Reinstall bulb socket, push in and twist clockwise.
- ▶ To reinstall lamp, set rear end in bumper and let front end snap into place.

Replacing bulbs for rear lamps

Tail lamp assemblies

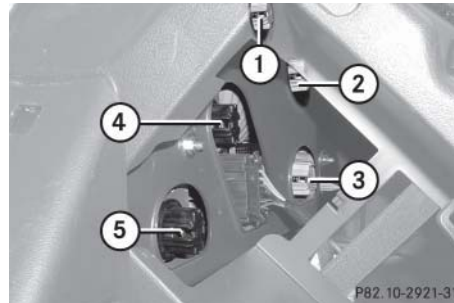

- ① Brake lamp
- ② Turn signal lamp
- ③ Tail, parking and standing lamp, side marker
- ④ Backup lamp
- ⑤ Rear fog lamp (driver's side)

- ▶ Switch off the lights.
- ▶ Open trunk lid (▷ page 78).
- ▶ Remove cover in right side panel.
- ▶ Remove first aid kit (▷ page 212).
- ▶ Remove cover in left side panel.
- ▶ Turn bulb socket counterclockwise and pull out.
- ▶ Gently push bulb into socket, turn counterclockwise and remove.
- ▶ Insert new bulb in socket, push in and turn clockwise.
- ▶ Reinstall bulb socket, push in and turn clockwise.
- ▶ Close cover.

Practical hints

Replacing bulbs

License plate lamp

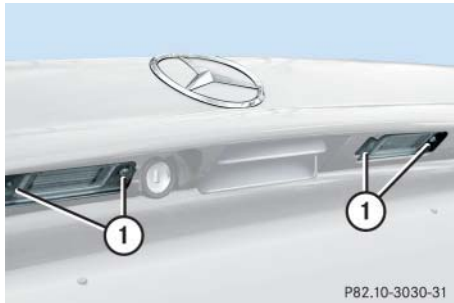

① Screws

- ▶ Switch off the lights.
- ▶ Loosen both screws ① and remove lamp.
- ▶ Replace the tubular lamp and reinstall lamp.
- ▶ Retighten the screws.

Adjusting headlamp aim (Halogen headlamps only)



Low beam adjustments simultaneously aim the high beam.

Vehicle should have a normal trunk load.

Vertical aim adjustments change horizontal aim.

Correct headlamp adjustment is extremely important. Have the adjustment checked regularly by an authorized Mercedes-Benz Center.

To check and readjust a headlamp, follow the steps described:

- ▶ Park vehicle on level surface.
- ▶ Open hood (▷ page 174).

Vertical headlamp aim

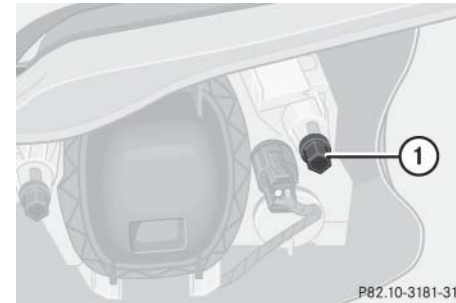

① Headlamp vertical adjusting screw

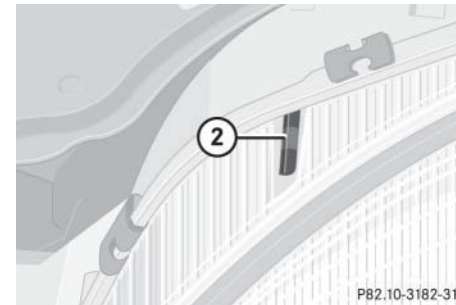

② Level



Practical hints

Replacing bulbs

- ▶▶ Turn adjusting screw ① (counterclockwise to adjust headlamp downward, clockwise upward) until bubble in level ② is centered on the "0" mark. Graduations: 0.18° pitch

Horizontal headlamp aim



- ③ Headlamp horizontal adjusting screw

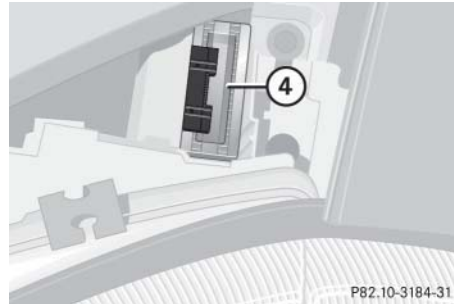

- ④ Sight glass
- ▶ Turn adjusting screw ③ (counterclockwise to adjust headlamp to the left, clockwise to the right) until indicator ④ in the sight glass is in line with the "0" mark.

▼ Replacing wiper blades

Removing wiper blades

Warning!



For safety reasons, remove key from steering lock before replacing a wiper blade, otherwise the motor could suddenly turn on and cause injury.

- ▶ Fold the wiper arm forward.

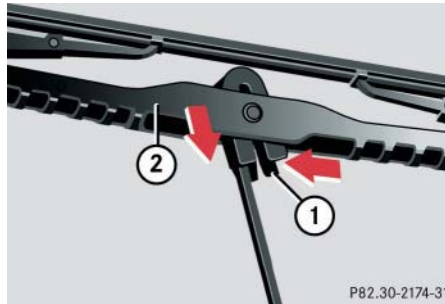

- ▶ Press safety tab ① down.
- ▶ Push wiper blade ② downward and remove.

Practical hints

Replacing wiper blades

Replacing wiper blade insert

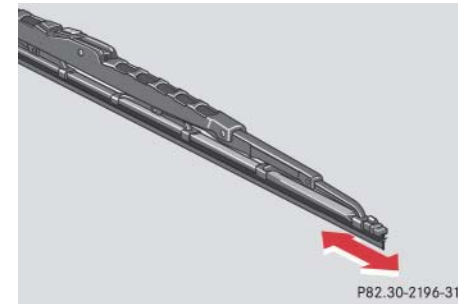

- ▶ Place wiper blade on firm support.
- ▶ Press down both tabs.
- ▶ Slide (in direction of arrow) the wiper blade insert out of the retainer claws.
- ▶ Slide (in direction of arrow) the new wiper blade insert into retainer claws until tabs are engaged.

Practical hints

Replacing wiper blades

Installing wiper blades

- ▶ Slide the wiper blade onto wiper arm until it locks in place.
- ▶ Rotate the wiper blade into position parallel to wiper arm.
- ▶ Fold the wiper arm back to rest on the windshield. Make sure you hold on to the wiper when folding the wiper arm back.



Never open the hood when the wiper arms are folded forward.

Hold on to the wiper when folding the wiper arm back. If released, the force of the impact from the tensioning spring could crack the windshield.

Do not allow the wiper arms to contact the windshield glass without a wiper blade inserted.

Make certain that the wiper blades are properly installed. Improperly installed wiper blades may cause windshield damage.

For your convenience, we recommend that you have this work carried out by an authorized Mercedes-Benz Center.

▼ Flat tire

Your vehicle is equipped with a TIREFIT kit (SLK 32 AMG only) (▷ page 2 14) or a spare wheel with collapsible tire (SLK 230 Kompressor and SLK 320 only) (▷ page 2 13).

You can identify which TIREFIT kit (SLK 32 AMG only) you have as follows:

- The TIREFIT container of kit 1 is a squeeze container.
- The TIREFIT container of kit 2 is a rigid container and includes a flange for filler hose (outlet) and air hose (inlet).

Preparing the vehicle

- ▶ Park the vehicle as far as possible from moving traffic on a hard surface.
- ▶ Turn on hazard warning flasher.
- ▶ Engage the steering wheel lock in the straight ahead position and set the parking brake.
- ▶ Move the selector lever to **P** (manual transmission to first or reverse gear).

- ▶ Have any passenger exit the vehicle at a safe distance from the roadway.

Sealing tires with TIREFIT kit 1

Warning!



Keep TIREFIT away from sparks, open flame or heat source.

Do not smoke.

Small tire punctures, only those in the tread, can be sealed with TIREFIT. TIREFIT can be used in ambient temperatures down to -4°F (-20°C).

The TIREFIT kit stored in the trunk (▷ page 2 14) contains the TIREFIT container, a filler hose, a valve stem tool, a valve core and a sticker.

Practical hints

Flat tire

Warning!



TIREFIT is a limited repair device. TIREFIT cannot be used for:

- cuts or punctures larger than approx. 0.16 in (4 mm)
- on a flat tire, or a damaged wheel
- tire damage caused by driving with extremely low tire pressure

Do not drive the vehicle under such circumstances.

Contact your nearest Mercedes-Benz Center for assistance or call Roadside Assistance.

- ▶ Foreign objects (e.g. screws or nails) should not be removed from the tire.
- ▶ Attach the sticker where it will be easily seen by the driver on the instrument cluster.

Practical hints

Flat tire

Preparing TIREFIT

- ▶ Take the TIREFIT kit out of the trunk (▷ page 214).

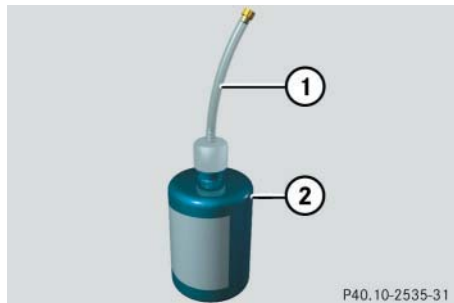

- ① Filler hose
- ② TIREFIT container

- ▶ Shake contents of TIREFIT container ②.
- ▶ Screw hose ① on to TIREFIT container ②.

TIREFIT is now ready for use.

Warning!



Take care not to allow the contents of TIREFIT to come in contact with hair, eyes or clothing. TIREFIT is harmful if inhaled, swallowed or absorbed through the skin. It causes skin, eye and respiratory irritation.

Any contact with eyes or skin should be flushed immediately with plenty of water.

If clothing comes in contact with TIREFIT, change clothing as soon as possible.

In case of allergic reaction or rash, consult a physician immediately.

Warning!



Keep TIREFIT out of reach of children.

If swallowed, rinse mouth immediately with plenty of water and drink plenty of water.

Do not induce vomiting!

Consult a physician immediately.

Keep away from open flame or heat source.

Practical hints

Flat tire

Adding TIREFIT

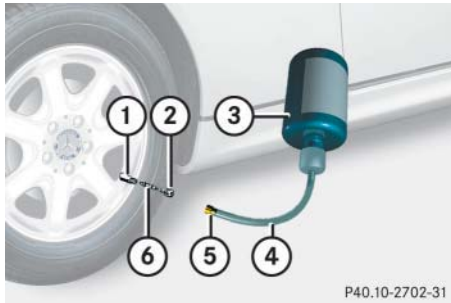

- ① Valve stem
- ② Valve stem tool
- ③ TIREFIT container
- ④ Filler hose
- ⑤ Filler hose plug
- ⑥ Tire valve core

- ▶ Unscrew the valve cap from valve ①.
- ▶ Remove tire valve core ⑥ from valve stem ① using valve stem tool ②. Keep tire valve core ⑥ clean and dry.

- ▶ Remove plug ⑤ from end of hose ④.
- ▶ Push hose ④ onto valve stem ①.
- ▶ Hold TIREFIT container ③ upside down (hose down) and squeeze firmly several times until entire contents of the container are in tire.
- ▶ Pull hose ④ off and screw tire valve core ⑥ tightly into the valve stem ① using valve stem tool ②.



If the removed tire valve core is dirty, use the spare tire valve core stored with the valve stem tool.

- ▶ Reinstall valve cap on valve stem ①.
- ▶ Install plug ⑤ onto end of hose ④.



If sealant has leaked out, let it dry. You can then peel it off.

- ▶ Drive the vehicle back and forth very slowly approximately 30 ft (10 m). This distributes the TIREFIT sealant material inside the tire.
- ▶ Take the electric air pump out of the trunk (> page 214).

Practical hints

Flat tire

Inflating the tire

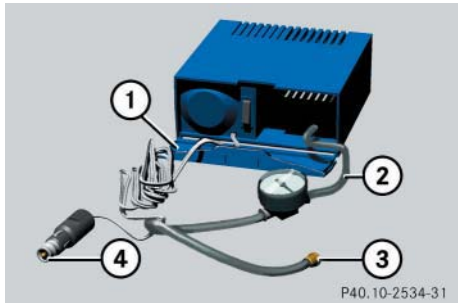

- ① Flap
- ② Air hose with pressure gauge and vent screw
- ③ Union nut
- ④ Electrical plug

Warning!



Observe safety instructions on air pump label.

- ▶ Open flap ① on air pump.
- ▶ Pull out electrical plug ④ and air hose with pressure gauge ②.
- ▶ Screw union nut ③ with air hose ② on to the tire valve.
- ▶ Insert electrical plug ④ into vehicle cigarette lighter socket.
- ▶ Turn key in steering lock to position ① (> page 29).
- ▶ Press **I** on the electric air pump switch.
The electric air pump should now switch on and inflate the tire.

After 5 minutes, the pressure gauge must display at least 26 psi (1.8 bar). The air hose and the union nut can become hot during inflation. Please exercise appropriate caution.



Do not exceed the maximum pressure of 36 psi (2.5 bar).

- ▶ If this tire pressure is not attained, turn off the electric air pump, detach the air hose from the tire valve, and again drive vehicle back and forth very slowly approximately 30 ft (10 m).
This serves to better distribute the TIREFIT sealant material inside the tire.
- ▶ Inflate the tire again.



Do not operate the electric air pump longer than eight minutes without interruption. Otherwise it may overheat.
You may operate the air pump again after it has cooled off.

- ▶ Press **0** on the electric air pump switch.
- ▶ Turn key in steering lock to position **0**.
The electric air pump should now be switched off.

Warning!

If a tire pressure of 26 psi (1.8 bar) is not attained, tire is too severely damaged for TIREFIT to provide a reliable tire repair

In this case, TIREFIT cannot properly seal the tire.

Do not drive the vehicle.

Contact the nearest Mercedes-Benz Center or call Roadside Assistance.

Warning!

To prevent possible injury when unscrewing air pump filler hose from tire valve after inflating the tire, use a rag since the tire valve could be hot.

- ▶ Detach the electric air pump.
- ▶ Reinstall tire valve cap.
- ▶ Store the electrical plug and the air hose behind the flap and place the air pump back into the trunk.
- ▶ Close the trunk lid.
- ▶ Drive away immediately.
The TIREFIT sealant will distribute itself evenly inside the tire.

Warning!

Do not exceed vehicle speed of 50 mph (80 km/h). A TIREFIT repair is not designed to operate at higher speeds.

The sticker must be attached on the instrument cluster where it will be easily seen by the driver.

Vehicle handling characteristics may change. Adapt your driving accordingly.

Practical hints**Flat tire**

- ▶ After driving vehicle for an initial 10 minutes, check tire pressure using the pressure gauge on the air pump.

Warning!

If tire pressure has fallen below 20 psi (1.3 bar), do not continue to drive the vehicle.

Park your vehicle safely away from the roadway and contact the nearest authorized Mercedes-Benz Center or Roadside Assistance.

If tire pressure is at least 20 psi (1.3 bar), inflate tire to correct pressure (see label on fuel filler flap), and drive vehicle to nearest tire repair facility to have tire repaired or replaced.

Recommended duration of use: 300 miles (500 km) at 50 mph (80 km/h) with the recommended tire pressure.

Practical hints

Flat tire

Warning!



Follow recommend tire pressures.

Do not overinflate tires. Overinflating tires can result in sudden deflation (blowout) because they are more likely to become punctured or damaged by road debris, potholes etc.

Do not underinflate tires. Underinflated tires wear unevenly, adversely affect handling and fuel economy, and are more likely to fail from being overheated.

Do not overload the tires by exceeding the specified vehicle capacity weight (as indicated by the label on the driver's door latch post). Overloading the tires can overheat them, possibly causing a blowout.

- ▶ Visit an authorized Mercedes-Benz Center as soon as possible to obtain a new TIREFIT container and/or filler hose.
- ▶ Bring used TIREFIT materials to an authorized Mercedes-Benz Center for proper disposal.
- ▶ Replace your TIREFIT container every four years. Containers are available at your authorized Mercedes-Benz Center.

Sealing tires with TIREFIT kit 2

Warning!



Keep TIREFIT away from sparks, open flame or heat source.

Do not smoke.

Small tire punctures, only those in the tread, can be sealed with TIREFIT. TIREFIT can be used in ambient temperatures down to -4°F (-20°C).

Warning!



Take care not to allow the contents of TIREFIT to come in contact with hair, eyes or clothing. TIREFIT is harmful if inhaled, swallowed or absorbed through the skin. It causes skin, eye and respiratory irritation.

Any contact with eyes or skin should be flushed immediately with plenty of water.

If clothing comes in contact with TIREFIT, change clothing as soon as possible.

In case of allergic reaction or rash, consult a physician immediately.

Warning!



Keep TIREFIT out of reach of children.

If swallowed, rinse mouth immediately with plenty of water and drink plenty of water.

Do not induce vomiting!

Consult a physician immediately.

Keep away from open flame or heat source.

Warning!



TIREFIT is a limited repair device. TIREFIT cannot be used for:

- cuts or punctures larger than approx. 0.16 in (4 mm)
- on a flat tire, or a damaged wheel
- tire damage caused by driving with extremely low tire pressure

Do not drive the vehicle under such circumstances.

Contact your nearest Mercedes-Benz Center for assistance or call Roadside Assistance.

- ▶ Take the TIREFIT kit out of the trunk (▷ page 214).
- ▶ Foreign objects (e.g. screws or nails) should not be removed from the tire.
- ▶ Attach the sticker where it will be easily seen by the driver on the instrument cluster.

Preparing TIREFIT

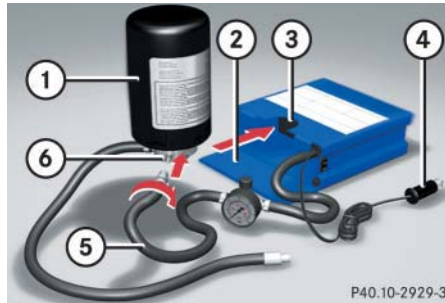

- ① TIREFIT container
- ② Flap
- ③ Notch
- ④ Electrical plug
- ⑤ Air hose
- ⑥ Flange

- ▶ Open flap ② on the electric air pump.
- ▶ Pull plug ④ and air hose ⑤ out of the pump housing.
- ▶ Screw the air pump's air hose ⑤ onto flange ⑥ of the TIREFIT container.

Practical hints

Flat tire

- ▶ Stick TIREFIT container ① upside down into notch ③ of the electric air pump.

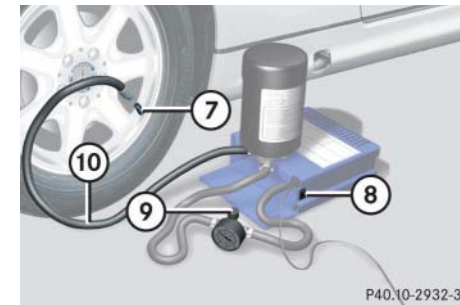

- ⑦ Tire valve
- ⑧ Electric air pump switch
- ⑨ Air hose with pressure gauge and vent screw
- ⑩ Filler hose

Warning!



Observe safety instructions on air pump label.

Practical hints

Flat tire



If sealant has leaked out, let it dry. You can then peel it off.

- ▶ Unscrew the valve cap from tire valve ⑦.
- ▶ Screw filler hose onto tire valve ⑦.
- ▶ Insert electrical plug ④ into vehicle cigarette lighter socket.
- ▶ Turn key in steering lock to position 1 (▷ page 29).
- ▶ Press I on electric air pump switch ⑧.
The electric air pump should now switch on and inflate the tire.



Do not operate the electric air pump longer than eight minutes without interruption. Otherwise it may overheat.

You may operate the air pump again after it has cooled off.

After 5 minutes, the pressure gauge must display at least 26 psi (1.8 bar). The air hose can become hot during inflation. Please exercise appropriate caution.

- ▶ If this tire pressure is not attained, turn off the electric air pump, detach the filler hose from the tire valve, and drive vehicle back and forth very slowly approximately 30 ft (10 m).

This serves to better distribute the TIREFIT sealant material inside the tire.

- ▶ Unscrew the air pump's air hose ⑤ from flange ⑥ of the TIREFIT container.
- ▶ Screw air hose ⑤ onto tire valve ⑦ and inflate the tire again.

Warning!



If a tire pressure of 26 psi (1.8 bar) is not attained, tire is too severely damaged for TIREFIT to provide a reliable tire repair.

In this case, TIREFIT cannot properly seal the tire.

Do not drive the vehicle.

Contact the nearest Mercedes-Benz Center or call Roadside Assistance.

- ▶ After attaining a tire pressure of 26 psi (1.8 bar), press 0 on electric air pump switch ⑧.

The electric air pump should now be switched off.

- ▶ Turn key in steering lock to position 0 (▷ page 29).

- ▶ Detach the electric air pump.
The air hose may still be hot. Please exercise appropriate caution.
- ▶ Store the electrical plug and the air hose behind the flap and place the air pump back in the trunk.
- ▶ Close the trunk lid.
- ▶ Drive away immediately.
The TIREFIT sealant will distribute itself evenly inside the tire.

Warning!



Do not exceed vehicle speed of 50 mph (80 km/h). A TIREFIT repair is not designed to operate at higher speeds.

The sticker must be attached on the instrument cluster where it will be easily seen by the driver.

Vehicle handling characteristics may change. Adapt your driving accordingly.

- ▶ After driving vehicle for an initial 10 minutes, check tire pressure using the pressure gauge on the air pump.

Warning!



If tire pressure has fallen below 20 psi (1.3 bar), do not continue to drive the vehicle.

Park your vehicle safely away from the roadway and contact the nearest authorized Mercedes-Benz Center or Roadside Assistance.

If tire pressure is at least 20 psi (1.3 bar), inflate tire to correct pressure (see label on fuel filler flap), and drive vehicle to nearest tire repair facility to have tire repaired or replaced.

Recommended duration of use:
300 miles (500km) at 50mph (80 km/h) with the recommended tire pressure.

Practical hints

Flat tire

Warning!



Follow recommend inflation pressures.

Do not overinflate tires. Overinflating tires can result in sudden deflation (blowout) because they are more likely to become punctured or damaged by road debris, potholes etc.

Do not underinflate tires. Underinflated tires wear unevenly, adversely affect handling and fuel economy, and are more likely to fail from being overheated.

Do not overload the tires by exceeding the specified vehicle capacity weight (as indicated by the label on the pillar in the driver's door opening). Overloading the tires can overheat them, possibly causing a blowout. ▷▷

Practical hints

Flat tire

- ▶▶ Visit an authorized Mercedes-Benz Center as soon as possible to obtain a new TIREFIT container.
- ▶ Bring used TIREFIT materials to an authorized Mercedes-Benz Center for proper disposal.

Warning!



Do not exceed vehicle speed of 50 mph (80 km/h). A TIREFIT repair is not designed to operate at higher speeds.

The sticker must be attached on the instrument cluster where it will be easily seen by the driver.

Vehicle handling characteristics may change. Adapt your driving accordingly.

- ▶ Replace your TIREFIT container every four years. Replacement containers are available at your authorized Mercedes-Benz Center.

Mounting the spare wheel

More information on spare wheels with collapsible tires can be found in the “Technical data” section (▷ page 273).

Warning!



The dimensions of the spare wheel are different from those of the road wheels. As a result, the vehicle handling characteristics change when driving with a spare wheel mounted. Adapt your driving style accordingly.

The spare wheel is for temporary use only. When driving with spare wheel mounted, ensure proper tire pressure and do not exceed vehicle speed of 50 mph (80 km/h).

Drive to the nearest Mercedes-Benz Center as soon as possible to have the spare wheel replaced with a regular road wheel.

Never operate the vehicle with more than one spare wheel mounted.

Preparing the vehicle

Prepare the vehicle as described under “Preparing the vehicle” (▷ page 235).

- ▶ Turn pump holder counterclockwise to loosen (▷ page 235).
- ▶ Take the spare wheel out of wheel well.

Lifting the vehicle

- ▶ Prevent the vehicle from rolling away by blocking wheels with wheel chocks (not included) or other sizable objects.

When changing wheel on a level surface:

- ▶ Place one chock in front of and one behind the wheel that is diagonally opposite to the wheel being changed.

When changing wheel on a hill:

- ▶ Place chocks on the downhill side blocking both wheels of the other axle.
- ▶ Take the vehicle tool kit and the jack out of the trunk.

Warning!



The jack is designed exclusively for jacking up the vehicle at the jack tubes built into both sides of the vehicle. To help avoid personal injury, use the jack only to lift the vehicle during a wheel change. Never get beneath the vehicle while it is supported by the jack. Keep hands and feet away from the area under the lifted vehicle. Always firmly set parking brake and block wheels before raising vehicle with jack.

Do not disengage parking brake while the vehicle is raised. Be certain that the jack is always vertical (plumb line) when in use, especially on hills. Always try to use the jack on level surface. Make sure the jack arm is fully inserted in the jack tube. Always lower the vehicle onto sufficient capacity jack-stands before working under the vehicle.



- ▶ On wheel to be changed, loosen but do not yet remove the wheel bolts (approximately one full turn with wrench).

The jack support tubes are located behind the front wheel housings and in front of the rear wheel housings.

Practical hints

Flat tire

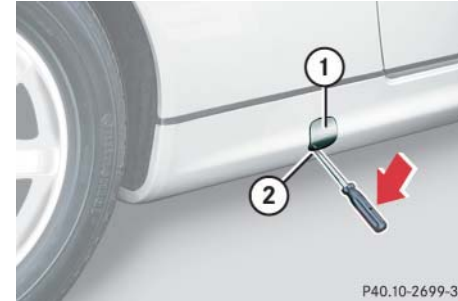

- ① Jack tube cover
- ② Notch

- ▶ Carefully insert the screwdriver (supplied in the tool kit) into notch ②.
- ▶ Pry out cover ① just so far as you can place your fingers underneath the cover.
- ▶ Carefully pull out cover ① completely. Make sure the pins do not brake off.

The cover will be hanging from a plastic band attached to it.

Practical hints

Flat tire

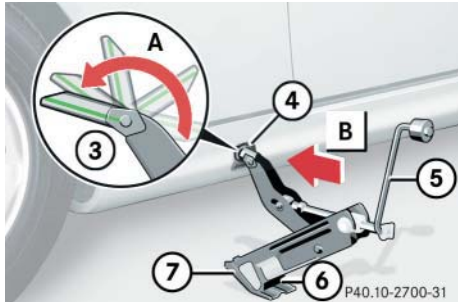

- ③ Jacking pin
- ④ Jack support tube hole
- ⑤ Crank
- ⑥ Small platform
- ⑦ Large platform

- ▶ Fold out jacking pin ③ in direction of arrow **A** until it snaps into place.

The green marking on the jacking pin should now form one line with the marking on the jack.

- ▶ Insert jacking pin ③ in direction of arrow **B** fully into jack support tube hole ④.

Warning!



Insert the jack arm fully into the jack support tube hole up to the stop. Otherwise the vehicle may fall from the jack and cause personal injury or damage to the vehicle.

- ▶ Keeping jack in this position, turn crank ⑤ clockwise until the jack's small platform ⑥ meets the ground. Make sure the jack is always vertical (plumb line).
- ▶ Jack the vehicle until the wheel is a maximum of 1.2 in (3 cm) from the ground.

The jack is now standing on the large platform ⑦.

Never start engine while vehicle is raised.

Removing the wheel

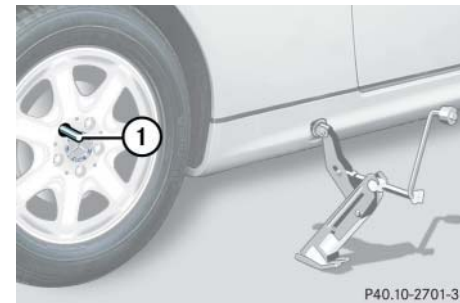

- ① Alignment bolt

- ▶ Unscrew upper-most wheel bolt and remove.
- ▶ Replace this wheel bolt with alignment bolt ① supplied in the tool kit.
- ▶ Remove the remaining bolts.



Do not place wheel bolts in sand or dirt. This could result in damage to the bolt and wheel hub threads.

- ▶ Remove the wheel.
- ▶ Take the spare tire out of the trunk.

Mounting the new wheel

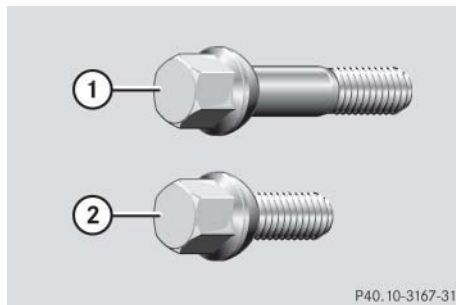

Wheel bolts

- ① Wheel bolt for
 - wheel rim size 7Jx16 H2 and 8Jx16 H2
 - AMG wheel rim size 7½ Jx17 H2 and 8½ Jx17 H2
 - spare wheel rim size 4½ Bx16 H2
- ② Wheel bolt for
 - spare wheel rim size 4½ Bx15 H2 (located with electric air pump)



Wheel bolts ② must be used when mounting spare wheel rim size 4½ Bx15 H2.

The use of any wheel bolts other than wheel bolts ② for spare wheel rim size 4½ Bx15 H2 can cause physical damage to the vehicle.

Warning!



Be sure to use original length wheel bolts when remounting the original wheel after it has been repaired.

- ▶ Clean contact surfaces of wheel and wheel hub.
- ▶ Guide the spare wheel onto the alignment bolt and push it on.
- ▶ Insert wheel bolts and tighten them slightly.

Practical hints

Flat tire

Warning!



Inflate spare wheel with collapsible tire only after the wheel is properly mounted.

- ▶ Inflate the spare tire using the electric air pump (▶ page 249).



To avoid paint damage, place wheel flat against hub and hold it there while installing first wheel bolt.

Practical hints

Flat tire

Warning!



Always replace wheel bolts that are damaged or rusted.

Never apply oil or grease to wheel bolts.

Damaged wheel hub threads should be repaired immediately. Do not continue to drive under these circumstances! Contact an authorized Mercedes-Benz Center or call Roadside Assistance.

Incorrect mounting bolts or improperly tightened mounting bolts can cause the wheel to come off. This could cause an accident. Be sure to use the correct mounting bolts.

Warning!



Use only genuine equipment Mercedes-Benz wheel bolts. Other wheel bolts may come loose.

Do not tighten the wheel bolts when the vehicle is raised. Otherwise the vehicle could tip over.

- ▶ Unscrew the alignment bolt, install last wheel bolt and tighten slightly.

Lowering the vehicle

- ▶ Lower vehicle by turning crank counterclockwise until vehicle is resting fully on its own weight.
- ▶ Pull the jack out of the jack support tube.
- ▶ Install jack tube cover.

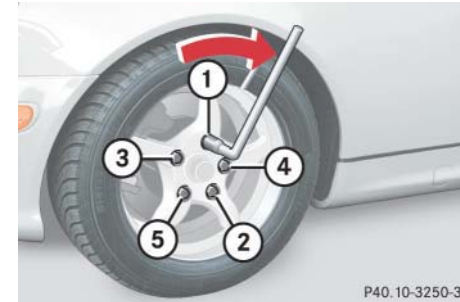

① - ⑤ Wheel bolts

- ▶ Tighten the five wheel bolts evenly, following the diagonal sequence illustrated (① to ⑤), until all bolts are tight. Observe a tightening torque of 80 lb-ft (110 Nm).

Warning!



Have the tightening torque checked after changing a wheel. The wheels could come loose if they are not tightened to a torque of 80 lb-ft (110 Nm).

- ▶ Before storing the jack in the trunk, it should be fully collapsed, with pin and handle folded in.

Inflating the collapsible spare tire

- ▶ Take the electric air pump out of the trunk (▷ page 214).

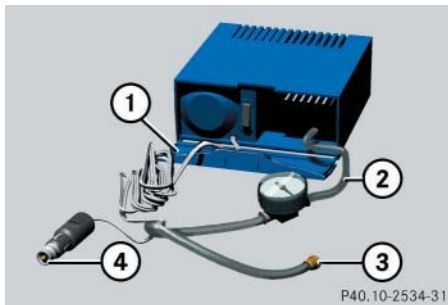

- ① Flap
- ② Air hose with pressure gauge and vent screw
- ③ Union nut
- ④ Electrical plug

Warning!



Observe instructions on air pump label.

- ▶ Open flap ① on air pump.
- ▶ Pull out electrical plug ④ and air hose with pressure gauge ②.
- ▶ Unscrew valve cap from spare wheel tire valve.
- ▶ Screw union nut ③ with air hose ② on to the tire valve.
- ▶ Insert electrical plug ④ into vehicle cigarette lighter socket.
- ▶ Turn key in steering lock to position 1 (▷ page 29).
- ▶ Press I on the electric air pump switch. The electric air pump should now switch on and inflate the tire.
- ▶ Inflate the collapsible tire to around 36 psi (2.5 bar).

Practical hints

Flat tire

This takes about 5 minutes for the collapsible spare tire. Air hose ② and union nut ③ can become hot duration inflation.



Do not operate the electric air pump longer than 8 minutes without interruption. Otherwise it may overheat.

You may operate the air pump again after it has cooled off.

- ▶ Press 0 on the electric air pump switch. The electric air pump should now be switched off.
- ▶ Turn key in steering lock to position 0.
- ▶ If the tire pressure is above 36 psi (2.5 bar) release excess tire pressure using the vent screw. ▷▷

Practical hints

Flat tire



Warning!



Follow recommended inflation pressures.

Do not overinflate tires. Overinflating tires can result in sudden deflation (blowout) because they are more likely to become punctured or damaged by road debris, potholes etc.

Do not underinflate tires. Underinflated tires wear unevenly, adversely affect handling and fuel economy, and are more likely to fail from being overheated.

Do not overload the tires by exceeding the specified vehicle capacity weight (as indicated by the label on the pillar in the driver's door opening). Overloading the tires can overheat them, possibly causing a blowout.

Warning!



To prevent possible injury when unscrewing air pump filler hose from tire valve after inflating the tire, use a rag since the tire valve could be hot.

- ▶ Detach the electric air pump.
- ▶ Reinstall tire valve cap.
- ▶ Stow the electrical plug and the air hose behind the flap and place the air pump back in the trunk.
- ▶ Close the trunk lid.

Storing collapsible spare wheel in wheel well

Before you can store the spare wheel with collapsible tire in the wheel well you have to release the air pressure of the tire.

- ▶ Unscrew valve stem removal tool, which is part of the valve cap, from tire valve.
- ▶ Using the valve stem removal tool, open tire valve slightly by turning the tire valve insert counterclockwise to release air pressure.
- ▶ When the air pressure has been released, remove tire valve insert (protect it from dirt and sand) using the previously removed tire valve cap.
- ▶ Once all air is out of the tire, and the tire has collapsed to its original shape, reinstall the tire valve insert and valve cap.
- ▶ Place spare wheel in wheel well and secure it with the pump holder.
- ▶ Turn pump holder clockwise to its stop.

▼ Battery

The battery is located in the engine compartment on the right-hand side.

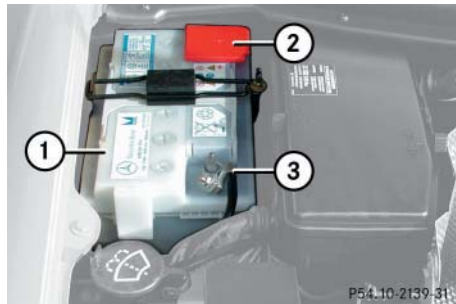

- ① Battery
- ② Positive terminal
- ③ Negative terminal

Warning!



Failure to follow these instructions can result in severe injury or death.

Observe all safety instructions and precautions when handling automotive batteries, see "Battery" (> page 183).

Never lean over batteries while connecting, you might get injured.

Battery fluid contains sulfuric acid. Do not allow this fluid to come in contact with eyes, skin or clothing. In case it does, immediately flush affected area with water and seek medical help if necessary.

A battery will also produce hydrogen gas, which is flammable and explosive. Keep flames or sparks away from battery, avoid improper connection of jumper cables, smoking etc.

Practical hints

Battery



Never loosen or detach battery terminal clamps while the engine is running or the key is in the steering lock. Otherwise the alternator and other electronic components could be severely damaged.

Have the battery checked regularly by an authorized Mercedes-Benz Center.

Refer to Service Booklet for maintenance intervals or contact your authorized Mercedes-Benz Center for further information.

Warning!



Do not place metal objects on the battery as this could result in a short circuit.

Use leak-proof battery only to avoid the risk of acid burns in the event of an accident.

Practical hints

Battery

Disconnecting the battery

Warning!



With a disconnected battery

- you will no longer be able to turn the key in the steering lock
 - automatic transmission: the gear selector lever will remain locked in position **P**
- ▶ Depress parking brake firmly or move gear selector lever to position **P** (manual transmission to Neutral).
 - ▶ Turn off all electrical consumers.
 - ▶ Remove key from steering lock.
 - ▶ Open the hood (▷ page 174).
 - ▶ Disconnect the battery negative lead.
 - ▶ Remove the cover ② from the positive terminal.
 - ▶ Disconnect the battery positive lead.

Removing the battery

- ▶ Remove the screw on the swivel bar.
- ▶ Remove the swivel bar.
- ▶ Take out the battery.

Charging and reinstalling battery

Warning!



Never charge a battery while still installed in the vehicle. Gases may escape during charging and cause explosions that may result in paint damage, corrosion or personal injury.

- ▶ Charge battery in accordance with the instructions of the battery charger manufacturer.
- ▶ Reinstall the charged battery. Follow the previously described steps in reverse order.

Reconnecting the battery

- ▶ Turn off all electrical consumers.
- ▶ Connect the positive lead and fasten its cover ②.
- ▶ Connect the negative lead.



Never invert the terminal connections!



The battery, its filler caps and the vent tube must always be securely installed when the vehicle is in operation.



The following procedures must be carried out following any interruption of battery power (e.g. due to reconnection):

- Set the clock (▷ page 91).
- Resynchronize the ESP (▷ page 202).
- Re-enter the radio code (see radio operating instructions).
- Resynchronize side windows (▷ page 129).

Batteries contain materials that can harm the environment if disposed of improperly. Large 12-volt storage batteries contain lead. Recycling of batteries is the preferred method of disposal. Many states require sellers of batteries to accept old batteries for recycling.

Practical hints

Jump starting

▼ Jump starting

Warning!



Failure to follow these directions will cause damage to the electronic components, and can lead to a battery explosion and severe injury or death.

Never lean over batteries while connecting or jump starting, you might get injured.

Battery fluid contains sulfuric acid. Do not allow this fluid to come in contact with eyes, skin or clothing. In case it does, immediately flush affected area with water, and seek medical help if necessary.

A battery will also produce hydrogen gas, which is flammable and very explosive. Keep flames or sparks away from battery, avoid improper connection of jumper cables, smoking etc.

Attempting to jump start a frozen battery can result in it exploding, causing personal injury.

Read all instructions before proceeding.

If the battery is discharged, the engine can be started with jumper cables and the battery of another vehicle. Observe the following:

- Jump starting should only be performed when the engine and catalytic converter are cold.
- Do not start the engine if the battery is frozen. Let the battery thaw out first.
- Only jump start from batteries with the same voltage rating (12V). Jump starting with a more powerful battery could damage the vehicle's electrical system, which will not be covered by the Mercedes-Benz Limited Warranty.
- Use only jumper cables with sufficient cross-section and insulated terminal clamps.
- Always make sure the jumper cables are not on or near pulleys, fans, or other parts that move when an engine is started or running.



Jump starting may only be performed on the battery installed in the engine compartment.

Avoid repeated and lengthy starting attempts.

Do not attempt to start the engine using a battery quick charge unit.

If engine does not run after several unsuccessful starting attempts, have it checked at the nearest authorized Mercedes-Benz Center.

Excessive unburned fuel generated by repeated failed starting attempts may damage the catalytic converter and may present a fire risk.

Make sure the jumper cables do not have loose or missing insulation.

Make sure the cable clamps do not touch any other metal part while the other end is still attached to a battery.

Warning!



Keep flames or sparks away from battery.
Do not smoke.

Observe all safety instructions and precautions when handling automotive batteries.

The battery is located on the right side of the engine compartment.

- ▶ Make sure the two vehicles do not touch.
- ▶ Turn off all electrical consumers.
- ▶ Apply parking brake.
- ▶ Shift gear selector lever to position **P** (manual transmission to Neutral).
- ▶ Open the hood.
- ▶ Connect positive terminals ① and ② of the batteries with the jumper cables. Clamp cable to charged battery ① first.



Never invert the terminal connections.

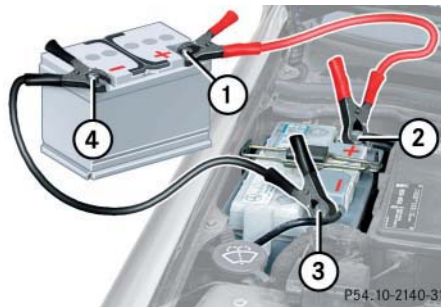

- ① Positive terminal of charged battery
 - ② Positive terminal of discharged battery
 - ③ Negative terminal of discharged battery
 - ④ Negative terminal of charged battery
- ▶ Start engine of the vehicle with the charged battery and run at idle speed.

Practical hints

Jump starting

- ▶ Connect negative terminals ③ and ④ of the batteries with the jumper cables. Clamp cable to charged battery ④ first.
- ▶ Start the engine of the disabled vehicle.

You can now again turn on the electrical consumers. Do not turn on the lights under any circumstances.

- ▶ Remove the jumper cables first from negative terminals ③ and ④ of the batteries and then from positive terminals ① and ②.

You can now turn on the lights.

- ▶ Have the battery checked at the nearest authorized Mercedes-Benz Center.



Vehicles with automatic transmission:
Do not tow-start vehicle.

Practical hints

Towing the vehicle

▼ Towing the vehicle

Mercedes-Benz recommends that the vehicle be transported with all wheels off the ground using flatbed or appropriate wheel lift/dolly equipment.



Vehicles with automatic transmission:
Do not tow-start vehicle.



Use flatbed or wheel lift/dolly equipment with key in starter switch turned to position **0**.

Do not tow with sling-type equipment. Towing with sling-type equipment over bumpy roads will damage radiator and supports.

To prevent damage during transport, do not tie down vehicle by its chassis or suspension parts.

Switch off the tow-away alarm (▷ page 72) and the automatic central locking (▷ page 79).

When circumstances do not permit the recommended towing methods, the vehicle may be towed with all wheels on the ground or front wheels raised only so far as necessary to have the vehicle moved to a safe location where the recommended towing methods can be employed.



If the vehicle is towed with the front axle raised, the engine must be shut off (key in starter switch position **0** or **1**). Otherwise, the ESP will immediately be engaged and will apply the rear wheel brakes.

When towing the vehicle with all wheels on the ground, the selector lever must be in position **N** (manual transmission: gear shift lever in neutral position) and the key must be in starter switch position **2**.

When towing the vehicle with all wheels on the ground or the front axle raised, the vehicle may be towed only for distances up to 30 miles (50 km) and at a speed not to exceed 30 mph (50 km/h).

Towing of the vehicle should only be done using the properly installed towing eye bolt. Never attach tow cable, tow rope or tow rod to vehicle chassis, frame or suspension parts.

Warning!



Prior to towing the vehicle with all wheels on the ground, make certain that the key is in starter switch position **2**.

If the key is left in starter switch position **0** for an extended period of time, it can no longer be turned in the switch. In this case, the steering is locked. To unlock, remove key from starter switch and reinsert.

If circumstances require towing the vehicle with all wheels on the ground, always tow with a tow bar if:

- the engine will not run
- there is a malfunction in the power supply or in the vehicle's electrical system as that will be necessary to adequately control the towed vehicle.

Warning!



With the engine not running, there is no power assistance for the brake and steering systems. In this case, it is important to keep in mind that a considerably higher degree of effort is necessary to brake and steer the vehicle. Adapt your driving accordingly.



To signal turns while being towed with the hazard warning flasher in use, turn key in starter switch to position **2** and activate the combination switch for the left or right turn signal in the usual manner – only the selected turn signal will operate.

Upon canceling the turn signal, the hazard warning flasher will operate again.

Practical hints

Towing the vehicle



When towing the vehicle with all wheels on the ground, please note the following:

With the automatic central locking activated and the key in starter switch position **2**, the vehicle doors lock if the left front wheel as well as the right rear wheel are turning at vehicle speeds of approx. 9 mph (15 km/h) or more.

Switch off the tow-away alarm (▷ page 72).

To prevent the vehicle door locks from locking, deactivate the automatic central locking (▷ page 79).

Towing of the vehicle should only be done using the properly installed towing eye bolt. Never attach tow cable, tow rope or tow rod to the vehicle chassis, frame or suspension parts.

Practical hints

Towing the vehicle



The selector lever will remain locked in position **P** and the key will not turn in the starter switch if the battery is disconnected or discharged. See notes on the battery (▷ page 251) or on jump starting (▷ page 254).

Vehicles with automatic transmission: Manual unlocking of transmission selector lever (▷ page 220).

Towing eye

SLK 230 Kompressor except Sport Package*, SLK 320 except Sport Package*

The rear towing eye is located at the right, below the bumper.

The front towing eye is located on the passenger-side behind the grille in the bumper panel.

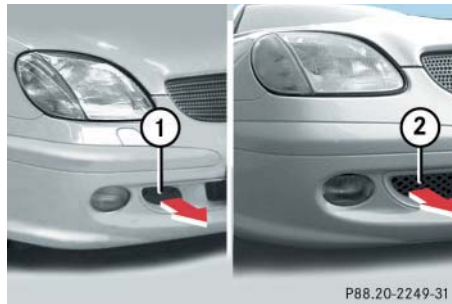

- ① Grille SLK 320 except Sport Package*
- ② Grille SLK 230 Kompressor except Sport Package*

Removing grille SLK 320

- ▶ Hold left and right end of grille ① and pull out firmly.

Installing grille SLK 320

- ▶ Position grille ① and press securely. The grille should audibly snap into place.

Removing grille SLK 230 Kompressor

- ▶ Hold grille ②, fold it down and pull out firmly.

Installing grille SLK 230 Kompressor

- ▶ Position grille ② and press securely. The grille should audibly snap into place.

Installing towing eye bolt

SLK 32 AMG, Sport Package*

The rear towing eye is located at the right, below the bumper.

SLK 32 AMG and Sport Package are fitted with a towing eye bolt.

The towing eye bolt is stored with the jack in the trunk (▷ page 213).

The threaded hole for the towing eye bolt is located on the passenger-side behind the grille in the bumper panel.

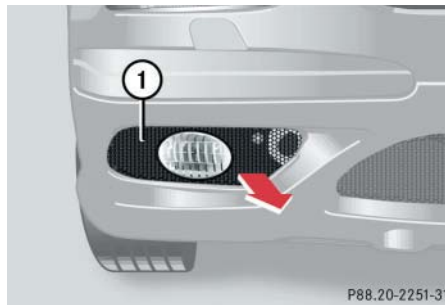

① Grille SLK 32 AMG, Sport Package*

Practical hints

Towing the vehicle

Removing grille

- ▶ Hold grille ① (arrow) and pull forward.

Installing towing eye bolt

- ▶ Take towing eye bolt and wheel wrench out of trunk.
- ▶ Screw towing eye bolt into its stop and tighten with wheel wrench.

Removing towing eye bolt

- ▶ Loosen towing eye bolt with wheel wrench.
- ▶ Unscrew towing eye bolt.
- ▶ Store towing eye bolt and wheel wrench in trunk.

Installing grille

- ▶ Position grille ① and press securely
The grille should audibly snap into place.

Practical hints

Fuses

▼ Fuses



Only install fuses that have been tested and approved by Mercedes-Benz and that have the specified amperage rating.

Never attempt to repair or bridge a blown fuse. Have the cause determined and remedied by an authorized Mercedes-Benz Center.

A special fuse extractor is supplied with the vehicle tool kit in the trunk.

Spare fuses are supplied inside the corresponding fuse box.

The fuse chart is printed on the cover of the corresponding fuse box.

The amperages of the fuses are also given there.

Main fuse box

The main fuse box is located in the engine compartment on the left hand side.

The main fuse box contains fuses for interior consumers.



① Main fuse box

Opening

- ▶ Release clamp (arrow) and lift fuse box cover ①.
- ▶ Remove fuse box cover.

Closing

- ▶ Fit fuse box cover ① back into the rear clamp.
- ▶ Close fuse box cover until the clamp engages.

Auxiliary fuse box

The auxiliary fuse box is located on the left hand side of the exterior lamp switch.

The auxiliary fuse box contains fuses for lights.



① Auxiliary fuse box

Opening

- ▶ Turn locks (arrows) using a coin and remove fuse box cover ①.

Closing

- ▶ Reinstall fuse box cover ① and turn locks using a coin.



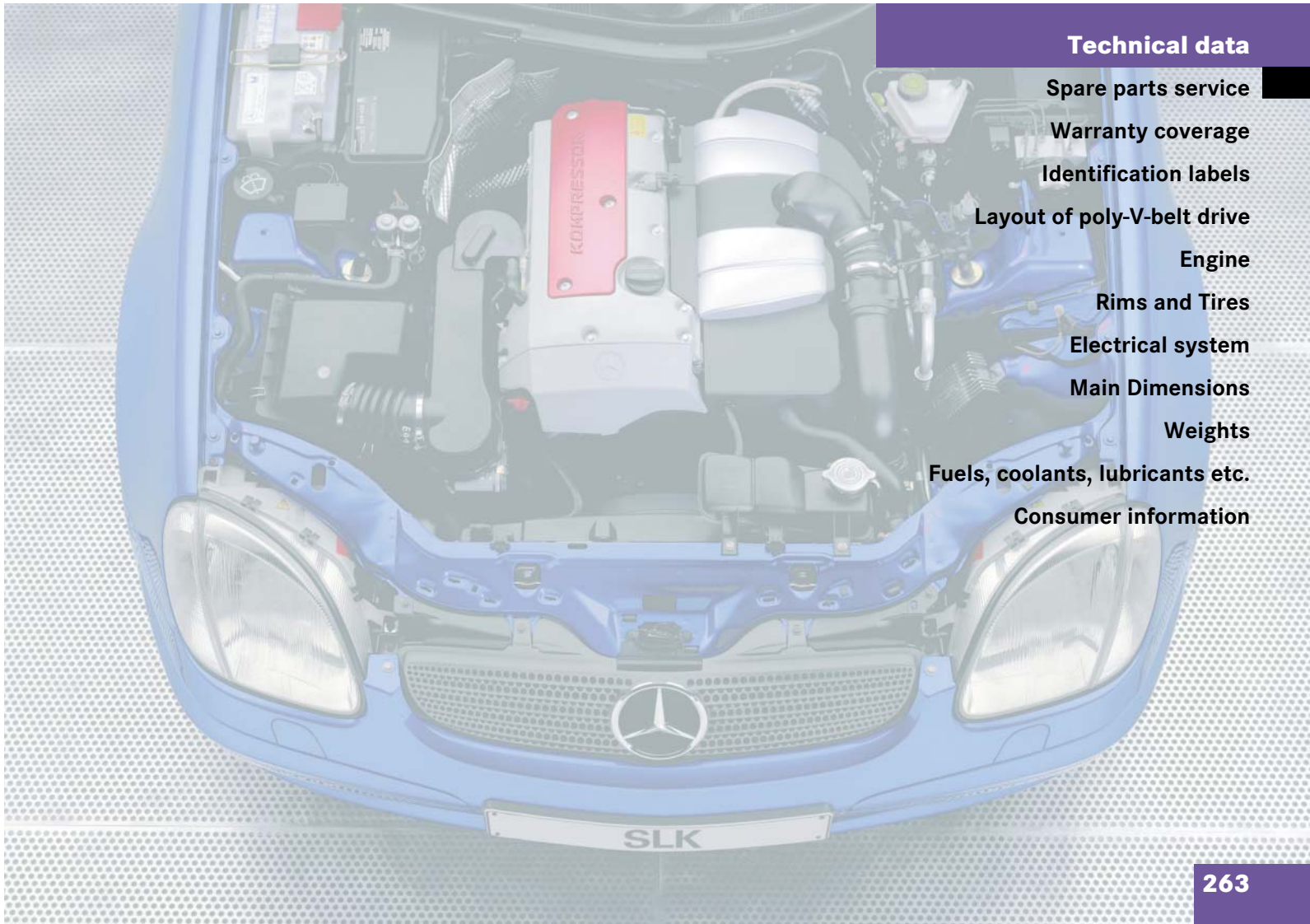

Technical data

Spare parts service

Warranty coverage

Identification labels

Layout of poly-V-belt drive

Engine

Rims and Tires

Electrical system

Main Dimensions

Weights

Fuels, coolants, lubricants etc.

Consumer information

Technical data

Spare parts service

The “Technical data” section provides the necessary technical data for your vehicle.

▼ Spare parts service

All authorized Mercedes-Benz Centers maintain a stock of genuine Mercedes-Benz parts required for maintenance and repair work. In addition, strategically located parts distribution centers provide quick and reliable parts service.

More than 300 000 different spare parts for Mercedes-Benz models are available.

Genuine Mercedes-Benz parts are subjected to stringent quality inspections. Each part has been specifically developed, manufactured or selected for and adapted to Mercedes-Benz vehicles.

Therefore, genuine Mercedes-Benz parts original spare parts should be installed.



The use of non-genuine Mercedes-Benz parts and accessories not authorized by Mercedes-Benz could damage the vehicle, which is not covered by the Mercedes-Benz Limited Warranty, or could compromise the vehicle's durability or safety.

▼ **Warranty coverage**

Your vehicle is covered under the terms of the “warranties” printed in the Service and Warranty Information booklet. Your authorized Mercedes-Benz Center will exchange or repair any defective parts originally installed in the vehicle in accordance with the terms of the following warranties:

- New vehicle limited warranty
- Emission system warranty
- Emission performance warranty
- California, Maine, Massachusetts, and Vermont emission control systems warranty

Replacement parts and accessories are covered by the Mercedes-Benz Spare Parts and Accessories warranties, copies of which are available at any Mercedes-Benz Center.

Loss of Service and Warranty Information Booklet

Should you lose your Service and Warranty Information booklet, have your authorized Mercedes-Benz Center arrange for a replacement. It will be mailed to you.

Technical data

Identification labels

▼ Identification labels



① Certification label

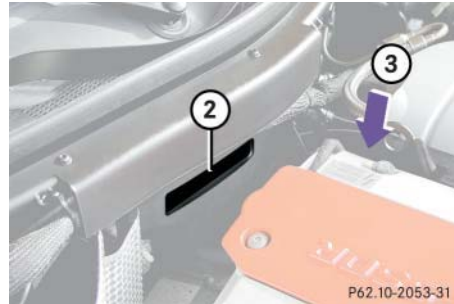

② Vehicle Identification Number (VIN)
③ Engine number (engraved on engine)

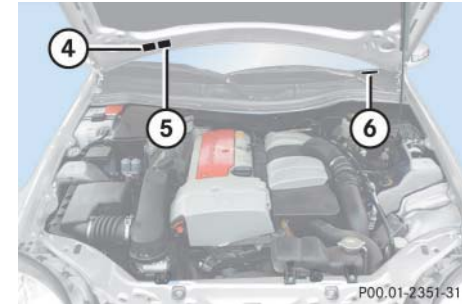

④ Emission control label
⑤ Information label, California version
Vacuum line routing for emission control system
⑥ VIN, visible (lower edge of windshield)

When ordering spare parts, please specify vehicle identification and engine numbers.

▼ Layout of poly-V-belt drive

SLK 230 Kompressor

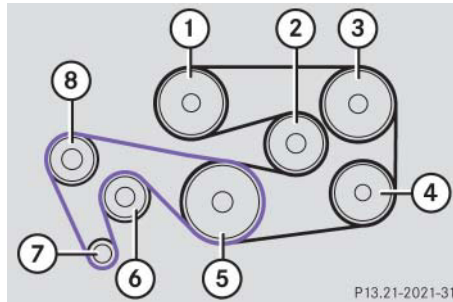

P13.21-2021-31

The SLK 230 Kompressor has two poly-V-belts (belt one shown in purple/belt two shown in black).

- ① Coolant pump
- ② Automatic belt tensioner
- ③ Power steering pump
- ④ Air conditioning compressor
- ⑤ Crankshaft
- ⑥ Automatic belt tensioner
- ⑦ Generator (alternator)
- ⑧ Supercharger

SLK 320

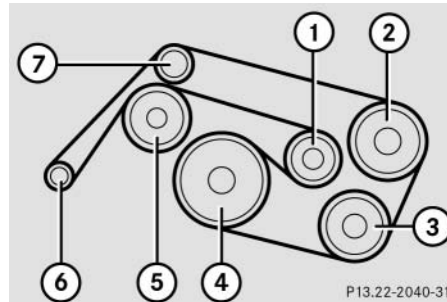

P13.22-2040-31

- ① Automatic belt tensioner
- ② Power steering pump
- ③ Air conditioner compressor
- ④ Crankshaft
- ⑤ Coolant pump
- ⑥ Generator (alternator)
- ⑦ Idler pulley

SLK 32 AMG

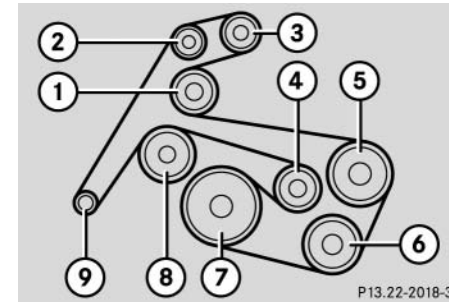

P13.22-2018-31

- ① Idler pulley
- ② Idler pulley
- ③ Supercharger
- ④ Automatic belt tensioner
- ⑤ Power steering pump
- ⑥ Air conditioner compressor
- ⑦ Crankshaft
- ⑧ Coolant pump
- ⑨ Generator (alternator)

Technical data

Engine

▼ Engine

Model	SLK 230 Kompressor (170.449) ¹	SLK 320 (170.465) ¹	SLK 32 AMG (170.466) ¹
Engine	111	112	112
Mode of operation	4-stroke engine, gasoline injection	4-stroke engine, gasoline injection	4-stroke engine, gasoline injection
No. of cylinders	4	6	6
Bore	3.58 in (90.90 mm)	3.54 in (89.90 mm)	3.54 in (89.90 mm)
Stroke	3.48 in (88.40 mm)	3.30 in (84.00 mm)	3.30 in (84.00 mm)
Total piston displacement	140.1 cu in (2295 cm ³)	195.2 cu in (3199 cm ³)	195.2 cu in (3199 cm ³)
Compression ratio	9:0	10:0	9:0
Output acc. to SAE J 1349	192 hp / 5500 rpm (145 kW / 5500 rpm)	215 hp / 5700 rpm (160 kW / 5700 rpm)	349 hp / 6100 rpm (260 kW / 6100 rpm)
Maximum torque acc. to SAE J 1349	207 lb-ft / 2500 rpm (280 Nm / 2500 rpm)	229 lb-ft / 3000 rpm (310 Nm / 3000 - 4600 rpm)	333 lb-ft / 4400 rpm (450 Nm / 4400 rpm)
Maximum engine speed	6200 rpm	6000 rpm	6200 rpm
Firing order	1-3-4-2	1-4-3-6-2-5	1-4-3-6-2-5
Poly-V-belt	Belt one: 1875 mm (routing I) Belt two: 1355 mm (routing II)	2390 mm	2902 mm

¹ The quoted data apply only to the standard vehicle. See an authorized Mercedes-Benz Center for the corresponding data of all special bodies and special equipment.

▼ Rims and Tires

Use only tires and rims which have been specifically developed for your vehicle and tested and approved by Mercedes-Benz. Other tires and rims can have detrimental effects, such as

- poor handling characteristics
- increased noise
- increased fuel consumption



Moreover, tires and rims not approved by Mercedes-Benz may, under load, exhibit dimensional variations and different tire deformation characteristics that could cause them to come into contact with the vehicle body or axle parts. Damage to the tires or the vehicle may be the result.



Further information on tires and rims is available at any authorized Mercedes-Benz Center. A tire inflation pressure table is located on the fuel filler flap of the vehicle. The tire pressure should be checked regularly and should only be adjusted on cold tires. Follow tire manufacturer's maintenance recommendation included with vehicle.

Technical data

Rims and Tires

Technical data

Rims and Tires

Same size tires

16" tires

	SLK 230 Kompressor	SLK 320	SLK 32 AMG
Rims (light alloy)	7 J x16 H2	7 J x16 H2	-
Wheel offset	1.46 in (37 mm)	1.46 in (37 mm)	-
Winter tires (radial-ply tires)	205/55 R16 91H M+S	205/55 R16 91H M+S	-

17" tires

	SLK 230 Kompressor	SLK 320	SLK 32 AMG
Rims (light alloy)	-	-	7½ J x17 H2
Wheel offset	-	-	1.46 in (37 mm)
Winter tires (radial-ply tires)	-	-	205/50 R17 89H M+S or 225/45 R17 91H M+S ¹

¹ Must not be used with snow chains.

Mixed size tires

16" tires

	SLK 230 Kompressor (except Sport Package)	SLK 320 (except Sport Package)
Front axle:		
Rims (light alloy)	7 J x16 H2	7 J x16 H2
Wheel offset	1.46 in (37 mm)	1.46 in (37 mm)
Summer tires (radial-ply tires)	205/55 R16 91V	205/55 R16 91W
Rear axle:		
Rims (light alloy)	8 J x16 H2	8 J x16 H2
Wheel offset	1.18 in (30 mm)	1.18 in (30 mm)
Summer tires (radial-ply tires)	225/50 R16 92V ¹	225/50 R16 92W ¹

¹ Must not be used with snow chains.

Technical data

Rims and Tires

17" tires

	SLK 230 Kompressor, SLK 320 (Sport Package*)	SLK 32 AMG
Front axle:		
Rims (light alloy)	7½ J x17 H2	7½ J x17 H2
Wheel offset	1.46 in (37 mm)	1.46 in (37 mm)
Summer tires (radial-ply tires)	225/45 R17 91Y or 225/45 ZR17 91Y	225/45 R17 91Y or 225/45 ZR17 91Y
Rear axle:		
Rims (light alloy)	8½ J x17 H2	8½ J x17 H2
Wheel offset	1.34 in (34 mm)	1.34 in (34 mm)
Summer tires (radial-ply tires)	245/40 R17 91Y ¹ or 245/40 ZR17 91Y ¹	245/40 R17 91Y ¹ or 245/40 ZR17 91Y ¹

¹ Must not be used with snow chains

Spare wheel with collapsible tire

	SLK 230 Kompressor	SLK 320
Rim (light alloy)	4.5 B x15 H2	4.5 B x16 H2
Wheel offset	0.47 in (12 mm)	0.47 in (12 mm)
Collapsible tire	165-15 89P ¹	165/70-16 92P ¹

¹ Must not be used with snow chains.



The SLK 32 AMG does not have a spare wheel. The SLK 32 AMG is equipped with TIREFIT (> page 235).

Technical data

Electrical system

▼ Electrical system

Model	SLK 230 Kompressor	SLK 320	SLK 32 AMG
Generator (alternator)	14 V/90 A	14 V/115 A	14 V/120 A
Starter motor	12 V/1.1 kW	12 V/1.7 kW	12 V/1.7 kW
Battery	12 V/74 Ah	12 V/74 Ah	12 V/74 Ah
Spark plugs	Bosch F 7 KTCR	Bosch F 8 DPER Beru 14 FGH 8 DPUR X 2 NGK PFR 5-11	NGK IFR 6D10
Electrode gap	0.039 in (1.0 mm)	0.039 in (1.0 mm)	0.039 in (1.0 mm)
Tightening torque	15 – 22 lb-ft (20 – 30 Nm)	15 – 22 lb-ft (20 – 30 Nm)	15 – 22 lb-ft (20 – 30 Nm)

Technical data

Main Dimensions

▼ Main Dimensions

Model	SLK 230 Kompressor, SLK 320	SLK 32 AMG
Overall vehicle length	157.9 in (4010 mm)	157.9 in (4010 mm)
Overall vehicle width	64.4 in (1712 mm)	64.4 in (1712 mm)
Overall vehicle height	50.4 in (1279 mm)	50.4 in (1279 mm)
Wheelbase	94.5 in (2400 mm)	94.5 in (2400 mm)
Track, front	58.6 in (1488 mm)	58.6 in (1488 mm)
Track, rear	58.5 in (1485 mm)	58.2 in (1477 mm)

Technical data

Weights

▼ Weights

Trunk load max.	110 lb (50 kg)
-----------------	----------------

▼ Fuels, coolants, lubricants etc.

Capacities

Vehicle components and their respective lubricants must match. Therefore use only brands tested and approved by Mercedes-Benz.

Please refer to the Factory Approved Service Products pamphlet, or inquire at your Mercedes-Benz Center.

	Model	Capacity	Fuels, coolants, lubricants etc.
Engine with oil filter	SLK 230 Kompressor	6.1 US qt (5.5 l)	Recommended engine oils
	SLK 320 SLK 32 AMG	8.5 US qt (8.0 l)	
Automatic transmission*		8.5 US qt (8.0 l)	MB Automatic Transmission Oil
Manual transmission	SLK 230 Kompressor	1.6 US qt (1.5 l)	MB Manual Transmission Oil
	SLK 320	1.9 US qt (1.8 l)	
Rear axle		1.4 US qt (1.3 l)	Hypoid gear oil SAE 90, 85 W 90
Power steering		approx. 1.1 US qt (1.0 l)	MB Power Steering Fluid
Front wheel hubs		approx. 1.5 oz (43 g) each	High temperature roller bearing grease
Brake system		0.5 US qt (0.5 l)	MB Brake Fluid (DOT 4)
Cooling system	SLK 230 Kompressor	approx. 9.8 US qt (9.3 l)	MB 325.0 Anticorrosion/Antifreeze Agent
	SLK 320	approx. 11.8 US qt (11.2 l)	
	SLK 32 AMG	approx. 15.3 US qt (14.5 l)	

Technical data

Fuels, coolants, lubricants etc.

	Model	Capacity	Fuels, coolants, lubricants etc.
Fuel tank including a reserve of		approx. 15.8 US gal (60.0 l) approx. 2.1 US gal (8.0 l)	Premium unleaded gasoline: Posted Octane 91 (average of 96 RON / 86 MON)
Air conditioner system			R-134a refrigerant and special PAG lubricant oil (never R-12)
Windshield washer and headlamp cleaning system*		7.4 US qt (7.0 l)	MB Windshield washer concentrate ¹

¹ Use MB Windshield Washer Concentrate "S" and water for temperatures above freezing or MB Windshield Washer Concentrate "S" and commercially available pre-mixed windshield washer solvent/antifreeze for temperatures below freezing. Follow suggested mixing ratios (▷ page 283).

Engine oils

Engine oils are specifically tested for their suitability in our engines. Therefore, use only engine oils recommended by Mercedes-Benz. Information on approved engine oils is available in the Factory Approved Service Products pamphlet, or at your authorized Mercedes-Benz Center.



Always check the oil filler cap (> page 171) for important information pertaining to the engine oil needed to meet a specific Mercedes-Benz specification (e.g. MB 229.5). If such information is printed on the oil filler cap, only use an engine oil from the list of approved engine oils in the Factory Approved Service Products pamphlet that meets the specification indicated on the oil filler cap.

Using engine oils of other specification may cause the FSS to incorrectly determine the next service interval and will result in engine damage not covered by the Mercedes-Benz Limited Warranty.

Please follow FSS or Service Booklet recommendations for scheduled oil changes. Failure to do so could result in engine damage not covered by the Mercedes-Benz Limited Warranty.

Engine oil additives

Do not blend oil additives with engine oil. They may damage the engine.

Damage or malfunctions resulting from blending oil additives are not covered by the Mercedes-Benz Limited Warranty.

Air conditioning refrigerant

R-134a (HFC) refrigerant and special PAG lubricating oil is used in the air conditioning system.

Never use R-12 (CFC) or mineral-based lubricating oil, otherwise damage to the system will occur.

Brake fluid

During vehicle operation, the boiling point of the brake fluid is continuously reduced through the absorption of moisture from the atmosphere. Under extremely strenuous operating conditions, this moisture content can lead to the formation of bubbles in the system, thus reducing the system's efficiency.

Therefore, the brake fluid must be replaced every two years, preferably in the spring.

Only brake fluid approved by Mercedes-Benz is recommended. Your authorized Mercedes-Benz Center will provide you with additional information.

Technical data

Fuels, coolants, lubricants etc.

Premium unleaded gasoline



To maintain the engine's durability and performance, premium unleaded gasoline must be used. If premium unleaded is not available and low octane fuel is used, follow these precautions:

- Have the fuel tank only partially filled with unleaded regular and fill up with premium unleaded as soon as possible.
- Avoid full throttle driving and abrupt acceleration.
- Do not exceed an engine speed of 3000 rpm if the vehicle is loaded with a light load such as two persons and no luggage.
- Do not exceed $\frac{2}{3}$ of maximum accelerator pedal position if the vehicle is fully loaded or operating in mountainous terrain.

Fuel requirements

Use only premium unleaded gasoline meeting ASTM standard D 439:

- The octane number (posted at the pump) must be 91 min. It is an average of both the Research (R) octane number and the Motor (M) octane number: $(R+M) / 2$. This is also known as the ANTI-KNOCK INDEX.

Unleaded gasoline containing oxygenates such as ethanol, IPA, IBA and TBA can be used provided the ratio of any one of these oxygenates to gasoline does not exceed 10%; MTBE not to exceed 15%.

The ratio of methanol to gasoline must not exceed 3% plus additional cosolvents.

Using mixtures of ethanol and methanol is not allowed. Gasohol, which contains 10% ethanol and 90% unleaded gasoline, can be used.

These blends must also meet all other fuel requirements, such as resistance to spark knock, boiling range, vapor pressure etc.

Gasoline additives

A major concern among engine manufacturers is carbon build-up caused by gasoline. Mercedes-Benz recommends only the use of quality gasoline containing additives that prevent the build up of carbon deposits.

After an extended period of using fuels without such additives, carbon deposits can build up especially on the intake valves and in the combustion area, leading to engine performance problems such as:

- Warm-up hesitation
- Unstable idle
- Knocking/pinging
- Misfire
- Power loss

Do not blend any specific fuel additives with fuel. This only results in unnecessary costs and may be harmful to engine operation.

Damage or malfunctions resulting from poor fuel quality or from blending specific fuel additives are not covered by the Mercedes-Benz Limited Warranty.

Coolants

The engine coolant is a mixture of water and anticorrosion / antifreeze, which provides:

- Corrosion protection
- Freeze protection
- Boiling protection (by increasing the boiling point)

The cooling system was filled at the factory with a coolant providing freeze protection to approximately -22°F (-30°C) and corrosion protection.

If the antifreeze mixture is effective to -22°F (-30°C), the boiling point of the coolant in the pressurized cooling system is reached at approximately 266°F (130°C).

The coolant solution must be used year-round to provide the necessary corrosion protection and increase boil over-protection. Refer to Service Booklet for replacement interval.

Coolant system design and coolant used stipulate the replacement interval. The replacement interval published in the Service Booklet is only applicable if MB 325.0 anticorrosion / antifreeze solution or other Mercedes-Benz approved products of equal specification (see Factory Approved Service Products pamphlet) are used to renew the coolant concentration or bring it back up to the proper level.

To provide important corrosion protection, the solution must be at least 45% anticorrosion / antifreeze (equivalent to freeze protection to approx. -22°F [-30°C]). If you use a solution that is more than 55% anticorrosion / antifreeze (freeze protection to approx. -49°F [-45°C]), the engine temperature will increase due to the lower heat

transfer capability of the solution. Therefore, do not use more than this amount of anticorrosion / antifreeze.

If the coolant level is low, water and MB Anticorrosion / Antifreeze should be used to bring it up to the proper level (have cooling system checked for signs of leakage). Please make sure the mixture is in accordance with label instructions.

The water in the cooling system must meet minimum requirements, which are usually satisfied by normal drinking water. If you are not sure about the water quality, consult your authorized Mercedes-Benz Center.

Technical data

Fuels, coolants, lubricants etc.

Anticorrosion/antifreeze

Your vehicle contains a number of aluminum parts. The use of aluminum components in motor vehicle engines necessitates that anticorrosion/antifreeze coolant used in such engines be specifically formulated to protect the aluminum

parts. (Failure to use such anticorrosion/antifreeze coolant will result in a significantly shortened service life.)

Therefore, the following product is strongly recommended for use in your vehicle: Mercedes-Benz 325.0 Anticorrosion/Antifreeze Agent.

Before the start of the winter season (or once a year in hot southern regions), you should have the anticorrosion/antifreeze concentration checked. The coolant is also regularly checked each time you bring your vehicle to your authorized Mercedes-Benz Center for service.

Anticorrosion/antifreeze quantity

Model	Approx. freeze protection	
	-35°F (-37°C)	-49°F (-45°C)
SLK 230 Kompressor	4.9 US qt (4.7 l)	5.4 US qt (5.1 l)
SLK 320	5.9 US qt (5.6 l)	6.5 US qt (6.1 l)
SLK 32 AMG	7.7 US qt (7.3 l)	8.5 US qt (8.0 l)

Windshield washer system and headlamp washer system*

Both the windshield and headlamp* washer systems are supplied from the windshield washer fluid reservoir.

The washer fluid reservoir has a capacity of approximately 7.4 US qt (7.0 l).

- ▶ Refill the reservoir with MB Windshield Washer Concentrate "S" and water (or concentrate and commercially available premixed windshield washer solvent / antifreeze, depending on ambient temperatures).

Warning!



Washer solvent/antifreeze is highly flammable. Do not spill washer solvent/antifreeze on hot engine parts because it may ignite and burn. You can be seriously burned.

Windshield and headlamp* washer fluid mixing ratio

For temperatures above freezing point, use MB Windshield Washer Concentrate "S" and water:

- 1 part "S" to 100 parts water
[40 ml "S" to 1 gallon (4 l) water]

For temperatures below freezing point, use MB Windshield Washer Concentrate "S" and commercially available premixed windshield washer solvent / antifreeze:

- 1 part "S" to 100 parts solvent
[40 ml "S" to 1 gallon (4 liters) solvent].

Technical data

Consumer information

▼ Consumer information

The following text is published as required of all manufacturers of passenger cars under Title 49, Code of U.S. Federal Regulations, Part 575 pursuant to the “National Traffic and Motor Vehicle Safety Act of 1966”.

Uniform tire quality grading

Quality grades can be found, where applicable, on the tire sidewall between tread shoulder and maximum section width. For example:

Tread wear	Traction	Temperature
200	AA	A

All passenger car tires must conform to federal safety requirements in addition to these grades.

Treadwear

The treadwear grade is a comparative rating based on the wear rate of the tire when tested under controlled conditions on a specified government test course. For example, a tire graded 150 would wear one and one-half (1½) times as well on the government course as a tire graded 100. The relative performance of tires depends upon the actual conditions of their use, however, and may depart significantly from the norm due to variations in driving habits, service practices and differences in road characteristics and climate.

Traction

The traction grades, from highest to lowest are AA, A, B, and C. Those grades represent the tire’s ability to stop on wet pavement as measured under controlled conditions on specified government test surfaces of asphalt and concrete. A tire marked C may have poor traction performance.

Warning!



The traction grade assigned to this tire is based on straight ahead braking traction tests, and does not include acceleration, cornering, hydroplaning, or peak traction characteristics.

Temperature

The temperature grades are A (the highest), B, and C, representing the tire's resistance to the generation of heat and its ability to dissipate heat when tested under controlled conditions on a specified indoor laboratory test wheel. Sustained high temperature can cause the material of the tire to degenerate and reduce tire life, and excessive temperatures can lead to sudden tire failure. Grade C corresponds to a level of performance which all passenger car tires must meet under the Federal Motor Vehicle Safety Standard No. 109.

Grades B and A represent higher levels of performance on the laboratory test wheel than the minimum required by law.

Warning!



The temperature grade for this tire is established for a tire that is properly inflated and not overloaded. Excessive speed, underinflation, or excessive loading, either separately or in combination, can cause excessive heat build-up and possible tire failure.



ABS

(Antilock Brake System)

Prevents the wheels from locking up during braking so that the vehicle can continue to be steered.

Alignment bolt

Metal pin with thread. The centering pin is an aid used when changing a tire to align the wheel with the wheel hub.

BabySmart™ airbag deactivation system

This system detects if a special system compatible child restraint seat is installed on the passenger seat. The system will automatically deactivate the passenger front airbag when such a seat is properly installed (indicator lamp  in the center console lights up). See your authorized Mercedes-Benz Center for availability.

BabySmart™ compatible child seats

Special restraint system for children. The sensor system for the passenger seat prevents deployment of the passenger front airbag if a BabySmart™ compatible child seat is installed.

BAS

(Brake Assist System)

System for potentially reducing braking distances in emergency braking situations. The system is activated when it senses an emergency based on how fast the brake is applied.

CAC

(Customer Assistance Center)

Mercedes-Benz customer service center, which can help you with any questions about your vehicle and provide assistance in the event of a breakdown.

CAN system

(Controller Area Network)

Data bus network serving to control vehicle functions such as door locking or windshield wiping.

Cockpit

All instruments, switches, buttons and indicator/warning lamps in the passenger compartment needed for vehicle operation and monitoring.

Collapsible tire

An especially compact spare tire that must be inflated with a provided air pump before using. It should only be used to bring the vehicle to the nearest service station.

Cruise control

Driving convenience system for automatically maintaining the vehicle speed set by the driver.

Technical terms

Engine number

The number set by the manufacturer and placed on the cylinder block to uniquely identify each engine produced.

Engine oil viscosity

Measurement for the inner friction (viscosity) of the oil at different temperatures. The higher the temperature an oil can tolerate without becoming thin, or the lower the temperature it can tolerate without becoming viscous, the better the viscosity.

ESP

(Electronic Stability Program)
Improves vehicle handling and directional stability.

ETD

(Emergency Tensioning Device)
Device which deploys in certain frontal and rear collisions exceeding the system's threshold to tighten the seat belts. ->SRS

FSS

(Flexible Service System)
Service indicator in the speedometer display that informs the driver when the next vehicle maintenance service is due.

Gear range

Number of gears which are available to the automatic transmission for shifting. The automatic gear shifting process can be adapted to specific operating conditions using the selector lever.

GPS

(Global Positioning System)
Satellite-based system for relaying geographic location information to and from vehicles equipped with special receivers.

Instrument cluster

The displays and indicator/warning lamps in the driver's field of vision, including the tachometer, speedometer, engine temperature and fuel gauge.

Kickdown

Depressing the accelerator past the point of resistance shifts the transmission down to the lowest possible gear. This very quickly accelerates the vehicle and should not be used for normal acceleration needs.

Lock button

Button on the door which indicates whether the door is locked or unlocked. Pushing the lock button down on an individual door from inside will lock that door.

MON

(Motor Octane Number)

The Motor Octane Number for gasoline as determined by a standardized method. It is an indication of a gasoline's ability to resist undesired detonation (knocking). The average of both the MON (Motor Octane Number) and →RON (Research Octane Number) is posted at the pump, also known as ANTI-KNOCK INDEX.

Overspeed range

Engine speeds within the red marking of the tachometer dial. Avoid this engine speed range, as it may result in serious engine damage that is not covered by the Mercedes-Benz Limited Warranty.

Poly-V-belt drive

Drives engine-components (alternator, AC compressor, etc.) from the engine.

Power train

Collective term designating all components used to generate and transmit motive power to the drive axles, including

- engine
- clutch/torque converter
- transmission
- drive shaft
- axle shafts/axles

Program mode selector switch

Used to switch the automatic transmission between standard operation S and winter operation W.

Remote Vehicle Diagnostics

Transmission of vehicle data and current location to the Mercedes-Benz Customer Assistance Center for subscribers to Tele Aid service.

REST

(Residual engine heat utilization)
Feature that uses the engine heat stored in the coolant to heat the vehicle interior for a short time after the engine has been turned off.

Restraint systems

Seat belts, belt tensioners, airbags and child restraint systems. As independent systems, their protective functions complement one another.

Technical terms

Retractable hardtop

Hardtop that can be opened and closed at the push of a button and stored in the trunk.

Roll bar

Occupant protection system which consists of tubular steel sheathed in plastic.

RON

(Research Octane Number)
The Research Octane Number for gasoline as determined by a standardized method. It is an indication of a gasoline's ability to resist undesired detonation (knocking). The average of both the \rightarrow MON (Motor Octane Number) and RON (Research Octane Number) is posted at the pump, also known as ANTI-KNOCK INDEX.

Shift lock

When the vehicle is parked, this lock prevents the transmission selector lever from being moved out of position **P** without key turned and brake pedal depressed.

SRS

(Supplemental Restraint System)
Seat belts, emergency tensioning device and airbags. Though independent systems, they are closely interfaced to provide effective occupant protection.

Tele Aid System

(Telematic Alarm Identification on Demand)
The Tele Aid system consists of three types of response: automatic and manual emergency, roadside assistance and information. Tele Aid is initially activated by completing a subscriber agreement and placing an acquaintance call.

The Tele Aid system is operational provided that the vehicle's battery is charged, properly connected, not damaged and cellular and GPS coverage is available.

Tightening torque

Force times lever arm (e.g. a lug wrench) with which threaded fasteners such as wheel bolts are tightened.

TIREFIT

Accessory for emergency and temporary tire repair. The TIREFIT kit consists of a container with sealant material, a filler hose, a valve stem tool, a valve insert, and an air compressor.

Tire speed rating

Part of tire designation; indicates the speed range for which a tire is approved.

Traction

Force exerted by the vehicle on the road via the tires.

VIN

(Vehicle Identification Number)
The number set by the manufacturer and placed on the body to uniquely identify each vehicle produced.

Voice control system*

Voice control system for car phones, portable cell phones and audio systems (radio, CD, etc.).

Wind screen

Screen for deflecting wind from the vehicle interior when the hardtop is lowered.

Xenon headlamps*

Headlamps which use an electric arc as the light source and produce a more intense light than filament headlamps.



A

- ABS 22, 66, 287
 - Malfunction indicator lamp 201
 - Warning lamp 201
- Accelerator position, automatic transmission 98
- Accident
 - In case of 46
- Activating
 - Air conditioning 107
 - Air recirculation mode 106
 - Anti-theft alarm system 71
 - Climate control 103
 - ESP 70
 - Exterior headlamps 43
 - Hazard warning flasher 86
 - Headlamps 43
 - High beams 85
 - Ignition 29
 - Immobilizer 71
 - Rear window defroster 101
 - Residual heat 107
 - Seat heater* 82
 - Tow-away alarm 72
 - Windshield wipers 44
- Activating automatic central locking 80
- Adding
 - Coolant 181
 - Engine oil 179
- Additional turn signals 226
- Adjusting 30
 - Air distribution 105
 - Air volume 105
 - Backrest tilt 32, 33
 - Exterior rear view mirror 35
 - Head restraint height 32
 - Inside rear view mirror 35
 - Instrument cluster illumination 89
 - Manual seat 31
 - Mirrors 35
 - Seat cushion tilt 33
 - Seat fore and aft adjustment 31, 33
 - Seat height 31, 33
 - Seats 30
 - Telescoping steering column* 34
- Adjusting headlamp aim
 - Horizontal headlamp aim 232
 - Vertical headlamp aim 231
- Air conditioning 106
 - Activating 107
 - Deactivating 107
- Air conditioning refrigerant 279
- Air distribution
 - Adjusting 105
- Air pressure see Tire inflation pressure 186
- Air recirculation mode 106
 - Activating 106
 - Deactivating 106
- Air volume
 - Adjusting 105
- AIRBAG OFF indicator lamp 211
- Airbags 53
 - BabySmart™ airbag deactivation system 287
 - BabySmart™ deactivation system 62
 - Children 54
 - Front 56
 - Passenger 56
 - Safety guidelines 55
 - Side impact 57

Index

- Alarm
 - Audible 65, 71, 72
 - Canceling 71, 72
 - Visual 71
 - Alarm system
 - Anti-theft 71
 - Alignment bolt 246
 - Alignment bolt (vehicle tool kit) 287
 - Anticorrosion/antifreeze 282
 - Antiglare
 - Automatic 99
 - Antilock brake system (ABS) 287
 - Anti-theft alarm system
 - Arming 71
 - Canceling alarm 71, 72
 - Disarming 71
 - Anti-theft systems 71
 - Anti-theft alarm system 71
 - Immobilizer 71
 - Tow-away alarm 72
 - Armrest
 - Storage compartment 141
 - Ashtray 142
 - ATF (automatic transmission fluid)* 180
 - Audio system 121
 - Audio and telephone, operation 111
 - Button and soft key operation 115
 - Cassette mode 118
 - Operating and display elements 112
 - Operating safety 111
 - Operation 115
 - Radio mode 116
 - Switching off 115
 - Switching on 115
 - Telephone operation 125
- Audio systems 111
 - Automatic antiglare for rear view mirror 99
 - Automatic central locking
 - Activating 80
 - Deactivating 80
 - Automatic lighting control
 - Deactivating 87
 - Automatic locking when driving 79
 - Automatic transmission 93
 - Accelerator position 98
 - Emergency operation (Limp Home Mode) 98
 - Gear ranges 95
 - Gear selector lever position 95
 - Gear shifting malfunctions 98
 - Kickdown 98
 - Manual shifting 94
 - One-touch gearshifting 94
 - Program mode selector switch 97
 - Selector lever position 93
 - Winter program mode 97
 - Automatic transmission*
 - Fluid level 180
 - Starting with 41
 - Transmission fluid 180
- B**
- BabySmart™
 - Airbag deactivation system 62
 - Compatible child seats 62, 287
 - Self-test 63
 - BabySmart™ airbag deactivation system 287
 - Backrest tilt 31
 - Backup lamps 227, 230
 - Bulbs 227
 - BAS 67, 287

- BAS/ESP
 - Malfunction indicator lamp 200
- Batteries, Remote control
 - Check lamp 75
- Batteries, remote control
 - Changing 218
- Battery discharged
 - Jump starting 254
- Battery, vehicle 183, 251
 - Charging 252
 - Disconnecting 252
 - Reconnecting 252
 - Reinstalling 252
 - Removing 252
- Block heater 189
- Bolts
 - For spare wheel 213
- Brake assist system (BAS) 287
- Brake fluid 279
- Brake lamp bulbs 227
- Brake lamp, high mounted 227
- Brakes 162
 - Warning lamp 204
- Break-in period 160
- Bulbs, replacing 226
 - Additional turn signals 226
 - Backup lamps 227
 - Brake lamps 227
 - Fog lamps 226
 - Front lamps 226
 - High beam 226
 - High mounted brake lamp 227
 - License plate lamps 227, 231
 - Low beam 226
 - Parking lamps 226, 227, 229
 - Rear fog lamp 227
 - Rear fog lamps 230
 - Side marker lamps 226, 230
 - Standing lamps 226, 227, 229
 - Tail lamp assemblies 227, 230
 - Turn signal lamps 226, 227
- Button
 - Audio system 115
- C**
- CAC (Customer Assistance Center) 287
- California
 - Important notice 9
- Calling up
 - Service indicator 191
- CAN system 287
- Capacities
 - Fuels, coolants, lubricants, etc. 277
- Cassette mode
 - Playing cassettes 118
- Catalytic converter 169
- CD changer* 122, 215
 - Removing and installing 122
- CD mode 121
- Center console 23
 - AIRBAG OFF indicator lamp 211
 - Lower part 24
 - Storage compartment 140
 - Upper part 23

Index

- Central locking
 - From inside 80
 - Unlocking from inside 80
- Certification label 266
- Changing CDs
 - CD mode 121
- Charging
 - Vehicle battery 252
- CHECK ENGINE malfunction indicator lamp 205
- Checking
 - Coolant level 173, 180
 - Oil level 172, 175
 - Tire inflation pressure 173
 - Vehicle lighting 173
- Child safety 60
 - Airbags 54
 - Infant and child restraint systems 57, 60
- Cigarette lighter 143
- Cleaning
 - Cloth upholstery 197
 - Cup holder 196
 - Gear selector lever 196
 - Hard plastic trim items 196
 - Headliner 197
 - Instrument cluster 196
 - Leather upholstery 197
 - Light alloy wheels 196
 - Plastic and rubber parts 197
 - Rear window 195
 - Seat belts 197
 - Steering wheel 196
 - Windows 195
 - Windshield 45
 - Wiper blades 195
- Cleaning*
 - Headlamps 99
- Climate control 102
 - Adjusting air distribution 105
 - Adjusting air volume 105
 - Air conditioning 106
 - Air recirculation mode 106
 - Deactivating the climate control system 110
 - Defogging windshield 110
 - Defrosting 109
 - Reactivating the climate control system 110
- Rear window defroster 101
- Residual heat utilization 107
- Residual ventilation 107
- Setting the temperature 104
- Clock 21
 - Setting 91
- Closing
 - Glove box 139
 - Hood 175
 - Retractable hardtop 221
 - Side windows 128
 - Trunk lid 78
 - Windows 128
- Closing hardtop
 - In an emergency 221
- Cloth upholstery
 - Cleaning 197
- Cockpit 18, 287
- Coin holder 142
- Collapsible tire 287

- Combination switch 85
 - High beam flasher 44, 85
 - Turn signals 43
 - Windshield wipers 44
- Consumer information 284
- Control and operation of radio transmitters 168
- Coolant 180, 281
 - Adding 181
 - Anticorrosion/antifreeze quantity 281
 - Capacities 277
 - Checking level 180
 - Temperature 170
 - Temperature gauge 89
- Coolant level
 - Checking 173, 180
- Cruise control 136, 287
 - Canceling 137
 - Driving downhill 137
 - Driving uphill 137
 - Fine adjustment 138
 - Saving current speed 137
 - Setting speeds 138
- Cruise control lever 136
 - For cruise control 136
- Cup holder 140
 - Cleaning 196
- Customer Assistance Center (CAC) 287
- D**
- Daytime running lamp mode 84
- Deactivating
 - Air conditioning 107
 - Air recirculation mode 106
 - Alarm 71
 - Anti-theft alarm system 71
 - Climate control 103
 - Cruise control 137
 - ESP 69
 - Hazard warning flasher 86
 - Headlamps 48
 - Immobilizer 71
 - Rear window defroster 101
 - Residual heat 108
 - Seat heater* 82
 - Tow-away alarm 72
- Deactivating automatic central locking 80
- Deep water see Standing water 168
- Defogging
 - Windshield 110
- Defrosting 109
- Difficulties
 - While driving see Problems while driving 45
 - With starting 41
- Direction of rotation (tires) 186
- Discharged battery
 - Jump starting 254
- Disconnecting
 - Vehicle battery 252
- Display elements
 - Audio system 112
- Displays
 - Messages 176
 - Service indicator 190
- Door unlock
 - With Tele Aid 151
- Doors
 - Opening from inside vehicle 77
 - Opening from outside 75

Index

- Downhill driving
 - Cruise control 137
- Downshifting 92, 94
- Drink holder see Cup holder 140
- Drinking and driving 161
- Driving
 - General instructions 37, 161
 - Hydroplaning 165
 - In winter 167
 - Problems 45
 - Safety systems 66
 - Through standing water 168
 - Traveling abroad 168
- Driving instructions 161
- Driving off 163
- Driving safety systems
 - ABS 66
 - BAS 67
 - ESP 68
- Driving systems 136
 - Cruise control 136
 - Driving safety systems 66
- E**
- Electrical fuses 260
- Electrical system
 - Technical data 274
- Electronic Stability Program see ESP 22, 68, 288
- Emergency call system 145
 - Requirements 145
- Emergency calls
 - Initiating an emergency call 147
 - With Tele Aid 146
- Emergency operation (Limp Home Mode) 98
- Emergency operations
 - Closing hardtop 221
 - Opening hardtop 221
 - Releasing trunk lid from inside 78
 - Remote door unlock 151
 - Unlocking the vehicle 216
- Emergency tensioning device see ETD 60, 288
- Emission control 170
- Emission control label 266
- Engine
 - Compartment 174
 - Starting with automatic transmission* 41
 - Starting with manual transmission 40
 - Starting with the key 40, 41
 - Technical data 268
 - Turning off with the key 48
- Engine cleaning 194
- Engine compartment 174
 - Hood 174
- Engine malfunction indicator lamp 21, 205
- Engine number 288
- Engine oil 175, 279
 - Adding 179
 - Additives 279
 - Checking level 175
 - Consumption 175
 - Messages in display 176
 - Oil dipstick 179
 - Viscosity 288
- Engine oil level see Oil level 172
- ESP 22, 68, 288
 - Switching off 69
 - Switching on 70
 - Synchronizing 202

Warning lamp 200
 ETD 288
 Safety guidelines 55
 ETD (Emergency tensioning device) 60
 Exterior lamp switch 83
 Exterior rear view mirrors
 Adjusting 35

F

Fastening the seat belts 37
 Fine adjustment
 Cruise control 138
 First aid kit 212
 Flat tire 235
 Lowering the vehicle 248
 Mounting the spare wheel 244
 Preparing the vehicle 235
 TIREFIT 214, 215
 Flexible Service System (FSS) 190, 288
 Fog lamp, rear 84, 227
 Fog lamps
 Replacing bulbs 226
 Fog lamps, front
 Replacing bulbs 227
 Switching on 84
 Front airbags 56

Front lamps
 Replacing bulbs 226, 228
 Switching on 83
 Front seats
 Heater* 82
 FSS (Flexible Service System) 190, 288
 Fuel 171
 Additives 280
 Fuel reserve warning lamp 207
 Gasoline additives 280
 Premium unleaded gasoline 171,
 280
 Requirements 280
 Reserve warning 21
 Technical data 277
 Fuel additives 280
 Fuel filler flap 171
 Locking 171
 Opening 219
 Unlocking 171
 Fuel requirements 280
 Fuel tank
 Capacity 278
 Filler flap 171

Fuels, coolants, lubricants etc.
 Capacities 277
 Fuse chart 260
 Fuse extractor 260
 Fuses 260
 Auxiliary fuse box 261
 Fuse chart 260
 Fuse extractor 260
 Main fuse box 260
 Spare fuses 260

G

Garage door opener 25, 153
 Gasoline see Fuel 171
 Gasoline additives 280
 Gear range 288
 Automatic transmission 95
 Limiting 95
 Shifting into optimal 94
 Gear range limit
 Canceling 94
 Gear selector lever
 Cleaning 196
 Position 95

Index

Global
 Locking 75
 Unlocking 75
Global Positioning System (GPS) 288
Glove box 19, 139
 Closing 139
 Opening 139
Good visibility 99
GPS 288

H

Hands-free microphone 25
Hard plastic trim items
 Cleaning 196
Hazard warning flasher 86
 Switching off 86
 Switching on 86
Head restraints 81
 Installing 81
 Manual seats 32
 Removing 81
Headlamp cleaning system 184

Headlamps
 Cleaning 194
 Cleaning system 184
 Cleaning system* 99
 Refilling washer fluid 184
 Switching off 48
 Switching on 43
 Washer fluid 283
 Washer system 283
 Xenon* 291
Headliner
 Cleaning 197
Heated seats* 82
Height adjustment
 Head restraints 32
 Telescoping steering column* 34
High beam flasher 44, 85
High beam headlamps
 Replacing bulbs 226, 228
 Switching on 85
High mounted brake lamp 227
Hood 174
 Closing 175
 Opening 174
Hydroplaning 165

I

Identification labels 266
 Certification label 266
 Vehicle Identification Number (VIN) 266
Ignition 29
 Switching on 40, 41
Immobilizer 71
 Activating 71
 Deactivating 71
Infant and child restraint systems 60
Information
 About service and warranty 8
 Button for Tele Aid 149
Inside rear view mirror
 Adjusting 35
Installing
 Towing eye bolt 259
 Wiper blades 234
Instrument cluster 20, 89, 288
 Cleaning 196
 Coolant temperature gauge 89
 Illumination 89
 Lamps in 207
 Outside temperature indicator 91
Instruments and controls see Cockpit 18

- Interior lighting 87
 - Automatic control 87
 - Deactivating automatic control 87
 - Manual control 88
 - Manual operation 88
- Interior storage spaces 139
 - Cup holder 140
 - Glove box 139
 - Parcel net in front passenger footwell 141
 - Storage compartment in armrest 141
 - Storage compartment in center console 140
- J**
- Jack 212
- Jump starting 254
- K**
- Key 216
 - Positions in steering lock 29
 - Remote control 74
 - Starting the engine 40, 41
- Key positions in steering lock 29
- Key, Remote control
 - Loss of 76
- Keys 74
- Kickdown 98, 288
- L**
- Labels, identification 266
- Lamp bulbs, exterior 226
- Lamps, exterior
 - Front 226
 - Rear 227
- Lamps, indicator and warning
 - ABS 201
 - Airbag Off 56
 - Battery (Remote control) 75
- Brakes 204
- CHECK ENGINE 205
- Engine diagnostics 205
- ESP 200
- Fuel reserve 207
- Instrument cluster 207
- Seat belts 205
- Service indicator 190
- SRS 52
- Turn signals 21
- Lamps, malfunction indicator
 - BAS/ESP 200
- Layout of poly-V-belt drive 267
- Leather upholstery
 - Cleaning 197
- License plate lamps
 - Replacing bulbs 227, 231
- Light alloy wheels
 - Cleaning 196
 - Technical data 270
- Lighter see Cigarette lighter 143
- Lighting 83
 - Combination switch 85
 - Daytime running lamp mode 84
 - Exterior lamp switch 83
 - Front fog lamps 84

Index

- High beam flasher 85
- High beams 85
- Instrument cluster illumination 89
- Interior 87
- Low beam 83
- Parking lamps 83
- Rear fog lamp 84
- Trunk 88
- Limiting the gear range 95
- Limp Home Mode 98
- Lock buttons 289
- Locking 47, 74
 - Centrally from inside 80
 - Driver's door and trunk in an emergency 217
 - Fuel filler flap 171
 - Global, Remote control 75
- Loss of keys 76
- Loss of Service and Warranty Information Booklet 265
- Low and high beam headlamps (Xenon* headlamps only) 228
- Low beam headlamps
 - Replacing bulbs 226, 228
- Lowering
 - Vehicle 248
- Lubricants
 - Technical data 277
- M**
- Main dimensions 275
- Maintenance 10, 190
- Manual operations
 - Fuel filler flap 219
 - Hardtop 221
 - Interior lighting control 88
 - Locking the driver's door and trunk 217
 - Unlocking the driver's door 216
 - Unlocking the trunk 216
 - Unlocking transmission selector lever 220
- Manual seat
 - Adjusting 31
 - Adjusting backrest tilt 32
 - Adjusting head restraint height 32
 - Adjusting seat height 31
 - Seat fore and aft adjustment 31
- Manual transmission 92
 - Shifting into reverse 92
 - Starting with 40
- Microphone
 - Hands-free microphone 25
- Mirrors
 - Adjusting 35
 - Automatic antiglare for rear view mirror 99
 - Exterior rear view mirror 35
 - Inside rear view mirror 35
- MON 171
- MON (Motor Octane Number) 289
- N**
- Night security illumination 88
- O**
- Occupant safety 52
 - Airbags 53
 - Children and airbags 54
 - Children in the vehicle 60
 - Fastening the seat belt 37
 - Infant and child restraint systems 60
 - Seat belts 37, 55
- Odometer, main 21

- Oil
 - Adding 179
 - Consumption 175
 - Dipstick 175
 - Oil dipstick 179
 - Viscosity 288
- Oil level
 - Checking 172
- One-touch gearshifting 94
 - Canceling gear range limit 94
 - Downshifting 94
 - Upshifting 94
- Opening
 - Ashtray 142
 - Doors from the inside 77
 - Fuel filler flap 171
 - Fuel filler flap manually 219
 - Glove box 139
 - Hardtop in an emergency 221
 - Hood 174
 - Retractable hardtop 221
 - Side windows 128
 - Trunk 77
 - Windows 128
- Operating
 - Audio system 111
 - Radio transmitters 168
 - Safety 14
 - Telephone 111
 - Telephone* 125
 - Vehicle outside the USA and Canada 11
- Operating safety 14
 - Audio system 111
- Operator's Manual 8
- Ornamental moldings 194
- Outside temperature indicator 91
- Overdue service 191
- Overhead control panel 25
- Overspeed range 289
- P**
- Paintwork 193
- Panic alarm 65
 - Panic button on remote control 65
- Parcel net
 - In front passenger footwell 141
- Parking 47, 163
 - Parking brake 42, 47
 - Engaging 47
 - Releasing 42
 - Parking lamps
 - Replacing bulbs 226, 227, 229
 - Switching on 83
 - Parts see Spare parts service 264
 - Passenger compartment 168
 - Inside rear view mirror 35
 - Interior lighting 87
 - Parcel net in front passenger footwell 141
 - Passenger safety see Occupant safety 52
 - Pedals 161
 - Plastic and rubber parts
 - Cleaning 197
 - Playing
 - CDs 123
 - Poly-V-belt drive 289
 - Layout 267
 - Power assistance 162
 - Power seat*
 - Adjusting backrest tilt 33
 - Adjusting seat cushion tilt 33

Index

- Adjusting seat height 33
- Seat fore and aft adjustment 33
- Power train 289
- Power washer 193
- Power windows 128
 - Side windows 128
 - Stopping windows 128
 - Synchronizing 129
- Practical hints
 - First aid kit 212
 - Fuses 260
 - Lamp in center console 211
 - Lamps in instrument cluster 200
 - Spare wheel bolts 213
 - TIREFIT 214, 215
 - Towing the vehicle 256, 258, 259
 - Vehicle tool kit 212
- Premium unleaded gasoline 280
- Problems
 - While driving 45
 - With vehicle 15
- Product information 7
- Program mode selector switch 289
 - Automatic transmission 97

R

- Radio mode 116
- Radio see Radio mode
- Radio transmitters, control and operation 168
- Rapid seat heating*
 - Switching on 82
- Rear fog lamp 227
 - Bulb 227
 - Switching on 84
- Rear lamp bulbs
 - Replacing 230
- Rear view mirror automatic antiglare 99
- Rear view mirrors see Mirrors
- Rear window
 - Cleaning 195
- Rear window defroster 101
 - Activating 101
 - Deactivating 101
- Reconnecting
 - Vehicle battery 252

- Refrigerant
 - Air conditioning 279
- Refueling 171
- Regular checks 172
- Reinstalling vehicle battery 252
- Remote control
 - Battery check lamp 75
 - Changing batteries 218
 - Checking the batteries 76
 - Global locking 75
 - Key 74
 - Restoring to factory setting 75
 - Selective setting 75
 - Unlocking with 28
- Remote control with folding key
 - Locking and unlocking 74
- Remote control, key
 - Factory setting 75
 - Global unlocking 75
- Remote door unlock
 - With Tele Aid 151
- Remote Vehicle Diagnostics 289

- Removing
 - Vehicle battery 252
 - Wheel 246
 - Wiper blade insert 233
 - Wiper blades 233
- Replacing
 - Backup lamp bulbs 230
 - Brake lamp bulbs 230
 - Bulbs 226
 - Front lamp bulbs 228
 - Front turn signal bulbs 228
 - Fuses 260
 - High beam bulbs 228
 - License plate lamp bulbs 231
 - Low beam bulbs 228
 - Parking lamp bulbs 229
 - Rear fog lamp bulbs 230
 - Rear lamp bulbs 227, 230
 - Rear turn signal bulbs 230
 - Side marker lamp bulbs 230
 - Standing lamp bulbs 229
 - Wiper blades 233
- Reporting
 - Safety defects 16
- Resetting
 - Service indicator (FSS) 191
 - Trip odometer 90
- Residual heat utilization 107, 289
- Residual ventilation 107
- REST (Residual engine heat utilization) 289
- Restraint system 289
- Restraint system see Infant and child restraint systems 60
- Retractable hardtop 130, 290
 - Closing 133, 221
 - Locking after raising/lowering 134
 - Opening 132, 221
 - Problems when operating 134
- Reverse (manual transmission)
 - Shifting into 92
- Rims 269
- Roadside assistance 10
 - Tele Aid 148
- Roll bar 290
- RON 171
- RON (Research Octane Number) 290
- Rotating wheels 187
- Rubber parts
 - Cleaning 197
- S**
- Safety
 - Occupant 52
 - Safety belts see Seat belts 37
 - Safety defects
 - Reporting 16
 - Safety systems
 - Driving 66
 - Saving current speed 137
 - Seat belts 57
 - Cleaning 197
 - Fastening 37
 - Proper use of 39, 59
 - Safety guidelines 55
 - Warning lamp 205
 - Seat heater*
 - Switching off 82
 - Switching on 82
 - Seats 81
 - Adjusting 30
 - Heater* 82
 - Manual 31

Index

- Rapid seat heating* 82
- Selector lever 21
 - Lock 41
 - Position (automatic transmission) 93
 - Position (automatic transmission*) 21
- Self-test
 - BabySmart™ airbag deactivation system 63
 - Tele Aid* 145
- Service
 - Calling up the service indicator 191
 - Major service (Service B) 190
 - Minor service (Service A) 190
 - Overdue 191
 - Spare parts 264
 - Types 191
 - When due 190
- Service (maintenance) 190
- Service and Warranty Booklet
 - Loss of 265
- Service and warranty information 8
- Service indicator 190
 - Calling up 191
 - Clearing 190, 191
- Service life (tires) 186
- Service System see FSS 190
- Setting
 - Clock 91
 - Cruise control 137
 - Higher speed in cruise control 138
 - Lower speed in cruise control 138
 - Slower speed in cruise control 138
 - Speed in cruise control 138
 - Temperature (interior) 104
- Settings
 - Factory, Remote control 75
 - Selective 75
- Shelf behind roll bar 141
- Shift lock 290
- Shifting
 - Gear selector lever positions 95
 - Into optimal gear range (automatic transmission) 94
 - Into reverse (manual transmission) 92
- Side impact airbags 57
- Side marker lamps
 - Replacing bulbs 226, 227, 230
- Side windows
 - Automatic opening 128
 - Cleaning 195
 - Closing 128
 - Opening 128
 - Opening fully 128
 - Synchronizing power windows 129
- Simultaneous wiping and washing
 - Windshield wipers 45
- Single wipe 45
- Snow chains 189
- Soft keys
 - Audio system 115
- Spare fuses 260
- Spare parts service 264
- Spare wheel
 - Bolts 213
 - Mounting 244

- Speed
 - Saving current 137
- Speed settings
 - Cruise control 138
- Speedometer 21
- SRS 59, 290
 - Indicator lamp 203
- Standing lamps 83
 - Replacing bulbs 226, 227, 229
- Standing water
 - Driving instructions 168
- Starting difficulties 41
- Starting position 29
- Starting the engine 40
- Steering column
 - Height adjustment 34
 - Length adjustment 34
- Steering lock 19, 29
 - Positions 29
- Steering wheel
 - Adjustment 34
 - Cleaning 196
- Stolen vehicle
 - Tracking services 152
- Storage compartments 140
 - Armrest 141
 - Center console 140
 - Glove box 139
- Sun visors 100
- Supplemental Restraint System (SRS) 290
- Switching off
 - Audio system 115
 - Engine 48
 - ESP 69
 - Hazard warning flasher 86
 - Headlamps 48
 - Seat heating* 82
- Switching on
 - Audio system 115
 - ESP 70
 - Front fog lamps 84
- Hazard warning flasher 86
- Headlamps 43
- High beams 85
- Rapid seat heating* 82
- Rear fog lamp 84
- Seat heating* 82
- Windshield wipers 44
- Synchronizing
 - ESP 202
 - Power windows 129
- Synchronizing the remote control 219
- T**
- Tachometer 21, 90
 - Displaying gear range 95
 - Overspeed range 90
- Tail lamps
 - Cleaning 194
 - Replacing bulbs 227, 230
- Tar stains 193
- Technical data 279

Index

- Brake fluid 279
- Coolant 277
- Coolants 281
- Electrical system 274
- Engine 268
- Engine oil 279
- Engine oil additives 279
- Fuel requirements 280
- Fuels 277
- Gasoline additives 280
- Lubricants 277
- Main dimensions 275
- Premium unleaded gasoline 280
- Rims and tires 269
- Weights 276
- Windshield and headlamp washer*
system 278, 283
- Tele Aid 144
 - Emergency calls 146
 - Information 149
 - Initiating an emergency call
manually 147
 - Remote door unlock 151
- Roadside assistance 148
- Stolen vehicle tracking services 152
- System self-check 145
- Tele Aid System 145
- Upgrade signals 150
- Tele Aid System 290
- Telephone* 143
 - Hands-free microphone 25
 - Operation 125
- Telescoping steering column*
Adjusting 34
- Temperature
 - Grades of tires 285
 - Setting interior temperature 104
 - Tires 187
- Tightening torque 290
- Tightening torque (Wheel bolts) 248
- Tire inflation pressure 242
 - Checking 173, 186
- Tire speed rating 166, 291
- Tire traction 165
- TIREFIT 290
- TIREFIT kit
 - Sealing tires with TIREFIT 235, 240
 - TIREFIT kit 1 235
 - TIREFIT kit 2 240
- TIREFIT-Kit
 - Adding TIREFIT 237
 - Inflating the tire 238
 - Preparing TIREFIT 236, 241
- Tires 185, 269
 - Collapsible 287
 - Consumer information 284
 - Direction of rotation 186
 - Driving instructions 164
 - Retreads 185
 - Rims and tires 269
 - Service life 186
 - Temperature 187

- Temperature grades 285
- Tread depth 188
- Wear pattern 187
- Winter 188
- Tools 212
- Tow-away alarm 23, 72
 - Arming 72
 - Disarming 72
 - Disarming for transport 72
- Towing eye bolt (vehicle tool kit)
 - Installing 259
- Towing the vehicle 256, 258, 259
- Tracking services
 - For stolen vehicle 152
- Traction 97, 284, 291
- Transmission see Automatic transmission* 180
- Transmission selector lever 220
 - Unlocking manually 220
- Traveling abroad 168
- Tread depth (tires) 188
- Treadwear 284
- Trip odometer
 - Resetting 90

- Trunk
 - Closing the lid 78
 - Lighting 88
 - Opening 77
 - Trunk lid emergency release 78
- Trunk lid
 - Closing 78
- Turn signal lamps
 - Replacing bulbs 226, 227
- Turn signals 43
 - Additional in mirrors 226
 - Cleaning lenses 194
 - Front bulbs 226, 229
 - Indicator lamps 21
 - Rear bulbs 227, 230
- Turning off
 - Engine 48

U

- Unlocking 28, 74
 - Centrally from inside 80
 - Driver's door in an emergency 216
 - Fuel filler flap 171
 - Global 75
 - In an emergency 216
 - Selective settings 75
 - Transmission selector lever
 - manually 220
 - Trunk in an emergency 216
 - Vehicle in an emergency 151
 - With the remote control 28
- Upgrade signals
 - Tele Aid 150
- Uphill driving
 - Cruise control 137
- Upshifting 94
- Useful features 139
 - Ashtray 142
 - Cigarette lighter 143
 - Interior storage spaces 139
 - Tele Aid 144
 - Telephone* 143

Index

V

- Vehicle
 - Battery 251
 - Locking 23
 - Lowering 248
 - Proper use of 14
 - Towing 256, 258, 259
 - Unlocking 23
 - Unlocking in an emergency 216
- Vehicle battery 251
- Vehicle care 192
 - Cloth upholstery 197
 - Cup holder 196
 - Engine cleaning 194
 - Gear selector lever 196
 - Hard plastic trim items 196
 - Headlamps 194
 - Instrument cluster 196
 - Leather upholstery 197
 - Light alloy wheels 196
 - Ornamental moldings 194
 - Paintwork 193

- Plastic and rubber parts 197
- Power washer 193
- Rear window cleaning 195
- Seat belts 197
- Steering wheel 196
- Tail lamps 194
- Tar stains 193
- Turn signals 194
- Vehicle washing 194
- Window cleaning 195
- Wiper blades 195
- Vehicle Identification Number (VIN) 266
- Vehicle lighting
 - Checking 173
- Vehicle tool kit 212
 - Alignment bolt 212
 - Spare fuses 212
 - Special fuse puller 212
 - Towing eye bolt 212
- Vehicle jack 212
- Wheel bolts 212
- Wheel wrench 212
- Vehicle washing 194

- VIN (Vehicle Identification Number) 266, 291
- Voice control system* 25, 291
 - Hands-free microphone 25

W

- Warning sounds
 - Drivers seat belts 57
 - Parking brake 42
- Warranty coverage 265
- Washer fluid see Windshield washer fluid
- Washing the vehicle 192
- Wear pattern (tires) 187
- Weights 276
- Wheel change
 - Tightening torque 248
- Wheels
 - Rotating 187
 - Tires and wheels 185
- Wind screen 135, 291
 - Installing 135
 - Removing 135

- Windows see Side windows
 - Windshield
 - Defogging 110
 - Refilling washer fluid 184
 - Replacing wiper blades 233
 - Washer fluid 184, 283
 - Washer system 283
 - Windshield washer fluid 283
 - Filler neck 184
 - Mixing ratio 283
 - Refilling 184
 - Wiping with 45
 - Windshield washer system 283
 - Windshield wipers 44
 - Fast wiper speed 44
 - Replacing wiper blades 233
 - Single wipe 45
 - Switching on 44
 - Wiping with windshield washer fluid 45
 - Winter driving 188
 - Block heater 189
 - Snow chains 189
 - Tires 188
 - Transmission program mode 97
 - Winter driving instructions 167
 - Winter tires 188
 - Wiper blades
 - Cleaning 195
 - Installing 234
 - Removing 233
 - Removing insert 233
 - Replacing 233
 - Wiping
 - And washing simultaneously 45
 - Interval 44
 - With windshield washer fluid 45
- X**
- Xenon headlamps* 291



Service and Literature

Your authorized Mercedes-Benz Center has trained technicians and original Mercedes-Benz parts to service your vehicle properly. For expert advice and quality service, see your authorized Mercedes-Benz Center.

If you are interested in obtaining service literature for your vehicle, please contact your authorized Mercedes-Benz Center. We consider this the best way for you to obtain accurate information for your vehicle.

For further information you can find us on the Mercedes-Benz web-site www.mbusa.com or www.mercedes-benz.ca.

Warning!



To help avoid personal injury, be extremely careful when performing any service work or repairs. Improper or incomplete service or the use of incorrect or inappropriate parts or materials may damage the vehicle or its equipment, which may in turn result in personal injury.

If you have questions about carrying out any type of service, turn to the advice of an authorized Mercedes-Benz Center.

We reserve the right to modify the technical details of the vehicle as given in the data and illustrations of this Operator's Manual. Re-printing, translation and copying, even of excerpts, is not permitted without our prior authorization in writing.

Title illustration no. P00.01-2290-31

Press time 08 / 20 / 03

GSP / TIP

Printed in Germany

Free Manuals Download Website

<http://myh66.com>

<http://usermanuals.us>

<http://www.somanuals.com>

<http://www.4manuals.cc>

<http://www.manual-lib.com>

<http://www.404manual.com>

<http://www.luxmanual.com>

<http://aubethermostatmanual.com>

Golf course search by state

<http://golfingnear.com>

Email search by domain

<http://emailbydomain.com>

Auto manuals search

<http://auto.somanuals.com>

TV manuals search

<http://tv.somanuals.com>