

MERIDIAN G SERIES  
G61 DIGITAL SURROUND CONTROLLER  
INSTALLATION GUIDE



BOOTHROYD STUART  
**MERIDIAN**

# G61 Digital Surround Controller Installation Guide

## Important safety instructions

- Read the instructions.
- Keep these instructions.
- Follow all instructions.
- Do not use this apparatus near water.
- Clean only with a dry cloth.
- Install only in accordance with the manufacturer's instructions.
- Refer all servicing to approved service personnel.

WARNING: TO REDUCE THE RISK OF FIRE OR ELECTRIC SHOCK, DO NOT EXPOSE THIS APPARATUS TO RAIN OR MOISTURE

This apparatus has been designed with Class 1 construction and must be connected to a mains socket outlet with a protective earthing connection (the third grounding pin).

### Safety warnings

- Do not expose the product to dripping or splashing.
- Do not place any object filled with liquid, such as a vase, on the product.
- Do not place naked flame sources, such as lighted candles, on the product.

### To avoid interference

Do not position the product:

- Near strong magnetic radiation, such as near a power amplifier.
- Near to a television, or where connecting cables may be subject to or cause interference.

### To avoid overheating

- Leave at least 10cm around the equipment to ensure sufficient ventilation.

Do not position the product:

- In direct sunlight.
- Near heat sources, such as a radiator.
- Directly on top of heat producing equipment, such as a power amplifier.
- On a soft surface, such as a carpet, which would obstruct the ventilation holes in the base.

The product normally runs warm to the touch.

### Radio interference

**FCC Warning:** This equipment generates and can radiate radio frequency energy and if not installed and used correctly in accordance with our instructions may cause interference to radio communications or radio and television reception. It has been type-tested and complies with the limits set out in Subpart J, Part 15 of FCC rules for a Class B computing device. These limits are intended to provide reasonable protection against such interference in home installations.

**EEC:** This product has been designed and type-tested to comply with the limits set out in EN55013 and EN55020.



# Contents

Introduction	1	DSP presets	33
Provides information about the digital surround controller, and technical specifications.		Gives details of the DSP presets and their parameters, and describes how to modify them.	
<b>Specifications</b>	<b>3</b>	<b>DSP presets</b>	<b>33</b>
Installing the digital surround controller	5	<b>Defining your own presets</b>	<b>43</b>
Describes how to install the digital surround controller and connect it to the other equipment in the system.		Troubleshooting	45
<b>Unpacking</b>	<b>5</b>	Provides suggested solutions to problems while installing, configuring, or operating the product.	
<b>Audio inputs</b>	<b>6</b>	<b>Maintenance</b>	<b>49</b>
<b>Audio outputs</b>	<b>9</b>	<b>Service and guarantee</b>	<b>50</b>
<b>Communications connections</b>	<b>13</b>	Index	51
Configuring the digital surround controller	15		
Explains how to configure the digital surround controller using the front-panel controls.			
<b>Configuration Wizard</b>	<b>15</b>		
<b>Stage 1: Resetting the product</b>	<b>16</b>		
<b>Stage 2: Configuring speakers</b>	<b>18</b>		
<b>Stage 3: Configuring sources</b>	<b>20</b>		
<b>Stage 4: Configuring other settings</b>	<b>22</b>		
Calibrating the system	25		
Describes how to fine-tune the digital surround controller to achieve the optimum performance from your sources and speaker layout.			
<b>Introduction</b>	<b>25</b>		
<b>Calibration tests</b>	<b>27</b>		
<b>Speaker size</b>	<b>29</b>		
<b>Using the Sine/Sub/Sens controls</b>	<b>30</b>		

## Copyright and acknowledgements

### Sales and service in the UK

Meridian Audio Ltd  
Latham Road  
Huntingdon  
Cambridgeshire  
PE29 6YE  
England

Tel +44 (0)1480 445678

Fax +44 (0)1480 445686

World Wide Web – <http://www.meridian-audio.com/>

Copyright © 2003-2005 Meridian Audio Ltd

Designed and manufactured in the UK by Meridian Audio Ltd. Meridian Audio reserves the right to make changes and improvements to any of the products described in this document without prior notice.

Dolby, Dolby Digital, Pro Logic, AC-3, PLII, PLIIx, AAC, and the double-D symbol are trademarks of Dolby Laboratories Licensing Corporation. Lucasfilm, THX, and THX Cinema are registered trademarks of Lucasfilm Ltd. Surround EX is a jointly developed technology of THX and Dolby Laboratories, Inc and is a trademark of Dolby Laboratories, Inc. All rights reserved. Used under authorisation. DTS is a registered trademark of Digital Theatre Systems Inc. MPEG is a registered trademark of the MPEG organisation. Ambisonic is a registered trademark of Nimbus Records Ltd. Trifield is a trademark of Trifield Productions Ltd. LaserDisc is a trademark of Pioneer Electric Corp.

Part no: G61/1

### Sales and service in the USA

Meridian America Inc  
8055 Troon Circle  
Suite C  
Austell  
GA30168-7849  
USA

Tel +1 (404) 344 7111

Fax +1 (404) 346 7111

Boothroyd|Stuart Meridian, Meridian, and Meridian Digital Theatre are registered trademarks of Meridian Audio Ltd.

This guide was produced by Human-Computer Interface Ltd, <http://www.interface.co.uk/>

Manufactured under license from Dolby Laboratories, Lucasfilm Ltd. (US patents 5,043,970;5,189,703;5,222,059. European patent 0323830), Trifield Productions Ltd, and Nimbus Records Ltd.

**MHR:** This product incorporates copyright protection technology covered by certain patent applications and intellectual property of Meridian Audio Ltd. This technology is provided for the express purpose of securely containing copyright audio within the Meridian System only. Reverse engineering or circumvention of this protection is strictly prohibited.

# Introduction

This guide provides full information about unpacking the G61 Digital Surround Controller, connecting it to the other equipment in the system, and configuring it using the front panel. Once you have connected and configured the product, refer to the *G Series System Guide* for information about operating it.

The G61 is a powerful, flexible surround controller, with 8 unbalanced analogue outputs and 10 digital outputs.

At the heart of the G61 is a powerful DSP engine consisting of three Motorola 56367s running at 150MHz – delivering an incredible 450MIPS (million instructions per second) capability. Processing is performed at high sample rates and with 48-bit precision throughout, ensuring that all filtering, processing, and other operations are carried out beyond the limits of human hearing. The G61 is thus a perfect processor for the very latest in digital audio, such as DVD-Audio and DVD-Video.

## Inputs

Analogue signals are converted via a 24-bit Delta-Sigma converter to high-sample-rate digital on input to the processor, while all digital signals are reclocked to minimise jitter and maintain total data integrity. All versions of the G61 include two six-channel S/PDIF digital inputs (coax), five Toslink optical inputs, and six

more stereo coax digital inputs. In addition, there is a six-channel analogue input, and five stereo analogue inputs.

## Formats supported

The G61 combines controller and surround processor functions, meeting the latest THX specifications and including MPEG, DTS, Dolby, Trifield, and Ambisonic decoding. In many cases the decoders incorporate our own code, giving them superior integration with the Meridian design philosophy, as well as superior performance. As a result, the G61 can decode surround signals from all PCM optical discs. The G61 is thus an ideal complement to a G Series optical disc player like the G98.

## Smart Source feature

The G61's 'Smart Source' feature continually monitors the digital inputs and automatically loads the correct decoding software for the format, speaker layout, and encoding of the incoming signal. This capability is enhanced by MHR SmartLink, which provides a digital link between a Meridian optical disc player and processor,

carrying explicit information about the nature of the datastream as well as encrypted high-resolution digital signals from DVD-Audio – the first system of its kind to be approved. Virtually all other manufacturers oblige you to go through an analogue connection, losing quality in the process.

You can also store separate parameters for each source (such as DVD) depending on whether the incoming signal is stereo or surround, so that any source material is played with the DSP mode of your choice.

# Specifications

<b>Digital coax inputs</b>	6 coax digital inputs, 2 6-channel coax inputs, all MHR.
<b>Digital optical inputs</b>	5 optical digital inputs.
<b>Analogue inputs</b>	5 stereo unbalanced inputs; 1 6-channel unbalanced input.
<b>Digital outputs</b>	Main, Centre/Sub, Sides, Rears, A/B*.
<b>Unbalanced outputs</b>	Main L/R, Centre/Sub, Rears, LZ, RZ†.
<b>Trigger outputs</b>	3 12VDC/100mA trigger outputs configurable by source.
<b>Comms</b>	2 5-pin 240° DIN sockets, BNC socket, USB, RS232 interface.
<b>Conversion</b>	Up to 192kHz, 24-bit Sigma-Delta conversion on all analogue inputs and outputs.
<b>Formats</b>	Include Dolby Digital, DTS, MPEG Surround, and AAC.
<b>DSP modes</b>	Direct, Music, Trifield, Ambisonics, Super, Stereo, MusicLogic, Mono, TV Logic, PLIIx Music, PLIIx Movie, PLIIx THX, Discrete, Cinema, PLIIx Mov6, PLIIx Mus6, THX, THX Surround EX, THX Ultra2 Cinema, THX Music.
<b>Power</b>	Universal supply 100-240V, 50-60Hz, 40W.
<b>Processing</b>	3 Motorola 56367s running at 150MHz to give a total of approximately 450MIPS. 48-bit arithmetic throughout.
<b>Dimensions</b>	440mm x 90mm x 350mm (17.32" x 3.54" x 13.78") WHD.
<b>Weight</b>	((to be added))
<b>Controls</b>	Front-panel soft keys include control of Source, Preset, etc. Standby and display buttons, volume control, mute. Full remote control of all features via MSR+.
<b>Display</b>	Multi-character dot-matrix Vacuum Fluorescent Display.
<b>Indicators</b>	Standby button lit when off.

\*A/B: Subs if two or three subs are used. Optional ceiling speakers with future software update.

†LZ/RZ: May be chosen to be any pair from: Main L/R, Centre/Sub, Sides, Rears, Subs.

**Note:** Current software supports a maximum of eight outputs. Future software will support up to 12.





# Installing the digital surround controller

This chapter explains how to install the digital surround controller. It describes what you should find when you unpack the product, and how you should connect it to the other equipment in the system.

You should not make any connections to the product or to any other component in the system while the AC power supply is connected and switched on.

## Unpacking

The G61 Digital Surround Controller is supplied with the following accessories:

- MSR+ remote control with batteries, manual, and spare key caps.
- Meridian Comms lead.
- Power cord.
- This manual.
- *Meridian G Series System Guide*.

If any of these items are missing please contact your dealer.

**Note:** You should retain the packaging in case you need to transport the unit.

## Audio inputs

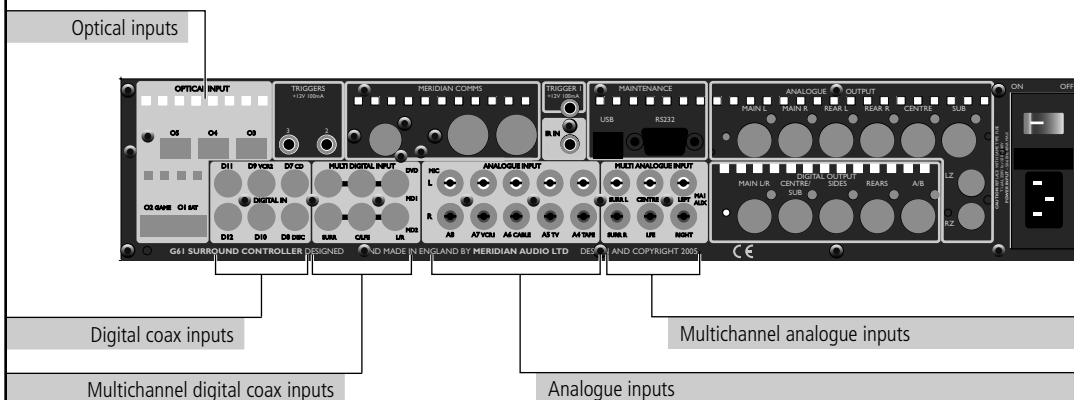
**Use this connector**

MULTI DIGITAL INPUT 1 (DVD) or D1-D3,  
MULTI DIGITAL INPUT 2 or D4-D6

DIGITAL INPUT D7 (CD), D8 (DISC), D9  
(VCR2), D10-D12

MULTI ANALOGUE INPUT (AUX) or A1-A3

ANALOGUE INPUT A4 (TAPE), A5 (TV),  
A6 (CABLE), A7 (VCR1)

OPTICAL INPUT O1 (SAT), O2 (GAME), O3-O5

**To connect to this**

The multichannel digital output of a source such as the G98DH DVD Audio Transport, or three digital sources.

The digital output of a source such as a G08 24-bit Upsampling CD Player or DAB tuner.

A multichannel analogue source such as an SACD player.

The unbalanced analogue output of a source such as a tape recorder, TV tuner, cable box, or VCR.

The optical output of a source such as a satellite receiver or computer game console.

The default assignment of the sources to each input is shown in brackets after the input name in the above table. To assign a different input to a source see *Configuring sources*, page 20 .

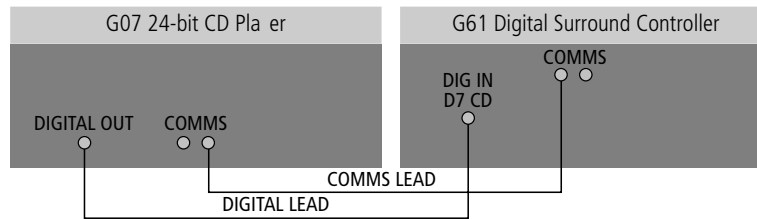
**To connect to a digital source (eg G07 24-bit CD Player)**

You can connect up to 12 digital coax sources to the G61 Digital Surround Controller.

If the source is a Meridian product connect together the COMMS sockets using the Comms lead provided.

- Connect the digital source to one of the digital input sockets of the digital surround controller, using a 75Ω screened coax phono lead.

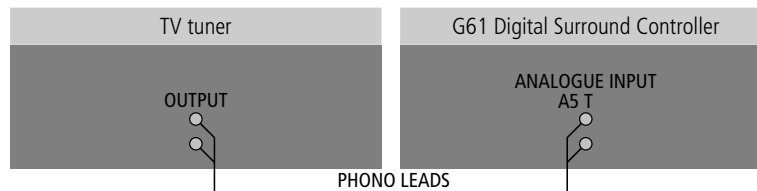
**To connect to an analogue source (eg TV tuner)**

You can connect up to eight analogue sources to the G61 Digital Surround Controller.

- Connect the analogue source to one of the analogue input sockets of the digital surround controller, using screened coax phono leads.

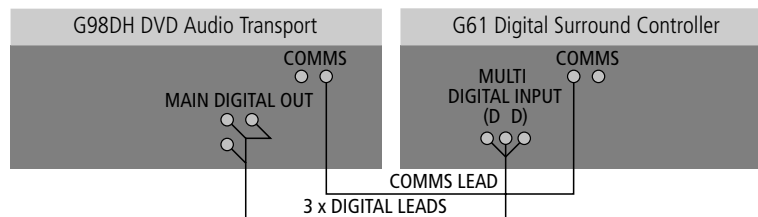
**To connect to a DVD-Audio player with digital multichannel outputs (eg G98DH DVD Audio Transport)**

The G61 Digital Surround Controller provides 12 digital coax inputs, six of which can be used as two multichannel inputs from a source with a suitable digital multichannel output, such as the G98DH DVD Player.

- Connect the MAIN DIGITAL OUT on the G98DH to the MULTI DIGITAL INPUT 1 on the G61, using three 75Ω screened coax phono leads.
- Connect together the COMMS sockets using the Comms lead provided.

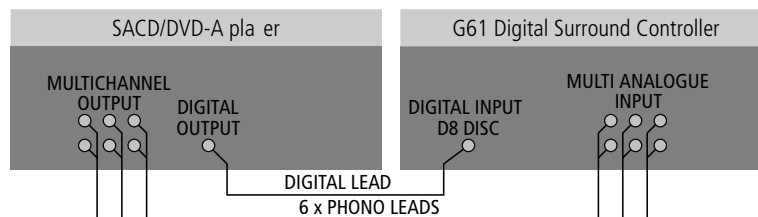
**To connect to a source with analogue multichannel outputs (eg SACD or DVD-A player)**

The G61 Digital Surround Controller provides eight analogue inputs, three of which can be used as a multichannel input from a source with a suitable analogue multichannel output, such as an SACD player.

- Connect the ANALOGUE OUTPUT sockets from the source to the analogue multichannel inputs on the digital surround controller using six phono leads.
- Optionally connect a digital output from the source to digital input D8 (DISC) on the digital surround controller, using a digital phono lead.

You can then select the source corresponding to the multichannel input (AUX) for playing surround material, and the source corresponding to the digital input (DISC) to decode other formats.

**Note:** Multichannel analogue sources may have subwoofer level outputs that vary by up to 10dB, so it may be necessary to reduce the LFE level to give correct bass integration; see *DSP presets*, page 33.

## Audio outputs

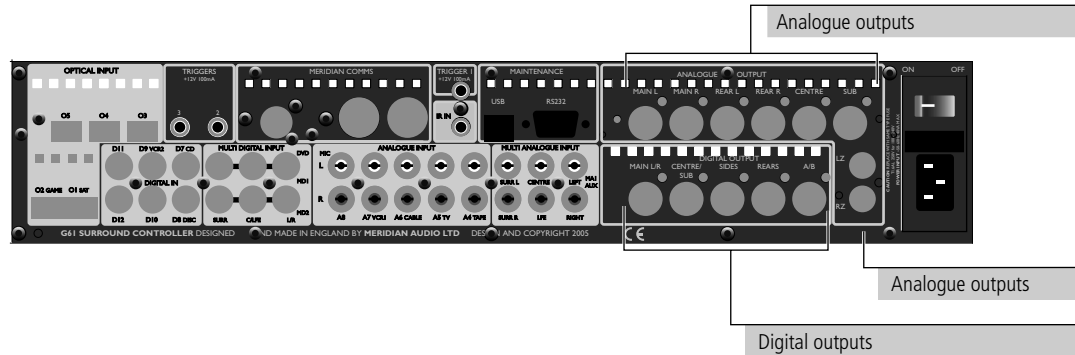

### Use this output

DIGITAL OUTPUT MAIN L/R, CENTRE/SUB,  
SIDES, REARS, A/B

ANALOGUE OUTPUT LEFT, RIGHT, REAR L,  
REAR R, CENTRE, SUB, LZ, RZ

### To connect to this

Digital loudspeakers, using digital coax cables.

The unbalanced analogue input of a power amplifier or active loudspeakers, using screened coax phono leads.

The G61 hardware architecture is designed to process up to 12 completely independent output channels. Currently the software limits the number of outputs to a total of eight: Main L/R, Centre, Sub, Rears, and either Sides or two more additional subwoofers.

The G61 provides analogue and/or digital output sockets for these eight speakers.

### To connect the G61 to Meridian DSP loudspeakers

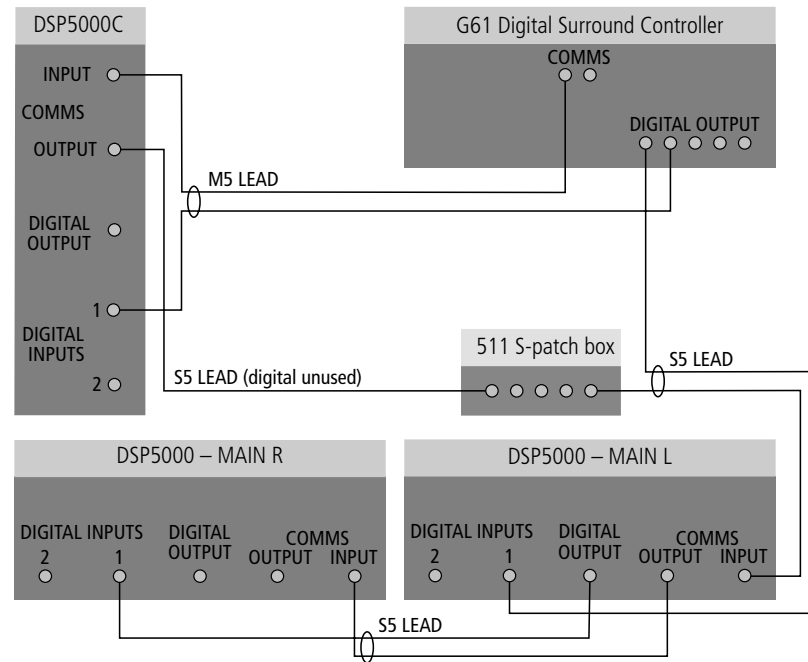

- Use the Comms part of an M5 lead to connect one of the COMMS sockets on the G61 to the digital speaker you have chosen as the master (typically the centre speaker).
- Use the audio part of the M5 lead to connect the digital speaker to the appropriate digital output socket.
- Link each pair of speakers together with an S5 lead, out of the first speaker and into the second speaker, as shown in the diagram for the main L&R.
- Connect the inputs to the first speaker of each additional pair to the 511 (Comms) and the appropriate output of the G61 (audio), using an S5 lead.

If the system includes more than two Meridian DSP loudspeakers you will need a 511 S-patch box (available separately) to link together the S5 leads from each speaker.

- Connect the COMMS output from the master digital speaker to one socket on the 511 using an S5 lead.

The speakers should then be configured appropriately as master and slaves, and Left, Right, Centre, Surround; see *Meridian DSP Loudspeaker User Guide* for more details.

**To connect the G61 to active unbalanced loudspeakers (eg Meridian M33s)**

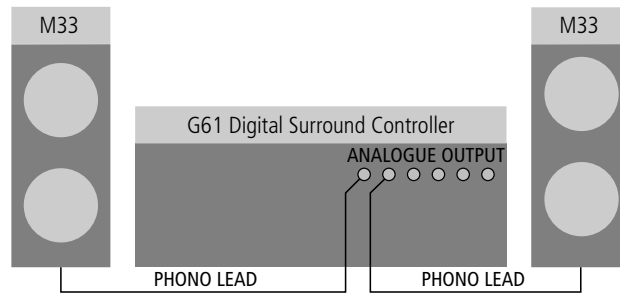

- Connect the appropriate analogue out sockets from the digital surround controller to the speaker inputs, using phono leads.

**To connect the G61 to a stereo power amplifier (eg Meridian G56 or G57)**

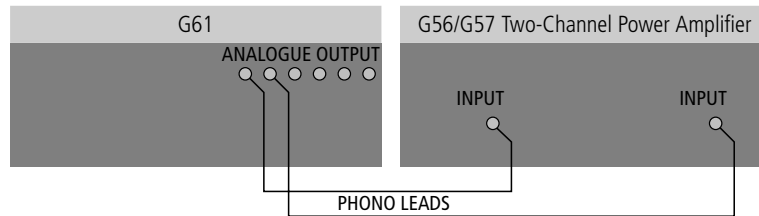

- Connect the appropriate analogue output sockets from the digital surround controller to the stereo power amplifier inputs, using phono leads.
- Connect the speaker outputs from the stereo power amplifier to suitable speakers.

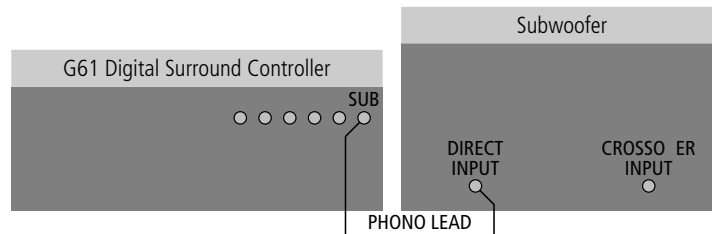

**To connect an active subwoofer (eg Meridian M1500 or M2500)**

- Connect the SUB analogue output socket from the G61 Digital Surround Controller to the subwoofer's line-level input using a phono lead.

Use RZ and LZ if you have two subwoofers.

The digital surround controller provides a very high-quality crossover for the subwoofer, and for best results you should use this instead of the subwoofer's crossover. To do this remove any crossover in the subwoofer or set it to its highest setting (eg 200Hz). The subwoofer crossover can be set from the front panel of the G61; see *Subwoofer crossover frequency*, page 30.

## Communications connections

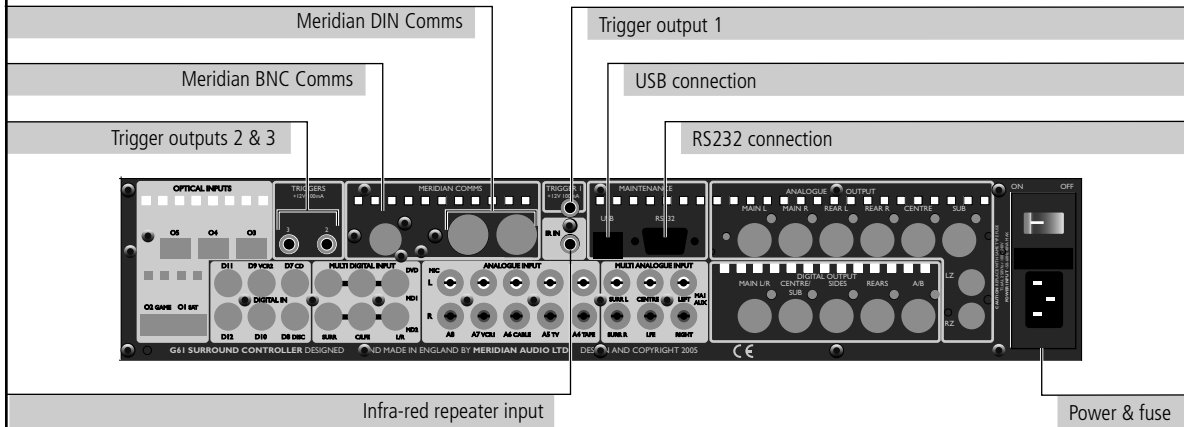
**Use this connector**

DIN COMMS

BNC COMMS

RS232 connection

USB connection

IR IN

TRIG 1, TRIG 2, TRIG 3

**To connect to this**

Other Meridian G Series, 500 Series, or 800 Series equipment, or Meridian DSP loudspeakers.

Other Meridian G Series equipment or some Meridian DSP loudspeakers.

A computer, for configuring the digital surround controller.

A computer, in future applications.

A G12 IR Receiver, or approved alternative infra-red repeater. Contact your dealer for details.

Other equipment, via mono 3.5mm jack plug outputs (centre pin hot) providing 12VDC. They are always low in standby. By default they are high for all sources, so can be used to bring a G56 or G57 Power Amplifier out of standby. Alternatively you can program them to be high for specific sources; eg to control a projection screen.

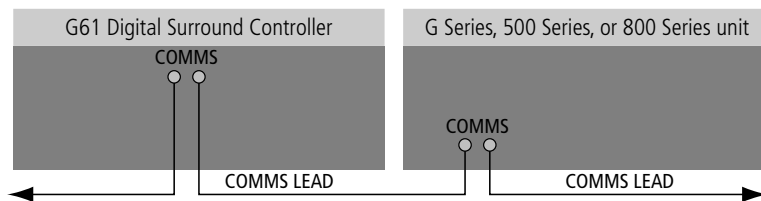
**To connect to other Meridian G Series, 500 Series, or 800 Series equipment**

In a system of Meridian products the products should be linked together in a chain, via the COMMS sockets, using the Comms leads supplied with each product. The sequence in which you connect the units is not important.

One of the products acts as the controller for the system, receiving infra-red commands from the MSR+, and then, if appropriate, relaying them to the other products via the Comms link. The following procedure should be used to set up the Comms correctly between several products:

- Switch all the units to standby.
- Press **Clear** (MSR+).

Each unit will display:

Auto

One unit will then be designated as the controller, and display:

Con.

All the other units will be configured as non-controllers, and display:

Not Con.

The system is now ready for use.

If the automatic setup does not work, first make sure you are operating the MSR+ from a position where all the units can receive the infra-red, and try again. Then:

- Check that none of the units have been configured to be IR Controller; see *Configuring other settings*, page 22. Either all products should be set to Auto, or one should be configured as Controller and the others as Not Controller.

**Note:** Do not, under any circumstances, connect any equipment other than Meridian G Series, 500 Series, or 800 Series to any socket marked COMMS on the back of the product.

# Configuring the digital surround controller

This chapter explains how to configure the digital surround controller using the Configuration Wizard. Alternatively, for complete control over all aspects of the product's configuration you can set up the unit from a computer using the Meridian Configuration Program. For full information refer to the *Meridian Configuration Program Guide* available separately.

## Configuration Wizard

The **Configuration Wizard** leads you through the correct sequence to configure your digital surround controller. Alternatively, you can skip between the configuration stages, which allow you to reset the configuration, or configure the sources or other settings of the digital surround controller.

### To run the Configuration Wizard

- If necessary press **On/Off** to put the digital surround controller into standby.
- Press **More**.

If the product is locked the display shows:



- Press **Unlock** to unlock it, then press **More**.

The displays then shows:

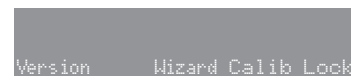

- Press **Wizard**.

Follow the sequence of configuration stages described in the following pages, pressing **Next** to proceed after each stage.

At any stage in the Configuration Wizard the following options are available:

To do this	Press
Go back to an earlier configuration option	Back
Return to the title screen for the stage	Home
Exit from the configuration menus	On/Off
Display help about the current option	More

## Stage 1: Resetting the product

The digital surround controller provides several alternative standard settings, called Types, which configure all aspects of the product into the most commonly needed configurations.

Choosing one of the Types overrides any other configuration you may have performed, and so can be used to reset the configuration of the unit.

### To reset the configuration

- Press **Wizard**.

The display shows the title screen for stage 1:

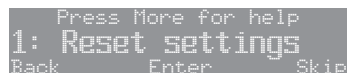

```

Press More for help
1: Reset settings
Back      Enter      Skip
  
```

- Press **Enter** to proceed or **Skip** to go stage 2.

If you pressed **Enter** the display shows:



```

Reset all settings?
Back Yes
  
```

- Press **Yes** to proceed or **Back** to exit.

The display shows the current Type:

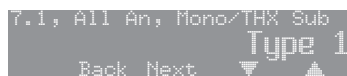

```

7.1, All An, Mono/THX Sub
Type 1
Back Next  ▼ ▲
  
```

- Press **▲** or **▼** to step through the available Types.

A description of the speakers for each type is shown on the top line of the display. As you select each Type the digital surround controller is reset to that Type.

When you have selected the Type you want:

*Either:*

- Press **Next** to proceed to configuring speakers, as described in the next section.

*Or:*

- Press **On/Off** to return to standby.

## Types

The following table lists the available Types:

Type	Speakers	Music Sub	Logic Sub	5.1 Movie Sub
0	All analogue.	LFE	Centre	LFE
1	All analogue.	Mono	Mono	Mono
2	All digital.	LFE	Centre	LFE
3	All digital, large centre.	None	None	None
4	Digital left, right, and centre.	LFE	Centre	LFE
5	Digital left and right.	LFE	Centre	LFE

Music Sub refers to a subwoofer used for all Music DSP presets, Logic Sub to a subwoofer used for all Logic DSP presets, and 5.1 Movie Sub to a subwoofer used for all 5.1 Movie DSP presets; see *Speaker layouts*, page 33.

LFE subwoofer is only active in multichannel presets. Mono and Centre Subwoofers are active in all presets.

## Stage 2: Configuring speakers

The Speakers configuration stage allows you to set up the digital surround controller for the particular arrangement of loudspeakers in your system.

### To configure the speakers

*Either:*

- Press **Next** after resetting the product; see page 16.

*Or:*

- Press **Wizard**; see page 15.
- Press **Skip** to skip past the **Reset settings** menu.

The display shows the title screen for stage 2:

```

Press More for help
2: Select speakers
Back      Enter      Skip
  
```

- Press **Enter** to proceed or **Skip** to go to stage 3.

The display shows the first speaker configuration option:

```

Number of Subwoofers:
                                one
Back Next  ▼      ▲
  
```

- Press **Next** or **Back** to step between options.

A description of each option is shown on the top line of the display, and its current value is shown below this to the right.

The options are summarised in the table on the next page.

### To change an option

- Press **▲** or **▼** to step between the alternative values for the option.

When you have stepped through all the speaker options the display shows:

```

Speaker choice finished.
Back Next
  
```

*Either:*

- Press **Next** on the last option of the last speaker to proceed to configuring sources, as described in the next section.

*Or:*

- Press **On/Off** to return to standby.

If you press **On/Off** before completing the configuration a warning is displayed, giving you the option of continuing or abandoning the configuration.

## Speaker options

The following table summarises the speaker options:

Option	Values	Description
Number of Subwoofers:	none, one, two, three	How many subwoofers.
The main L&R speakers are:	small analogue/THX, small DSP, large analogue, large DSP	The types of the main left and right speakers. If you have no subwoofers, you cannot specify small main speakers.
The Centre is used:	always, never, for music, for movies	When the centre speaker is to be used.
The Centre speaker is a:	small analogue/THX, small DSP, large analogue, large DSP	The type of the centre speaker.*
Number of Surrounds:	none, two, four	The number of rear or side surround speakers.
The Side speakers are:	small analogue/THX, small DSP, large analogue, large DSP	The types of the side speakers.*
The Rear speakers are:	small analogue/THX, small DSP, large analogue, large DSP	The types of the rear speakers.*
The Subs are used:	for movies only, always	When the subwoofers are used. If you have small main speakers, the subwoofer must always be used.
The Sub handles:	all the bass, only the LFE	Whether to use the subwoofer for all bass or just the LFE channel. Only available if there is only one subwoofer.
The bass balance is:	neutral, heavy	Whether the bass is distributed to all the large speakers and subwoofer (heavy) or just the subwoofer (neutral – recommended). Only available if there is only one subwoofer, and it handles all the bass not just the LFE.
The 2 Subs are used for:	Left and Right, Front and Surround	If there are two subwoofers, their position. Only available if there are two subwoofers.
The sub is:	analogue, digital	The type of subwoofer.

\*If you have small main speakers, you cannot specify large centre or surrounds.



## Stage 3: Configuring sources

The digital surround controller provides up to 12 sources corresponding to the 12 source keys on the MSR+:

CD, RADIO, DVD, AUX, DISC, TAPE, TV, CABLE, SAT, VCR1, VCR2, GAME.

For each source the Configure sources stage allows you to configure a series of options, including:

- Whether it is in use.
- The label used for it on the front-panel display.
- The audio input it selects.
- The TRIGGER output level it selects.

The procedure for doing this is as follows.

### To configure a source

*Either:*

- Press **Next** after configuring speakers; see page 18.

*Or:*

- Press **Wizard**; see page 15.
- Press **Skip** to skip past the **Reset settings** and **Select speakers** menus.

The display shows the title screen for stage 3:

```

Press More for help
3: Configure sources
Back      Enter      Skip
  
```

- Press **Enter** to proceed or **Skip** to go to stage 4.

The display shows the first source and the first configuration option for that source, whether it is in use:

```

This source is:
Radio           in use
Source Back Next  ▾  ▴
  
```

- Press **Next** or **Back** to step between options.

The top line of the display shows a description of each option, and its current value is shown to the right of the source name.

When changing the source name, **Next** and **Back** step between character positions.

The options are summarised in the table on the next page.

### To change an option

- Press **▲** or **▼** to step through the alternative values for the option.

### To move to the next source

- Press **Source**.

When you have finished configuring sources:

*Either:*

- Press **Next** on the last option of the last source (Game) to proceed to configuring settings, as described in the next section.

*Or:*

- Press **On/Off** to return to standby.

## Source options

The following table summarises the source options:

Option	Values	Description
The source is:	in use, not in use	Whether the source is enabled.
Audio input:	D1-D12, MD1-MD2, O1-O5, A1-A8, MA1, Last Valid*	The audio input used for the source; digital, multichannel digital, optical, tuner, analogue, or multichannel analogue.
Source name:		Any name of up to five characters.
Trigger #1:	High, Low	Trigger outputs for the source.
Trigger #2:	High, Low	Trigger outputs for the source.
Trigger #3:	High, Low	Trigger outputs for the source.
Comms Type:	CD 1C, Tuner 2C, DVD 3C, 4C-8C, No Comms NC	Set to NC unless the source is a Meridian product.
Comms Address:	1A-8A	Allows you to have up to eight of each source type.

\*Last Valid leaves the input set to the last input you selected.

## Stage 4: Configuring other settings

The next stage allows you to configure other aspects of the product's operation.

### To configure other settings

*Either:*

- Press **Next** after configuring the sources; see page 20.

*Or:*

- Press **Wizard**; see page 15.
- Press **Skip** to skip past the stages 1 to 3.

The display shows the title screen for stage 4:

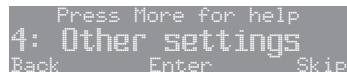

```

Press More for help
4: Other settings
Back Enter Skip
  
```

- Press **Enter** to proceed or **Skip** to go to the calibration procedure.

The first setting is displayed:



```

The fan is:
used as necessary
Back Next ▼ ▲
  
```

A description of each setting is shown on the top line of the display, and its current value is shown to the right of the display.

The settings are summarised in the table on the next page.

### To change a setting

- Press **▲** or **▼** to step through the alternative values for the setting.

When you have finished configuring the settings:

*Either:*

- Press **Next** to proceed to calibrating the system, as described in the next chapter.

*Or:*

- Press **On/Off** to return to standby.

## Settings

The following table summarises the product settings:

Option	Values	Description
The fan is:	used as necessary, never used	Specifies how the optional temperature controlled fan operates.
Distance measurement:	feet/inches, metres	Units for displaying and entering distances.
Do your subs play to 20Hz?	No, THX Ultra2/yes	Subwoofer frequency response.
Boundary Gain Compensation:	off, on	Reduces the bass to compensate for listening positions close to a wall.
Rear speaker separation	<12"/0.3m, 12-48"/0.3-1.2m, >48"/1.2m	Separation between rear speakers.
Timeout to Home buttons:	on, off	Whether the soft keys revert to the home keys after a delay.
Diagnostic displays:	on, off	Whether diagnostic displays are shown.
Is the G61 IR Controller?	Auto, Controller, Not Controller	Whether the product is the infra-red controller for the system.
Main System Address	1-8	Advanced setting (normally 1).
Product Address	1-8	Advanced setting (normally 1).



# Calibrating the system

To help you to set up the installation to give the best possible sound with any particular combination of associated equipment, the G61 Digital Surround Controller includes a built-in calibration procedure.

This calibration procedure uses test signals to present a series of sounds, which you use to adjust certain aspects of the system to their optimum settings.

You should use the calibration procedure the first time you set up the system, and whenever you want to check the calibration, such as after changing the layout of the room.

## Introduction

We recommend that you perform the calibration procedure using the MSR+ and from the listening position.

As you run the calibration procedure the name of each calibration test is shown on the front-panel display, followed by the parameters adjusted in the test.

Each calibration test uses a test signal designed to give the best results.

## Using a Sound Pressure Level meter

Although you can perform the calibration procedure by ear, it is recommended that you perform the tests using a Sound Pressure Level meter. These are available fairly cheaply from Tandy/Radio Shack, or your Meridian dealer may be able to lend you one.

Set the Sound Pressure Level meter to C weighted, and Slow. Take readings with the meter at the listening position, pointing vertically. You should hold the meter with an outstretched arm to minimise reflections from your body.

You can choose to display and enter distances in either feet and inches or metres.

**To start the calibration procedure***Either:*

- Press **Next** on the last option of configuring settings; see page 22.

*Or:*

- Press **On/Off** to put the digital surround controller into standby.
- Press **More**.

If the product is locked the display shows:

```
Version                Unlock
```

- Press **Unlock**.

The display shows:

```
Version  Wizard Calib Lock
```

- Press **Calib**.

The display shows **Please wait....**

After a few seconds the display shows the first calibration test:

```
Press More for help
Left  Level  +0.0dB
  ◀   ▶   ▼   ▲
```

For more detailed information about this and the other calibration tests see the following sections.

**To exit from the calibration procedure**

You can exit from the calibration procedure at any time, and any parameters you have set will be retained:

- Press **On/Off**.

**To complete the calibration procedure**

When you reach the end of the calibration procedure the following display confirms that you have completed the calibration of the system:

```
Calibration complete.
Back  Next  Restart
```

- Press **Restart** to restart the calibration procedure, or **Next** to complete the wizard.

The display shows:

```
Press More for help
Wizard complete
Back  Exit  Restart
```

*Either:*

- Press **Exit** to return to standby.

*Or:*

- Press **Restart** to return to stage 1; see page 16.

## Calibration tests

### Levels

These tests allow you to adjust the output level to each speaker individually, and it follows the general guidelines from Dolby Laboratories and THX.

In each test the display shows the speaker being tested, and the current relative level. For example:



- Use ► and ◀ to move between each of the speakers in the layout in the sequence: Left, Centre, Right, Side R, Rear R, Rear L, Side L, and subwoofers.
- Use ▲ and ▼ to adjust the level of the speaker. Ignore any tonal difference.

For correct THX reproduction you should adjust each speaker to 75dB SPL using an SPL meter. Even if the speakers are not THX approved this setting is recommended.

If you have Meridian DSP loudspeakers they cannot be set above +0dB.

**Note:** You cannot set the level of a subwoofer by ear, because low-frequency noises sound quieter. To set the subwoofer correctly either use an SPL meter, or set it by ear and then reduce the subwoofer gain by 15dB to correct for human hearing.

- When you have completed the Levels section press ► to proceed to the next test.

### Distance

These tests allow you to adjust the delay of each of the speakers in the layout to time-align the system so that sounds are coincident when they arrive at the listening position.

Before setting up the speaker outputs you need to measure the distance to each speaker from the listening position:

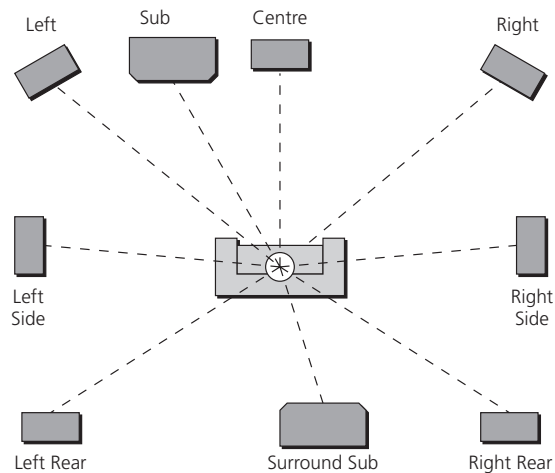

Measure from ear height at the listening position to the tweeter on each speaker (where applicable), in the distance units you have chosen; see *Settings*, page 23.



- Use ► and ◀ to move between each of the speakers in the layout.

The display shows the speaker being tested, and the distance:



- Use ▲ and ▼ to change the distance.
- You can press **Units** to change between feet/inches and metres.

Repeat this for each of the speakers in your layout.

- Press ► to proceed to the next calibration stage.

## Fine tuning

These tests allow you to fine-tune the phase and delay of each speaker when used in conjunction with other speakers on the layout.

- Use ► and ◀ to move between each of the speakers in the layout.

The first display allows you to adjust the phase. For example:



The next display shows the distance for the same speaker. For example:



- Choose the correct setting as follows:

Setting	What it sounds like
Correct	The sound between the speakers is very even, and does not change radically as you move your head.
Incorrect	The sound appears diffused, and changes in timbre and apparent location as you move your head.

Pay particular attention to the centre channel, as this can have a dramatic effect on the overall sound.

- Press ► to proceed to the next calibration stage.

## Speaker size

These tests allow you to determine the bass handling capability of large analogue speakers and subwoofers. Once set, the digital surround controller will limit the bass level to protect the speakers from potential damage.

On starting the test the speaker sizes are set to zero to avoid the possibility of damaging the speakers, and the display shows:



Press More for help  
Sizes set to zero  
◀ ▶ ▼ ▲

The display then shows the first large analogue speaker; for example:



Press More for help  
Left Size 0  
◀ ▶ ▼ ▲

- Press ▲ or ▼ to adjust the size value for the speaker until it just begins to distort distinctly, and then reduce the value by one.
- Press ▶ or ◀ to move between each of the speakers to be adjusted.

This is the last test in the calibration procedure; see *To complete the calibration procedure*, page 26.

## Using the Sine/Sub/Sens controls

This section explains how to use the Sine/Sub/Sens controls to check for room resonances, adjust the subwoofer crossover frequency, or adjust the sensitivity of the analogue sources.

### To display the Sine/Sub/Sens controls

- If necessary, unlock the digital surround controller as described in *Configuration Wizard*, page 15.
- Press **More** until the bottom line of the display shows:

```
Radio Trifield 65
Sine/Sub/Sens. Store Clear
```

- Press **Sine/Sub/Sens**.

The bottom line of the display shows the **Sine/Sub/Sens** controls:

```
Radio Trifield 65
Sine -Xover+ -Sens.+
```

### Subwoofer crossover frequency

The G61 Digital Surround Controller allows the crossover frequency for any subwoofers which you have to be adjusted between 30 and 150Hz. The crossover can be set independently for Music, Logic, and 5.1 Movie layouts. The default is the THX standard of 80Hz.

#### To adjust the subwoofer crossover frequency

- Select a source, then display the **Sine/Sub/Sens** controls as described above.

- Press **Xovr-** or **Xovr+** to decrease or increase the crossover frequency.

The display shows the current crossover frequency:

```
CD Xover 85Hz
Sine -Xover+ -Sens.+
```

For THX loudspeaker systems you should not adjust these settings; they should be left at 80Hz. 80Hz is also the recommended setting for all movie listening. You may prefer, however, to lower the crossover frequency for music if the main speakers have good bass handling down to, say, 50Hz.

### Sinewave sweep test

The G61 includes a sinewave signal test, to help you set the subwoofer crossover frequencies, or check for room resonances. To avoid possible damage to the speakers the volume is reduced to 50, if necessary, on entering the test.

**Warning: This test is very loud. Very loud low-frequency signals may damage the speakers.**

#### To use the sinewave sweep test

- Select a source, then display the **Sine/Sub/Sens** controls as described above.
- Press **Sine** to turn on the sinewave signal.

The display shows:



An 80Hz sinewave will be played through all channels.

You can change the test signal using the menu keys, as described in the following sections.





#### To select the channel

- Press **Chan**.

You can select any individual channel, or **All Channels**.

#### To change the sweep rate

- Press **▲** or **▼** to change the sweep rate and direction, as follows:

Display	Description
	Fast sweep up.
	Slow sweep up.
	Paused.
	Slow sweep down.
	Fast sweep down.

#### To change the volume

- Use the volume keys in the usual way.

#### To change the input

- Press **Sound**.

You can select between the following inputs:

Option	Description
Input	The current input.
Sine	A sinewave.
Noise	Pink noise, band bass 500Hz to 2kHz for main channel.
Silent	Silence.

Alternatively you can switch between inputs using the menu keys on the MSR+.

## Setting up sources

This section explains how to use the **Sine/Sub/Sens** controls to adjust the sensitivity of the analogue sources.

### To adjust the sensitivity of a source

To obtain the best signal-to-noise ratio for each analogue source you can adjust its sensitivity to give the highest level that does not produce clipping.

- Select the source you want to adjust, with loud source material playing.
- Display the **Sine/Sub/Sens** controls as described above.
- Press **Sens-** or **Sens+** to decrease or increase the sensitivity.

The display shows the current sensitivity and the peak level; for example:

```
TV      1.4V  Peak -3
Sine    -Xover+  -Sens.+
```

You can adjust the sensitivity between 0.7, 1.0, 1.4, 2.0, and 2.8V (least sensitive).

If the sensitivity is set too high the input will clip the loudest passages, and the peak will be 0dB.

The display shows, for example:

```
TV      2.0V  Clip -0
Sine    -Xover+  -Sens.+
```

In this case reduce the sensitivity by selecting a higher number.

If you have selected a digital source you cannot adjust the sensitivity and the display shows, for example:

```
DVD     Not Analogue
Sine    -Xover+  -Sens.+
```

# DSP presets

This chapter gives details of the DSP presets and their parameters, and describes how to modify them.

## DSP presets

The G61 Digital Surround Controller provides two types of DSP preset. One set is available if the input is two-channel; eg from a traditional stereo source or a two-channel DVD-A. The other set is available if the input is 5.1 or 6 channels of discrete audio; eg from a Dolby Digital DVD-V or a music DVD-A. The DSP presets available in each set are described in the following pages.

### Speaker layouts

The G61 Digital Surround Controller provides great flexibility in the way in which you use the loudspeakers in your system. For example, the speaker step of the Configuration Wizard allows you to use the subwoofers and centre speaker only for movie material see *Configuring speakers*, page 18. With the Meridian Configuration Program you can specify three different speaker layouts, each with a different use of subwoofers and centre speaker:

Layout	Description
Music	For music presets: two-channel (eg Trifield) and multichannel (eg Discrete).
Logic	For two-channel movie presets: eg PLIIx Movie.
5.1 Movie	For multichannel movie presets: eg Cinema.

## Standard parameters

All DSP presets (except Mono and Direct) provide the following standard parameters.

Individual DSP presets provide additional parameters, to allow you to adjust specific features provided by that preset. For full details refer to information about each preset later in this chapter.

Parameter	Range	Default	What it changes
Treble*	-10dB to +10dB	+0dB	The slope of the frequency response.
Bass*	-5dB to +5dB	+0dB	The bass response.
Phase*	+ or -	+	The phase of all loudspeakers.
Axis†	-2 to +3	-1	The vertical balance.
Balance	<10 to 10>	<0>	The L-R balance.
HS Output?*	Y or N	Y	Select <b>Y</b> for high-rate audio, upsampled if necessary. Select <b>N</b> for standard-rate audio, downsampled if necessary.
Centre	-3.0dB to +3.0dB	+0.0dB	The level of the centre.
Depth	-2.5ms to +5.0ms	+0.0ms	The delay of the centre.
Rear	-30dB to +10dB	+0dB	The level of the rears.
Sides	-30dB to +10dB	+0dB	The level of the sides.
R Delay	0ms to 30ms	Varies	The delay of the rears.
S Delay	0ms to 30ms	Varies	The delay of the sides.
LipSync	0ms to 30ms	0ms	The sync. delay.

\*These parameters apply to all DSP presets.

†Axis is only available with Meridian DSP loudspeakers.

## DSP presets for two-channel material

The G61 provides several signal processing options for two-channel material. The Music DSP presets are designed for use with music from sources such as CD, radio, or two channel DVD-A:

- Music, Trifield, Ambisonics, Super Stereo, Music Logic, PLIIx Music, Stereo, and Direct.

The Logic DSP presets are designed for use with film soundtracks or TV programmes:

- PLIIx Movie, PLIIx THX, TV Logic, and Mono.

The Music and Logic DSP presets use the Music and Logic speaker layout respectively; see *Speaker layouts*, page 33.

### Music

The Music DSP preset extracts the mono and surround components of the original recording. These components provide an alternative representation of the original sound, and this is sometimes used for recording systems or in broadcasts such as FM radio. The mono element is equalised using a proprietary Meridian technique to match the tone colour of the centre speaker, and to compensate

### Music and Trifield DSP preset parameters

Parameter	Options	What it changes
Centre	Flat, EQ1-3	The timbre of the centre loudspeaker.
Width†	0-1.5	The width of the image.
Surr. Rear	Surr. Rear, Surr. Side, Surr. All	Switches the surround signal between the side and rear speakers.
R Filter	Off, 1kHz, 3kHz, 7kHz	The cutoff of high frequencies from the rear surrounds.
S Filter	Off, 1kHz, 3kHz, 7kHz	The cutoff of high frequencies from the side surrounds.

†Trifield only.

for the fact that the frequency response of human hearing changes with direction.

The Music DSP preset is recommended for recordings made with spaced omnidirectional microphones, or using a mono-surround technique.

### Trifield

As for the Music DSP preset, the Trifield preset extracts the mono and surround components of the original recording. It then calculates the signals for the front, left, centre, and right speakers, using the phase and amplitude differences between the three front channels, to redistribute the sounds on a frequency-dependent basis.

This gives a significant improvement over traditional stereo, which converts the differences between the microphone signals into amplitude differences in the speaker signals. This version of the Trifield algorithm is virtually impossible to implement without digital signal processing.

Trifield is recommended for well-made recordings and stereo television broadcasts that are not Dolby Surround encoded. An advantage over the Music DSP preset is that the front stereo image is more focused, and the width of the image can be adjusted.



### Ambisonics

The Ambisonics DSP preset can decode UHJ format, the two-channel stereo-compatible encoding found on Ambisonically-recorded discs and broadcasts. This material is specifically encoded for surround reproduction and can give breathtakingly realistic sound when replayed using the digital surround controller.

Ambisonics surround sound is quite unlike conventional stereo. A special microphone technique picks up the sound of the original performance in all three dimensions, allowing an archive to be made which describes the soundfield exactly at that position. The microphone signals are then encoded using a phase-amplitude matrix to allow the effect to be conveyed on two-channel carriers (like FM radio, LP, or CD).

The digital surround controller uses accurately matched, frequency-dependent, phase-amplitude matrices to decode the signal and construct the signals for each speaker feed.

The fundamental difference between Ambisonics surround sound and conventional stereo is that the signals from all the speakers combine to produce a coherent soundfield at the listening position, giving the illusion that you are sitting inside the recording space whether you are at the exact central seat or well off to one side.

Of all the signal-processing options, Ambisonics is the one that requires the greatest attention to speaker choice and positioning.

### Super

Super synthesises a signal from a conventional stereo recording or broadcast so that it can be decoded using the Ambisonic decoder. The result is especially effective for two particular types of recordings:

- Those using true coincident microphone techniques.
- Multi-tracked or multi-miked recordings.

### Ambisonics and Super DSP preset parameters

Parameter	Options	What it changes
Width*	0 to 1	The width of the image.
Row†	A, C, E, G, I, K, M	The seating position; the letters are like rows in a hall.
Channels	7, 6, 5, 4	The number of speakers.
R Filter	Off, 3kHz, 7kHz, 9kHz	The cutoff of high frequencies from the rear surrounds.
S Filter	Off, 3kHz, 7kHz, 9kHz	The cutoff of high frequencies from the side surrounds.

\*Super only.

†Ambisonics only.

**MusicLogic**

MusicLogic is a music DSP preset based on Pro Logic II with the addition of user-adjustable steering, designed to provide an exciting experience with many types of studio-produced music.

**MusicLogic DSP preset parameters**

Parameter	Options	What it changes
Roll	Off, Low, Med, Max	The degree of left-right steering.
Yaw	Off, Low, Med, Max	The degree of front-rear steering.
Steered All	Steered Rear, Steered Side, Steered All	Which of the four surround channels are generated by steering.

**PLIIx Music**

The PLIIx Music preset is designed to use the Pro Logic IIx DSP processing mode to decode music sources. It provides additional **Width**, **Dimension**, and **Panorama** preset parameters to allow you to adjust the soundfield.

**PLIIx Music DSP preset parameters**

Parameter	Options	What it changes
Steered All	Steered Rear, Steered Side, Steered All	Which of the four surround channels are generated by steering.
Width	0 to 7	The centre spread, where <b>0</b> is full centre and <b>7</b> is full left and right.
Dimension	-3 to +3	The spatial soundfield, where <b>-3</b> puts the balance to the rear of the room and <b>+3</b> puts it to the front.
Panorama	No, Yes	Extends the front stereo image to include the surround speakers, providing a wrap-around effect new to Pro Logic.

**Stereo and Direct**

The Stereo preset passes the left and right input signals directly to the left and right main speakers. Any mono or front left and right subwoofers continue to be used.

With the Direct preset only the left and right main speakers are used, bypassing any spatial processing and bass management.

There are no additional DSP preset parameters for Stereo and Direct.

**PLIIx Movie and PLIIx THX**

PLIIx Movie and PLIIx THX use the Dolby Pro Logic IIx DSP processing mode, and are the recommended choice for Dolby Surround encoded material. They also give excellent results with two-channel sources not specifically encoded for Dolby Surround, including two-channel Dolby Digital sources.

Pro Logic IIx re-creates 7.1-channel movie surround from the two-channel source, using improved decoding techniques that preserve the directness of the soundfield, resulting in enhanced image

**PLIIx Movie and PLIIx THX DSP preset parameters**

Parameter	Options	What it changes
Surrounds	Rear, Side, All	Which of the four surround channels are generated by steering.
Pro Logic	Off, On	<b>On</b> selects an emulation of the original Pro Logic decoding.

stability compared with the original Pro Logic decoding. Meridian's implementation of Pro Logic IIx uses proprietary code based on 48-bit precision to give outstanding clarity.

The PLIIx THX DSP preset uses the same PLIIx processing as PLIIx Movie, but adds THX Cinema processing. THX is a set of standards and technologies developed by Lucasfilm Ltd. with the aim of making your experience of the film soundtrack as faithful as possible to what the director intended.

Re-equalisation is used to restore the correct tonal balance for watching a film soundtrack in a small home environment.

Timbre matching filters the information going to the surround speakers so that they more closely match the tonal characteristics of the sound coming from the front speakers. This ensures seamless panning between the front and surround speakers.

THX can also be used with the 5.1 Movie DSP presets; see *THX*, page 41.

### TV Logic

TV Logic is a Logic preset based on Pro Logic IIx with the addition of user-adjustable steering, designed to give higher intelligibility and a more appropriate spatial presentation for studio-based TV material.

#### TV Logic DSP preset parameters

Parameter	Options	What it changes
Roll	Off, Low, Med, Max	The degree of left-right steering.
Yaw	Off, Low, Med, Max	The degree of front-rear steering.
Surrounds	Rear, Side, All	Which of the surround channels are generated by steering.

### Mono

In the Mono DSP preset you can choose to listen to:

- Only one of two input channels, such as when different languages or material are carried on each channel.
- A combined version of the two input channels, such as if the material was originally mono and has been conveyed on a two-channel carrier.

If **Party?** is set to **No**, the combined or selected signal is played only through the centre speaker, or the left and right speakers if there is no centre, to centrally localise high-frequency hiss and clicks.

**Note:** If **Party?** is set to **Yes**, full range bass is played through any speakers that are not supplemented by a subwoofer, and this may damage small speakers at high volume levels.

#### Mono DSP preset parameters

Parameter	Options	What it changes
Input	Auto L+R, Input L, Input R, Input L+R	The channel selected.
Academy	Off or On	Select <b>On</b> to include an equalisation (recommended by Lucasfilm Ltd) to correct for a high-frequency balance in some old mono films.
Party?	No or Yes	Select <b>Yes</b> to play the mono signal through all speakers, including subwoofers.

## DSP presets for multichannel material

Multichannel audio signals can come from either encoded data streams (such as Dolby Digital) or as discrete channels from a DVD player. If you are using Meridian SmartLink then all formats will reach the G61 as discrete channels. With suitable loudspeakers the G61 can upsample these to provide a more enjoyable surround experience.

The G61 Digital Surround Controller will automatically select the right decoder algorithm and present the same set of preset choices for all streams. **Note:** Some presets are only available if there are four surround speakers in the system.

There are four multichannel Music presets:

- Discrete, PLIIx Mus6, THX Music, and Ambisonics B format (discrete inputs only).

### Discrete and Cinema DSP preset parameters

Parameter	Options	What it changes
2+2+2*	Off, 5.1, Side, 7.1	Allows you to specify how DVD Audio channels 3+4 should be interpreted: <b>Off</b> ignores them, <b>5.1</b> and <b>7.1</b> use them for centre and LFE, <b>Side</b> uses them for the side speakers, <b>7.1</b> adds side speakers to 5.1.
Surround†	Surr. Rear, Surr. Side, Surr. All	Allows you to specify which speakers the surround channels should be sent to in a system with four surrounds.
R Filter	Off, 1kHz, 3kHz, 7kHz	The cutoff of high frequencies from the rear surrounds.
S Filter	Off, 1kHz, 3kHz, 7kHz	The cutoff of high frequencies from the side surround.
LFE	-28dB to 0dB	The relative level of the LFE bass channel.

\*Discrete only.

†Cinema only.

There are five multichannel Movie presets:

- Cinema, PLIIx Mov6, THX, THX Surround EX, and THX Ultra2 Cinema.

The multichannel Music presets all use the Music speaker layout and the multichannel Movie presets all use the 5.1 Movie speaker layout; see *Speaker layouts*, page 33.

### Cinema

The Cinema preset is recommended for listening to multichannel movie soundtracks when no further processing is required.

### Discrete

The Discrete preset is similar to Cinema, except that it uses the Music speaker layout and sets the LFE level to -10dB.

**THX**

As with the PLIIx THX DSP preset, THX re-equalises the signals to suit domestic listening conditions, and applies frequency-response correction and decorrelation to the surround channels to make the surround sound more realistic. It can be used whether or not your other equipment is THX approved.

**THX DSP preset parameters**

Parameter	Options	What it changes
Surround	Surr. Rear, Surr. Side, Surr. All	Switches the surround signal between the side and rear speakers.

**PLIIx Mov6, THX Surround EX, PLIIx Mus6, THX Ultra2 Cinema, and THX Music**

These presets are available if you have four surround speakers. They use Dolby Pro Logic IIx, Dolby Surround EX, and THX Ultra2 Cinema processing to generate multiple signals for larger home theatres.

PLIIx Mov6 uses extended PLII technology from Dolby to generate four surround signals from traditional multichannel source material like Dolby Digital 5.1. It is intended for use with movie soundtracks.

PLIIx Mus6 also creates four surround signals; it is intended for multichannel music playback from sources such as DVD-A or SACD music discs.

THX Ultra2 Cinema and THX Music use a THX proprietary process called advanced speaker array to provide a mix of ambient and directional surround sounds using four surround speakers. Optimum performance of THX Ultra2 Cinema and THX Music is produced when the two rear speakers are placed close together behind the listening position. THX Ultra2 Cinema is recommended for movie soundtracks that are not Dolby Surround EX encoded, and THX Music is recommended for listening to multichannel music.

**PLIIx Mov6, THX Surround EX, PLIIx Mus6, THX Ultra2 Cinema, and THX Music preset parameters**

Parameter	Options	What it changes
LFE	-28dB to 0dB	The relative level of the LFE bass channel.

**Ambisonics**

The Ambisonics preset allows you to decode multi-channel sources which have been encoded in Ambisonics B format.

Ambisonics B format contains four independent channels of information to give a three-axis representation of the sound at the recording position. The signals are: mono sound pressure, left-right velocity component, front-back velocity component, and up-down velocity component.

**Using dynamic range control**

If the input format is Dolby Digital, the 5.1 Movie DSP presets provide an additional **Compress** parameter to allow you to take advantage of the dynamic range information provided in the Dolby Digital format to provide dynamic range control without the distortion involved in analogue methods.

## Defining your own presets

The G61 Digital Surround Controller allows you to modify any of the built-in presets, and save them for future use.

You can either save the changes to the built-in preset, or you can create up to 10 presets of your own, with names of your choice, so you can use them alongside the built-in presets.

### To save the preset settings

- Make sure the menus are unlocked; see *To run the Configuration Wizard*, page 15.
- Press **DSP** to select the preset you want to modify.
- Change the preset parameters to the values you want to store.
- Press **More** then **Store**, or **Function + Store** on the MSR+.

The display shows the next available user-defined preset. For example:



- If you want to overwrite an existing user-defined preset press **▲** to select the preset you want to overwrite.

For example:



Alternatively press **▼** to choose the built-in preset you started with. For example:



- Press **Store**.

The settings have been stored in the new or existing preset you selected.

If you are defining a user preset you can now edit the name of the preset if you wish.

A flashing cursor shows the letter you are editing:



- Press **▶** or **◀** to select the character position you want to edit.
- Press **▲** or **▼** to change the character.

Each press steps through the sequence A to Z, a to z, 0 to 9, full stop, and blank. You can also select a blank directly by pressing **Clear** on the MSR+.



For example, you could change the name to:



- When you have entered the name you want to use press **Store**.

The display shows:



To make the new preset the default for the current source and audio format:

- Press **Assign**.

#### To clear a user-defined preset

- Make sure the menus are unlocked; see *To run the Configuration Wizard*, page 15.
- Press **DSP** to select the preset you want to clear.
- Press **More** then **Clear**, or **Function + Clear** on the MSR+.

The display shows **Preset Clear**.

If you clear a preset that was saved over a built-in preset, the original settings are restored.

# Troubleshooting

We expect you to achieve superb results with your digital surround controller. If, however, you encounter any problems, either when installing and configuring it, or during operation, please check the following pages for suggested solutions.

If these suggestions fail to cure the problem, please contact your Meridian dealer for further assistance.

## General operating problems

### Standby light not lit

- Check that the AC power supply is connected correctly.
- Check that the **ON OFF** switch on the back panel is in the **ON** position.

If the light still does not illuminate, check any fuses in your power supply and the fuse in the inlet of the G61. If these are all intact, contact your dealer.

### Erratic or unexpected system behaviour

Redo the Auto Configure process as follows:

- Put the whole system into standby.
- Make sure you are operating the MSR+ from a position where all the units can receive the infra-red.
- Press **Clear** on the MSR+.
- Observe all units responding correctly.

In extreme cases, the memory of the G61 may have been corrupted. If this is suspected perform a full reset; see *Resetting the product*, page 16.

**Remote not working**

Check the following:

- The battery in the MSR+.
- Remove the Comms connections from the G61 and check whether it responds now. If so, replace the connections and perform an Auto Configure procedure; see *To connect to other Meridian G Series, 500 Series, or 800 Series equipment*, page 14.
- See if the G61 has been set up as Not Controller in the Configuration Menu; see *Configuring other settings*, page 22.

**Note:** This may be deliberate by your dealer.

**When playing a Dolby Digital DVD, the G61 selects a two-channel preset**

DVDs include a two-channel Dolby Digital soundtrack, which will use the default two-channel preset.

- Select a six-channel soundtrack, if it is available.

**Unit is overheating**

Check that there is adequate ventilation around the unit.

**Audio problems****Hum on analogue input**

- Check the source equipment. Disconnect each source in turn.
- If the hum originates from a ground loop, an antenna or cable supply may be the cause. In this case an antenna-lead isolator should be fitted.
- If the G61 seems to be the cause of hum consult your dealer.

**There is radio interference**

The G61 is a digital audio and computing device which has been designed to very high standards of electromagnetic compatibility.

If this equipment does cause or suffer from interference to/from radio or television reception then the following measures should be tried:

- Reorient the receiving aerial (or antenna) or route the antenna cable of the receiver as far as possible from the G61 and its cabling.
- Ensure that the receiver uses well-screened antenna cable.
- Relocate the receiver with respect to the G61.
- Connect the receiver and this product to different AC outlets.
- If the problem persists contact your dealer.

### Audible hiss at high volume settings

The input dynamic range of most current recordings is at maximum 16 bit. The reason for this is that currently CD, DVD, and LaserDisc use a 16-bit standard, although DVD can support up to 24-bits. The analogue sources you have cannot achieve this kind of range. For comparison, analogue sources are likely to be of the order of:

- VCR, 12 bits.
- FM radio, 13 bits.
- Reel to reel tape, 13 bits.
- Cassette tape, 12 bits.
- LP, 11 bits.

**Note:** There may be a difference between the dynamic range of the source channel when it is operating, and the noise you hear in standby. For example, LP normally has lower noise when the stylus is not in the groove; similarly tape will be quieter when it is stopped. CD may also be quieter when it is stopped, producing so called 'digital silence'.

The G61 has a 24-bit capability on its internal analogue-to-digital converter, which is used for analogue sources. When the volume is turned up high you may hear its dither as a hiss when the sources are stopped. This hiss is lower than the background noise of your recordings and should be of no consequence.

### Sound not clear

- If speech sounds muffled in a system with a centre speaker, check that sound is coming from the centre as there may be a connection problem. In a digital or Meridian feed to the centre you may have set it up to be right instead of left so that it is playing a subwoofer signal.
- If speech sounds muffled in a system with no centre speaker, you may have selected a layout that expects one. See *Configuring speakers*, page 18.

### Centre not working

There may be a connection problem.

- In a digital or Meridian feed to the centre, you may have set it up to be right instead of left, and therefore it may be playing a subwoofer signal.

### There is a hiss when starting DTS LaserDiscs or CDs

The DTS audio stream is indistinguishable from a PCM audio stream; the G61 takes 30ms to identify the encoding, during which a hiss is heard.

- With non-video DTS sources you can add a 30ms delay to avoid this.
- With video sources you can create a DTS-only source to avoid any hiss.

For more information about each of these options see the *Meridian Configuration Program Guide*.

**The preset changes unexpectedly with a multichannel source**

If you are using a non-Meridian source on the MHR SmartLink input, proprietary data may cause preset switching.

- Select **Force this source to be six-channel** for the source. See the *Meridian Configuration Program Guide*.

# Maintenance

## Cleaning

### To clean the case, display panel, and keypad

- Disconnect the power cord before cleaning the unit.

The exterior surfaces of Meridian G Series products are made from solid anodised aluminium, powder coated steel, thermoplastic rubber, and glass.

They are designed to be easily wiped clean with a dry, lint free cloth. Greasy marks should be removed by light rubbing with a slightly damp cloth and a trace of proprietary glass cleaner. Do not use any other solvent or abrasive based cleaners.

Ensure that no liquid enters the casework and that the product is completely dry before re-connection.

### To clean the audio and video connections

The audio and video sockets on the back of the product are gold plated and do not need to be cleaned if gold-plated phono plugs are used. Otherwise, it is recommended that you unplug and reconnect the plugs at least once a year. A proprietary contact cleaner can be used to some advantage.

The electrical digital output should be treated in a similar way.

### To change the mains fuse

- Remove the mains connector, and pull out the drawer above the power input to access the fuse.

Before replacing a blown fuse, it is best to ascertain the cause of the failure.

The fuse drawer includes a spare fuse. This should be replaced by a fuse of the same rating.

## Service and guarantee

### Service

The Meridian G Series of hi-fi components has been carefully designed to give years of untroubled service. There are no user-serviceable parts inside the case, nor do the units require any form of maintenance.

In the unlikely event that your product fails to function correctly, it should be returned, in its original packaging, to your Meridian dealer.

In case of difficulty within the UK or USA please contact the appropriate sales and service address shown on page iv.

In case of difficulty outside the UK or USA, contact the importing agent for the territory. A list of Meridian agents outside the UK is available from Meridian Audio.

No responsibility can be accepted for the product whilst in transit to the factory or an agent, and customers are therefore advised to insure the unit. When seeking service under guarantee, proof of the date of purchase will be required.

### Guarantee

The product is guaranteed against defects in material and workmanship for two years from the date of purchase.

The guarantee is void if the product has been subject to misuse, accident, or negligence, or has been tampered with or modified in any way without the written authorisation of Meridian Audio Limited. **Note:** Connecting anything other than the correct network lead to the Comms sockets may cause damage to the product which will not be covered by this guarantee. Attempted servicing by unauthorised people may also invalidate this guarantee. Labour and carriage charges are not covered unless by local agreement.

Outside the UK, local warranty liability is restricted to equipment purchased within the territory. Our agents outside the UK are only under contractual obligation to service under-guarantee equipment sold through them. They are entitled to make a non-refundable charge for any service carried out on other equipment.

This guarantee does not limit your statutory rights within the country of purchase.

**A**

Academy (DSP parameter) 39  
 accessories 5  
 active loudspeakers, connecting to 11  
 active subwoofer, connecting to 12  
 Ambisonics (DSP preset) 36, 42  
 analogue source, connecting 7  
 audio inputs 6  
 audio outputs 9  
 automatic setup 14  
 Axis (DSP parameter) 34

**B**

Balance (DSP parameter) 34  
 Bass (DSP parameter) 34  
 built-in presets, replacing 43

**C**

calibration procedure 25  
   moving between tests 26  
   starting 26  
   tests 27  
 calibration tests 27  
   distance 27  
   fine-tuning 28  
   levels 27  
   speaker size 29  
 Centre (DSP parameter) 34, 35  
 Channels (DSP parameter) 36  
 Cinema (DSP preset) 40  
 cleaning 49  
 COMMS, connecting 14  
 communications connections 13

compression 42  
 Compress (DSP parameter) 42  
 configuration, resetting 16  
 Configuration Wizard 15  
 configuring  
   settings 22  
   sources 20  
 connections  
   audio inputs 6  
   audio outputs 9  
   cleaning 49  
   communications 13  
 Controller, setting 14

**D**

Depth (DSP parameter) 34  
 digital source, connecting 7  
 Dimension (DSP parameter) 37  
 Direct (DSP preset) 38  
 Discrete (DSP preset) 40  
 DSP parameters  
   Academy 39  
   Axis 34  
   Balance 34  
   Bass 34  
   Centre 34, 35  
   Channels 36  
   Compress 42  
   Depth 34  
   Dimension 37  
   HS Output? 34  
   Input 39  
   LFE 40



DSP parameters *(continued)*

LipSync 34  
 Panorama 37  
 Party? 39  
 Phase 34  
 Pro Logic 38  
 Rear 34  
 Roll 37, 39  
 Row 36  
 R Delay 34  
 R Filter 35, 36, 40  
 Sides 34  
 Steered All 37  
 Surr. Rear 35  
 Surround 40, 41  
 Surrounds 39  
 S Delay 34  
 S Filter 35, 36, 40  
 2+2+2 40  
 Treble 34  
 Width 35, 36  
 Yaw 37, 39

DSP presets

Ambisonics 36, 42  
 Cinema 40  
 clearing 44  
 Direct 38  
 Discrete 40  
 Mono 39  
 multichannel 40  
 Music 35  
 MusicLogic 37  
 PLIIx Mov6 41  
 PLIIx Movie 38  
 PLIIx Mus6 41

DSP presets *(continued)*

PLIIx Music 37  
 PLIIx THX 38  
 standard parameters 34  
 Stereo 38  
 Super 36  
 THX 41  
 THX Music 41  
 THX Surround EX 41  
 THX Ultra2 Cinema 41  
 Trifield 35  
 two-channel 35  
 user-defining 43, 44  
 DVD-Audio player, connecting to 8  
 dynamic range control 42

G

guarantee 50

H

HS Output? (DSP parameter) 34

I

Input (DSP parameter) 39

L

layouts  
   5.1 Movie 33  
   Music 35  
 LFE (DSP parameter) 40, 41  
 LipSync (DSP parameter) 34

## M

mains fuse, changing 49  
 Meridian DSP loudspeakers, connecting to 10  
 Mono (DSP preset) 39  
 MusicLogic (DSP preset) 37  
 Music (DSP preset) 35

## P

Panorama (DSP parameter) 37  
 Party? (DSP parameter) 39  
 Phase (DSP parameter) 34  
 PLIIx (DSP preset) 38  
 PLIIx Mov6 (DSP preset) 41  
 PLIIx Movie (DSP preset) 38  
 PLIIx Mus6 (DSP preset) 41  
 PLIIx Music (DSP preset) 37  
 PLIIx THX (DSP preset) 38  
 presets  
   multichannel 40  
   standard parameters 34  
   two-channel 35  
   user-defining 43  
 Pro Logic (DSP parameter) 38

## R

Rear (DSP parameter) 34  
 Roll (DSP parameter) 37, 39  
 Row (DSP parameter) 36  
 R Delay (DSP parameter) 34, 37  
 R Filter (DSP parameter) 35, 36, 40

## S

safety warnings ii  
 settings 23  
   configuring 22  
 Sides (DSP parameter) 34  
 Sine/Sub/Sens controls 30  
 Sine/Sub/ Sens menu, sources 32  
 sinewave sweep test 30  
 Sound Pressure Level meter 25  
 sources  
   options 21  
   sensitivity 32  
   setting up 32  
 sources, configuring 20  
 speakers  
   configuring 18  
   options 19  
   setting up 29  
 speaker layouts 33  
 specifications 3  
 Steered All (DSP parameter) 37, 38, 39  
 Stereo (DSP preset) 38  
 stereo power amplifier, connecting to 11  
 subwoofers  
   connecting to 12  
   crossover frequency 30  
 subwoofer crossover frequency 30  
 Super (DSP preset) 36  
 Surr. Rear (DSP parameter) 35, 40, 41  
 Surrounds (DSP parameters) 39  
 S Delay (DSP parameter) 34, 37  
 S Filter (DSP parameter) 35, 36, 40

## T

THX (DSP preset) 40, 41  
THX Music (DSP preset) 41  
THX Surround EX (DSP preset) 41  
THX Ultra2 Cinema (DSP preset) 41  
Treble (DSP parameter) 34  
Trifield (DSP preset) 35  
troubleshooting 45  
2+2+2 (DSP parameters) 40  
Types 16, 17

## U

UHF format 36  
user-defined presets 43  
    clearing 44  
    editing name 43

## W

Width (DSP parameter) 35, 36, 37

## Y

Yaw (DSP parameter) 37, 39

## Free Manuals Download Website

<http://myh66.com>

<http://usermanuals.us>

<http://www.somanuals.com>

<http://www.4manuals.cc>

<http://www.manual-lib.com>

<http://www.404manual.com>

<http://www.luxmanual.com>

<http://aubethermostatmanual.com>

Golf course search by state

<http://golfingnear.com>

Email search by domain

<http://emailbydomain.com>

Auto manuals search

<http://auto.somanuals.com>

TV manuals search

<http://tv.somanuals.com>