



INSTALLATION INSTRUCTIONS FOR PART 95-5817

APPLICATIONS

FORD

Explorer 1995-2001
 Explorer Sport Trac 2001-2005
 Ranger 1995-2009
 Crown Victoria 1995-2009
 Econoline 1997-2008
 Escape 2001-2007
 Windstar 1999-2003
 Excursion 2000-2005
 Super Duty 1999-2004

LINCOLN

Continental 1995-1997
 Mark VIII 1996-1998
 Town Car 1995-2002

MAZDA

B-Series Pickup 1995-2009

MERCURY

Grand Marquis 1995-2009
 Marauder 2003-2004
 Mountaineer 1997-2001
 Mariner 2005-2007

95-5817

KIT FEATURES

- Double DIN Unit Provision
- Stacked ISO Mounts Units Provision

***NOTE:** Sub dash modifications are necessary to use this dash kit.*

You will need to trim the sub dash to gain suitable depth and height.

***NOTE:** Once the kit is snapped in, it cannot be removed without dash panel removal.*



KIT COMPONENTS

- A) Double Din Trim Brackets
- B) Filler Bar

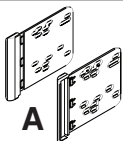

WIRING AND ANTENNA CONNECTIONS (Sold Separately)

Wiring Harness:

- See www.metraonline.com for specific interface applications

Antenna Adapter: Not required.

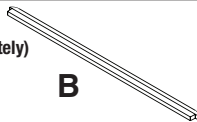

TOOLS REQUIRED:

- Dremel or Suitable Cutting Tool
- Small Flat Blade Screwdriver
- Panel Removal Tool
- Socket Wrench
- Metra 86-5618 Removal Keys

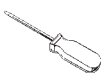

1-800-221-0932



www.metraonline.com

© COPYRIGHT 2009-10 METRA ELECTRONICS CORPORATION



TABLE OF CONTENTS

Dash Disassembly

- All Vehicles1

Kit Assembly

- Double DIN/Stacked ISO Mount Units Provision2

Final Assembly3

***Note:**

Refer also to the instructions included with the aftermarket radio.



KNOWLEDGE IS POWER

Enhance your installation and fabrication skills by enrolling in the most recognized and respected mobile electronics school in our industry. Log onto www.installerinstitute.com or call 800-354-6782 for more information and take steps toward a better tomorrow.

ALL VEHICLES

- 1 Disconnect the negative battery terminal to prevent an accidental short circuit.
- 2 Using the Metra 86-5618 removal keys, slide the radio out of the radio cavity. Unplug and remove the radio. (Figure A)
- 3 Cut and remove obstructions in dash cavity. (*Be careful not to cut into harnesses or electronic components*)

Continue to kit assembly.

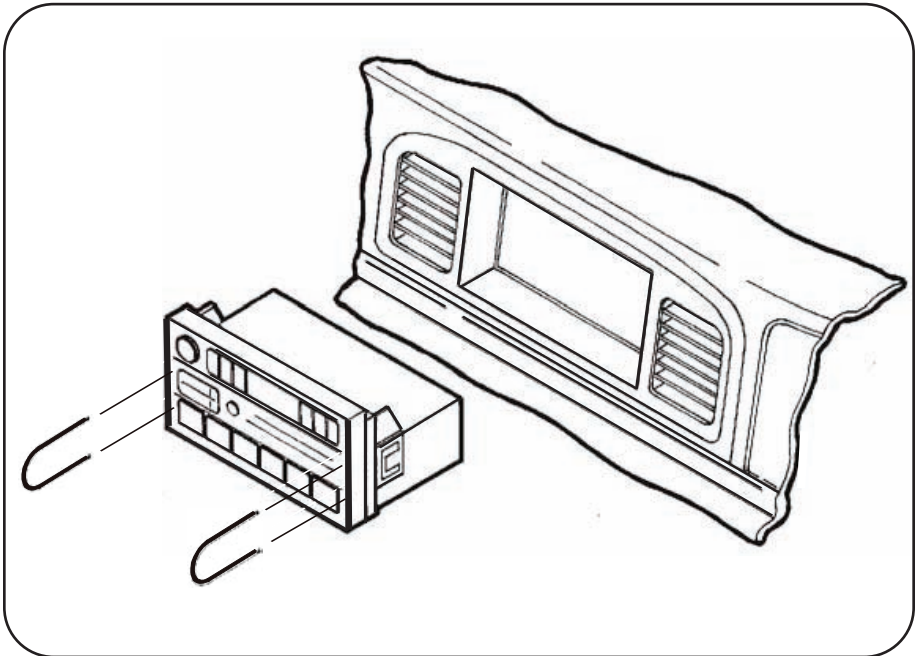

DOUBLE DIN/STACKED ISO MOUNT UNIT(S) PROVISION

****Note: Refer also to the instructions included with the aftermarket radio.***

NOTE: Sub dash modifications are necessary to use this dash kit. You will need to trim the sub dash to gain suitable depth and height.

NOTE: Once the kit is snapped in, it cannot be removed without dash panel removal.

- 1 Attach the double DIN brackets to the double DIN or stacked ISO Mount unit(s) using the screws supplied with the unit(s). (Figure A)

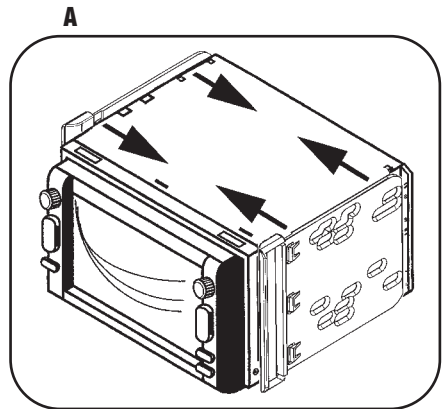

- 2 Locate the factory wiring harness in the dash. Metra recommends using the proper mating adapter and making the connections as shown. (Isolate and individually tape off the ends of any unused wires to prevent electrical short circuit). (Figure B)
- 3 Re-connect the negative battery terminal and test the unit for proper operation.

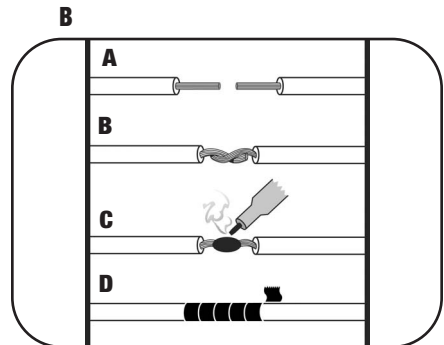

(A) Strip wire ends back 1/2"

B) Twist ends together

C) Solder

D) Tape

Continued on page 3.

NOTE: Major sub dash modifications are necessary to use this dash kit. You will need to trim the sub dash to gain suitable depth and height.

Continued from page 2.

- 4** Slide the double DIN radio or stacked ISO Mount unit assembly into the modified sub dash until it clicks into place.

- 5** Clip the filler bar into the bottom of the radio opening under the radio assembly with the rounded edges facing toward the dash. **Tip:** Hook one side in then push the other side in until it clips. (Figure C)

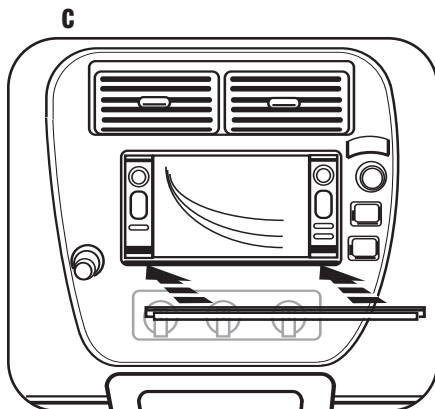

FINAL WIRING CONNECTIONS

Make wiring connections using the EIA color code chart shown below and the instructions included with the head unit. Metra recommends making connections shown below; Strip, Splice, Solder, Tape. Isolate and individually tape off ends of any unused wires to prevent electrical short circuit.

METRA / EIA WIRING CODE

12V Ignition / Acc.	Red	Right Front (+)	Gray
12V Batt / Memory.	Yellow	Right Front (-).	Gray / Black
Ground.	Black*	Left Front (+)	White
Power Antenna.	Blue	Left Front (-).	White / Black
Amp Turn-On	Blue / White	Right Rear (+)	Violet
Amp Ground.	Black / White	Right Rear (-).	Violet / Black
Illumination	Orange	Left Rear (+)	Green
Dimmer	Orange / White	Left Rear (-).	Green / Black

****NOTE: When a Black wire is not present, ground radio to vehicle chassis. All colors may not be present on all leads due to manufacturer's specifications.***

Enjoy your newly installed radio!

95-5817 INSTRUCTIONS



1-800-221-0932



www.metraonline.com

REV. 06/08/10 © COPYRIGHT 2009-10 METRA ELECTRONICS CORPORATION INST95-5817

Free Manuals Download Website

<http://myh66.com>

<http://usermanuals.us>

<http://www.somanuals.com>

<http://www.4manuals.cc>

<http://www.manual-lib.com>

<http://www.404manual.com>

<http://www.luxmanual.com>

<http://aubethermostatmanual.com>

Golf course search by state

<http://golfingnear.com>

Email search by domain

<http://emailbydomain.com>

Auto manuals search

<http://auto.somanuals.com>

TV manuals search

<http://tv.somanuals.com>