



METROLOGIC INSTRUMENTS, INC.
IS6520/MS6520 Cubit[®] Series
Omnidirectional Bar Code Scanner
Installation and User's Guide





LOCATIONS

Corporate Headquarters

North America	Metrologic Instruments, Inc. 90 Coles Road Blackwood, NJ 08012-4683	Customer Service: 1-800-ID-METRO Tel: 856-228-8100 Fax: 856-228-6673 Email: info@metrologic.com Internet: www.metrologic.com
----------------------	---	---

European Headquarters

Germany, Middle East and Africa	Metrologic Instruments GmbH Dornierstrasse 2 82178 Puchheim b. Munich, Germany	Tel: +49 89 89019 0 Fax: +49 89 89019 200 Email: info@europe.metrologic.com Germany Email: info@de.metrologic.com
Spain	Metrologic Eria Ibérica SL Julían Camarillo 29, D-1 Edificio Diapasón 28037 Madrid	Tel: +34 913 272 400 Fax: +34 913 273 829 Email: info@es.metrologic.com
Italy	Metrologic Instruments Italia srl Via Emilia 70 40064 Ozzano dell'Emilia (BO)	Tel: +39 0 51 6511978 Fax: +39 0 51 6521337 Email: info@it.metrologic.com
France	Metrologic Eria France SA 69 Rue de la Belle Etoile ZI Paris Nord II, BP 50057 95947 – ROISSY CDG CEDEX	Tel: +33 (0) 1 48.63.78.78 Fax: +33 (0) 1 48.63.24.94 Email: info@fr.metrologic.com
United Kingdom	Metrologic Instruments UK Limited 58 Tempus Business Centre Kingsclere Road, Basingstoke Hampshire RG21 6XG	Tel: +44 (0) 1256 365900 Fax: +44 (0) 1256 365955 Email: info@uk.metrologic.com
Russia	Metrologic Russia Bolshaya Novodmitrovskaya 14 RU-125015 Moscow Russia	Tel: +7 095 Email: info@ru.metrologic.com

Asia

Singapore	Metrologic Asia (Pte) Ltd No. 8 Kaki Bukit Place 4 th Floor Singapore 416186	Tel: 65-6842-7155 Fax: 65-6842-7166 Email: info@sg.metrologic.com
China	Metro (Suzhou) Technologies Co., Ltd. 221 Xing Hai Street Suzhou Industrial Park Suzhou, China 215021	Tel: 86-512-62572511 Fax: 86-512-62571517 Email: info@cn.metrologic.com
Japan	Metrologic Japan Co., Ltd. Matsunoya Building, 6 Floor 3-14-8 Higashiueno Taitou-Ku, Tokyo 110-0015 Japan	Tel: 81-03-3839-8511 Fax: 81-03-3839-8519 Email: info@jp.metrologic.com

South America

Brazil	Metrologic do Brasil Ltda. Rua da Paz 2059 CEP 04713-002 Chácara Santo Antônio São Paulo, SP, Brasil	Tel: 55-11-5182-8226 Fax: 55-11-5182-8315 Email: info@br.metrologic.com
Outside Brazil	Metrologic South America Rua da Paz 2059 CEP 04713-002 Chácara Santo Antônio São Paulo, SP, Brasil	Tel: 55-11-5182-7273 Fax: 55-11-5182-7198 Email: info@sa.metrologic.com

Copyright

© 2003 by Metrologic Instruments, Inc. All rights reserved. No part of this work may be reproduced, transmitted, or stored in any form or by any means without prior written consent, except by reviewer, who may quote brief passages in a review, or provided for in the Copyright Act of 1976.

Products and brand names mentioned in this document are trademarks of their respective companies.

TABLE OF CONTENTS

Introduction.....	1
Scanner and Accessories.....	2
Installation	
RS232, Light Pen (IS6520-41/MS6520-41)	3
Keyboard Wedge (IS6520-47/MS6520-47).....	4
Stand Alone Keyboard (IS6520-47/MS6520-47).....	5
Disconnecting the PowerLink Cable from the Scanner.....	6
Scanner Parts.....	7
Mounting Holes	7
Stands	8
Audible Indicators	9
Failure Modes.....	10
Visual Indicators	11
Programming Modes	12
Labels.....	15
Maintenance.....	15
Optimal Low and Close Depth of Field.....	16
Optimal High and Normal Depth of Field	17
Far Depth of Field.....	18
Troubleshooting Guide	19
Appendix A	
Design Specifications.....	23
Appendix B	
Default Settings.....	25

TABLE OF CONTENTS

Appendix C

Scanner Pinout Connections	29
Cable Connector Configurations	29

Appendix D

Warranty and Disclaimer	31
-------------------------------	----

Appendix E

Notices	32
---------------	----

Appendix F

Patents	34
---------------	----

Index	35
-------------	----



INTRODUCTION

Metrologic's Cubit[®] Series of compact omnidirectional bar code scanners includes the MS6520 for retail applications and the IS6520 for OEM applications. Both Cubit models have several key product features including:

- Fully Automatic Scanning Operation
- Single Cable Interface To Host
- PowerLink Quick Disconnect User-Replaceable Cables
- 7 Beeper Tones
- Programmable Depth Of Fields
- Capable Of Scanning And Decoding All Standard Barcodes Including Rss-14, RSS Limited And RSS Expanded Bar Codes
- OPOS And JPOS System Compatible
- Sunrise 2005 Compliant

The MS6520 is equipped with a tilt stand that can be mounted securely to the countertop or wall for fixed -mount scanning. The multi-position stand has a locking design that rotates the head of the MS6520 up to 64° making it perfect for installation underneath check writing and credit card stands.

Since the IS6520 was designed to be part of an OEM product, it does not include the tilt stand but instead is equipped with three (3) threaded mounting holes on the back of the unit. The modular design of the IS6520 is versatile enough for integration into a diversity of applications including kiosks, reverse vending machines, time/attendance machines and price look-up systems.

A fixed vertical stand is also available for additional purchase. Please contact a customer service representation at 1-800-ID-METRO for information.

SCANNER	INTERFACE
IS6520-41 or MS6520-41	Full RS232 and Light Pen Emulation
IS6520-47 or MS6520-47	Keyboard Wedge, Stand Alone Keyboard and RS232 Transmit/Receive

SCANNER AND ACCESSORIES

BASIC KIT COMPONENTS	
Part No.	Description
IS6520/MS6520	Cubit® Omnidirectional Scanning Engine
00-02421	Installation and User's Guide*
00-02407	MetroSelect® Configuration Guide*

*Available for download on Metrologic's website, www.metrologic.com.

OPTIONAL ACCESSORIES	
Part No.	Description
AC to DC Power Transformer – Regulated 5.2VDC @ 650 mA output.	
45-45593	120V United States
45-45591	220V-240V Continental European
45-45992	220V-240V United Kingdom
46-46803	220V-240V Australia
46-46983	220V-240V China
<i>xxx - specifies connection to the host</i>	
53-53xxx	PowerLink cable with built in power jack 2.7m (9') coiled cord, long strain relief
54-54xxx	PowerLink cable with built in power jack 2.1m (7') straight cord, short strain relief
54-54002	Keyboard Wedge PowerLink cable and Adapter Cable
54-54020	Stand Alone Keyboard PowerLink Cable
46-46486	Tilt Stand
46-46145	Fixed Vertical Stand

To order additional items, contact the dealer, distributor or call Metrologic's Customer Service Department at 1-800-ID-METRO (1-800-436-3876).

INSTALLATION

RS232, Light Pen (IS6520-41/MS6520-41)

1. Turn off the host device.
2. Plug the male 10-pin RJ45 end of the PowerLink cable into the 10-pin socket on Cubit. You will hear a 'click' when the connection is made.
3. Connect the 9-pin female end of the PowerLink cable to the host device.

Note: Skip to step 6 if receiving power from the host device.

4. Plug the external power supply into the power jack on the PowerLink cable.

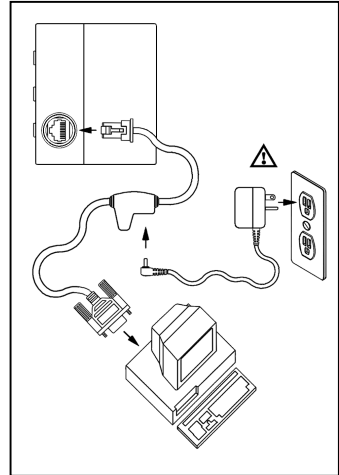

Check the AC input requirements of the power supply to make sure the voltage matches the AC outlet. The outlet must be located near the equipment and be easily accessible.

5. Connect AC power to the transformer.
6. Turn on the host device.



Plugging the scanner into a port on the host system does not guarantee that scanned information will be communicated properly to the host system. The scanner is shipped from the factory configured to a set of default parameters. Please refer to the MetroSelect Configuration Guide (MLPN 00-02407) for instructions on changing the scanner's configuration. In addition, please check that the scanner and host system are using the same communication protocol.



Caution:

To maintain compliance with applicable standards, all circuits connected to the scanner must meet the requirements for SELV (Safety Extra Low Voltage) according to EN 60950.

To maintain compliance with standard CSA C22.2 No. 950/UL 1950 and norm EN 60950, the power source should meet applicable performance requirements for a limited power source.

INSTALLATION

Keyboard Wedge (IS6520-47/MS6520-47)

1. Turn off the host device.
2. Plug the male 10-pin RJ45 end of the PowerLink cable into the 10-pin socket on Cubit. You will hear a 'click' when the connection is made.
3. Disconnect the keyboard from the host device.
4. Connect the "Y" end of the PowerLink cable to the keyboard and the keyboard port on the host device. If necessary use the male/female adapter cable supplied with the scanner to make the proper connections.
5. Plug the external power supply into the power jack on the PowerLink cable.



Check the AC input requirements of the power supply to make sure the voltage matches the AC outlet. The outlet must be located near the equipment and be easily accessible.

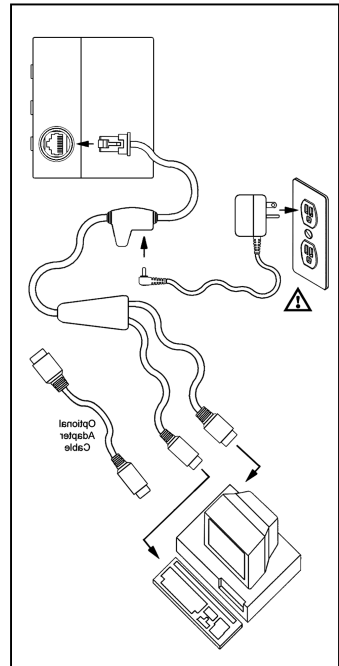

6. Connect AC power to the transformer.
7. Turn on the host device.



Powering the Cubit directly from the host device can sometimes cause interference with the operation of the scanner or the computer. Not all computers supply the same current through the keyboard port. For this reason, Metrologic recommends using an external power supply. For additional information contact a Metrologic customer service representative.



Caution:

To maintain compliance with applicable standards, all circuits connected to the scanner must meet the requirements for SELV (Safety Extra Low Voltage) according to EN 60950.

To maintain compliance with standard CSA C22.2 No. 950/UL 1950 and norm EN 60950, the power source should meet applicable performance requirements for a limited power source.

INSTALLATION

Stand Alone Keyboard (IS6520-47/MS6520-47)

1. Turn off the host device.
2. Plug the male 10-pin RJ45 end of the PowerLink cable into the 10-pin socket on Cubit. You will hear a 'click' when the connection is made.
3. Connect the other end of the PowerLink cable to the keyboard port on the host device.
4. Plug the external power supply into the power jack on the PowerLink cable.



Check the AC input requirements of the power supply to make sure the voltage matches the AC outlet. The outlet must be located near the equipment and be easily accessible.

5. Connect AC power to the transformer.
6. Turn on the host device.

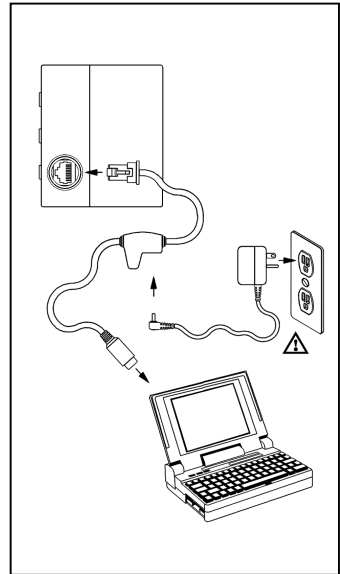

Powering the Cubit directly from the host device can sometimes cause interference with the operation of the scanner or the computer. Not all computers supply the same current through the keyboard port. For this reason, Metrologic recommends using an external power supply. For additional information contact a Metrologic customer service representative.



Caution:

To maintain compliance with applicable standards, all circuits connected to the scanner must meet the requirements for SELV (Safety Extra Low Voltage) according to EN 60950.

To maintain compliance with standard CSA C22.2 No. 950/UL 1950 and norm EN 60950, the power source should meet applicable performance requirements for a limited power source.

DISCONNECTING THE POWERLINK CABLES FROM THE SCANNER

Before removing the cable from the scanner, Metrologic recommends that the power on the host system is off and the power supply has been disconnected from the PowerLink cable.

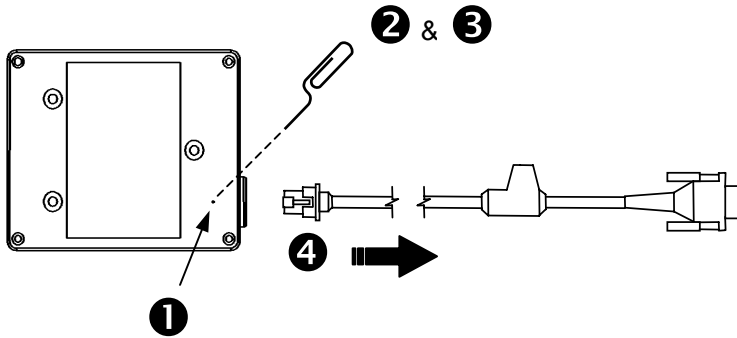

1. Locate the small 'pin-hole' on the back of the scanner.
2. Bend an ordinary paperclip into the shape shown above.
3. Insert the paperclip (or other small metallic pin) into the small 'pin-hole'.
4. You will here a faint 'click'. Pull gently on the strain-relief of the PowerLink cable and it will slide out of the scanner.

SCANNER PARTS

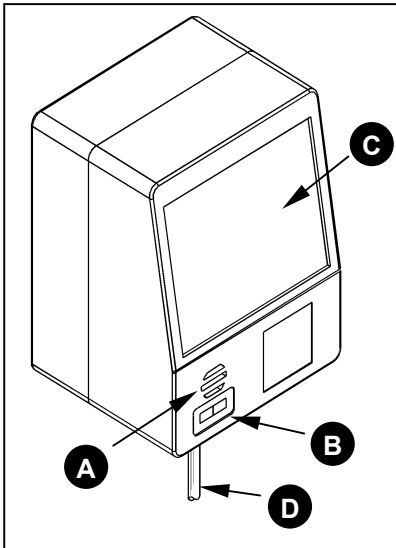

A. Speaker

Serves as an audible indicator.

B. Green & Red LEDs

During normal operation, the green LED is on. This indicates that the laser is on and the unit is ready to scan. On a successful read of a bar code, the red LED will turn on. After communication to the host is complete, the red LED will turn off. The LEDs are also used as diagnostic indicators and mode indicators.

C. Output Window

Laser light emits from this aperture.

D. PowerLink Cable

The IS6520/MS6520 scanner has a 10-pin modular jack. The 10-pin modular plug on the PowerLink cable connects into the IS6520/MS6520.

MOUNTING HOLES

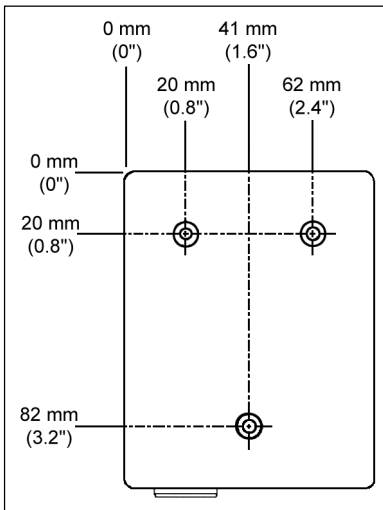

Each IS6520/MS6520 Cubit[®] is equipped with three threaded mounting holes located on the back of the scanner. The following diagram shows the exact location of each mounting hole. The mounting holes are 6 millimeters deep and are threaded for use with 3 millimeter screws.

Caution: Using a screw that is longer than 6 millimeters can potentially damage the scanner.



STANDS

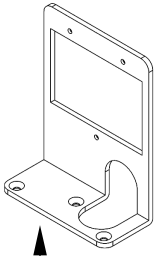

← **Fixed Vertical Stand** (MLPN 46-46145)
Optional purchase.

- a. Fixed Vertical Stand Qty. 1
- b. #7 x 1.00" Wood Screw ... Qty. 3
- c. M3 x 0.5 x 6 mm Screw... Qty. 3

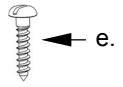

Tilt Stand (MLPN 46-46486) →

- c. Tilt Stand Qty. 1
- d. #8 x 1.00" Wood Screw ... Qty. 3

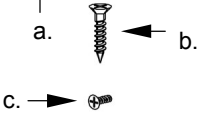
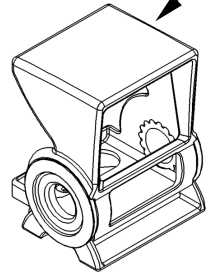

Fixed Vertical Stand Installation (MLPN 46-46145)

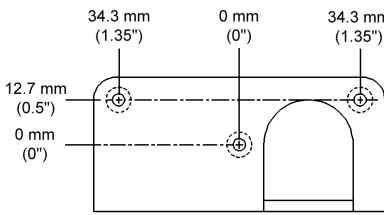

- Step 1: Drill three #43 pilot holes in the countertop.
- Step 2: Attach the stand to the countertop with the three #7 wood screws provided.
- Step 3: Attach the scanner to the stand with the three M3 screws provided.

Tilt Stand Installation (MLPN 46-46486)

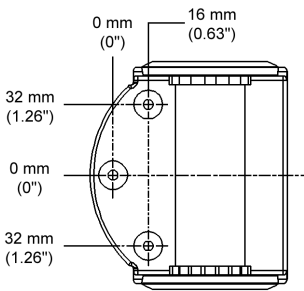

- Step 1: Drill three #39 pilot holes in the countertop.
- Step 2: Insert the scanner into the rubber boot (*the MS6520 is shipped assembled*).
- Step 3: Tilt the scanner forward in the stand.
- Step 4: Attach the stand to the countertop using the three #8 wood screws provided.
- Step 5: Tilt the scanner back into place.

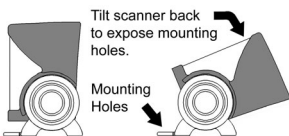

AUDIBLE INDICATORS

When the IS6520/MS6520 scanner is in operation, it provides audible feedback. These sounds indicate the status of the scanner. Eight settings are available for the tone of the beep (normal, 6 alternate tones and no tone). To change the tone, refer to the MetroSelect Configuration Guide (MLPN 00-02407).



One Beep

When the scanner *first* receives power, the green LED will turn on, then the red LED will flash and the scanner will beep once. (The red LED will remain on for the duration of the beep.) The scanner is ready to scan.

When the scanner *successfully* reads a bar code, the red LED will flash and the scanner beeps once (if programmed to do so). If the scanner does not beep once and the red light does not flash, then the bar code has *not* been successfully read.

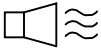

Razzberry Tone

This tone is a failure indicator. Refer to "Failure Modes" page 10.



Three Beeps - During Operation

During operation of the scanner, the red LED will flash while the scanner simultaneously beeps three times (while going into programming mode).

The red LED will continue to flash until the unit exits program mode. Upon exiting program mode, the scanner will beep three times and the red LED will stop flashing. When configured, 3 beeps can also indicate a communications timeout during normal scanning mode.

When using one-code-programming, the scanner will beep three times (the current selected tone), followed by a short pause then by a high tone and a low tone. This tells the user that the single configuration bar code has successfully configured the scanner.

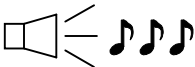

Three Beeps - On Power Up

This is a failure indicator. Refer to "Failure Modes" on page 10.

FAILURE MODES

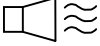
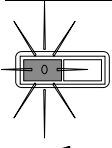

Flashing Green and One Razzberry Tone

This indicates the scanner has experienced a laser subsystem failure. Return the unit for repair at an authorized service center.

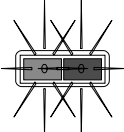

Flashing Green and Red and Two Razzberry Tones

This indicates the scanner has experienced a motor failure. Return the unit for repair at an authorized service center.

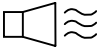

Continuous Razzberry Tone with Both LEDs Off

If, upon power up, the scanner emits a continuous razzberry tone, then the scanner has an electronic failure. Return the unit for repair at an authorized service center.

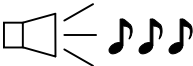

Three Beeps - On Power Up

If the scanner beeps 3 times on power up then, the non-volatile memory that holds the scanner configuration has failed. Return the unit for repair at an authorized service center.

VISUAL INDICATORS

There is a red LED and a green LED on IS6520/MS6520. When the scanner is on, the flashing or stationary, activity of the LEDs indicates the status of the current scan and the scanner.



No Red or Green LED

The LEDs will not be illuminated if the scanner is not receiving power from the host or transformer.



Steady Green

When the laser is active, the green LED is illuminated. The green LED will remain illuminated until the laser is deactivated. During the power save mode, the laser will turn on and turn off. During this period, the green LED remains illuminated.

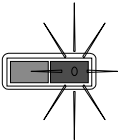

Steady Green and Single Red Flash

When the scanner successfully reads a bar code, the red LED will flash and the scanner will beep once. If the red LED does not flash or the scanner does not beep once, then the bar code has not been successfully read.



Steady Green and Steady Red

After a successful scan, the scanner transmits the data to the host device. Some communication modes require that the host inform the scanner when data is ready to be received. If the host is not ready to accept the information, the scanner's red LED will remain on until the data can be transmitted.

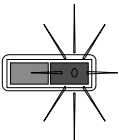

Steady Green and Flashing Red

This indicates the scanner is in program mode. A razzberry tone indicates that an invalid bar code has been scanned in this mode.



Steady Red, Green Off

This indicates the scanner may be waiting for communication from the host.

PROGRAMMING MODES

The IS6520/MS6520 Cubit has 3 modes of programming.

Bar Codes: Cubit can be configured by scanning the bar codes located in the MetroSelect Configuration Guide (MLPN 00-02407). Please refer to this guide for instructions. This manual can be downloaded for FREE from Metrologic's website (www.metrologic.com).

MetroSet[®]: This user-friendly Windows-based configuration program allows you to simply 'point-and-click' at the desired scanner options. This program can be downloaded for FREE from Metrologic's website (www.metrologic.com), or set-up disks can be ordered by calling 1-800-ID-METRO.

Serial Programming: This mode of programming is ideal for OEM applications. This mode gives the end-user the ability to send a series of commands using the serial port of the host system. The commands are equivalent to the numerical values of the bar codes located in the MetroSelect Configuration Guide.

How does Serial Programming work?

1. Each command sent to the scanner is the ASCII representation of each numeral in the configuration bar code. The entire numeric string is framed with an ASCII [stx] and an ASCII [etx].

EXAMPLE #1: Command for Disabling Codabar

Command = [stx]100104[etx]

String Sent to Scanner = 02h 31h 30h 30h 31h 30h 34h 03h

(All values are hexadecimal).

2. If the command sent to the scanner is valid, the scanner will respond with an [ack].
3. If the command sent to the scanner is invalid, the scanner will respond with a [nak].

NOTE: If this occurs, the end-user must start over at the very beginning of the configuration sequence. Simply re-transmitting the invalid command will not work, you must start over.

4. During programming, the motor and laser remain active. YOU CANNOT SCAN ANY BAR CODES WHILE IN PROGRAM MODE.
5. There is a 20 second window between commands. If a 20 second timeout occurs, the scanner will send a [nak] and you must start over.

PROGRAMMING MODES (CONTINUED)

6. To enter serial program mode, send the following command [stx]999999[etx].
7. To exit serial program mode, send the following command [stx]999999[etx], the scanner will respond with an [ack] and a long beep.
8. This mode uses the current Baud Rate, Parity, Stop Bits and Data Bits settings that are configured in the scanner. The default settings of the scanner are 9600, Space, 2, 7 respectively. If a command is sent to the scanner to change any of these settings, the change will NOT take effect until after serial program mode is exited.

EXAMPLE #2: The following example will set the scanner to the factory default settings, Disable Scanning of Code 128 bar codes, change the beeper tone, and add a “G” as a programmable prefix.

<u>FEATURE</u>	<u>HOST</u> <u>COMMAND</u>	<u>ASCII REPRESENTATION</u>	<u>SCANNER</u> <u>RESPONSE</u>
Enter Program Mode	[stx]999999[etx]	02h 39h 39h 39h 39h 39h 39h 03h	[ack] or 06h
Load Defaults	[stx]999998[etx]	02h 39h 39h 39h 39h 39h 38h 03h	[ack] or 06h
Disable Code 128	[stx]100113[etx]	02h 31h 30h 30h 31h 31h 33h 03h	[ack] or 06h
Alternate Tone 1	[stx]318565[etx]	02h 33h 31h 38h 35h 36h 35h 03h	[ack] or 06h
Prog. Prefix #1	[stx]903500[etx]	02h 39h 30h 33h 35h 30h 30h 03h	[ack] or 06h
Code Byte 0	[stx]0[etx]	02h 30h 03h	[ack] or 06h
Code Byte 7	[stx]7[etx]	02h 37h 03h	[ack] or 06h
Code Byte 1	[stx]1[etx]	02h 31h 03h	[ack] or 06h
Exit Program Mode	[stx]999999[etx]	02h 39h 39h 39h 39h 39h 39h 03h	[ack] or 06h

The scanner will emit a long beep!

The commands sent to the scanner do not include the small superscripted ‘3’ that you see in front of each bar code string in the MetroSelect® manual. THE ‘3’ SHOULD NOT BE SENT, IT IS A CODE TYPE DESIGNATION ONLY!

As you will note for commands requiring additional bar codes to be scanned (such as prefixes, suffixes, timeouts, etc.), simply send the code bytes in the same order that you would normally scan the bar codes.

PROGRAMMING MODES (CONTINUED)

EXAMPLE #3: The following example shows the events that occur when an invalid bar code is sent. This sample will load the factory default settings and then set the baud rate to 19200.

<u>FEATURE</u>	<u>HOST COMMAND</u>	<u>ASCII REPRESENTATION</u>	<u>SCANNER RESPONSE</u>
Enter Program Mode	[stx]999999[etx]	02h 39h 39h 39h 39h 39h 39h 03h	[ack] or 06h
Load Defaults	[stx]999999:[etx]	02h 39h 39h 39h 39h 39h 3Ah 03h	[nak] or 15h
Invalid command was sent, you must start over!			
Enter Program Mode	[stx]999999[etx]	02h 39h 39h 39h 39h 39h 39h 03h	[ack] or 06h
Load Defaults	[stx]999998[etx]	02h 39h 39h 39h 39h 39h 39h 03h	[ack] or 06h
19200 Baud Rate	[stx]415870[etx]	02h 34h 31h 35h 38h 37h 30h 03h	[ack] or 06h
Exit Program Mode	[stx]999999[etx]	02h 39h 39h 39h 39h 39h 39h 03h	[ack] or 06h
The scanner will emit a long beep!			

This example illustrates 2 important points.

First, if an invalid command is sent from the host, the scanner responds with a [nak] and the end-user must start over from the beginning.

Second, if a command is sent to change the Baud Rate, the new baud rate does not take effect until after the end-user exits program mode.

ABREVIATED ASCII TABLE

Character	Hex Value	Decimal Value
[STX]	02h	2
[ETX]	03h	3
[ACK]	06h	6
[NAK]	15h	21
0	30h	48
1	31h	49
2	32h	50
3	33h	51
4	34h	52
5	35h	53
6	36h	54
7	37h	55
8	38h	56
9	39h	57

LABELS

Each scanner has a label on the back of the unit that lists the model number, date of manufacture, serial number, CE and caution information. The following is an example of the label:

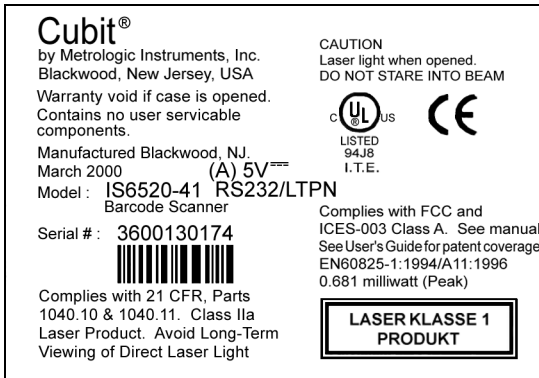

MAINTENANCE

Smudges and dirt can interfere with the proper scanning of a bar code. Therefore, the output window will need occasional cleaning.

1. Spray glass cleaner onto lint free, non-abrasive cleaning cloth.
2. Gently wipe the scanner window.

OPTIMAL LOW AND CLOSE DEPTH OF FIELD

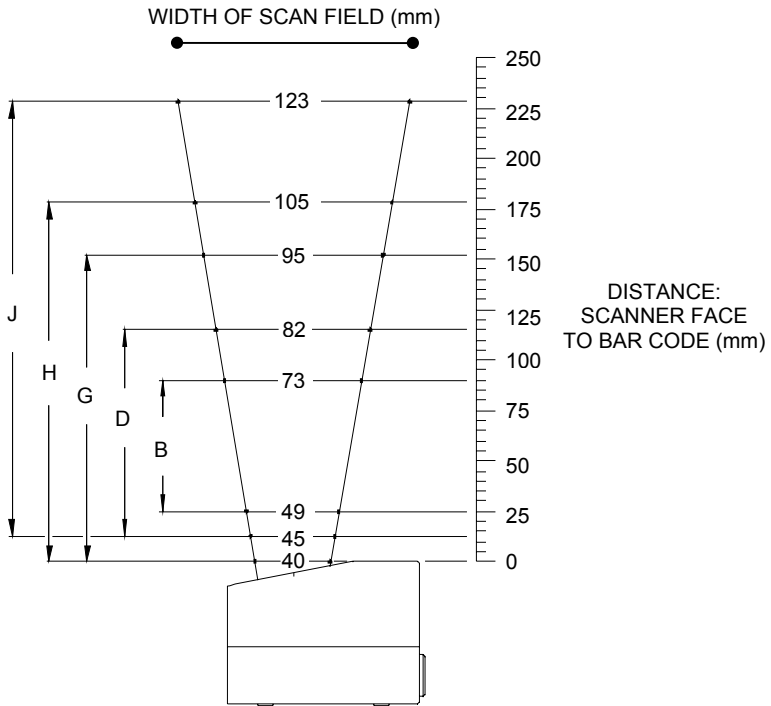

Minimum Bar Code Element Width										
	A	B	C	D	E	F	G	H	J	K
mm	-	.15	-	.17	-	-	.25	.33	.53	-
mils	-	5.7	-	6.8	-	-	10	13	21	-

Note: The same depth of field is achieved when programming Cubit[®] for either Optimal Low Depth of Field or Close Depth of Field.

OPTIMAL HIGH AND NORMAL DEPTH OF FIELD

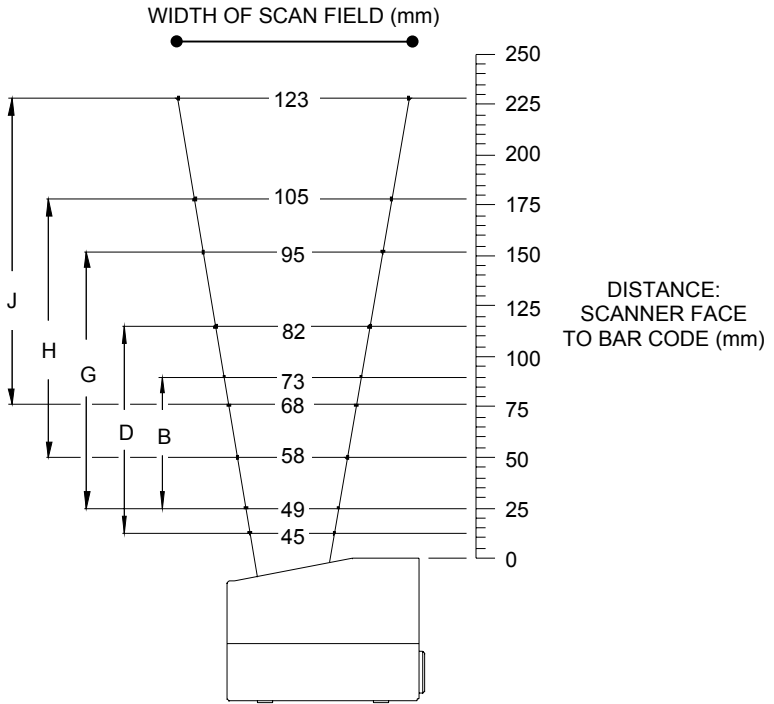

Minimum Bar Code Element Width										
	A	B	C	D	E	F	G	H	J	K
mm	-	.15	-	.17	-	-	.25	.33	.53	-
mils	-	5.7	-	6.8	-	-	10	13	21	-

Note: The same depth of field is achieved when programming Cubit® for either Optimal High Depth of Field or Normal Depth of Field.

FAR DEPTH OF FIELD

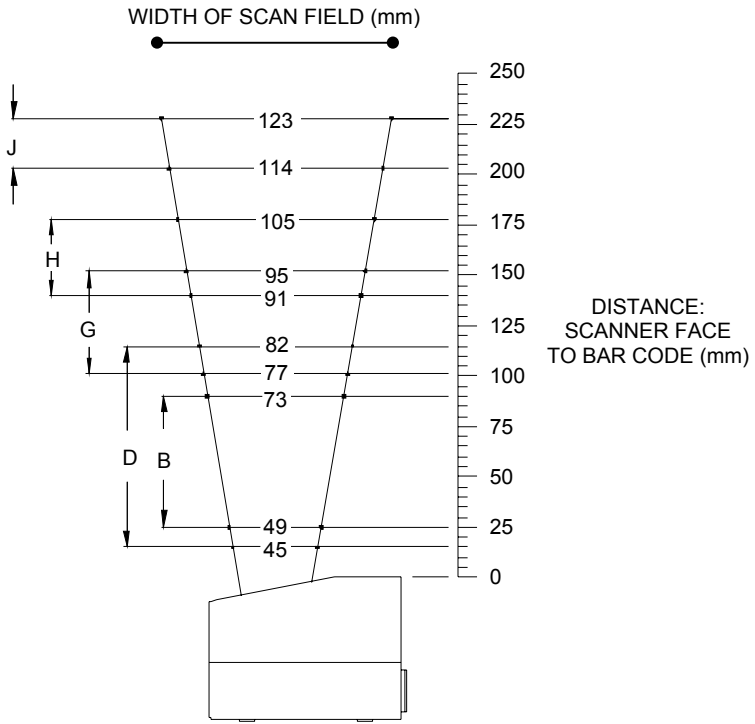

Minimum Bar Code Element Width										
	A	B	C	D	E	F	G	H	J	K
mm	-	.15	-	.17	-	-	.25	.33	.53	-
mils	-	5.7	-	6.8	-	-	10	13	21	-

TROUBLESHOOTING GUIDE

The following guide is for reference purposes only. Contact a Metrologic representative at 1-800-ID-METRO or 1-800-436-3876 to preserve the limited warranty terms.

All Interfaces

IS6520/MS6520 Series Troubleshooting Guide		
SYMPTOMS	POSSIBLE CAUSE(S)	SOLUTION
No LEDs, beep or motor spin	No power is being supplied to the scanner	Check transformer, outlet and power strip. Make sure the cable is plugged in to the scanner
No LEDs, beep	No power is being supplied to the scanner front host	Some host system's cannot supply enough current to power Omni-Quest. Use the power supply included with the scanner.
3 beeps on power up	Non-volatile RAM failure	Contact a Metrologic Representative, if the unit will not hold the programmed configuration
Continuous razz tone on power up	RAM or ROM failure	Contact a Metrologic Representative, if the unit will not function
Razz tone and green LED flash at power up	VLD failure	Contact a Metrologic Representative
Razz tone and both LEDs flash at power up	Scanner motor failure	Contact a Metrologic Representative
Unit scans, Communicates and beeps twice	Same symbol timeout set too short	Adjust same symbol timeout for a longer time

TROUBLESHOOTING GUIDE (CONTINUED)

All Interfaces

IS6520/MS6520 Series Troubleshooting Guide (continued)		
SYMPTOMS	POSSIBLE CAUSE(S)	SOLUTION
The unit powers up, but does not scan and/or beep	Beeper disabled. No tone selected	Enable beeper. Select tone
The unit powers up, but does not scan and/or beep	Scanning a particular symbology that is not enabled	UPC/EAN, Code 39, interleaved 2 of 5, Code 93, Code 128 and Codabar are enabled by default. Verify that the type of bar code being read has been selected
The unit powers up, but does not scan and/or beep	The scanner has been programmed for a character length lock, or a minimum length and bar code being scanned does not satisfy the programmed criteria	Verify that the bar code that is being scanned falls into the criteria. (Typical of Non-UPC/EAN codes.) (<i>The scanner defaults to a minimum of 4 character bar code</i>)
The unit scans a bar code, but locks up after the first scan (red LED stays on)	The scanner is configured to support some form of host handshaking but is not receiving the signal	If the scanner is setup to support ACK/NAK, RTS/CTS, XON/XOFF or D/E, verify that the host cable and host are supporting the handshaking properly
The unit scans, but the data transmitted to the host is incorrect	The scanner's data format does not match the host system requirements	Verify that the scanner's data format matches that required by the host. Make sure that the scanner is connected to the proper host port

TROUBLESHOOTING GUIDE (CONTINUED)

All Interfaces

IS6520/MS6520 Series Troubleshooting Guide (continued)		
SYMPTOMS	POSSIBLE CAUSE(S)	SOLUTION
Scanner beeps at some bar codes and NOT for others of the same bar code symbology	The print quality of the bar code is suspect	Check print mode. The type of printer could be the problem. Change print settings. For example change to econo mode or high speed
Scanner beeps at some bar codes and NOT for others of the same bar code symbology	The aspect ratio of the bar code is out of tolerance	Check print mode. The type of printer could be the problem. Change print settings, ie change to econo mode or high speed
Scanner beeps at some bar codes and NOT for others of the same bar code symbology	The bar code may have been printed incorrectly	Check if it is a check digit, character, or border problem
Scanner beeps at some bar codes and NOT for others of the same bar code symbology	The scanner is not configured correctly for this type of bar code	Check if check digits are set properly
Scanner beeps at some bar codes and NOT for others of the same bar code symbology	The minimum symbol length setting does not work with the bar code	Check if the correct minimum symbol length is set

TROUBLESHOOTING GUIDE (CONTINUED)

RS232 only

IS6520/MS6520 Series Troubleshooting Guide (continued)		
SYMPTOMS	POSSIBLE CAUSE(S)	SOLUTION
Powers up OK and scans OK but does not communicate properly to the host	Com port at the host is not working or configured properly	Check to make sure that the baud rate, data bits, stops bits and parity of the scanner and the communication port match and the program is looking for "RS232" data
Powers up OK and scans OK but does not communicate properly to the host	Cable not connected to the proper com port	Check to make sure that the baud rate, data bits, stops bits and parity of the scanner and the communication port match and the program is looking for "RS232" data
Powers up OK and scans OK but does not communicate properly to the host	Com port not operating properly	Check to make sure that the baud rate, data bits, stops bits and parity of the scanner and the communication port match and the program is looking for "RS232" data
The host is receiving data but the data does not look correct	The scanner and host may not be configured for the same interface font	Check that the scanner and the host are configured for the same interface font
Characters are being dropped	Intercharacter delay needs to be added to the transmitted output	Add some Intercharacter delay to the transmitted output by using the MetroSelect Configuration Guide (mlpn 00-02407)

APPENDIX A

Design Specifications

Operational

Light Source:	VLD 650 ± 10 nm, 0.681 milliwatts (PEAK)
Depth of Field:	0 mm to 176 mm (0" to 7") for 0.33 mm (13 mil) bar code at default setting (programmable)
Scan Speed:	1000 scan lines/second
Scan Pattern:	5 fields of 4 parallel lines (omnidirectional)
Scan Lines:	20
Min Bar Width:	0.145 mm (5.7 mil)
Decode capability:	Autodiscriminates all standard bar codes; for other symbologies call Metrologic
System Interfaces:	RS-232, Light Pen Emulation, Keyboard Wedge, Stand Alone Keyboard
Print Contrast:	35% minimum reflectance difference
Roll, Pitch, Yaw:	360°, 60°, 60°
Indicators:	Green = laser on, ready to scan; Red = good read, decoding
Beeper Operation:	7 tones or no beep

Mechanical

Length:	102 mm (4.0")
Width:	83 mm (3.25")
Height (front edge):	70 mm (2.75")
Height (back edge):	55 mm (2.25")
Weight:	298 g (10.5 oz)
Termination:	10 Position Modular RJ45
Mounting Holes:	3 mm threaded; maximum depth of 6 mm (0.24")

APPENDIX A (CONTINUED)

Design Specifications

Electrical

Power:	1.0 W
Input Voltage:	5 VDC \pm 0.25 V
Operating Current:	200 mA typical @5VDC
DC Transformers:	Class 2; 5.2 VDC @ 650 mA
EMC:	FCC, ICES-003 & EN 55022 Class A
Laser Class:	CDRH Class IIa EN 60825-1:1994/A11: 1996 CLASS 1

Environmental

Operating Temperature:	-20°C to 40°C (-4°F to 104°F)
Storage Temperature:	-40°C to 60°C (-40°F to 140°F)
Humidity:	5% to 95% relative humidity, non-condensing
Light Levels:	Up to 4840 Lux (450 footcandles)
Contaminants:	Sealed to resist airborne particulate contaminants
Ventilation:	None required

Specifications subject to change without notice.

APPENDIX B

Default Settings

Many functions of the scanner can be "programmed" - that is, enabled or disabled. The scanner is shipped from the factory programmed to a set of default conditions. The default parameter of the scanner has an asterisk (*) in the charts on the following pages. If an asterisk is not in the default column then the default setting is Off or Disabled. Every communication does not support every parameter. If the communication supports a parameter listed in the charts on the following pages, a check mark will appear.

Parameter	Default	RS232*	Light Pen	KBW
UPC/EAN	*	✓	✓	✓
Code 128	*	✓	✓	✓
Code 93	*	✓	✓	✓
Codabar		✓	✓	✓
Interleaved 2 of 5 (ITF)	*	✓	✓	✓
MOD 10 Check on ITF		✓	✓	✓
Code 11		✓	✓	✓
Code 39	*	✓	✓	✓
Full ASCII Code 39		✓	✓	✓
MOD 43 Check on Code 39		✓	✓	✓
MSI-Plessey		✓	✓	✓
MSI-Plessey, 10/10 Check Digit		✓	✓	✓
MSI-Plessey, MOD 10 Check Digit	*	✓	✓	✓
Paraf Support		✓	✓	✓
ITF Symbol Lengths	Variable	✓	✓	✓
Minimum Symbol Length	4	✓	✓	✓
Symbol Length Lock	None	✓	✓	✓
Bars High as Code 39	*		✓	
Spaces High as Code 39			✓	
Bars High as Scanned			✓	
Spaces High as Scanned			✓	
DTS/SIEMENS				

APPENDIX B (CONTINUED)

Parameter	Default	RS232*	Light Pen	KBW
DTS/NIXDORF	*			
NCR F				
NCR S				
Poll Light Pen Source			✓	
Beeper Tone	Normal	✓	✓	✓
Beep/Transmit Sequence	Before Transmit	✓	✓	✓
Communication Timeout	None	✓	✓	✓
Razzberry Tone on Timeout		✓	✓	✓
Three Beeps on Timeout		✓	✓	✓
No Beeps on Timeout	*	✓	✓	✓
Enter Power Save Mode	10 mins.	✓	✓	✓
Same Symbol Rescan Timeout: 200 msec		✓	✓	✓
Same Symbol Rescan Timeout: 500 msec Programmable in 50 msec steps (MAX 6.35 seconds)	*	✓	✓	✓
Same Symbol Rescan Timeout: 1250 msec		✓	✓	✓
Same Symbol Rescan Timeout: 2000 msec		✓	✓	✓
Intercharacter Delay Programmable in 1 msec steps (MAX 255 msec)	1 msec 10 msec in KBW	✓		✓
Number of Scan Buffers	1	✓	✓	✓
Transmit UPC-A Check Digit	*	✓	✓	✓
Transmit UPC-E Check Digit		✓	✓	✓
Expand UPC-E		✓	✓	✓
Convert UPC-A to EAN-13		✓		✓
Transmit Lead Zero on UPC-E		✓	✓	✓
Convert EAN-8 to EAN-13		✓		✓
Transmit UPC-A Number System	*	✓	✓	✓

APPENDIX B (CONTINUED)

Parameter	Default	RS232*	Light Pen	KBW
Transmit UPC-A Manufacturer ID#	*	✓	✓	✓
Transmit UPC-A Item ID#	*	✓	✓	✓
Transmit Codabar Start/Stop Characters		✓		✓
CLSI Editing (Enable)		✓		✓
Transmit Mod 43 Check Digit on Code 39		✓		✓
Transmit Code 39 Stop/Start Characters		✓		✓
Transmit Mod 10/ITF		✓		✓
Transmit MSI-Plessey Check Characters		✓		✓
Parity	Space	✓		
Baud Rate	9600	✓		
8 Data Bits		✓		
7 Data Bits	*	✓		
Transmit Sanyo ID Characters		✓		✓
Nixdorf ID		✓		✓
LRC Enabled		✓		✓
UPC Prefix		✓		✓
UPC Suffix		✓		✓
Transmit AIM ID Characters		✓		✓
STX Prefix		✓		✓
ETX Suffix		✓		✓
Carriage Return	*	✓		✓
Line Feed	*	✓		✓
Tab Prefix		✓		✓
Tab Suffix		✓		✓
"DE" Disable Command		✓		
"FL" Laser Enable Command		✓		
DTR Handshaking Support		✓		
RTS/CTS Handshaking		✓		
Character RTS/CTS	*	✓		

APPENDIX B (CONTINUED)

Parameter	Default	RS232*	Light Pen	KBW
Message RTS/CTS		✓		
XON/XOFF Handshaking		✓		
ACK/NA K		✓		
Two Digit Supplements		✓	as code 39	✓
Five Digit Supplements		✓	as code 39	✓
Bookland		✓	as code 39	✓
977 (2 digit) Supplemental Requirement		✓	✓	✓
Supplements are not Required	*	✓	✓	✓
Two Digit Redundancy	*	✓	✓	✓
Five Digit Redundancy		✓	✓	✓
100 msec to Find Supplement Programmable in 100 msec steps (MAX 800 msec)	*	✓	✓	✓
Coupon Code 128		✓	as code 39	✓
Programmable Code Lengths	7 avail.	✓	✓	✓
Programmable Prefix Characters	10 avail.	✓		
Suffix Characters		✓		
Prefixes for individual Code Types				
Editing		✓	✓	✓
Inter Scan-Code Delay Programmable (100 msec steps)	800 msec			✓
Function/Control Key Support				
Minimum Element Width Programmable in 5.6 μ sec steps	1 msec		✓	
Depth of Field				
Optimal High Depth of Field	*	✓	✓	✓
Normal Depth of Field		✓	✓	✓
Optimal Low Depth of Field		✓	✓	✓
Close Depth of Field		✓	✓	✓
Far Depth of Field		✓	✓	✓

APPENDIX C

Scanner Pinout Connections

The IS6520/MS6520 scanner interfaces terminate to a 10-pin modular jack. The serial # label indicates the interface enabled when the scanner is shipped from the factory.

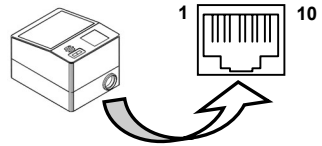

IS6520-47 / MS6520-47 Keyboard Wedge	
Pin	Function
1	Ground
2	RS-232 Transmit Output
3	RS-232 Receive Input
4	PC Data
5	PC Clock
6	KB Clock
7	PC +5V
8	KB Data
9	+5VDC
10	Shield Ground

IS6520-41 / MS6520-41 RS-232/LTPN	
Pin	Function
1	Ground
2	RS-232 Transmit Output
3	RS-232 Receive Input
4	RTS Output
5	CTS Input
6	DTR Input/LTPN Source
7	Reserved
8	LTPN Data
9	+5VDC
10	Shield Ground

Cable Connector Configurations

"Standard" PowerLink cable (MLPN 53000 or 54000)	
9-pin D-type female connector to the PC	
Pin	Function
1	Shield Ground
2	RS-232 Transmit Output
3	RS-232 Receive Input
4	DTR Input
5	Power/Signal Ground
6	Light Pen Data
7	CTS Input
8	RTS Output
9	+5VDC*

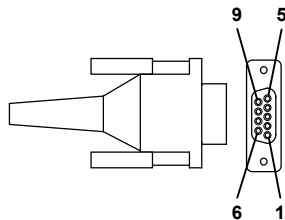

9-Pin D-Type Connector

* If a PowerLink power supply is plugged into the PowerLink cable, +5V will NOT be available on this pin. This pin is used when the host is supplying +5V to the scanner.

APPENDIX C (CONTINUED)

Keyboard Wedge Powerlink and Adapter Cable (MLPN 54-54008)

The Keyboard Wedge PowerLink cable is terminated with a 5-pin DIN female connector on one end, and a 6-pin mini DIN male on the other.

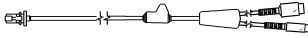

**Keyboard Wedge
PowerLink Cable**

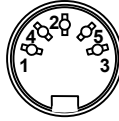

5-Pin DIN, Female

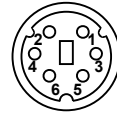

6-Pin DIN, Male

Metrologic will supply an adapter cable with a 5-pin DIN male connector on one end and a 6-pin mini DIN female connector on the other.

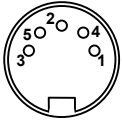

5-Pin Din, Male



Adapter Cable

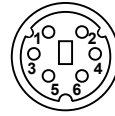

6-pin Mini Din, Female

According to the termination required, connect the appropriate end of the adapter cable to the PowerLink cable, leaving the necessary termination exposed for connecting to the keyboard and the keyboard port on the PC.

The pin assignments are as follows:

PowerLink Cable

5-pin Female DIN	
Pin	Function
1	Keyboard Clock
2	Keyboard Data
3	No Connect
4	Power Ground
5	+5 Volts DC
6-pin Male Mini-DIN	
Pin	Function
1	PC Data
2	No Connect
3	Power Ground
4	+5 Volts DC
5	PC Clock
6	No Connect

Adapter Cable

5-pin Male DIN	
Pin	Function
1	PC Clock
2	PC Data
3	No Connect
4	Power Ground
5	+5 Volts DC
6-pin Female Mini-DIN	
Pin	Function
1	Keyboard Data
2	No Connect
3	Power Ground
4	+5 Volts DC
5	Keyboard Clock
6	No Connect

APPENDIX D

Warranty and Disclaimer

Limited Warranty

The IS6520/MS6520 Cubit[®] scanners are manufactured by Metrologic at its Blackwood, New Jersey, U.S.A. facility. The IS6520/MS6520 Cubit[®] scanners have a two (2) year limited warranty from the date of manufacture. Metrologic warrants and represents that all IS6520/MS6520 Cubit[®] scanners are free of all defects in material, workmanship and design, and have been produced and labeled in compliance with all applicable U.S. Federal, state and local laws, regulations and ordinances pertaining to their production and labeling.

This warranty is limited to repair, replacement of Product or refund of Product price at the sole discretion of Metrologic. Faulty equipment must be returned to the Metrologic facility in Blackwood, New Jersey, U.S.A. or Puchheim, Germany. To do this, contact Metrologic's Customer Service/Repair Department to obtain a Returned Material Authorization (RMA) number.

In the event that it is determined the equipment failure is covered under this warranty, Metrologic shall, at its sole option, repair the Product or replace the Product with a functionally equivalent unit and return such repaired or replaced Product without charge for service or return freight, whether distributor, dealer/reseller, or retail consumer, or refund an amount equal to the original purchase price.

This limited warranty does not extend to any Product which, in the sole judgement of Metrologic, has been subjected to abuse, misuse, neglect, improper installation, or accident, nor any damage due to use or misuse produced from integration of the Product into any mechanical, electrical or computer system. The warranty is void if the case of Product is opened by anyone other than Metrologic's repair department or authorized repair centers.

THIS LIMITED WARRANTY, EXCEPT AS TO TITLE, IS IN LIEU OF ALL OTHER WARRANTIES OR GUARANTEES, EITHER EXPRESS OR IMPLIED, AND SPECIFICALLY EXCLUDES, WITHOUT LIMITATION, WARRANTIES OF MERCHANTABILITY AND FITNESS FOR A PARTICULAR PURPOSE UNDER THE UNIFORM COMMERCIAL CODE, OR ARISING OUT OF CUSTOM OR CONDUCT. THE RIGHTS AND REMEDIES PROVIDED HEREIN ARE EXCLUSIVE AND IN LIEU OF ANY OTHER RIGHTS OR REMEDIES. IN NO EVENT SHALL METROLOGIC BE LIABLE FOR ANY INDIRECT OR CONSEQUENTIAL DAMAGES, INCIDENTAL DAMAGES, DAMAGES TO PERSON OR PROPERTY, OR EFFECT ON BUSINESS OR PROPERTY, OR OTHER DAMAGES OR EXPENSES DUE DIRECTLY OR INDIRECTLY TO THE PRODUCT, EXCEPT AS STATED IN THIS WARRANTY. IN NO EVENT SHALL ANY LIABILITY OF METROLOGIC EXCEED THE ACTUAL AMOUNT PAID TO METROLOGIC FOR THE PRODUCT. METROLOGIC RESERVES THE RIGHT TO MAKE ANY CHANGES TO THE PRODUCT DESCRIBED HEREIN.

Metrologic Instruments, Inc.
90 Coles Road
Blackwood, NJ 08012-4683
Customer Service Department:
1-800-ID-METRO (1-800-436-3876)
TEL: 856-228-8100
FAX: 856-228-6673

Metrologic Instruments GmbH
Dornierstrasse 2
82178 Puchheim b
Munich, Germany
TEL: 49-89-89019-0
FAX: 49-89-89019-200

APPENDIX E

Notices

Notice

This equipment has been tested and found to comply with limits for a Class A digital device, pursuant to Part 15 of the FCC Rules. These limits are designed to provide reasonable protection against harmful interference when the equipment is operated in a commercial environment. This equipment generates, uses and can radiate radio frequency energy and, if not installed and used in accordance with the instruction manual, may cause harmful interference to radio communications. Operation of this equipment in a residential area is likely to cause harmful interference, in which case the user will be required to correct the interference at his own expense. Any unauthorized changes or modifications to this equipment could void the users authority to operate this device.

This device complies with Part 15 of the FCC Rules. Operation is subject to the following two conditions: (1) This device may not cause harmful interference, and (2) this device must accept any interference received, including interference that may cause undesired operation.

Notice

This Class A digital apparatus complies with Canadian ICES-003.

Remarque

Cet appareil numérique de la classe A est conforme à la norme NMB-003 du Canada.

Caution

Use of controls or adjustments or performance of procedures other than those specified herein may result in hazardous laser light exposure. Under no circumstances should the customer attempt to service the laser scanner. Never attempt to look at the laser beam, even if the scanner appears to be nonfunctional. Never open the scanner in an attempt to look into the device. Doing so could result in hazardous laser light exposure. The use of optical instruments with the laser equipment will increase eye hazard.

Atención

La modificación de los procedimientos, o la utilización de controles o ajustes distintos de los especificados aquí, pueden provocar una luz de láser peligrosa. Bajo ninguna circunstancia el usuario deberá realizar el mantenimiento del láser del escáner. Ni intentar mirar al haz del láser incluso cuando este no esté operativo. Tampoco deberá abrir el escáner para examinar el aparato. El hacerlo puede conllevar una exposición peligrosa a la luz de láser. El uso de instrumentos ópticos con el equipo láser puede incrementar el riesgo para la vista.

Attention

L'emploi de commandes, réglages ou procédés autres que ceux décrits ici peut entraîner de graves irradiations. Le client ne doit en aucun cas essayer d'entretenir lui-même le scanner ou le laser. Ne regardez jamais directement le rayon laser, même si vous croyez que le scanner est inactif. N'ouvrez jamais le scanner pour regarder dans l'appareil. Ce faisant, vous vous exposez à une rayonnement laser qui est dangereux. L'emploi d'appareils optiques avec cet équipement laser augmente le risque d'endommagement de la vision.

Achtung

Die Verwendung anderer als der hier beschriebenen Steuerungen, Einstellungen oder Verfahren kann eine gefährliche Laserstrahlung hervorrufen. Der Kunde sollte unter keinen Umständen versuchen, den Laser-Scanner selbst zu warten. Sehen Sie niemals in den Laserstrahl, selbst wenn Sie glauben, daß der Scanner nicht aktiv ist. Öffnen Sie niemals den Scanner, um in das Gerät hineinzusehen. Wenn Sie dies tun, können Sie sich einer gefährlichen Laserstrahlung aussetzen. Der Einsatz optischer Geräte mit dieser Laserausrüstung erhöht das Risiko einer Sehschädigung.

Attenzione

L'utilizzo di sistemi di controllo, di regolazioni o di procedimenti diversi da quelli descritti nel presente Manuale può provocare delle esposizioni a raggi laser rischiose. Il cliente non deve assolutamente tentare di riparare egli stesso lo scanner laser. Non guardate mai il raggio laser, anche se credete che lo scanner non sia attivo. Non aprite mai lo scanner per guardare dentro l'apparecchio. Facendolo potete esporVi ad una esposizione laser rischiosa. L'uso di apparecchi ottici, equipaggiati con raggi laser, aumenta il rischio di danni alla vista.

APPENDIX E (CONTINUED)

European Standard

Warning

This is a class A product. In a domestic environment this product may cause radio interference in which case the user may be required to take adequate measures.

Funkstöreigenschaften nach EN 55022:1998

Warnung!

Dies ist eine Einrichtung der Klasse A. Diese Einrichtung kann im Wohnbereich Funkstörungen verursachen; in diesem fall kann vom Betreiber verlangt werden, angemessene Maßnahmen durchführen.

Standard Europeo

Attenzione

Questo e' un prodotto di classe A. Se usato in vicinanza di residenze private potrebbe causare interferenze radio che potrebbero richiedere all'utilizzatore opportune misure.

Attention

Ce produit est de classe "A". Dans un environnement domestique, ce produit peut être la cause d'interférences radio. Dans ce cas l'utiliseteur peut être amené à prendre les mesures adéquates.

APPENDIX F

Patents

For patent information, please refer to www.honeywellaidc.com/patents.

INDEX

A

AC input/outlet.....2, 3, 4, 5, 29
Accessories.....2
Approvals.....15, 32, 33
Assignments
 pin.....29
Audible.....9
Autodiscriminates.....23

B

Bar code1, 9, 11, 12, 15, 16, 17,
 18, 20, 21, 25
Bar width.....23
Beep.....9, 10, 11, 19, 20, 21, 26

C

Cable.....2, 22, 30
 communication.....29, 30
 detachable.....1, 6, 29, 30
 pin assignments.....29, 30
 powerlink.....3, 4, 5, 6, 30
Caution.....3, 4, 5, 7, 15, 32, 33
CDRH.....24
CE.....32
Communication.....3, 11, 22, 25
Compliance.....32, 33
Current.....9, 19, 24
Customer service.....2, 31

D

DC transformer.....24
Decode capability.....23
Default settings.....25, 26, 27, 28
Depth of field.....16, 17, 18, 23, 28
Design specifications.....23
Disclaimer.....31

E

Electrical.....24

F

Failure indicator(s).....9
Failure modes.....9, 10

G

Green LED.....11, 19

H

Host.....2, 3, 6, 11, 20, 22, 29

I

Indicators.....9, 10, 11, 23
 audible.....9
 LED.....7, 9, 10, 11, 19, 20
 Visual.....11
Input voltage.....24
Installation.....3, 7, 8
Interfaces.....1, 19, 20, 21, 23

K

Keyboard wedge.....1, 2, 29, 30

L

Labels.....15
Light levels.....24
Light Pen.....1, 23, 25, 26, 27, 28
Light source.....23
List.....2

M

Maintenance.....15

N

Notices.....32, 33

INDEX

O

Operating current 24
Operating temperature 24
Operation 9, 23, 32
Operational 23
Output window 7

P

Parts 2, 7
PC 4
Port 5, 22
Power supply 1, 2, 5, 29
Powerlink 2, 3, 4, 6
Programming guide 3, 9, 12
Programming modes 12, 13, 14

Q

Quick start 3

R

Razzberry tone 9, 10, 11, 26
Red LED 9, 11, 20
Repair 10
RMA 31
RS-232 22, 23, 25, 26, 27, 28

S

Scan lines 23
Scan pattern 23
Scan speed 23
Service 2, 10, 31
Specifications 23, 24
System interfaces 23

T

Termination 5, 23
Tones 9, 10, 23
Transformers 24
Troubleshooting 19, 20, 21, 22

V

Ventilation 24
Visual 11
Voltage 24

W

Warranty 19, 31
Weight 23
Window 7, 15



July 2004

Printed in the USA



0 0 - 0 2 4 2 1 B

Free Manuals Download Website

<http://myh66.com>

<http://usermanuals.us>

<http://www.somanuals.com>

<http://www.4manuals.cc>

<http://www.manual-lib.com>

<http://www.404manual.com>

<http://www.luxmanual.com>

<http://aubethermostatmanual.com>

Golf course search by state

<http://golfingnear.com>

Email search by domain

<http://emailbydomain.com>

Auto manuals search

<http://auto.somanuals.com>

TV manuals search

<http://tv.somanuals.com>