METROLOGIC[®] INSTRUMENTS, INC.

TECH 8[®] Laser Bar Code Projection Scanner

Installation and User's Guide

MLPN 2168
Printed in USA
October 1999 Rev 01

Locations

USA Corporate Headquarters

 Metrologic Instruments, Inc.
90 Coles Rd.
Blackwood, NJ 08012-4683

 Customer Service: 1-800-ID-METRO
Telephone: 856-228-8100

 Fax: 856-228-6673

 Email: info@metrologic.com
Internet: <http://www.metrologic.com>

South America

 Rua Flórida 1.821, 5° Andar- Brooklin
CEP 04571-090, São Paulo-SP, Brasil

Outside Brazil
Metrologic South America

 **Outside Brazil**
Telephone: 55-11-5505-6568

 Fax: 55-11-5505-1681

 Email: info@sa.metrologic.com

In Brazil
Metrologic do Brasil Ltda

 **In Brazil**
Telephone: 55-11-5505-2396

 Fax: 55-11-5507-2301

 Email: metrolog@br.metrologic.com

Europe

 Metrologic Instruments GmbH
Dornierstrasse 2
82178 Puchheim b.
Munich, Germany

 Telephone: 49-89-89019-0

 Fax: 49-89-89019-200

 Email: metrologic@europe.metrologic.com

Asia

 Metrologic Asia (PTE) Ltd.
31, Kaki Bukit Road 3
#05-08 Techlink
Singapore 417818

 Telephone: 65-842-7155

 Fax: 65-842-7166

 Email: ahsu@sg.metrologic.com

Copyright

© 1999 by Metrologic Instruments, Inc. All rights reserved. No part of this work may be reproduced, transmitted, or stored in any form or by any means without prior written consent, except by reviewer, who may quote brief passages in a review, or provided for in the Copyright Act of 1976.

Products and brand names mentioned in this document are trademarks of their respective companies.

Table of Contents

Unpacking List.....	1
Introduction	1
Labels.....	2
Applications and Protocols	2
Maintenance.....	3
Configuration of the Scanner to the Host System	3
Scanner Connections.....	4
Attaching the Scanner to the Stand and Work Surface	5
Scanning Bar Codes	6
Appendix A	
Specifications	7, 8
Appendix B	
Version A1 Pin Assignments for the Mil spec Connector.....	9
Version A15 Pin Assignments for the Mil spec Connector.....	10
Appendix C	
Warranty and Disclaimer	11
Appendix D	
Notices	12, 13
Appendix E	
Patents	14
Index.....	15, 16

Unpacking List

The shipping carton, will contain the following:

- TECH 8[®] Laser Bar Code Projection Scanner
- Installation and User's Guide
- ScanSelect™ Scanner Programming Guide
- Communication Cable (optional) or Communication Cable with Power Supply (optional)
- Stand (optional)

If any item is missing or to order additional items, contact the dealer, distributor or call Metrologic's Customer Service Department at 1-800-ID-METRO or 1-800-436-3876.

Introduction

Metrologic's TECH 8[®] laser bar code projection scanner is encased in an NEMA-12 steel case. The scanner's construction enables the scanner to operate in harsh surroundings, especially industrial environments. Water-resistant, shock-resistant, and rugged, the TECH 8 scanner is also fast, aggressive and reliable. It can register bar codes at a range of 203mm - 457mm (8" - 18") and can autodiscriminate among all common codes.

Among the scanner's many features is an ASIC (Application Specific Integrated Circuit) in the decoding system that virtually eliminates misreads and MECCA[®] (Metrologic Enhanced Code Correcting Algorithm). MECCA[®] enables the scanner to read poorly printed, wrinkled or even torn bar codes on the first pass.

The scanner has been configured at the time of manufacture based on information supplied at the time of order.

Labels

The first label is found inside the window of the scanner noting that this device is a CDRH Class Ila laser product and EN 60825-1 LASERKLASSE 1. The second label is located on back of the scanner. This label contains information such as the model number, the date of manufacture and the serial number. The following are samples of the labels that are found on the unit.

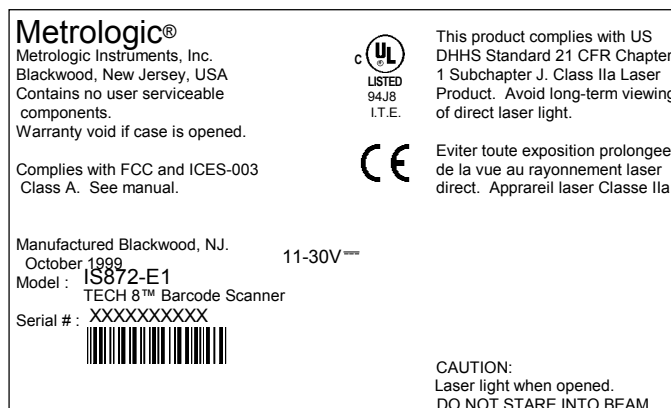
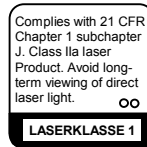

Applications and Protocols

The following chart lists the version identifiers for all the communication protocols. Listed on each scanner is a model number. The model number includes the scanner number, revision label, and denoted version identifier. For example, if the model number is MS870-B1, the scanner is an MS870, B is the revision level, and 1 is the version identifier.

B UNITS		
Scanner	Version Identifier	Communication Protocol(s)
MS870	1	RS-232, OCIA
MS870	15	Light Pen Emulation

Maintenance

Smudges or dirt that appears on the scanner window can interfere with proper scanning. Therefore, the window will need occasional cleaning.

1. Spray glass cleaner onto lint free, non-abrasive cleaning cloth.
2. Gently wipe the scanner window.

Configuration of the Scanner to the Host System

The scanner has been configured at the time of manufacture based on information supplied at the time of order. If ScanSet[®] is being used, refer to the ScanSet documentation for information on how to configure your scanner.

Scanner Connections

In order for the scanner to maintain compliance with applicable standards, all circuits connected to the scanner must meet the requirements for SELV (Safety Extra Low Voltage) according to EN 60950.



To avoid potential problems, **do not power up the scanner until the communication cable is secured to the host.**

1. Turn off the host system.
2. Find the 19-pin female end of the scanner link cable and the widest key located above pins L and A. Align this key with the corresponding key on the scanner box's Mil spec connector. While pushing in on the connector, rotate the ring clockwise until it locks into place with a click.
3. Connect the other end of the communication cable to the host device.

The following statement is applicable if the optional power adapter available through Metrologic does not power the bar code scanner, and the scanner receives power from a host device such as a computer system.

Caution: To maintain compliance with standards CSA C22.2 No. 950/UL 1950 and norm EN 60950, the power source must meet applicable performance requirements for a limited power source.



If the scanner will not receive power from a transformer, skip to Step 6.

4. If the scanner will receive power from an external power source, check the AC input requirements of the transformer to make sure the voltage matches the AC outlet. (A socket-outlet should be installed near the equipment and must be easily accessible.)
5. Plug the transformer into the AC outlet to supply power to the scanner.
6. Power up the host system.
7. Scan a few items to verify that data is being properly transmitted between the scanner and the host device.

Attaching the Scanner to the Stand and Work Surface

The scanner can be positioned in a vertical orientation with the Metrologic stand (Part #45478). To attach the unit to the stand and work surface purchase the following: four 6-32 x 1/2" (maximum length) machine screws and two (2) #10 pan head or two (2) #8 countersunk wood screws. (Refer to figure 1)

1. Lay the scanner face down on a clean cloth to prevent any scratches from occurring on the output window. Position the scanner so the red and green LEDs are pointed toward you.
2. Lay the stand on the scanner with the angled bracket pointing up and toward you.
3. Align the four clearance holes to the four holes in the scanner's case. Fasten the scanner to the stand by inserting the four 6-32 x 1/2" screws into the four holes in the scanner's case.
4. Drill two holes into the work surface that correspond with the holes in the 216mm - 96mm (8.5" x 3.80") base of the stand.
5. Use two pan head or countersunk wood screws to attach the scanner and stand to the work surface.

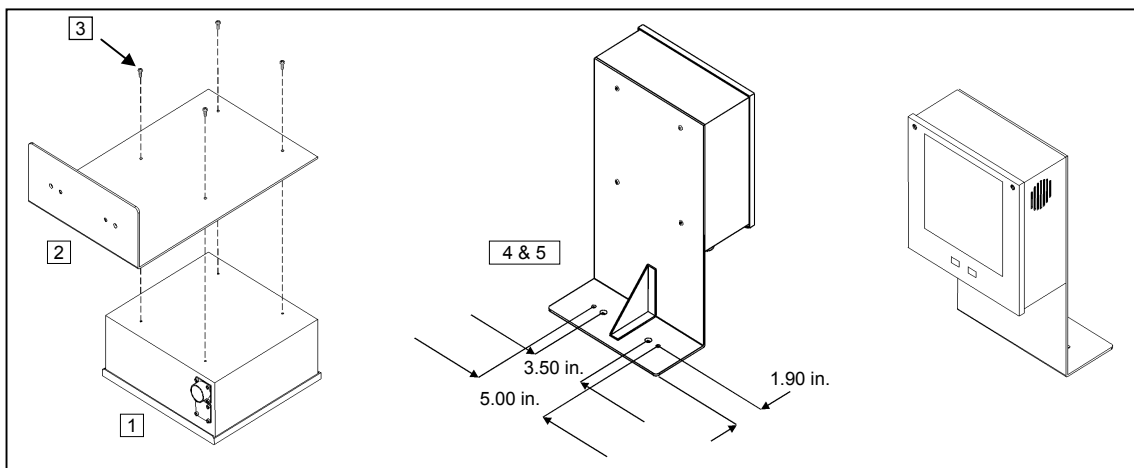

Figure 1: Stand Installation

Scanning Bar Codes

The depth of field for the scanner is 203mm to 457mm (8" to 18") from the scanner window. The symbol must be passed through the scan area in order for the scanner to recognize the bar code. (Refer to Figure 2)

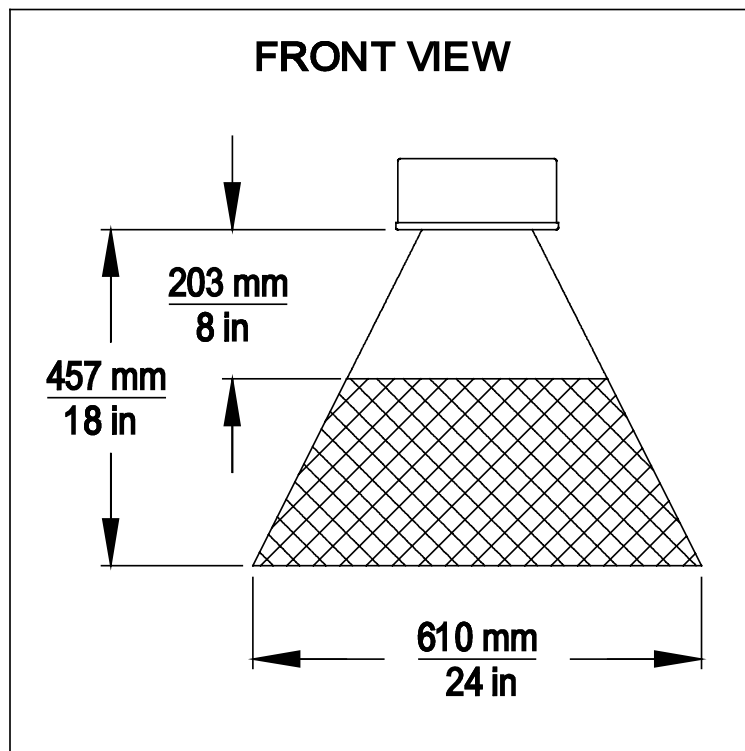

Figure 2

Appendix A

TECH 8[®] Laser Bar Code Scanner Specifications	
Application	Industrial Scanner
Light Source	Visible Laser Diode 670 ± 5nm
Laser Class	CDRH: Class IIa; EN 60825: Class 1
EMC	CE, UL listed for US and Canada
EMI	FCC, ICES-003 & EN 55022 Class A
Mechanical	
Dimensions	203mm x 216mm x 96mm (8"L x 8.5"W x 3.8"D)
Weight	3.5kg. (7.75 lbs.) without cable
Orientation	May be used in any orientation
Mounting	Vertical stand
Top Cover	NEMA-12 steel case
Cable Length	1.83m (6') cable with mil spec connector
Electrical	
Power	9 watts, host system or wall transformer
Input Voltage	11-30 VDC
Operating Current	450mA typical @ 20V
Standby Current	210mA typical @ 20V
DC Transformers	6061/6113-220V (AC in) 6062/6114-120V (AC in) 6115-240V (AC in) output 24/20VDC @ 750mA

Specifications subject to change without notice.

Appendix A (Continued)

Operational	
Depth of Scan Field	203mm to 457mm (8" to 18")
Scan Speed	Model 870 1250 scan lines per second Model 875: 450 scan lines per second
Scan Pattern	Model 870: Omnidirectional (20 interlocking lines) Model 875: 6-line raster
Indicators	LED: green=on ready to scan; red=good read
Beeper Operation	Selection of 3 tones for "Good Read"
Maintenance Required	Clean window periodically
Decode Capability	Autodiscriminates
System Interfaces	RS-232C; Light Pen Emulation; OCIA
Optional Interfaces	Opto coupled 6 amp US and Canada, 5 amps EEA countries TRIAC output; object sensor input
Print Contrast	35% minimum reflectance difference
Roll, Pitch, Yaw	360°, 60°, 60°
Environmental	
Storage Temperature	-40°C to 60°C (-40°F to 140°F)
Operating Temperature	0°C to 35°C (32°F to 95°F)
Humidity	5% to 95% relative humidity, non-condensing
Light Levels	Up to 3200 foot candles - works in direct sun
Ventilation	None required
Shock	100g for 1ms
ESD	8kV IEC 801-2
Contaminants	Protects against dust, falling dirt, and dripping non-corrosive liquid

Specifications subject to change without notice.

Appendix B

Version A1 Pin Assignments for the Mil spec Connector

Each TECH 8 scanner has a 19-pin male Mil spec connector that is found on the side of the unit. To connect the scanner to the host device, use a communication cable with a female Mil spec connector. The communication cable may include a power transformer or it may be designed to draw power directly from the host device. This item can be ordered when the scanner is purchased.

The following is a list of pin assignments for Version A1 scanners. The communication protocols for Version A1 are RS-232 and OCIA. The pin numbers are impressed on the male Mil spec connector. For easier reference, refer to Figure 3 for pin locations.

PIN	FUNCTION
A	R Data
B	RTS Output
C	Signal Ground
D	CTS Input
E	R Data Return
F	RS-232 Output
G	Clock In
H	Clock In Return
J	Clock Out
K	Shield Ground
L	DTR Input
M	Clock Out Return
N	Power to Scanner + 24 VDC
P	Earth Ground
R	Power Ground
S	RS-232 Input

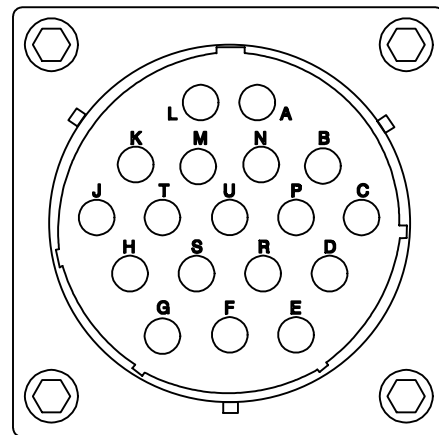

Figure 3

Appendix B (Continued)

Version A15 Pin Assignments for the Mil spec Connector

Each TECH 8 scanner has a 19-pin male Mil spec connector that is found on the side of the unit. To connect the scanner to the host device, use a communication cable with a female Mil spec connector. The communication cable may include a power transformer or it may be designed to draw power directly from the host device. This item can be ordered when the scanner is purchased.

The following is a list of pin assignments for Version A15 scanners. The communication protocol for Version A15 is light pen emulation. The pin numbers are impressed on the male Mil spec connector. For easier reference, refer to Figure 4 for pin locations.

PIN	FUNCTION
A	R Data
B	Light Pen Data Output
C	Signal Ground
D	Light Pen Source + 5 VDC
E	R Data Return
F	RS-232 Output
G	Clock In
H	Clock In Return
J	Clock Out
K	Shield Ground
L	DTR Input
M	Clock Out Return
N	Power to Scanner + 24 VDC
P	Earth Ground
R	Power Ground
S	RS-232 Input

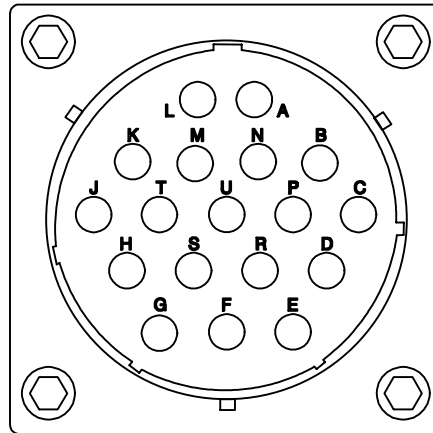

Figure 4

Appendix C

Warranty and Disclaimer

Limited Warranty

The Tech 8[®] Series of scanners are manufactured by Metrologic at its Blackwood, New Jersey, U.S.A. facility. The Tech 8 Series scanners have a two (2) year limited warranty from the date of manufacture. Metrologic warrants and represents that all Tech 8 Series scanners are free of all defects in material, workmanship and design, and have been produced and labeled in compliance with all applicable U.S. Federal, state and local laws, regulations and ordinances pertaining to their production and labeling.

This warranty is limited to repair, replacement of Product or refund of Product price at the sole discretion of Metrologic. Faulty equipment must be returned to the Metrologic facility in Blackwood, New Jersey, U.S.A. or Puchheim, Germany. To do this, contact a Metrologic's Customer Service/Repair Department to obtain a Returned Material Authorization (RMA) number.

In the event that it is determined the equipment failure is covered under this warranty, Metrologic shall, at its sole option, repair the Product or replace the Product with a functionally equivalent unit and return such repaired or replaced Product without charge for service or return freight, whether distributor, dealer/reseller, or retail consumer, or refund an amount equal to the original purchase price.

This limited warranty does not extend to any Product which, in the sole judgement of Metrologic, has been subjected to abuse, misuse, neglect, improper installation, or accident, nor any damage due to use or misuse produced from integration of the Product into any mechanical, electrical or computer system. The warranty is void if the case of Product is opened by anyone other than Metrologic's repair department or authorized repair centers.

THIS LIMITED WARRANTY, EXCEPT AS TO TITLE, IS IN LIEU OF ALL OTHER WARRANTIES OR GUARANTEES, EITHER EXPRESS OR IMPLIED, AND SPECIFICALLY EXCLUDES, WITHOUT LIMITATION, WARRANTIES OF MERCHANTABILITY AND FITNESS FOR A PARTICULAR PURPOSE UNDER THE UNIFORM COMMERCIAL CODE, OR ARISING OUT OF CUSTOM OR CONDUCT. THE RIGHTS AND REMEDIES PROVIDED HEREIN ARE EXCLUSIVE AND IN LIEU OF ANY OTHER RIGHTS OR REMEDIES. IN NO EVENT SHALL METROLOGIC BE LIABLE FOR ANY INDIRECT OR CONSEQUENTIAL DAMAGES, INCIDENTAL DAMAGES, DAMAGES TO PERSON OR PROPERTY, OR EFFECT ON BUSINESS OR PROPERTY, OR OTHER DAMAGES OR EXPENSES DUE DIRECTLY OR INDIRECTLY TO THE PRODUCT, EXCEPT AS STATED IN THIS WARRANTY. IN NO EVENT SHALL ANY LIABILITY OF METROLOGIC EXCEED THE ACTUAL AMOUNT PAID TO METROLOGIC FOR THE PRODUCT.

METROLOGIC ALSO RESERVES THE RIGHT TO MAKE ANY CHANGES TO THE PRODUCT DESCRIBED HEREIN.

Metrologic Instruments, Inc.
90 Coles Road
Blackwood, NJ 08012-4683
Customer Service Department
1-800-ID-METRO (1-800-436-3876)
TEL: 856-228-8100
FAX: 856-228-6673

Metrologic Instruments GmbH
Dornierstrasse 2
82178 Puchheim b
Munich, Germany
TEL: 49-89-89019-0
FAX: 49-89-89019-200

Appendix D

Notices

Notice

This equipment has been tested and found to comply with limits for a Class A digital device, pursuant to Part 15 of the FCC Rules. These limits are designed to provide reasonable protection against harmful interference when the equipment is operated in a commercial environment. This equipment generates, uses and can radiate radio frequency energy and, if not installed and used in accordance with the instruction manual, may cause harmful interference to radio communications. Operation of this equipment in a residential area is likely to cause harmful interference, in which case the user will be required to correct the interference at his own expense. Any unauthorized changes or modifications to this equipment could void the users authority to operate this device.

This device complies with Part 15 of the FCC Rules. Operation is subject to the following two conditions: (1) This device may not cause harmful interference, and (2) this device must accept any interference received, including interference that may cause undesired operation.

Notice

This Class A digital apparatus complies with Canadian ICES-003.

Remarque

Cet appareil numérique de la classe A est conforme à la norme NMB-003 du Canada.

Caution

Use of controls or adjustments or performance of procedures other than those specified herein may result in hazardous laser light exposure. Under no circumstances should the customer attempt to service the laser scanner. Never attempt to look at the laser beam, even if the scanner appears to be nonfunctional. Never open the scanner in an attempt to look into the device. Doing so could result in hazardous laser light exposure. The use of optical instruments with the laser equipment will increase eye hazard.

Atención

La modificación de los procedimientos, o la utilización de controles o ajustes distintos de los especificados aquí, pueden provocar una luz de láser peligrosa. Bajo ninguna circunstancia el usuario deberá realizar el mantenimiento del láser del escáner. Ni intentar mirar al haz del láser incluso cuando este no esté operativo. Tampoco deberá abrir el escáner para examinar el aparato. El hacerlo puede conllevar una exposición peligrosa a la luz de láser. El uso de instrumentos ópticos con el equipo láser puede incrementar el riesgo para la vista.

Attention

L'emploi de commandes, réglages ou procédés autres que ceux décrits ici peut entraîner de graves irradiations. Le client ne doit en aucun cas essayer d'entretenir lui-même le scanner ou le laser. Ne regardez jamais directement le rayon laser, même si vous croyez que le scanner est inactif. N'ouvrez jamais le scanner pour regarder dans l'appareil. Ce faisant, vous vous exposez à une rayonnement laser qu'est dangereux. L'emploi d'appareils optiques avec cet équipement laser augmente le risque d'endommagement de la vision.

Achtung

Die Verwendung anderer als der hier beschriebenen Steuerungen, Einstellungen oder Verfahren kann eine gefährliche Laserstrahlung hervorrufen. Der Kunde sollte unter keinen Umständen versuchen, den Laser-Scanner selbst zu warten. Sehen Sie niemals in den Laserstrahl, selbst wenn Sie glauben, daß der Scanner nicht aktiv ist. Öffnen Sie niemals den Scanner, um in das Gerät hineinzusehen. Wenn Sie dies tun, können Sie sich einer gefährlichen Laserstrahlung aussetzen. Der Einsatz optischer Geräte mit dieser Laserausrüstung erhöht das Risiko einer Sehschädigung.

Attenzione

L'utilizzo di sistemi di controllo, di regolazioni o di procedimenti diversi da quelli descritti nel presente Manuale può provocare delle esposizioni a raggi laser rischiose. Il cliente non deve assolutamente tentare di riparare egli stesso lo scanner laser. Non guardate mai il raggio laser, anche se credete che lo scanner non sia attivo. Non aprite mai lo scanner per guardare dentro l'apparecchio. Facendolo potete esporvi ad una esposizione laser rischiosa. L'uso di apparecchi ottici, equipaggiati con raggi laser, aumenta il rischio di danni alla vista.

Appendix D (Continued)

European Standard

Warning

This is a class A product. In a domestic environment this product may cause radio interference in which case the user may be required to take adequate measures.

Funkstöreigenschaften nach EN 55022:1998

Warnung!

Dies ist eine Einrichtung der Klasse A. Diese Einrichtung kann im Wohnbereich Funkstörungen verursachen; in diesem fall kann vom Betreiber verlangt werden, angemessene Maßnahmen durchführen.

Standard Europeo

Attenzione

Questo e' un prodotto di classe A. Se usato in vicinanza di residenze private potrebbe causare interferenze radio che potrebbero richiedere all'utilizzatore opportune misure.

Attention

Ce produit est de classe "A". Dans un environnement domestique, ce produit peut être la cause d'interférences radio. Dans ce cas l'utiliseteur peut être amené à predre les mesures adéquates.

Appendix E

Patents

For patent information, please refer to www.honeywellaidc.com/patents.

Index

A			
AC outlet	4		
Application	7		
Application and protocols	2		
Asia	ii		
ASIC	1		
Attaching stand	5		
A1 pin assignments	9		
A15 pin assignments	10		
B			
B units	2		
Bar codes	6		
Base	5		
Beeper operation	8		
Bracket	5		
C			
Case	1, 5, 7		
CDRH class IIa	2, 7		
CDRH/IEC	7		
CE Mark	7		
Class 1	7		
Clean	3, 8		
Communication cable	1,4, 9, 10		
Communication protocol	2		
Compliance	4		
Configuration	3		
Connectors	4, 7, 9, 10		
Connections	4		
Construction	1		
Containments	8		
Contrast	8		
Copyright	ii		
Current	7		
Customer Service	ii, 11		
D			
DC transformer	7		
Decode capability	8		
Depth of field	6, 8		
Dimensions	7		
Disclaimer	11		
E			
Electrical	7		
Email	ii		
EN 60825-1	2, 4		
Environmental	8		
ESD	8		
EU	7		
Europe	ii		
Exit angle	8		
F			
Faulty equipment	11		
Fax	ii		
Functions	9, 10		
G			
Germany (GmbH)	11		
Good read	8		
Guides	1		
H			
Headquarters	ii		
Host	3, 4, 9, 10		
Humidity	8		
I			
Input voltage	7		
Internet	ii		
Introduction	1		
K			
Key	4		
L			
Labels	2		
LASERKLASSE 1	2		
LEDs	5		
Light levels	8		
Light pen emulation	2, 8		
Light source	7		
Limited warranty	11		
Link cable	4		
Locations	ii		
M			
Maintenance	3, 8		
MECCA	1		
Mechanical	7		
Mil spec connector	4, 7, 9, 10		
Model number	2		
Mounting options	7		

Index

N			
NEMA-12 steel case	1, 7	Shipping carton	1
Notices	12, 13	Socket-outlet	4
O		South America	ii
OCIA	2, 9	Specifications	7, 8
Operating current	7	Stand	1, 5, 7
Operating temperature	8	Storage temperature	8
Operational	8	System interfaces	8
Optional interfaces	8	T	
Orientation	7	Temperature	8
P		Top cover	7
Patents	15	Transformer	4, 7, 9, 10
Pin assignments	9, 10	U	
Power consumption	7	UL/CSA	7
Print contrast	8	Units	2
Programming guide	1	USA corporate headquarters	ii
Protocols	2	V	
R		Ventilation	8
RMA	11	Version A1	9
Roll, pitch, yaw	8	Version A15	10
RS-232	2, 8, 9	Version identifiers	2
S		Vertical stand	1, 5, 7
Scan field	6, 8	Visible laser diode	7
Scanning bar codes	6	Voltage	4, 7
Scan pattern	8	W	
Scanner connections	4	Warranty	11
ScanSet	3	Weight	7
ScanSelect manual	1	Window	2, 3, 5, 6, 8
Scan speed	8		
Service	1, 11		

Free Manuals Download Website

<http://myh66.com>

<http://usermanuals.us>

<http://www.somanuals.com>

<http://www.4manuals.cc>

<http://www.manual-lib.com>

<http://www.404manual.com>

<http://www.luxmanual.com>

<http://aubethermostatmanual.com>

Golf course search by state

<http://golfingnear.com>

Email search by domain

<http://emailbydomain.com>

Auto manuals search

<http://auto.somanuals.com>

TV manuals search

<http://tv.somanuals.com>