METROLOGIC INSTRUMENTS, INC.

MS6720 Hand-Held Laser Scanner

Installation and User's Guide

**MLPN 2368
Printed in USA
October 1998**

Locations:

USA Corporate Headquarters

Metrologic Instruments, Inc.
90 Coles Road
Blackwood, NJ 08012
Customer Service: 1-800-ID-METRO
Tel: 609-228-8100
Fax: 609-228-6673
info@metrologic.com
www.metrologic.com

Europe

Metrologic Instruments GmbH
Dornierstrasse 2
82178 Puchheim b.
Munich, Germany
Tel: 49-89-89018-0
Fax: 49-89-89019-200
metrologic@europe.metrologic.com

South America

Metrologic Instruments
Rua Flórida, 1.821-5° Andar-Brooklin
CEP 04571-090, São Paulo-SP, Brasil
Outside Brazil:
Tel: 55-11-5505-6568
Fax: 55-11-5505-1681
info@sa.metrologic.com
In Brazil:
Tel: 55-11-5505-2396
Fax: 55-11-5507-2301
metrolog@br.metrologic.com

ASIA

Metrologic Asia (PTE) Ltd.
31, Kaki Bukit Road 3
#05-08 Techlink
Singapore 417818
Tel: 65-842-7155
Fax: 65-842-7166
ant888@cyberway.com.sg

Copyright

© 1998 by Metrologic® Instruments, Inc. All rights reserved. No part of this work may be reproduced, transmitted, or stored in any form or by any means without prior written consent, except by reviewer, who may quote brief passages in a review, or provided for in the Copyright Act of 1976.

Products and brand names mentioned in this document are trademarks of their respective companies.

Scope of this Manual

This manual contains all information about the basic operation and usage for the MS6720.

Material in this document is presented in a user-friendly manner and should be easily understood. However, it is helpful if the reader is familiar with the general use and operation of a scanner.

Table of Contents

Introduction	1
Scanner and Accessories	2
Quick Start	3
Operational Test	4
Scanner Installation: Powered by External Power Supply	5
Scanner Installation: Powered by the Host Device	6
Scanner Installation: to the PC for the Scanner with Built-In PC Keyboard Wedge Interface	7
The MS6720 Stand	8
Scanner Parts	9
Audible Indicators	10
Failure Modes	11
Visual Indicators	12
Label	13
Depth of Field Specifications	14
Normal Depth of Field	14
Short Depth of Field	15
Extended Depth of Field	16
Optional Depth of Field	17
Automatic Turn-On Specifications	18
Normal Depth of Field	18
Short Depth of Field	18
Scan Pattern Specifics	19
Projection Axis	19
Omnidirectional Scan Volume	19
Cross-Sectional Scan Pattern	20
Maintenance	21
Troubleshooting Guide	22 - 26
Application and Protocols	27

Appendix A	
Design Specifications	28, 29
Appendix B	
Default Settings	30 - 33
Appendix C	
Pin Assignments	34 - 36
Appendix D	
Warranty and Disclaimer	37, 38
Appendix E	
Notices	39, 40
Appendix F	
Patents	41
Index	42 - 44

Introduction

The MS6720 is the first laser bar code scanner truly to bridge the gap between omnidirectional fixed projection and hand-held scanners. It incorporates fixed projection performance and our patented 20-line scan pattern into a comfortable, ergonomic styling of our popular hand-helds. With this design, Metrologic has engineered a scanner that transcends any other on the market today.

The MS6720 utilizes a unique, patented infrared sensor and control scheme for hands-free projection scanning and fatigue reduced hand-held operation. Whether operators choose to present small items to the scanner or transport the lightweight scanner to bulkier items, the compact size and comprehensive scan pattern make the MS6720 the perfect choice for many applications.

The superior performance and features the world has come to expect from Metrologic were packaged into the comfortable case only after tests and approvals by hands of all sizes. With 84 degrees rotation and 10 locking positions through 45 degrees of tilt, the stand for the MS6720 is also ergonomically and application friendly. Mounting was designed to provide an adequate distance for scanning between the scanner face and the counter top at all times. When fully tilted, the face of the unit remains a full five inches from the counter. In addition, the modular construction thoughtfully includes a removable wall mount cap.

As with all Metrologic hand-held scanners, the MS6720 features both short-range and long-range activation, user-friendly programming, reliability and versatility. Operators are sure to appreciate the convenience and flexibility of the MS6720, offered at an unbeatable price.

Scanner and Accessories

The following is a list of the parts included in the MS6720 kit.

- ! MS6720 Hand-Held Laser Scanner - Refer to page 27 for available communication protocols

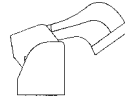

- ! Stand (MLPN 45967) - Refer to page 8 for available kits

- ! Optional Power Transformer 120V or 220V or 240V (AC in) 5V (DC out) @300mA regulated (MLPN 46010/46009/46008) for applications where host power is not available

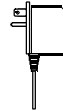

- ! Installation and User's Guide (MLPN2368)



- ! ScanSelect™ Scanner Programming Guide (MLPN 2186)



RS-232, Light Pen, some OCIA and some 46xx scanners:

- ! MCA (Metrologic Connector Adaptor) (MLPN MCA951)



- ! For direct connect application (No Power Transformer) 4 position MCA ground jumper (MLPN 51191)



Keyboard Wedge Scanners:

- ! Adaptor Cable with a 5-pin DIN male connector on one end and a 6-pin mini DIN female connector on the other (MLPN 19716)



- ! For direct connect application (No Power Transformer) 4 position direct power jumper (MLPN 52332) for host powered applications



Other items may be ordered for the specific protocol being used. To order additional items, contact the dealer, distributor or call Metrologic's Customer Service Department at 1-800-ID-METRO or 1-800-436-3876.

Quick Start

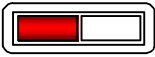

- 1.) Plug in the scanner. Both LEDs come on together along with the beep-the green LED only flashes.

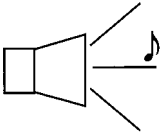

- 2.) The scanner is shipped from the factory programmed with default settings. To configure the MS6720 scanner to meet the host system's specific needs, refer to the Programming Guide (MLPN 2186) for instructions on how to enter the program mode and to select the appropriate bar codes.

Note: Any time the Load Defaults bar code is scanned the MS6720 is configured for an RS-232 interface. If a RS-232 is not being used, scan at least one other bar code to enable Keyboard Wedge, OCIA, Light Pen or 46xx. Refer to sections B and F in the ScanSelect Programming Guide (MLPN 2186).

Operational Test

If the scanner is to receive power from an external power supply, test the scanner before it is connected to the host system.

Keyboard Wedge Scanners:

1. Plug one end of the coil cable into the keyboard connector on the PC. Then plug the keyboard connector into the other end of the coil cable. Plug in the external transformer.
2. Check the AC input requirements of the power supply to make sure the voltage matches the AC outlet. Connect AC power to the transformer.
3. Both LEDs come on together along with the beep-the green LED only flashes.

RS-232, Light Pen, OCIA and 46xx scanners:

1. Plug the scanner's coil cable into the MCA (Metrologic Connector Adaptor).
2. Check the AC input requirements of the power supply to make sure the voltage matches the AC outlet. Plug the power supply into the MCA and the appropriate AC outlet. (the socket-outlet shall be installed near the equipment and shall be easily accessible.)
3. Both LEDs come on together along with the beep-the green LED only flashes.

Note: Two methods that the scanner can be powered are as follows:
External Power Supply or Host Device ie the PC for the MS6720 with a Built-in PC Keyboard Wedge interface.

Scanner Installation: Powered by External Power Supply

To maintain compliance with applicable standards, all circuits connected to the scanner must meet the requirements for SELV (Safety Extra Low Voltage) according to EN 60950.

1. Turn off the host system.
2. If using a communication cable, connect the cable to the correct port on the host device and the MCA (Metrologic Connector Adaptor). If the host device is an IBM compatible PC with a male 9-pin serial port, connect the MCA to the port.
3. Plug the scanner's coil cable into the MCA.
4. Check the AC input requirements of the power supply to make sure the voltage matches the AC outlet. (the socket-outlet shall be installed near the equipment and shall be easily accessible.) Plug the power supply into the MCA and the AC outlet.
5. Turn on the host system.

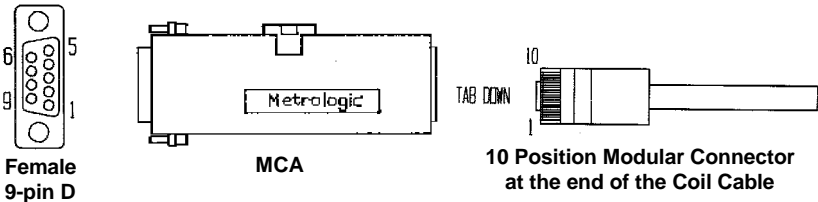

- Note:**
- a. When the scanner first receives power, both LEDs come on together along with the beep-the green LED only flashes.
 - b. Plugging the scanner into the serial port of the PC does not guarantee that scanned information will appear at the PC. A software driver and correct configuration setting are also required for proper communication to occur.

Scanner Installation: Powered by Host Device

If the host system supplies +5VDC power to the scanner, reposition the internal jumper within the MCA (Metrologic Connector Adaptor) before connecting the scanner to the host device. In addition, plug the 4 position ground jumper into the power supply connector located on the side of the MCA.

1. Make sure the MCA is not connected to the scanner, communication cable or host and unfasten the case.

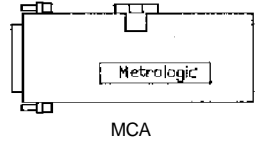

2. Reposition the shunt on JP1 to pins 1 and 2 and close the case.

Note: The factory setting of jumper 1 (JP1) is on pins 2 and 3. To direct power for the scanner from the host device, position the jumper on pins 1 and 2.

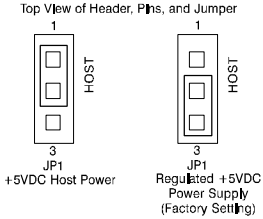

3. Plug the 4 position ground jumper into the power supply connector.

4. Turn off the host system.

5. If using a communication cable, connect the cable to the correct port on the host device and the MCA. If the host device is an IBM compatible with a male 9-pin serial port, connect the MCA to the port. There is an optional cable (MLPN 51236) that is available for IBM PC applications where the MCA will not fit at the back of the computer.

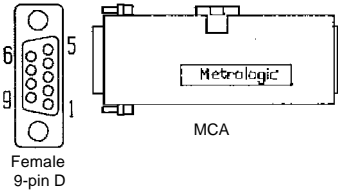

6. Plug the scanner's coil cable into the MCA.

7. Turn on the host system.

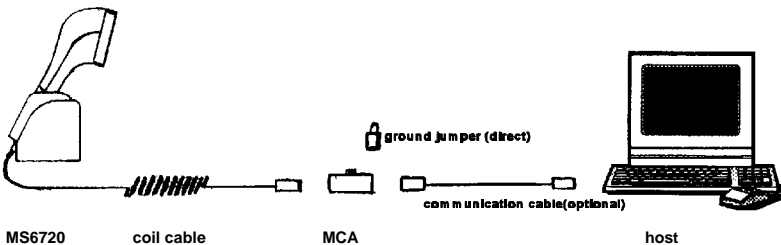

Scanner Installation to the PC for the Scanner with Built-in PC Keyboard Wedge Interface

To maintain compliance with applicable standards, all circuits connected to the scanner must meet the requirements for SELV (Safety Extra Low Voltage) according to EN 60950.

1. The “Y” coil cable is terminated with a 5-pin DIN female connector on one end, and a 6-pin mini DIN male on the other. Also included with the MS6720 is an adaptor cable with a 5-pin male DIN on one end and a 6-pin female mini DIN on the other to mate to a specific keyboard. According to the termination required, connect the appropriate end of the adaptor cable to the coil cable, leaving the necessary termination exposed for connecting to the keyboard and the keyboard port on the PC. Refer to Appendix C page 36 for pin assignments.
2. If the PC is on, exit the application and turn the PC off.
3. Disconnect the keyboard from the PC.
4. Plug one end of the coil cable into the keyboard connector on the PC. Then plug the keyboard connector into the other end of the coil cable. Plug in the external transformer. Refer to Manufacturer’s Recommendation below. Connect AC power to the transformer.
5. Power up the PC.

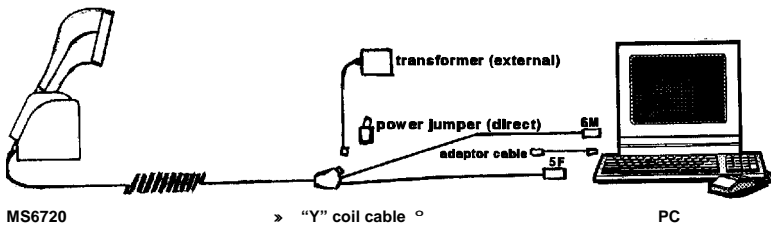

Manufacturer’s Recommendation:

Metrologic recommends the use of an external power supply with MS6720-47 Keyboard Wedge applications. Powering the MS6720-47 directly from the computer keyboard connector could interfere with the operation of the scanner or the computer. Not all computers supply the same current through the keyboard port, this explains why a scanner would work on one computer and not another.

The MS6720 Stand

The stand for the MS6720 is ergonomic and application friendly. The mounting was designed to provide an adequate distance for scanning between the scanner face and the counter top at all times. When fully tilted, the face of the scanner remains a full five inches from the counter. The stand comes preassembled so it can be attached to the work surface with minimum effort (also included is the wall mount clip). The instructions for use of the wall mount clip are included with the general assembly instructions for the stand. Listed below are the component parts of the MS6720 stand kits.

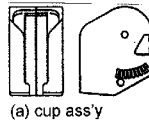
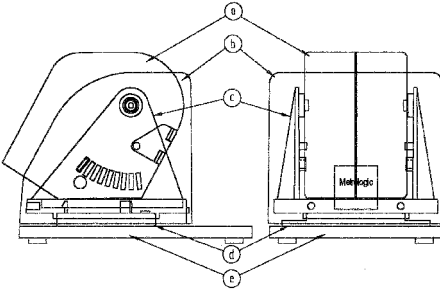

(a) cup ass'y

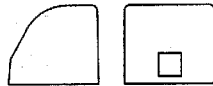

(b) shroud

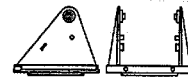

(c) tilt/swivel frame



(d) rotating base

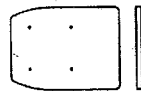

(e) weighted platform base

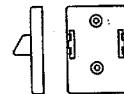

(f) wall clip (45978)

1) Complete Stand Kit:

MLPN 45967

Kit includes:

- MLPN 45965 (counter top stand)
- MLPN 45969 (weighted base)
- MLPN 45978 (wall clip)
- 10-32 x 3/8" flat head screws
- #10 x 1" flat head wood screws

2) Counter top Stand Kit:

(for securing directly to a counter top ONLY)

MLPN 45965

Kit includes:

- each: parts a, b, c, d as shown
- #10 x 1" flat head wood screws

3) Wall Mount Kit:

(for directly to a wall ONLY)

MLPN 45966

Kit includes:

- part (a) as shown
- 45978 (wall clip)
- #10 x 1" flat head wood screws

Scanner Parts

Green and Red LED

When the red LED is on, this indicates that the laser is on. When the green LED flashes on, the scanner has read a bar code successfully. When the green light turns off, communication to the host is complete. The green LED blinks while the scanner is waking up from an IR sensor timeout. The LED's are also used as diagnostic indicators and mode indicators. Refer to pages 10-12 for details.

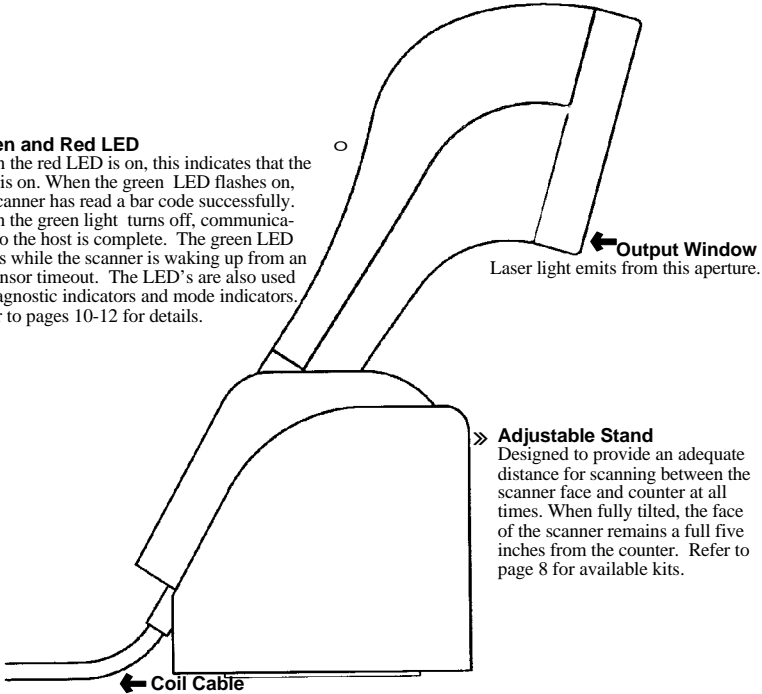

← **Output Window**
Laser light emits from this aperture.

» **Adjustable Stand**
Designed to provide an adequate distance for scanning between the scanner face and counter at all times. When fully tilted, the face of the scanner remains a full five inches from the counter. Refer to page 8 for available kits.

← **Coil Cable**

This cable is terminated with a 10-pin modular connector, which attaches to the MCA951. The Keyboard Wedge unit has a "Y" coil cable terminated with a 5-pin female on one end, a 6-pin male and a 4-pin locking connector for power input (power jumper). An adaptor is included with a 5-pin male DIN on one end and a 6-pin female mini DIN on the other to mate to a specific keyboard. Refer to Appendix C page 36 for pin assignments.

Audible Indicators

When the MS6720 scanner is in operation, it provides audible feedback. These sounds indicate the status of the scan and scanner. Four settings are available for the tone of the beep. To change the tone, refer to the Programming Guide section: Beeper Tones.

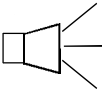

One Beep

*

When the scanner *first* receives power, both LEDs come on together along with the beep-the green LED only flashes. After the scanner performs this startup sequence, the scanner is ready to scan.

When the scanner *successfully* reads a bar code, the green light will flash and beep once (if programmed to do so). If the scanner does not beep once and the green light does not flash, then the bar code has *not* been successfully read.



Razzberry Tone

This tone is a failure indicator. Refer to failure modes page 11.

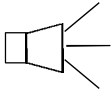

Three Beeps - after power up

* * *

When entering the program mode, the green LED will flash while the scanner simultaneously beeps three times. The green LED will continue to flash until the unit exits program mode. Upon exiting program mode, the scanner will beep three times and the green LED will stop flashing. When configured, 3 beeps can also indicate a communications timeout during normal scanning mode.

Failure Modes

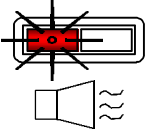

Flashing Red and One Razzberry Tone

This indicates the scanner has experienced a laser subsystem failure. Return the unit for repair at an authorized service center.

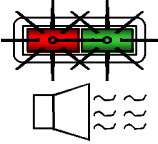

Flashing Red and Green and Two Razzberry Tones

This indicates the scanner has experienced a motor failure. Return the unit for repair at an authorized service center.

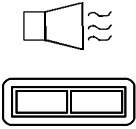

Continuous Razzberry Tone with both LEDs off

If, upon power up, the scanner emits a continuous razzberry tone, then the scanner has an electronic failure. Return the unit for repair at an authorized service center.

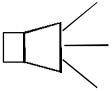

Three Beeps - on power up

* * *

If the scanner beeps 3 times on power up then, the non volatile memory which holds the scanner configuration has failed. Return the unit for repair at an authorized service center.

Visual Indicators

There are a red LED and a green LED on the scanner. When the scanner is on, the flashing or stationary activity of the LEDs indicates the status of the scan and scan-ner.

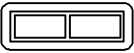

No Red or Green LED

There are two reasons why the LEDs will not be illuminated:

- 1.) If the scanner is receiving power and the LEDs are not on, then the scanner has been dormant for a specified time and the laser has turned off. To reactivate the unit, pass an object through the scan field.
- 2.) If the scanner is not receiving power from the host or transformer, then the LEDs will not be on.

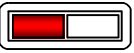

Steady Red

When the laser is on, the red LED is also on. The red LED will remain on until the scanning period has expired.

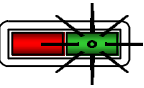

Steady Red and Single Green Flash

When the scanner successfully reads a bar code, the green LED will flash then beep once. If the green LED does not flash or the scanner does not beep once, then the bar code has not been successfully read.



Steady Red and Steady Green

After a successful scan, the scanner transmits the data to the host device. If the host is not ready to accept the information, the scanner's green LED will remain on until the data can be transmitted. The red LED will turn off when the scanning period expires.

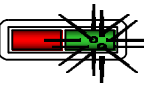

Steady Red and Flashing Green

This indicates the scanner is in program mode. A razzberry tone indicates that an invalid bar code has been scanned in this mode.



Steady Green

This indicates the scanner may be waiting for communication from the host.

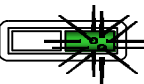

Flashing Green

This indicates the scanner is waking up from a dormant state in response to an IR sensor activation. Refer to page 18.

Label

Each scanner has a label located on the bottom of the unit. This label contains information such as the model number, date of manufacture, serial number, and approvals. This label also notes that the device is a CDRH Class IIa laser product. The following is an example of this label:



Depth of Field Specifications

Normal Depth of Field

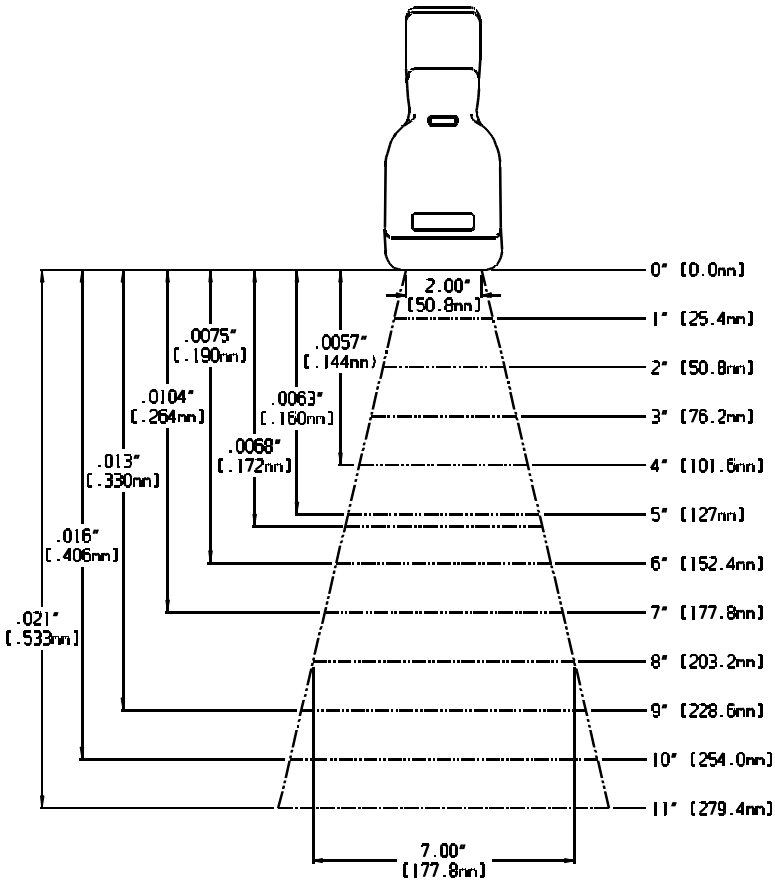

Short Depth of Field

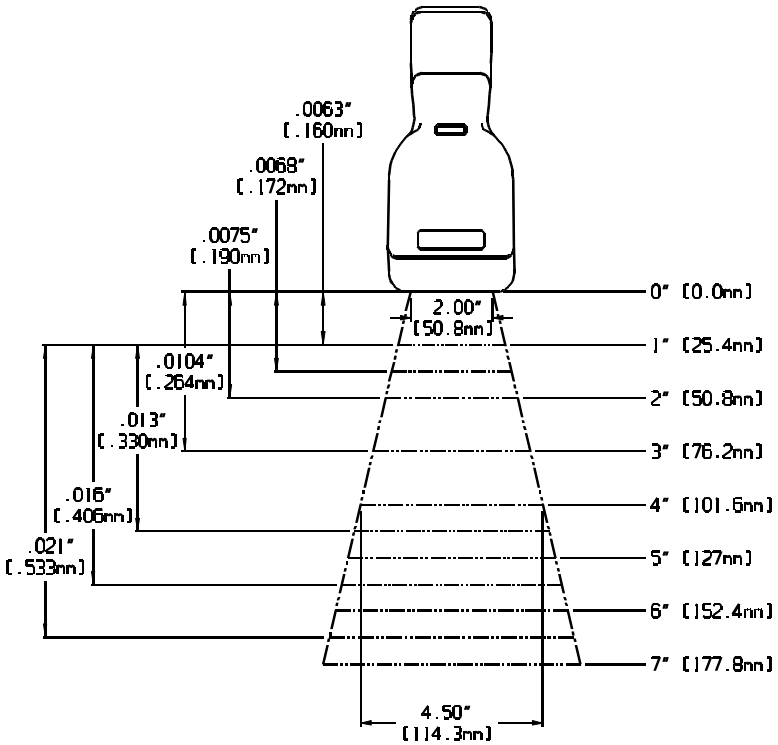

Extended Depth of Field

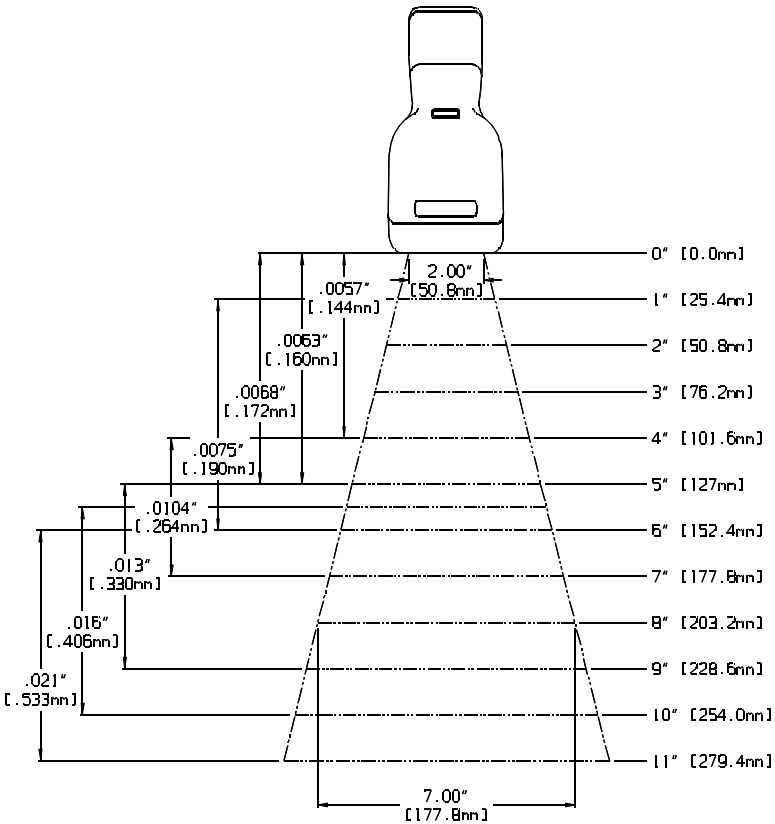

Optional Depth of Field

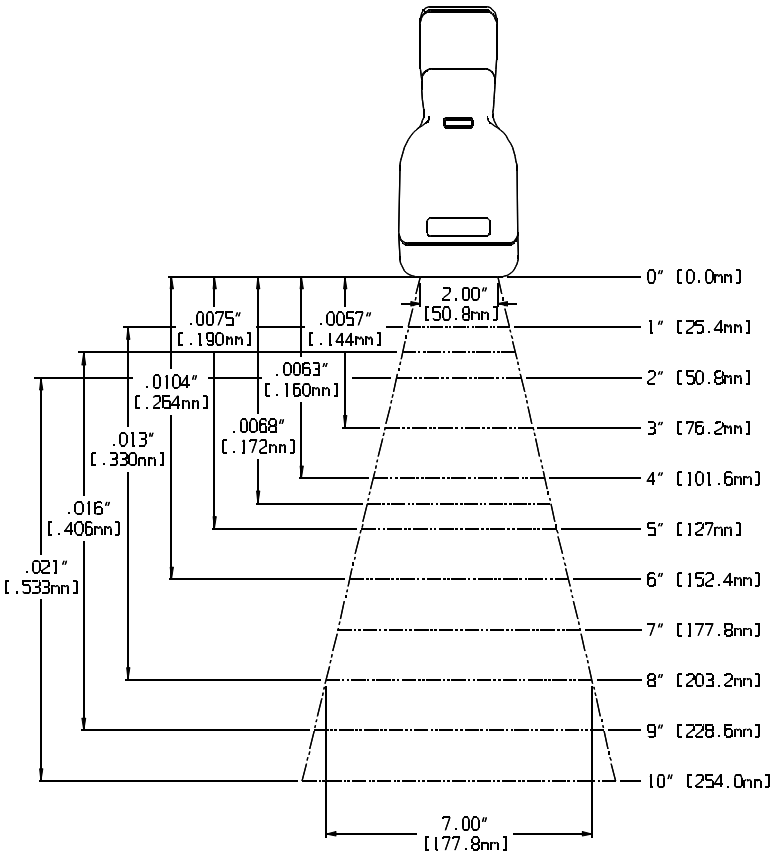

Automatic Turn-On Specifications (IR Sensor)

Normal Depth of Field

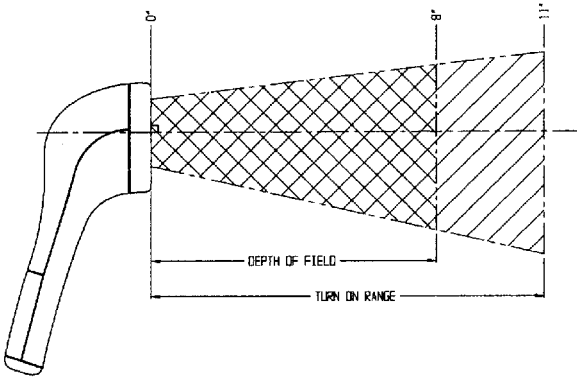

Short Depth of Field

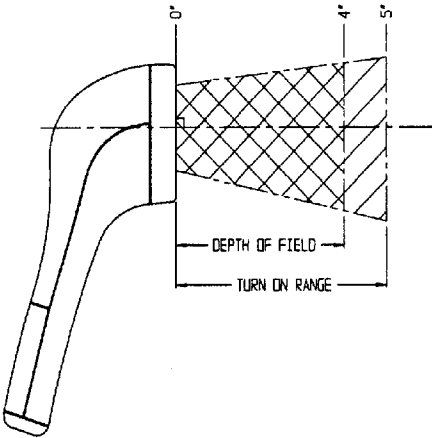

Note: Depth of Field based on 13mil (.013") minimum element width, Turn On Range is nominal; small variances do NOT indicate a malfunction.

Scan Pattern Specifics

Projection Axis

The scan pattern of the MS6720 exits straight out of the scanner. This feature was purposefully designed to provide pointing efficiency in the hand held mode and instinctive positioning in the fixed presentation mode.

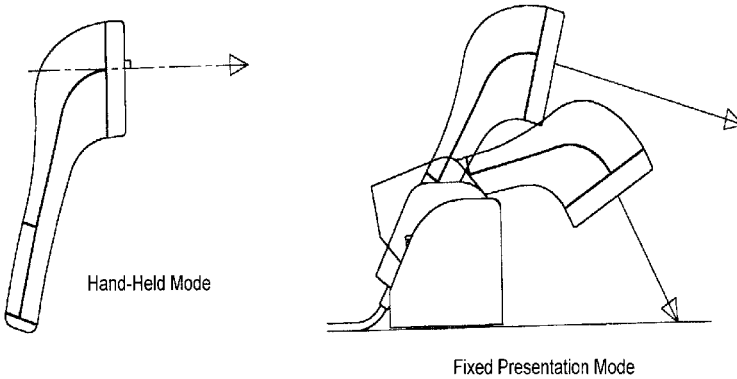

Omnidirectional Scan Volume

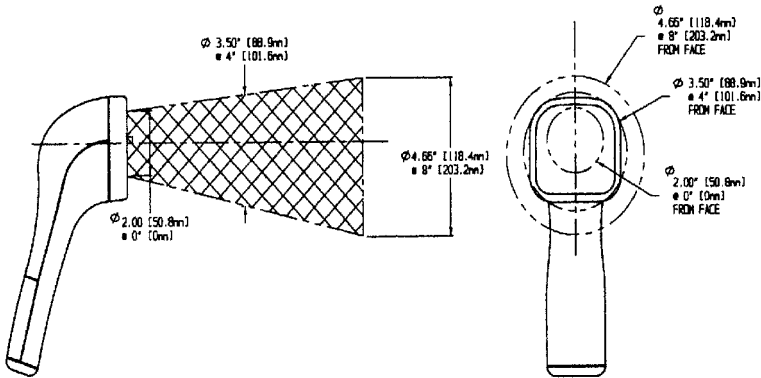

Note: The above scan volume shows omnidirectional volume. This volume does not reflect the entire length of all the laser lines. (Please refer to the Cross-Sectional Pattern in this section, page 20).

Cross-Sectional Scan Pattern

(scaled to fit paper)

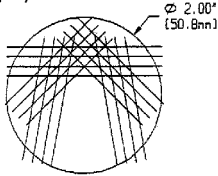

MS6720 Scan Pattern at face of scanner

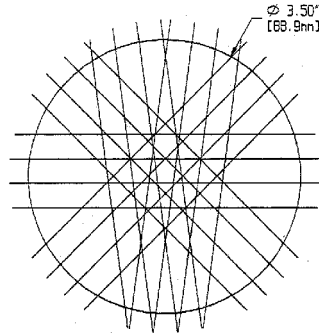

MS6720 Scan Pattern at 4" (101.6mm)

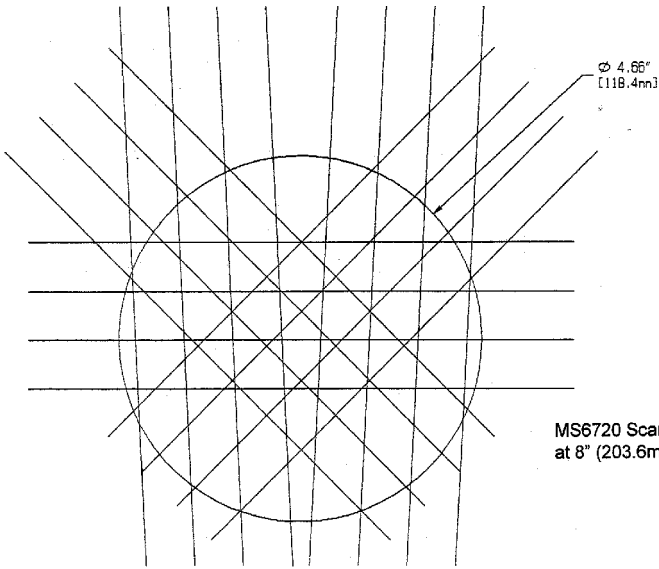

MS6720 Scan Pattern at 8" (203.6mm)

Maintenance

Smudges and dirt can interfere with the proper scanning of a bar code. Therefore, the output window will need occasional cleaning.

1. Spray glass cleaner onto lint free, non-abrasive cleaning cloth.
2. Gently wipe the scanner window.

The following guide is for reference purposes only. Contact a Metrologic representative at 1-800-ID-METRO or 1-800-436-3876 to preserve the limited warranty terms. Pg. 37.

All Interfaces

MS6720 Troubleshooting Guide		
SYMPTOMS	POSSIBLE CAUSE(S)	SOLUTION
No LEDs, beep or motor spin	No power at power up	Check transformer, outlet and power strip
NOTE: If it's a direct connect scanner, the problem could be inadequate power being supplied to the scanner. It may be necessary to use a Metrologic transformer for power. Check the fuse in the MCA.		
3 beeps on power up	Non-volatile RAM failure	Contact a Metrologic Rep, if the unit will not hold the programmed configuration
Continuous razz tone on power up	RAM or ROM failure	Contact a Metrologic Rep, if the unit will not function
Razz tone and red LED flash at power up	VLD failure	Contact a Metrologic Rep
Razz tone and both LEDs flash at power up	Scanner motor failure	Contact a Metrologic Rep
Unit scans, Communicates and beeps twice	Same symbol timeout set too short	Adjust same symbol timeout for a longer time

All Interfaces continued

SYMPTOMS	POSSIBLE CAUSE(S)	SOLUTION
Unit goes to sleep and does not wake up	IR sensor used to wake up the scanner is always sensing an object	Adjust scanner positioning so that the IR senses an object when a bar code is presented. For example; point to the ceiling and then back to the object. Disable IR sleep mode
Unit scans bar code too slowly upon waking up	wake up requires full motor spin up for operation	Disable IR sleep mode
NOTE: Disabling the IR sleep mode allows the scanner to respond to bar codes quicker		

SYMPTOMS
The unit powers up properly, lasers come on, but the unit does not scan and does not beep when a bar code is presented
POSSIBLE CAUSE(S)/SOLUTION(S)
Improper settings can be the cause for a scanner not to scan. The following would be typical examples:
1. Scanning a particular symbology that is not enabled. (UPC/EAN, Code 39, Interleaved 2 of 5, Code 93, Code 128 and Codabar are enabled by default.) Verify that the type of bar code being read has been selected.
2. The scanner has been programmed for a character length lock, or a minimum length and the bar code being scanned does not satisfy the programmed criteria. Verify that the bar code that is being scanned falls into the criteria. (Typical of Non-UPC/EAN codes.)
3. The scanner scans a bar code but the scanner locks up (green LED comes on and stays on) after the first scan. The scanner is configured to support some form of host handshaking but is not receiving the signal. If the scanner is setup to support ACK/NAK, RTS/CTS, XON/XOFF or D/E, verify that the host cable and host are supporting the handshaking properly.
4. The scanner scans and transmits but the data is not correct at the host. Verify that the scanner's data format matches that required by the host. Make sure that the scanner is connected to the proper host port.
SYMPTOMS
Scanner beeps at some bar codes and NOT for others of the same bar code symbology
POSSIBLE CAUSE(S)/SOLUTION(S)
1. The print quality of the bar code is suspect.
2. The aspect ratio of the bar code is out of tolerance.
3. The bar code may have been printed incorrectly. (check digit/character/or border problem.)

Keyboard Wedge Only

SYMPTOMS	POSSIBLE CAUSE(S)	SOLUTION
Unit scans the bar code but there is no data	Configuration is not correct	Make sure the scanner is configured for keyboard wedge mode - Section F of the ScanSelect Guide (MLPN 2186)
Unit scans but data is not correct	Configuration is not correct	Make sure that the proper PC type AT, PS2, XT is selected verify correct country code and data formatting are selected Adjust inter character delay
Unit is transmitting each character twice	Configuration is not correct	Increase the inter scan code delay setting Adjust whether the F0 break is transmitted. It may be necessary to try this in both settings.
Alpha characters show as lower case	Computer is in Caps Lock mode	Enable Caps Lock detect setting of the scanner to detect whether PC is operating in Caps Lock
Everything works except for a couple of characters	These characters may not be supported by that country's key look up table	Try operating the scanner in Alt mode

RS-232 only

SYMPTOMS	POSSIBLE CAUSE(S)	SOLUTION
Power-up OK Scans OK Does not communicate properly to the host	Com port at the host not working or not configured properly Cable not connected to the proper com port Com port not operating properly	Check to make sure the baud rate and parity of the scanner and the communication port match and the program is looking for "RS-232" data.

NOTE: Metrologic's default of 7 data bits, space parity is usually what is expected when an IBM compatible type PC is configured for 8 data bits, no parity.

SYMPTOMS	SOLUTION
Host receiving data but data does not look correct	Check that the scanner and host are configured for the same interface format
Characters are being dropped	Add some intercharacter delay to the transmitted output. This can be programmed into the scanner through ScanSelect

RS-232 Demonstration Program

If an RS-232 scanner is not communicating with your IBM compatible PC, key in the following BASIC program to test that the communication port and scanner are working. This program is for demonstration purposes only. It is only intended to prove that cabling is correct, the comx port is working, and the scanner is working. If the bar code data displays on the screen while using this program, it only demonstrates that the hardware interface and scanner are working. At this point, investigate whether the application software and the scanner configuration match. If the application does not support RS-232 scanners, a software wedge program that will take RS-232 data and place it into a keyboard buffer may be needed. This program tells the PC to ignore RTS-CTS, Data Set Ready (DSR) and Data Carrier Detect (DCD) signals. If the demonstration program works and yours still does not, jumper RTS to CTS and Data Terminal Reading (DTR) to DCD and DSR on the back of your PC.

```

10 CLS
20 ON ERROR GOTO 100
30 OPEN "COM1:9600,S,7,1,CS0,DS0,CD0,LF" AS #1
35 PRINT "SCAN A FEW BAR CODES"
40 LINE INPUT #1, BARCODE$
50 PRINT BARCODE$
60 K$ = INKEY$: IF K$ = CHR$(27) THEN GOTO 32766
70 GOTO 40
100 PRINT "ERROR NO.": ERR; " PRESS ANY KEY TO TERMINATE."
110 K$ = INKEY$: IF K$ = "" THEN GOTO 110
32766 CLOSE: SYSTEM
32767 END

```

Applications and Protocols

The model number on each scanner includes the scanner number and communications protocol.

Scanner	Version Identifier	Communication Protocol(s)
6720	9	OCIA (OCIA)
6720	11	IBM (46XX)
6720	14	RS-232 (232)
6720	15	Light Pen Emulation (LTPN)
6720	47	Keyboard Wedge (KBW)

The MS6720 Hand-Held Laser Scanner with Built-in PC Keyboard Wedge Interface is designed to be used for keyboard emulation only. However, many RS-232 programmable functions that are available in other Metrologic scanners are also available as keyboard wedge functions. The most important selectable options specific to the keyboard wedge are the following:

Keyboard Type

- ! ** AT (includes IBM® PS2 models 50, 55, 60, 80)
- ! XT
- ! IBM PS2 (includes models 30, 70, 8556)

Keyboard Country Type

- ! ** USA
- ! French
- ! Italian
- ! Belgium
- ! United Kingdom
- ! German
- ! Spanish
- ! Swiss

**Default setting. Refer to Appendix B pages 30 - 33 for default settings. Refer to ScanSelect Scanner Programming Guide (MLPN 2186) for information on how to change the default settings.

Appendix A

Design Specifications

Application:	Fixed Projection/Hand-Held Laser Bar Code Scanner
Max. Radiant Power:	0.681 Milliwatts (PEAK)
Light Source:	VLD 675 ± 5 nm
CDRH:	Class IIa laser product
CE:	EN 60950: 1993, EN 60825-1:1994/A11:1996, Laser Class 1, EN 55022:1987 Class A, EN 55082-1:1992, IEC 801-2:1991 8kVAD, IEC 100-4-3:1995 3V/m IEC 801-4:1988 1kV Power Lines
EMI:	FCC Class A

Mechanical

Dimensions:	110mm L x 75mm W x 160mm H
Weight:	450 grams
Termination:	~ 1 meter retracted coil cable

Electrical

Input Voltage:	5VDC $\pm .25$ V
Power :	1.1 watt
Operating Current :	225 mA typical @5VDC (468x - 300mA)
Standby Current:	74 mils (468x - 165mils)
DC Transformers:	Class 2; 5VDC @300mA

Operational

Depth of Field:	0" - 4"; 0"- 8" (programmable) 0 - 101.6mm; 0 - 203.2mm
Scan Speed:	1000 scan lines per second
Scan Pattern:	5 fields of 4 parallel lines
Scan Lines:	20
Min Bar Width:	5.2 mil
Indicators (LED):	red = laser on, ready to scan green = good read, decoding
Beeper Operation:	3 tones or no beep
Maintenance:	Clean output window periodically
Decode Capability:	Autodiscriminates all standard bar codes; for other symbologies call Metrologic
System Interfaces:	Keyboard Wedge, RS-232, OCIA, Light Pen, IBM 46xx
Print Contrast:	35% minimum reflectance difference
Roll, Pitch, Yaw:	360E, 60E, 60E

Environmental

Storage Temperature:	-40EC to 60EC (-40EF to 140EF)
Operating Temperature:	0EC to 35EC (32EF to 95EF)
Humidity:	5% to 95% relative humidity, non-condensing
Light Levels:	Up to 300 LUX
Ventilation:	None required
Shock:	1m. (40") drop
Contaminants:	Sealed to resist airborne particulate contaminants

This Metrologic product may be covered by one or more of the following U.S. patents:

5, 073,702, 5,115,333, 5, 216,232, 5,484,992, 5,525,789, 5,557,093,
5,591,953, 5,616,908.

Specifications subject to change without notice.

Appendix B

Default Settings

Many functions of the scanner can be "programmed" - that is, enabled or disabled. The scanner is shipped from the factory programmed to a set of default conditions. The default parameter of the scanner has an asterisk (*) in the charts on the following pages. If an asterisk is not in the default column then the default setting is Off or Disabled. Every communication does not support every parameter. If the communication supports a para-meter listed in the charts on the following pages, a check mark will appear.

Parameter	Default	OCIA	RS-232*	Light Pen	IBM 46XX	KBW
UPC/EAN	*	T	T	T	T	T
Code 128	*	T	T	T	T	T
Code 93	*	T	T	T	T	T
Codabar	*	T	T	T	T	T
Interleaved 2 of 5 (ITF)	*	T	T	T	T	T
MOD 10 Check on ITF		T	T	T	T	T
Code 11		T	T	T	T	T
Code 39	*	T	T	T	T	T
Full ASCII Code 39		T	T	T	T	T
MOD 43 Check on Code 39		T	T	T	T	T
MSI-Plessey		T	T	T	T	T
MSI-Plessey 10/10 Check Digit		T	T	T	T	T
MSI-Plessey MOD 10 Check Digit	*	T	T	T	T	T
MECCA		T	T	T	T	T
Paraf Support		T	T	T	T	T
ITF Symbol Lengths	Variable	T	T	T	T	T
Minimum Symbol Length	04	T	T	T	T	T
Symbol Length Lock	None	T	T	T	T	T
Bars High as Code 39	*			T		
Spaces High as Code 39				T		
Bars High as Scanned				T		
Spaces High as Scanned				T		
DTS/SIEMENS		T				

Parameter	Default	OCIA	RS-232*	Light Pen	IBM 46XX	KBW
DTS/NIXDORF	*	T				
NCR F		T				
NCR S		T				
Poll Light Pen Source				T		
Beeper Tone	Normal	T	T	T	T	T
Beep/Transmit Sequence	Before Transmit	T	T	T	T	T
Communication Timeout	None	T	T	T	T	T
Razzberry Tone on Timeout		T	T	T	T	T
Three Beeps on Timeout		T	T	T	T	T
No Beeps on Timeout	*	T	T	T	T	T
IR Timeout	10 Min.	T	T	T	T	T
Same Symbol Rescan Timeout: 200 msec		T	T	T	T	T
Same Symbol Rescan Timeout: 500 msec	*	T	T	T	T	T
Same Symbol Rescan Timeout: 1250 msec		T	T	T	T	T
Same Symbol Rescan Timeout: 2000 msec		T	T	T	T	T
Intercharacter Delay	1 msec	T	T		T	T
Scan Buffer 1 of 2	1	T	T	T	T	T
Transmit UPC-A Check Digit	*	T	T	T	T	T
Transmit UPC-E Check Digit		T	T	T	T	T
Expand UPC-E		T	T	T	T	T
Convert UPC-A to EAN-13		T	T		T	T
Transmit Lead Zero on UPC-E		T	T	T	T	T
Convert EAN-8 to EAN-13		T	T		T	T
Transmit UPC-A Number System	*	T	T	T	T	T
Transmit Codabar Start/Stop Characters		T	T		T	T
CLSI Editing (Enable)		T	T		T	T
Transmit Mod 43 Check Digit on Code 39		T	T		T	T
Transmit Code 39 Stop/Start Characters		T	T		T	T

Parameter	Default	OCIA	RS-232*	Light Pen	IBM 46XX	KBW
Transmit Mod 10/ITF		T	T		T	T
Transmit MSI-Plessey Check Characters		T	T		T	T
Parity	Space		T			
Baud Rate	9600		T			
8 Data Bits			T			
7 Data Bits	*		T			
Transmit Sanyo ID Characters			T			T
Nixdorf ID			T			T
Shell Schulmberger Formatting			T			T
UPC Prefix			T			T
UPC Suffix			T			T
Transmit AIM ID Characters			T			T
STX Prefix			T			T
ETX Suffix			T			T
Carriage Return	*		T			T
Line Feed	*		T			T
Tab Prefix			T			T
Tab Suffix			T			T
"DE" Disable Command			T			
"FL" Laser Enable Command			T			
DTR Handshaking Support			T			
RTS/CTS Handshaking			T			
Character RTS/CTS	*		T			
Message RTS/CTS			T			
XON/XOFF Handshaking			T			
ACK/NAK			T			
Two Digit Supplements		T	T	as code 39	T	T
Five Digit Supplements		T	T	as code 39	T	T
Bookland		T	T	as code 39	T	T

Parameter	Default	OCIA	RS-232*	Light Pen	IBM 46XX	KBW
977 (2 digit) Supplemental Requirement		T	T	T	T	T
Supplements are not Required	*	T	T	T	T	T
Two Digit Redundancy	*	T	T	T	T	T
Five Digit Redundancy		T	T	T	T	T
200 msec to Find Supplement		T	T	T	T	T
100 msec to Find Supplement	*	T	T	T	T	T
Coupon Code 128		T	T	as code 39	T	T

Appendix C

Pin Assignments

Cable Pin Assignments for the Coil Cable

The MS6720 scanners are terminated to a 10 position shielded modular connector. All of the coil cables (MLPN 44530) for the MS6720 scanner are terminated the same. The difference between versions is the end of the cable going into the scanner. This connector plugs into different “J” positions on various computer/interface boards. Since each computer/interface board is different, the output signals are different.

Version “9” (OCIA)

Pin	Function
1	Power/Signal Ground
2	RDATA
3	RDATA Return
4	Clock In
5	Clock In Return
6	Clock Out
7	Clock Out Return
8	No Connection
9	+5 VDC Power to Scanner
10	OCIA Shield Ground

Version “11” (46XX)

Pin	Function
1	Power/Signal Ground
2	RS-232 Transmit Output
3	RS-232 Receive Input
4	RTS Output
5	CTS Input
6	IBM 46XX Transmit
7	IBM 46XX Receive
8	No Connection
9	+5 VDC Power to Scanner
10	Shield Ground

Version “14” (232)

Pin	Function
1	Power/Signal Ground
2	RS-232 Transmit Output
3	RS-232 Receive Input
4	RTS Output
5	CTS Input
6	DTR Input
7	DSR Output
8	No Connection
9	+5 VDC Power to Scanner
10	Shield Ground

Version “15” (LTPN)

Pin	Function
1	Power/Signal Ground
2	RS-232 Transmit Output
3	RS-232 Receive Input
4	RTS Output
5	CTS Input
6	Light Pen Source +5V
7	Light Pen Data
8	No Connection
9	+5 VDC Power to Scanner
10	Shield Ground

Pin Assignments for the MCA951 (DEC9S)

Located on the MCA is a 9-pin female D-type connector used to connect the MCA to the host device. The output signals on the 9-pin host end of the MCA are dependent upon which version of the scanner that is being used. The following is a list of the pin assignments for the different versions:

Version "9" (OCIA)

Pin	Function
1	OCIA Shield Ground
2	RDATA
3	RDATA Return
4	Clock Out
5	Power/Signal Ground
6	Clock Out Return
7	Clock In Return
8	Clock In
*9	+5VDC Power to Scanner

Version "11" (46XX)

Pin	Function
1	Shield Ground
2	RS-232 Transmit Output
3	RS-232 Receiver Input
4	IBM 4680 -B
5	Power/Signal Ground
6	IBM 4680 +A
7	Clear to Send Input
8	Request to Send Output
*9	+5VDC Power to Scanner

Version "14" (232)

Pin	Function
1	Shield Ground
2	RS-232 Transmit Output
3	RS-232 Receiver Input
4	Data Terminal Ready Input
5	Power/Signal Ground
6	Data Set Ready Output
7	Clear to Send Input
8	Request to Send Output
9	+5VDC Power to Scanner

Version "15" (LTPN)

Pin	Function
1	Shield Ground
2	RS-232 Transmit Output
3	RS-232 Receiver Input
4	Light Pen Source (+5V Input)
5	Power/Signal Ground
6	Light Pen Data (Output)
7	Clear to Send (Input)
8	Request to Send (Output)
*9	+5VDC Power to Scanner

*When the host supplies power to the scanner, this is the pin assignment for the +5VDC for the scanner. If, in the application, the host device will supply the power necessary for the scanner, reposition an internal jumper within the MCA and plug the 4 position ground jumper to the power supply connector for FCC and ESD purposes. (Refer to Scanner Installation: Powered by External Power Supply page 5).

Pin Assignments for the 5-pin DIN and 6-pin mini-DIN MS6720 Hand-Held Laser Scanner with Built-in PC Keyboard Wedge Interface

The coil cable is terminated with a 5-pin DIN female connector on one end, and a 6-pin mini DIN male on the other. Metrologic will supply an adaptor cable with a 5-pin DIN male connector on one end and a 6-pin mini DIN female connector on the other.

Coil Cable Connectors

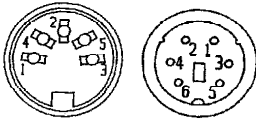

5-pin Female

6-pin Male

Adaptor Cable Connectors

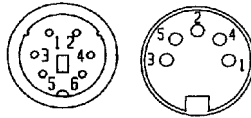

6-pin Female

5-pin Male

According to the termination required, connect the appropriate end of the adaptor cable to the coil cable, leaving the necessary termination exposed for connecting to the keyboard and the keyboard port on the PC. The pin assignments are as follows:

5-pin Female DIN

Pin	Function
1	Keyboard Clock
2	Keyboard Data
3	No Connect
4	Power Ground
5	+5 Volts DC

6-pin Female mini-DIN

Pin	Function
1	Keyboard Data
2	No Connect
3	Power Ground
4	+5 Volts DC
5	Keyboard Clock
6	No Connect

5-pin Male DIN

Pin	Function
1	PC Clock
2	PC Data
3	No Connect
4	Power Ground
5	+5 Volts DC

6-pin Male mini-DIN

Pin	Function
1	PC Data
2	No Connect
3	Power Ground
4	+5 Volts DC
5	PC Clock
6	No Connect

Appendix D

Warranty and Disclaimer

Limited Warranty

Products manufactured by Metrologic have a 2-year limited warranty from date of manufacture.

This warranty is limited to repair, replacement or refund at Metrologic's discretion. Faulty equipment must be returned to the Metrologic facility in Blackwood, New Jersey or Puchheim, Germany. To do this, contact Metrologic Customer Service/Repair for a Returned Material Authorization (RMA) number.

In the event that it is determined that the equipment failure is covered under the warranty, Metrologic shall, as its sole option, repair, replace with a functionally equivalent unit, or refund an amount equal to the purchase price to the original purchaser, whether distributor, dealer/reseller, or retail consumer, and return the equipment to the customer without charge for service or return freight.

This limited warranty does not extend to any Product which, in the sole judgment of Metrologic, has been subjected to misuse, neglect, improper installation or accident, nor does it extend to any Product which has been repaired or altered by anyone who is not a Metrologic authorized representative.

THIS LIMITED WARRANTY, EXCEPT AS TO TITLE, IS IN LIEU OF ALL OTHER WARRANTIES, EXPRESS OR IMPLIED, INCLUDING MERCHANTABILITY OR FITNESS FOR ANY PARTICULAR PURPOSE, ARISING BY LAW, CUSTOM OR CONDUCT. THE RIGHTS AND REMEDIES PROVIDED HEREIN ARE EXCLUSIVE AND IN LIEU OF ANY OTHER RIGHTS OR REMEDIES. IN NO EVENT SHALL METROLOGIC BE LIABLE FOR INDIRECT, INCIDENTAL, OR CONSEQUENTIAL DAMAGES, INCLUDING, WITHOUT LIMITATION, ANY INJURY TO PROPERTY OR PERSON OR EFFECT ON BUSINESS OR PROFIT, AND IN NO EVENT SHALL ANY LIABILITY OF METROLOGIC EXCEED THE ACTUAL AMOUNT PAID TO METROLOGIC FOR THE PRODUCT.

Metrologic Instruments, Inc.
90 Coles Road
Blackwood, NJ 08012

Customer Service Department
1-800-ID-METRO (1-800-436-3876)
TEL: 609-228-8100
FAX: 609-228-6673

Metrologic Instruments GmbH
Dornierstrasse 2
82178 Puchheim b.
Munich, Germany
TEL: 49-89-89019-0
FAX: 49-89-89019-200

Disclaimer

Metrologic Instruments, Inc. and the author or authors make no claims or warranties with respect to the contents or accuracy of this publication, or the product it describes, including any warranties of fitness or merchantability for a particular purpose. Any stated or expressed warranties are in lieu of all obligations or liability for any damages, whether special, indirect, or consequential, arising out of or in connection with the use of this publication or the product it describes.

Furthermore, the right is reserved to make any changes to this publication without obligation to notify any person of such changes. Metrologic also reserves the right to make any changes to the product described herein.

Exclusion des responsabilités

Metrologic Instruments, Inc. et le/les auteur(s) ne sont ni garants, ni responsables pour l'exhaustivité et la correction des informations contenues dans cette brochure - que ce soit - relativement à leur teneur et à l'exactitude - ou pour le produit qui y est décrit. Ils ne sont en outre responsables d'aucune garantie de propriété ou de qualité pour un usage particulier. Toutes les assurances nommées ou exprimées excluent toute garantie ou responsabilité pour les dommages spéciaux, indirects ou des suites de l'utilisation de cette brochure ou du produit qui y est décrit respectivement, en rapport avec l'emploi de cette brochure et du produit qui y est décrit. Il leur est également réservé le droit de procéder à des modifications de cette brochure sans avoir à en avertir qui que ce soit. Metrologic se réserve en outre le droit de procéder à des modifications du produit qui y est décrit.

Haftungsausschluß

Metrologic Instruments, Inc. und der/die Autor(en) übernehmen keinerlei Gewähr und haften nicht für die Richtigkeit im Hinblick auf Inhalt oder Genauigkeit der Angaben dieser Veröffentlichung oder des hierin beschriebenen Produkts. Sie übernehmen ebenso keinerlei Eignungsgarantie oder Gewährleistung durchschnittlicher Qualität für einen bestimmten Zweck. Alle benannten oder ausdrücklichen Zusicherungen schließen sämtliche Verpflichtungen oder Haftungen aus jeglichem Schaden aus, ganz gleich ob speziell, indirekt oder als Folge der Verwendung dieser Veröffentlichung oder des hierin beschriebenen Produkts bzw. in Zusammenhang mit der Verwendung dieser Veröffentlichung oder des hierin beschriebenen Produkts. Darüber hinaus wird das Recht vorbehalten, Änderungen an dieser Veröffentlichung vorzunehmen ohne die Verpflichtung, irgend jemanden über solche Änderungen zu unterrichten. Metrologic behält sich ferner das Recht vor, Änderungen an dem hierin beschriebenen Produkt vorzunehmen.

Esclusione della responsabilità

La Metrologic Instruments, Inc. e l'autore/gli autori non assumono nessuna garanzia e non rispondono della correttezza per quanto riguarda il contenuto o la precisione di quanto indicato nel presente Manuale o del prodotto in esso descritto. Neppure essi assumono una garanzia per l'idoneità o una garanzia della qualità media per un determinato scopo. Tutte le garanzie citate o fatte espressamente escludono qualsiasi obbligo o responsabilità derivanti da qualsiasi danno, indipendentemente dal fatto che questo obbligo/questa responsabilità risulti in particolare, indirettamente o come conseguenza dall'uso del presente Manuale o del prodotto in esso descritto oppure se è legato/a all'uso del presente Manuale o del prodotto in esso descritto. Inoltre ci si riserva il diritto di modificare il presente Manuale senza essere obbligati ad informare persona alcuna circa dette modifiche. Metrologic si riserva il diritto di apportare modifiche al prodotto descritto nel presente Manuale.

Appendix E

Notices

Notice

This equipment has been tested and found to comply with limits for a Class A digital device, pursuant to Part 15 of the FCC Rules. These limits are designed to provide reasonable protection against harmful interference when the equipment is operated in a commercial environment. This equipment generates, uses and can radiate radio frequency energy and, if not installed and used in accordance with the instruction manual, may cause harmful interference to radio communications. Operation of this equipment in a residential area is likely to cause harmful interference, in which case the user will be required to correct the interference at his own expense. Any unauthorized changes or modifications to this equipment could void the users authority to operate this device.

Notice

This digital apparatus does not exceed the Class A limits for radio noise emissions from digital apparatus set out in the Radio Interference Regulations of the Industry and Canada.

Caution

Use of controls or adjustments or performance of procedures other than those specified herein may result in hazardous laser light. Under no circumstances should the customer attempt to service the laser scanner. Never attempt to look at the laser beam, even if the scanner appears to be nonfunctional. Never open the scanner in an attempt to look into the device. Doing so could result in hazardous laser light exposure. The use of optical instruments with the laser equipment will increase eye hazard.

Remarque

Après contrôle de cet appareil, on a noté qu'il répondait aux valeurs limites de la classe A, conformément à la partie 15 des directives de l'administration fédérale américaine pour les télécommunications. Ces valeurs limites ont été prévues pour garantir une protection suffisante contre les effets nocifs dus à l'emploi de l'appareil dans un magasin. L'appareil génère et utilise une énergie haute fréquence et peut, s'il n'est pas installé et utilisé conformément aux instructions mentionnées dans le guide d'utilisation, entraîner des perturbations dans la radiocommunications. L'utilisation de cet appareil dans une zone d'habitation entraînera très vraisemblablement des perturbations. Dans ce cas, l'utilisateur est tenu de remédier à ces perturbations à ses propres frais. Toute modification ou remplacement non autorisé sur cet appareil peut entraîner l'invalidité de l'autorisation d'utilisation de l'appareil.

Remarque

Cet appareil numérique ne va pas contre les valeurs limites pour émissions de bruits radios des appareils numérique de la classe A, conformément aux directives relatives aux perturbations des radiocommunications du ministère canadien pour l'industrie.

Attention

L'emploi de commandes, réglages ou procédés autres que ceux décrits ici peut entraîner de graves irradiations. Le client ne doit en aucun cas essayer d'entretenir lui-même le scanner ou le laser. Ne regardez jamais directement le rayon laser, même si vous croyez que le scanner est inactif. N'ouvrez jamais le scanner pour regarder dans l'appareil. Ce faisant, vous vous exposez à une rayonnement laser mortel. L'emploi d'appareils optiques avec cet équipement laser augmente le risque d'endommagement de la vision.

Anmerkung

Nach Überprüfung dieses Geräts wurde festgestellt, daß es den Grenzwerten für Digitalgeräte der Klasse A gemäß Teil 15 der Richtlinien der US-amerikanischen Bundesbehörde für das Fernmeldewesen entspricht. Diese Grenzwerte wurden festgelegt, um einen angemessenen Schutz gegen schädliche Auswirkungen bei Einsatz des Geräts in einer Ladenumgebung zu gewähren. Das Gerät erzeugt und verwendet Hochfrequenzenergie und kann diese ausstrahlen, und kann, falls es nicht gemäß den im Bedienerhandbuch enthaltenen Anweisungen installiert und verwendet wird, zu einer Störung des Funkverkehrs führen. Der Betrieb dieses Geräts in einem Wohngebiet führt höchstwahrscheinlich zu Störungen. In diesem Fall ist der Bediener verpflichtet, die Störung auf eigene Kosten zu beseitigen. Durch jegliche unerlaubte Auswechslung oder Änderung an diesem Gerät könnte die Genehmigung des Bedieners zur Verwendung dieses Geräts ungültig werden.

Anmerkung

Dieses Digitalgerät verstößt nicht gegen die Grenzwerte für Funkrauschemissionen von Digitalgeräten der Klasse A gemäß den Richtlinien für Funkstörungen des kanadischen Ministeriums für Industrie.

Achtung

Die Verwendung anderer als der hierin beschriebenen Steuerungen, Einstellungen oder Verfahren kann eine lebensgefährliche Laserstrahlung hervorrufen. Der Kunde sollte unter keinen Umständen versuchen, den Laser-Scanner selbst zu warten. Sehen Sie niemals in den Laserstrahl, selbst wenn Sie glauben, daß der Scanner nicht aktiv ist. Öffnen Sie niemals den Scanner, um in das Gerät hineinzusehen. Wenn Sie dies tun, können Sie sich einer lebensgefährlichen Laserstrahlung aussetzen. Der Einsatz optischer Geräte mit dieser Laserausrüstung erhöht das Risiko einer Sehschädigung.

N.B.

Dal controllo di questo apparecchio risulta che esso risponde ai valori limite per apparecchi digitali della classe A conf. parte 15 delle direttive sulle telecomunicazioni dell'Autorità federale statunitense. Questi valori limite sono stati fissati per garantire una protezione adeguata contro gli effetti nocivi se questo apparecchio viene usato all'intero di un negozio. L'apparecchio genera, utilizza e può emettere energia ad alta frequenza e, se non viene installato ed utilizzato conformemente alle indicazioni fornite nel Manuale utente, può provocare disturbi al servizio radiofonico. L'uso di questo apparecchio in zone residenziali causa molto probabilmente dei disturbi. In questo caso l'utente è obbligato ad eliminare questi disturbi a sue spese. Qualsiasi sostituzione o modifica non autorizzata all'apparecchio potrebbe rendere invalida l'autorizzazione dell'utente all'uso dell'apparecchio.

N.B.

Questo apparecchio digitale non supera I valori limite per l'emissione di radiorumori da parte di apparecchi digitali della classe A conformemente alle direttive per radiodisturbi del Ministero canadese per l'Industria.

Attenzione

L'utilizzo di sistemi di controllo, di regolazioni o di procedimenti diversi da quelli decritti nel presente Manuale può provocare dei raggi laser pericolosi per la vita. Il cliente non deve assolutamente tentare di riparare egli stesso lo scanner laser. Non guardate mai nel raggio laser, anche se credete che lo scanner non sia attivo. Non aprite mai lo scanner per guardare dentro l'apparecchio. Se tuttavia lo fate, potete esporvi a dei raggi laser pericolosi per la vita. L'uso di apparecchi ottici con questo equipaggiamento laser aumenta il rischio di danni alla vista.

Appendix F

Patents

“Patent Information

This METROLOGIC product may be covered by one or more of the following U.S. Patents:

U.S. Patent No. 4,360,798; 4,369,361; 4,387,297; 4,460,120; 4,496,831; 4,593,186; 4,607,156; 4,673,805; 4,736,095; 4,758,717; 4,816,660; 4,845,350; 4,896,026; 4,923,281; 4,933,538; 4,992,717; 5,015,833; 5,017,765; 5,059,779; 5,117,098; 5,124,539; 5,130,520; 5,132,525; 5,140,144; 5,149,950; 5,180,904; 5,200,599; 5,229,591; 5,247,162; 5,250,790; 5,250,791; 5,250,792; 5,262,628; 5,280,162; 5,280,164; 5,304,788; 5,321,246; 5,324,924; 5,396,053; 5,396,055; 5,408,081; 5,410,139; 5,436,440; 5,449,891; 5,468,949; 5,479,000; 5,532,469; 5,545,889, 5,216,232; 1,268,257; 5,484,992; 5,468,951; 5,340,971; 5,424,525; 4,960,985

No license right or sublicense is granted, either expressly or by implication, estoppel, or otherwise, under any METROLOGIC or third party intellectual property rights (whether or not such third party rights are licensed to METROLOGIC), including any third party patent listed above, except for an implied license only for the normal intended use of the specific equipment, circuits, and devices represented by or contained in the METROLOGIC products that are physically transferred to the user, and only to the extent of METROLOGIC’s license rights and subject to any conditions, covenants and restrictions therein.”

Index

A

- Accessories 2
- AC input/outlet 2, 4, 5, 7
- Adaptor
 - cable 2, 7, 36
 - 5M 6F 7
 - MCA 2, 4-6
- Application 2, 27, 28, 35
- Approvals 13
- Assignments
 - pin 34-36
- Audible indicators 10
- Authorized service center 37
- Autodiscriminates 29
- Automatic turn-on specifications
 - Normal DOF 18
 - Short DOF 18
- Axis
 - projection 19

B

- Bar code 3, 10, 12, 21, 23-26, 29
- Bar width 29
- Beep(s) 3-5, 10-12, 22, 24, 29, 31
- Beeper operation 29
- Built-in PC keyboard wedge interface 4, 7, 27, 36

C

- Cable
 - adaptor 2, 4, 7, 36
 - coil 4-7, 28, 34, 36
 - communication 5, 6
 - pin assignments 34-36
- Caution 39
- CDRH 28
- CE 28
- Characteristics 9-13
- Compliance 5, 7
- Configuration procedures 5-7
- Connector(s) 2, 4-7, 34-36

- Cross sectional scan pattern 20
- Current 7, 28
- Customer service 37

D

- DC transformer 28
- Decode capability 29
- Default Settings 30-33
- Depth of field 14-18, 29
- Design specifications 28, 29
- Dimensions 28
- Disclaimer 38

E

- Electrical 28
- EMI 28
- Extended DOF 16
- External power supply 4, 5, 7, 35

F

- Failure indicator(s) 10, 11
- Failure modes 10, 11
- Female connector 2, 7, 36
- Function(s) 27, 30-36

G

- Green LED 2, 5, 10-12, 24, 29
- Ground 34-36
- Ground jumper 2, 6, 35

H

- Host 2-6, 12, 24, 26, 35

I

- Indicators
 - Audible 10
 - Visual 12
 - LED 3-5, 10-12, 22, 24, 29
- Input voltage 28

Installation 5-7
 Interfaces 22, 24, 29

J
 J positions 34
 JP1 6
 Jumper 2, 6, 35

K
 Keyboard Type(s) 27
 Keyboard Wedge (KBW) 2-4, 7,
 25-27, 29, 36

L
 Label 13
 LEDs 3-5, 10-12, 22, 24, 29
 Light levels 29
 Light source 28
 List 2
 LTPN 27, 34, 35

M
 Maintenance 21, 29
 Manufacturer's recommendation
 7
 MCA 2, 4-6, 22, 35
 Mechanical 28
 Min bar width 29

N
 Normal depth of field 14, 18
 Notices 39, 40

O
 OCIA 2-4, 27, 29-35
 Omindirectional scan volume
 19
 Operating current 28
 Operating temperature 29
 Operation 4-7
 Operational 29
 Operational test 4
 Optional depth of field 17
 Output 34, 35
 Output window 21, 29

P
 Parts 9
 Patents 41
 PC 4-7, 27, 36
 Pin assignments 34-36
 Port 5-7, 24, 26, 36
 Powered by 5, 6
 Power supply 4-7, 35
 Programming guide 2, 3,
 27
 Projection axis 19
 Protocols 27

Q
 Quick start 3

R
 Razzberry tone 10-12, 31
 RDATA 34, 35
 Recommendation 7
 Red led 3-5, 10, 12, 22
 Repair 22, 37
 Rights
 property 41
 warranty 37
 RMA 37
 Roll, pitch, yaw 29
 RS-232 2-4, 26, 27, 29-35

S
 Scan lines 29
 Scan pattern(s) 19, 20, 29
 Scan speed 29
 Scan volume 19
 Scanner installation 5-7
 ScanSelect manual 2, 3,
 25-27
 SELV 5, 7
 Service 37
 Shock 29
 Specifications 14-20, 28, 29
 Stand 2, 8
 Storage temperature 29

System interfaces 29

T

Termination 34-36

Test 4

Transformers 28

Troubleshooting 22-26

Tones 10-12, 29

Turn-on specifications 18

V

Ventilation 29

Version 27, 34, 35

Visual indicators 12

Voltage 4, 5, 7, 28

W

Warranty 22, 37

Watt 28

Weight 28

Window 21

Free Manuals Download Website

<http://myh66.com>

<http://usermanuals.us>

<http://www.somanuals.com>

<http://www.4manuals.cc>

<http://www.manual-lib.com>

<http://www.404manual.com>

<http://www.luxmanual.com>

<http://aubethermostatmanual.com>

Golf course search by state

<http://golfingnear.com>

Email search by domain

<http://emailbydomain.com>

Auto manuals search

<http://auto.somanuals.com>

TV manuals search

<http://tv.somanuals.com>