

METROLOGIC INSTRUMENTS, INC.

# MX001 Industrial Control Interface Installation and User's Guide

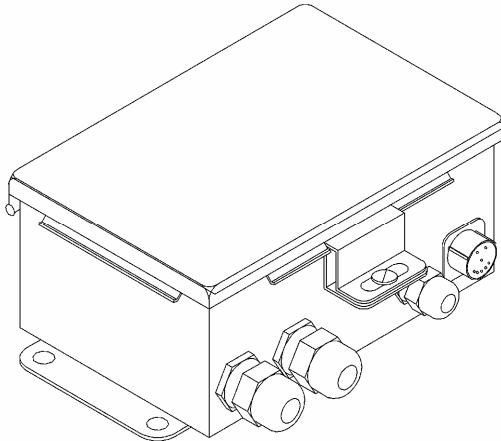

## **Copyright**

© 2007 by Metrologic Instruments, Inc. All rights reserved. No part of this work may be reproduced, transmitted, or stored in any form or by any means without prior written consent, except by reviewer, who may quote brief passages in a review, or provided for in the Copyright Act of 1976.

## **Trademarks**

Metrologic is a registered trademark of Metrologic Instruments, Inc. Products identified in this document are hereby acknowledged as trademarks, registered or otherwise, of Metrologic Instruments, Inc. or their respective companies.

# TABLE OF CONTENTS

---

Introduction.....	1
Opening the MX001 Industrial Control Box.....	2
Internal Components.....	3
LED Status Indicators .....	4
Configuring the MX001 for 115 or 230 Volt Operation	
USA: 115V Operation .....	5
USA: 230V Operation .....	6
Europe/Asia:230V Operation.....	7
Europe/Asia: 115V Operation.....	8
Locating the Three Strain Reliefs and the Signal Connector.....	9
Connecting External Wiring to the MX001 .....	9
Power Requirements for the MX001 .....	9
Connecting the AC Power Input Cable .....	10
Connecting the TRIAC Controlled Power Output Cable .....	11
Temporarily Disabling the TRIAC Output.....	12
Sensor Support .....	13
Connecting the Sensor .....	14
Temporarily Disabling the Sensor and/or Sensor Alarm .....	14
Sensors Powered Independently that Provide either 12V, 5V or a 10mA DC Output Signal .....	15
Sensors that Provide Switch Closures or Relay Type Output.....	17
Low Voltage Self-Contained DC Sensors with a Current Sinking Output.....	18
Low Voltage Self-Contained DC Sensors with a Current Sourcing Output.....	19
Universal Self-Contained Sensors that Provide a Single Pole/Double Throw (SPDT) Relay Output.....	20

## TABLE OF CONTENTS

---

Sensors Powered Independently that Provide Either 12V, or a 10mA DC Output Signal with a Sensor Alarm .....	22
Sensors that Provide Switch Closures or Relay Type Output with a Sensor Alarm.....	24
Low Voltage Self-Contained DC Sensors with Current Sinking Outputs and Sensor Alarm .....	25
Universal Self-contained Sensors That Provide Single Pole/Double Throw (SPDT) Relay Outputs for Both Object Sensing and Sensor Alarm .....	27
Closing the MX001 Industrial Control Box .....	29
Connecting the MX001 to the Scanner .....	29
Cable Pin Outs for the 8-Pin and 19-Pin Connectors .....	30
Specifications .....	31
Troubleshooting .....	32
Limited Warranty .....	40
Notices .....	41

## INTRODUCTION

---

Metrologic's MX001 Industrial Control Interface enhances Metrologic's line of industrial laser scanners. It does this by providing a way to connect an external object sensor to the scanner and a way for the scanner to control an external device through an electronic switch (a TRIAC). This enables the scanner to sense the presence of objects to be scanned and then provide a line voltage output signal if the scanned object meets preprogrammed conditions.

The MX001 can be configured to support any object sensor that can supply a 12V, 5V or 10mA output signal. It will also support switch closure (relay) type sensor output. Additionally, the MX001 can provide 12V DC power (at 200mA maximum) to a low voltage, DC type sensor unit making external sensor power supplies unnecessary.

The MX001's electronic switch or TRIAC, allows the scanner to control an external device directly by switching a line voltage output signal off or on and can handle device loads of up to a maximum of 6 amps US and Canada, 5 amps Europe. The switching can take place in response to a good scan, a no read scan, or a mismatch between scanned label data and expected label data preprogrammed into the scanner for comparison purposes. The scanner can also activate the TRIAC switch in response to a host system command sent through the RS-232 scanner-host communications link.

This manual shows how to wire and configure the MX001 Industrial Control Box so that it will work properly when connected to its associated sensor, output device and TECH series scanner. Programming the associated TECH series scanner is necessary to define how the object sensor and TRIAC switch will operate. Tech series industrial scanners are programmed by using Metrologic's HoloSet® configuration software which operates through an RS-232 port of an IBM XT, AT or compatible PC. In order to program the scanner a HoloSet kit containing the necessary communications cable, software and manual will be needed. Please refer to that manual for further details on how to configure the scanner for use with the MX001 box.

## OPENING THE MX001 INDUSTRIAL CONTROL BOX

---

To open the MX001 box for wiring and configuration, proceed as follows:

1. Loosen the lid clamp screw with a flat blade screwdriver.
2. Disengage the clamp by pushing the lid down, then move the clamp to the left, and rotate it outward in a counterclockwise direction.
3. Once the clamp is disengaged, open the lid.

## INTERNAL COMPONENTS

The following illustration and list explain the parts that pertain to the installation and operation of the MX001.

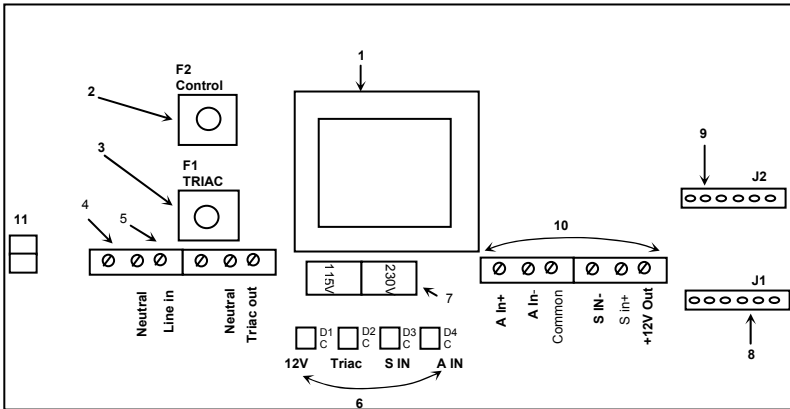

Figure 1

1. **Power Transformer** Supplies a stepped down and isolated voltage that produces the 12V DC power for the industrial control box and external sensor.
2. **F2 Control Fuse Holder** Contains the fuse that controls the 12V DC power in the industrial control box.
3. **F1 TRIAC Fuse Holder** Contains the fuse that controls the power for the TRIAC output.
4. **Power Terminal Block**  
(Line Power Input) Provides the input connection point for the AC line that supplies power to the industrial control box.
5. **TRIAC Terminal Block**  
(Controlled Power Output) Provides the output connection point for the scanner controlled power output (switched by the TRIAC).
6. **LED Status Indicators** These light up when the +12V power supply, TRIAC, sensor, or sensor alarm circuits are active.
7. **Voltage Selector Switch** Used to configure the industrial control box to match the incoming line voltage.
8. **J1 Jumper** Configures sensor input.
9. **J2 Jumper** Configures the sensor alarm input.
10. **Sensor Terminal Block** Provides the connection points for the sensor.
11. **Protective Earthing Connectors** To connect line cord protective earthing conductors to industrial control box enclosure.

## LED STATUS INDICATORS

---

The LED, (light emitting diode) status indicators are found just below the voltage selector switch. They indicate the operating state of the 12V power supply, the TRIAC and the status of the sensor and sensor alarm inputs. An LED will glow when a circuit is active. From these visual indications, it can be determined if the MX001 box is active and what action the scanner and sensor are performing in your system. The following list explains the function of each indicator. They appear inside the box in the order illustrated in Figure 2.

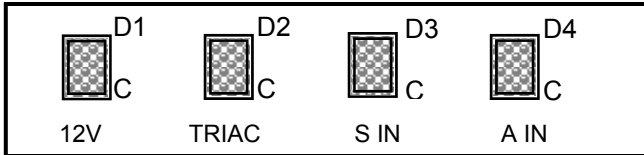

Figure 2

### **Green +12V (D1)**

Indicates that the +12V control and sensor power supply is active

### **Red TRIAC (D2)**

Indicates that the TRIAC switched power output circuit is active.

### **Red S IN (D3)**

Indicates that the sensor circuit is active because an object is being sensed.

### **Red A IN (D4)**

Indicates that the sensor alarm circuit is active because the sensing conditions are marginal.

**Note:** The red TRIAC, S IN and A IN LED's perform two functions. Besides circuit activity (status), these indicators also monitor the connection between the MX001 box and the scanner and will not light if that connection is broken. Thus, if lit, the indicators also show the user that the inter-connecting signal (link) cable between the scanner and the MX001 box is good.



## CONFIGURING THE MX001 FOR 115 OR 230 VOLT OPERATION

Before applying power to the MX001, it must first be configured for either 115 or 230 volt operation as required. This is accomplished by using the voltage selector switch and the installation of the proper fuses. Refer to one of the procedures on the following pages that apply to your voltage requirement to learn which fuses should be inserted into the F1 and F2 fuse holders. (Refer to Figure 3)

If fuse replacement becomes necessary, replace with the same type of fuse originally supplied. Damage to the unit may result if the same type of fuse is not used.

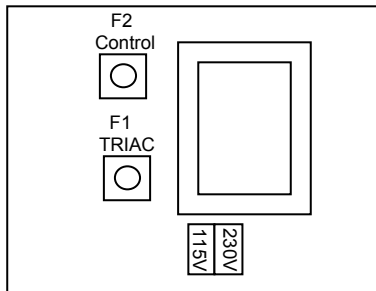

Figure 3

### USA: 115V Operation

1. Move the voltage selector to the right with a small screwdriver so that the 115V legend shows in the window.
2. Open the fuse kit and remove the following:
  - (2) Gray Fuse Holder Caps
  - (1) 10 Amp 250V Fast Acting  $\frac{1}{4}$  x 1  $\frac{1}{4}$  Inch Fuse
  - (1) 1/8 Amp 250V Slow Blow  $\frac{1}{4}$  X 1  $\frac{1}{4}$  Inch Fuse
3. Press the end of the 10 Amp fuse into one of the gray fuse holder caps until it seats.
4. Insert the fuse and cap into the **F1 TRIAC fuse holder** with the screwdriver slot pointing toward the power transformer.
5. Using a small screw driver, press the cap down into the fuse holder body and turn the cap  $\frac{1}{4}$  turn clockwise to lock the cap in place. This results in the cap slot pointing toward the top and bottom of the box.

## CONFIGURING THE MX001 FOR 115 OR 230 VOLT OPERATION

---

### USA: 115V Operation (continued)

6. Press the end of the 1/8 Amp fuse into the other gray fuse holder cap until it seats.
7. Insert the fuse and cap into the **F2 control fuse holder** with the screwdriver slot pointing toward the power transformer.
8. Using a small screwdriver, press the cap down into the fuse holder body and turn the cap ¼ turn clockwise to lock the cap in place. This results in the cap slot pointing toward the top and bottom of the box.

### USA: 230V Operation

1. Move the voltage selector to the left with a small screwdriver so that the 230V legend shows in the window.
2. Open the fuse kit and remove the following:
  - (2) Gray Fuse Holder Caps
  - (1) 10 Amp 250V Fast Acting ¼ x 1 ¼ Inch Fuse
  - (1) 1/16 Amp 250V Slow Blow ¼ x 1 ¼ Inch Fuse
3. Press the end of the 10 Amp fuse into one of the gray fuse holder caps until it seats.
4. Insert the fuse and cap into the **F1 TRIAC fuse holder** with the screwdriver slot pointing toward the power transformer.
5. Using a small screwdriver, press the cap down into the fuse holder body and turn the cap ¼ turn clockwise to lock the cap in place. This results in the cap slot pointing toward the top and bottom of the box.
6. Press the end of the 1/16 Amp fuse into the other gray fuse holder cap until it seats.
7. Insert the fuse and cap into the **F2 control fuse holder** with the screwdriver slot pointing toward the power transformer.
8. Using a small screwdriver, press the cap down into the fuse holder body and turn the cap ¼ turn clockwise to lock the cap in place. This results in the cap slot pointing toward the top and bottom of the box.

## CONFIGURING THE MX001 FOR 115 OR 230 VOLT OPERATION

---

### Europe/Asia: 230V Operation

1. Move the voltage selector to the left with a small screwdriver so that the 230V legend shows in the window.
2. Open the fuse kit and remove the following:
  - (2) Black Fuse Holder Caps
  - (1) 6.3 Amp 250V Fast Acting, High Interrupt 5 x 20 mm Fuse
  - (1) 50ma 250V Time Delay 5 x 20 mm Fuse
3. Press the end of the 6.3 Amp fuse into one of the black fuse holder caps until it seats.
4. Insert the fuse and cap into the **F1 TRIAC fuse holder** with the screwdriver slot pointing toward the power transformer.
5. Using a small screwdriver, press the cap down into the fuse holder body and turn the cap  $\frac{1}{4}$  turn clockwise to lock the cap in place. This results in the cap slot pointing toward the top and bottom of the box.
6. Press the end of the 50mA fuse into the other black fuse holder cap until it seats.
7. Insert the fuse and cap into the **F2 control fuse holder** with the screwdriver slot pointing toward the power transformer.
8. Using a small screwdriver, press the cap down into the fuse holder body and turn the cap  $\frac{1}{4}$  turn clockwise to lock the cap in place. This results in the cap slot pointing toward the top and bottom of the box.

## CONFIGURING THE MX001 FOR 115 OR 230 VOLT OPERATION

---

### Europe/Asia: 115V Operation

1. Move the voltage selector to the right with a small screwdriver so that the 115V legend shows in the window.
2. Open the fuse kit and remove the following:
  - (2) Black Fuse Holder Caps
  - (1) 6.3 Amp 250V Fast Acting, High Interrupt 5 x 20mm Fuse
  - (1) 125mA 250V Time Delay 5 x 20mm Fuse
3. Press the end of the 6.3 Amp fuse into one of the black fuse holder caps until it seats.
4. Insert the fuse and cap into the **F1 TRIAC fuse holder** with the screwdriver slot pointing toward the power transformer.
5. Using a small screwdriver, press the cap down into the fuse holder body and turn the cap  $\frac{1}{4}$  turn clockwise to lock the cap in place. This results in the cap slot pointing toward the top and bottom of the box.
6. Press the end of the 125mA fuse into the other black fuse holder cap until it seats.
7. Insert the fuse and cap into the **F2 control fuse holder** with the screw driver slot pointing toward the power transformer.
8. Using a small screwdriver, press the cap down into the fuse holder body and turn the cap  $\frac{1}{4}$  turn clockwise to lock the cap in place. This results in the cap slot pointing toward the top and bottom of the box.

## LOCATING THE THREE STRAIN RELIEFS AND THE SIGNAL CONNECTOR

---

There are three strain reliefs and one 8-pin signal connector located on the bottom of the MX001 box. The two large strain reliefs on the left side allow the use of flexible cordage for MX001 power input and controlled power (TRIAC) output in that order. If your application requires the use of conduit for power wiring, these two strain reliefs can be easily removed and standard conduit fittings can be used in their place. The smaller strain relief is used to secure the signal/ power cable from the object sensor that is a user supplied part. The 8-pin signal connector is used to connect the MX001 box to the scanner through the scanner link cable.

## CONNECTING EXTERNAL WIRING TO THE MX001

---

External wiring is connected to the MX001 by means of “lift clamp” terminal blocks. These blocks have an opening in their base that will accept a wire with ¼ inch of insulation removed. Connections are made by first turning the terminal's binding screw counterclockwise with a small screwdriver which “opens” the terminal allowing it to accept the wire. The stripped wire is then inserted into the opening in the terminal and then clamped in place by turning the associated terminal screw clockwise until tight.

There are two sets of terminal blocks inside the MX001. The larger set of 6 terminals on the left of the voltage selector switch handle the AC power wiring while the smaller set of 6 terminals on the right handle the sensor wiring.

Two terminals mounted on the MX001 enclosure near the protective earthing symbol are intended to be used for ground connection of the AC power input cable and TRIAC controlled power output cable.



## POWER REQUIREMENTS FOR THE MX001

---

The MX001 control box neither supplies nor draws operating power from the scanner to which it is connected. It contains an independent, regulated and totally isolated 12 volt DC power supply that is used to drive the (optocoupled) sensor and TRIAC signal circuit links to the scanner. Therefore, the MX001 must be powered from the AC line at all times to allow it to communicate with the scanner.

## CONNECTING THE AC POWER INPUT CABLE

1. Make sure power is not being applied to the power cable that is to be connected to the unit.
2. Open the terminals in the **power terminal block** by turning each screw counterclockwise until there is enough space to insert wires.
3. Strip off 1 ¼ inches of the power cable's outer jacket.
4. Strip the insulation off each cable wire ¼ of an inch.
5. Feed the power cable through the first, large strain relief on the left.
6. Connect each wire to the appropriate locations noted in the table below and secure the wires in the terminal block and protective earthing terminal by turning each screw clockwise. (Refer to the MX001 box or to Figure 4 for the order of the terminals for the power wires.)
7. Secure the cable by turning the strain relief's domed sealing nut clockwise until tight.

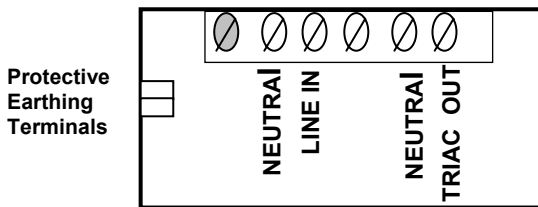

Figure 4

**NOTE:** Do not connect any wires to the first terminal.

Terminal Block	Cable Color in USA and Canada	Cable Color in Europe
Neutral Line In	White Black	Blue Brown
Protective Earthing Terminals	Cable Color in USA and Canada	Cable Color in Europe
Ground	Green	Yellow-Green

## CONNECTING THE TRIAC CONTROLLED POWER OUTPUT CABLE

The MX001 box contains a power line TRIAC that acts as an electronic power output switch operated by the scanner and capable of controlling a current load of 6 amps in the USA. In Europe, the maximum current load supported is 5 Amps. The TRIAC controlled output voltage equals the line input voltage when the scanner activates the TRIAC. How the TRIAC will operate is defined by the HoloSet Program.

1. Make sure power is not being applied to the unit.
2. Open the terminals in the **TRIAC terminal block** by turning each screw counterclockwise until there is enough space to insert wires.
3. Strip off 1 ¼ inches of the power output cable's outer jacket.
4. Strip the insulation off each cable wire ¼ of an inch.
5. Feed the power output cable through the second large strain relief.
6. Connect each wire to the appropriate locations noted in the table below and secure the wires in the terminal block and protective earthing terminal by turning each screw clockwise. (*Refer to the MX001 box or to figure 5 for the order of the terminals for the TRIAC wires.*)

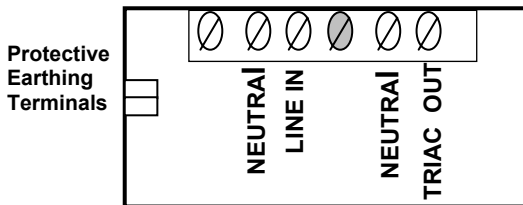

Figure 5

**Note:** Do not connect any wires to the fourth terminal.

Terminal Block	Cable Color in USA and Canada	Cable Color in Europe
Neutral Line In	White Black	Blue Brown
Protective Earthing Terminals	Cable Color in USA and Canada	Cable Color in Europe
Ground	Green	Yellow-Green

**Caution:** Damage will occur to the unit if the TRIAC output is shorted.

## TEMPORARILY DISABLING THE TRIAC OUTPUT

---

If, during set up or maintenance, there is a need to disable the TRIAC output of the MX001, simply remove the F1 TRIAC fuse. This disconnects the AC line voltage from the TRIAC circuitry and output terminal block, but leaves the TRIAC LED indicator active allowing checks to be made for TRIAC circuit activity without activating the TRIAC controlled device.



## SENSOR SUPPORT

---

There are many different types of sensors available, which will work with the MX001 control box.

Common types:

1. Sensors powered independently which provide 12V, 5V, or a 10mA DC output signal (sourcing type output).
2. Sensors that provide switch closures or relay type outputs.
3. Low voltage, self-contained DC sensors that provide current sourcing and/or sinking type outputs.
4. "Universal" self-contained sensors that provide a single pole, double throw (SPDT) relay output.

In all cases, the sensor's output signal or switch closure is expected to become active when an object has been sensed.

The easiest sensor to use with the MX001 is a low voltage (a 10-30 volt) DC, self contained, sensor. The industrial control box can power this type of sensor with 12V DC at 200 mA maximum and will interface to either a (PNP) current sourcing, or (NPN) current sinking output. (Current sourced or sunk = 10 mA.) A switch closure (relay) type output is also supported. All output types are expected to become active when an object has been sensed.

Additionally, some sensors also provide an "alarm" output that warns the user when sensing conditions are becoming marginal. This optional output is also supported through the MX001. The option forces the scanner to emit a repetitive warning tone when the sensor's alarm output becomes active.

How the sensor interacts with the scanner depends upon which sensor options were chosen in the HoloSet program. Refer to that manual for further details.

### **Connecting the Sensor**

Reference the documentation that came with your sensor to determine the function of each sensor wire. Then, refer to one of the procedures on the following pages that apply to your sensor for information on how to hook up the appropriate wires and position the configuration jumper on the appropriate pins of its header. If your sensor supports the alarm function, begin looking for the procedure for your sensor on page 22.

### **Temporarily Disabling the Sensor and/or Sensor Alarm**

If, during set up or maintenance, there is a need to disable the sensor and/or sensor alarm inputs of the MX001, proceed as follows:

- To disable the sensor, position the J1 (S SET UP) jumper on pins 2 and 3 of its header.
- To disable the sensor alarm, position the J2 (A SETUP) jumper on pins 2 and 3 of its header.

These procedures disconnect the sensor's output signals from the MX001's input circuitry without physically disconnecting any sensor wiring.

### Sensors Powered Independently that Provide Either 12V, 5V or a 10mA DC Output Signal

1. Make sure power is not being applied to the unit.
2. Open the terminals in the **sensor terminal block** by turning each screw counterclockwise until there is enough space to insert wires.
3. Strip off 2 ¼ inches of the sensor cable's outer jacket.
4. Strip the insulation off each cable wire ¼ of an inch.
5. Feed the sensor cable through the small strain relief.
6. Insert the sensor's DC common (or negative) output wire into the S IN- terminal block and secure the wire by turning the terminal's screw clockwise. *(Refer to the MX001 box or Figure 6 for the order of the terminals for the sensor wires)*
7. Insert and secure the sensor's positive output wire to the **S IN+** terminal.
8. Secure the cable by turning the strain relief's domed sealing nut clockwise until tight.
9. Depending upon your sensor's output, perform one of the following steps.
  - For a 12V DC output signal, position the jumper on pins 1 and 2 of the J1 (S SET UP) header. *(Refer to Figure 7)*
  - For a 5V DC output signal, position the jumper on pins 3 and 4 of the J1 (S SET UP) header. *(Refer to Figure 7)*
  - For a 10mA DC output signal, position the jumper on pins 4 and 5 of the J1 (S SET UP) header. *(Refer to Figure 7)*

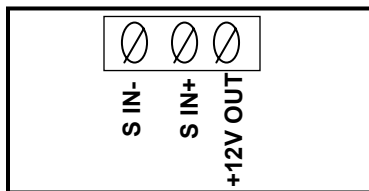

Figure 6

**Sensors Powered Independently that Provide Either 12V, 5V or a 10mA DC Output Signal**

**Caution:** When configured for a 10mA DC source input, the MX001 box expects a current limited 10 mA DC signal to be supplied by the sensor. Failure to limit this current to 10mA can damage the sensor input circuitry of the system.

Current limiting can be accomplished by using an external limiting resistor of the appropriate value (which is dependent upon the sensor's DC signal output voltage level). This resistor is connected between the S IN+ input of the MX001 box and the sensor.

$$\text{Approximate Resistance} = \frac{\text{Sensor Output Voltage} - 3V}{10\text{mA}}$$

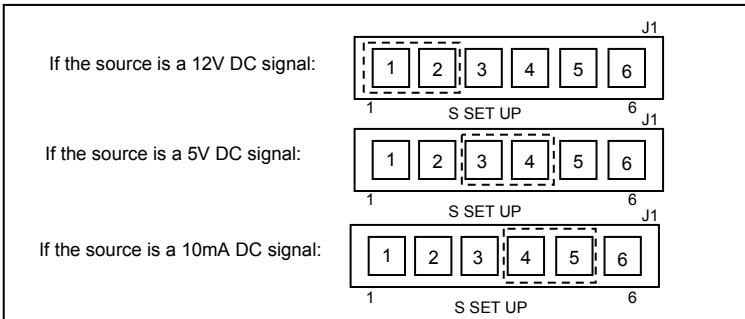

Figure 7

## Sensors that Provide Switch Closures or Relay Type Output

1. Make sure power is not being applied to the unit.
2. Open the terminals in the sensor terminal block by turning each screw counterclockwise until there is enough space to insert wires.
3. Strip off 2 ¼ inches of the sensor cable's outer jacket
4. Strip the insulation off each cable wire ¼ of an inch.
5. Feed the sensor cable through the small strain relief.
6. Insert one of the sensors signal output wires into the **COMMON** terminal and secure the wire by turning the terminal's screw clockwise. (Refer to the *MX001* box or to *Figure 8* for the order of the terminals for the sensor wires.)
7. Insert and secure the sensor's other signal output wire into the **S IN-** terminal.
8. Secure the cable by turning the strain relief's domed sealing nut clockwise until tight.
9. Position the jumper on pins **5** and **6** of the **J1 (S SET UP)** header. (Refer to *Figure 9*).

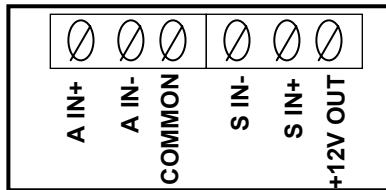

Figure 8

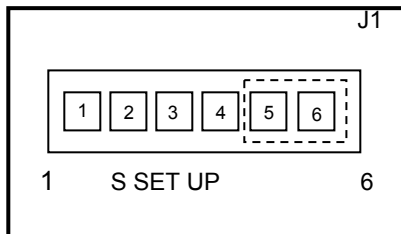

Figure 9

## Low Voltage Self-Contained DC Sensors with a Current Sinking Output

1. Make sure power is not being applied to the unit.
2. Open the terminals in the **sensor terminal block** by turning each screw counterclockwise until there is enough space to insert wires.
3. Strip off 2 ¼ inches of the sensor cable's outer jacket.
4. Strip the insulation off each cable wire ¼ of an inch.
5. Feed the sensor cable through the small strain relief.
6. Inserts the sensor's DC common wire into the **COMMON** terminal and secure the wire by turning the terminals's screw clockwise. (Refer to the *MX001* box or to *Figure 10* for the order of the terminals for the sensor wires.)
7. Insert and secure the sensor's +DC power input wire into the **+12V OUT** terminal.
8. Insert and secure the sensor's signal output wire into the **S IN-** terminal.
9. Secure the cable by turning the strain relief's domed sealing nut clockwise until tight.
10. Position the jumper on pins **5** and **6** of the **J1 (S SET UP)** header. (Refer to *Figure 11*).

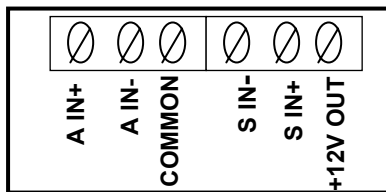

Figure 10

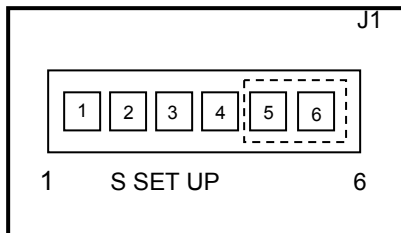

Figure 11

## Low Voltage Self-Contained DC sensors with a Current Sourcing Output

1. Make sure power is not being applied to the unit.
2. Open the terminals in the **sensor terminal block** by turning each screw counterclockwise until there is enough space to insert wires.
3. Strip off 2 ¼ inches of the sensor cable's outer jacket.
4. Strip insulation off each cable wire ¼ of an inch.
5. Feed the sensor cable through the small strain relief.
6. Connect a small jumper wire between the **COMMON** and the **S IN-** terminals. Secure the jumper wire in the **S IN-** terminal by turning the terminal's screw clockwise. (Refer to the MX001 box or to Figure 12 for the order of the terminals for the sensor wires.)
7. Connect the sensor's DC common wire to the **COMMON** terminal and secure the sensor and jumper wire by turning the terminal's screw clockwise.
8. Insert and secure the sensor's +DC power input wire into the **+12V OUT** terminal.
9. Insert and secure the sensor's sourcing output wire into the **S IN+** terminal.
10. Secure the cable by turning the strain relief's domed sealing nut clockwise until tight.
11. Position the jumper on pins **1** and **2** of the **J1 (S SET UP)** header. (Refer to Figure 13).

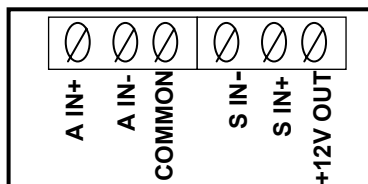

Figure 12

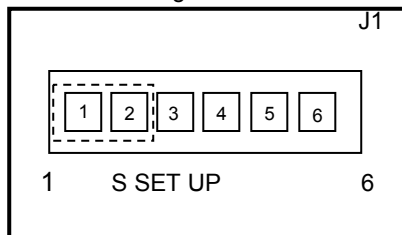

Figure 13

### “Universal” Self-Contained Sensors that Provide a Single Pole/Double Throw (SPDT) Relay Output

1. Make sure the “universal” sensor can operate on +12 volts DC at 200mA or less. If so, then the MX001 box can supply the +12 volts necessary to power the “universal” sensor.
2. Make sure power is not being applied to the unit.
3. Open the terminals in the **sensor terminal block** by turning each screw counterclockwise until there is enough space to insert wires.
4. Strip 2 ¼ inches of the sensor cable’s outer jacket
5. Strip the insulation off each cable wire ¼ of an inch.
6. Feed the sensor cable through the small strain relief.
7. Insert the sensor’s +DC power input wire into the **+12V OUT** terminal and secure the wire by turning the terminal’s screw clockwise. (*Refer to the MX001 box or to Figure 14 for the order of the terminals for the sensor wires.*)
8. Insert the sensor’s –DC or common power input wire and the relay output common signal wire into the **COMMON** terminal and secure both wires.
9. Determine from the literature supplied with your sensor which sensor relay output makes contact with its common terminal when an object is sensed. If the output cannot be determined, go on to Step 10. Otherwise, skip to Step 11.
10. Temporarily apply power to the MX001 box to activate the sensor and then determine with a continuity tester or ohm meter which relay output (the normally closed [NC] or the normally open [NO] output) make contact with the **COMMON** terminal when the sensor “sees” the object to be scanned.
11. Remove any power applied to the MX001 (in Step 10) and connect and secure the relay output wire previously determined to the **S IN-** terminal. (The other relay output wire may be cut off or connected to the MX001 **COMMON** terminal if desired).
12. Secure the cable by turning the strain relief’s domed sealing nut clockwise until tight.



**“Universal” Self-Contained Sensors that Provide a Single Pole/Double Throw (SPDT) Relay Output**

- 13. Position the jumper on pins 5 and 6 of the **J1 (S SET UP)** header. (Refer to Figure 15).

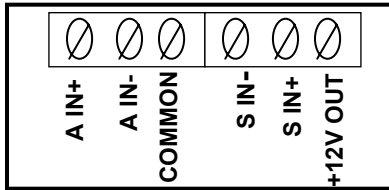

Figure 14

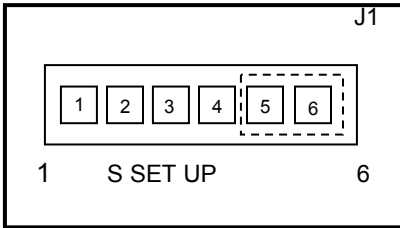

Figure 15

### Sensors Powered Independently that Provide Either 12V, 5V or a 10mA DC Output Signal with a Sensor Alarm

1. Make sure power is not being applied to the unit.
2. Open the terminals in the **sensor terminal block** by turning each screw counterclockwise until there is enough space to insert wires.
3. Strip off 2 ¼ inches of the sensors cable's outer jacket.
4. Strip the insulation off each cable wire ¼ of an inch.
5. Feed the sensor cable through the small strain relief.
6. Insert the sensor's DC common (or negative) output wire into the **S IN-** terminal block and secure the wire by turning the terminal's screw clockwise. (*Refer to the MX001 box or to Figure 16 for the order of the terminals for the sensor wires.*)
7. Insert and secure the sensor's positive output wire into the **S IN+** terminal.
8. Insert and secure the sensor's alarm DC common (or negative) output wire into the **A IN-** terminal and the sensor's alarm positive output wire into the **A IN+** terminal.
9. Secure the cable by turning the strain relief's domed sealing nut clockwise until tight.
10. Depending upon your sensor's output, perform one of the of the following steps:

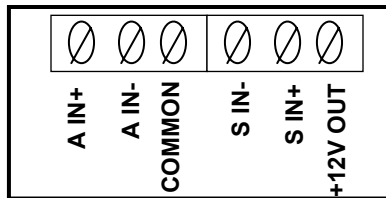

Figure 16

**Sensors Powered Independently that Provide Either 12V, 5V or a 10mA DC Output Signal with a Sensor Alarm**

- For 12V DC output signals, position the jumpers on pins **1** and **2** of the **J1 (S SET UP)** and **J2 (A SET UP)** headers. (Refer to Figure 17)
- For 5V DC output signals, position the jumpers on pins **3** and **4** of the **J1 (S SET UP)** and **J2 (A SET UP)** headers. (Refer to Figure 17)
- For 10mA DC output signals, position the jumpers on pins **4** and **5** of the **J1 (S SET UP)** and **J2 (A SET UP)** headers. (Refer to Figure 17)

**Caution:** When configured for a 10mA DC source input, the MX001 box expects a current limited 10 mA DC signal to be supplied by the sensor. Failure to limit this current to 10 mA can damage the sensor input circuitry of the system.

Current limiting can be accomplished by using external limiting resistors of an appropriate value (which are dependent upon the sensor's DC signal output voltage level). One resistor is connected between the **S IN+** input of the MX001 box and the sensor. The other resistor is connected between the **A IN+** input of the MX001 box and the sensor (for the sensor alarm circuit).

$$\text{Approximate Resistance} = \frac{\text{Sensor Output Voltage} - 3V}{10 \text{ mA}}$$

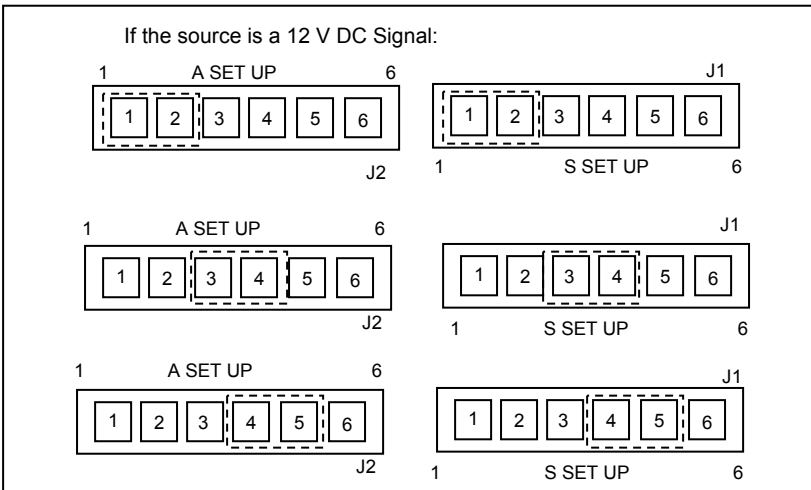

Figure 17

## Sensors that Provide Switch Closures or Relay Type Output with a Sensor Alarm

1. Make sure power is not being applied to the unit.
2. Open the terminals in the sensor terminal block by turning each screw counterclockwise until there is enough space to insert wires.
3. Strip off 2 ¼ inches of the sensor cable's outer jacket.
4. Strip the insulation off each cable wire ¼ of an inch.
5. Feed the sensor cable through the small strain relief.
6. Insert one of the sensor's signal output wires and one of the sensor's alarm output wires into the **COMMON** terminal and secure the wires by turning the terminal's screw clockwise. (Refer to the MX001 box or to Figure 18 for the order of the terminals for the sensor wires.)
7. Insert and secure the sensor's remaining signal output wire into the **S IN-** terminal.
8. Insert and secure the sensor's remaining alarm output wire into the **A IN-** terminal.
9. Secure the cable by turning the strain relief's domed sealing nut clockwise until tight.
10. Position the jumpers on pins **5** and **6** of the **J1 (S SET UP)** and **J2 (A SET UP)** headers. (Refer to Figure 19)

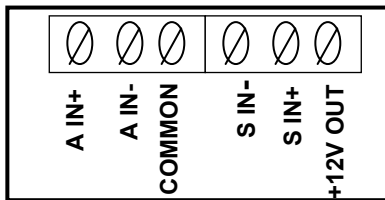

Figure 18

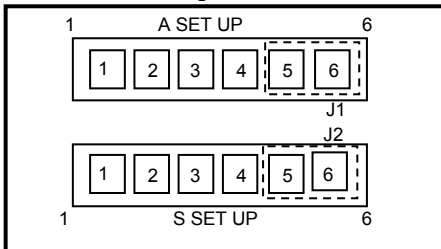

Figure 19

## Low Voltage Self-Contained DC Sensors with Current Sinking Outputs and Sensor Alarm

1. Make sure power is not being applied to the unit.
2. Open the terminals in the sensor terminal block by turning each screw counterclockwise until there is enough space to insert wires.
3. Strip off 2 ¼ inches of the sensor cable's outer jacket.
4. Strip the insulation off each cable wire ¼ of an inch.
5. Feed the sensor cable through the small strain relief.
6. Insert the sensor's DC common wire into the **COMMON** terminal and secure the wire by turning the terminal's screw clockwise. (Refer to the MX001 box or to Figure 20 for the order of the terminals for the sensor wires.)
7. Insert and secure the sensor's +DC power input wire into the **+12V OUT** terminal.
8. Insert and secure the sensor's signal output wire into the **S IN-** terminal.
9. Insert and secure the sensor's alarm signal output wire into the **A IN-** terminal.
10. Secure the cable by turning the strain relief's domed sealing nut clockwise until tight.
11. Position the jumpers on pins **5** and **6** of the **J1 (S SET UP)** and **J2 (A SET UP)** headers. (Refer to figure 21).

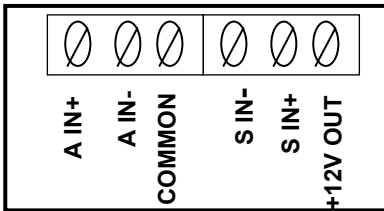

Figure 20

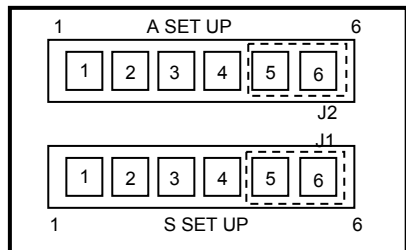

Figure 21

## Low Voltage Self-Contained DC Sensors with Current Sourcing Output and Sensor alarm

1. Make sure power is not being applied to the unit.
2. Open the terminals in the **sensor terminal block** by turning each screw counterclockwise until there is enough space to insert wires.
3. Strip off 2 ¼ inches of the sensor cable's outer jacket.
4. Strip the insulation off each cable wire ¼ of an inch.
5. Feed the sensor cable through the small strain relief.
6. Connect a small jumper wire between the **COMMON** and the **S IN-** terminals and secure the jumper in the **S IN-** terminal by turning the terminal's screw clockwise. (Refer to the *MX001* box or to *Figure 22* for the order of the terminals for the sensor wires.)
7. Connect a small jumper wire between the **COMMON** and the **A IN-** terminal and secure the jumper in the **A IN-** terminal.
8. Connect the sensor's DC common wire to the **COMMON** terminal and secure the jumpers and wire by turning the terminal's screw clockwise.
9. Insert and secure the sensor's +DC power input wire into the **+12V OUT** terminal.
10. Insert and secure the sensor's signal output wire into the **S IN+** terminal.
11. Insert and secure the sensor's alarm output wire into the **A IN+** terminal. Secure the cable and turn the strain relief's domed sealing nut clockwise until tight.
12. Position the jumpers on pins **1** and **2** of the **J1 (S SET UP)** and **J2 (A SET UP)** headers. (Refer to *Figure 23*)

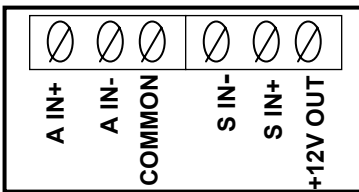

Figure 22

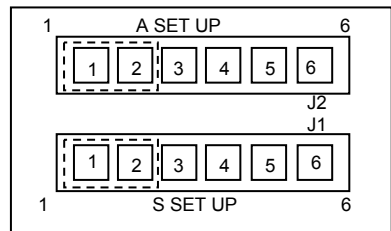

Figure 23

### **“Universal” Self-contained Sensors That Provide Single Pole/Double Throw (SPDT) Relay Outputs for Both Object Sensing and Sensor Alarm**

1. Make sure the “universal” sensor can operate on +12 volts DC at 200ma or less. If so, then the MX001 box can supply the +12 volts necessary to power the “universal” sensor.
2. Make sure power is not being applied to the unit.
3. Open the terminals in the sensor terminal block by turning each screw counterclockwise until there is enough space to insert wires.
4. Strip off 2 ¼ inches of the sensor cable’s outer jacket.
5. Strip the insulation off each cable wire ¼ of an inch.
6. Feed the sensor cable through the small strain relief.
7. Insert the sensor’s +DC power input wire into the **+12V OUT terminal** and secure the wire by turning the terminal’s screw clockwise. *(Refer to the MX001 box or to figure 24 for the order of the terminals for the sensor wires.)*
8. Insert the sensor’s -DC or common power input wire and both the object sense and alarm relay output common signal wires into the **COMMON** terminal and secure all three wires.
9. Determine from the literature supplied with your sensor which sensor relay output makes contact with its common terminal when an object is sensed. If the output cannot be determined, go on to Step 10. Otherwise, skip to Step 11.
10. Temporarily apply power to the MX001 box to activate the sensor and then determine with a continuity tester or ohm meter which relay output (the normally closed [NC] or the normally open {NO} output) makes contact with the **COMMON** terminal when the sensor “sees” the object to be scanned.
11. Remove any power applied to the MX001 (in Step 10) and connect and secure the “sense” relay output wire previously determined to the **S IN**-terminal. (The other sense relay output wire may be cut off or connected to the MX001 **COMMON** terminal if desired).

## “Universal” Self-contained Sensors That Provide Single Pole/Double Throw (SPDT) Relay Outputs for Both Object Sensing and Sensor Alarm

12. Determine from the literature supplied with your sensor which sensor alarm relay output makes contact with its common terminal when sensing conditions become marginal. If the output cannot be determined, go on to Step 13. Otherwise, skip to Step 14.
13. Temporarily apply power to the MX001 box again to activate the sensor and try to make sensing conditions marginal by placing the object to be sensed at a greater than normal distance from the sensor or misalign the sensor to activate the sensor’s alarm output. (Most sensors have a small indicator that shows when the alarm output is active by being either on or off depending upon the type of sensor.) Determine with a continuity tester or ohm meter which relay output (the normally closed [NC or the normally open {NO} output) makes contact with the **COMMON** terminal when the sensor indicates that its alarm output is active.
14. Remove any power applied to the MX001 box (in Step 13) and connect and secure the “alarm” relay output wire previously determined to the **A IN-** terminal. (The other alarm relay output wire may be cut off or connected to the MX001 **COMMON** terminal if desired.)
15. Secure the cable by turning the strain relief’s domed sealing nut clockwise until tight.
16. Position the jumpers on pins **5** and **6** of the **J1 (S SET UP)** and **J2 (A SET UP)** headers (Refer to Figure 25).

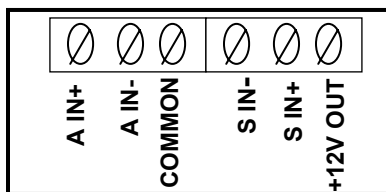

Figure 24

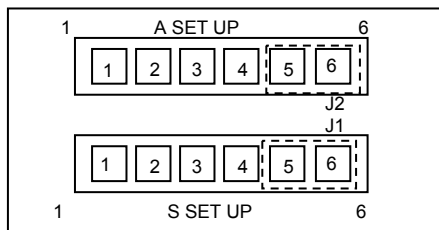

Figure 25



## CLOSING THE MX001 INDUSTRIAL CONTROL BOX

---

1. Close the lid of the MX001 box.
2. Rotate the clamp clockwise while pushing down on the lid. Then move the clamp to the right, positioning it over the ledge on the lid.
3. Fasten the clamp in place by tightening its screw with a flat blade screwdriver.

## CONNECTING THE MX001 TO THE SCANNER

---

The supplied, scanner link cable is used to connect the MX001 box to a TECH series scanner. This one meter cable carries the MX001's control signals and is terminated with an 8 and a 19 pin connector. (Other cable lengths are available, contact Metrologic for details.)

1. Find the 8-pin male end of the scanner link cable and locate the wide connector key found above pins A and G. Align this key with the corresponding key on the MX001's signal connector. Push in on the cable connector slightly and rotate its ring clockwise until the connector locks in place with a click.
2. Likewise, the 19-pin female connector found on the other end of this cable is connected to the 19-pin male connector on the scanner case. This connector is the one closest to the scanner window.

## CABLE PIN OUTS FOR THE 8-PIN AND 19-PIN CONNECTORS

The standard scanner link cable length is 3 feet – 1 meter. Other scanner link cable lengths are available upon request. Contact Metrologic Customer Service for additional details.

If there is a need to lengthen the scanner link cable, use a cable with #26 wire. The scanner link cable can be easily extended to 100 feet without signal difficulty. The following are listings of the cable pin outs for the 19-pin female and the 8-pin male ends of the link cable. (Refer to Figures 26 and 27)

### 19-Pin Female Mil Spec Connector

Pin	Function
A	TRIAC1+
B	TRIAC1-
C-L	RESERVED
M	SENSOR+
N	SENSOR-
P	SENSE ALARM+
R	SENSE ALARM-
S-V	RESERVED

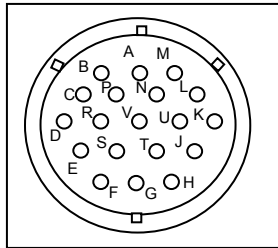

Figure 26

### 8-Pin Male Mil Spec Connector

Pin	Function
A	TRIAC+
B	TRIAC-
C	SENSOR+
D	SENSOR-
E	SENSE ALARM/AUX+
F	SENSE ALARM/AUX-
G	RESERVED
H	RESERVED

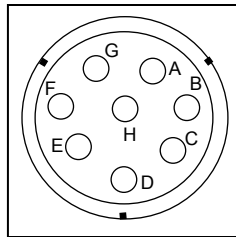

Figure 27

## SPECIFICATIONS

---

MX001 Specifications	
Application:	Industrial Control Interface
Orientation:	L-bracket with TECH scanner or independently mounted
Dimensions:	152mm L x 102mm W x 76mm D (6" x 4" x 3")
Weight:	1.36 Kg (93 lbs.)
Case Material:	Oil Tight J1C box
Electrical:	12 V at 200mA for low voltage DC type object sensor
System Interfaces:	6 Amp TRIAC output (5 Amp in Europe) 12V, 5V, 10mA or switch closure object sensor input
Status Indicators:	Four LED's for: 12V Power supply, TRIAC, sensor and sensor alarm
UL, CSA and IEC:	UL and CUL listed, CE

Specifications are subject to change without notice.

### No Operation – Green LED off:

1. Check power input wiring for correct connection and security at power terminal block. (Wires must be stripped before insertion into the terminal block and terminal block screws must be tight, clamping the stripped wire firmly in the block.)
2. Check for AC power input between **LINE IN** and **NEUTRAL** terminals of the power terminal block.
3. Check F2 Control fuse.

### F2 Control Fuse Open:

1. Review the MX001 manual detailing the fuse installation procedure and check the **F2 Control fuse** for correct rating. (Depends upon line voltage in use.)
2. If a low voltage DC type sensor is connected to the MX001 and is using the MX001 as its power source (**+12V OUT** in use), make sure this sensor does not draw more than 200mA of current from the MX001 or that the sensor is incorrectly connected or shorted.

### No Operation Sensor & TRIAC with Green LED on (other LED's do not light):

1. Check that the scanner link cable is connected to the MX001 and scanner.
2. Check the connection of the MX001 internal link cable to the printed circuit board at **J3** (Lower right corner).
3. Check for proper connection of the sensor (if used) plus proper positioning of the **S** and **A** set up jumpers at **J1** and **J2**. (Depends upon sensor type.)
4. Check for proper HoloSet programming of the TRIAC. (To check TRIAC output, temporarily program the scanner via HoloSet to support only the TRIAC with **TRIAC Normally On**. This will activate the red TRIAC LED and the TRIAC output continuously.)

### No TRIAC Output with Red TRIAC LED On:

1. Check that the TRIAC load is properly connected to the **TRIAC terminal block**. (Wires must be stripped before insertion into the terminal block and terminal block screws must be tight, clamping the stripped wire firmly in the block.)
2. Check for AC power output between the **TRIAC OUT** and **NEUTRAL** terminals of the **TRIAC terminal block** when the TRIAC LED is on.
3. Check the fuse in the F1 **TRIAC fuse holder**.

### F1 TRIAC Fuse Open:

1. Review the section detailing the fuse installation procedure and check the **F1 TRIAC** fuse for correct rating (10 or 6.3 Amps). Make sure one of the **F2 CONTROL** fuses have not been installed in place of the correct **TRIAC fuse**.
2. Check that the TRIAC load has been properly connected to the **TRIAC terminal block** and does not draw current greater than the rating of the **F1 TRIAC fuse** installed (10 Amp in USA or 6.3 Amp in Europe/Asia).
3. Check that the TRIAC load does not draw an excessively large surge or start up current that is beyond the capabilities of the MX001 fuse rating.
4. Check to make sure the TRIAC load is not or has not been accidentally shorted. If a short is found, remove the short and check for proper TRIAC operation after installing a new **F1 TRIAC fuse**. (See item 5.)
5. Disconnect the normal TRIAC load and temporarily connect a 60W light bulb in a wired test socket to the TRIAC output. If the bulb does not light when the red LED TRIAC indicator is on after a new fuse has been installed or if the bulb lights continuously with the red LED TRIAC indicator off, then MX001 TRIAC circuit damage is indicated. The Mx001 can be damaged if the TRIAC output is accidentally shorted.

**NOTE:** TRIAC load refers to the device that is connected by the MX001 TRIAC.

### **TRIAC Output Active with Red TRIAC LED off:**

Tests for AC power output from the TRIAC should only be made when a device or load is connected between the **TRIAC OUT** and **NEUTRAL** terminals of the **TRIAC terminal block**. Attempting to measure output voltage with nothing connected to the TRIAC terminal block will result in a false output reading which may show partial or full line voltage present at all times. This is due to the TRIAC snubber circuit in the MX001 that protects the TRIAC from surge damage due to inductive loads. This circuit produces a small amount of AC output (5mA) at the **TRIAC terminal block** that can be measured when no load is connected there but is of no consequence otherwise.

To test properly for AC power output from the TRIAC, temporarily connect a 60W light bulb in a wired test socket to the **TRIAC output**. This lamp will provide a proper load for the TRIAC. If the bulb lights when the red LED TRIAC indicator is **OFF**, then MX001 circuit damage is indicated as the problem. The unit can be damaged if the **TRIAC output** is accidentally shorted.

### **No Sensor Input Indication (Red S in LED does not light):**

1. Review the documentation that came with your sensor to learn the type of output the sensor provides. Review the MX001 manual and find the set up procedure that applies to your sensor. Check for proper connection of the sensor to the MX001 sensor terminal block plus proper positioning of the **S** set up jumper **J1**. (Depends upon sensor type in use.)
2. Check your sensor for output indication. Most sensors have a small indicator on them or their controller that lights when the sensor output is active. Make sure the sensor is active when expected.
3. Check the positioning of the sensor making sure it is oriented correctly.
4. Check sensor gain/sensitivity adjustment for correctness. Most sensors provide this adjustment to adapt to various sensing conditions. Check to see if the gain/sensitivity is not set too low in diffuse proximity type sensors or not set too high in beam break type sensors. Review the documentation that came with your sensor to learn how to make this adjustment correctly.
5. Make sure the MX001 scanner link cable is connected to both the scanner and the MX001.

### **Reversed Sensor Input Indication (Red S in LED goes off when object is sensed):**

1. Some sensors provide the option of output activation when they sense or do **not** sense an object. Having the sensor set up to produce an output when it does **not** sense an object will result in reversed sensing conditions. The MX001 expects to receive an active output signal from the sensor (source voltage/current or switch closure) when the object to be scanned is being sensed. Review the documentation that came with your sensor to learn what type of output it provides and how to configure it.
2. Some sensors that provide switch closure type output provide both normally open (NO) and normally closed (NC) switched outputs. If the sensor as connected is providing a reversed sensing condition (switch closure when **no** object is being sensed), disconnect the switched output used and connect the other switched output in its place.
3. If the sensor in use provides an output **only** when an object is **not** being sensed and cannot be configured otherwise, contact Metrologic for special instructions on how to adapt to this type of sensor.

### **Erratic Sensor Operation:**

1. Check the sensor wiring for correct connection and security at the sensor terminal block. (wires must be stripped before insertion into the terminal block and terminal block screws must be tight, clamping the stripped wire firmly in the block.)
2. Check the positioning of the sensor making sure it is oriented correctly and not dirty.
3. Check sensor gain/sensitivity adjustments for correctness. Most sensors provide this adjustment to adapt to various sensing conditions. Review the documentation that came with your sensor to learn how to make this adjustment correctly. If this adjustment is made incorrectly, the sensor will act erratically.

### Continuous Sensor Input Indication (Red S IN LED continuously on):

1. Review the documentation that came with your sensor to learn the type of output the sensor provides. Review the MX001 manual and find the set up procedure that applies to your sensor. Check for proper connection of the sensor to the MX001 sensor terminal block plus proper positioning of the **S** set up jumper at **J1**. (Depends upon sensor type in use.)
2. Check your sensor for output indication. Most sensors have a small indicator on them or their controller that lights when the sensor output is active. Make sure the sensor is not providing a continuous output.
3. Some sensors provide the option of output activation when they sense or do **not** sense an object. Having the sensor set up to produce an output when it does **NOT** sense an object will result in continuous sensor output when the sensor is idle. Review the documentation that came with your sensor to learn what type of output it provides and how to configure it. The MX001 box expects to receive an active output signal from the sensor (source voltage/current or switch closure) when an object to be scanned is being sensed.
4. Check sensor gain/sensitivity adjustment for correctness. Most sensors provide this adjustment to adapt to various sensing conditions. Check to see if the gain/sensitivity is not set too low in beam break type sensors or not set to high in diffuse proximity type sensors. Review the documentation that came with your sensor to learn how to make this adjustment correctly.

### Continuous Sensor Alarm Indication (Red A IN LED continuously on):

1. Review the documentation that came with your sensor to learn the type of alarm output the sensor provides. Review the MX001 manual and find the set up procedure that applies to your sensor. Check for proper connection of the sensor alarm output to the MX001 sensor terminal block plus proper positioning of the **A** Set Up jumper at **J2**. The MX001 expects to receive an active alarm output signal from the sensor (source voltage/current or switch closure) when sensing conditions have become marginal.
2. If the sensor in use provides an alarm output **only** when sensor conditions are **not** marginal and cannot be configured otherwise, contact Metrologic for special instructions on how to adapt to this type of sensor.



### **Erratic Sensor Alarm Indication (Red A IN LED blinks):**

1. Check the positioning of the sensor to make sure it is oriented correctly.
2. Check to see if the sensor is dirty and clean it if necessary.
3. Check sensor gain/sensitivity adjustment for correctness. Most sensors provide this adjustment to adapt to various sensing conditions. Review the documentation that came with your sensor to learn how to make this adjustment correctly. If this adjustment is made incorrectly, the sensor may produce an erratic alarm output.

### **Scanner cannot be placed in program mode using HoloSet label:**

1. Disconnect then reconnect power to the scanner. Enter scanner program mode by choosing **Enter Program Mode** from the HoloSet Main Menu.
2. If the scanner has been programmed for sensor support, the scanner will not scan any label including the HoloSet label unless a sensor is connected to the MX001 box and activated.
3. If the scanner has been programmed to support DTR, the scanner will not scan any label including the HoloSet label unless the DTR input is active.

### **Scanner cannot be placed in program mode using HoloSet menu:**

1. Disconnect then reconnect power to the scanner. Retry entering program mode by choosing **Enter Program Mode** from the HoloSet Main Menu.
2. Check to see if the HoloSet communication cable is plugged into your PC correctly.
3. Make sure the correct COM option (COM 1 or 2 as required) is being used.

### Operational Check Out Procedure for the MX001 Box:

The following procedure provides a basic test of the MX001 hardware and confirms effective communication with the HoloSet program. This quick test should be performed before the MX001 box has been configured by the HoloSet program for its final application. These steps are **not** required for proper installation and application programming of the MX001 box.

1. Do not connect a sensor to the MX001 at this time. Tighten each sensor terminal block screw by turning each screw clockwise.
2. Temporarily place both **S** and **A SET UP** jumpers (**J1** and **J2**) at positions 5 and 6.
3. Connect a standard 60W light bulb in a wired test socket to the TRIAC terminal block at the **TRIAC OUT** and **NEUTRAL** terminals. This lamp will act as a load for the TRIAC. (**Do Not** try to monitor TRIAC output without a load connected.)
4. Connect the MX001 box to the scanner with the scanner link cable.
5. Apply power to both the MX001 and the scanner. The green LED inside the MX001 should light.
6. If a volt meter is available, measure the DC output voltage between the **+12V OUT** and **COMMON** terminals on the sensor terminal block. This voltage should be between 11.5 and 12.5 volts DC.
7. Temporarily program the TECH options of the scanner using HoloSet for the following:
  - Support Line Sensor
  - Support Line Sensor Alarm
  - Support TRIAC
  - TRIAC Normally On
  - Activate on No Read
8. After programming, the MX001's red TRIAC LED should light and the test light bulb should be on.
9. Short the **S IN-** terminal screw to the COMMON terminal screw with a short piece of wire. The red **S IN LED** should light and the test light bulb connected to the TRIAC output should flash off then back on.

## TROUBLESHOOTING

---

10. Short the **A IN-** terminal screw to the **COMMON** terminal screw with a short piece of wire. The red **A IN LED** should light and the scanner should emit a repetitive warning tone as long as this connection is maintained.
11. Disconnect then reconnect power to the scanner. Enter scanner program mode by choosing **Enter Program Mode** from the HoloSet Main Menu. (Do not try to use the HoloSet bar code label at this time) **DISABLE** all TECH options then re-program the scanner. This neutralizes the test program disabling the unconnected sensor inputs and turns the TRIAC output off.
12. If needed, the scanner can now be programmed for your particular application.

## LIMITED WARRANTY

---

The MX001 interface is manufactured by Metrologic at its Blackwood, New Jersey, USA facility. The MX001 interface has a two (2) year limited warranty from the date of manufacture. Metrologic warrants and represents that all MX001 interface is free of all defects in material, workmanship and design, and have been produced and labeled in compliance with all applicable US Federal, state and local laws, regulations and ordinances pertaining to their production and labeling.

This warranty is limited to repair, replacement of Product or refund of Product price at the sole discretion of Metrologic. Faulty equipment must be returned to the Metrologic facility in Blackwood, New Jersey, USA or Puchheim, Germany. To do this, contact Metrologic's Customer Service/Repair Department to obtain a Returned Material Authorization (RMA) number.

In the event that it is determined that the equipment failure is covered under the warranty, Metrologic shall, as its sole option, repair the Product or replace the Product with a functionally equivalent unit and return such repaired or replaced Product without charge for service or return freight, whether distributor, dealer/reseller, or retail consumer, or refund an amount equal to the original purchase price.

This limited warranty does not extend to any Product which, in the sole judgement of Metrologic, has been subjected to abuse, misuse, neglect improper installation, or accident, nor any damage due to use or misuse produced from integration of the Product into any mechanical, electrical or computer system. The warranty is void if the case of Product is opened by anyone other than Metrologic's repair department or authorized repair centers.

THIS LIMITED WARRANTY, EXCEPT AS TO TITLE, IS IN LIEU OF ALL OTHER WARRANTIES OR GUARANTEES, EITHER EXPRESS OR IMPLIED, AND SPECIFICALLY EXCLUDES, WITHOUT LIMITATION, WARRANTIES OF MERCHANTABILITY AND FITNESS FOR A PARTICULAR PURPOSE UNDER THE UNIFORM COMMERCIAL CODE, OR ARISING OUT OF CUSTOM OR CONDUCT. THE RIGHTS AND REMEDIES PROVIDED HEREIN ARE EXCLUSIVE AND IN LIEU OF ANY OTHER RIGHTS OR REMEDIES. IN NO EVENT SHALL METROLOGIC BE LIABLE FOR ANY INDIRECT OR CONSEQUENTIAL DAMAGES, INCIDENTAL DAMAGE, DAMAGES TO PERSON OR PROPERTY, OR EFFECT ON BUSINESS OR PROPERTY, OR OTHER DAMAGES OR EXPENSES DUE DIRECTLY OR INDIRECTLY TO THE PRODUCT, EXCEPT AS STATED IN THIS WARRANTY. IN NO EVENT SHALL ANY LIABILITY OF METROLOGIC EXCEED THE ACTUAL AMOUNT PAID TO METROLOGIC FOR THE PRODUCT. METROLOGIC RESERVES THE RIGHT TO MAKE ANY CHANGES TO THE PRODUCT DESCRIBED HEREIN.

---

### **CORPORATE HEADQUARTERS, NORTH AMERICA**

**Metrologic Instruments, Inc.**  
90 Coles Rd.  
Blackwood, NJ 08012-4683  
Customer Service Department  
Tel: 1-800-ID-METRO  
Fax: 856-228-6673  
Email: [info@metrologic.com](mailto:info@metrologic.com)

### **METROLOGIC EUROPEAN REPAIR CENTER (MERC)**

**Metrologic Eria Ibérica, SL**  
C/Alfonso Gomez, 38-40, 1D  
28037 Madrid  
Tel: +34 913 751 249  
Fax: +34 913 270 437

### **MTLG AUTO ID INSTRUMENTS (SHANGHAI) Co., LTD Suzhou Sales Office**

BLK A, Room# 03/03-04  
No.5 Xinghan Street, Xinsu Industrial Square  
China-Singapore Suahou Industrial Park, Suzhou, PRC  
Tel: 86-512-67622550  
Fax: 86-512-67622560  
Email: [info@cn.metrologic.com](mailto:info@cn.metrologic.com)

## NOTICES

---

Changes or modifications not expressly approved by the party responsible for compliance could void the user's authority to operate the equipment.

### **Class A Devices**

This equipment has been tested and found to comply with limits for a Class A digital device, pursuant to part 15 of the FCC Rules. These limits are designed to provide reasonable protection against harmful interference when the equipment is operated in a commercial environment. This equipment generates, uses and can radiate radio frequency energy and, if not installed and used in accordance with the instruction manual, may cause harmful interference to radio communications. Operation of this equipment in a residential area is likely to cause harmful interference, in which case the user will be required to correct the interference at their own expense. Any unauthorized changes or modifications to this equipment could void the user's authority to operate this device.

This device complies with part 15 of the FCC Rules. Operation is subject to the following two conditions: (1) This device may not cause harmful interference, and (2) this device must accept any interference received, including interference that may cause undesired operation.

### **Notice**

This Class A digital apparatus complies with Canadian ICES-003.

### **Remarque**

Cet appareil numérique de classe A est conforme à la norme canadienne NMB-003.

### **European Standard**

#### **Warning**

This is a class A product. In a domestic environment this product may cause radio interference in which case the user may be required to take adequate measures.

### **Funkstöreigenschaften nach EN55022:1998**

#### **Warnung!**

Dies ist eine Einrichtung der Klasse A. Diese Einrichtung kann im Wohnbereich Funkstörungen verursachen. In diesem Fall kann vom Betreiber verlangt werden, angemessene Massnahmen durchzuführen.

### **Standard Europeo**

#### **Attenzione**

Questo e' un prodotto di classe A. Se usato in vicinanza di residenze private potrebbe causare interferenze radio che potrebbero richiedere all'utilizzatore opportune misure.

#### **Attention**

Ce produit est de classe "A". Dans un environnement domestique, ce produit peut être la cause d'interférences radio. Dans ce cas l'utiliseteur peut être amené à predre les mesures adéquates.

## WORLDWIDE HEADQUARTERS

### Metrologic Instruments, Inc.

90 Coles Rd. Blackwood, NJ 08012-4683 • Email: info@metrologic.com  
Customer Service Tel: 1-800-ID-METRO • Corporate Tel: 856-228-8100  
Fax: 856-228-6673 (Sales) • 856-228-1879 (Marketing) • Fax: 856-228-0653 (Legal/Finance)

#### USA

##### **Omniplanar**

Tel: 856.537.6100  
Fax: 856.537.6116  
Email: info@omniplanar.com

#### USA

##### **NOVODisplay**

Tel: 856.537.6139  
Fax: 856.537.6116  
Email: info@NOVOdisplay.com

#### METROLOGIC - THE AMERICAS

#### USA

##### **Metrologic USA - Headquarters**

Tel: 1.856.537.6400  
Fax: 1.856.537.6474  
Email: info@us.metrologic.com

#### Mexico

##### **Metrologic Mexico, S.A. DE C.V.**

Tel: 55.5365.6247  
Fax: 55.5362.2544  
Email:  
info@mx.metrologic.com

#### South America

##### **Metrologic do Brasil Ltda.**

Tel: 52.55.11.5182.7273  
Fax: 52.55.11.5182.7198  
Email: info@sa.metrologic.com

#### South America

##### **Metrologic South America**

Tel: 1.239.642.1958  
Fax: 1.239.642.1959  
Email: info@sa.metrologic.com

#### METROLOGIC - EMEA

#### Central Europe

##### **Metrologic Instruments GmbH Headquarters**

Tel: 49-89-89019-0  
Fax: 49-89-89019-200  
Email: info@de.metrologic.com

#### France

##### **Metrologic Eria France SA**

Tel: +33 (0) 1 48.63.78.78  
Fax: +33 (0) 1 48.63.24.94  
Email: info@fr.metrologic.com

#### METROLOGIC - EMEA

#### Spain

**Metrologic Eria Iberica, SL**  
Tel: +34 913 272 400  
Fax: +34 913 273 829  
Email: info@es.metrologic.com

#### Russia

##### **Metrologic Instruments LLC**

Tel: +7 (495) 737 7273  
Fax: +7 (495) 737 7271  
Email: info@ru.metrologic.com

#### Italy

##### **Metrologic Instruments Italia**

Tel: +39 0 57 6511978 or  
+39 051 651 1978  
Fax: +39 0 51 6521337  
Email: info@it.metrologic.com

#### Poland

##### **Metrologic Instruments Poland**

Tel: +48 (22) 545 04 30  
Fax: +48 (22) 545 04 31  
Email: info@pl.metrologic.com

#### United Kingdom

##### **Metrologic Instruments UK Limited**

Tel: +44 (0) 1256 365900  
Fax: +44 (0) 1256 365955  
Email: info@uk.metrologic.com

#### METROLOGIC - APAC

#### Asia

##### **Metrologic Asia (Pte) Ltd Headquarters**

Tel: (65) 6842-7155  
Fax: (65) 6842-7166  
Email: info@sg.metrologic.com

#### China

##### **Suzhou Sales Office**

**Headquarters**  
Tel: 86-512-67622550  
Fax: 86-512-67622560  
Email: info@cn.metrologic.com

#### METROLOGIC - APAC

#### Australia

##### **Metrologic Australia**

Tel: 61 2 9652 2726  
(international)  
Tel: 02 9816 6470 (local)  
Tel: 1 800 99 88 38 (Australia)  
Email:  
kmason@au.metrologic.com

#### China

##### **Beijing Sales Office**

Tel/Fax: 86 10 82253472  
Email: info@cn.metrologic.com

#### China

##### **Chengdu Sales Office**

Tel/Fax: 86 28 86200109  
Email: info@cn.metrologic.com

#### China

##### **Guangzhou Sales Office**

Tel: 86-20-38823476  
Fax: 86-20-38823477  
Email: info@cn.metrologic.com

#### India

##### **India Sales Office**

Tel: +91 80 41256718  
Fax: +91 80 41256719  
Email: info@in.metrologic.com

#### Korea

##### **Korea Sales Office**

Tel: 82-2-6205-5379  
Fax: 82-2-3444-3980  
Email:  
Scott.lee@kr.metrologic.com

#### Japan

##### **Metrologic Japan Co., Ltd.**

Tel: 81-3-3839-8511  
Fax: 81-3-3839-8519  
Email: info@jp.metrologic.com

#### Thailand

##### **Metrologic Thailand**

Tel: +662-610-3787  
Fax: +662-610-3601  
Email:  
tawan.jandang@th.metrologic.com

#### China

##### **Shanghai**

Tel: 86-21-58356616  
Fax: 86-21-58358873  
Email: info@cn.metrologic.com



March 2004, Version 01

Printed in the USA



00 - 02173



## Free Manuals Download Website

<http://myh66.com>

<http://usermanuals.us>

<http://www.somanuals.com>

<http://www.4manuals.cc>

<http://www.manual-lib.com>

<http://www.404manual.com>

<http://www.luxmanual.com>

<http://aubethermostatmanual.com>

Golf course search by state

<http://golfingnear.com>

Email search by domain

<http://emailbydomain.com>

Auto manuals search

<http://auto.somanuals.com>

TV manuals search

<http://tv.somanuals.com>